



INTERNATIONAL TELECOMMUNICATION UNION

ITU-T

TELECOMMUNICATION
STANDARDIZATION SECTOR
OF ITU

X.36

(02/2003)

SERIES X: DATA NETWORKS AND OPEN SYSTEM
COMMUNICATIONS

Public data networks – Interfaces

**Interface between Data Terminal Equipment
(DTE) and Data Circuit-terminating Equipment
(DCE) for public data networks providing frame
relay data transmission service by dedicated
circuit**

ITU-T Recommendation X.36

ITU-T X-SERIES RECOMMENDATIONS
DATA NETWORKS AND OPEN SYSTEM COMMUNICATIONS

PUBLIC DATA NETWORKS	
Services and facilities	X.1–X.19
Interfaces	X.20–X.49
Transmission, signalling and switching	X.50–X.89
Network aspects	X.90–X.149
Maintenance	X.150–X.179
Administrative arrangements	X.180–X.199
OPEN SYSTEMS INTERCONNECTION	
Model and notation	X.200–X.209
Service definitions	X.210–X.219
Connection-mode protocol specifications	X.220–X.229
Connectionless-mode protocol specifications	X.230–X.239
PICS proformas	X.240–X.259
Protocol Identification	X.260–X.269
Security Protocols	X.270–X.279
Layer Managed Objects	X.280–X.289
Conformance testing	X.290–X.299
INTERWORKING BETWEEN NETWORKS	
General	X.300–X.349
Satellite data transmission systems	X.350–X.369
IP-based networks	X.370–X.399
MESSAGE HANDLING SYSTEMS	X.400–X.499
DIRECTORY	X.500–X.599
OSI NETWORKING AND SYSTEM ASPECTS	
Networking	X.600–X.629
Efficiency	X.630–X.639
Quality of service	X.640–X.649
Naming, Addressing and Registration	X.650–X.679
Abstract Syntax Notation One (ASN.1)	X.680–X.699
OSI MANAGEMENT	
Systems Management framework and architecture	X.700–X.709
Management Communication Service and Protocol	X.710–X.719
Structure of Management Information	X.720–X.729
Management functions and ODMA functions	X.730–X.799
SECURITY	X.800–X.849
OSI APPLICATIONS	
Commitment, Concurrency and Recovery	X.850–X.859
Transaction processing	X.860–X.879
Remote operations	X.880–X.899
OPEN DISTRIBUTED PROCESSING	X.900–X.999

For further details, please refer to the list of ITU-T Recommendations.

ITU-T Recommendation X.36

Interface between Data Terminal Equipment (DTE) and Data Circuit-terminating Equipment (DCE) for public data networks providing frame relay data transmission service by dedicated circuit

Summary

This Recommendation defines the DTE/DCE interface for public data networks providing frame relay data transmission service by dedicated circuit. It defines frame relay basic service for permanent virtual circuits and switched virtual circuits and frame relay link layer protocol for data transfer. It defines permanent virtual circuits management protocol and signalling for switched virtual circuits. It also defines the following network capabilities: closed user group, reverse charging, transit network selection, transfer and discard priorities and service classes, NSAP support by the network for interworking with ATM networks, multiprotocol encapsulation and selection and fragmentation at the DTE/DCE interface. This revision replaces ITU-T Rec. X.36 (2000); it has a new annex explaining the relationship between clause 11 on PVC management procedures and Annex A of ITU-T Rec. Q.933 and a new appendix imported from ITU-T Rec. Q.933.

This revision of ITU-T Rec. X.36 (2003) is in alignment with the latest release of ITU-T Recs Q.933 (2003) and X.76 (2003).

Source

ITU-T Recommendation X.36 was revised by ITU-T Study Group 17 (2001-2004) and approved under the WTSA Resolution 1 procedure on 13 February 2003.

FOREWORD

The International Telecommunication Union (ITU) is the United Nations specialized agency in the field of telecommunications. The ITU Telecommunication Standardization Sector (ITU-T) is a permanent organ of ITU. ITU-T is responsible for studying technical, operating and tariff questions and issuing Recommendations on them with a view to standardizing telecommunications on a worldwide basis.

The World Telecommunication Standardization Assembly (WTSA), which meets every four years, establishes the topics for study by the ITU-T study groups which, in turn, produce Recommendations on these topics.

The approval of ITU-T Recommendations is covered by the procedure laid down in WTSA Resolution 1.

In some areas of information technology which fall within ITU-T's purview, the necessary standards are prepared on a collaborative basis with ISO and IEC.

NOTE

In this Recommendation, the expression "Administration" is used for conciseness to indicate both a telecommunication administration and a recognized operating agency.

INTELLECTUAL PROPERTY RIGHTS

ITU draws attention to the possibility that the practice or implementation of this Recommendation may involve the use of a claimed Intellectual Property Right. ITU takes no position concerning the evidence, validity or applicability of claimed Intellectual Property Rights, whether asserted by ITU members or others outside of the Recommendation development process.

As of the date of approval of this Recommendation, ITU had received notice of intellectual property, protected by patents, which may be required to implement this Recommendation. However, implementors are cautioned that this may not represent the latest information and are therefore strongly urged to consult the TSB patent database.

© ITU 2003

All rights reserved. No part of this publication may be reproduced, by any means whatsoever, without the prior written permission of ITU.

CONTENTS

	Page
1	Scope 1
2	References..... 1
3	Terms and definitions 3
4	Abbreviations..... 3
5	Conventions 4
6	Description of the DTE/DCE interface (physical layer)..... 4
6.1	ITU-T X.21 interface..... 4
6.2	X.21 <i>bis</i> interface..... 5
6.3	V-series interfaces 6
6.4	G-series interfaces 6
6.5	I-series interfaces..... 6
7	Description of services 6
7.1	General definition..... 6
7.2	Multiplexing 6
7.3	Service aspect 7
7.4	Frame transfer priority..... 7
7.5	Frame discard priority 9
7.6	Frame relay service class..... 11
7.7	Support of both service class and priorities..... 11
7.8	SVC related services..... 11
8	Service parameters and service quality..... 11
8.1	Scope 11
8.2	Service parameters..... 12
8.3	SVC related service parameters..... 13
8.4	Service quality 14
9	Data link transfer control..... 14
9.1	General 14
9.2	Frame format 14
9.3	Addressing..... 15
9.4	Transmission consideration..... 18
9.5	Frame relay data transmission service over SDH..... 20
9.6	Fragmentation..... 20
10	Call connection control..... 24
10.1	General 24
10.2	Signalling channel 24
10.3	List of the signalling channel link layer parameters..... 25
10.4	Call states..... 25

	Page
10.5	Message definitions 26
10.6	General message format and information element coding 33
10.7	Call establishment and clearing procedures 58
10.8	Status enquiry and status procedures 65
10.9	Restart procedure 66
10.10	Handling of error conditions 67
10.11	List of timers 71
10.12	Closed user group facility 73
10.13	Transit network selection facility 76
10.14	Reverse charging facility 76
10.15	Frame Transfer priority 76
10.16	Frame Discard priority 77
10.17	Frame Relay Service Class 78
10.18	Support of both Service Class and Priorities 78
10.19	Charging information 79
11	PVC management procedures 79
11.1	Overview 79
11.2	Message definition 80
11.3	Message specific information elements 81
11.4	Description of procedures 83
11.5	Optional bidirectional network procedures 88
11.6	System parameters 90
12	Congestion control 91
12.1	General 91
12.2	Impact of congestion 92
12.3	Congestion notification 92
12.4	DTE congestion detection method and actions 94
	Annex A – List and status of the X.36 parameters 94
	Annex B – Functional support at the DTE/DCE interface 98
	B.1 Protocol Capabilities (PC) 98
	B.2 Frames protocol data units (FR) 98
	B.3 System Parameters (SP) 99
	Annex C – Consolidated Link Layer Management (CLLM) message 99
	C.1 Address octets 100
	C.2 Control field 100
	C.3 XID information field 100
	C.4 FCS field 103
	C.5 Network CLLM message transmission procedure 103

	Page
Annex D – Use of frame relay for multiprotocol encapsulation.....	105
D.1 General frame format	105
D.2 Frame format for ISO CLNP (ISO/IEC 8473)	106
D.3 Frame format for IP	107
D.4 Frame format for protocols with Ethertype code point	107
D.5 Frame format for bridged packets	108
D.6 Low layer compatibility negotiation procedures	117
D.7 Examples	119
D.8 Protocol encapsulation format	121
Annex E – Usage of cause and location.....	121
E.1 Location field generation.....	121
E.2 Cause values	122
E.3 Coding of the diagnostic field	131
Annex F – Use of NSAP at the DTE-DCE interface	132
F.1 Introduction	132
F.2 Encoding of X.121 numbers as NSAP	133
F.3 Encoding of E.164 numbers as NSAP.....	134
F.4 Other ATM End System Address coding.....	134
Annex G – Enhancements to PVC management procedures.....	134
G.1 Introduction	134
G.2 List of changes to clause 11.....	135
Annex H – Procedures defined in X.36 clause 11 and Q.933 Annex A.....	136
Appendix I – Examples of PVC management error events	136
I.1 Loss of STATUS ENQUIRY message.....	136
I.2 Loss of STATUS message.....	137
I.3 Invalid Receive Sequence Number	138
Appendix II – DTE congestion detection methods and actions.....	139
II.1 Implicit congestion detection	139
II.2 Explicit congestion detection	139
Appendix III – Handling of physical layer loopback conditions when using frame relay PVC bidirectional procedures.....	140
III.1 Recommended procedures for DTE/DCE that can detect loopback at the physical layer.....	140
III.2 Recommended procedures for DTE/DCE that cannot detect loopback at the physical layer.....	140
Appendix IV – Information on address.....	141
IV.1 Main address and complementary address	141
IV.2 Addresses in SETUP message.....	141
IV.3 Addresses in CONNECT message	141

	Page
IV.4 Addresses processing by the network in SETUP message.....	142
IV.5 Addresses processing by the network in CONNECT message.....	142
Appendix V – International network identification according to ITU-T Rec. X.125 for networks providing frame relay services and numbered under the E.164 numbering plan	143
V.1 Introduction	143
V.2 Assignment and notification process.....	143
Appendix VI – Call state diagrams at the DCE side of the DTE/DCE interface and DCE actions.....	143
VI.1 Foreword.....	143
VI.2 Symbol definition of the call state diagrams	144
VI.3 Call state diagrams	144
VI.4 Actions taken by the DCE on receipt of message in a given call state at the DCE side of the DTE/DCE interface.....	146
Appendix VII – Window size for a data link layer protocol.....	147

ITU-T Recommendation X.36

Interface between Data Terminal Equipment (DTE) and Data Circuit-terminating Equipment (DCE) for public data networks providing frame relay data transmission service by dedicated circuit

1 Scope

This Recommendation defines the interface between data terminal equipment (DTE) and data circuit-terminating equipment (DCE) for public data networks providing frame relay data transmission service by dedicated circuit. It defines frame relay basic service for permanent virtual circuits and switched virtual circuits and frame relay link layer protocol for data transfer. It defines permanent virtual circuits management protocol and signalling for switched virtual circuits. It defines also the following network capabilities:

- Closed user group;
- Reverse charging;
- Transit network selection;
- Support of NSAP;
- Transfer and discard priorities;
- Service classes;
- Fragmentation at the DTE/DCE interface;
- Multiprotocol encapsulation and selection.

2 References

The following ITU-T Recommendations and other references contain provisions which, through reference in this text, constitute provisions of this Recommendation. At the time of publication, the editions indicated were valid. All Recommendations and other references are subject to revision; users of this Recommendation are therefore encouraged to investigate the possibility of applying the most recent edition of the Recommendations and other references listed below. A list of currently valid ITU-T Recommendations is regularly published. The reference to a document within this Recommendation does not give it, as a stand-alone document, the status of a Recommendation.

- ITU-T Recommendation E.164 (1997), *The international public telecommunication numbering plan*.
- ITU-T Recommendation G.703 (2001), *Physical/electrical characteristics of hierarchical digital interfaces*.
- ITU-T Recommendation G.704 (1998), *Synchronous frame structures used at 1544, 6312, 2048, 8448 and 44 736 kbit/s hierarchical levels*.
- ITU-T Recommendation G.707/Y.1322 (2000), *Network node interface for the synchronous digital hierarchy SDH*.
- ITU-T Recommendation G.732 (1988), *Characteristics of primary PCM multiplex equipment operating at 2048 kbit/s*.
- ITU-T Recommendation I.122 (1993), *Framework for frame mode bearer services*.
- ITU-T Recommendations I.233.x series, *Frame mode bearer services*.

- ITU-T Recommendation I.363.5 (1996), *B-ISDN ATM Adaptation Layer specification: Type 5 AAL*.
- ITU-T Recommendation I.370 (1991), *Congestion management for the ISDN frame relaying bearer service*.
- ITU-T Recommendation I.372 (1993), *Frame relaying bearer service network-to-network interface requirements*.
- ITU-T Recommendation I.430 (1995), *Basic user-network interface – Layer 1 specification*.
- ITU-T Recommendation I.431 (1993), *Primary rate user-network interface – Layer 1 specification*.
- ITU-T Recommendation Q.850 (1998), *Usage of cause and location in the Digital Subscriber Signalling System No. 1 and the Signalling System No. 7 ISDN user part*.
- ITU-T Recommendation Q.921 (1997), *ISDN user-network interface – Data link layer specification*.
- ITU-T Recommendation Q.922 (1992), *ISDN data link layer specification for frame mode bearer services*.
- ITU-T Recommendation Q.931 (1998), *ISDN user-network interface layer 3 specification for basic call control*.
- ITU-T Recommendation Q.933 (2003), *ISDN Digital subscriber Signalling System No. 1 (DSS1) – Signalling specifications for frame mode switched and permanent virtual connection control and status monitoring*.
- ITU-T Recommendations Q.951.x series, *Stage 3 description for number identification supplementary services using DSS1*.
- ITU-T Recommendation T.50 (1992), *International Reference Alphabet (IRA) (Formerly International Alphabet No. 5 or IA5) – Information technology – 7-bit coded character set for information interchange*.
- ITU-T Recommendation X.21 (1992), *Interface between Data Terminal Equipment and Data Circuit-terminating Equipment for synchronous operation on public data networks*.
- ITU-T Recommendation X.21 bis (1988), *Use on public data networks of Data Terminal Equipment (DTE) which is designed for interfacing to synchronous V-series modems*.
- ITU-T Recommendation X.25 (1996), *Interface between Data Terminal Equipment (DTE) and Data Circuit-terminating Equipment (DCE) for terminals operating in the packet mode and connected to public data networks by dedicated circuit*.
- ITU-T Recommendation X.121 (2000), *International numbering plan for public data networks*.
- ITU-T Recommendation X.124 (1999), *Arrangements for the interworking of the E.164 and X.121 numbering plans for frame relay and ATM networks*.
- ITU-T Recommendation X.125 (1998), *Procedure for the notification of the assignment of international network identification codes for public frame relay data networks and ATM networks numbered under the E.164 numbering plan*.
- ITU-T Recommendation X.144 (2000), *User information transfer performance parameters for data networks providing international frame relay PVC service*.
- ITU-T Recommendation X.146 (2000), *Performance objectives and quality of service classes applicable to frame relay*.

- ITU-T Recommendation X.150 (1988), *Principles of maintenance testing for public data networks using Data Terminal Equipment (DTE) and Data Circuit-terminating Equipment (DCE) test loops.*
- ITU-T Recommendation X.263 (1998) | ISO/IEC TR 9577:1999, *Information technology – Protocol identification in the Network layer.*
- ISO/IEC 646:1991, *Information technology – ISO 7-bit coded character set for information interchange.*
- ISO/IEC 8885:1993, *Information technology – Telecommunications and information exchange between systems – High-level data link control (HDLC) procedures – General purpose XID frame information field content and format.*

3 Terms and definitions

This Recommendation defines the following terms:

3.1 calling/called DTE: A calling DTE is the entity which initiates or originates a request to set up a Frame Relay switched virtual circuit. The called DTE is the DTE to which a Frame relay switched virtual circuit set-up request is directed.

3.2 connected DLCI: A DLCI is "connected" when it is being used in a frame relay switched virtual circuit.

3.3 disconnected DLCI: A DLCI is "disconnected" when it is no longer being used in a frame relay switched virtual circuit but is not yet available for use in a new frame relay switched virtual circuit.

3.4 released DLCI: A DLCI is "released" when it is not being used in a frame relay switched virtual circuit but is available for use in a new frame relay switched virtual circuit.

3.5 outgoing/incoming (first meanings): In relation to call establishment and the call state machines at a DTE/DCE interface, the term "outgoing" refers to the direction from the DTE to the DCE at the originating DTE/DCE interface. The term "incoming" refers to the direction from the DCE to the DTE at a destination DTE/DCE interface. In this context, the meanings of "outgoing" and "incoming" are local to a DTE/DCE interface.

3.6 outgoing/incoming (second meanings): The second meanings of "outgoing" and "incoming" are strictly related to the Link layer core parameters and the Priority and service class parameters information elements. In this context, the term "outgoing" refers to the forward direction from the calling DTE to called DTE and the term "incoming" refers to the backward direction from the called DTE to calling DTE.

4 Abbreviations

This Recommendation uses the following abbreviations:

AR	Access Rate
Bc	Committed Burst Size
Be	Excess Burst Size
BECN	Backward Explicit Congestion Notification
CIR	Committed Information Rate
CLLM	Consolidated Link Layer Management
CLNP	Connectionless Network Layer Protocol

C/R	Command/Response
D/C	DLCI Extension/Control Indication Bit
DCE	Data Circuit-terminating Equipment
DE	Discard Eligibility indicator
DLCI	Data Link Connection Identifier
DTE	Data Terminal Equipment
EA	Address Field Extension
EIR	Excess Information Rate
FCS	Frame Check Sequence
FDDI	Fibre Distributed Data Interface
FECN	Forward Explicit Congestion Notification
FR	Frame Relay
FRDTS	Frame Relay Data Transmission Service
IP	Internet Protocol
LAPF	Link Access Protocol F
MAC	Media Access Control
OUI	Organization Unique Identifier
PDN	Public Data Network
PDU	Protocol Data Unit
PID	Protocol Identifier
PVC	Permanent Virtual Circuit
SNAP	Subnetwork Access Protocol
SVC	Switched Virtual Circuit
Tc	Committed Rate Measurement Interval
VC	Virtual circuit

5 Conventions

No special conventions are employed within this Recommendation.

6 Description of the DTE/DCE interface (physical layer)

Networks may offer one or more of the interfaces specified below. The exact use of the relevant points in these Recommendations is detailed below.

6.1 ITU-T X.21 interface

6.1.1 DTE/DCE interface element

The DTE/DCE physical interface element shall be according to 2.1/X.21 through 2.5/X.21.

6.1.2 Procedures for entering operational phases

The procedures for entering operational phases shall be as described in 5.2/X.21. The data exchanged on circuits T and R when the interface is in states 13S, 13R and 13 of Figure A.3/X.21 will be as described in subsequent clauses of this Recommendation. The not ready states given in 2.5/X.21 are considered to be non-operational states and may be considered by the higher layers to be out of order states.

6.1.3 Failure detection and test loops

The failure detection principles shall be according to 2.6/X.21. In addition, $i = \text{OFF}$ may be signalled due to momentary transmission failures. Higher layers may delay for several seconds before considering the interface to be out of order.

The definitions of test loops and the principles of maintenance testing using the test loops are provided in ITU-T Rec. X.150.

A description of the test loops and the procedures for their use is given in clause 7/X.21.

Automatic activation by a DTE of a test loop 2 in the DCE at the remote terminal is not possible. However, some Administrations may permit the DTE to control the equivalent of a test loop 2, at the local DCE, to verify the operation of the leased line or subscriber line and/or all or part of the DCE or line terminating equipment. Control of the loop, if provided, may be either manual or automatic, as described in ITU-T Recs X.150 and X.21 respectively.

6.1.4 Signal element timing

Signalling element timing shall be in accordance with 2.6.3/X.21.

6.2 X.21 *bis* interface

6.2.1 DTE/DCE physical interface elements

The DTE/DCE physical interface element shall be according to 1.2/X.21 *bis*.

6.2.2 Operational phases

When circuit 107 is in the ON condition, and circuits 105, 106, 108 and 109, if provided, are in the ON condition, data exchange on circuits 103 and 104 will be as described in subsequent clauses of this Recommendation.

When circuit 107 is in the OFF condition, or any of circuits 105, 106, 108 or 109, if provided, are in the OFF condition, this is considered to be in a non-operational state, and may be considered by the higher layers to be in an out of order state.

6.2.3 Failure detection and test loops

The failure detection principles, the description of test loops and the procedures for their use shall be according to 3.1 through 3.3/X.21 *bis*. In addition, circuits 106 and 109 may enter the OFF condition due to momentary transmission failures. Higher layers may delay for several seconds before considering the interface to be out of order.

Automatic activation by a DTE of test loop 2 in the DCE at the remote terminal is not possible. However, some Administrations may permit the DTE to control the equivalent of a test loop 2, at the local DCE, to verify the operation of the leased line or subscriber line and/or all or part of the line terminating equipment. Control of the loop, if provided, may be either manual or automatic, as described in ITU-T Recs X.150 and X.21 *bis* respectively.

6.2.4 Signal element timing

Signal element timing shall be in accordance with 3.4/X.21 *bis*.

6.3 V-series interfaces

General operation with V-series modems is as described in 6.2 above. However, for specific details, particularly related to failure detection principles, loop testing, and the use of circuits 107, 109, 113 and 114, refer to the appropriate V-series Recommendations.

The delay between 105 – ON and 106 – ON (when these circuits are present) will be more than 10 ms and less than 1 s. In addition, circuits 106 or 109 may enter the OFF condition due to momentary transmission failures or modem retraining. Higher layers may delay for several seconds before considering the interface to be out of order.

6.4 G-series interfaces

The characteristics of the physical circuit interface, defined as the physical layer element, shall be in accordance with ITU-T Rec. G.703.

When used, the frame structure conforms to ITU-T Rec. G.704. In case of 2 Mbit/s, time slot 0 is used to perform the fault detection (see ITU-T Rec. G.732). Time slot 16 may either be used or not used, resulting in an access rate of 1984 kbit/s or 1920 kbit/s respectively.

A physical layer interface based on SDH shall be according to ITU-T Rec. G.707.

6.5 I-series interfaces

I-series physical interfaces on PDN for Frame Relay Data Network Service are defined in ITU-T Recs I.430 and I.431.

NOTE – I-series physical interfaces are to be used for dedicated lines to the PDN providing a FRDTS. In some cases, semi-permanent channel interfaces from ISDN networks will be used without channel negotiation procedures.

7 Description of services

7.1 General definition

FRDTS provides bidirectional transfer of frames from one DTE/DCE interface to another DTE/DCE interface with content transparency, error detection and order preservation of the transmitted frames.

FRDTS does not provide procedures for error notification, error recovery, retransmission in case of lost frames.

Loss of frames can result not only from transmission errors but also from congestion within the network or at the DTE/DCE interfaces.

7.2 Multiplexing

FRDTS allows simultaneous connections between DTEs to be multiplexed on a single access circuit. Individual frames of a given connection are identified by means of an attached label. This field in the frame called DLCI (Data Link Connection Identifier) is a logical identifier, with local significance. The network keeps a relationship between the DLCI used on one DTE/DCE interface and the DLCI used on the remote DTE/DCE interface for a given DTE to DTE connection (see Figure 7-1). Note that the mapping of DLCI value of transmitting DTE to receiving DTE is network dependent.

For each connection, the order of frames is preserved from the transmitting DTE to the receiving DTE.

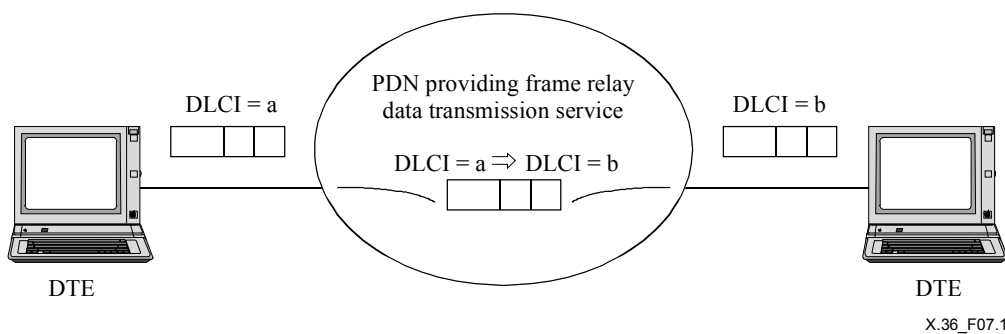

Figure 7-1/X.36 – Data Link Connection Identifier

7.3 Service aspect

FRDTS provides both Switched Virtual Circuit (SVC) and Permanent Virtual Circuit (PVC) services.

7.4 Frame transfer priority

7.4.1 General description

The frame transfer priority is an optional network facility allowing networks and DTEs the possibility to apply different priorities to virtual circuits. During the data transfer phase, a virtual circuit with a higher frame transfer priority will have, in general, its frames serviced (processed and transmitted) before the frames of virtual circuits assigned a lower priority resulting in a lower end-to-end delay and lower variation of this delay. Frame transfer priorities are assigned per virtual circuit and possibly for each direction of the data transmission. Frame transfer priority provides frame relay networks with a capability allowing them to support and meet the temporal requirements, such as end-to-end delay, of real-time applications and to offer multiple level of services based on the time-sensitivity requirements of the applications.

7.4.2 Service provisioning and request

Supporting the frame transfer priority service during the data transfer phase is a network option. If supported, it is also a network option whether the frame transfer priority applies at the DTE/DCE interface and/or within the network and if different frame transfer priorities per data transmission direction are possible or not. If a network does not support different frame transfer priorities for each direction, the highest requested priority is used for both directions.

For permanent virtual circuits, frame transfer priority is assigned at subscription time. For switched virtual circuit subscription parameters may be required to manage by the networks the usage of frame transfer priorities. Frame transfer priority is requested by the calling DTE, the request is processed by the network and transmitted to the called DTE. When progressing the call set-up, the network accommodates the request of the calling DTE based on its own Frame transfer priority capabilities.

When using a permanent or switched virtual circuit with frame transfer priority requested to the network, a DTE is encouraged to also apply frame transfer priority when it transmits data to the network or, if applicable, when it switches data internally.

A condition for frame transfer priority services to provide their expected benefits is such that DTEs do not always use the same priority (possibly the highest one).

It is the responsibility of network operators to build mechanisms that will lead DTEs to request different frame transfer priority. Such mechanisms could be based on items or combination of items of the following non-exhaustive and non-constraining list, items defined for a DTE/DCE interface and per priority class:

- a different tariff;
- a maximum number (Note 1) of VCs (PVCs + SVCs) per interface;
- a maximum limit to frame information field size per VC;
- a maximum limit (Note 1) to sum of CIR, aggregated per interface;
- a maximum limit (Note 1) to sum of (CIR + EIR) (Note 3), aggregated per interface;
- a maximum limit (Note 1) to sum of Committed burst size (Bc), aggregated per interface;
- a maximum limit (Note 1) to sum of Excess burst size (Be), aggregated per interface;
- a maximum limit (Note 2) to individual CIR, i.e., per VC;
- a maximum limit (Note 2) to individual (CIR + EIR) (Note 3), i.e., per VC;
- a maximum limit (Note 2) to individual Committed burst size (Bc), i.e., per VC;
- a maximum limit (Note 2) to individual Excess burst size (Be), i.e., per VC;

NOTE 1 – Actual value can be an absolute figure or a function of access rate of the DTE/DCE interface.

NOTE 2 – Actual value can be an absolute figure or a function based on the minimum of access rates of the two considered DTE/DCE interfaces.

NOTE 3 – $CIR + EIR = CIR (1 + Be/Bc)$.

Regarding traffic policing based on link layer core parameters, different behaviours may exist based on frame transfer priority classes (possibly more constraining on highest one) in case CIR and EIR are exceeded.

7.4.2.1 Frame transfer priority indices and classes

A frame transfer priority class corresponds to a distinct frame transfer priority supported by the network. The number and characteristics of frame transfer priority classes rely highly on internal network capabilities and as such cannot be standardized.

A frame transfer priority index is an integer from zero to fifteen used at the DTE/DCE interfaces to identify a frame transfer priority. Zero is the lowest priority index and fifteen the highest. The mapping between frame transfer priority indices and classes is network-dependent. A frame transfer priority index has a local significance. Therefore, it has a local meaning determined according to the service description of the network a DTE is connected to.

7.4.2.2 Conformance to the Frame transfer priority service

In order to conform to the Frame transfer priority service, a network must ensure that its mapping between frame transfer priority indices and classes always satisfies the following proposition:

Let i and j be two indices with $i < j$ then $FTP_Class(i) \leq FTP_Class(j)$.

In other words if i and j are two frame transfer priority indices such that i is smaller than j , the frame transfer priority class (FTP_Class) assigned to a switched virtual circuit requesting a frame transfer priority index equal to i shall not be greater than the frame transfer priority class assigned by the network to a virtual circuit requesting a frame transfer priority index equal to j . It may, however, be the same.

In addition a network must ensure that if $FTP_Class(j) > FTP_Class(i)$ the temporal constraints or performance bounds such as delays and/or delay variation assigned to $FTP_Class(j)$ are better than those assigned to $FTP_Class(i)$. This Recommendation does not specify what is meant by "better" nor shall it specify specific performance bounds. This is the prerogative of the service provider. Intuitively, it should be expected that a higher FTP_Class will support a lower delay and/or lower delay variation.

7.5 Frame discard priority

7.5.1 General description

The frame discard priority at the DTE/DCE interface is an optional network facility. It allows networks and DTEs to apply different frame discard priorities to virtual circuits at the DTE/DCE interface. Each discard priority can be associated with a different frame loss ratio. When frame relay frames have to be discarded under adverse network conditions, frames belonging to a virtual circuit assigned a lower frame discard priority will be discarded by the network prior to those belonging to virtual circuits assigned higher frame discard priorities. Frame discard priorities are assigned per virtual circuit at the DTE/DCE interface and different values may be assigned for each direction of data transmission.

7.5.2 Service Provisioning and Signalling

Supporting the frame discard priority service is a network option. It is also a network option to support a different frame discard priority per direction of data transmission. If a network does not support different frame discard priorities for each direction, the highest requested priority is used for both directions.

For permanent virtual circuits, Frame discard priority is assigned at subscription time. For switched virtual circuit subscription parameters may be required to manage by the networks the usage of frame discard priorities. Frame discard priority is requested by the calling DTE, the request is processed by the network and transmitted to the called DTE. When progressing the call set-up, the network accommodates the request of the calling DTE based on its own frame discard priority capabilities.

Although the assignment of frame discard priority is different between switched virtual circuits and permanent virtual circuits, its operation is similar during the data transfer phase.

It is the responsibility of network operators to build mechanisms that will lead DTEs to request different frame discard priorities. Such mechanisms could be based on items or combinations of items of the following non-exhaustive and non-constraining list. Items defined for a DTE/DCE interface and per priority are:

- A different tariff;
- A maximum number (Note 1) of VCs (PVCs + SVCs) per interface;
- A maximum limit to frame information field size per VC;
- A maximum limit (Note 1) to sum of CIR, aggregated per interface;
- A maximum limit (Note 1) to sum of (CIR + EIR) (Note 3), aggregated per interface;
- A maximum limit (Note 1) to sum of Committed burst size, aggregated per interface;
- A maximum limit (Note 1) to sum of Excess burst size, aggregated per interface;
- A maximum limit (Note 2) to individual CIR, i.e., per PVC;
- A maximum limit (Note 2) to individual (CIR + EIR) (Note 3), i.e., per VC;
- A maximum limit (Note 2) to individual Excess burst size, i.e., per VC.

NOTE 1 – Actual value can be an absolute figure or a function of access rate of the DTE/DCE interface.

NOTE 2 – Actual value can be an absolute figure or a function based on the minimum of access rate of the two considered DTE/DCE interfaces.

NOTE 3 – $CIR + EIR = CIR (1 + Be/Bc)$.

Regarding traffic policing based on link layer core parameters, different behaviours may exist based on frame discard priority classes (possibly more constraining on highest one) in case CIR and EIR are exceeded.

7.5.2.1 Frame discard priority indices and classes

A Frame discard priority class corresponds to a distinct frame discard priority supported by the network. The number and characteristics of frame discard priority classes rely highly on internal network capabilities and as such cannot be standardized.

A frame discard priority index is an integer from zero to seven used at the DTE/DCE interface to signal a frame discard priority:

- Frame discard priority 0: Lowest frame discard priority. Virtual circuits assigned this frame discard priority will have their frames discarded first. This should result in the highest frame loss ratio.
- Frame discard priority 7: Highest frame discard priority. Virtual circuits assigned this frame discard priority will have their frames discarded last. This should result in the lowest frame loss ratio.

Frame discard priority indices can be grouped into frame discard priority classes within a network, each of which corresponds to a distinct frame discard priority. A frame discard priority index has a local significance. It has a local meaning determined according to the service description of the network a DTE is connected to.

7.5.2.2 Conformance to the frame discard priority service

In order to conform to the frame discard priority service, a network must ensure that its mapping between frame discard priority indices and classes always satisfies the following propositions:

Let i and j be two frame discard priority indices with $i < j$
then $\text{FDP_Class}(i) \leq \text{FDP_Class}(j)$

In other words if i and j are two frame discard priority indices such that i is smaller than j , the frame discard priority class (FDP_Class) assigned to a virtual circuit requesting a frame discard priority index equal to i shall not be greater than the frame discard priority class assigned by the network to a virtual circuit requesting a frame discard priority index equal to j . It may, however, be equal (if i and j map to the same frame discard priority class).

In addition, a network must ensure that if $\text{FDP_Class}(j) > \text{FDP_Class}(i)$, the performance bound such as frame loss ratio assigned to FDP_Class (j) is better than that assigned to FDP_Class (i). This Recommendation does not specify what is meant by «better», nor does it define specific performance bounds. This is the prerogative of the service provider. Intuitively, it should be expected a higher FDP_Class would support a lower frame loss ratio.

7.5.3 Frame discard priority and other frame relay parameters

While both frame discard priority and the frame relay discard eligibility (DE) bit deal with frame discards, they function differently but in a complementary manner. At a given point in time when a network supporting multiple virtual circuits of different frame discard priority classes decides to discard frames due to congestion, all frames with DE bits ON (called EIR traffic/frames) regardless of the frame discard priority classes assigned to the connections they belong to, are discarded ahead of frames with DE bit OFF (called CIR traffic/frames). In other words, EIR traffic is treated as the least critical traffic and is discarded first. In the event of continuing congestion, if necessary, CIR frames are then discarded according to their assigned frame discard priorities: CIR frames belonging to connections with lower frame discard priority values will be discarded ahead of those belonging to connections with higher frame discard priority values.

7.6 Frame relay service class

Frame Relay Service Class is an optional facility allowing Frame Relay networks to apply different Quality of Service Classes to Frame Relay virtual circuits to meet delay and loss requirements for different applications. During the data transfer phase, frames will be processed such that the performance characteristics of the subscribed or requested Service Class will be met.

The use of Frame Relay Service Class at the DTE/DCE interface is by subscription for a PVC or by signalling for SVCs. For SVCs, the Service Class is requested by the calling DTE by signalling a service class number at the time of call establishment.

Defined Service Classes are specified in Table 7-1. Each Service Class has associated maximum end-to-end delay and loss values as appropriate for the requirements of applications for each class. Service Classes and their defined delay and loss parameter values are defined in ITU-T Rec. X.146.

Table 7-1 /X.36 – Service class description

Service class number	Support requirement	Application notes
0	Mandatory	Moderate frame loss and unspecified delay requirements.
1	Mandatory	Default Service Class. All Frame Relay networks offering Service Classes will provide this Service Class and the signalling of this Service Class for SVCs if supported. Moderate frame loss and moderate delay requirements.
2	Optional	Stringent frame loss and moderate delay requirements.
3	Optional	Stringent frame loss and stringent delay requirements.

7.7 Support of both service class and priorities

Networks may support Service Class, Priorities, both or none.

Networks will make known by administrative means whether Service Classes, Priorities, or both, are available at a DTE/DCE interface.

In the case where a network provides both options, two modes of operation are possible:

- An optional DTE subscription option that indicates whether the DTE supports Service classes or priorities.
- No DTE subscription.

In any case, on a per PVC or on a per SVC basis network supports either service class or Priority(ies) but not both at the same time on the same PVC or SVC.

7.8 SVC related services

As basic and mandatory features, networks provide calling party number and connected party number screening and presentation as well as link layer core parameter negotiation.

As optional services, networks may provide Closed User Group facilities, Transit network selection facility and reverse charging facility.

8 Service parameters and service quality

8.1 Scope

This clause describes the service parameters needed to ensure the necessary service requirements including congestion management.

8.2 Service parameters

8.2.1 Access Rate (AR)

The access rate is the maximum data rate that the DTE can inject into or extracted from the network. It is determined by the speed of the access channel which is selected by the user from a set supported by the network. It is agreed for a period of time.

8.2.2 Committed Burst Size (Bc)

The committed burst size is the amount of data for a particular virtual circuit that the network agrees to transfer under normal conditions during interval T_c (see 8.2.5).

The value of this service parameter for a given direction of transmission (i.e., outgoing direction from the DTE to the DCE and incoming direction from the DCE to the DTE) is set to a value selected from a set supported by the network and agreed to for a period of time. The value of this service parameter for a given direction of transmission can also be negotiated at call set-up.

8.2.3 Excess Burst Size (Be)

The excess burst size is the amount of uncommitted data that the network shall endeavour to accept in addition to the committed burst size (B_c) from a DTE for a particular virtual circuit during interval T_c (see 8.2.5).

The value of this service parameter for a given direction of transmission (i.e., outgoing direction from the DTE to the DCE and incoming direction from the DCE to the DTE) is set to a value selected from a set supported by the network and agreed for a period of time. The value of this service parameter for a given direction of transmission can also be negotiated at call set-up.

8.2.4 Committed Information Rate (CIR)

The information transfer rate for a particular VC which the network is committed to transfer under normal conditions. The rate is averaged over a minimum time interval of T_c .

The value of this service parameter for a given direction of transmission (i.e., outgoing direction from the DTE to the DCE and incoming direction from the DCE to the DTE) is set to a value selected from a set supported by the network and agreed for period of time. The value of this service parameter for a given direction of transmission can also be negotiated at call set-up.

8.2.5 Committed Rate Measurement Interval (T_c)

The committed rate measurement interval T_c is the time interval during which the network may expect committed burst size and excess burst size data. For each direction of transmission, it is defined according to the following formula:

- 1) If $CIR > 0$ $T_c = B_c/CIR$.
- 2) If $CIR = 0$, T_c is set to a value selected by the user from a set supported by the network. This value is agreed for a period of time.

8.2.6 Maximum octet length of Frame Relay Information Field (N203)

The size of the Frame Relay Information Field (N203 parameter) is the number of user data octets after the address field and before the Frame Check Sequence (FCS) field (see Figure 9-1). The count is done prior to zero-bit insertion on the transmitting side and following zero-bit extraction at the receiving side. The value of the N203 parameter for a given direction of transmission (i.e., outgoing direction from the DTE to the DCE and incoming direction from the DCE to the DTE) is set to a value selected from a set supported by the network and agreed to for a period of time. The value of the N203 parameter for a given direction of transmission can also be negotiated at call set-up.

All networks shall support at least the value of 1600 octets.

8.2.7 Priorities or service class

When supported by the network, Frame Transfer and/or Discard Priorities or Service Class are applied on a per virtual circuit basis.

8.2.8 Fragmentation parameters

The use of DTE/DCE fragmentation is defined by a subscription parameter.

In which case, another subscription parameter defines the maximum Fragment size that can be used at the DTE/DCE interface. This parameter applies to both directions of data transmission.

8.3 SVC related service parameters

The mode of operation of SVC requires the introduction of parameters that are generally relevant on a per interface basis. The actual definition of those parameter may be on a per network basis (the same value applies to all interfaces) or on a per interface basis (value is defined as a subscription parameter).

8.3.1 DTE address

DTE address is a succession of digits that uniquely identify the DTE/DCE interface within the numbering plan of the network.

8.3.2 Maximum number of SVCs

This parameter defines the maximum number of SVCs that can simultaneously be established over a DTE/DCE interface, regardless of the direction of each individual call.

8.3.3 Default values for link layer core parameters

To avoid the calling DTE to specify each link layer core parameter, default values are defined:

- outgoing and incoming throughputs (CIR);
- outgoing and incoming minimum throughputs;
- outgoing and incoming committed burst sizes;
- outgoing and incoming excess burst sizes.

Default values for the incoming link layer core parameters can be the same as the default values for the outgoing parameters.

8.3.4 CUG profile

CUG profile of a DTE/DCE interface is determined at subscription time by the set of Closed User Groups to which the interface belongs to (none, one or several), the signalling procedure used (simple CUG versus CUG selection), the mapping of signalled indexes to administrative CUG identifiers in case of CUG selection facility, possible outgoing access and incoming access options.

8.3.5 Reverse charging prevention

The Reverse charging prevention requires the network not to present the reverse charging request to the called DTE.

8.3.6 Default priorities

To avoid the calling DTE to specify each priority, default values are defined:

- outgoing and incoming Frame Transfer priorities;
- outgoing and incoming Frame Discard priorities.

Default values for the incoming priorities can be the same as the default values for the outgoing priorities.

8.3.7 Priorities versus service class

When network supports both Priorities and Service Class, the DTE profile can be subscribed to specify signalling handling of the network on that particular DTE/DCE interface.

8.4 Service quality

The QoS level for committed traffic characterized by the CIR, Bc and Tc parameters may be delivered within a certain probability. The QoS for level excess traffic characterized by the parameter Be may also be delivered within a certain probability.

More details on this aspect can be found in ITU-T Rec. X.144. Congestion occurrence within the network or at the DTE/DCE interfaces impacts the provided QoS level (see clause 12).

Frame Transfer priorities, Frame Discard Priorities and Service classes have an impact on the probability that committed and excess traffics are delivered and on the probability that committed and excess traffics are delivered within a certain delay.

For priorities the exact impact is not standardized and is network dependent. Impact for Service classes is defined in ITU-T Rec. X.146.

9 Data link transfer control

9.1 General

This clause contains the frame structure, elements of procedure, format of fields and procedures for the operation of the Frame Relay Data Transmission Service for physical interfaces other than SDH. For Frame Relay Data Transmission Service over SDH, clause 9.5 applies. The functions provided by the Frame Relay Data Transmission Service are:

- frame delimiting, alignment and transparency;
- frame multiplexing/de-multiplexing using the address field;
- inspection of the frame to ensure that it consists of an integral number of octets prior to zero bit insertion or following zero bit extraction;
- inspection of the frame to ensure that it is neither too long nor too short;
- detection of (but not recovery from) transmission errors;
- congestion control functions.

9.2 Frame format

The frame format used for individual frame is shown in Figure 9-1.

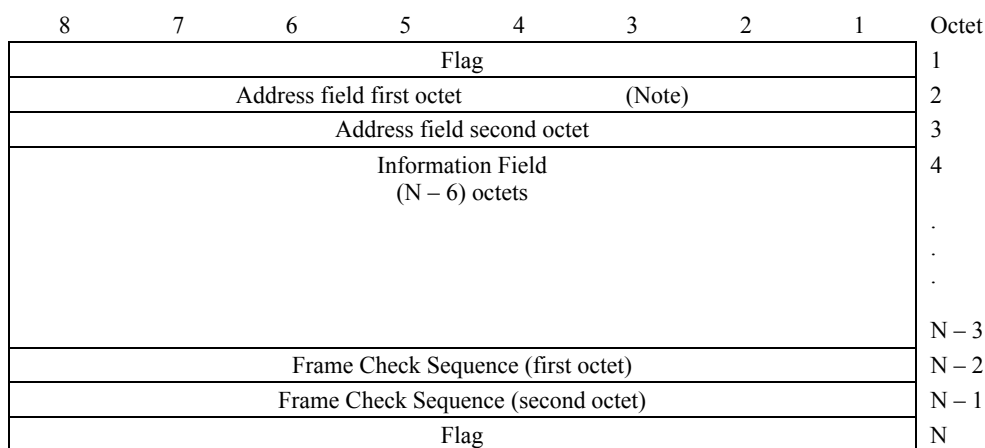

NOTE – The default address field length is 2 octets. It may be extended to 4 octets.

Figure 9-1/X.36 – Frame format with 2-octet address

9.2.1 Flag sequence

All frames shall start and end with the flag sequence consisting of one 0 bit followed by six contiguous 1 bits and one 0 bit. The flag preceding the address field is defined as the opening flag. The flag following the Frame Check Sequence (FCS) field is defined as the closing flag. DTE and DCE must be able to support the use of the closing flag as the opening flag of the following frame.

9.2.2 Address field

The address field shall consist of at least two octets, and may optionally be extended to 4 octets. The format of the address field is defined in 9.3.

9.2.3 Information field

The information field of a frame, when present, follows the address field (see 9.3.2) and precedes the frame check sequence field (see 9.2.4). The contents of the frame relay information field shall consist of an integral number of octets. The maximum length of the frame relay information field is defined in 8.2.6.

9.2.4 Frame Check Sequence (FCS) field

The FCS field shall be a 16-bit sequence. It shall be the ones complement of the sum (modulo 2) of:

- 1) the remainder of $x^k (x^{15} + x^{14} + x^{13} + x^{12} + x^{11} + x^{10} + x^9 + x^8 + x^7 + x^6 + x^5 + x^4 + x^3 + x^2 + x + 1)$ divided (modulo 2) by the generating polynomial $x^{16} + x^{12} + x^5 + 1$, where k is the number of bits in the frame existing between, but not including, the final bit of the opening flag and the first bit of the FCS, excluding bits inserted for transparency; and
- 2) the remainder of the division (modulo 2) by the generating polynomial $x^{16} + x^{12} + x^5 + 1$ of the product of x^{16} by the content of the frame, existing between but not including, the final bit of the opening flag and the first bit of the FCS, excluding bits inserted for transparency.

9.3 Addressing

9.3.1 General

This clause describes the format of the address field (see Figure 9-2). A frame relay connection is governed by the elements of the address field described in this clause. These elements of the address field provide for the support of congestion management optional procedures which can be found in clause 12. The information field follows the address field.

9.3.2 Address field format

The address field shown in Figure 9-2 contains the address field extension bits, a command/response indication bit, a forward explicit congestion notification bit, a backward explicit congestion notification bit, a discard eligibility indication bit, Data Link Connection Identifier (DLCI) bits and a DLCI extension/Control indication bit (D/C bit). The support of 2 octets address field is mandatory. DTE and DCE may also support address fields with a length of 4 octets. When the network supports address fields with length of 4 octets, the choice of the length is made at a subscription time and is applicable to the entire DTE/DCE interface.

9.3.3 The address field element

9.3.3.1 Address field extension bit (EA bit)

The address field range is extended by reserving bit 1 of the address field octets to indicate the final octet of the address field. The presence of a 0 in bit 1 of an address field octet signals that another octet of the address field follows this one. The presence of a 1 in bit 1 of an address field octet signals that it is the final octet of the address field.

9.3.3.2 Command/Response bit (C/R bit)

The C/R bit is conveyed transparently from one DTE to the other.

	8	7	6	5	4	3	2	1
Default address field format (2 octets)	Upper DLCI (6 bits)						*	EA 0
	Lower DLCI (4 bits)				FECN	BECN	DE	EA 1

or

	8	7	6	5	4	3	2	1
4 octets address field format	Upper DLCI (6 bits)							EA 0
	DLCI (4 bits)				FECN	BECN	DE	EA 0
	DLCI (7 bits)							EA 0
	Lower DLCI (6 bits)						D/C 0	EA 1

* Bit intended to support a command/response indication. The coding is application specific (see 9.3.3.2).

BECN Backward Explicit Congestion Notification

D/C DLCI Extension/Control Indication Bit

DE Discard Eligibility Indicator

DLCI Data Link Connection Identifier

EA Address Field Extension Bit

FECN Forward Explicit Congestion Notification

Figure 9-2/X.36 – Address field format

9.3.3.3 Forward Explicit Congestion Notification Bit (FECN bit)

This bit may be set by a congested network to notify the receiving DTE that congestion avoidance procedures should be initiated, where applicable for traffic in the direction of the frame carrying the FECN indication. This bit is set to 1 to indicate to the receiving DTE that the frames it receives have encountered congested resources. This bit may be used by destination DTE to initiate transmitter rate adjustment.

While setting this bit by the network or DTE is optional, no network shall ever clear (set to 0) this bit. Networks that do not provide FECN shall pass this bit unchanged. Explanations on the use of this bit are contained in clause 12.

9.3.3.4 Backward Explicit Congestion Notification Bit (BECN bit)

This bit may be set by a congested network to notify the receiving DTE that congestion avoidance procedures should be initiated, where applicable for traffic in the opposite direction of the frame carrying the BECN indication. This bit is set to 1 to indicate to the receiving DTE that the frames it transmits may encounter congested resources. This bit may be used by the source DTE to initiate transmitter rate adjustment.

While setting this bit by the network or DTE is optional, no network shall ever clear (set to 0) this bit. Networks that do not provide BECN shall pass this bit unchanged. Explanations on the use of this bit are contained in clause 12.

9.3.3.5 Discard Eligibility Indicator Bit (DE bit)

This bit, if used, is set to 1 to indicate a request that a frame should be discarded in preference to other frames in a congestion situation. Setting of this bit by the network or DTE is optional. No network shall ever clear (set to 0) this bit. Networks are not constrained to discard only frames with DE = 1 in the presence of congestion.

9.3.3.6 Data Link Connection Identifier (DLCI)

Depending on the length of the address field, the DLCI can be 10 bits, or 23 bits. When the length of the address field is 2 octets, the DLCI is 10 bits and appears in octets 1 and 2. When the length of the address field is 4 octets, the DLCI is 23 bits and appears in octets 1, 2, 3 and 4. See Figure 9-2.

The DLCI identifies a virtual circuit at the local DTE/DCE interface. Its value is determined at subscription time for permanent virtual circuits and at call set-up time for switched virtual circuits. The maximum number of virtual circuits supported for a DTE/DCE interface is network dependent.

Specific values of the DLCI are also used for:

- the signalling for switched virtual circuits (see clause 10);
- the additional procedures for permanent virtual circuits (see clause 11);
- layer 2 management, in particular the Consolidated Link Layer Management (CLLM) (see Annex C).

The various values for DLCI are specified in Tables 9-1 and 9-2.

Table 9-1/X.36 – DLCI value range when 2 octets address field is used

DLCI range (10 bits)	Function
0	Signalling
1-15	Reserved
16-991	Virtual circuit identification
992-1007	Layer 2 management of FRDTS used for information related to the network such as the Consolidated Link Layer Management (CLLM) messages (see Annex C)
1008-1022	Reserved
1023	Reserved for in channel layer 2 management, if required

Table 9-2/X.36 – DLCI value range when 4 octets address field is used

DLCI range (23 bits)	Function
0	Signalling
1-15	Reserved
16-991	Virtual circuit identification
992-1007	Layer 2 management of FRDTS used for information related to the network such as the Consolidated Link Layer Management (CLLM) messages (see Annex C)
1008-1022	Reserved
1023	Reserved for in channel layer 2 management, if required
1024-8388607	Virtual circuit identification

9.3.3.7 DLCI extension Control indication bit (D/C bit)

The D/C bit is bit 2 of the last octet of the address field when a 4 octets format is used. It is always set to 0 in this Recommendation. When set to 1, the bits 3 to 8 of this last octet are no longer interpreted as DLCI bits and their use is for further study.

9.4 Transmission consideration

9.4.1 Order of bit transmission

The bits are grouped into octets. The bits of an octet are shown horizontally and are numbered from 1 to 8. Multiple octets are shown vertically and are numbered from 1 to n (see Figure 9-3).

The octets are transmitted in ascending numerical order. For each octet: bit 1, which is the least significant bit, is transmitted first and bit 8, which is the most significant bit, is transmitted last.

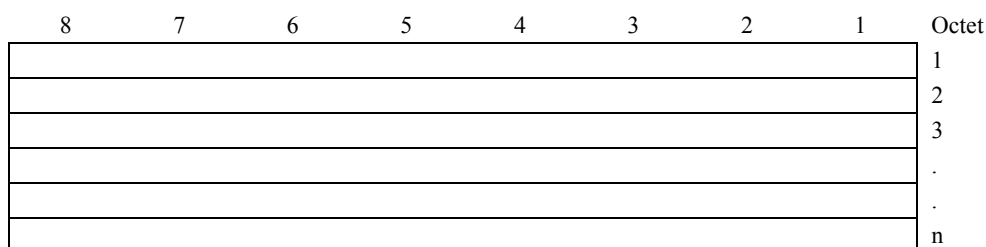

Figure 9-3/X.36 – Format convention

9.4.2 Order of bits in frame fields

When a field is contained within a single octet, the lowest bit number of the field represents the lowest order value.

When a field spans more than one octet, the order of bit values progressively decreases as the octet number increases within each octet. The lowest bit number associated with the field represents the lowest order value.

For example in an address field with length of two octets, the order of the values of the DLCI bits is as shown in Figure 9-4.

8	7	6	5	4	3	2	1	Octet
Upper DLCI (6 bits)						C/R	0EA	1
2^9	2^8	2^7	2^6	2^5	2^4			
Lower DLCI (4 bits)				FECN	BECN	DE	1EA	2
2^3	2^2	2^1	2^0					

Figure 9-4/X.36 – Order of values of the DLCI bits

There are two exceptions to the preceding convention:

- 1) The order of the values of the bits within the information field is not specified in this Recommendation.
- 2) The order of the values of FCS bits is as follows: bit 1 of the first octet is the high-order bit and bit 8 of the second octet is the low-order bit (see Figure 9-5).

8	7	6	5	4	3	2	1	Octet
2^8	2^9	2^{10}	2^{11}	2^{12}	2^{13}	2^{14}	2^{15}	1
2^0	2^1	2^2	2^3	2^4	2^5	2^6	2^7	2

Figure 9-5/X.36 – Order of values of the FCS bits

9.4.3 Transparency

The DTE and DCE shall examine the frame contents between the opening and closing flag sequences (address, information, and FCS fields) and shall insert a "0" bit after all sequences of five contiguous "1" bits (including the last five bits of the FCS) to ensure that a flag or an abort sequence is not simulated within the frame. The receiving DTE and DCE shall examine the frame contents between the opening and closing flag sequences and shall discard any "0" bit which directly follows five contiguous "1" bits.

9.4.4 Inter frame fill

For inter frame fill flag sequence must also be used.

9.4.5 Invalid frame

An invalid frame is a frame which:

- a) is not properly bounded by two flags; or
- b) has fewer than two octets between the address field and the closing flag; or
- c) does not consist of an integral number of octets prior to a "0" bit insertion or following "0" bit extraction; or
- d) contains a frame check sequence error; or
- e) contains a single octet address field; or
- f) contains a DLCI which is not supported by the receiver; or
- g) contains 7 or more continuous bits set to 1 after "0" bit insertion or before "0" bit extraction ("transparency violation" or "frame abort"); or
- h) has an information field longer than N203 (see 8.2.6).

NOTE 1 – Item b) above means that frames with an information field length equal to 0 are valid frames. In case there is no traffic on a given transmission direction, the DTE or the DCE may use such frames to send information about congestion in the opposite direction by means of the BECN bit set to 1 or to 0. For backward compatibility reasons, DTE or DCE may consider as invalid such frames, and consequently discards them without notification to the transmitting DCE or DTE.

NOTE 2 – In case h) above, the network may send part of the frame toward the remote DTE then abort the frame.

Invalid frames shall be discarded without notification to the transmitting DTE or DCE.

9.4.6 Frame abortion

Aborting a frame is performed by transmitting at least seven contiguous 1 bits (with no inserted 0 bits). The receipt of seven or more contiguous 1 bits by a DTE (or a DCE) is interpreted as an abort and the DTE (or the DCE) ignores the frame currently being received.

9.5 Frame relay data transmission service over SDH

9.5.1 General aspects

Frame relay link layer protocol is a bit-oriented protocol. It was conceived to operate on transmission facilities other than SDH. SDH presents an octet oriented interface to the link layer. There is no provision in SDH to support octet fragments (a number of bits that is not a multiple of 8). In order to cope with SDH requirements, the link layer has to guarantee that an integral number of octets are passed to the physical layer. This is not possible with current frame relay transfer protocol because of the zero bit insertion. The octet oriented frame relay data link layer framing specified in this clause shall be used with SDH as the physical transmission facility.

9.5.2 Framing aspects

Clauses 9.2 to 9.4 apply with the following exceptions:

- 1) Frame check sequence: AAL type 5 described in ITU-T Rec. I.363.5 32-bit FCS shall be used. The FCS generating polynomial is: $G(x) = x^{32} + x^{26} + x^{23} + x^{22} + x^{16} + x^{12} + x^{11} + x^{10} + x^8 + x^7 + x^5 + x^4 + x^2 + x + 1$. The algorithms used by the transmitter and the receiver are defined in ITU-T Rec. I.363.5.
- 2) Transparency: After computation of the FCS, the transmitting DTE or DCE shall examine the contents of the frame between the opening and closing flags (address, information and FCS fields). It shall insert the following binary number escape code 01111101 if a flag sequence (01111110) or an escape code (01111101) is encountered in the contents of the frame. Before FCS computation, the receiving DTE or DCE shall examine the contents of the frame between the two flags, if an octet is preceded by the escape code, the escape code is removed.
- 3) Scrambling as per ITU-T Rec. G.707/Y.1322 is used.

9.6 Fragmentation

This clause provides optional support for transmitting Frame Relay DTEs and DCEs with the ability to fragment long frames into a sequence of shorter frames, which will then be reassembled into the original frame by the receiving peer DTE or DCE.

To properly support delay-sensitive traffic on low-speed virtual connections, it is necessary to fragment the longer, more delay-tolerant frames that share the same connections. This is done so that the shorter, delay sensitive frames are not excessively delayed. Fragmentation is strictly local to the DTE/DCE interface, and the fragment size can be optimally configured to provide the proper delay and delay variation based upon the logical speed of the DTE/DCE interface.

Since fragmentation is local to the interface, the network can take advantage of the higher internal trunk speeds by transporting the complete frames, which is more efficient than transporting a larger number of smaller fragments.

The DTE and DCE interfaces act as fragmentation and reassembly peers, as shown in Figure 9-6.

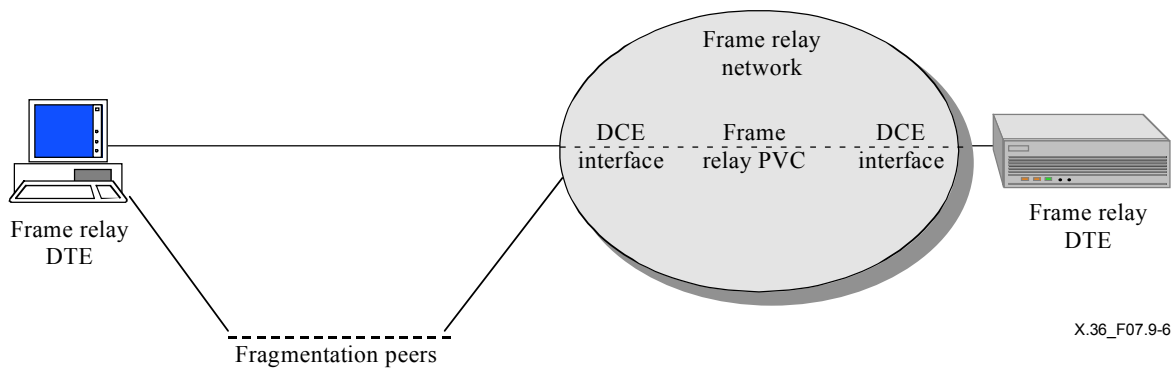

Figure 9-6/X.36 – DTE-DCE fragmentation/reassembly reference diagram

It should be noted that the fragmentation function has been illustrated as a standalone "Logical Fragmentation Function", but it is expected to be implemented in the DTE and DCE interfaces shown in Figure 9-6.

Fragmentation is provisioned on an interface-by-interface basis. When configured on an interface, then fragmentation procedures and format apply to all DLCIs (including DLCI 0, PVCs, and SVCs).

A subscription parameter defines the maximum Fragment size that can be used at the DTE/DCE interface. This parameter applies to both directions of data transmission.

9.6.1 Fragmentation format

A two-octet fragmentation header is inserted between the opening flag and the address field of the Frame Relay Frame.

The format for each fragment of a Frame Relay frame is described in Figure 9-7.

8	7	6	5	4	3	2	1	Octet
0	1	1	1	1	1	1	0	1
B	E	C	Fragment sequence number (most significant 4 bits)				1	2
Fragment sequence number (less significant 8 bits)								3
Address field first octet								4
Address field second octet								5
Fragment payload								8
Frame check sequence first octet								N – 3
Frame check sequence second octet								N – 2
0	1	1	1	1	1	1	0	N – 1
								N

Figure 9-7/X.36 – Access fragment format

The (B)eginning fragment bit is a one-bit field set to 1 on the first fragment derived from the original frame and set to 0 for all other fragments from the same frame.

The (E)nding fragment bit is a one-bit field set to 1 on the last fragment and set to 0 for all other fragments. A fragment may have both the (B)eginning and (E)nding fragment bits set to 1.

The (C)ontrol bit is set to 0 in all fragments. It is reserved for future control functions.

The fragment sequence number is a 12-bit binary number that is incremented modulo 2^{12} for every fragment transmitted on a VC. There is a separate sequence number maintained for each VC across the DTE/DCE interface.

Note that the low order bit of the first octet of the fragmentation header is set to 1. This allows the fragmentation header to be distinguishable from the Frame Relay header. This allows a fragmentation entity to detect the misconfiguration of its peer, since the peers must be configured identically to use or not use fragmentation across an interface. If a peer is configured for access fragmentation and receives frames that do not contain the fragmentation header, those frames are discarded. If a peer is not configured for access fragmentation and receives frames with the fragmentation header, those frames will be discarded due to the violation of the Frame Relay header format.

9.6.2 Fragmentation procedures

Fragmentation applies to the Information field of the FR frames to be transmitted over the DTE/DCE interface.

A series of Fragments is created by dividing the Information field of a FR frame into fragment payloads. Each resulting fragment payload is transmitted over its intended VC using the fragment format described in Figure 9-7.

All fragments are variable in size.

The transmitter should not exceed the subscribed fragment maximum size.

The resulting fragments must be transmitted in the same sequence as they occurred in the frame prior to being fragmented. Fragments from multiple VCs may be interleaved with each other on one interface.

The first fragment in the series has the B bit set, and the final fragment has the E bit set. Every fragment in the series contains the same address octets that were on the original unfragmented frame, including the Frame Relay congestion bits (FECN, BECN, DE).

The first fragment sent on a VC (following a VC becoming active) may have the sequence number set to any value (including zero), and the sequence number must subsequently be incremented by one for each fragment sent. The sequence number is incremented without regard to the original frame boundaries; if the last fragment in one frame used sequence number "N", then the first fragment of the following frame will use sequence number "N+1". This allows lost fragments (and bursts of lost fragments) to be easily detected. Each VC has its own fragmentation sequence number sequence, independent of all other VCs.

If sufficient fragments are sent on an active VC, the sequence number will wrap from all ones to zero, and will eventually also wrap past the original sequence number sent on the VC after it became active.

9.6.3 Reassembly procedures

For each VC, the receiver must keep track of the incoming sequence numbers and maintain the most recently received sequence number. The receiver detects the end of a reassembled frame when it receives a fragment bearing the (E)nding bit. Reassembly of the frame is complete if all sequence numbers up to that fragment have been received.

Note that the Frame Relay congestion bits (FECN, BECN, DE) must be logically ORed for all fragments, and the results included in the reassembled frame.

The receiver detects lost fragments when one or more sequence numbers are skipped. When a lost fragment or fragments are detected on a VC, the receiver must discard all currently unassembled and subsequently received fragments for that VC until it receives the first fragment that bears the (B)eginning bit. The fragment bearing the (B)eginning bit is used to begin accumulating a new frame.

In the event of an error (e.g., one or more fragments lost due to transmission error or reassembly buffer overflow), fragments which cannot be reconstructed back into the original frame must be discarded by the receiver.

In case a fragment exceeds the subscribed maximum Data Fragment size, this fragment, and as a result the following and received fragments of the FR frame being reassembled, should be discarded, by the receiver.

In case it has an information field longer than N203, the reassembled FR frame should be discarded.

9.6.4 Example of operation

An example of the fragmentation procedure, using a multiprotocol encapsulated frame as the data to be fragmented, is diagrammed in Figure 9-8. The octets in white indicate the data portion of the original frame that is split into fragments (three fragments in this example). While this example uses a multiprotocol encapsulated frame for illustration purposes, any arbitrary frame contents may be fragmented. For this example, the starting sequence number of 42 was chosen at random.

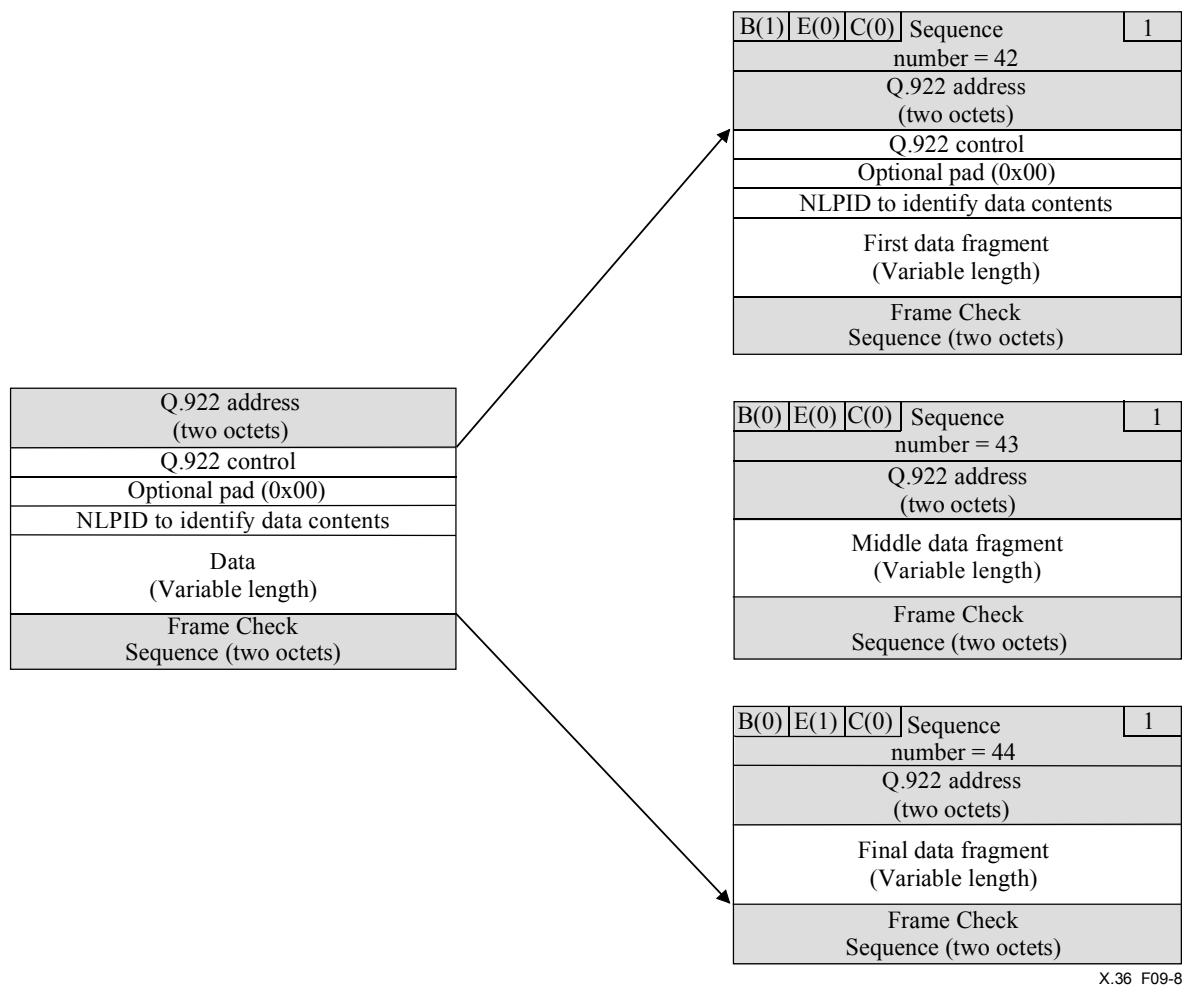

Figure 9-8/X.36 – DTE-DCE fragmentation example

10 Call connection control

10.1 General

This clause defines the signalling for frame relay Switched Virtual Circuits (SVCs) control at the DTE/DCE interface of a public data network providing a frame relay service. The following optional facilities also are defined: Closed user group, reverse charging indication and prevention and transit network selection.

10.2 Signalling channel

ITU-T Rec. Q.922 defines the link layer protocol known as LAPF to provide a reliable data link connection for the exchange of SVC signalling messages defined in this clause across a DTE/DCE interface (see Figure 10-1).

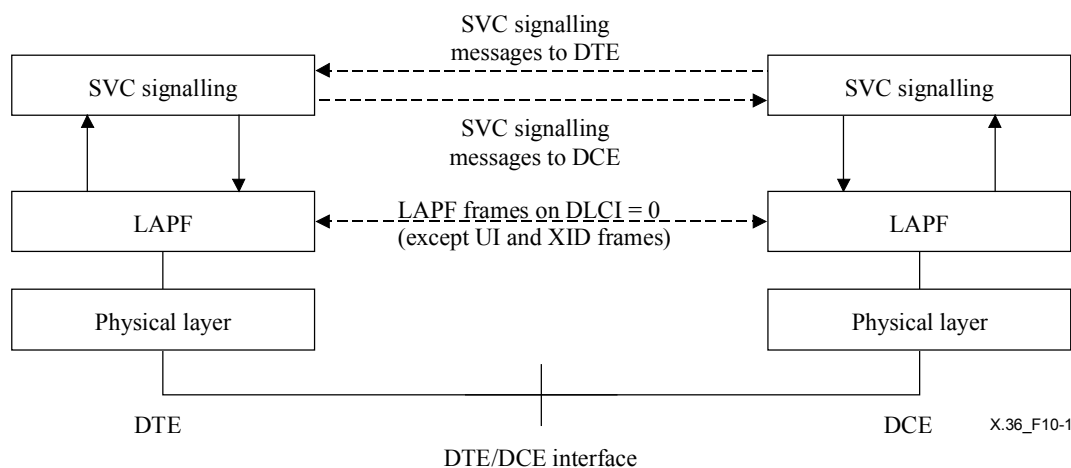

Figure 10-1/X.36 – DTE/DCE protocol layers for signalling

The following frame types identified in ITU-T Rec. Q.922 and defined in ITU-T Rec. Q.921 must be supported:

- Set Asynchronous Balanced Mode Extended (SABME) command;
- Disconnection (DISC) command;
- Receive Ready (RR) command and response;
- Reject (REJ) command/response;
- Receive Not Ready (RNR) command/response;
- I-frames;
- Unnumbered Acknowledgment (UA) response;
- Disconnected Mode (DM) response;
- Frame Reject (FRMR) response.

XID frames are not used and Unnumbered Information (UI) frames are used for PVC signalling. SVC signalling does not affect PVC signalling since for SVC signalling, I-frames are used whereas for PVC signalling UI frames are used.

In order to exchange SVC signalling messages across the DTE/DCE interface, a LAPF link has to be established using DLCI = 0. After establishment of LAPF link, the data link connection identified with DLCI = 0 is automatically ready for the exchange of the signalling messages across the DTE/DCE interface. This LAPF link is known as the signalling channel.

On the signalling channel, FECN, BECN and DE bits are not used. They must be set to 0 upon transmission and must not be interpreted upon reception.

10.3 List of the signalling channel link layer parameters

The values of the link layer parameters of the link layer protocol used on the signalling channel are as follows:

- 1) Timer T200: The default value of the retransmission timer T200 at the end of which transmission of a frame may be initiated according to the procedures of ITU-T Rec. Q.922 is 1 second.
- 2) Timer T203: The idle timer T203 represents the maximum time allowed without frames being exchanged; its default value is 30 seconds.
- 3) Maximum number of retransmissions N200: The retransmission counter N200 identifies the maximum number of retransmissions of a frame; its default value is 3.
- 4) Maximum number k of outstanding I frames: The default maximum number k of outstanding sequentially numbered I frames (that is, unacknowledged) at any given time shall be 7.
- 5) Maximum number of octets in an Information field: The default for the number of octets N201 in an information field is 1598 ($N203 - 2$) octets.

10.4 Call states

10.4.1 Call states at the DTE side

The following states are the DTE states that may exist at the DTE side of the DTE/DCE interface, (the states have local significance):

- **Null (U0)** – No switched virtual circuit exists.
- **Call Initiated (U1)** – This state exists for an outgoing switched virtual circuit when the DTE has sent a request to the DCE to establish a frame relay switched virtual circuit.
- **Outgoing Call Proceeding (U3)** – This state exists for an outgoing switched virtual circuit when the DTE has received an indication that the DCE has received the necessary information to establish the frame relay switched virtual circuit.
- **Call Present (U6)** – This state exists for an incoming switched virtual circuit when the DTE has received a request to establish a frame relay switched virtual circuit but has not yet responded.
- **Incoming Call Proceeding (U9)** – This state exists for an incoming call when the DTE has acknowledged the receipt of the request to establish a frame relay switched virtual circuit.
- **Active (U10)** – This state exists for an incoming or outgoing switched virtual circuit when the frame relay switched virtual circuit has been established and data transfer phase can begin.
- **Disconnect Request (U11)** – This state exists when the DTE has requested the DCE to disconnect the frame relay switched virtual circuit and is waiting for a response.
- **Disconnect Indication (U12)** – This state exists when the DTE has received an invitation to disconnect the frame relay switched virtual circuit and has not replied yet.
- **Release request (U19)** – This state exists when the DTE has sent a request to the DCE to release the frame relay switched virtual circuit and is waiting for the response.

10.4.2 Call states at the DCE side

The following states are the DCE states that may exist at the DCE side of the DTE/DCE interface, (the states have local significance):

- **Null (N0)** – No switched virtual circuit exists.
- **Call Initiated (N1)** – This state exists for an outgoing switched virtual circuit when the DCE has received a request to establish a frame relay switched virtual circuit but has not yet responded.
- **Outgoing Call Proceeding (N3)** – This state exists for an outgoing switched virtual circuit when the DCE has acknowledged the receipt of the information necessary to establish the frame relay switched virtual circuit.
- **Call Present (N6)** – This state exists for an incoming switched virtual circuit when the DCE has sent a request to establish a frame relay switched virtual circuit but the DTE has not responded.
- **Incoming Call Proceeding (N9)** – This state exists for an incoming switched virtual circuit when the DCE has received an acknowledgement that the called DTE has received the request to set up the frame relay switched virtual circuit.
- **Active (N10)** – This state exists for an incoming or outgoing switched virtual circuit when the frame relay connection has been established and the data transfer phase can begin.
- **Disconnect Request (N11)** – This state exists when the DCE has received a request from the DTE to disconnect the frame relay switched virtual circuit.
- **Disconnect Indication (N12)** – This state exists when the DCE has disconnected the frame relay switched virtual circuit and has sent an invitation to disconnect and is waiting for the reply from the DTE.
- **Release Request (N19)** – This state exists when the DCE has requested the DTE to release the frame relay switched virtual circuit and is waiting for the response.

10.4.3 States used with the restart facility

The following states are associated with the restart facility, the states are the states of the DTE or DCE side of the interface and have a local significance:

- **Null (Rest0)** – No restart request exists.
- **Restart request (Rest1)** – This state exists after a DTE or a DCE has sent a restart request to the other side of the DTE/DCE interface and is waiting for an acknowledgement.
- **Restart (Rest2)** – This state exists when one side of the DTE/DCE interface has received a request for a restart and has not returned an acknowledgement yet.

10.5 Message definitions

This clause provides an overview of the message structure, which highlights the functional definition and information content of each message. Each definition includes:

- 1) A brief description of the message direction and use, including whether the message has:
 - a) Local significance, i.e., relevant only at a DTE/DCE interface;
 - b) Global significance, i.e., relevant at both the local and remote DTE/DCE interfaces and in the network.
- 2) A table listing the information elements in the order of their appearance in the message. For each information element the table indicates:
 - a) the clause of this Recommendation describing the information element;
 - b) the direction in which it may be sent, i.e., DTE to DCE, DCE to DTE or both;

- c) whether the information element inclusion in the message is mandatory (M), or optional (O), with a reference to notes explaining the circumstances under which the information element shall be included;
- d) the length of the information element (or permissible range of length) in octets. "*" denotes an undefined length which may be network or DTE/DCE dependent;
- e) further explanatory notes as necessary.

Table 10-1 lists the messages for frame relay SVC. These messages are a subset of the messages defined and specified in ITU-T Recs Q.931 and Q.933.

Every message transferred across the DTE/DCE interface on the logical data link identified by DLCI=0 consists of at least five octets. These five octets contain a Protocol Discriminator (1 octet), a Call Reference (3 octets) and a Message Type (1 octet). Other information elements are included as required.

Table 10-1/X.36 – Messages for frame relay SVC signalling

Message	Reference
<i>Virtual circuit establishment messages:</i>	
CALL PROCEEDING	10.5.1
CONNECT	10.5.2
SETUP	10.5.8
<i>Virtual circuit clearing messages:</i>	
DISCONNECT	10.5.3
RELEASE	10.5.4
RELEASE COMPLETE	10.5.5
<i>Miscellaneous messages:</i>	
RESTART	10.5.6
RESTART ACKNOWLEDGE	10.5.7
STATUS	10.5.9
STATUS ENQUIRY	10.5.10

10.5.1 CALL PROCEEDING

This message is sent by the DCE to the calling DTE and by the called DTE to the DCE to indicate that the set-up request for the switched virtual connection has been initiated. This message acknowledges the receipt of the SETUP message, (see Table 10-2).

Table 10-2/X.36 – CALL PROCEEDING message content

Message type: CALL PROCEEDING		Direction: Both		
Significance: Local				
Information element	Reference	Direction	Type	Length
Protocol discriminator	10.6.1	Both	Mandatory	1
Call reference	10.6.2	Both	Mandatory	3
Message type	10.6.3	Both	Mandatory	1
Data Link Connection Identifier	10.6.14	Both	Mandatory	4-6

10.5.2 CONNECT

This message is sent by the called DTE to the DCE and by the DCE to the calling DTE to indicate that the called DTE has accepted the request to establish a switched virtual circuit (see Table 10-3).

Table 10-3/X.36 – CONNECT message content

Message type: CONNECT Significance: Global		Direction: Both		
Information element	Reference	Direction	Type	Length
Protocol discriminator	10.6.1	Both	Mandatory	1
Call reference	10.6.2	Both	Mandatory	3
Message type	10.6.3	Both	Mandatory	1
Data Link Connection Identifier	10.6.14	Both	Optional (Note 1)	4-6
Link layer core parameters	10.6.15	Both	Mandatory	4-31
Connected number	10.6.12	Both	Optional (Note 2)	*
Connected subaddress	10.6.13	Both	Optional (Note 3)	*
Low layer compatibility	10.6.17	Both	Optional (Note 5)	4-15
User-user	10.6.21	Both	Optional (Note 4)	2-131

NOTE 1 – Mandatory in the DTE-to-DCE direction when the called DTE replies to the incoming SETUP message with a CONNECT message. In all other cases it is optional.

NOTE 2 – If included by the called DTE in the DTE-to-DCE direction, then its presence is optional in the DCE-to-DTE direction if it is the same as the Called party number presented to the called DTE in the SETUP message. Its presence is mandatory in the DCE-to-DTE direction if it is different from the called party number presented to the called DTE in the SETUP message.

NOTE 3 – Included in the DCE-to-DTE direction at the calling DTE/DCE interface if it was included in the DTE-to-DCE direction at the called DTE/DCE interface to identify the connected subaddress to the calling DTE.

NOTE 4 – Included in the DCE-to-DTE direction at the calling DTE/DCE interface if it was included in the DTE-to-DCE direction at the called DTE/DCE interface to pass user data from the answering DTE to the calling DTE.

NOTE 5 – Included in the DCE-to-DTE direction at the calling DTE/DCE interface if it was included in the DTE-to-DCE direction at the called DTE/DCE interface. See procedures in D.6.

10.5.3 DISCONNECT

This message is sent by a DTE to the DCE, and by a DCE to a DTE to disconnect the frame relay SVC (see Table 10-4).

Table 10-4 /X.36 – DISCONNECT message content

Message type: DISCONNECT		Direction: Both		
Significance: Global				
Information element	Reference	Direction	Type	Length
Protocol discriminator	10.6.1	Both	Mandatory	1
Call reference	10.6.2	Both	Mandatory	3
Message type	10.6.3	Both	Mandatory	1
Cause	10.6.10	Both	Mandatory	4-*

10.5.4 RELEASE

This message is sent by a DTE to the DCE, and by the DCE to the DTE to clear the frame relay SVC (see Table 10-5).

Table 10-5/X.36 – RELEASE message content

Message type: RELEASE		Direction: Both		
Significance: Local (Note 1)				
Information element	Reference	Direction	Type	Length
Protocol discriminator	10.6.1	Both	Mandatory	1
Call reference	10.6.2	Both	Mandatory	3
Message type	10.6.3	Both	Mandatory	1
Cause	10.6.10	Both	(Note 2)	4-*
NOTE 1 – This message has local significance. However, it may carry information of global significance when used as the first call clearing message.				
NOTE 2 – Mandatory if the RELEASE message is the first call clearing message sent as a result of an error handling condition; otherwise, it is optional. This information element may be repeated to indicate multiple clearing causes.				

10.5.5 RELEASE COMPLETE

This message is sent by a DTE to the DCE and by the DCE to the other DTE as part of the clearing process (see Table 10-6).

Table 10-6/X.36 – RELEASE COMPLETE message content

Message type: RELEASE COMPLETE		Direction: Both		
Significance: Local (Note 1)				
Information element	Reference	Direction	Type	Length
Protocol discriminator	10.6.1	Both	Mandatory	1
Call reference	10.6.2	Both	Mandatory	3
Message type	10.6.3	Both	Mandatory	1
Cause	10.6.10	Both	(Note 2)	4-*
NOTE 1 – This message has local significance. However, it may carry information of global significance when used as the first call clearing message.				
NOTE 2 – Mandatory if the RELEASE COMPLETE message is the first call clearing message sent as a result of an error handling condition, otherwise it is optional. This information element may be repeated to indicate multiple clearing causes.				

10.5.6 RESTART

This message is sent by a DTE to a DCE or a DCE to a DTE to request the recipient to restart (i.e., return to an idle condition) the DTE/DCE interface (see Table 10-7).

Table 10-7/X.36 – RESTART message content

Message type: RESTART Significance: Local		Direction: Both		
Information element	Reference	Direction	Type	Length
Protocol discriminator	10.6.1	Both	Mandatory	1
Call reference	10.6.2	Both	Mandatory (Note)	3
Message type	10.6.3	Both	Mandatory	1
NOTE – The RESTART message is sent with the global call reference.				

10.5.7 RESTART ACKNOWLEDGE

This message is sent by a DTE to a DCE or a DCE to a DTE to acknowledge the receipt of the restart message and to indicate that the requested restart is complete (see Table 10-8).

Table 10-8/X.36 – RESTART ACKNOWLEDGE message content

Message type: RESTART ACKNOWLEDGE Significance: Local		Direction: Both		
Information element	Reference	Direction	Type	Length
Protocol discriminator	10.6.1	Both	Mandatory	1
Call reference	10.6.2	Both	Mandatory (Note)	3
Message type	10.6.3	Both	Mandatory	1
NOTE – The RESTART ACKNOWLEDGE message is sent with the global call reference.				

10.5.8 SETUP

This message is sent by the calling DTE to the DCE, and by the DCE to the called DTE to initiate the establishment of the Frame Relay switched virtual circuit (see Table 10-9).

Table 10-9/X.36 – SETUP message content

Message type: SETUP Significance: Global		Direction: Both		
Information element	Reference	Direction	Type	Length
Protocol discriminator	10.6.1	Both	Mandatory	1
Call reference	10.6.2	Both	Mandatory	3
Message type	10.6.3	Both	Mandatory	1
Bearer capability	10.6.4	Both	Mandatory	5
Data Link Connection Identifier	10.6.14	n → u	Mandatory (Note 1)	4-6
Closed user group	10.6.11	Both	Optional	4-7
Link layer core parameters	10.6.15	Both	Optional (Note 2)	4-31
Link layer protocol parameters	10.6.16	Both	Optional	2-9
Priority and service class parameters	10.6.18	Both	Optional	2-8
Reverse charging indication	10.6.19	Both	Optional	3
Calling party number	10.6.8	Both	Optional (Note 3)	*
Calling party subaddress	10.6.9	Both	Optional (Note 4)	*
Called party number	10.6.6	Both	Optional (Note 5)	*
Called party subaddress	10.6.9	Both	Optional (Note 6)	*
Transit network selection	10.6.20	u → n	Optional	7-11
Low layer compatibility	10.6.17	Both	Optional (Notes 6, 7, 8)	4-15
User-user	10.6.21	Both	Optional (Note 6)	2-131

Table 10-9/X.36 – SETUP message content

NOTE 1 – Mandatory in the DCE-to-DTE direction. Not allowed in the DTE-to-DCE direction.
NOTE 2 – Included in the DTE-to-DCE direction when the calling DTE wants to indicate the proposed link layer core parameters to the network. Always included in the DCE-to-DTE direction. If the link layer core parameters information element is missing or partially specified, in the DTE-to-DCE direction, the network will use default values and will present them to the called DTE.
NOTE 3 – Mandatory in the DCE-to-DTE direction to identify the calling user. Optional in the DTE-to-DCE direction.
NOTE 4 – Included in the DCE-to-DTE direction if the calling party included this information element in the DTE-to-DCE direction.
NOTE 5 – Mandatory in the DTE-to-DCE direction to identify the called user. Included in the DCE-to-DTE direction when called party number information is to be conveyed to the called DTE (e.g., when the called DTE is a private network).
NOTE 6 – Included in the DCE-to-DTE direction at the called DTE/DCE interface if it was included by the calling DTE.
NOTE 7 – Included in the DCE-to-DTE direction at the called DTE/DCE interface if it was included by the calling DTE. This information element may be repeated according to the procedures in D.6.
NOTE 8 – This information element may occur up to three times.

10.5.9 STATUS

This message is sent by the DCE to a DTE and by a DTE to the DCE in response to a STATUS ENQUIRY or at any time to report certain error condition (see Table 10-10).

Table 10-10/X.36 – STATUS message content

Message type: STATUS		Direction: Both		
Significance: Local				
Information element	Reference	Direction	Type	Length
Protocol discriminator	10.6.1	Both	Mandatory	1
Call reference	10.6.2	Both	Mandatory	3
Message type	10.6.3	Both	Mandatory	1
Cause	10.6.10	Both	Mandatory	4-*
Call State	10.6.5	Both	Mandatory	3

10.5.10 STATUS ENQUIRY

This message is sent by a DTE to the DCE and by the DCE to a DTE at any time to solicit a STATUS message (see Table 10-11).

Table 10-11/X.36 – STATUS ENQUIRY message content

Message type: STATUS ENQUIRY		Direction: Both		
Significance: Local				
Information element	Reference	Direction	Type	Length
Protocol discriminator	10.6.1	Both	Mandatory	1
Call reference	10.6.2	Both	Mandatory	3
Message type	10.6.3	Both	Mandatory	1

10.6 General message format and information element coding

This clause describes the information elements which are included in the various signalling messages defined in the previous clause.

Every message of this protocol shall consist of the following parts:

- a) Protocol discriminator;
- b) Call reference;
- c) Message type;
- d) Other information elements.

Information elements a), b), c) are common to all the messages and shall always be present. Each message will have additional information elements. This organization is shown in Figure 10-2.

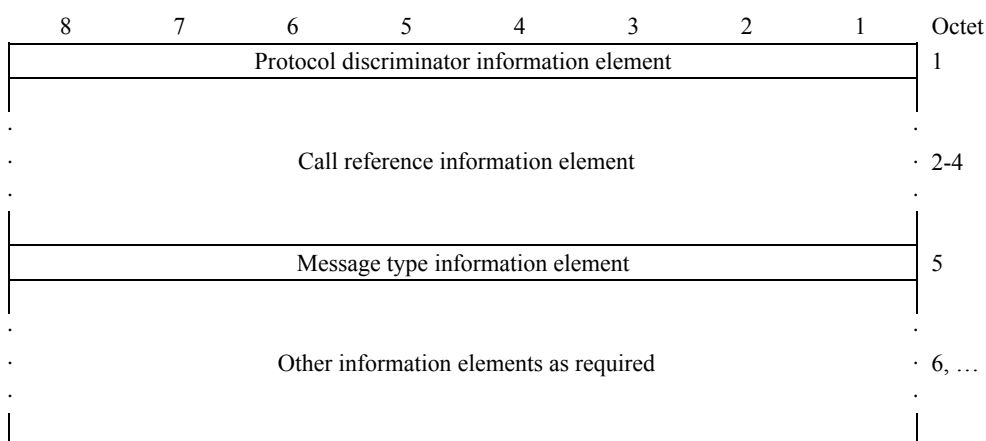

Figure 10-2/X.36 – General message organization example

Unless specified otherwise, a particular information element may be present only once in a given message.

The information elements used for frame relay SVC are:

Information element	Information element identifier	Reference
Protocol discriminator	Not applicable	10.6.1
Call reference	Not applicable	10.6.2
Message type	Not applicable	10.6.3
Bearer Capability	0 0 0 0 0 1 0 0	10.6.4
Call State	0 0 0 1 0 1 0 0	10.6.5
Called party number	0 1 1 1 0 0 0 0	10.6.6
Called party subaddress	0 1 1 1 0 0 0 1	10.6.7
Calling party number	0 1 1 0 1 1 0 0	10.6.8
Calling party subaddress	0 1 1 0 1 1 0 1	10.6.9
Cause	0 0 0 0 1 0 0 0	10.6.10
Closed user group	0 1 0 0 0 1 1 1	10.6.11
Connected number	0 1 0 0 1 1 0 0	10.6.12

Information element	Information element identifier	Reference
Connected subaddress	0 1 0 0 1 1 0 1	10.6.13
Data link connection identifier	0 0 0 1 1 0 0 1	10.6.14
Link layer core parameters	0 1 0 0 1 0 0 0	10.6.15
Link layer protocol parameters	0 1 0 0 1 0 0 1	10.6.16
Low layer compatibility	0 1 1 1 1 1 0 0	10.6.17
Priority and service class parameters	0 1 1 0 1 0 1 0	10.6.18
Reverse charge indication	0 1 0 0 1 0 1 0	10.6.19
Transit network selection	0 1 1 1 1 0 0 0	10.6.20
User-user	0 1 1 1 1 1 1 0	10.6.21

The coding of the information elements other than the first three mandatory information elements (protocol discriminator, call reference and message type) is as follows:

- The information elements used with frame relay call control are of variable length. They are described in alphabetical order. However, there is a particular order of appearance for each information element in a message. The code values of the variable length information element identifiers are assigned in numerical order according to the actual order of appearance of each information element in a message. This allows a receiver to detect the presence or absence of a particular information element without scanning through the entire message.
- Information element identifier values (first octet of a variable length information element) with bits 5-8 coded "0000" are for future information elements for which comprehension by the receiver is required.
- When the description of the information elements contains spare bits, these bits are indicated as being set to "0".
- The second octet of a variable length information element indicates the total length of the contents starting with octet 3. It is the binary coding of the number of octets of the contents, with bit 1 as the least significant bit.
- Each octet of a variable length information element is numbered.
- Optional octet(s) are marked with asterisks (*).
- An octet group is a self-contained entity, it contains one or more octets. For frame relay information elements, the internal structure of an octet group is defined by using the following extension mechanism:
 - The first octet of an octet group is identified by a number (N). The subsequent octets are identified as Na, Nb, Nc, ... Bit 8 of each octet is the *extension bit*. The value "0" of bit 8 indicates that the octet group continues to the next octet. The value "1" of bit 8 indicates that this octet is the last octet of the octet group. If one octet (Nc) must be present, the preceding octets (N, Na and Nb) must also be present.
 - In the description of the information elements, bit 8 is marked "0/1 ext." if another octet follows. Bit 8 is marked "1 ext." if this is the last octet of the octet group.
- When a field extends over more than one octet, the order of bit values progressively decreases as the octet number increases. The least significant bit of the field is represented by the lowest numbered bit of the highest-numbered octet of the field.

10.6.1 Protocol discriminator

The protocol discriminator is the first part (first octet) of every message. It is coded as shown in Figure 10-3.

8	7	6	5	4	3	2	1	Octet
Protocol discriminator								1
0	0	0	0	1	0	0	0	

Figure 10-3/X.36 – Protocol discriminator

10.6.2 Call reference

The purpose of the call reference is to identify the switched virtual circuit to which the particular message applies. The call reference does not have end-to-end significance. The call reference is the second part of every message.

The call reference is coded as shown in Figure 10-4. Only call reference values of two octets (15 bits) are supported in this Recommendation. The encoding of the call reference value always uses two octets even if the value can be encoded in one octet only. Hence, the length field will always have a binary value of "0010". The most significant bit of the call reference value is bit 7 of octet 2 and the least significant bit is bit 1 of octet 3.

8	7	6	5	4	3	2	1	Octet
0	0	0	0	Length of call reference (in octets)				1
Flag		Call reference value (most significant 7 bits)						2
Call reference value (2nd most significant 8 bits)								3

Flag (octet 2)

Bit

8

- 0 The message is sent **from** the side of the DTE/DCE interface that originates the call reference.
- 1 The message is sent **to** the side of the DTE/DCE interface that originates the call reference.

Figure 10-4/X.36 – Call reference information element

The purpose of the call reference flag is to identify who allocated the call reference value for a call. The call reference flag is used to resolve simultaneous attempts to allocate the same call reference value.

The call reference flag can take the binary values "0" or "1". The call reference flag is used to identify which end of the DTE/DCE interface originated a call reference. The origination side always sets the call reference flag to "0". The recipient side always sets the call reference flag to "1".

The call reference value will always have two octets. The call reference value is coded as a 15-bit binary number. A call reference value equal to zero is reserved for the global call reference value. The global call reference has also a length of 2 octets.

10.6.3 Message type

The purpose of the message type is to identify the message being sent. The message type is the third part of every message (see Figure 10-5 and Table 10-12).

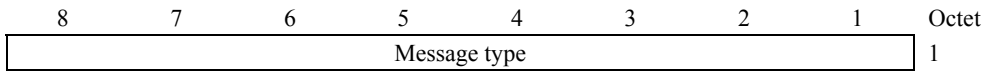

Figure 10-5/X.36 – Message type

Table 10-12/X.36 – Message types

Bits	
<u>8 7 6 5 4 3 2 1</u>	
	<i>SVC establishment messages</i>
0 0 0 0 0 0 1 0	CALL PROCEEDING
0 0 0 0 0 1 1 1	CONNECT
0 0 0 0 0 1 0 1	SETUP
	<i>SVC clearing messages</i>
0 1 0 0 0 1 0 1	DISCONNECT
0 1 0 0 1 1 0 1	RELEASE
0 1 0 1 1 0 1 0	RELEASE COMPLETE
	<i>Miscellaneous messages</i>
0 1 0 0 0 1 1 0	RESTART
0 1 0 0 1 1 1 0	RESTART ACKNOWLEDGE
0 1 1 1 1 1 0 1	STATUS
0 1 1 1 0 1 0 1	STATUS ENQUIRY

10.6.4 Bearer capability

The purpose of the bearer capability information element is to request a bearer service. The only bearer service supported is the Frame Relay bearer service. The bearer capability information element is coded as shown in Figure 10-6.

8	7	6	5	4	3	2	1	Octet (Note)
Bearer capability information element identifier								
0	0	0	0	0	1	0	0	1
Length of the bearer capability contents								
0	0	0	0	0	0	1	1	2
ext.	Coding Standard		Information Transfer capability					
1	0	0	0	1	0	0	0	3
ext.	Transfer mode		Reserved					
1	0	1	0	0	0	0	0	4
ext.	Layer 2 ident.		User information layer 2 protocol					
1	1	0	0	1	1	1	1	6

NOTE – Octet group 5 defined in ITU-T Recs Q.931 and Q.933 is not used. For consistency, Q.931 and Q.933 octet numbering is kept.

Figure 10-6/X.36 – Bearer capability information element

10.6.5 Call state

The purpose of the Call state information element is to describe the current state of a frame relay connection. The Call state information element is coded as shown in Figure 10-7 and Table 10-13.

8	7	6	5	4	3	2	1	Octet
Call state information element identifier								1
0	0	0	1	0	1	0	0	
Length of call state contents								2
0	0	0	0	0	0	0	1	
Coding Standard		Call state value/Global interface state (state value is coded in binary)						3
0	0							

Figure 10-7/X.36 – Call state information element

Table 10-13/X.36 – Call state information element

<i>Call state value (octet 3)</i>			
Bits			
<u>6 5 4</u>	<u>3 2 1</u>	<i>Call state at the DTE side</i>	<i>Call state at the DCE side</i>
0 0 0	0 0 0	U0 Null	N0 Null
0 0 0	0 0 1	U1 Call initiated	N1 Call initiated
0 0 0	0 1 1	U3 Outgoing call proceeding	N3 Outgoing call proceeding
0 0 0	1 1 0	U6 Call present	N6 Call present
0 0 1	0 0 1	U9 Incoming call proceeding	N9 Incoming call proceeding
0 0 1	0 1 0	U10 Active	N10 Active
0 0 1	0 1 1	U11 Disconnect request	N11 Disconnect request
0 0 1	1 0 0	U12 Disconnect indication	N12 Disconnect indication
0 1 0	0 1 1	U19 Release request	N19 Release request
<i>Global interface state value (octet 3)</i>			
Bits			
<u>6 5 4</u>	<u>3 2 1</u>	<i>State</i>	
0 0 0	0 0 0	REST0	Null
1 1 1	1 0 1	REST1	Restart request
1 1 1	1 1 0	REST2	Restart
All other values are reserved.			

10.6.6 Called party number

The purpose of the Called party number information element is to identify the called party of a call. The Called party number information element is coded as shown in Figure 10-8 and Table 10-14.

8	7	6	5	4	3	2	1	Octet	
Called party number information element identifier								1	
0	1	1	1	0	0	0	0		
Length of called party number contents								2	
ext. 1	Type of number			Numbering plan identification				3	
·	·								
·	0	Number digits (coded according to ITU-T Rec. T.50)						·	4
·	·								
								etc.	

Figure 10-8/X.36 – Called party number information element

Table 10-14/X.36 – Called party number information element

Type of number (octet 3)

Bits
7 6 5
0 0 1 International number (Note 1)
0 1 0 National number (Note 1)
0 1 1 Network specific number (for use in private network)
1 0 0 Complementary address without main address/subscriber number (Note 2)
1 0 1 Alternative address (see Numbering plan identification)
1 1 1 Reserved for extensions

All other values are reserved.

NOTE 1 – Prefix or escape digits shall not be included in the number digits.
NOTE 2 – The use of this code point is a network option (see Appendix IV).

Numbering plan identification (octet 3)

Bits
4 3 2 1
0 0 0 0 Unknown
0 0 0 1 ISDN/telephony numbering plan (ITU-T Rec. E.164)
0 0 1 1 Data numbering plan (ITU-T Rec. X.121)
1 0 0 1 Private numbering plan (for use with private networks)

All other values are reserved.

Numbering plan identification coding (octet 3) when type of number is alternative address

Bits
4 3 2 1
0 0 0 0 Character string coded in accordance with ITU-T Rec. T.50 and ISO/IEC 646. (Note 3)
0 0 0 1 ISO NSAP address coded in accordance with ITU-T Rec. X.213 | ISO/IEC 8348.
0 0 1 0 Media Access Control (MAC) address coded in accordance with ISO/IEC 10039. (Note 3)
0 0 1 1 Internet address coded in accordance with RFC 1166. (Note 3)

All other values are reserved.

NOTE 3 – The use of this code point is *for further study*.

Number digits (octet 4, etc.)

The number digits appear in multiple octets starting at octet 4. One digit is coded per octet such that the leftmost digit is coded in octet 4. Each digit corresponds to a T.50 character.

Valid combinations of type of number and numbering plan fields

Type of numbering	Numbering plan identification	Format
International	E.164	CC + N(S)N
International	X.121	DNIC + NTN
National	E.164	N(S)N
National	X.121	NTN or NN
Network specific	Private numbering plan	According to the private numbering plan
Alternative address	ISO NSAP	Number/address following NSAP format (Note 4)
Complementary address without main address	Unknown	User-specific

Table 10-14/X.36 – Called party number information element

NOTE 4 – This combination is used to allow the coding of an NSAP. The support of this combination is a network option. It is used to provide interworking of frame relay and ATM networks. The use of this combination does not imply that a frame relay network supports the numbering plans or addressing schemes identified in the NSAP. It rather allows the selection of a route towards a frame relay/ATM interworking unit.

10.6.7 Called party subaddress

The purpose of the Called party subaddress information element is to identify the subaddress of the called party of the call. The network does not interpret this information element. It is carried transparently between the calling and called interface. The Called party subaddress information element is coded as shown in Figure 10-9 and Table 10-15.

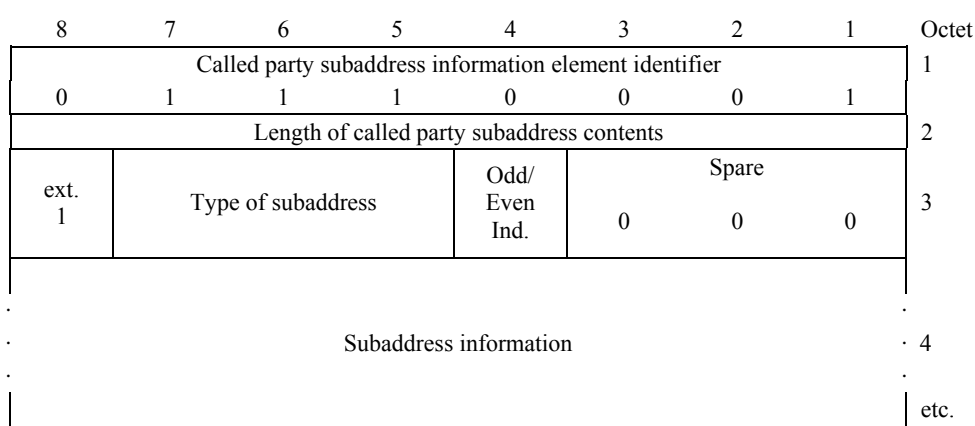

Figure 10-9/X.36 – Called party subaddress information element

Table 10-15/X.36 – Called party subaddress information element

Type of subaddress (octet 3)
 Bits
7 6 5
 0 0 0 NSAP (ITU-T Rec. X.213 | ISO/IEC 8348)
 0 1 0 User specified
 All other values are reserved.

Odd/even indicator (octet 3)
 Bit
4
 0 Even number of subaddress digits
 1 Odd number of subaddress digits

NOTE – The odd/even indicator is used when the type of subaddress (octet 3) is user specified and the coding is BCD.

Subaddress information (octet 4, etc.)
 The subaddress information is formatted according to the coding of the type of subaddress field (octet 3).

10.6.8 Calling party number

The purpose of the Calling party number information element is to identify the origin of a frame relay switched virtual circuit. The Calling party number information element is coded as shown in Figure 10-10 and Table 10-16.

8	7	6	5	4	3	2	1	Octet
0	1	1	0	1	1	0	0	1
Calling party number information element identifier								
Length of calling party number contents								2
ext. 0/1	Type of number			Numbering plan identification				3
ext. 1	Presentation indicator	0	Spare 0 0		Screening indicator			3a*
Number digits (coded according to ITU-T Rec. T.50)								4
								etc.

Figure 10-10/X.36 – Calling party number information element

Table 10-16/X.36 – Calling party number information element

<i>Type of number (octet 3)</i>	
Bits	
<u>7 6 5</u>	
0 0 1	International number (Note 1)
0 1 0	National number (Note 1)
0 1 1	Network specific number (for use in private network)
1 0 0	Complementary address without main address/subscriber number (Note 2)
1 0 1	Alternative address (See Numbering plan identification)
1 1 1	Reserved for extensions
All other values are reserved.	
NOTE 1 – Prefix or escape digits shall not be included in the number digits.	
NOTE 2 – The use of this code point is a network option (see Appendix IV).	
<i>Numbering plan identification (octet 3)</i>	
Bits	
<u>4 3 2 1</u>	
0 0 0 0	Unknown
0 0 0 1	ISDN/telephony numbering plan (ITU-T Rec. E.164)
0 0 1 1	Data numbering plan (ITU-T Rec. X.121)
1 0 0 1	Private numbering plan (Note 3)
All other values are reserved.	
NOTE 3 – For use with private networks.	
<i>Numbering plan identification coding (octet 3) when type of address is alternative address</i>	
Bits	
<u>4 3 2 1</u>	
0 0 0 0	Character string coded in accordance with ITU-T Rec. T.50 and ISO/IEC 646. (Note 4)
0 0 0 1	ISO NSAP address coded in accordance ITU-T Rec. X.213 ISO/IEC 8348.
0 0 1 0	Media Access Control (MAC) address coded in accordance with ISO/IEC 10039. (Note 4)
0 0 1 1	Internet address coded in accordance with RFC 1166. (Note 4)
All other values are reserved.	
NOTE 4 – The use of this code point is for further study.	

Table 10-16/X.36 – Calling party number information element

<i>Valid combinations of type of number and numbering plan fields</i>		
Type of numbering	Numbering plan identification	Format
International	E.164	CC + N(S)N
International	X.121	DNIC + NTN
National	E.164	N(S)N
National	X.121	NTN or NN
Network specific	Private numbering plan	According to the private numbering plan
Alternative address	ISO NSAP	Number/address following NSAP format (Note 5)
Complementary address without main address	Unknown	User-specific

NOTE 5 – This combination is used to allow the coding of an NSAP. The support of this combination is a network option. It is used to provide interworking of frame relay and ATM networks. The use of this combination does not imply that a frame relay network supports the numbering plans or addressing schemes identified in the NSAP. It rather allows the indication of a route from a frame relay/ATM interworking unit.

Presentation indicator (octet 3a) (Note 6)

Bits
7 6
 0 0 Presentation allowed
 All other values are reserved.

Screening indicator (octet 3a) (Note 6)

Bits
2 1
 0 0 User provided not screened. Not used in this Recommendation.
 0 1 User provided verified and passed (Note 7).
 1 0 User provided verified and failed. Not used in this Recommendation.
 1 1 Network provided.
 All other values are reserved.

NOTE 6 – The DCE shall always provide octet 3a.

NOTE 7 – Since in some cases the network cannot guarantee that the complete number identifies a DTE, the term "verified" implies matching the user provided number or part of this number with the range(s) of numbers stored at the network. It implies also at least a valid format of user provided number information.

Number digits (octet 4, etc.)

The number digits appear in multiple octets starting at octet 4. One digit is coded per octet such that the leftmost digit is coded in octet 4. Each digit corresponds to a character coded according to ITU-T Rec. T.50.

10.6.9 Calling party subaddress

The purpose of the Calling party subaddress information element is to identify the subaddress of the originator of the frame relay call. This information element is carried transparently across the network. The Calling party subaddress information element is coded as shown in Figure 10-11 and Table 10-17.

8	7	6	5	4	3	2	1	Octet
Calling party subaddress information element identifier								1
0	1	1	0	1	1	0	0	
Length of calling party subaddress contents								2
ext. 1	Type of subaddress			Odd/ even ind.	Spare			3
				0	0	0		
Subaddress information								4
								etc.

Figure 10-11/X.36 – Calling party subaddress information element

Table 10-17/X.36 – Calling party subaddress information element

<i>Type of subaddress (octet 3)</i>	
Bits	
<u>7 6 5</u>	
0 0 0	NSAP (ITU-T Rec. X.213 ISO/IEC 8348)
0 1 0	User specified
All other values are reserved.	
<i>Odd/even indicator (octet 3)</i>	
Bit	
<u>4</u>	
0	Even number of subaddress digits
1	Odd number of subaddress digits
NOTE – The odd/even indicator is used when the type of subaddress (octet 3) is user specified and the coding is BCD.	
<i>Subaddress information (octet 4, etc.)</i>	
The subaddress information is formatted according to the coding of the type of subaddress field (octet 3).	

10.6.10 Cause

The purpose of the Cause information element is to identify an event that occurred to a frame relay SVC, a DTE/DCE interface or the frame relay network and to provide a reason for clearing a frame relay SVC. The Cause information element is coded as shown in Figure 10-12 and Table 10-18. Annex E provides detailed information on the use and coding of the Cause information element fields. The cause information element may be repeated.

8	7	6	5	4	3	2	1	Octet
Cause information element identifier								1
0	0	0	0	1	0	0	0	
Length of cause contents								2
ext. 1	Coding 0	standard 0	Spare 0	Location				3
ext. 1	Cause value						4	
Diagnostic(s) (if any)								5* etc.

Figure 10-12/X.36 – Cause information element

Table 10-18/X.36 – Cause information element

<i>Location (octet 3) (see Annex E on Location field generation)</i>	
Bits	
<u>4 3 2 1</u>	
0 0 0 0	User (U)
0 0 0 1	Private network serving the local user (LPN)
0 0 1 0	Public network serving the local user (LN)
0 0 1 1	Transit network (TN)
0 1 0 0	Public network serving the remote user (RLN)
0 1 0 1	Private network serving the remote user (RPN)
0 1 1 1	International network (INTL)
1 0 1 0	Network beyond interworking point (BI)
All other values are reserved.	
<i>Cause value (octet 4 bits 1 to 7)</i>	
The cause value is divided into two fields, a class (bit 5 to 7) and a value within the class (bits 1 to 4). The class indicates the general nature of the event:	
Bits	
<u>7 6 5</u>	
0 0 0	Normal event
0 0 1	Normal event
0 1 0	Resource unavailable
0 1 1	Service or option not available
1 0 0	Service or option not implemented
1 0 1	Invalid message
1 1 0	Protocol error
1 1 1	Interworking
See Annex E on <i>Cause values</i> for the relevant cause values.	
<i>Diagnostic(s) (octet 5):</i> See Annex E on <i>Coding of the diagnostic field</i> for the relevant diagnostic codes. Further, the diagnostic field is optional and will not necessarily be provided by the DCE or the DTE even if a diagnostic is available for a cause value.	

10.6.11 Closed user group

The purpose of the Closed user group information element is to indicate the closed user group to be used for the SVC being established and to indicate the Outgoing Access selection facility. The Closed user group information element is coded as shown in Figure 10-13 and Table 10-19.

8	7	6	5	4	3	2	1	Octet
Closed user group information element identifier								1
0	1	0	0	0	1	1	1	
Length of CUG contents								2
ext.	Spare				CUG indication			3
1	0	0	0	0	0			
0	CUG index code (coded according to ITU-T Rec. T.50)							4 etc.

Figure 10-13/X.36 – Closed user group information element

Table 10-19/X.36 – Closed user group information element

<i>CUG indication (octet 3)</i>	
Bits	
<u>3 2 1</u>	
0 0 1	Closed user group selection
0 1 0	Closed user group with outgoing access selection
<i>CUG index code (octet 4, etc.)</i>	
The CUG index code is represented by up to four octets coded according to ITU-T Rec. T.50.	
Bits	
<u>7 6 5 4 3 2 1</u>	
0 1 1 0 0 0 0	0
0 1 1 0 0 0 1	1
0 1 1 0 0 1 0	2
0 1 1 0 0 1 1	3
0 1 1 0 1 0 0	4
0 1 1 0 1 0 1	5
0 1 1 0 1 1 0	6
0 1 1 0 1 1 1	7
0 1 1 1 0 0 0	8
0 1 1 1 0 0 1	9

10.6.12 Connected number

The purpose of the connected number is to identify the responding party of the call. The encoding of the connected number is shown in Figure 10-14. The coding of the Connected number information element is the same as that of the Calling party number information element.

8	7	6	5	4	3	2	1	Octet
Connected number information element identifier								1
0	1	0	0	1	1	0	0	
Length of connected number contents								2
ext. 0/1	Type of number			Numbering plan identification				3
ext. 1	Presentation indicator	0	Spare 0 0		Screening indicator			3a*
Number digits (coded according to ITU-T Rec. T.50)								4
0								etc.

Figure 10-14/X.36 – Connected number information element

10.6.13 Connected subaddress

The purpose of the connected subaddress is to identify the subaddress of the responding party of a call. The network does not interpret this information element. It has only to recognize and carry it transparently between the called and calling user. The encoding of the connected subaddress information element is shown in Figure 10-15 and Table 10-20.

8	7	6	5	4	3	2	1	Octet
Connected subaddress information element identifier								1
0	1	0	0	1	1	0	1	
Length of connected subaddress contents								2
ext. 1	Type of subaddress			Odd/even ind.	Spare			3
			0	0	0			4
Subaddress information								etc.

Figure 10-15/X.36 – Connected subaddress information element

Table 10-20/X.36 – Connected subaddress information element

<i>Type of subaddress (octet 3)</i>	
Bits	
<u>7</u>	<u>6</u>
0 0 0	NSAP (ITU-T Rec. X.213 ISO/IEC 8348)
0 1 0	User specified
All other values are reserved.	
<i>Odd/Even indicator (octet 3)</i>	
Bit	
<u>4</u>	
0	Even number of subaddress digits
1	Odd number of subaddress digits
NOTE – The odd/even indicator is used when the type of subaddress (octet 3) is user specified and the coding is BCD.	
<i>Subaddress information (octet 4, etc.)</i>	
The subaddress information is formatted according to the coding of the type of subaddress field (octet 3).	

10.6.14 Data link connection identifier

The Data Link Connection Identifier information element identifies the Data Link Connection Identifier (DLCI) assigned to the SVC. The DLCI is coded as shown in Figure 10-16. The default length of the DLCI values is two octets (10 bits). Optionally some networks may support DLCI values with four octets at the DTE/DCE interface by subscription. The data link connection identifier value is coded as a binary number.

	8	7	6	5	4	3	2	1	Octet
Data link connection identifier information element identifier									1
0 0 0 1 1 0 0 1									
Length of data link connection identifier contents									2
ext.	Pref./	Data link connection identifier							3
0	excl. 1	(Most significant 6 bits)							
ext.	Data link connection identifier				(Reserved)				3a
0/1	(2nd most significant 4 bits)				0	0	0		
ext.	Data link connection identifier								3b*
0	(3rd most significant 7 bits)								(Note)
ext.	Data link connection identifier						Res.		3c*
1	(4th most significant 6 bits)						0		(Note)

NOTE – These octets shall both be included only when subscription allows DLCIs of four octets (23 bits).

Figure 10-16/X.36 – Data link connection identifier information element

10.6.15 Link layer core parameters

The purpose of the link layer parameters information element is to indicate requested frame relay Quality of Service parameters to be used for the SVC. The Link layer core parameters information element is coded as shown in Figure 10-17 and Table 10-21.

8	7	6	5	4	3	2	1	Octet
Link layer core parameters information element identifier								1
0	1	0	0	1	0	0	0	(Notes 1, 2)
Length of link layer core parameters contents								2
ext. 0	Maximum Frame Relay Information Field (FRIF) size							3
	0	0	0	1	0	0	1	
ext. 0	Outgoing maximum FRIF size							3a
ext. 0/1	Outgoing maximum FRIF size (cont.)							3b
ext. 0	Incoming maximum FRIF size							3c*
ext. 1	Incoming maximum FRIF size (cont.)							3d*
ext. 0	Throughput							4*
	0	0	0	1	0	1	0	
ext. 0	Outgoing magnitude			Outgoing multiplier				4a*
ext. 0/1	Outgoing multiplier (cont.)							4b*
ext. 0	Incoming magnitude			Incoming multiplier				4c*
ext. 1	Incoming multiplier (cont.)							4d*
ext. 0	Minimum acceptable throughput							5*
	0	0	0	1	0	1	1	(Note 3)
ext. 0	Outgoing magnitude			Outgoing multiplier				5a*
ext. 0/1	Outgoing multiplier (cont.)							5b*
ext. 0	Incoming magnitude			Incoming multiplier				5c*
ext. 1	Incoming multiplier (cont.)							5d*
ext. 0	Committed burst size							6*
	0	0	0	1	1	0	1	
ext. 0	Outgoing committed burst size value							6a*
ext. 0/1	Outgoing committed burst size value (cont.)							6b*
ext. 0	Incoming committed burst size value							6c*
ext. 1	Incoming committed burst size value (cont.)							6d*
ext. 0	Excess burst size							7*
	0	0	0	1	1	1	0	
ext. 0	Outgoing excess burst size value							7a*
ext. 0/1	Outgoing excess burst size value (cont.)							7b*
ext. 0	Incoming excess burst size value							7c*
ext. 1	Incoming excess burst size value (cont.)							7d*
ext. 0	Committed burst size magnitude							8*
	0	0	1	0	0	0	0	
ext. 1	Spare		Incoming Bc magnitude		Outgoing Bc magnitude			8a*
ext. 0	Excess burst size magnitude							9*
	0	0	1	0	0	0	1	
ext. 1	Spare		Incoming Be magnitude		Outgoing Be magnitude			9a*

Figure 10-17/X.36 – Link layer core parameters information element

Notes relative to Figure 10-17

NOTE 1 – All the parameters are position independent. All the parameters are optional except the outgoing maximum FRIF size. If a parameter is not included, a default value will be used. The term *outgoing* corresponds to the calling to called DTE direction and the term *incoming* refers to the direction from the called to the calling DTE.

Several fields of the link layer core parameters information element are coded as binary numbers using 2 octets. The Most Significant Bit (MSB) of the field is the bit with the highest bit number of the first octet and the Least Significant Bit (LSB) is bit 1 of the second octet. When a field is coded as a binary number and requires one octet or less than 8 bits, the LSB is bit 1 and the MSB is the highest bit number allocated to the field.

NOTE 2 – When octet N (N = 3, 4, 5, 6 or 7) is present, octets Na and Nb shall also be present but the presence of octets Nc and Nd is not mandatory.

NOTE 3 – Octet group 5 (minimum acceptable throughput) may be included only in the SETUP message.

Table 10-21/X.36 – Link layer core parameters information element

<p><i>Maximum frame mode information field (octet group 3)</i></p> <p>The maximum frame relay information field, when present, follows the address field and precedes the frame check sequence field. The default maximum size is 1600 octets.</p> <p>If the maximum frame relay information field is symmetrical (same size in the incoming and outgoing directions), octets 3c and 3d are not coded and the value in octets 3a and 3b is used for both directions.</p> <p><i>Throughput (octet group 4)</i></p> <p>The throughput (also known as CIR or Committed Information Rate) is the average number of bits of the frame relay information field transferred per second across a DTE/DCE interface in one direction. The throughput is measured over an interval of duration "T" known also as the Committed rate measurement interval (Tc).</p> <p>The throughput can be asymmetrical if the values in the incoming and outgoing directions differ. If the throughput is symmetrical, octets 4c and 4d are not coded and the value in octets 4a and 4b is used for both directions.</p> <p><i>Minimum acceptable throughput (octet group 5)</i></p> <p>The purpose of the minimum acceptable throughput is to negotiate the throughput of the call. Minimum acceptable throughput is the lowest throughput value the calling user is willing to accept for the call.</p> <p>This field which is present only in the SETUP message is carried unchanged through the network(s). Its value may not be greater than the requested throughput (octet group 4).</p> <p>The minimum acceptable throughput can be asymmetrical (the values in the incoming and outgoing directions differ). If the minimum acceptable throughput is symmetrical, octets 5c and 5d are not coded and the value in octets 4a and 4b is used for both directions.</p> <p>Throughput and minimum acceptable throughput are expressed as an order of magnitude (in powers of 10) and an integer multiplier. The multiplier shall be encoded as the smallest possible number. For example a throughput of 64 kbit/s shall be expressed as 64×10^3 and not 640×10^2.</p> <p><i>Magnitude (octets 4a, 4c, 5a and 5c)</i></p> <table><tr><td>Bits</td><td></td></tr><tr><td><u>7 6 5</u></td><td></td></tr><tr><td>0 0 0</td><td>10^0</td></tr><tr><td>0 0 1</td><td>10^1</td></tr><tr><td>0 1 0</td><td>10^2</td></tr><tr><td>0 1 1</td><td>10^3</td></tr><tr><td>1 0 0</td><td>10^4</td></tr><tr><td>1 0 1</td><td>10^5</td></tr><tr><td>1 1 0</td><td>10^6</td></tr></table> <p>All other values are reserved.</p>	Bits		<u>7 6 5</u>		0 0 0	10^0	0 0 1	10^1	0 1 0	10^2	0 1 1	10^3	1 0 0	10^4	1 0 1	10^5	1 1 0	10^6
Bits																		
<u>7 6 5</u>																		
0 0 0	10^0																	
0 0 1	10^1																	
0 1 0	10^2																	
0 1 1	10^3																	
1 0 0	10^4																	
1 0 1	10^5																	
1 1 0	10^6																	

Table 10-21/X.36 – Link layer core parameters information element

<p><i>Multiplier (octets 4a, 4b, 4c, 4d, 5a, 5b, 5c, and 5d)</i></p> <p>This field indicates in binary the value by which the magnitude shall be multiplied to obtain the throughput and the minimum acceptable throughput.</p> <p><i>Committed burst size (octet group 6)</i></p> <p>This field indicates the maximum amount of data (in bits) that the network agrees to transfer over the measurement interval T. This data may appear in one or more frames possibly with inter-frame idle flags.</p> <p>This field specifies a number of octets. Therefore the committed burst size is $8 \times$ the contents of this field. If the committed burst size is symmetrical, octets 6c and 6d are not coded and the value in octets 6a and 6b is used for both directions.</p> <p><i>Excess burst size (octet group 7)</i></p> <p>This field indicates the maximum amount of uncommitted data (in bits) that the network will attempt to deliver over the measurement interval T. This data may appear in one or more frames possibly with inter-frame idle flags. Excess burst may be marked Discard Eligible (DE) by the network.</p> <p>This field specifies a number of octets. Therefore the excess burst size is $8 \times$ the contents of this field. If the excess burst size is symmetrical, octets 7c and 7d are not coded and the value in octets 7a and 7b is used for both directions.</p> <p>NOTE – The same default values and range of values for the CIR, burst size, excess burst size, committed measurement interval and algorithms used for PVC should also be used in the case of SVC.</p> <p><i>Committed burst size magnitude (octets 8 and 8a)</i></p> <p>The Committed burst size magnitude field indicates the magnitude of the Committed burst size. It is expressed as a power of 10. It is multiplied by the Committed burst size value (octet group 6) to give the actual value of the Committed burst size. When the incoming committed burst size field is not included (in octet group 6), the incoming magnitude has no significance.</p> <p>The outgoing and incoming Bc magnitudes are coded as a power of 10 as follows:</p> <table border="0"> <tr> <td>Bits</td> <td></td> </tr> <tr> <td><u>3 2 1</u></td> <td></td> </tr> <tr> <td>0 0 0</td> <td>10^0</td> </tr> <tr> <td>0 0 1</td> <td>10^1</td> </tr> <tr> <td>0 1 0</td> <td>10^2</td> </tr> <tr> <td>0 1 1</td> <td>10^3</td> </tr> <tr> <td>1 0 0</td> <td>10^4</td> </tr> <tr> <td>1 0 1</td> <td>10^5</td> </tr> <tr> <td>1 1 0</td> <td>10^6</td> </tr> </table> <p>All other values are reserved.</p> <p>The values coded in octet 8a shall be the smallest values required to represent the outgoing and incoming committed burst sizes.</p> <p><i>Excess burst size magnitude (octets 9 and 9a)</i></p> <p>The Excess burst size magnitude field indicates the magnitude of the Excess burst size. It is expressed as a power of 10. It is multiplied by the Excess burst size value (octet group 7) to give the actual value of the Excess burst size. When the incoming Excess burst size field is not included (in octet group 7), the incoming magnitude has no significance.</p>	Bits		<u>3 2 1</u>		0 0 0	10^0	0 0 1	10^1	0 1 0	10^2	0 1 1	10^3	1 0 0	10^4	1 0 1	10^5	1 1 0	10^6
Bits																		
<u>3 2 1</u>																		
0 0 0	10^0																	
0 0 1	10^1																	
0 1 0	10^2																	
0 1 1	10^3																	
1 0 0	10^4																	
1 0 1	10^5																	
1 1 0	10^6																	

Table 10-21/X.36 – Link layer core parameters information element

The outgoing and incoming Be magnitudes are coded as a power of 10 as follows:

Bits	
<u>3</u> <u>2</u> <u>1</u>	
0 0 0	10 ⁰
0 0 1	10 ¹
0 1 0	10 ²
0 1 1	10 ³
1 0 0	10 ⁴
1 0 1	10 ⁵
1 1 0	10 ⁶

All other values are reserved.

The values coded in octet 9a shall be the smallest values required to represent the outgoing and incoming excess burst sizes.

10.6.16 Link layer protocol parameters

The purpose of the Link layer protocol parameters information element is to indicate requested layer 2 parameters values for the link layer elements of procedures to be used for the SVC. All parameters are optional and position independent. The default values defined in ITU-T Rec. Q.922 apply end-to-end. If any parameter is omitted from the information element, the default value specified for the end-to-end link layer protocol applies. The procedures associated with these parameters are used end-to-end between the two DTEs. The Link layer protocol parameters information element is coded as shown in Figure 10-18 and Table 10-22.

	8	7	6	5	4	3	2	1	Octet
	Link layer protocol parameters information element identifier								
	0	1	0	0	1	0	0	1	1
	Length of link layer protocol parameters contents								2
ext.	Transmit window size identifier								3*
0	0	0	0	0	1	1	1		
ext.	Transmit window value								3a*
1									
ext.	Retransmission timer identifier								4*
0	0	0	0	1	0	0	1		
ext.	Retransmission timer value								4a*
0									
ext.	Retransmission timer value (cont.)								4b*
1									
ext.	Mode of operation								5* (Note)
0	0	0	0	1	1	1	1		
ext.	Spare					Mode indication			5a*
1									

NOTE – Mode of operation is only included when the LLC octet 6 "user information layer 2 protocol" is coded with one of the code points: ITU-T X.25 link layer, ITU-T X.25 multilink, extended LAPB for half duplex operation (see ITU-T Rec. T.71) and ITU-T Rec. X.75 Single Link Procedures (SLP).

Figure 10-18/X.36 – Link layer protocol parameters information element

Table 10-22/X.36 – Link layer protocol parameters information element

<i>Transmit window value (octet 3a)</i>	
The value of the maximum number of outstanding transmit I-frames (window) is encoded as a binary value between 1 and 127.	
<i>Retransmission timer value (octets 4a, 4b)</i>	
The retransmission timer (e.g., LAPF T200) value is binary encoded in multiples of tenths of a second.	
<i>Mode indication (octet 5a)</i>	
Bits	
<u>2 1</u>	
0 1	Basic mode – Modulo 8 (NOTE – This mode is the default mode.)
1 0	Extended mode – Modulo 128
All other values are reserved.	

10.6.17 Low layer compatibility

The purpose of the Low layer compatibility information element is to provide a means which should be used for compatibility checking by an addressed entity (e.g., remote DTE or an interworking unit or a high layer function of a DCE node addressed by the calling DTE). The Low layer compatibility information element is transferred transparently by a frame relay network between the calling DTE and the addressed entity. The Low layer compatibility information element is coded as shown in Figure 10-19 and Table 10-23.

	8	7	6	5	4	3	2	1	Octet	
	0	Low layer compatibility information element identifier							1	
		1	1	1	1	1	0	0		
	Length of the low layer compatibility contents									
	2									
ext.	Coding Standard		Information transfer capability							3
1	0	0	0	1	0	0	0	0		
ext.	Transfer Mode		Reserved							4
1	0	1	0	0	0	0	0	0		
ext.	Layer 2 ident.		User info Layer 2 protocol							6 (Notes 1, 4)
0/1	1	0								
ext.	Reserved		SREJ use		Modulo		Address Inclusion		6a*	
1	0	0								
ext.	User specified									6a*
1										
ext.	Layer 3 ident.		User information layer 3 protocol							7*
0/1	1	1								
ext.	User specified layer 3 protocol information									7a*
1										
ext.	ITU-T Rec. X.263 ISO/IEC TR 9577 Initial Protocol Identifier (IPI)									7a*
0										
ext.	IPI		Spare							7b* (Note 2)
1			0	0	0	0	0	0		
ext.	SNAP ID		Spare							8* (Note 3)
1	0	0	0	0	0	0	0	0		
OUI Octet 1									8.1* (Note 3)	
OUI Octet 2									8.2* (Note 3)	
OUI Octet 3									8.3* (Note 3)	
PID Octet 1									8.4* (Note 3)	
PID Octet 2									8.5* (Note 3)	

NOTE 1 – Octet group 5 defined in ITU-T Rec. Q.933 is not used in ITU-T Rec. X.36.

NOTE 2 – These octet(s) may be present only if octet 7 indicates ITU-T Rec. X.263 | ISO/IEC TR 9577.

NOTE 3 – This octet group shall be present only if octet 7 indicates ITU-T Rec. X.263 | ISO/IEC TR 9577 and octets 7a and 7b indicate IEEE 802.1 SNAP.

NOTE 4 – Octet group 6 is omitted if no layer 2 protocol is used.

Figure 10-19/X.36 – Low layer compatibility information element

Table 10-23/X.36 – Low layer compatibility information element

<i>Information transfer capability (octet 3)</i>	
Bits	
<u>5 4 3 2 1</u>	
0 1 0 0 0	Unrestricted digital information
All other values are reserved.	
<i>User information layer 2 protocol (octet 6)</i>	
Bits	
<u>5 4 3 2 1</u>	
0 0 0 0 1	Basic ISO 1745
0 0 1 1 0	ITU-T X.25 link level (Note 1)
0 0 1 1 1	ITU-T X.25 multilink level (Note 2)
0 1 0 0 0	Extended LAPB for half duplex operation (ITU-T Rec. T.71) (Note 1)
0 1 0 0 1	HDLC ARM (ISO/IEC 4335) (Note 3)
0 1 0 1 0	HDLC NRM (ISO/IEC 4335) (Note 3)
0 1 0 1 1	HDLC ABM (ISO/IEC 4335) (Note 3)
0 1 1 0 0	LAN logical link control (ISO/IEC 8802-2) (Notes 4 and 5)
0 1 1 0 1	ITU-T X.75 Single Link Procedure (SLP) (Note 1)
0 1 1 1 0	ITU-T Rec. Q.922 (Note 6)
0 1 1 1 1	Core aspects of Annex A/Q.922 (Note 7)
1 0 0 0 0	User specified (Note 8)
1 0 0 0 1	ISO/IEC 7776 DTE to DTE operation (Note 1)
All other values are reserved.	
NOTE 1 – Normally the LAPB address is not provided. When provided, octet 6a will indicate that the address is present. When the LAPB address is provided, the calling DTE assumes address A (value 3) and the called DTE assumes address B (value 1).	
NOTE 2 – Normally the X.25 multilink address is not provided. When provided, octet 6a will indicate that the address is present. When the X.25 multilink address is provided, the calling DTE assumes address C (value 15) and the called DTE assumes address D (value 7).	
NOTE 3 – Normally the HDLC address is not provided. When provided, octet 6a will indicate that the address is present.	
NOTE 4 – Destination Service Access Point (DSAP) and Source Service Access Point (SSAP) are included. When a logical link control frame (which contains a logical link control PDU) is required (transparent inter-connection of similar LANs by frame relay), octet 6a will indicate that the logical link control frame is encapsulated. The contents of a logical link control frame is defined in the LAN Media Access Control (MAC) standards (e.g., ISO/IEC 8802-5).	
NOTE 5 – The indication of command or response bit in the frame relay address will be ignored.	
NOTE 6 – Address is not encapsulated.	
NOTE 7 – This code point is not used in ITU-T Rec. X.36.	
NOTE 8 – When this coding is included, octet 6a will include the code point for user specified layer 2 protocol.	
<i>Octet 6a coding for user specified code point</i>	
User information layer 2 protocol (octet 6a) (applies for layer 2 = User specified) – User specified.	

Table 10-23/X.36 – Low layer compatibility information element

Octet 6a coding for Address inclusion

User information layer 2 protocol (octet 6a) (Note 9)

Bits

2 1

0 1 Address included (Note 10)

1 0 Encapsulation of logical control frame (Note 11)

All other values are reserved.

NOTE 9 – When the octet is present, the indication of C/R bit in the frame relay core aspects address will be ignored.

NOTE 10 – Applies for the following layer 2 protocols specified in octet 6: ITU-T X.25 link layer, ITU-T X.25 multilink, extended LAPB for half duplex operation (see ITU-T Rec. T.71) HDLC ARM, HDLC NRM, HDLC ABM and ITU-T X.75 Single Link Procedures (SLP).

NOTE 11 – Applies for the following layer 2 protocol specified in octet 6: LAN logical link control (ISO/IEC 8802-2).

Bits

4 3

0 0 Modulo 8

0 1 Modulo 128

1 0 Modulo 32 768

1 1 Modulo 2147483648

Bits

5

0 SREJ not used

1 SREJ used

User information layer 3 protocol (octet 7)

Bits

5 4 3 2 1

0 0 1 1 0 ITU-T X.25 packet level

0 0 1 1 1 ISO/IEC 8208 (X.25 packet level protocol for DTE)

0 1 0 0 0 ITU-T Rec. X.223 or ISO/IEC 8878 (use of ISO/IEC 8208 and X.25 to provide the OSI-CONS)

0 1 0 0 1 ISO/IEC 8473 (OSI connectionless mode protocol)

0 1 0 1 0 ITU-T T.70 minimum network layer

0 1 0 1 1 ITU-T Rec. X.263 | ISO/IEC TR 9577 (Protocol identification in the network layer)

1 0 0 0 0 User specified (Note 12)

1 1 0 0 0 The use of this code point is specified by the Frame Relay Forum (Note 12).

NOTE 12 – When this coding is included, octet 7a will include the code point for user or Frame Relay Forum specified layer protocol.

NOTE 13 – If extension octets (7a-7b) are not included, more than one protocol may be encapsulated over the SVC using the ITU-T Rec. X.263 | ISO/IEC TR 9577 format as described in Annex D/X.36.

If extension octets are present one protocol is carried on the SVC. The ITU-T Rec. X.263 | ISO/IEC TR 9577 Initial Protocol Identifier (IPI) as well as the subsequent protocol identification octets are not carried in the user plane

User specified layer 3 protocol information (octet 7a)

When the "user information layer 3 protocol" field of octet 7 is coded as "user specified" (10000), the "user specified layer 3 protocol information" field of octet 7a is defined by the user and not by this Recommendation.

Table 10-23/X.36 – Low layer compatibility information element

ITU-T Rec. X.263 | ISO/IEC TR 9577 Initial Protocol identifier (octet 7a)

Octet 7a and bit 8 of octet 7b indicate the ITU-T Rec. X.263 | ISO/IEC TR 9577 Initial Protocol Identifier (IPI) for the protocol to be carried in the user plane. If octets 7a and 7b are coded as '1000 0000', indicating an IEEE 802.1 SNAP identifier (see Annex D of ITU-T Rec. X.263 | ISO/IEC TR 9577), octets 8.1-8.5 will contain a 40-bit SNAP identifier, consisting of a 24-bit organization unique identifier (OUI) and a 16-bit protocol identifier (PID). The NLPID coding shall only be used if there is no ITU-T standardized coding for the layer 3 protocol being used, and an ITU-T Rec. X.263 | ISO/IEC TR 9577 or SNAP coding applies for that protocol. The SNAP coding shall be used for a layer 3 protocol only if ISO has not assigned an NLPID for the layer 3 protocol. The SNAP coding can also be used to indicate that bridged LAN frames are to be carried in the user plane.

10.6.18 Priority and service class parameters information element

The purpose of the Priority and service class parameters information element is to select and identify the frame transfer priority indices of a switched virtual circuit. A different frame transfer priority may be assigned to each data transmission direction. The priority and service class parameters information element is shown in Figure 10-20 and in Table 10-24.

8	7	6	5	4	3	2	1	Octet
Priority and service class parameters information element identifier								1
0	1	1	0	1	0	1	0	
Length of Priority and service classes parameters contents								2
Frame transfer priority identifier								3*
0	0	0	0	0	0	0	1	
Outgoing transfer priority index				Incoming transfer priority index				3.1*
Frame discard priority identifier								4*
0	0	0	0	0	0	1	0	
Outgoing discard priority index				Incoming discard priority index				4.1*
Service class								5*
0	0	0	0	0	0	1	1	
Service class value								5.1*

Figure 10-20/X.36 – Priority and service class parameters information element

Table 10-24/X.36 – Priority and service class parameters information element

<p><i>Outgoing transfer priority index (octet 3.1 bits 5-8) (Notes 1, 2)</i></p> <p>A binary number in the range of 0 to 15 indicating the Frame transfer priority index for the outgoing direction. 0 denotes the lowest priority and 15 the highest.</p> <p><i>Incoming requested transfer priority (octet 3.1 bits 1-4) (Notes 1, 2)</i></p> <p>A binary number in the range of 0 to 15 indicating the Frame transfer priority index for the incoming direction. 0 denotes the lowest priority and 15 the highest.</p> <p>NOTE 1 – A Frame transfer priority index has a local significance.</p> <p>NOTE 2 – The term <i>outgoing</i> refers to the calling to called DTE direction and the term <i>incoming</i> refers to the direction from the called to calling DTE.</p> <p><i>Outgoing Frame Discard Priority index (octet 4.1 bits 5-8) (Notes 3, 4)</i></p> <p>A binary number in the range of 0 to 7 indicating the Frame Discard Priority index in the outgoing direction. 0 denotes the lowest priority (first to be discarded) and 7 the highest. Other values (8 to 15) are reserved.</p> <p><i>Incoming Frame Discard Priority (octet 4.1 bits 1-4) (Notes 3, 4)</i></p> <p>A binary number in the range of 0 to 7 indicating the Frame Discard Priority index in the incoming direction. 0 denotes the lowest priority (first to be discarded) and 7 the highest. Other values (8 to 15) are reserved.</p> <p>NOTE 3 – A frame discard priority index has a local significance.</p> <p>NOTE 4 – The term <i>outgoing</i> refers to the calling to called DTE direction and the term <i>incoming</i> refers to the direction from the called to calling DTE.</p> <p><i>Service class value (octet 5.1)</i></p> <p>A binary number in the range of 0 to 3 indicating the specified Service Class. Other values are reserved. Service classes and their associated quality of service characteristics are standardized – see Table 7-1/X.36 and ITU-T Rec. X.146.</p>

10.6.19 Reverse charging indication

The purpose of the reverse charging indication information element is to indicate that reverse charging has been requested for that frame relay SVC. The reverse charging indication is coded as shown in Figure 10-21 and Table 10-25.

8	7	6	5	4	3	2	1	Octet
Reverse charging indication information element identifier								
0	1	0	0	1	0	1	0	1
Length of reverse charging indication contents								
0	0	0	0	0	0	0	1	2
ext. 1	Spare			Reverse charging indication				3
	0	0	0	0				

Figure 10-21/X.36 – Reverse charging indication information element

Table 10-25/X.36 – Reverse charging indication information element

<p><i>Reverse charging indication (octet 3)</i></p> <p>Bits</p> <p><u>3 2 1</u></p> <p>0 0 1 Reverse charging requested</p> <p>All other values are reserved.</p>
--

10.6.20 Transit network selection

The purpose of the Transit network selection information element is to identify one requested transit network. The Transit network selection information element is coded as shown in Figure 10-22 and Table 10-26.

8	7	6	5	4	3	2	1	Octet
Transit network selection information element identifier								
0	1	1	1	1	0	0	0	1
Length of transit network selection contents								2
ext. 1	Type of network identification			Network identification plan				3
ext. 0	Network identification (coded according to ITU-T Rec. T.50)							4 etc.

Figure 10-22/X.36 – Transit network selection information element

Table 10-26/X.36 – Transit network selection information element

<i>Type of network identification (octet 3)</i>	
Bits	
<u>7 6 5</u>	
0 1 1	International network identification
All other values are reserved.	
<i>Network identification plan (octet 3)</i>	
Bits	
<u>4 3 2 1</u>	
0 0 0 0	Unknown (Note 1)
0 0 0 1	Carrier identification code (Note 2)
0 0 1 1	Data network identification code (ITU-T Rec. X.121)
All other values are reserved.	
NOTE 1 – Not used in ITU-T Rec. X.36. This code point is for use in private networks.	
NOTE 2 – This code point is used to identify public frame relay networks numbered under the E.164 numbering plan (see Appendix V and ITU-T Rec. X.125). The network identification consists of an E.164 Country Code followed by a network identifier number. The maximum length is 8 octets (digits).	
<i>Network identification (octet 4)</i>	
These characters coded according to ITU-T Rec. T.50 are organized according to the network identification plan specified in octet 3.	

10.6.21 User-user

The purpose of the user-user information element is to convey information between the users. This information is not interpreted by the network but carried transparently and delivered to the recipient. The user-user information element is coded as shown in Figure 10-23. The network needs only to understand the first 2 octets. The maximum length of the user-user information element is 131.

8	7	6	5	4	3	2	1	Octet
User-user information element identifier								1
0	1	1	1	1	1	1	0	
Length of user-user contents								2
Protocol discriminator (Note)								3
User information								4 etc.

NOTE – See coding in ITU-T Rec. Q.931.

Figure 10-23/X.36 – User-to-user information element

10.7 Call establishment and clearing procedures

10.7.1 Call establishment at the calling DTE/DCE interface

10.7.1.1 Actions by the DTE

Switched virtual circuit set-up: A DTE initiates the establishment of a Switched Virtual Circuit (SVC) by transferring a SETUP message across the DTE/DCE interface on DLCI = 0. Following the transmission of the SETUP message, the SVC shall be considered by the DTE in the call initiated state (U1).

The DTE shall not include in the SETUP message the Data Link Connection Identifier information element. The network shall select one and include it in the first reply message to the call SETUP.

After sending the SETUP message, the DTE shall start timer T303, enter state U1 (Call initiated) and wait for the DCE reply. At the first expiry of timer T303, the DTE shall retransmit the SETUP message. At the second expiry of timer T303, the DTE shall clear the SVC by following the clearing procedures before reaching the active state with cause No. 102 *Recovery on timer expiry* and return to the null state U0.

Call proceeding: At the receipt of the CALL PROCEEDING message, the DTE shall stop timer T303, start timer T310 and enter state U3 (Outgoing call proceeding). At the expiry of timer T310, the SVC shall be cleared by following the clearing procedures before reaching the active state with cause No. 102 *Recovery on timer expiry*.

Call connected: Upon receiving a CONNECT message from the network indicating that the called party has accepted the call, the calling DTE shall stop timer T310 and enter the call active state U10. The SVC is now established and data transfer can begin.

In the CONNECT message received from the network, the link layer core parameters information element indicates the final Quality of Service parameters to be used. Based on the content of the received CONNECT message, the calling DTE may reject the call by using clearing procedure in the active state with appropriate cause value.

10.7.1.2 Actions by the DCE

Call proceeding: At the receipt of the SETUP message, the DCE shall enter state N1 (Call initiated). If the DCE determines that the DTE set-up request is not authorized or cannot be supported, it shall clear the SVC by following the clearing procedures before reaching the active state. Otherwise, the DCE shall send a CALL PROCEEDING message to the DTE to acknowledge the SETUP message and to indicate that the SVC is being processed and shall enter call state N3 (Outgoing call proceeding).

Calling party number screening and presentation: The screening and presentation indicators of the calling party number information element shall be transmitted to the remote DTE and the presentation indicator (octet 3a bits 6 and 7) shall be coded *Presentation allowed*.

The network at the calling DTE/DCE interface shall perform the screening of the calling party number as follows:

- 1) When the calling DTE provides its address or a complementary address in the Calling party number information element, the DCE can only verify that the address is allocated to that DTE. If the screening is successful, the screening indicator (octet 3a bits 1 and 2) shall be coded *User provided verified and passed*.
- 2) If the calling DTE does not provide its address or provides one that the DCE considers invalid, the screening is not successful. In this case, the DCE shall provide a default address assigned to the calling DTE and the screening indicator shall be coded *Network provided*.

In any case, the calling DTE address transmitted to the called DTE will be a valid complete address.

If octet 3a is provided by the calling user, it shall be ignored by the DCE at the originating interface. The network shall encode the screening and presentation indicators of the calling party number as described above.

Call connected: Upon receiving an indication that the called DTE has accepted the switched virtual circuit set-up request, the DCE shall send a CONNECT message to the calling DTE and enter the call active state N10. The CONNECT message sent to the calling DTE shall include the link layer core parameters to indicate the final traffic parameters of the switched virtual circuit.

Call rejection: Upon receiving an indication from the called DTE that the switched virtual connection set-up request cannot be accepted, the originating DCE shall initiate clearing at the originating DTE/DCE interface according to the clearing procedure before reaching the active state.

10.7.1.3 Link layer core parameters negotiation

If the calling DTE does not supply some or all of the traffic parameters, the network will use default values for:

- outgoing and incoming throughputs (CIR);
- outgoing and incoming minimum throughputs;
- outgoing and incoming committed burst sizes;
- outgoing and incoming excess burst sizes.

NOTE – The default values for the incoming link layer core parameters can be the same as the default values for the outgoing parameters.

After examining the traffic parameters, if supplied by the DTE, or the default ones for the parameters not supplied by the calling DTE, the DCE can take one of the following actions:

- If it is able to provide the requested Quality of Service and able to support the indicated link layer core parameter values, the DCE will progress the switched virtual circuit set-up request to the remote DTE with the original parameters.
- If unable to provide the requested traffic parameters but able to provide at least the lowest acceptable parameters, the DCE will progress the switched virtual circuit set-up request to the remote DCE after adjusting the appropriate parameters. The adjusted parameters will support at least the lowest acceptable values.

When progressing the set-up of the switched virtual circuit set-up, a network, if necessary, may reduce further the requested traffic parameters but not below the lowest acceptable values. If unable to support the lowest acceptable values, the network will clear the switched virtual circuit with the calling DTE.

- If unable to provide at least the lowest acceptable traffic parameters, the network will reject the SVC set-up request with cause No. 49 *Quality of service not available* by following the clearing procedure before reaching the active state.

10.7.1.4 DLCI allocation

The calling DTE shall not include the Data link connection identifier information element in the SETUP message. It is the responsibility of the network to allocate the DLCI at the calling DTE/DCE interface. As a result of processing the SETUP message received from the calling DTE, the network will allocate an available DLCI and will return it in the data link Connection identifier information element of the CALL PROCEEDING message sent in response to the SETUP message of the calling DTE.

If no DLCI is available at the calling DTE/DCE interface or the maximum number of SVC is reached, the network rejects the SVC establishment request with cause No. 34 *No circuit/channel available* by following the clearing procedure before reaching the active state.

10.7.2 Call establishment at the called DTE/DCE interface

10.7.2.1 Actions by the DCE

The DCE shall indicate the arrival of a switched virtual circuit set-up request at the destination DTE/DCE interface by transferring a SETUP message across the interface. The SETUP message shall contain the DLCI with the Pref./Excl. field set to *Exclusive* and appropriate information elements to help the called DTE determines whether to accept or not the call.

The DCE shall present the calling party number by including the calling number information element in the SETUP message. Octet 3a of the calling party number information element shall be coded according to the information provided by the DCE at the originating interface.

The link layer core parameters information element shall reflect any reduction performed by the network while progressing the switched virtual circuit set-up request. If the network did not change the traffic parameters while progressing the switched virtual circuit set-up request to the called DTE, the value supplied by the calling DTE, or the default value supplied by the DCE at the originating DTE/DCE interface, shall be transmitted to the called DTE.

The SETUP message shall include any end-to-end information element supplied by the calling DTE at the originating interface. After sending the SETUP message, the DCE shall start timer T303 and enter state N6 (Call present). If no response to the SETUP is received from the called DTE before the first expiration of timer T303, the SETUP message shall be retransmitted and timer T303 restarted. At the second expiry, the DCE at the originating DTE/DCE interface shall perform the normal clearing procedure with the calling DTE and shall indicate cause No. 18 *No user responding*. The DCE at the destination DTE/DCE interface shall perform the clearing procedure with the called DTE by following the clearing procedure before reaching the active state with cause No. 102 *Recovery on timer expiry* and return to the null state N0.

Call proceeding: At the receipt of a CALL PROCEEDING message from the called DTE, the DCE shall stop timer T303, and start timer T310 and enter call state N9 (Incoming call proceeding). At the expiry of timer T310, the switched virtual circuit shall be cleared with the calling and called DTE according to the clearing procedure before reaching the active state.

NOTE – Sending a CALL PROCEEDING by the called DTE to the DCE is not mandatory. It is allowed for the called DTE to reply to the SETUP message with a CONNECT message.

Call connected: Upon receiving a CONNECT message indicating that the called DTE has accepted the call, the DCE shall stop timer T310 (or timer T303, if T310 is not running and T303 is) and enter the call active state N10.

Connected number screening and presentation: If the called DTE provides a connected number information element in the CONNECT message, the screening and presentation indicators of the connected number information element will be transmitted to the originating interface and the presentation indicator (octet 3a bits 6 and 7) shall be coded *Presentation allowed*.

The DCE at the called DTE/DCE interface shall perform the screening of the connected number as follows:

- 1) When the called DTE provides an address or a complementary address in the Connected number information element, the DCE can only verify that the address is allocated to that DTE. If the screening is successful, the screening indicator (octet 3a bits 1 and 2) shall be coded *User provided verified and passed*.
- 2) If the called DTE provides an address or a complementary address in the Connected number information element that the DCE considers invalid, the screening is not successful. In this case, the DCE shall provide a default address assigned to the called DTE in the connected number information element and the screening indicator shall be coded *Network provided*.

In any case, the connected number transmitted to the calling DTE will be a valid and complete address.

If octet 3a of the Connected number information element is provided by the called DTE, it shall be ignored by the DCE. The network shall encode the screening and presentation indicators of the connected number as described above.

10.7.2.2 Actions by the called DTE

After receiving the SETUP message from the DCE, the called DTE shall enter call state U6 (call present) and respond with the following sequence of messages:

- A CALL PROCEEDING to acknowledge the receipt of the SETUP message and enter state U9 (Incoming call proceeding). In the CALL PROCEEDING message, the DTE shall include the DLCI value provided by the network in the SETUP message and code the *Excl./Pref.* field as *exclusive*.
NOTE – Sending a CALL PROCEEDING message by the DTE is optional. The called DTE can also reply with a CONNECT message to the SETUP message sent by the DCE.
- A CONNECT message to notify the DCE of the acceptance of the switched virtual circuit set-up request and enter the Active state U10. In the CONNECT message, the DTE shall include the DLCI value provided by the DCE in the SETUP message and code the *Excl./Pref.* field as *exclusive* if the CONNECT message is the first response to the SETUP message.

If the called DTE wishes to refuse the switched virtual circuit set-up request, it shall initiate call clearing at the called DTE/DCE interface, with cause No. 21 *Call rejected*, according to the clearing procedure before reaching the active state, release the call reference and the DLCI and return to the null state U0.

In the SETUP message, the DCE will have included the DLCI value to use with the switched virtual circuit. If this DLCI value is unacceptable to the called DTE, the switched virtual circuit may be cleared according to the clearing procedure before reaching the active state of 10.7.4.1.

Call accepted: A called DTE indicates acceptance of an incoming switched virtual circuit set-up request by sending a CONNECT message to the DCE. The CONNECT message shall contain the link layer core parameters information element acceptable to the called DTE.

10.7.2.3 Link layer core parameters negotiation

At the called DTE/DCE interface, the DCE will examine the traffic parameters received. If it is unable to provide at least the lowest acceptable traffic parameters, the network will clear the switched virtual circuit set-up request towards the calling DTE with cause No. 49 *Quality of Service not available*, by following the clearing procedure before reaching the active state.

Otherwise the DCE shall include in the Link layer core parameters information element of the SETUP message to be sent to the called DTE values, not below the lowest acceptable parameter values, for the following parameters:

- maximum frame mode information field;
- throughput that may be smaller or equal to the one requested by the calling DTE but always greater or equal to minimum acceptable throughput;
- minimum acceptable throughput as requested by the calling DTE;
- committed burst size that may be smaller or equal to the one requested by the calling DTE;
- excess burst size that may be smaller or equal to the one requested by the calling DTE.

After examining the link layer core parameters information element supplied by the DCE, the called DTE can take one of the following actions:

- If the requested traffic parameters are acceptable, the called DTE shall include them in the CONNECT message returned to the DCE.
- If the requested traffic parameters are not acceptable, but the called DTE can support lowest acceptable parameters (in particular the minimum throughput), the reduced values shall be included in the CONNECT message returned to the DTE.
- If the called DTE is unable to support even the lowest possible traffic parameters, the called DTE will reject the switched virtual circuit set-up request with cause No. 49 *Quality of Service not available*, by following the clearing procedure before reaching the active state.

10.7.2.4 DLCI allocation

At the called DTE/DCE interface, it is the responsibility of the network to allocate the DLCI. The network indicates to the called DTE the allocated DLCI in the data link connection identifier information element included in the SETUP message sent to the called DTE.

If no DLCI is available at the called DTE/DCE interface or the maximum number of SVC is reached, the network clears the switched virtual circuit in the backward direction with cause No. 34 *No circuit/channel available*, by following the clearing procedure before reaching the active state.

In its reply to the SETUP message received from the DCE, the called DTE shall include the received DLCI value in the data link connection identifier information element in the first message (CALL PROCEEDING or CONNECT message). In case the called DTE does not follow this procedure, the network clears the SVC with the called DTE and calling DTE by following the clearing procedure before reaching the active state with one of the following cause values:

- No. 96 *Mandatory information element is missing* if the Data link connection identifier information element is absent;
- No. 100 *Invalid information element contents* if the DLCI value encoded in the data link connection identifier differs from the value allocated by the network.

10.7.3 Frame relay data transfer phase

Upon establishing the SVC, the frame relay data transfer phase procedures, as described in clause 9, are followed. Since signalling messages and FR frames do not follow the same path at least at the DTE/DCE interfaces, it is possible that the called DTE starts transmitting FR frames on a SVC before the corresponding CONNECT message is received by the calling DTE. Some FR frames may not be delivered for this reason.

After the clearing of a SVC has been initiated by a DTE or a DCE, the data frames in transit in both directions may be lost and not delivered to their destination.

10.7.4 Call clearing

Three clearing cases are identified:

- clearing in the active state which is initiated by sending a DISCONNECT message;
- clearing when an entity is not in the null state but has not reached the active state, initiated by sending a RELEASE message;
- clearing in the null state which is initiated by sending a RELEASE COMPLETE message.

10.7.4.1 Clearing in the active state

10.7.4.1.1 Clearing in the active state initiated by the DTE

Actions by the DTE: The DTE shall initiate switched virtual circuit clearing by disconnecting the DLCI, informing the DL-core sublayer entity of the initiation of switched virtual circuit clearing, sending a DISCONNECT message, starting timer T305 and entering the Disconnect request state (U11).

On receipt of the RELEASE message, the DTE shall stop timer T305, send a RELEASE COMPLETE message, release the call reference and the DLCI and return to the Null state (U0).

If timer T305 expires, the DTE shall send a RELEASE message to the DCE with the cause number originally contained in the DISCONNECT message, start timer T308 and enter the release request state (U19). The DTE may indicate a second cause information element with cause No. 102 *Recovery on timer expiry*.

If timer T308 expires, the DTE shall resend the RELEASE message, restart timer T308 and stay in the release request state (U19). In the RELEASE message, the DTE may include a second cause information element with cause No. 102 *Recovery on timer expiry*. If timer T308 expires for a second time, the DTE shall release the call reference and the DLCI and return to the Null state (U0).

Actions by the DCE: On the receipt of the DISCONNECT message, the DCE shall enter the Disconnect request state (N11), disconnect the DLCI, inform the U-plane DL-core sublayer entity of the initiation of switched virtual circuit clearing, send a RELEASE message to the DTE, start timer T308 and enter the Release request state (N19).

Following the receipt of the RELEASE COMPLETE message from the DTE, the DCE shall stop timer T308, release the call reference and the DLCI and return to the Null state (N0).

If timer T308 expires, the DCE shall resend the RELEASE message and restart timer T308. In addition, the DCE may indicate a second cause information element with cause No. 102 *Recovery on timer expiry*. If timer T308 expires for a second time, the DCE shall release the call reference and the DLCI and return to the Null state (N0).

10.7.4.1.2 Clearing in the active state initiated by the DCE

Actions by the DCE: The DCE shall initiate clearing by disconnecting the DLCI, sending a DISCONNECT, starting timer T305 and entering the Disconnect indication state (N12).

On receipt of the RELEASE message from the DTE, the DCE shall stop timer T305, send a RELEASE COMPLETE message, release the call reference and the DLCI and return to the Null state (N0).

If timer T305 expires, the DCE shall send a RELEASE message to the DTE with the cause number originally contained in the DISCONNECT message, start timer T308 and enter the release request state (N19). The DCE may indicate a second cause information element with cause No. 102 *Recovery on timer expiry*.

If timer T308 expires, the DCE shall resend the RELEASE message, restart timer T308 and stay in the release request state (N19). In the RELEASE message, the DCE may include a second cause information element with cause No. 102 *Recovery on timer expiry*. If timer T308 expires for a second time, the DCE shall release the call reference and the DLCI and return to the Null state (N0).

Actions by the DTE: On the receipt of the DISCONNECT message, the DTE shall enter the Disconnect indication state (U12), disconnect the DLCI, inform the U-plane DL-core sublayer entity of the initiation of switched virtual circuit clearing, send a RELEASE message to the DCE, start timer T308 and enter the Release request state (U19).

Following the receipt of the RELEASE COMPLETE message from the DCE, the DTE shall stop timer T308, release the call reference and the DLCI and return to the Null state (U0).

If timer T308 expires, the DTE shall resend the RELEASE message and restart timer T308. In addition, the DTE may indicate a second cause information element with cause No. 102 *Recovery on timer expiry*. If timer T308 expires for a second time, the DTE shall release the call reference and the DLCI and return to the Null state (U0).

10.7.4.2 Clearing before reaching the active state

Before reaching the active state, the clearing procedure is initiated by the DTE or the DCE by sending a RELEASE message except when the entity is in the null state (U0 or N0).

When an entity is in the null state, the clearing procedure is initiated with the RELEASE COMPLETE message. After sending or receiving a RELEASE COMPLETE message, the sending or receiving entity will remain in the null state.

10.7.4.2.1 Clearing initiated by the DTE

When a DTE initiates switched virtual circuit clearing by sending a RELEASE message, the following procedure applies: the DTE shall disconnect the DLCI, send a RELEASE message to the DCE, start timer T308 and enter the Release request state (U19).

Following the receipt of the RELEASE COMPLETE message from the DCE, the DTE shall stop timer T308, release the call reference and the DLCI and return to the Null state (U0).

If timer T308 expires, the DTE shall resend the RELEASE message, restart timer T308 and stay in the release request state (U19). In the RELEASE message, the DTE may indicate a second cause information element with cause No. 102 *Recovery on timer expiry*. If timer T308 expires for a second time, the DTE shall release the call reference and the DLCI and return to the Null state (U0).

10.7.4.2.2 Clearing initiated by the DCE

When the DCE initiates switched virtual circuit clearing by sending a RELEASE message, the following procedure applies: the DCE shall disconnect the DLCI, inform the U-plane DL-core sublayer entity of the initiation of switched virtual circuit clearing, send a RELEASE message to the DTE, start timer T308 and enter the Release request state (N19).

Following the receipt of the RELEASE COMPLETE message from the DTE, the DCE shall stop timer T308, release the call reference and the DLCI and return to the Null state (N0).

If timer T308 expires, the DCE shall resend the RELEASE message, restart timer T308 and stay in the release request state (N19). In the RELEASE message, the DCE may indicate a second cause information element with cause No. 102 *Recovery on timer expiry*. If timer T308 expires for a second time, the DCE shall release the call reference and the DLCI and return to the Null state (N0).

10.7.4.3 Clearing collision

A clearing collision happens when the DTE or the DCE after sending a DISCONNECT message receives a DISCONNECT message with the same call reference value. A clearing collision happens in state U11 (Disconnect request) or N12 (Disconnect indication). When a clearing collision is detected, the DCE and the DTE shall stop the running timer T305, send a RELEASE message, start timer T308 and enter the release request states (U19 and N19) and follow the rest of the clearing procedures.

A clearing collision can also occur when both sides of a DTE/DCE interface simultaneously transfer a RELEASE message related to the same call reference value. This clear collision type occurs when both sides are in the Release request states (U19 and N19). When this type of clearing collision occurs, the entity receiving a RELEASE message while in the Release request state, shall stop timer T308, release the call reference and the DLCI and return to the Null state (U0 or N0) without sending a RELEASE COMPLETE message.

10.8 Status enquiry and status procedures

10.8.1 Status enquiry procedure

Whenever an entity (DTE or DCE) wishes to check the correctness of a call state at the peer entity, a STATUS ENQUIRY message may be sent. Upon sending the STATUS ENQUIRY message, timer T322 shall be started in anticipation of receiving a STATUS message. While timer T322 is running, only one outstanding request for call state information shall exist per call reference. If switched virtual circuit clearing is received while timer T322 is running, it shall be stopped and clearing shall continue.

Upon receipt of a STATUS ENQUIRY message, the receiver shall respond with a STATUS message, reporting the current call state and cause No. 30 *Response to STATUS ENQUIRY*. Sending or receiving a STATUS message does not result in a state change.

The side having received the STATUS message shall inspect the cause information element. If it is not cause No. 30 *Response to STATUS ENQUIRY*, timer T322 shall continue to time for an explicit response to the STATUS ENQUIRY message. If a STATUS message is received with the cause No. 30, timer T322 shall be stopped and the appropriate action taken based on the information in that STATUS message about the call state of the sender and the current call state of the receiver.

If timer T322 expires and a STATUS was received with another cause value than No. 30, appropriate actions based on the cause received and the call state of the sender shall be taken.

If timer T322 expires and no STATUS was received, the STATUS ENQUIRY message may be retransmitted one or more times until a response is received. The number of times a STATUS ENQUIRY is retransmitted is an implementation dependent value.

The switched virtual circuit shall be cleared with cause No. 41 *Temporary failure*, if the STATUS ENQUIRY message is retransmitted the maximum number of times.

10.8.2 Receiving a STATUS message

On receipt of a STATUS message reporting an incompatible state, the receiving entity shall:

- clear the call by sending the appropriate clearing message with cause No. 101 *Message not compatible with call state*; or
- take other actions which attempt to recover from a mismatch and which are an implementation option.

Except for the following rules, the determination of which states are incompatible is left as an implementation decision:

- if the receiver is in the Null state and the STATUS message indicates the Null state, then no action shall be taken by the receiver other than discarding the message and staying in the Null state;
- if the receiver is in any state except the Null state and the STATUS message indicates the Null state, then the receiver shall release all resources, the DLCI and the call reference and move to the Null state;
- if the receiver is in the Release request state (U19 or N19) and the STATUS message indicates any state except the Null state, then no action shall be taken;
- if the receiver is in the Null state and the STATUS message indicates any state except the Null state, then the receiver shall send:
 - a RELEASE COMPLETE message with cause No. 101 *Message not compatible with call state* and remain in the Null State.

If a STATUS message is received in a compatible state but contains one of the following causes:

- No. 96 *Mandatory information element is missing;*
- No. 97 *Message type non-existent or not implemented;*
- No. 99 *Information element parameter non-existent or not implemented;*
- No. 100 *Invalid information element contents,*

the actions to be taken are an implementation option. If no other procedure is defined, the receiver shall clear the call with the appropriate procedure defined in 10.6.4 using the cause value specified in the received STATUS message.

10.8.3 Receipt of the STATUS message with the global call reference

On receipt of a STATUS message with the Global call reference, no action shall be taken on the STATUS message. On receipt of any other message with the Global call reference than the STATUS message, a STATUS message with cause No. 81 *Invalid call reference value* is returned; the call reference information element is coded with the global call reference and the call state is coded as REST0.

10.9 Restart procedure

The restart procedure is used by a DTE or DCE to return a frame relay DTE/DCE interface to an idle or null state. The restart procedure is used by a DTE or DCE to recover from internal failure, after power-up or after internal re-initialization. The restart procedure affects only the switched virtual circuits and has no effect on the permanent virtual circuit. A result of the execution of the restart procedure, the switched virtual circuits will be cleared and will return to the null state.

10.9.1 Sending a RESTART message

A RESTART message is sent by a DTE or a DCE across the DTE/DCE interface in order to return the whole interface to the Null or idle state. Upon transmitting the RESTART message, the sender enters the Restart Request state, starts timer T316 and waits for the RESTART ACKNOWLEDGE message. Also, no further RESTART messages shall be sent until a RESTART ACKNOWLEDGE message is received or timer T316 expires. Receipt of a RESTART ACKNOWLEDGE message stops timer T316, frees the DLCI and call reference values for reuse, and causes the receiver to enter the Null state for each switched virtual circuit restarted.

If a RESTART ACKNOWLEDGE message is not received prior to the expiry of timer T316, one or more subsequent RESTART messages may be sent until a RESTART ACKNOWLEDGE message is returned. Meanwhile, no calls shall be placed or accepted over the interface. The number of

unsuccessful restart attempts is limited to a default value of two. When this limit is reached, the originator of the restart attempt shall record an error, take appropriate actions and consider that the interface is available for new calls.

The RESTART and RESTART ACKNOWLEDGE messages shall contain the global call reference value. The call reference flag of the global call reference applies to restart procedures. In the case where both sides of the DTE/DCE initiate simultaneously restart requests, they shall be handled independently, the DTE/DCE interface shall not be considered for reuse until all the relevant restart procedures are completed.

10.9.2 Receipt of a RESTART message

Upon receiving a RESTART message, the recipient shall enter the Restart state associated to the global call reference and start timer T317; it shall then initiate the appropriate internal actions to clear all calls on the interface and to return the interface to the idle state. Upon completion of internal clearing, timer T317 shall be stopped and a RESTART ACKNOWLEDGE message transmitted to the originator, and the Null state entered. If timer T317 expires prior to completion of internal clearing, an indication shall be sent to the maintenance entity.

Even if all call references are in the Null state and all data link connections are in the idle condition, the receiving entity shall transmit a RESTART ACKNOWLEDGE message to the originator upon receiving a RESTART message.

10.10 Handling of error conditions

Detailed error handling procedures are implementation dependent. This clause provides general rules required by each implementation to facilitate the orderly treatment of error conditions. The general rules do not take precedence over applicable procedures as specified in other clauses of this Recommendation. Order of precedence among the rules are defined by the order of description of this clause.

The following error types are covered in this clause:

- protocol discriminator error;
- message too short;
- call reference error;
- message type or message sequence errors;
- general information element errors;
- mandatory information element errors;
- non-mandatory information element errors;
- data link reset and data link failure.

10.10.1 Protocol discriminator error

When a message is received with a protocol discriminator coded other than *Q.931 user-network call control message* (0000 1000), the message shall be ignored (discarded) and no further action will be taken.

10.10.2 Message too short

When a message is received that is too short to contain a complete message type information element, that message shall be ignored.

10.10.3 Call reference error

10.10.3.1 Invalid call reference format

- 1) If the call reference information element octet 1, bits 5-8 do not equal '0000', then the message shall be ignored.
- 2) If the call reference information element octet 1, bits 1-4 indicates a length other than 2, then the message shall be ignored.

10.10.3.2 Call reference procedural errors

- 1) Whenever a CALL PROCEEDING, CONNECT, DISCONNECT or RELEASE is received specifying a call reference which it does not recognize as related to an active SVC or a SVC set-up request in progress, the receiving entity shall send a RELEASE COMPLETE message with cause No. 81 *Invalid call reference value* and remain in the Null state (U0 or N0). The RELEASE COMPLETE message will specify the call reference received in the message in error.
- 2) When a RELEASE COMPLETE is received that specifies a call reference which it does not recognize as related to an active switched virtual connection or a switched virtual connection set-up request in progress, no action should be taken.
- 3) When a SETUP message is received that specifies a call reference which is recognized as related to an active switched virtual connection or a switched virtual connection set-up request in progress or with a call reference flag incorrectly set to B '1', that message shall be ignored.
- 4) When any message except RESTART, RESTART ACKNOWLEDGE or STATUS is received using the global call reference, no action should be taken on this message and a STATUS message using the global call reference with cause No. 81 *Invalid call reference value* and a call state indicating REST0 shall be returned.
- 5) When a STATUS message is received that specifies a call reference which is not recognized as related to an active switched virtual connection or a switched virtual connection set-up request in progress, the procedures of 10.8.2 shall apply.
- 6) When a STATUS ENQUIRY message is received that specifies a call reference which is not recognized as related to an active switched virtual connection or a switched virtual connection set-up request in progress, the procedures of 10.8.1 shall apply.

10.10.4 Message type or message sequence errors

- 1) Whenever an unexpected RELEASE message is received, the DCE or the DTE shall stop all timers, send a RELEASE COMPLETE message, release the DLCI and the call reference and return to the Null state (U0 or N0). In addition, the DCE shall clear the SVC with the remote DTE.
- 2) Whenever an unexpected RELEASE COMPLETE message is received, the DCE or the DTE shall stop all timers, release the DLCI and the call reference and return to the Null state (U0 or N0). In addition, the DCE shall clear the switched virtual connection with the remote DTE before returning to the Null state.
- 3) Whenever an unexpected CALL PROCEEDING, CONNECT, SETUP or DISCONNECT message, or an unrecognized message is received in any state other than the Null state, one of the following three actions shall be performed without changing state:
 - Sending a STATUS message with cause No. 98 *Message not compatible with call state or message type non-existent or not implemented* and the message type code point in the diagnostic field of the cause information element;

- Sending of a STATUS message with either cause No. 97 *Message type non-existent or not implemented* if the message is unrecognized/not implemented or cause No. 101 *Message not compatible with call state* if the message is unexpected in the current state;
- Sending of a STATUS ENQUIRY message requesting the call state of the sender if the received message does not use the global call reference.

10.10.5 General information element errors

10.10.5.1 Information element out of sequence

A variable length information element which has a code value lower than the code value of the variable length information element preceding it shall be considered as out of sequence information element.

If the DCE or the DTE receives a message containing an out of sequence information element, it may ignore this information element and continue to process the message. If the DCE or the DTE chooses to ignore this out of sequence information element, then the error handling procedure for missing mandatory information elements as described below shall apply. If the out of sequence information element is non-mandatory, the receiver continues to process the message.

NOTE – Some implementation may choose to process all information elements received in a message regardless of the order in which they are placed.

10.10.5.2 Duplicated information elements

- 1) If an information element is repeated in a message in which repetition of the information element is not permitted, only the contents of the first instance of the information element shall be considered and all subsequent instances shall be ignored.
- 2) When repetition of an information element is permitted and if the limit of repetition of the information element is exceeded, the contents of the instances of the information element appearing up to the limit of repetition shall be handled and all subsequent repetitions of the information element shall be ignored.

10.10.6 Mandatory information element errors

10.10.6.1 Mandatory information element missing

- 1) When a RELEASE COMPLETE message is received, as a first clearing message, with the cause information element missing, it will be assumed that cause No. 31 *Normal, unspecified* was received.
- 2) When a DISCONNECT or RELEASE message is received, as a first clearing message, with the cause information element missing, it will be assumed that cause No. 31 *Normal, unspecified* was received. However the reply, RELEASE or RELEASE COMPLETE respectively, shall be sent to the other side of the UNI with the cause No. 96, *Mandatory information element is missing*.
- 3) When a SETUP message is received which has one or more mandatory information element missing, the receiving entity shall clear the SVC by following the clearing procedures before reaching the active state as described in 10.7.4.2 and a message with cause No. 96 *Mandatory information element is missing* shall be returned.
- 4) When a message other than one of the above is received which has one or more mandatory information elements missing, no action should be taken on the message and no state change should occur. A STATUS message should be returned with cause No. 96 *Mandatory information element is missing*.

10.10.6.2 Mandatory information element content error

- 1) An implementation should consider as invalid an information element with a length exceeding the maximum length defined in 10.5.
- 2) When a RELEASE COMPLETE message is received with an invalid content of the cause information element, it will be assumed that cause No. 31 *Normal, unspecified* was received.
- 3) When a DISCONNECT or RELEASE message is received with an invalid content of the cause information element, it will be assumed that cause No. 31 *Normal, unspecified* was received. However the reply, RELEASE or RELEASE COMPLETE respectively, shall be sent to the other side of the UNI with the cause value No. 100 *Invalid information element contents*.
- 4) When a SETUP or RELEASE message is received which has one or more mandatory information element with an invalid content, the receiving entity shall clear the SVC by following the clearing procedures before reaching the active state as described in 10.7.4.2 with cause No. 100 *invalid information element contents*.
- 5) When a CALL PROCEEDING, or CONNECT message is received which has one or more mandatory information elements with an invalid content, no action should be taken on the message and no state change should occur. A STATUS message with cause No. 100 *Invalid information element contents* shall be returned.

10.10.7 Non-mandatory information element errors

The following clauses identify actions on information element not recognized as mandatory. When a message is received which has one or more unrecognized information elements, the receiving entity shall check whether any are encoded to indicate "comprehension required". If any unrecognized information element is encoded to indicate "comprehension required", then the procedures of 10.10.6.1 are followed, i.e., as if a "missing mandatory information element" error condition has occurred. If all unrecognized information elements are not encoded to indicate "comprehension required", then the receiving entity shall proceed as specified in the following subclauses.

10.10.7.1 Unrecognized information element

- 1) When a RELEASE COMPLETE message is received which has one or more unrecognized information elements, no action shall be taken on the unrecognized information elements.
- 2) When a RELEASE message is received which has one or more unrecognized information elements, a RELEASE COMPLETE message is returned with cause No. 99 *Information element/parameter non-existent or not implemented*, the diagnostic field, if present, shall contain the information element identifier for each information element which was unrecognized.
- 3) When a DISCONNECT message is received which has one or more unrecognized information elements, a RELEASE message is returned with cause No. 99 *Information element/parameter non-existent or not implemented*, the diagnostic field, if present, shall contain the information element identifier for each information element which was unrecognized.
- 4) When a message is received which has one or more unrecognized information elements, action shall be taken on the message and those information elements which have a valid content. When a CALL PROCEEDING, CONNECT or SETUP message is received, a STATUS message may be returned indicating the call state of the sender after taking action on the valid information elements of the message. The cause information element shall contain cause No. 99 *Information element/parameter non-existent or not implemented*, and the diagnostic field, if present, shall contain the information element identifier for each

information element which was unrecognized. Subsequent actions are determined by the sender of the faulty message.

NOTE – The diagnostic of cause No. 99 facilitates the decision in selecting an appropriate recovery procedure at the reception of a STATUS message. Therefore, it is recommended to provide cause No. 99 with diagnostic information.

10.10.7.2 Non-mandatory information element content error

An implementation may either discard or truncate an information element with a length exceeding the maximum length defined in 10.5.

When a message is received which has one or more non-mandatory information elements with invalid content, action shall be taken on the message and those information elements which have a valid content. A STATUS message may be returned indicating the call state of the sender after taking action on the valid information elements of the message. The cause information element shall contain cause No. 100 *Invalid information element contents* and the diagnostic field, if present, shall contain the information element identifier for each information element which has a content error. Subsequent actions are determined by the sender of the faulty message.

10.10.7.3 Unexpected recognized information element

- When a message is received with a recognized information element not defined to be contained in that message, the receiving entity shall treat the information element as an unrecognized information element and follow the procedures for handling non-mandatory unrecognized information elements.

10.10.8 Handling of data link exceptions of the signalling channel

10.10.8.1 Data link reset

Whenever an entity is informed of a data link reset, no special actions shall be taken; the appropriate procedures (normal procedures or error handling procedures) described above shall be performed.

10.10.8.2 Data link failure

Data link failure consists of a disconnect of the link followed by a link re-establishment. For this event, the restart procedures shall be performed. As a consequence, any switched virtual connection shall be cleared internally.

10.11 List of timers

NOTE – This clause corresponds to 10.7.

10.11.1 DTE timers

The DTE timers are specified in ITU-T Rec. Q.931. The following timers are supported: T303, T305, T308, T310, T316, T317 and T322. Timers T305, T308, T316 and T317 are mandatory (see Table 10-27).

Table 10-27/X.36 – DTE timers

Timer No.	Default value	Cause for start	Normal stop	1st expiry	2nd expiry
T303	4 s	SETUP sent	CALL PROCEEDING or clearing message received	Retransmit SETUP Restart T303	Not restarted Clear call
T305	30 s	DISC sent	Clearing message received	Send RELEASE message	Not restarted
T308	4 s	REL sent	Clearing message received	Retransmit RELEASE Restart T308	Not restarted Release call reference
T310	30-40 s	CALL PROC received	CONNECT or clearing message received	Clear call	Not restarted
T316	120 s	RESTART sent	RESTART ACKNOWLEDGE received	RESTART may be transmitted several times	RESTART may be transmitted several times
T317	Implementation-dependent	RESTART received	Internal clearing of call references	Maintenance notification	Timer is not restarted
T322	4 s	STAT ENQ sent	STATUS or a clearing message received	STATUS ENQUIRY retransmitted	May be transmitted several times

10.11.2 DCE timers

The DCE timers are specified in ITU-T Rec. Q.931. The following timers are supported: T303, T305, T308, T310, T316, T317 and T322. All of them are mandatory for the DCE (see Table 10-28).

Table 10-28/X.36 – DCE timers

Timer No.	Default value	Cause for start	Normal stop	1st expiry	2nd expiry
T303	4 s	SETUP sent	CALL PROCEEDING, CONNECT or a clearing message received	Retransmit SETUP Restart T303	Not restarted Clear call
T305	30 s	DISC sent	Clearing message received	Send RELEASE message	Not restarted
T308	4 s	REL sent	Clearing message received	Retransmit RELEASE Restart T308	Not restarted Release call reference
T310	30-40 s	CALL PROC received	CONNECT or clearing message received	Clear call	Not restarted
T316	120 s	RESTART sent	RESTART ACKNOWLEDGE received	RESTART may be transmitted several times	RESTART may be transmitted several times
T317	Implementation-dependent	RESTART received	Internal clearing of call references	Maintenance notification	Timer is not restarted
T322	4 s	STAT ENQ sent	STATUS or a clearing message received	STATUS ENQUIRY retransmitted	May be transmitted several times

10.12 Closed user group facility

10.12.1 General

A set of Closed User Group (CUG) optional user facilities enables users to form groups of DTEs to and/or from which access is restricted. A DTE belonging only to one or several CUGs (i.e., not having the outgoing or incoming access described below) can only communicate with DTEs belonging also to one of these CUGs: the network will clear any call not fitting with this condition. From an administrative point of view, a DTE may subscribe to a given CUG only with the authorization of the subscriber who is responsible for the CUG.

In addition to the CUGs, the open part is defined which is composed of all the DTEs which have not subscribed to any closed user group related facilities.

A DTE having subscribed to outgoing access may call the open part and DTEs having subscribed to incoming access.

A DTE having subscribed to incoming access may be called by the open part and by DTEs having subscribed to the outgoing access.

10.12.2 Subscription options

The DTE may subscribe either to simple CUG facility or to CUG selection facility.

The simple CUG facility enables the DTE to belong to one CUG in a way that is completely transparent, i.e., without any specific signalling procedures.

The CUG selection facility enables the DTE to belong to one or several CUGs and for each virtual circuit to select or to receive the information to which CUG the particular virtual circuit belongs to.

In addition, the DTE may subscribe to outgoing access and/or incoming access.

10.12.3 Per call options

The CUG facilities defined on a per call basis are:

- No CUG – It is equivalent to a call with called DTE in the open part or having subscribed to incoming access.
- CUG specified.
- CUG specified with outgoing access.

10.12.4 Simple CUG

Simple CUG is an optional user facility agreed for a period of time and applies to the entire DTE/DCE interface for virtual circuits. This facility, if subscribed to, enables the DTE to belong to a CUG in a way that is completely transparent.

At subscription time the user simply indicates its CUG profile:

- the CUG it wants to belong to (only one);
- the outgoing access or not;
- the incoming access or not.

In all these combinations, no closed user group information element is needed nor permitted in the SETUP messages received and transmitted by the DTE.

10.12.4.1 SETUP message from the DTE to the DCE

The SETUP message transmitted by the DTE should not contain any closed user group information element. If any closed user group information element is present in a SETUP message received from a DTE having subscribed to the simple CUG facility, the DCE must clear the switched virtual circuit with cause No. 50 *Requested facility not subscribed*.

To determine whether or not the call can proceed and if it can, the type of the call regarding CUG possibilities, the DCE processes the CUG profile of the calling DTE as described in Table 10-29.

Table 10-29/X.36 – DCE check on outgoing calls for simple CUG

CUG profile of the calling DTE	Type of call regarding CUG possibilities
Simple CUG	CUG specified
Simple CUG plus outgoing access	CUG specified with OA

10.12.4.2 SETUP message from the DCE to the DTE

To determine whether the call can be presented to the called DTE or must be cleared, the DCE processes the type of call regarding CUG possibilities and the user profile of the called DTE as described in Table 10-30.

NOTE – In the following tables on CUG, the numbers in parentheses refer to cause values.

Table 10-30/X.36 – DCE check on incoming calls for simple CUG

CUG profile of the called DTE	Type of the call regarding CUG possibilities				
	No CUG	CUG specified		CUG specified with OA	
		Match	No match	Match	No match
Simple CUG	Clear call (87)	Call allowed	Clear call (87)	Call allowed	Clear call (87)
Simple CUG with IA	Call allowed	Call allowed	Clear call (87)	Call allowed	Call allowed

The SETUP message transmitted by the DCE must not contain any closed user group information element.

10.12.5 CUG selection

CUG selection is an optional user facility agreed for a period of time for virtual circuits and applies for the entire DTE/DCE interface. This facility, if subscribed to, enables the DTE to belong to one or several CUGs and for each virtual circuit to select or to receive the information to which CUG the particular virtual circuit belongs to.

At subscription, the user indicates its CUG profile:

- the CUG(s) it wants to belong to;
- the outgoing access or not;
- the incoming access or not.

10.12.5.1 SETUP message from the DTE to the DCE

The SETUP message transmitted by the DTE may contain or not the closed user group information element. To determine whether or not the call can proceed and if it can, the type of the call regarding CUG possibilities, the DCE processes the content of the closed user group information element (if present) and the CUG profile of the calling DTE as described in Table 10-31.

NOTE – The presence of the closed user group information element with a coding error is handled as a non-mandatory information element error.

Table 10-31/X.36 – DCE check on outgoing calls for CUG selection

CUG profile of the calling DTE	Type of the call specified in the SETUP message				
	Not CUG call	CUG call		CUG call with OA	
		Match	No match	Match	No match
CUG selection	Clear call (50)	Call with specified CUG	Clear call (90)	Clear call (50)	Clear call (90)
CUG selection with IA	Normal call	Call with specified CUG	Clear call (90)	Call with specified CUG + OA	Normal call

10.12.5.2 SETUP message from the DCE to the DTE

To determine whether the call can be presented to the called DTE or must be cleared, the DCE processes the type of the call regarding CUG possibilities and the CUG profile of the called DTE as described in Table 10-32. When the call can be presented, Table 10-32 provides also the CUG signalling to the DTE.

Table 10-32/X.36 – DCE check and signalling on incoming calls for CUG selection

CUG profile of the called DTE	Type of the call specified in the SETUP message				
	Not CUG call	CUG call		CUG call with OA	
		Match	No match	Match	No match
CUG selection	Clear call (87)	Call with specified CUG	Clear call (87)	Call with specified CUG	Clear call (87)
CUG selection with incoming access	Normal call	Call with specified CUG	Clear call (87)	Call with specified CUG + OA	Normal call

10.12.6 No CUG

In case DTEs have subscribed neither to simple CUG nor to CUG selection facilities, this clause describes DCE check and signalling on outgoing and incoming calls.

10.12.6.1 SETUP message from the DTE to the DCE

The SETUP message transmitted by the DTE should not include the closed user group information element. If any closed user group information element is present in a SETUP message received from a DTE having subscribed neither to simple CUG nor CUG selection facilities, the DCE must clear the virtual circuit with cause No. 50 *Requested facility not subscribed*. If present, the diagnostic includes the information element identifier of the closed user group information element.

The per call facility used such a DTE is "call with no CUG".

10.12.6.2 SETUP message from the DCE to the DTE

To determine whether the call can be presented to the called DTE or must be cleared, the DCE processes the type of the call regarding CUG possibilities and the fact that the called DTE has not subscribed to any CUG facilities, as described in Table 10-33.

Table 10-33/X.36 – DCE check on incoming calls for No CUG

CUG profile of the called DTE	Type of the call specified in the SETUP message				
	Not a CUG call	CUG call		CUG call with OA	
No CUG	Normal call		Clear call (87)	Normal call	

10.13 Transit network selection facility

It is a network option to support the transit network selection facility. In the case where the network does not support the transit network selection capability and a transit network selection information element is received in the SETUP message, that information element is processed according to the rules for unimplemented non-mandatory information elements.

When the transit network selection capability is supported, the user may identify one and only one transit network in the SETUP message in a Transit network selection information element. If a Transit network selection information element is included in the SETUP message and the network cannot route through the transit network specified, it shall not route through another route but clear the call with cause No. 2 *No route to specified transit network*.

A network may screen the transit network selection information element to:

- ensure an appropriate business relationship exists between selected networks; or
- ensure compliance with national and local regulations.

If the transit network is of an incorrect format, or fails to meet the above criteria, the network shall initiate call clearing with cause No. 91 *Invalid transit network selection*.

10.14 Reverse charging facility

10.14.1 Reverse charging request and acceptance

Reverse charging is an optional facility which may be requested by a calling DTE for a given SVC establishment request. To request reverse charging, the calling DTE includes in the SETUP message the Reverse charging indication information element. The network will transmit to the called DTE a SETUP message with the Reverse charging indication information element. The called DTE may reject the Reverse charging indication request with cause No. 29 *Facility rejected*.

In the absence of this information element in the SETUP message at the calling DTE/DCE interface, the network will not transmit to the called DTE the Reverse charging indication information element and normal charging will apply.

10.14.2 Reverse charging prevention

The Reverse charging prevention is an optional facility activated by subscription. The network will not transmit to a called DTE which has subscribed to this facility a SETUP message requesting reverse charging. But will clear the call towards the calling DTE with cause No. 29 *Facility rejected*.

10.15 Frame Transfer priority

10.15.1 Actions by the calling DTE

To request a specific Frame transfer priority for each direction of a switched virtual circuit, the calling DTE has to include the Priority and service class parameters information element in the SETUP message with the requested indices. The Frame transfer priority indices for the outgoing and incoming directions can be the same or different.

10.15.2 Actions by the network

Upon receiving a SETUP message that includes transfer priority indices in the Priority and service class parameters information element, the network maps these indices to its internal transfer priority classes it supports. If a network does not support a different frame transfer priority per data transmission direction, the highest priority index is used for both directions. A network may assign a default transfer priority class to a switched virtual circuit when the calling DTE has not signalled a frame transfer priority. The value of this default is network dependent.

The SETUP message transmitted by the network to the called DTE contains transfer priority indices in the Priority and service class parameters information element based on the transfer priority class assigned to the call.

If the network is unable to provide the requested frame transfer priorities, it will reject the set-up request with cause No. 49 *Quality of service not available*. If the priority and service class parameters information element is not recognized by the network, the error handling procedures for unrecognized information element apply. When applicable, cause No. 29 *Facility rejected* or cause No. 50 *Requested facility not subscribed* may also be used.

In case the network puts some limits on the use of given priorities as described in 7.4.2 and if a particular limit is exceeded at call set-up, the network can adjust the link layer core parameters or clear the call.

10.15.3 Actions by the called DTE

If the called DTE receives a SETUP message containing a Priority and service class parameters information element, it may either accept the call if the requested transfer priority indices for the outgoing and incoming directions are acceptable or reject it if one of the requested transfer priority index is not acceptable with cause No. 49 *Quality of service not available*.

10.16 Frame Discard priority

10.16.1 Actions by the calling DTE

To request a specific frame discard priority for each direction of a switched virtual circuit, the calling DTE has to include the Priority and service class parameters information element in the SETUP message with the requested frame discard indices. The discard indices for the outgoing and incoming directions can be the same or different.

10.16.2 Actions by the Network

Upon receiving a SETUP message from the calling DTE/DCE interface that includes frame discard priority indices in the Priority and service class parameters information element, the network maps these indices to its internal frame discard priority classes that it supports. If a network does not support a different frame discard priority per data transmission direction, the highest priority index is used for both directions. A network may assign a default discard priority class to a switched virtual connection when the calling DTE has not signalled a discard priority. The value of this default is network dependent.

The SETUP message transmitted by the network to the called DTE contains frame discard priority indices in the Priority and service class parameters information element as requested by the calling DTE.

If the network is unable to provide the requested Frame Discard Priorities, it will reject the set-up request with cause No. 49 *Quality of service not available*. If the priority and service class parameters information element is not recognized by the network, the error handling procedures for unrecognized information element apply. When applicable cause No. 29 *Facility rejected* or cause No. 50 *Requested facility not subscribed* may also be used.

In case the network puts some limits on the use of given priorities as described in 7.5.2 and if a particular limit is exceeded at call set-up, the network can adjust the link layer core parameters or clear the call.

10.16.3 Actions by the called DTE

If the called DTE receives a SETUP message containing a Priority and service class parameters information element, it may either accept the call if the requested frame discard priority indices for the outgoing and incoming directions are acceptable, or reject it if any of the requested frame discard priority index is not acceptable with a cause No. 49 *Quality of service not available*.

10.17 Frame Relay Service Class

10.17.1 Action by the calling DTE

To request a particular Service Class, the calling DTE includes a Service Class Parameter Priority and service class parameters information element in the SETUP message with a value set to the Service Class number corresponding to the Service Class selected.

10.17.2 Action by the network

Upon reception of a Service Class parameter in the Priority and service class parameter information element of the SETUP message, the network will set up an SVC taking the requested Service Class value into account in the SVC establishment procedures.

In case Service Class parameter is not included in the Priority and service class parameter information element of the SETUP message, the network's default Service Class (Service Class 1) will be used in the SVC establishment procedures.

If not able to establish the call with the specified service class parameter value, the network will clear the call with cause No. 49 *Quality of service not available*.

The network signals to the called DTE the service class associated within the network to the call being presented by inserting a Service Class parameter in the Priority and service class parameter information element of the SETUP message, the value being the same as the one sent by the calling DTE.

10.17.3 Action by the called DTE

The Called DTE may use the signalled Service Class parameter value in the Priority and service class parameters information element of the SETUP message to apply an internal Quality of Service mechanism.

If the Called DTE can accept the incoming call with the indicated Service Class parameter value, normal call establishment procedures will be followed.

If the Called DTE cannot accept the incoming call with the indicated Service Class parameter value, it will clear the call using cause No. 49 *Quality of service not available*.

10.18 Support of both Service Class and Priorities

10.18.1 Action by the calling DTE

In the optional DTE subscription option, the calling DTE is expected to always request either priorities or service classes.

In the no DTE subscription case, the calling DTE will include either Service class parameter or Priority(ies) parameter(s) in the Priority and service class parameters information element of the SETUP message.

10.18.2 Action by the network

In the optional DTE subscription option, the network acts at the calling DTE/DCE interface according to what the DTE has subscribed to.

In the no DTE subscription case, the network acts at the calling DTE/DCE interface according to what the DTE signals on a per call basis.

NOTE – If both Service Class and Priority parameters are received in the Priority and Service Class information element of the SETUP message, (the network will ignore Priority parameter(s) and will treat the Service Class parameter as valid) or (the DCE will ignore either Priority parameter(s) or Service class parameter as a network option). The actual choice is for further study.

At the called DTE/DCE interface, the network will insert either Priority parameter(s) or Service class parameter in the Priority and Service class parameters information element of the SETUP message, according to the DTE subscription if this option is supported. When the priority(ies) or service class associated within the network to the call being presented are not compatible with the subscription parameter of the called DTE, mapping from priority(ies) to the best matching service class or from service class to the best matching priority(ies) occurs.

In the no DTE subscription option, the network signals to the called DTE either the service class or the priority(ies) associated with the call being presented by inserting a Service Class parameter or Priority parameter(s) in the Priority and service class parameter information element of the SETUP message.

10.18.3 Action by the called DTE

When it supports either priorities or service class, the called DTE acts accordingly. When it supports both priorities and service class, the called DTE acts according to what the network signals on a per call basis.

NOTE – If both Service Class and Priority parameters are received in the Priority and Service Class information element of the SETUP message, the called DTE will ignore the non-supported parameters. When it supports both Service class and Priority parameter(s) (the called DTE will ignore the Priority parameter(s) and will treat the Service Class parameter as valid) or (the called DTE will ignore either Priority parameter(s) or Service class parameter as an implementation option). The actual choice is for further study.

10.19 Charging information

This network facility is for further study.

11 PVC management procedures

11.1 Overview

These procedures described in 11.2-11.6 provide the following functionalities:

- link integrity verification of the DTE/DCE interface;
- notification to the DTE of the addition of a PVC;
- detection by the DTE of the deletion of a PVC;
- notification to the DTE of the status of a PVC.

These procedures are based on periodic transmission of a STATUS ENQUIRY message by the DTE and STATUS message by the DCE.

The support of these procedures is mandatory for the network. The DTE has to indicate at subscription time whether or not it will use these procedures. In addition, for example, when the DTE is a private network, bidirectional procedures as described in 11.5 may be used. It is optional for the network to support these procedures. The DTE has to indicate at subscription time whether or not it will use the bidirectional procedures.

In addition to the capabilities defined in this clause, Annex G defines optional PVC signalling enhancements procedures to increase the number of PVCs status reports. The enhanced procedures add a new report type in order to segment the STATUS message when the number of PVC status reporting cannot fit in one STATUS message.

11.2 Message definition

Both messages are transferred on DLCI = 0, FECN, BECN and DE bits are not used and must be set to 0 upon transmission and must not be interpreted upon reception. The 3 octets following the address field have fixed values:

- the first octet is the control field of a UI frame with P bit set to 0;
- the 2nd octet is the protocol discriminator information element of the message;
- the 3rd octet is the dummy call reference information element of the message.

Consequently, the first octets of the frame are as described in Figure 11-1.

The other information elements are described in 11.2.1 and 11.2.2 below.

Octet	8	7	6	5	4	3	2	1	
1	Flag								
2	0	0	0	0	0	0	0	0	Address field
3	0	0	0	0	0	0	0	1	DLCI = 0
4	0	0	0	0	0	0	1	1	UI P = 0
5	0	0	0	0	1	0	0	0	Protocol discriminator
6	0	0	0	0	0	0	0	0	Dummy call reference
	Message specific information element								See 11.2.1 and 11.2.2
	FCS								
	Flag								

**Figure 11-1/X.36 – PVC management frame format
(for 2 octets address)**

11.2.1 STATUS ENQUIRY message

This message is sent to request the status of PVCs or to verify link integrity. Message specific information elements for this messages are described in Table 11-1, and are in the order indicated in this table.

Table 11-1/X.36 – Message specific information elements in STATUS ENQUIRY message

Message type: STATUS ENQUIRY Significance: Local		Direction: Both	
Information element	Direction	Type	Length
Message type	Both	Mandatory	1
Report type	Both	Mandatory	3
Link integrity verification	Both	Mandatory	4

11.2.2 STATUS message

This message is sent in response to a STATUS ENQUIRY message to indicate the status of permanent virtual circuits or for a link integrity verification. Optionally, it may be sent at any time to indicate the status of a single PVC. Message specific information elements for this message are described in the Table 11-2, and are in the order indicated in the table. Moreover, the PVC status information element may occur several times.

Table 11-2/X.36 – Message specific information elements in STATUS message

Message type: STATUS		Direction: Both	
Significance: Local			
Information element	Direction	Type	Length
Message type	Both	Mandatory	1
Report type	Both	Mandatory	3
Link integrity verification	Both	Optional/Mandatory (Note)	4
PVC status	Both	Optional/Mandatory (Note)	5-7
NOTE – Optional or Mandatory depending on the type of report. See 11.4.			

11.3 Message specific information elements

11.3.1 Message type

The coding of message type is defined in Table 11-3.

Table 11-3/X.36 – Message type coding

<i>Message type coding for PVC management</i>			
Bits			
<u>8</u>	<u>7</u>	<u>6</u>	<u>5 4 3 2 1</u>
0	1	-	- - - - -
1	0	1	0 1 STATUS ENQUIRY
1	1	1	0 1 STATUS

11.3.2 Report type

The purpose of the Report type information element is to indicate the type of enquiry requested when included in a STATUS ENQUIRY message or the contents of the STATUS message. The length of this information element is 3 octets. The format of the Report type information element is defined in Figure 11-2, where the type of report is indicated in octet 3.

8	7	6	5	4	3	2	1	Octet
0	1	0	1	0	0	0	1	1
Length of report type contents								2
Type of report								3

Type of report (octet 3)

Bits

8 7 6 5 4 3 2 1

0 0 0 0 0 0 0 0 Full status (status of all PVCs on the DTE/DCE interface)

0 0 0 0 0 0 0 1 Link integrity verification only

0 0 0 0 0 0 1 0 Single PVC asynchronous status

All other values are reserved.

Figure 11-2/X.36 – Report type information element

11.3.3 Link integrity verification

The purpose of the Link integrity verification information element is to exchange sequence numbers between the DCE and the DTE on a periodic basis. The length of this information element is 4 octets. The length of the contents of the link integrity information element is binary encoded in octet 2.

The format of the Link integrity verification information element is defined in the Figure 11-3, where send sequence number in octet 3 indicates the current send sequence number of the originator of the message, and receive sequence number in octet 4 indicates the send sequence number received in the last received message. The send sequence number is binary encoded in octet 3. The receive sequence number is encoded in octet 4.

8	7	6	5	4	3	2	1	Octet
0	1	0	1	0	0	1	1	1
Length of link integrity verification contents = 2								2
Send sequence number								3
Receive sequence number								4

Figure 11-3/X.36 – Link integrity verification information element

11.3.4 PVC status

The purpose of the PVC status information element is to indicate the status of existing PVCs at the interface. The information element can be repeated, as necessary, in a message to indicate the status of all PVCs on the DTE/DCE interface. The length of this information element depends on the length of the DLCIs being used on the DTE/DCE interface. The length of this information element is 5 octets when a default address format (2 octets) is used. The format of the PVC status information element is defined in Figure 11-4, where a default address format is used. Bit 6 of octet 3 is the most significant bit in the data link connection identifier.

8	7	6	5	4	3	2	1	Octet
0	1	0	1	0	1	1	1	1
Length of PVC status contents = 3								2
ext. 0	Spare 0	Data Link connection identifier (Most significant 6 bits)						3
ext. 1	Data Link connection identifier (2nd most significant 4 bits)				0	Spare 0 0		3a
ext. 1	0	Spare 0	0	New "N"	Delete "D"	Active "A"	Reserved 0	4

Figure 11-4/X.36 – PVC STATUS information element with 2 octets address format

The format of the PVC status information element is defined in Figure 11-5, where a 4 octets address format is used.

8	7	6	5	4	3	2	1	Octet
0	1	0	1	0	1	1	1	1
Length of PVC status contents = 5								2
ext. 0	Spare 0	Data Link connection identifier (Most significant 6 bits)						3
ext. 1	Data Link connection identifier (3rd most significant 4 bits)				0	Spare 0 0		3a
ext. 0	Data Link connection identifier (3rd most significant 7 bits)							3b
ext. 1	Data Link connection identifier (4th most significant 6 bits)						Spare 0	3c
ext. 1	0	Spare 0	0	New "N"	Delete "D"	Active "A"	Reserved 0	4

Figure 11-5/X.36 – PVC STATUS information element with 4 octets address format

Bit 2 of the last octet for each PVC status information element is Active bit, which is coded 1 to indicate the PVC is active, and coded 0 to indicate the PVC is inactive. An active indication means that the PVC is available to be used for data transfer. An inactive indication means that the PVC is configured but is not available for data transfer.

Bit 3 of the last octet for each PVC status information element is Delete bit, which is coded 1 to indicate the PVC is deleted, and coded 0 to indicate the PVC is configured.

Bit 4 of the last octet for each PVC status information element is New bit, which is coded 1 to indicate the PVC is newly configured, and coded 0 to indicate the PVC is already configured.

The PVC status information elements are arranged in the messages in ascending order of DLCIs; the PVC with the lowest DLCI is first, the second lowest DLCI is second, and so on. The maximum number of PVCs that can be indicated in a message is limited by the maximum frame size.

The Delete bit is only applicable for timely notification using the optional single PVC asynchronous status report. When this bit is set to 1, the New and Active bits have no significance and shall be set to 0 upon transmission and not interpreted upon reception. When the New or Active bits have significance, the Delete bit shall be set to 0 upon transmission and not interpreted upon reception.

11.4 Description of procedures

These procedures use periodic polling, as described in 11.4.1, to verify the integrity of the link (see 11.4.1.2) and to report the status of the PVCs (see 11.4.1.3, 11.4.1.4 and 11.4.1.5).

11.4.1 Periodic polling

11.4.1.1 General

The DTE initiates the polling described below.

- 1) The DTE sends a STATUS ENQUIRY message to the DCE and starts the polling timer T391. When T391 expires, the DTE repeats the above action.
This STATUS ENQUIRY message typically requests a link integrity verification exchange only (report type equal '0000 0001'). However every N391 polling cycle, the DTE requests full status of all PVCs (report type equal '0000 0000').
- 2) The DCE responds to each STATUS ENQUIRY message with a STATUS message and starts or restarts the polling verification timer T392 used by the network to detect errors (see 11.4.1.6). The STATUS message sent in response to a STATUS ENQUIRY contains the link integrity verification and report type information elements. If the content of the report type information element specifies full status, then the STATUS message must contain one PVC status information element for each PVC configured on the DTE/DCE interface.
- 3) The DTE shall interpret the STATUS message depending upon the type of report contained in this STATUS message. The DCE may respond to any poll with a full status message in case of a PVC status change or to report the addition or deletion of PVC on the DTE/DCE interface. If it is a full status message, the DTE should update the status of each configured PVC.

11.4.1.2 Link integrity verification

The purpose of the link integrity verification information element is to allow the DTE and the DCE to determine the status of the signalling link (DLCI 0). This is necessary since these procedures use the Unnumbered Information (UI) frame.

Figure 11-6 shows the normal Link integrity verification procedure.

The DTE and the DCE maintain the following internal counters:

- The send sequence counter maintains the value of the send sequence number field of the last link integrity verification information element sent.
- The receive sequence counter maintains the value of the last received send sequence number field in the link integrity verification information element and maintains the value to be placed in the next transmitted received sequence number field.

The following procedure is used:

- 1) Before any messages are exchanged, the DCE and the DTE set the send sequence counter and receive sequence counter to zero.
- 2) Each time the DTE sends a STATUS ENQUIRY message, it increments the send sequence counter and places its value into the send sequence number field. It also places the current value of the receive sequence counter into the receive sequence number field of the link integrity verification information element. The DTE increments the send sequence counter using modulo 256. The value zero is skipped.
- 3) When the DCE receives a STATUS ENQUIRY from the DTE, the DCE checks the receive sequence number received from the DTE against its send sequence counter. The handling of error conditions is described in 11.4.1.6.

The received send sequence number is stored in the receive sequence counter. The DCE then increments its send sequence counter and places its current value in the send sequence number field and the value of the receive sequence counter (the last received send sequence number) into the receive sequence number field of the outgoing link integrity verification information element. The DCE then transmits the completed STATUS message back to the DTE. The DCE increments the send sequence counter using modulo 256. The value zero is skipped.

- 4) When the DTE receives a STATUS from the DCE in response to a STATUS ENQUIRY, the DTE checks the receive sequence number received from the DCE against its send sequence counter. The handling of error conditions is described in 11.4.1.6. The received send sequence number is stored in the receive sequence counter.

NOTE – The value zero in the receive sequence number indicates that the field contents are undefined, this value is normally used after initialization. The value zero shall not be sent in the send sequence number field so that the receive sequence number shall never contain the value zero to differentiate the undefined condition from the normal modulo round off.

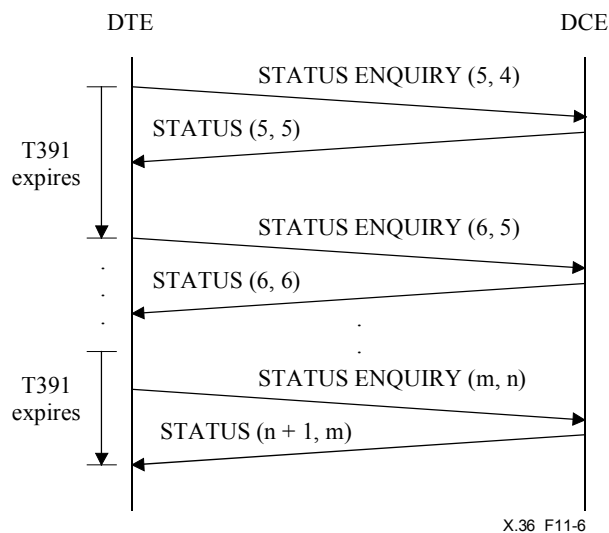

Figure 11-6/X.36 – Link integrity verification

11.4.1.3 Signalling of the presence or absence of a PVC

The DCE will signal the presence of a PVC by including a PVC status, i.e., with the appropriate DLCI in a STATUS message with full status report. A PVC should be considered as present when it is configured in the network in which the DCE is located.

The DTE shall interpret the omission of a previously reported PVC from the full status message as an indication that the PVC is no longer provisioned at the DTE/DCE interface.

11.4.1.4 Signalling that a PVC is new

One of the functions of periodic polling is to notify the DTE of newly added permanent virtual circuits using a full status message. The PVC reporting procedure using a full status message ensures that a permanent virtual circuit cannot be deleted and another added using the same DLCI without the DTE detecting the change. The PVC reporting procedures are defined as follows:

- 1) When a new permanent virtual circuit has been added, the DCE sets the New bit to 1 in the PVC status information element for that PVC in a full status STATUS message.
- 2) The DCE shall not clear the new bit in the PVC status information element until it receives a STATUS ENQUIRY message containing a receive sequence number equal to the send sequence counter (i.e., the send sequence number transmitted in the last STATUS message).
- 3) When the DTE receives a full status message containing a PVC status information element identifying an unknown DLCI and the New bit is set to 1, the DTE marks this PVC as new and adds it to its list of PVCs.

NOTE – When the New bit is set to 1, the Delete bit must be set to 0 on transmission. On reception, the Delete bit is not interpreted when the New bit is set to 1.

11.4.1.5 Signalling the activity status of PVCs

In response to a STATUS ENQUIRY message sent by the DTE containing a report type information element set to "full status", the DCE reports in a STATUS message to the DTE the activity status of each PVC configured on the DTE/DCE interface with PVC status information elements (one per PVC).

The report type information element in this STATUS message is set to "full status". Also in response to a STATUS ENQUIRY message sent by the DTE containing a report type information element set to "link integrity verification only", the DCE may respond with a STATUS message containing a report type information element set to "full status" in case of a PVC status change. Each PVC status information element contains an Active bit indicating the activity status of that PVC.

The action that the DTE takes based on the value of the Active bit is independent of the action based on the New bit. The DTE could get a PVC status information element with the New bit set to 1 and the Active bit set to 0.

If the DTE receives a PVC status information element with the Active bit set to 0, the DTE shall stop transmitting frames on the PVC until it receives a PVC status information element for that PVC with the Active bit set to 1. When the Active bit is set to 1, the Delete bit must be set to 0 on transmission. The Delete bit is not interpreted in the full status reporting STATUS message. When the Delete bit set to 1 in the optional asynchronous status message, the active bit has no significance. Other action taken by the DTE is implementation dependent.

Since there is a delay between the time the network makes a PVC active and the time the DCE transmits a PVC status information element notifying the DTE, there is a possibility of the DTE receiving frames on a PVC marked as inactive. The action the DTE takes on receipt of frames on an inactive PVC is implementation dependent.

Since there is a delay between the time the network detects that a PVC has become inactive and the time the DCE transmits a PVC status information element notifying the DTE, there is a possibility of the DCE receiving frames on an inactive PVC. The action the DCE takes on receipt of frames for an inactive PVC is network dependent and may include the dropping of frames on the inactive PVC.

The DCE will signal that a PVC is active if the following criteria are met:

- The PVC is configured and available for data transfer in the network from the local DCE to the remote DCE.
- There is no service affecting condition at both local and remote DTE/DCE interfaces.
- In the case bidirectional procedures (see 11.5) are used at the remote DTE/DCE interface, the remote DTE indicates that the PVC is present and active.

Note that in the case bidirectional procedures are used at the local DTE/DCE interface, this indication is independent of the indication received from the local DTE.

11.4.1.6 Error monitoring

The DTE and DCE use the information provided by periodic polling for error monitoring.

The DTE and DCE detect the following error conditions:

- *Procedure errors* – Non-receipt of STATUS/STATUS ENQUIRY messages, or invalid receive sequence number in a link integrity verification information element.
- *Protocol errors* – Protocol discriminator, message type, call reference and mandatory information element errors.

In case of protocol errors, DTE and DCE shall ignore such messages: no response, no error count, no use of content of link integrity verification information.

Examples of procedure errors are given in Appendix I.

11.4.1.6.1 DCE actions

Several kinds of errors have to be taken into account by the DCE:

1) *Errors within the network*

The DCE shall set the Active bit to 0 for a PVC if a service affecting condition occurs within the network (implementation dependent, e.g., switching node or internal link out of order, etc.).

2) *Errors at the DTE/DCE interface*

For the purpose to determine a service affecting condition at the DTE/DCE interface, an event is defined as:

- receipt of a STATUS ENQUIRY message with no protocol errors; or
- expiration of timer T392.

The first type of event is considered as an error if the contents of the link integrity verification information element is invalid. This consists of an invalid receive sequence number. The receive sequence number is not valid when it is not equal to the last transmitted send sequence number.

NOTE – The DCE continues periodic polling procedure regardless of the value of the received receive sequence number (i.e., the DCE answers to every STATUS ENQUIRY message with no protocol errors).

The second type of event is always considered as an error.

Detecting N392 of the last N393 events are in error indicates a service affecting condition. At the detection of a service affecting condition at the DTE/DCE interface by the DCE, the network should notify the remote DTE for each PVC whose service is affected restored by setting the Active bit to 0 in a full status STATUS message or optionally in a single PVC asynchronous PVC STATUS message.

The DCE shall continue link integrity verification procedures to detect service restoration. Detecting N392 consecutive events have occurred without error indicates service restoration.

3) *Loss of STATUS message with full status*

The DCE detects that its previous STATUS message with full status report has not been correctly received by the DTE when it receives from the DTE a STATUS ENQUIRY message that contains a receive sequence number that does not match the DCE send sequence counter (see 11.4.1.2). In this case, the DCE may indicate in the STATUS that it transmits:

- the report type with full status;
- PVC status.

The above is performed even if the received STATUS ENQUIRY does not contain a request for full status STATUS message.

4) *Recovery condition*

When the network detects that the service affecting condition is cleared, the DCE resumes normal operation of active PVC. The network shall notify the DTE for each PVC whose service is restored by the setting active bit to 1 in a full status message which is sent as a response to a STATUS ENQUIRY message or optionally in a single PVC asynchronous PVC STATUS message.

11.4.1.6.2 DTE actions

Several kinds of errors have to be taken into account by the DTE:

1) *Errors at the DTE/DCE interface*

For the purpose to determine a service affecting condition at the DTE/DCE interface, an event is defined as the transmission of a STATUS ENQUIRY message.

This event is considered as an error in the following cases:

- non-receipt of a STATUS message with no protocol errors and with report type equal to "full status" or "link integrity verification only" before T391 expires;
- receipt of a STATUS message with report type equal to "full status" or "link integrity verification only" that contains invalid contents of an information element. This consists of detecting an invalid receive sequence number. The received receive sequence number is not valid when it is not equal to the last transmitted send sequence number.

NOTE 1 – When the DTE receives a STATUS message with no protocol errors but with an invalid receive sequence number, the DTE ignores such message including its send sequence number. Using the send sequence number of such STATUS message may cause the DTE to acknowledge a STATUS message with report type equal to "full status" that has been ignored (i.e., acknowledgement of the New bit and/or deletion status).

NOTE 2 – When the DTE receives a STATUS message with type of report set to link integrity verifications in response to a STATUS ENQUIRY with type of report set to full status, the STATUS message is ignored.

Detecting N392 errors in the last N393 events indicates a service affecting condition. The DTE may also use additional methods for detecting service affecting conditions.

At the detection of a service affecting condition at the DTE/DCE interface, the DTE should stop transmission of frames on all PVCs on the DTE/DCE interface. The DTE should continue link integrity verification procedures to detect service restoration.

When the DTE detects that the service affecting conditions is cleared, it resumes normal operation of active PVCs on the DTE/DCE interface. Detecting N392 consecutive events have occurred without error indicates service restoration.

This procedure detects problems with the signalling link (DLCI = 0) and does not detect problems with individual PVCs.

2) *Discrepancies about PVC status*

If the DTE receives a PVC status information element for a PVC not currently defined and the New bit is set to 0, the DTE records this as an error and adds the PVC to the active PVCs. Other actions taken by the DTE are implementation dependent.

If the DTE receives a full status STATUS message with no PVC status information element for a PVC that the DTE is currently using, the DTE shall remove that PVC from its list of PVCs.

3) *Loss of STATUS message with full status*

When the DTE has transmitted a STATUS ENQUIRY message with requesting a full status report and has not received the corresponding STATUS message (i.e., with a full status report) before timer T391 expires, it may repeat this request for full status report in the STATUS ENQUIRY message it sends.

11.4.2 Asynchronous PVC STATUS message

It is optional for the network to support this message. In addition, when supported by the network, the DTE chooses at subscription time whether or not the DCE may transmit this message to it. The asynchronous PVC STATUS message is a STATUS message with only a report type information element set to "single PVC asynchronous status" and one PVC status information element. The asynchronous STATUS message is set by a DCE to inform the DTE of an activity status change for a given PVC. This message is transmitted asynchronously, i.e., independently of STATUS ENQUIRY message sent by the DTE. When a PVC is deleted, the DCE may send an asynchronous PVC STATUS message to the DTE that contains the report type information element set to "single PVC asynchronous status" and the PVC status information element. In the PVC status information element, the Delete bit is set to 1. When the Delete bit is set to 1, the New bit and the Active bit have no significance. They must be set to 0 on transmission and should not be interpreted on reception.

The procedures for reporting new PVCs are not supported by the asynchronous status messages. In an asynchronous PVC STATUS message, the New bit has no significance. It must be set to 0 on transmission and should not be interpreted on reception.

11.5 Optional bidirectional network procedures

It is optional for the network and the DTE to support these procedures. When supported by the network, the DTE chooses at subscription time whether or not the DCE uses these procedures. These procedures are mainly intended for the case where the DTE is a private network.

Figure 11-7 shows bidirectional procedure principles.

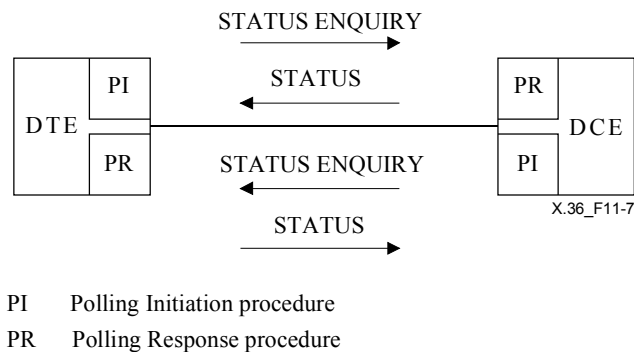

Figure 11-7/X.36 – Bidirectional procedure principles

The DTE sends STATUS ENQUIRY message and the DCE responds with STATUS message. The procedures in 11.4.1 apply.

The DCE sends STATUS ENQUIRY message and the DTE responds with STATUS message. The procedures in 11.4.1 apply with the roles of DTE and DCE reversed. The following considerations apply.

Periodic polling

Both the DTE and DCE drives periodic polling procedures as described in 11.4.1.1, i.e., both the DTE and DCE implement T391, T392 and N391.

Link integrity verification

Two sets of sequence numbers are used by the DCE and DTE for Link Integrity Verification procedures. The first set is used when the DTE sends STATUS ENQUIRY message and the DCE responds with STATUS message. The second set is used when the DCE sends STATUS ENQUIRY message and the DTE responds with STATUS message.

Error monitoring

The DTE and the DCE must both implement two sets of parameters N392 and N393. One set is used by the polling initiation procedure (see 11.4.1.6.1), and one set is used by the polling response procedure (see 11.4.1.6.2). It is recognized that in the DTE or DCE, the polling initiation procedure and the polling response procedure may detect different states. Determination of the state of the DTE/DCE interface from these states is implementation dependent.

Initial state of the DTE/DCE interface

When it is first activated, the DTE (or DCE) shall consider the interface to be non-operational, It shall consider the interface to be operational either after N393 consecutive valid polling cycles occur or, as an alternative, after one valid polling cycle occurs. In both cases when the first polling cycle results in an error, then the interface shall be considered non-operational until N393 consecutive valid polling cycles occur.

Signalling that a PVC is new

For a given PVC when the New bit received by the DCE is set to 1, this means that the PVC has been newly added or reconfigured on the DTE side (e.g., in a private network). This information shall be propagated across the network to the remote DTE/DCE interface.

NOTE – This procedure assures that the remote DTE does not miss the fact that the DTE (e.g., private network) deleted a PVC and then quickly reused the same DLCI for a new PVC to a new destination.

Deletion of a PVC

The omission of a previously reported PVC from the full status received by the DCE is interpreted as an indication that the PVC is no longer configured by the DTE on the interface. Removal of a PVC configuration by the DTE does not necessarily cause the DCE or the remote DTE to remove its configuration. In such a case an inactive status is propagated by the network to the remote DTE associated with the PVC.

11.6 System parameters

Tables 11-4 and 11-5 summarize the acceptable values for the configurable parameters described in these procedures. Parameter values other than the default values are a subscription option.

Table 11-4/X.36 – System parameters counters

Counter	Description	Range	Default/ threshold	Usage	Entity transmitting STATUS ENQUIRY (Note 1)	Entity answering with STATUS (Note 2)
N391	Full status (status of all PVCs) polling counter	1-255	6	Polling cycles	Mandatory	Not applicable
N392	Error/recovery counter	1-10 (Note 3)	3	Errored events/ No errored events	Mandatory	Mandatory
N393	Monitored events counter	1-10 (Note 4)	4	Events	Mandatory	Mandatory

NOTE 1 – Supported by the DTE for PVC management procedures. Supported by the DCE for bidirectional procedures.

NOTE 2 – Supported by the DCE for PVC management procedures. Supported by the DTE for bidirectional procedures.

NOTE 3 – N392 should be less than or equal to N393.

NOTE 4 – If N393 is set to a value much less than N391, then the link could go in and out-of error condition without the DTE or network being notified.

Table 11-5/X.36 – System parameters timers

Timer	Description	Range	Default (seconds)	Started	Actions taken when expired	Entity transmitting STATUS ENQUIRY (Note 1)	Entity answering with STATUS (Note 2)
T391	Link integrity verification polling timer	5-30	10	Transmit STATUS ENQUIRY	Transmit STATUS ENQUIRY Record error if STATUS message not received	Mandatory	Not applicable
T392	Polling verification timer	5-30 (Note 3)	15	Transmit STATUS	Record error by incrementing N392 Restart T392	Not applicable	Mandatory
<p>NOTE 1 – Supported by the DTE for PVC management procedures. Supported by the DCE for bidirectional procedures.</p> <p>NOTE 2 – Supported by the DCE for PVC management procedures. Supported by the DTE for bidirectional procedures.</p> <p>NOTE 3 – T392 should be less than or equal to T391.</p>							

12 Congestion control

12.1 General

Under normal operation, the DCE should be able to receive data transmitted from individual DTEs at the user data transfer rate (i.e., the access rate of the physical subscriber lines) and transfer that data with a minimum delay to a remote DTE. However, when the DCE is suffering from mild congestion, the frames received from individual DTEs cannot be forwarded immediately and are instead stored in buffers for a short time before transmission to the remote DTE, thus resulting in an increased of the end-to-end frame transfer delay.

If the network congestion worsens to the point where the network can no longer transmit user frames at the rate with which they are being transmitted by the DTE, the frames thus stored in buffers will cause the buffers to overflow, causing the overflow frames to be discarded.

Users can avoid this congestion from occurring and prevent their data frames from being discarded by reducing their transmitting data rate into the network to the CIR (as defined at subscription time) in response to congestion notifications from the network. It is for this reason that it is necessary to consider factors such as total CIR rate for all VC services accommodated on the network, the percentage of usage allocated to data transmission and reception for each link, and the ratio of this usage percentage to the rate of the physical lines when setting the capacity specifications for VC services.

To guarantee the quality of FRDTS network services, it is first necessary to ensure that the percentage of frames discarded during normal operation stays below a certain level. And while it is not possible to guarantee the same level of reliability at times of congestion, it is necessary to ensure that the percentage of frames discarded stays below the level needed to accommodate minimum levels of communications. In case of severer congestion, data transmission service must be stopped in order to recover network resources, and it will be impossible to ensure the data transmission.

Figure 12-1 shows the relation between the level of congestion on the network and the throughput for user-transmitted data. Here it can be seen that at times of congestion the discarding of frames and subsequent retransmission of user frames leads to decreased overall throughput.

Region I of Figure 12-1 indicates the throughput of the network during normal condition, Region II indicates its condition at times of mild congestion and Region III its condition at times of severe congestion.

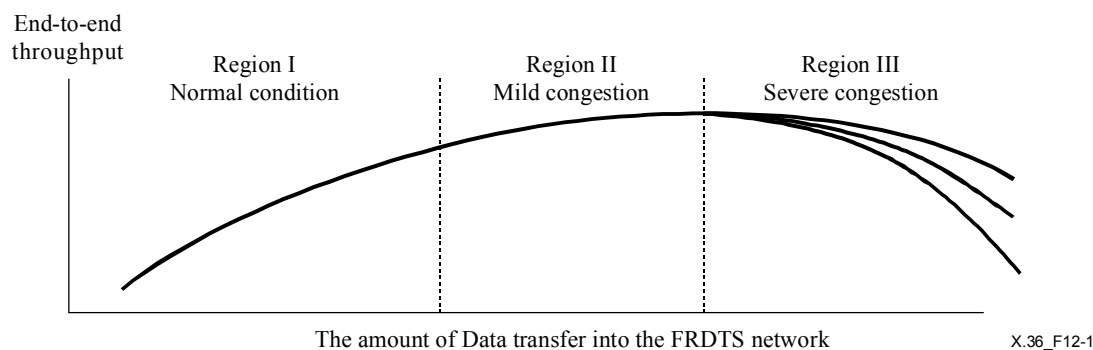

Figure 12-1/X.36 – Relation between network congestion and throughput

12.2 Impact of congestion

At the onset of mild congestion, the network must implement procedures to detect congestion, notify the DTEs, and where possible control excess traffic so as to avoid as far as possible the actual discarding of frames. The network should send messages explicitly notifying DTEs that congestion exists within the network. DTEs should respond to such messages by reducing traffic transmitted to the network, thus allowing the network to recover from congestion.

In times of congestion, networks will generally discard those frames marked as Discard Eligible (DE) in preference to other traffic. However, networks may discard any frames at any time to protect themselves from congestion collapse. The only method of controlling the traffic from DTEs which do not respond to congestion notification is to discard frames.

12.3 Congestion notification

When the network detects a state of congestion, it may set to 1 the FECN and/or BECN bits in frames transmitted to the concerned DTEs (see Figure 12-2). Some networks may also send a CLLM message to the concerned DTEs (see Annex C).

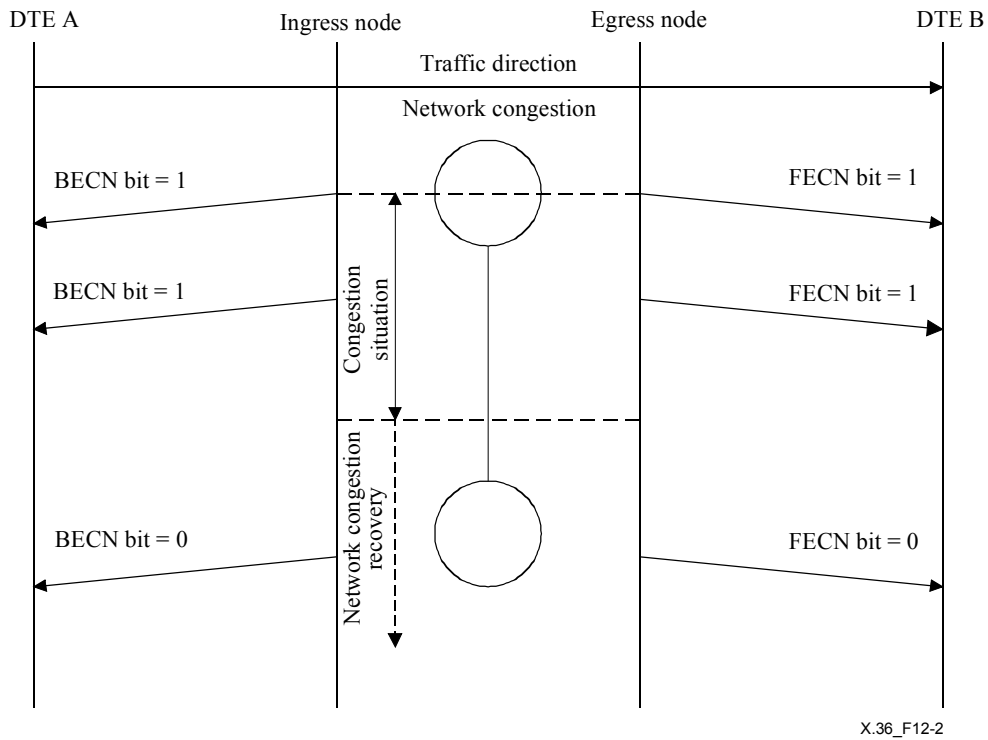

Figure 12-2/X.36 – Network congestion notification

12.3.1 Forward explicit congestion notification

Notification in the same direction as the traffic causing the network to congestion is called forward explicit congestion notification. The network sets the FECN bit "1" within the address field of the frame passing the congested node to inform the receiving user of the network congestion (see Figure 12-3).

Note that FECN bit may be set by the DTE to notify the network and/or the remote DTE.

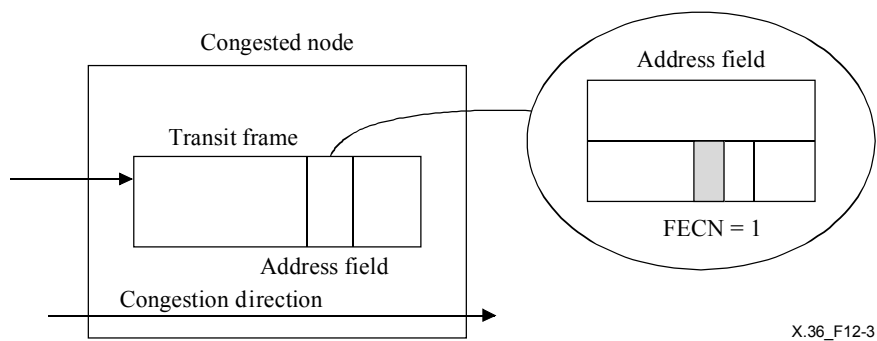

Figure 12-3/X.36 – Congestion notification using FECN bit

12.3.2 Backward explicit congestion notification

Notification in the reverse direction of the traffic causing network congestion is called backward explicit congestion notification. The network sets the BECN bit "1" within the address field of the frame passing the congested node to inform the receiving DTE of network congestion (see Figure 12-4).

Note that the BECN bit may be set by the DTE to notify the network and/or the remote DTE.

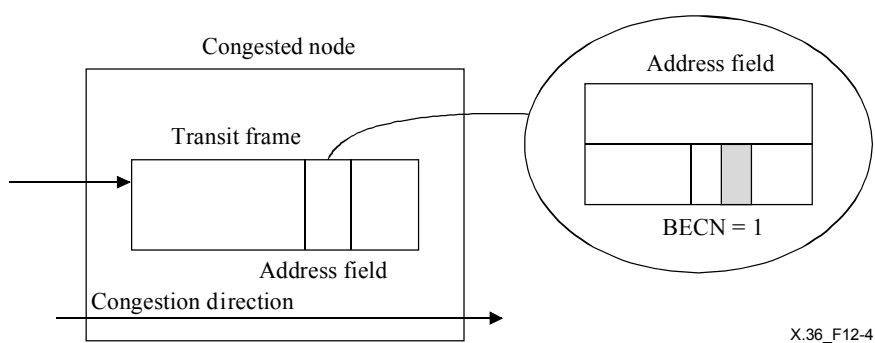

Figure 12-4/X.36 – Congestion notification using BECN bit

12.4 DTE congestion detection method and actions

Appendix II gives guidance on the methods that the DTE may use to detect and react to the network congestion.

Annex A

List and status of the X.36 parameters

Table A.1 gives the list of parameters for a frame relay DTE/DCE interface. The column "DTE" indicates whether this parameter has to be supported by the DTE for proper operations. The column "DCE" indicates whether the parameters must be supported by all networks complying with this Recommendation. When both the DTE and the DCE use the parameter for a given PVC or DTE/DCE interface, the next column indicates whether the DTE value should be the same as the DCE value. The last column indicates whether the parameter is defined per DTE/DCE interface or per PVC.

When a parameter is supported by the network, the user may select the value at subscription time among these supported by the network.

Table A.1/X.36 – List of configurable parameters for a DTE/DCE interface

Counter/ Timer/ Parameter	Reference	DTE	DCE	Same value required for DTE and DCE	Significance
AR	8.2.1	Mandatory	Mandatory	Yes	Per interface
Support of DTE/DCE fragmentation	9.6	Optional	Optional	Yes	Per interface
Fragment size	9.6	Optional	Optional	Yes	Per interface
DLCI	9.3.3.6	Mandatory	Mandatory	Yes	Per PVC
CIR	8.2.4	Optional	Mandatory	Yes	Per PVC for each direction
Bc	8.2.2	Optional	Mandatory	Yes	Per PVC for each direction
Be	8.2.3	Optional	Mandatory	Yes	Per PVC for each direction
Tc (when CIR = 0)	8.2.5	Optional	Mandatory	Yes	Per PVC for each direction

Table A.1/X.36 – List of configurable parameters for a DTE/DCE interface

Counter/ Timer/ Parameter	Reference	DTE	DCE	Same value required for DTE and DCE	Significance
N203	8.2.6	Mandatory	Mandatory	Yes	Per PVC for each direction
Frame Transfer priority	7.4 and 10.15	Optional	Optional	Yes	Per PVC for each direction
Frame Discard priority	7.5 and 10.16	Optional	Optional	Yes	Per PVC for each direction
Service Class	7.6 and 10.17	Optional	Optional	Yes	Per PVC
Support of PVC management	11	Optional	Mandatory	Yes	Per interface
N391	11.6	Mandatory	Not applicable	Not applicable	Per interface
N392	11.6	Mandatory	Mandatory	Advisable	Per interface
N393	11.6	Mandatory	Mandatory	Advisable	Per interface
T391	11.6	Mandatory	Not applicable	Not applicable	Per interface
T392	11.6	Not applicable	Mandatory	Not applicable	Per interface
Support of PVC bidirectional procedure	11.5	Optional	Optional	Yes	Per interface
T391	11.6	Mandatory	Not applicable	Not applicable	Per interface
T392	11.6	Not applicable	Mandatory	Not applicable	Per interface
Support of PVC bidirectional procedure	11.5	Optional	Optional	Yes	Per interface
N391 (second set)	11.5	Not applicable	Mandatory	Not applicable	Per interface
N392 (second set)	11.5	Mandatory	Mandatory	Advisable	Per interface
N393 (second set)	11.5	Mandatory	Mandatory	Advisable	Per interface
T391 (second set)	11.5	Not applicable	Mandatory	Not applicable	Per interface
T392 (second set)	11.5	Mandatory	Not applicable	Not applicable	Per interface
Support of asynchronous PVC status message	11.4.2	Optional	Optional	Advisable	Per interface
Support of segmentation of Status message	Annex G	Optional	Optional	Yes	Per interface
Support of CLLM message	Annex C	Optional	Optional	Yes	Per interface
Tx	C.5.4	Not applicable	Mandatory	Not applicable	Per interface
Ty	C.5.4	Mandatory	Not applicable	Not applicable	Per interface

Table A.1/X.36 – List of configurable parameters for a DTE/DCE interface

Counter/ Timer/ Parameter	Reference	DTE	DCE	Same value required for DTE and DCE	Significance
Support of SVC	10	Optional	Optional	Yes	Per interface
T200	10.3	Mandatory	Mandatory	Advisable	Per interface
T203	10.3	Mandatory	Mandatory	Advisable	Per interface
N200	10.3	Mandatory	Mandatory	Advisable	Per interface
k	10.3	Mandatory	Mandatory	Advisable	Per interface
N201	10.3	Mandatory	Mandatory	Yes	Per interface
T303	10.11.1 and 10.11.2	Mandatory	Mandatory	Advisable	Per interface
T305	10.11.1 and 10.11.2	Mandatory	Mandatory	Advisable	Per interface
T308	10.11.1 and 10.11.2	Mandatory	Mandatory	Advisable	Per interface
T310	10.11.1 and 10.11.2	Mandatory	Mandatory	Advisable	Per interface
T316	10.11.1 and 10.11.2	Mandatory	Mandatory	Advisable	Per interface
T317	10.11.1 and 10.11.2	Optional	Optional	Advisable	Per interface
T322	10.11.1 and 10.11.2	Optional	Optional	Advisable	Per interface
DTE address	8.3.1	Optional	Mandatory	Yes	Per interface
Max. number of SVCs	8.3.2	Optional	Mandatory	Yes	Per interface
Default Outgoing CIR	8.3.3 and 10.6.15	Not applicable	Mandatory	Not applicable	Per interface
Default Incoming CIR	8.3.3 and 10.6.15	Not applicable	Optional	Not applicable	Per interface
Default minimum outgoing CIR	8.3.3 and 10.6.15	Not applicable	Mandatory	Not applicable	Per interface
Default minimum incoming CIR	8.3.3 and 10.6.15	Not applicable	Optional	Not applicable	Per interface
Default outgoing Bc	8.3.3 and 10.6.15	Not applicable	Mandatory	Not applicable	Per interface
Default incoming Bc	8.3.3 and 10.6.15	Not applicable	Optional	Not applicable	Per interface
Default outgoing Be	8.3.3 and 10.6.15	Not applicable	Mandatory	Not applicable	Per interface
Default incoming Be	8.3.3 and 10.6.15	Not applicable	Optional	Not applicable	Per interface

Table A.1/X.36 – List of configurable parameters for a DTE/DCE interface

Counter/ Timer/ Parameter	Reference	DTE	DCE	Same value required for DTE and DCE	Significance
Simple CUG	8.3.4 and 10.12	Optional	Optional	Yes	Per interface
CUG selection	8.3.4 and 10.12	Optional	Optional	Yes	Per interface
CUG + Outgoing access	8.3.4 and 10.12	Optional	Optional	Yes	Per interface
CUG + Incoming access	8.3.4 and 10.12	Optional	Optional	Yes	Per interface
CUG administrative identifiers and corresponding indexes	8.3.4 and 10.12	Optional	Optional	Yes	Per interface
Reverse charging prevention	8.3.5 and 10.14	Not applicable	Optional	Not applicable	Per interface
Default Outgoing Frame Transfer priority	8.3.6 and 10.6.18	Not applicable	Optional	Not applicable	Per interface
Default Incoming Frame Transfer priority	8.3.6 and 10.6.18	Not applicable	Optional	Not applicable	Per interface
Default Outgoing Frame Discard priority	8.3.6 and 10.6.18	Not applicable	Optional	Not applicable	Per interface
Default Incoming Frame Discard priority	8.3.6 and 10.6.18	Not applicable	Optional	Not applicable	Per interface
Priority versus Service Class parameter	8.3.7 and 10.18	Not applicable	Optional	Not applicable	Per interface

Annex B

Functional support at the DTE/DCE interface

B.1 Protocol Capabilities (PC)

The Protocol Capabilities support mandatory/optional are defined in Table B.1.

Table B.1/X.36 – Protocol Capability (PC)

Index	Protocol features	Reference	Support status	
			DTE	DCE
Transmission features				
PC1	STATUS ENQUIRY transmit	11.2	Optional	Optional
PC2	STATUS answer	11.2	Optional	Mandatory
PC3	Asynchronous STATUS message transmit	11.6	Optional	Optional
PC4	2-octet address field support and transmit	9.3.2	Mandatory	Mandatory
PC5	3-octet address field support and transmit	9.3.2	Optional	Optional
PC6	4-octet address field support and transmit	9.3.2	Optional	Optional
PC7	Ability to set FECN bit to 1	9.3.3.3	Optional	Optional
PC8	Ability to set BECN bit to 1	9.3.3.4	Optional	Optional
PC9	Ability to set DE bit to 1	9.3.3.5	Optional	Optional
PC10	CLLM message transmit	Annex C	Not applicable	Not applicable
Reception features				
PC11	STATUS ENQUIRY receive	11.2	Optional	Mandatory
PC12	STATUS receive	11.2	Optional	Optional
PC13	Asynchronous STATUS message receive	11.6	Optional	Optional
PC14	2-octet address field support and receive	9.3.2	Mandatory	Mandatory
PC15	3-octet address field support and receive	9.3.2	Optional	Optional
PC16	4-octet address field support and receive	9.3.2	Optional	Optional
PC17	Transparency to FECN bit set to 1	9.3.3.3	Not applicable	Mandatory
PC18	Transparency to BECN bit set to 1	9.3.3.4	Not applicable	Mandatory
PC19	Transparency to DE bit set to 1	9.3.3.5	Not applicable	Mandatory
PC20	CLLM message receive	Annex C	Optional	Optional

B.2 Frames protocol data units (FR)

The Protocol data units support mandatory/optional are defined in Table B.2.

Table B.2/X.36 – Protocol data units (FR)

Index	Protocol features	Reference	Support status	
			DTE	DCE
Common features				
FR1	All frames start and end with a flag	9.2.1	Mandatory	Mandatory
FR2	Address field default of two octets	9.3.2	Mandatory	Mandatory
FR3	Address field extended to three octets	9.3.2	Optional	Optional
FR4	Address field extended to four octets	9.3.2	Optional	Optional
FR5	Field mapping convention (lowest bit number represents the lowest order value)	9.2.1	Mandatory	Mandatory
Transmitting features				
FR6	Generate a single flag (the closing flag is also the open flag)	9.2.1	Optional	Optional
FR7	Transparency (insertion of a "0" bit after five "1" bits)	9.4.2	Mandatory	Mandatory
FR8	Order of bit transmission	9.4.1	Mandatory	Mandatory
FR9	FCS field of transmit	9.2.4	Mandatory	Mandatory
FR10	Interframe fill with flag sequence	9.4.3	Mandatory	Mandatory
Reception features				
FR11	Accept the closing flag as the open flag of the next frame	9.2.1	Mandatory	Mandatory
FR12	Transparency (discard an "0" bit after five "1" bits)	9.4.1	Mandatory	Mandatory
FR13	Order of bit of receiving	9.4.1	Mandatory	Mandatory
FR14	FCS field receiving	9.2.4	Mandatory	Mandatory
FR15	Ability to receive continuous flags as interframe fill	9.4.3	Mandatory	Mandatory
FR16	Discard invalid frames	9.4.4	Mandatory	Mandatory

B.3 System Parameters (SP)

System Parameters support mandatory/optional are defined in Table A.1.

Annex C

Consolidated Link Layer Management (CLLM) message

The consolidated link layer management message is based on ISO/IEC 8885 definition of XID frames for transport function information. The use of the CLLM messages is optional for both the DTE and the DCE. The frame format for the CLLM message is as shown in Figure C.1.

Each parameter is described using the sequence type-length-value. The following clauses describe the functional fields for the consolidated link layer management message. The CLLM message may be transmitted whenever congestion control procedure is being performed as a result of network congestion, line or equipment failure or the performance of maintenance functions. All fields are binary encoded unless otherwise specified.

	87654321	
1	11111010	Address Octet 1
2	11110001	Address Octet 2
3	10101111	XID Control Field
4	10000010	Format Identifier (130)
5	00001111	Group Identifier = 15
6		Group Length Octet 1
7		Group Length Octet 2
8	00000000	Parameter identifier = 0
9	00000100	Parameter Length (4)
10	01101001	Parameter value = 105 (IA5 coded 1)
11	00110001	Parameter value = 49 (IA5 coded 1)
12	00110010	Parameter value = 50 (IA5 coded 2)
13	00110010	Parameter value = 50 (IA5 coded 2)
14	00000010	Parameter identifier = 2 (cause id)
15	00000001	Parameter length = 1
16		Cause value
17	00000011	Parameter Identifier = 3 (DLCI identifier)
18		Parameter Length
19	.	DLCI value Octet 1 (1st)
20	.	DLCI value Octet 2 (1st)
.		
.		
2n + 17		DLCI value Octet 1 (nth)
2n + 18		DLCI value Octet 2 (nth)
2n + 19		FCS octet 1
2n + 20		FCS octet 2

Figure C.1/X.36 – 2 octets address field CLLM message format

C.1 Address octets

This annex supports only address fields with a length of 2 octets. Further study is required for support of address fields with a length of 4 octets.

Since the length of the address field is set at 2 octets, the 6 high-order bits from the 8th to the 3rd bit within the first octet are reserved for the first 6 bits of the DLCI, while the 4 high-order bits of the second octet from the 8th to the 5th bit are reserved for the 4 low-order bits of the DLCI. Note that CLLM messages are classified as maintenance frames within the network, and they must be coded with a decimal value of DLCI = 1007 or to its binary equivalent of DLCI = 1111101111.

The second bit within the first octet is the Command/Response (C/R) bit, used to indicate whether the frame is a command or a response. As the CLLM message is an XID response frame, this must be coded with a value of R = 1. FECN, BECN and DE bits are not used, must be set to 0 upon transmission and must not be interpreted upon reception.

C.2 Control field

Octet 3 contains the control field code point for this type of message. This presents the control field for XID with a binary value of '10101111'.

C.3 XID information field

C.3.1 Format identifier field

Octet 4 contains the format identifier field. The format identifier field is defined by ISO/IEC 8885 to have a length of 1 octet. The general purpose format identifier is assigned the decimal value 130.

C.3.2 Group field

C.3.2.1 Group identifier field

Octet 5 contains the group identifier field. The group identifier field is decimal 15, which is assigned by ISO/IEC 8885 to indicate private parameters.

C.3.2.2 Group length field

Octets 6 and 7 contain the group length field. This 16-bit field describes the "length" of the octets in the remainder of the group field. The maximum value of the group length field is 1595 (= 1600 (Maximum length of frame information field) – 5 (CLLM message overhead)).

C.3.2.3 Group value field

The group value field consists of two or more parameter fields. The parameter set identification (with a parameter value 0) identifies the set of private parameters within the group field per ISO/IEC 8885 as an identifier to determine. The other parameters shall appear in the following order: cause identifier and then DLCI identifier.

C.3.3 Parameter set identification parameter

The parameter set identification parameter shall always be present; otherwise the CLLM message is ignored.

C.3.3.1 Parameter set identification field

Octet 8 contains the parameter identification field for the first parameter, and is set to 0 per ISO/IEC 8885. Parameter 0 identifies the set of private parameters within this group.

C.3.3.2 Parameter set identification length field

Octet 9 contains the length of the parameter 0 and is set to a binary value of '100' (i.e., a decimal value of 4).

C.3.3.3 Parameter value field

Octets 10 to 13 identify that this usage of the XID frame private parameter group is for I.122 private parameters.

Octet 10 contains the IA5 value of 'I' (decimal 105).

Octet 11 contains the IA5 value of '1' (decimal 49).

Octets 12 and 13 each contain the IA5 value for '2' (decimal 50).

C.3.4 Cause identifier parameter field

The cause identifier is required, and the frame is ignored if the cause identifier parameter field is not included within the CLLM message.

C.3.4.1 Parameter identifier field

Octet 14 contains the cause identifier field. The parameter identifier field is set to 2.

C.3.4.2 Parameter length field

Octet 15 contains the length of the cause identifier. This shall be set to binary "1".

C.3.4.3 Cause value

Octet 16 contains the cause value. This octet identifies the cause of this message as determined by the congested network node whose layer management module originated the message. The value for the cause set here is set to indicate the network status of the layer management entity issuing this message (e.g., congestion, failure, or maintenance operation). The values which may be coded in this field are shown in Table C.1.

The CLLM message shall not be ignored because of an unknown cause value.

NOTE – Cause values shall be coded as "short term" if the CLLM is sent due to a transient condition (e.g., one anticipated to have a duration on the order of seconds or minutes); otherwise, they shall be coded as "long term". Usage shall be network specific.

Table C.1/X.36 – Codes for Cause of CLLM message

Bits	Cause
87654321	
00000010	Network congestion due to excessive traffic – short term
00000011	Network congestion due to excessive traffic – long term
00000110	Facility or equipment failure – short term
00000111	Facility or equipment failure – long term
00001010	Maintenance action – short term
00001011	Maintenance action – long term
00010000	Unknown – short term
00010001	Unknown – long term
	All other values are reserved

C.3.5 DLCI identifier parameter field

DLCI identifier parameter fields are used to determine the DLCI corresponding to the cause listed in the CLLM messages listed above. If the DLCI identifier is missing, then the frame shall be ignored.

C.3.5.1 Parameter identifier field

Octet 17 contains the parameter identifier field. When the parameter identifier field is set to 3, the following octets of this parameter contain the DLCI(s) of the frame relay connection(s) that are congested.

C.3.5.2 Parameter length field

Octet 18 contains the length of DLCI(s) being reported, in octets. For example, if (n) DLCIs are being reported and they are of length two octets each, this will be 2 times (n) in octet size.

C.3.5.3 Parameter value field

Octet 19 through to the FCS octets contain the DLCI value(s) which identify logical link(s) that have encountered a congested state. The DLCI field is 10 bits long and contained in bits 8 to 3 of the first octet pair and bits 8 to 5 of the next octet of the pair. The bit 8 of the first octet is the most significant bit and bit 5 of the second octet is the least significant. The bits 2 to 1 in the first octet and bits 4 to 1 in the second octet are reserved.

87654321

xxxxxx**

Octet 1 The high-order 6 bits of the DLCI are stored in the bits marked 'xxxxxx'.

xxxx**** Octet 2 The low-order 4 bits of the DLCI are stored in the bits marked 'xxxx'.

The bits marked with asterisks (*) are reserved for later use.

C.4 FCS field

The last two octets of the frame contain the frame check sequence field.

C.5 Network CLLM message transmission procedure

The network transmits a CLLM message whenever it is unable to successfully transmit traffic from the DTE as a result of equipment failure or the congestion of resources due to excessive levels of traffic, thus informing the DTE of the network status. The purpose of sending a CLLM message is to request the DTE to reduce the overall amount of traffic.

C.5.1 Network congestion

When the network encounters resource congestion as a result of excessive levels of the DTE traffic and the level of traffic continues at these high levels, the network may be forced to discard traffic or bring the system to a halt for recovery. By sending a CLLM message to the DTE indicating the cause underlying the congestion, the network informs the DTE of the possibility of such action being taken. Note that since CLLM messages generated at times of congestion are intended only for providing notification in the opposite direction to that of the traffic causing the congestion, they are sent only in the opposite direction to the traffic congestion direction (see Figure C.3). CLLM messages may signal a congestion to the transmitting DTE when there is no traffic in the reverse direction.

C.5.1.1 Mild network congestion

When the status of network buffers and resources cause the network to fall into a state of mild congestion (as defined in 12.1), the network sends a message to the DTE informing it of the congestion and requiring it to restrict the traffic submitted to the network so that the network can recover before it becomes necessary to discard excess traffic.

C.5.1.2 Severe network congestion

When the status of network buffers and resources cause the network to fall into a state of severe congestion (as defined in 12.1), the network becomes unable to function without discarding traffic and accordingly sends a CLLM message to the DTE informing the DTE of the congestion and its cause while simultaneously discarding the excess traffic. Doing this enables the network to recover its resources and prepare for recovery to normal working status. Having received notice from the network of the discarding of traffic, the DTE should restrain from generating further traffic or halt operation to allow the network to recover. The CLLM message is sent by the network to inform the DTE that a possibility exists of its traffic being discarded.

C.5.2 Network failure

When an equipment failure or line fault occurs in the network, a code indicating the cause underlying the failure or error is stored in a CLLM message and transmitted to the DTE. When the DTE receives this failure message, it will recognize that a failure has occurred within the network and is required to halt the transmission of all traffic over the FR connection in question.

C.5.3 Notification of network maintenance action

When the network undergoes a continued period of severe congestion to the point where it adversely affects the operation of the network equipment or where the common network resources are overloaded by traffic from a specific DTE, and the network thus becomes unable to continue providing normal communications quality as specified by contract for low-traffic DTEs (e.g., DTEs

communicating over links at volumes within the specified value for the CIR), the network may halt for short periods of time transmissions over high-traffic links, with those links with the highest level of traffic being given top priority for the halting of operation. The network will then transmit a CLLM message indicating the cause for the link stoppage to the link for which communications have been halted to inform the DTE of the action taken.

C.5.4 Recovery from cause given in the CLLM message

NOTE – These recovery procedures do not exist in the present text of ITU-T Rec. Q.922 (1992).

When the DCE has transmitted a CLLM message for a given set of DLCIs, it must transmit a CLLM message each Tx period, as long as the cause is valid for at least one DLCI. When the DTE receives a CLLM message with the same cause as the previous one, but with modifications in the list of DLCIs, it should consider that the CLLM message cause is no longer valid for the connections corresponding to the missing DLCIs. Every time the DTE receives a CLLM message, it should start or restart a Ty timer. When this timer expires the DTE should consider that the CLLM message cause is no longer valid for all the DLCIs (see Table C.2 and Figures C.2 and C.3).

Table C.2/X.36 – CLLM timers

Timer	Description	Range	Default (seconds)	Started when	Actions taken when expired
Tx (DCE)	CLLM message send interval timer	5-30	10	Transmit CLLM message	Repeat CLLM if the cause is still valid
Ty (DTE) (Note)	CLLM message recovery timer	5-30	11	Receive CLLM message	Consider the cause no longer valid

NOTE – Ty should be greater than Tx.

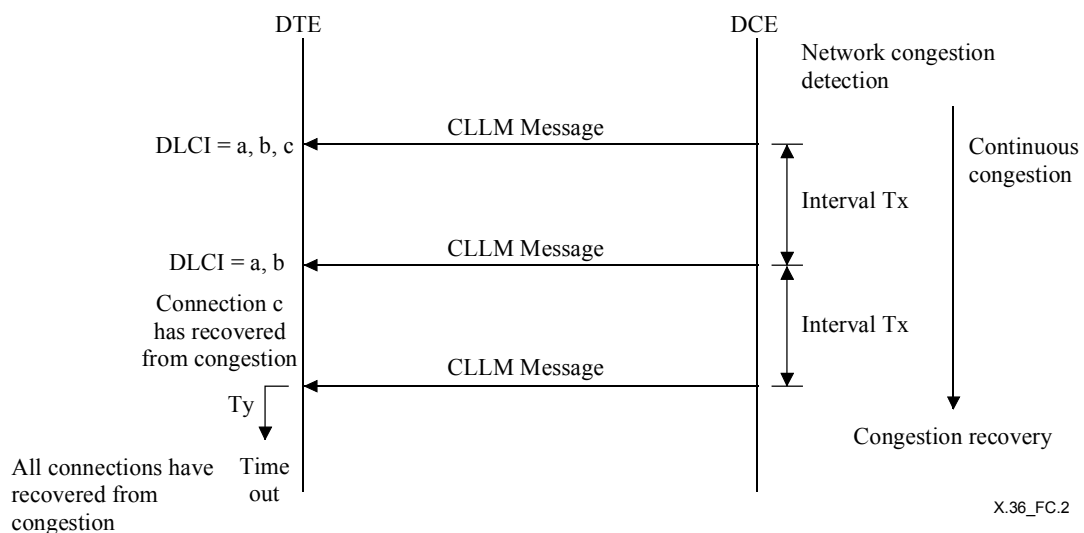
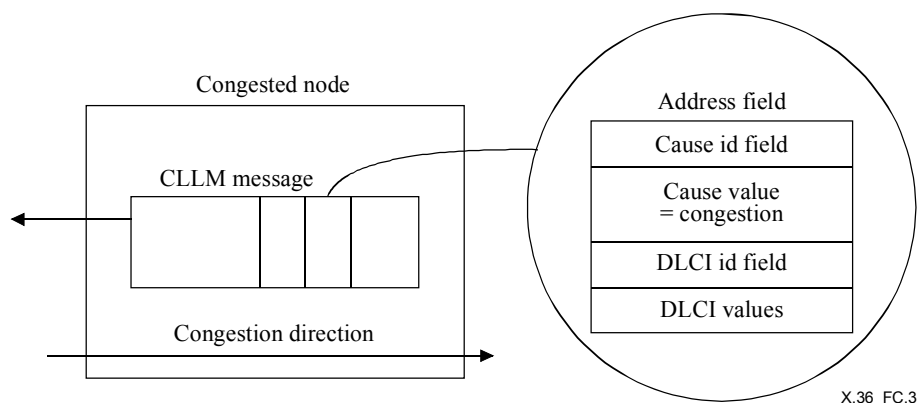

Figure C.2/X.36 – CLLM message send sequence



X.36_FC.3

NOTE – Timer recovery from cause of CLLM message is a new procedure which needs further study by ITU-T.

Figure C.3/X.36 – Congestion notification using CLLM message

Annex D

Use of frame relay for multiprotocol encapsulation

This annex provides guidance when using frame relay for the encapsulation of multiple protocols. Multi-protocol encapsulation provides a flexible method for carrying several protocols on a given frame relay connection. The use of these procedures is optional.

Guidance is also provided on using frame relay for the encapsulation of multiple protocols. Encapsulation procedures shall be used only on PVCs that have been explicitly configured for its use or on SVCs that are established with multiprotocol encapsulation specified during call set-up.

D.1 General frame format

The format used for multiprotocol encapsulation is described in Figure D.1. It follows the frame format defined in Figure 9-1.

8	7	6	5	4	3	2	1	Octet
Flag								1
Address field first octet				(Note)				2
Address field second octet								3
Control field of UI frame = Hexadecimal 03								4
Optional PAD = Hexadecimal 00								5
Protocol Identifier								6
Encapsulated PDU								.
								.
								.
								N – 3
Frame Check Sequence first octet								N – 2
Frame Check Sequence second octet								N – 1
Flag								N

NOTE – The default address field length is 2 octets. It may be extended to 4 octets.

Figure D.1/X.36 – Frame format for multiprotocol encapsulation with 2 octets address

The first octet in the information field is the control field of a UI frame with P bit set to 0.

An optional PAD field is used to align the remainder of the frame to a two-octet boundary. There may be zero or one pad octet within the pad field and, if present, must have a value of zero.

The protocol identifier field is used to identify the protocol whose PDU is encapsulated in the remainder of the information field.

The network layer protocol identifiers are defined in ITU-T Rec. X.263 | ISO/IEC TR 9577. All users of this Recommendation are encouraged to investigate the possibility of applying the most recent edition of ITU-T Rec. X.263 | ISO/IEC TR 9577. Note that when the code point 80 Hexadecimal (for IEEE SNAP (Subnetwork Access Protocols) convention) is used, the protocol identifier octet is extended to six: three additional for the Organizationally Unique Identifier (OUI) and two additional for the protocol identifier. These additional five octets are inserted after the protocol identifier octet and before the encapsulated PDU.

An NLPID value of hexadecimal 00 is invalid for multiprotocol encapsulation in frame relay frames since this value cannot be distinguished from a pad field.

If a protocol can be encapsulated in more than one multiprotocol header format, the first format from the list below, which provides a code point for the protocol, shall be used:

- 1) Direct NLPID – Protocols for which a NLPID value is defined in ITU-T Rec. X.263 | ISO/IEC TR 9577; e.g., IP, CLNP (ISO/IEC 8473) and ISO/IEC 8208.
- 2) SNAP encapsulation – Using SNAP NLPID followed by SNAP, e.g., LAN bridging and connectionless protocols which have a SNAP value.
- 3) NLPID followed by four octets indicating layer 2 and layer 3 identifications, i.e., connection-oriented protocols and other protocols which cannot be supported by the other two methods.

D.2 Frame format for ISO CLNP (ISO/IEC 8473)

The format used for encapsulation of ISO CLNP is described in Figure D.2. The protocol identifier is set to hexadecimal 81.

Note that in the case of ISO CLNP, the protocol identifier is also considered part of the CLNP unit data PDU and as such, it shall be retained.

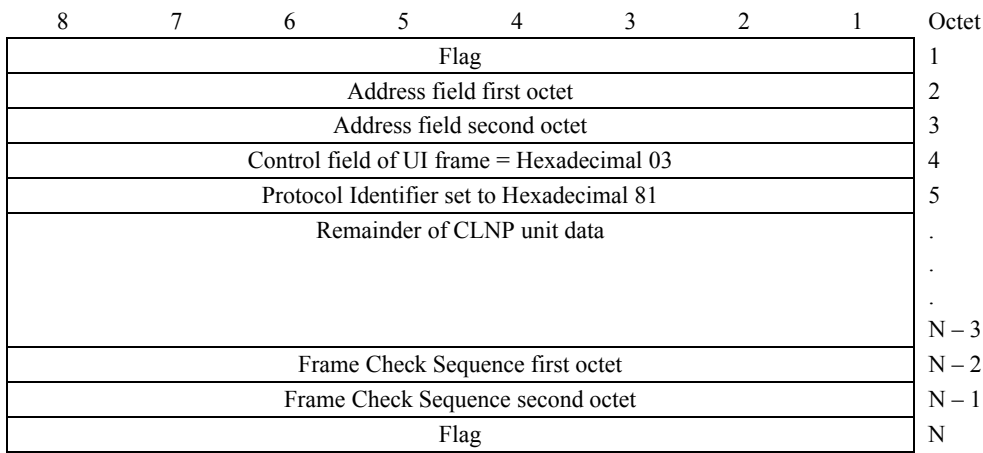

Figure D.2/X.36 – Encapsulation of CLNP (ISO/IEC 8473) unit data PDU

D.3 Frame format for IP

The format used for encapsulation of IP datagrams is described in Figure D.3. The protocol identifier is set to hexadecimal CC.

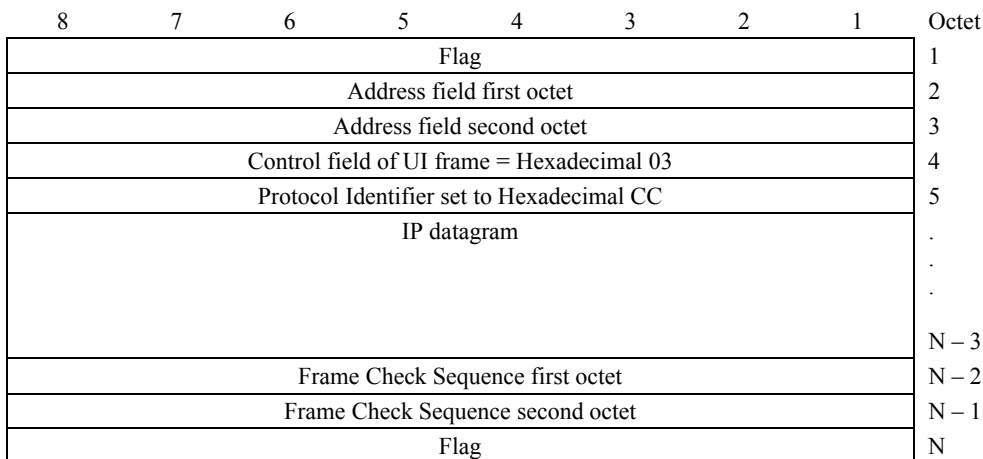

Figure D.3/X.36 – Encapsulation of an IP datagram

D.4 Frame format for protocols with Ethertype code point

Some connectionless protocols do not have an assigned protocol identifier code point in ITU-T Rec. X.263 | ISO/IEC TR 9577 (second edition), but have an Ethertype code point assigned.

The format used for encapsulation of PDUs of such protocols is described in Figure D.4.

The protocol identifier is set to hexadecimal 80 indicating the use of the SNAP convention. The OUI value used for this encapsulation is set to hexadecimal 00-00-00 indicating that the following two octets (PID) contain an Ethertype code point.

8	7	6	5	4	3	2	1	Octet
Flag								1
Address field first octet								2
Address field second octet								3
Control field of UI frame = Hexadecimal 03								4
PAD = Hexadecimal 00								5
Protocol Identifier set to hexadecimal 80								6
OUI first octet set to hexadecimal 00								7
OUI second octet set to hexadecimal 00								8
OUI third octet set to hexadecimal 00								9
Ethertype first octet								10
Ethertype second octet								11
Encapsulated PDU								.
								.
								.
Frame Check Sequence first octet								N – 3
Frame Check Sequence second octet								N – 2
Flag								N – 1
								N

Figure D.4/X.36 – Encapsulation of protocol identified through Ethertype

D.5 Frame format for bridged packets

The protocol identifier is set to hexadecimal 80 indicating the use of the SNAP convention. The OUI value used for this encapsulation is the IEEE 802.1 organization code hexadecimal 00 80 C2. The following two octets (PID) specify the form of the MAC header. Additionally, the PID indicates whether the original FCS is preserved within the bridged packet. Table D.1 provides the values of the PID to be used with multiprotocol encapsulation over Frame Relay.

NOTE – In addition, the PID value hexadecimal 00 0E identifies bridged protocol data units (Bridged PDUs) as defined by 802.1 (d) or 802.1 (g) (see IEEE, "IEEE Standard for local and Metropolitan Networks: Media Access Control (MAC) Bridges", IEEE Standard 802.1D 1990). The PID value hexadecimal 00 0F identifies source routing Bridged PDU.

Table D.1/X.36 – PID values for OUI hexadecimal 00 80 C2

With preserved FCS (Hexadecimal)	Without preserved FCS (Hexadecimal)	Media
00 01	00 07	802.3
00 02	00 08	802.4
00 03	00 09	802.5
00 04	00 0A	FDDI
	00 0B	802.6

D.5.1 Frame format for bridged 802.3 frame

The format used for encapsulation of bridged 802.3 frame is described in Figure D.5.

8	7	6	5	4	3	2	1	Octet
Flag								1
Address field first octet								2
Address field second octet								3
Control field of UI frame = Hexadecimal 03								4
PAD = Hexadecimal 00								5
Protocol Identifier set to hexadecimal 80								6
OUI first octet set to hexadecimal 00								7
OUI second octet set to hexadecimal 80								8
OUI third octet set to hexadecimal C2								9
PID first octet set to hexadecimal 00								10
PID second octet set to hexadecimal 01 or 07								11
MAC destination address (Remainder of the MAC frame)								12
LAN FCS (If PID second octet is set to hexadecimal 01) (4 octets)								.
								.
								N – 3
Frame Check Sequence first octet								N – 2
Frame Check Sequence second octet								N – 1
Flag								N

Figure D.5/X.36 – Encapsulation of bridged 802.3 frame

D.5.2 Frame format for bridged 802.4 frame

The format used for encapsulation of bridged 802.4 frame is described in Figure D.6.

8	7	6	5	4	3	2	1	Octet
Flag								1
Address field first octet								2
Address field second octet								3
Control field of UI frame = Hexadecimal 03								4
PAD = Hexadecimal 00								5
Protocol Identifier set to hexadecimal 80								6
OUI first octet set to hexadecimal 00								7
OUI second octet set to hexadecimal 80								8
OUI third octet set to hexadecimal C2								9
PID first octet set to hexadecimal 00								10
PID second octet set to hexadecimal 02 or 08								11
PAD = Hexadecimal 00								12
Frame Control								13
MAC destination address (Remainder of the MAC frame)								14
LAN FCS (If PID second octet is set to hexadecimal 02) (4 octets)								.
								.
								N – 3
Frame Check Sequence first octet								N – 2
Frame Check Sequence second octet								N – 1
Flag								N

Figure D.6/X.36 – Encapsulation of bridged 802.4 frame

D.5.3 Frame format for bridged 802.5 frame

The format used for encapsulation of bridged 802.5 frame is described in Figure D.7.

8	7	6	5	4	3	2	1	Octet
Flag								1
Address field first octet								2
Address field second octet								3
Control field of UI frame = Hexadecimal 03								4
PAD = Hexadecimal 00								5
Protocol Identifier set to hexadecimal 80								6
OUI first octet set to hexadecimal 00								7
OUI second octet set to hexadecimal 80								8
OUI third octet set to hexadecimal C2								9
PID first octet set to hexadecimal 00								10
PID second octet set to hexadecimal 03 or 09								11
PAD = Hexadecimal 00								12
Frame Control								13
MAC destination address (Remainder of the MAC frame)								14
LAN FCS (If PID second octet is set to hexadecimal 03) (4 octets)								.
								.
								.
								N – 3
Frame Check Sequence first octet								N – 2
Frame Check Sequence second octet								N – 1
Flag								N

Figure D.7/X.36 – Encapsulation of bridged 802.5 frame

D.5.4 Frame format for bridged FDDI frame

The format used for encapsulation of bridged FDDI frame is described in Figure D.8.

8	7	6	5	4	3	2	1	Octet
Flag								1
Address field first octet								2
Address field second octet								3
Control field of UI frame = Hexadecimal 03								4
PAD = Hexadecimal 00								5
Protocol Identifier set to hexadecimal 80								6
OUI first octet set to hexadecimal 00								7
OUI second octet set to hexadecimal 80								8
OUI third octet set to hexadecimal C2								9
PID first octet set to hexadecimal 00								10
PID second octet set to hexadecimal 04 or 0A								11
PAD = Hexadecimal 00								12
Frame Control								13
MAC destination address (Remainder of the MAC frame)								14
LAN FCS (If PID second octet is set to hexadecimal 04) (4 octets)								.
								.
								.
								N – 3
Frame Check Sequence first octet								N – 2
Frame Check Sequence second octet								N – 1
Flag								N

Figure D.8/X.36 – Encapsulation of bridged FDDI frame

D.5.5 Frame format for bridged 802.6 frame

The format used for encapsulation of bridged 802.6 frame is described in Figure D.9.

The common Protocol Data Unit (PDU) header and trailer are conveyed to allow pipelining at the egress bridge to an 802.6 subnetwork. Specifically, the common PDU header contains the BAsize field, which contains the length of the PDU. If this field is not available to the egress 802.6 bridge, then that bridge cannot begin to transmit the segmented PDU until it has received the entire PDU, calculated the length, and inserted the length into the BAsize field. If the field is available, the egress 802.6 bridge can extract the length from the BAsize field of the common PDU header, insert it into the corresponding field of the first segment, and immediately transmit the segment onto the 802.6 subnetwork. Thus, the bridge can begin transmitting the 802.6 PDU before it has received the complete PDU.

The common PDU header and trailer of the encapsulated frame should not be simply copied to the outgoing 802.6 subnetwork because the encapsulated BEtag value may conflict with the previous BEtag value transmitted by that bridge.

8	7	6	5	4	3	2	1	Octet
Flag								1
Address field first octet								2
Address field second octet								3
Control field of UI frame = Hexadecimal 03								4
PAD = Hexadecimal 00								5
Protocol Identifier set to hexadecimal 80								6
OUI first octet set to hexadecimal 00								7
OUI second octet set to hexadecimal 80								8
OUI third octet set to hexadecimal C2								9
PID first octet set to hexadecimal 00								10
PID second octet set to hexadecimal 0B (Note)								11
Reserved								12
BEtag								13
BAsize								14
BAsize (continue)								15
MAC destination address (Remainder of the MAC frame)								16
Common PDU trailer (4 octets)								.
Common PDU trailer (4 octets)								.
Common PDU trailer (4 octets)								.
Common PDU trailer (4 octets)								N - 3
Frame Check Sequence first octet								N - 2
Frame Check Sequence second octet								N - 1
Flag								N

NOTE – In bridged 802.6 PDUs, there is only one choice for the PID value, since the presence of a CRC-32 is identified by the CIB bit in the header of the MAC frame.

Figure D.9/X.36 – Encapsulation of bridged 802.6 frame

D.5.6 Frame format for Bridged PDU

The format used for encapsulation of Bridged PDU is described in Figure D.10.

8	7	6	5	4	3	2	1	Octet
Flag								1
Address field first octet								2
Address field second octet								3
Control field of UI frame = Hexadecimal 03								4
PAD = Hexadecimal 00								5
Protocol Identifier set to hexadecimal 80								6
OUI first octet set to hexadecimal 00								7
OUI second octet set to hexadecimal 80								8
OUI third octet set to hexadecimal C2								9
PID first octet set to hexadecimal 00								10
PID second octet set to hexadecimal 0E								11
Bridged PDU as defined by 802.1(d) or 802.1 (g)								12 . . . N – 3
Frame Check Sequence first octet								N – 2
Frame Check Sequence second octet								N – 1
Flag								N

Figure D.10/X.36 – Encapsulation of Bridged PDU

D.5.7 Frame format for Source Routing Bridged PDU

The format used for encapsulation of Source Routing Bridged PDU is described in Figure D.11.

8	7	6	5	4	3	2	1	Octet
Flag								1
Address field first octet								2
Address field second octet								3
Control field of UI frame = Hexadecimal 03								4
PAD = Hexadecimal 00								5
Protocol Identifier set to hexadecimal 80								6
OUI first octet set to hexadecimal 00								7
OUI second octet set to hexadecimal 80								8
OUI third octet set to hexadecimal C2								9
PID first octet set to hexadecimal 00								10
PID second octet set to hexadecimal 0F								11
Source Routing Bridged PDU								12 . . . N – 3
Frame Check Sequence first octet								N – 2
Frame Check Sequence second octet								N – 1
Flag								N

Figure D.11/X.36 – Encapsulation of Source Routing Bridged PDU

D.5.8 Other protocols

Some protocols do not have a specific NLPID assigned to them. When packets of such protocols are sent over a frame relay connection supporting multiprotocol encapsulation, they use NLPID 0x08 (which indicates ITU-T Rec. Q.933). The four bytes following NLPID include both layer 2 and layer 3 protocol identifications. The code points for most protocols are currently defined in the low layer compatibility information element (see 10.6.17, octets 6 and 7 codings). There is also an escape for defining non-standard protocols (see Figure D.12).

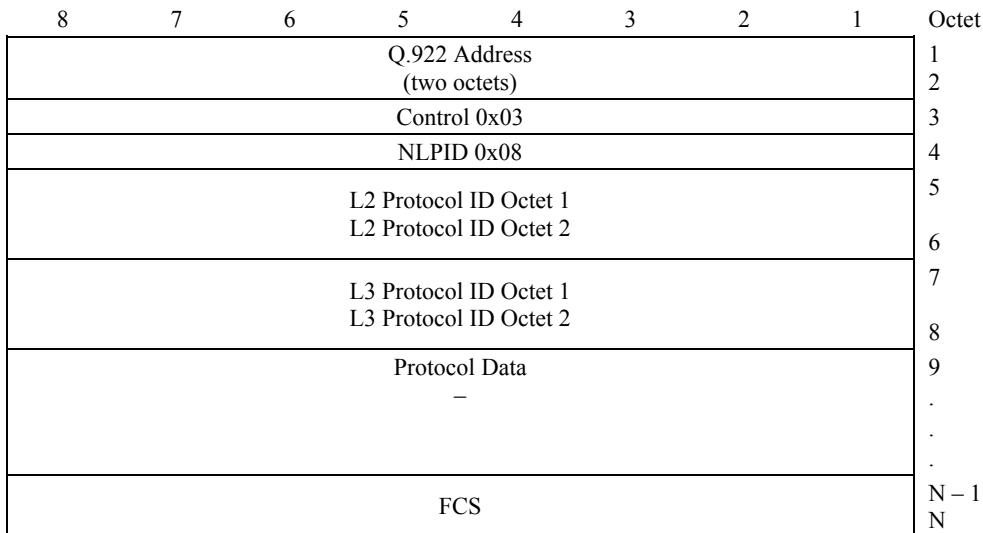
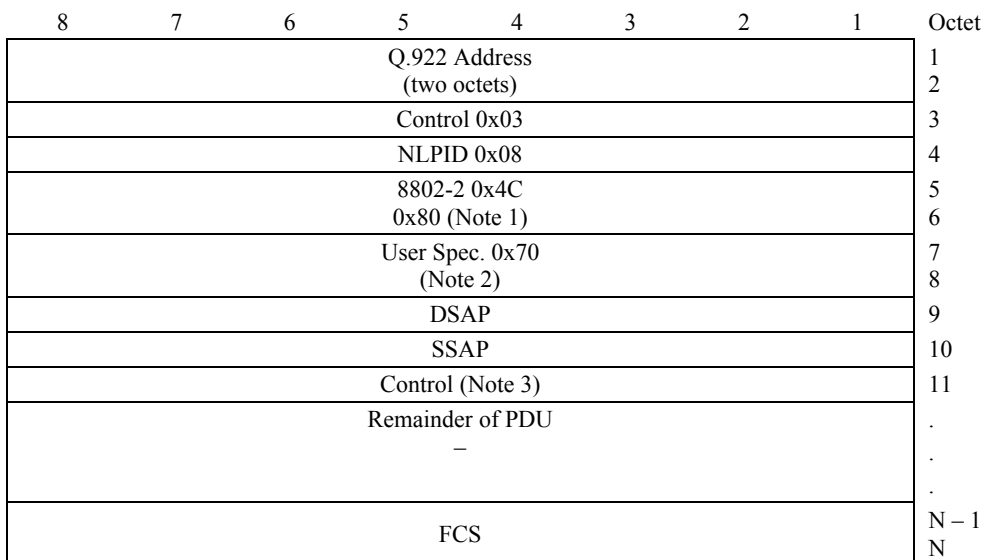

Figure D.12/X.36 – Format of other protocol frame using Q.933 NLPID

D.5.8.1 ISO/IEC 8802-2 with user specified layer 3

See Figure D.13.



NOTE 1 – Required for padding.

NOTE 2 – Indicates the code point for user specified layer 3 protocol.

NOTE 3 – Control field is two octets for I-format and S-format frames (see ISO/IEC 8802-2).

Figure D.13/X.36 – Format of frame with ISO/IEC 8802-2 (layer 2) and user specified (layer 3)

D.5.9 Fragmentation issues

Fragmentation allows the exchange of packets that are greater than the maximum frame size supported by the underlying network. In the case of frame relay, the network may support a maximum frame size as small as 262 octets, although support of maximum frame size of at least 1600 octets (i.e., large enough to carry an unfragmented IEEE 802.3 frame) is strongly recommended. Because of this small maximum size, it is advantageous to support fragmentation and reassembly.

To properly support delay-sensitive traffic on low-speed virtual connections, it is necessary to fragment the longer, more delay-tolerant frames that share the same connections. This is done so that the shorter, delay sensitive frames are not excessively delayed.

The fragmentation procedure is transparent to Frame Relay network(s) between the transmitting and receiving DTEs. The transmitting Frame Relay DTEs fragment long frames into a sequence of shorter frames, which will then be reassembled into the original frame by the receiving DTE.

D.5.9.1 Fragmentation format

The general format of fragmented packets is the same as any other encapsulated protocol. The most significant difference is that the fragmented packet will contain the encapsulation header.

The Network Layer Protocol ID (NLPID) 0xB1 has been assigned to identify this fragmentation header format.

The format for each fragment of a Frame Relay frame is described in Figure D.14.

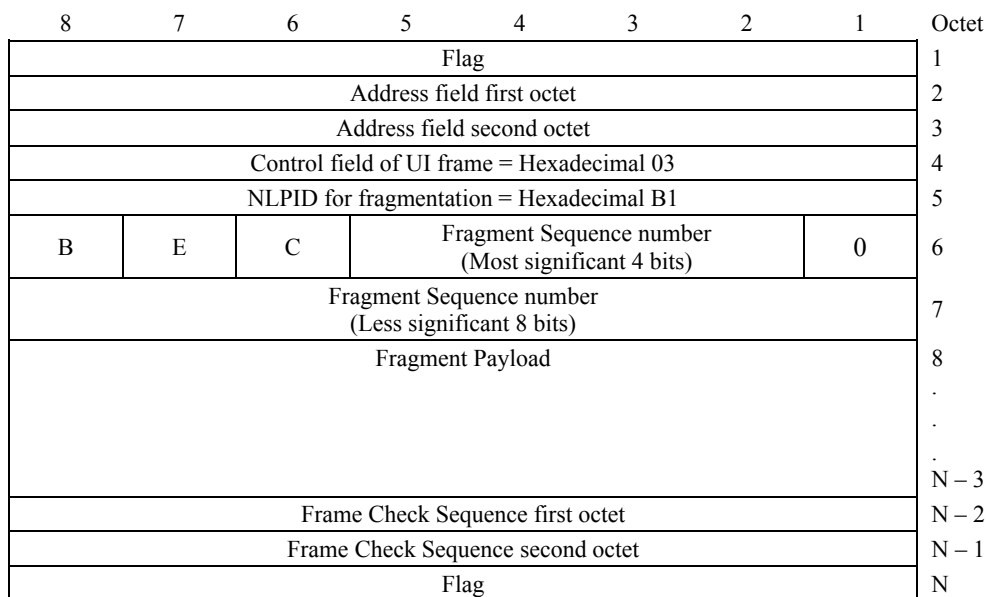

Figure D.14/X.36 – Data fragment format

The (B)eginning fragment bit is a one-bit field set to 1 on the first data fragment derived from the original frame and set to 0 for all other fragments from the same frame.

The (E)nding fragment bit is a one-bit field set to 1 on the last data fragment and set to 0 for all other data fragments. A data fragment may have both the (B)eginning and (E)nding fragment bits set to 1.

The (C)ontrol bit is set to 0 in all fragments. It is reserved for future control functions.

The fragment sequence number is a 12-bit binary number that is incremented modulo 2^{12} for every data fragment transmitted on a VC. There is a separate sequence number maintained for each fragmented VC between DTE peers.

D.5.9.2 Fragmentation procedures

Fragmentation procedures apply to the initial Information field of a Frame Relay frame.

A series of data Fragments is created by dividing the Information field of an initial FR frame into fragment payloads, to which a fragmentation header is added. Each resulting data fragments is transmitted over its intended VC in the information field of a Frame Relay Frame

As a consequence, if a multiprotocol-encapsulated frame is being fragmented, then the Q.922 control, optional pad, and NLPID octets of the original multiprotocol frame are only contained in the first data fragment.

The resulting fragments must be transmitted in the same sequence as they occurred in the frame prior to being fragmented. Fragments from multiple VCs may be interleaved with each other on one interface.

The first data fragment in the series has the B bit set, and the final data fragment has the E bit set. Every fragment in the series contains the same address octets that were on the original unfragmented frame, including the Frame Relay congestion bits (FECN, BECN, DE).

The first fragment sent on a VC (following a VC becoming active) may have the sequence number set to any value (including zero), and the sequence number must subsequently be incremented by one for each fragment sent. The sequence number is incremented without regard to the original frame boundaries; if the last fragment in one frame used sequence number "N", then the first fragment of the following frame will use sequence number "N+1". This allows lost fragments (and bursts of lost fragments) to be easily detected. Each VC has its own fragmentation sequence number sequence, independent of all other VCs.

If sufficient fragments are sent on an active VC, the sequence number will wrap from all ones to zero, and will eventually also wrap past the original sequence number sent on the VC after it became active. This wrapping may or may not occur on an original frame boundary (it is transparent to frame boundaries).

All fragments are variable in size.

The two involved DTEs could agree, by means not described in this Recommendation, on a maximum Data Fragment size. In such a case, the transmitter should not exceed the agreed maximum size.

D.5.9.3 Reassembly procedures

For each VC, the receiver must keep track of the incoming sequence numbers and maintain the most recently received sequence number. The receiver detects the end of a reassembled frame when it receives a fragment bearing the (E)nding bit. Reassembly of the frame is complete if all sequence numbers up to that fragment have been received.

Note that the Frame Relay congestion bits (FECN, BECN, DE) must be logically ORed for all fragments, and the results included in the reassembled frame.

The receiver detects lost fragments when one or more sequence numbers are skipped. When a lost fragment or fragments are detected on a VC, the receiver must discard all currently unassembled and subsequently received fragments for that VC until it receives the first fragment that bears the (B)eginning bit. The fragment bearing the (B)eginning bit is used to begin accumulating a new frame.

In the event of an error (e.g., one or more fragments lost due to transmission error or reassembly buffer overflow), fragments which cannot be reconstructed back into the original frame must be discarded by the receiver.

In case a fragment exceeds the maximum Data Fragment size, if any agreed, this fragment and as a result the following and received fragments of the FR frame being reassembled, should be discarded, by the receiver.

In case it has an information field longer than N203, the reassembled FR frame should be discarded.

D.5.9.4 Fragmentation example

An example of the fragmentation procedure, using multiprotocol encapsulated frame as the data to be fragmented, is diagrammed in Figure D.15. The octets in white indicate the data portion of the original frame that is split into fragments (three fragments in this example). For this example, the starting sequence number of 42 was chosen at random. Note that when fragmenting multiprotocol data, the control octet, the optional pad (if present), and the NLPID of the original frame are transported in the first frame fragment and are part of the reassembled frame.

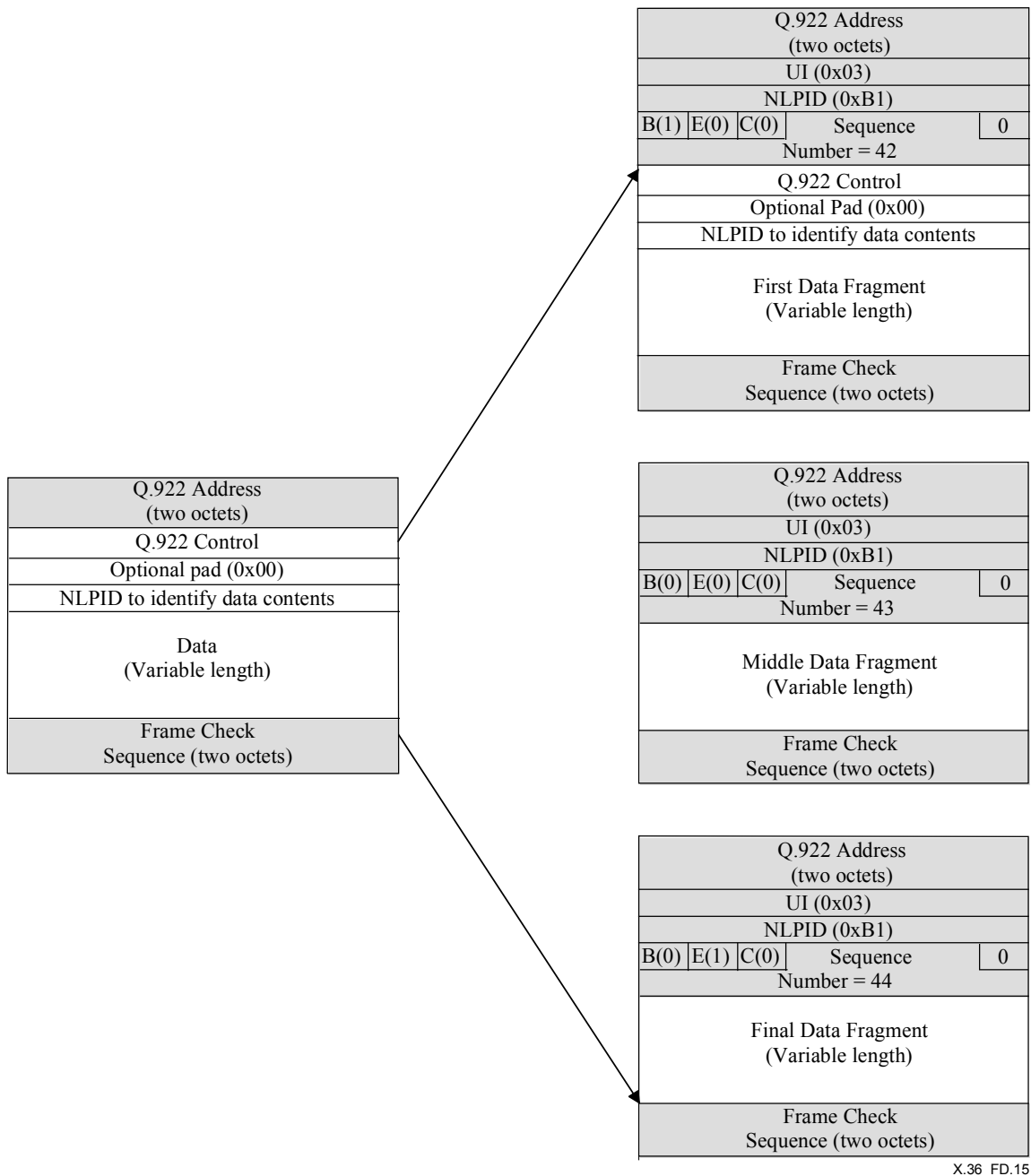

Figure D.15/X.36 – Fragmentation example

D.6 Low layer compatibility negotiation procedures

D.6.1 General purpose

The Low layer compatibility negotiation procedures in this annex are based on Annex J/Q.931 and are optional. The purpose of the Low layer compatibility information element is to provide a means which should be used for compatibility checking by an addressed entity (e.g., a remote user or an interworking unit or high layer function network node addressed by the calling user). The Low layer compatibility information element is transferred transparently by a frame relay network between the call originating entity (e.g., the calling user) and the addressed entity.

The user information protocol fields of the Low layer compatibility information element indicate the low layer attributes at the call originating entity and the addressed entity. This information is not interpreted by the frame relay network and therefore the bearer capability provided by the frame relay network is not affected by this information. The call originating entity and the addressed entity may modify the low layer attributes by the negotiation described below.

The Low layer compatibility information element is coded according to 10.6.17.

D.6.2 Low layer capability notification to the called user

When the calling user wishes to notify the called user of its information transfer attributes (OSI layer 2 and layer 3 attributes), then the calling user shall include a Low layer compatibility information element in the SETUP message; this element is conveyed by the network and delivered to the called user. However, if the network is unable to convey this information element, it shall act as described in 10.10.7.1 (unrecognized information element).

D.6.3 Low layer compatibility negotiation between users

If the user wishes to indicate alternative values of low layer compatibility parameters (e.g., alternative protocol suites), the Low layer compatibility information element is repeated in the SETUP message. Up to *three* Low layer compatibility information elements may be included in a SETUP message. The first Low layer compatibility information element in the list is the default and is used if the network or called user does not support negotiation. The order of appearance of the subsequent Low layer compatibility information elements indicates the order of preference of end-to-end low layer parameters.

If the network or called user does not support repeating of the Low layer compatibility information element, and therefore discards the subsequent Low layer compatibility information elements, only the first Low layer compatibility information element is used in the negotiation.

NOTE 1 – When the first Low layer compatibility information element of the SETUP message does not contain octets 7b* and 8.1* to 8.5* it favours interoperability with DTEs that do not support these extensions.

NOTE 2 – When the length of the first Low layer compatibility information element of the SETUP message is less or equal to 8 octets (previous case, or octets 6, 6a* and 8.1* to 8.5* not included) it favours interoperability with networks that do not support the extension of octets 7b* and 8.1* to 8.5*, the transmission of more than one Low Layer Compatibility information element in the SETUP message and one in the CONNECT message.

The called user indicates a single choice from among the options offered in the SETUP message by including the Low layer compatibility information element in the CONNECT message. Absence of a Low layer compatibility information element in the CONNECT message indicates acceptance of the first Low layer compatibility information element in the SETUP message.

D.6.4 Backward compatibility considerations

Since the initial versions of frame relay implementations typically do not support Low Layer Compatibility negotiation, it is important that these implementations still interoperate with implementations of X.36 that do support the Low Layer Compatibility negotiation. Because the Low Layer Compatibility is an end-to-end function and was previously not negotiated, a called DTE that does not support LLC negotiation will accept the call based on its comprehension of the first Low Layer Compatibility presented in the SETUP, and it will send a CONNECT without a Low Layer Compatibility or it will clear the call. The calling DTE interprets the absence of an LLC IE in the CONNECT as an acceptance of the first LLC presented in the SETUP. In either case this is acceptable behaviour to the negotiation procedures proposed and provides consistent function to the older implementation.

Since a calling DTE that does not support negotiation can only send one LLC IE in the SETUP this indicates to the called DTE that the calling DTE does not support negotiation or does not wish to negotiate the LLC for the call. The call, if accepted, will use the LLC IE from the SETUP and no LLC will be returned in the CONNECT.

If any network connecting two DTEs does not support LLC negotiation, all but the first LLC IE in the SETUP will be discarded and the call is progressed to the called DTE. The called DTE interprets the call as though the calling DTE does not support negotiation or does not wish to negotiate the LLC. The call, if accepted, will use the LLC IE from the SETUP and no LLC will be returned in the CONNECT.

D.7 Examples

The following are examples of how one would encode the Low Layer Compatibility IE to signal the use protocol indicated. See Figures D.16 to D.20.

8	7	6	5	4	3	2	1	Octet
0	Low layer compatibility information element identifier							1
	1	1	1	1	1	0	0	
Length of the low layer compatibility contents								2
ext.	Coding standard		Information transfer capability					3
1	0	0	0	1	0	0	0	
ext.	Transfer mode		Reserved					4
1	0	1	0	0	0	0	0	
ext.	Layer 3 ident.		User information layer 3 protocol ITU-T Rec. X.263 ISO/IEC TR 9577					7*
1	1	1	0	1	0	1	1	

Figure D.16/X.36 – Encoding for ITU-T Rec. X.263 | ISO/IEC TR 9577 multiprotocol encapsulation

8	7	6	5	4	3	2	1	Octet
0	Low layer compatibility information element identifier							1
	1	1	1	1	1	0	0	
Length of the low layer compatibility contents								2
ext.	Coding standard		Information transfer capability					3
1	0	0	0	1	0	0	0	
ext.	Transfer mode		Reserved					4
1	0	1	0	0	0	0	0	
ext.	Layer 3 ident.		User information layer 3 protocol ITU-T Rec. X.263 ISO/IEC TR 9577					7*
1	1	1	0	1	0	1	1	
ext.	ITU-T Rec. X.263 ISO/IEC TR 9577 Initial Protocol Identifier (IPI) for IP (bits 8-2)							7a*
0	1	1	0	0	1	1	0	
ext.	IPI (bit 1)	Spare						7b*
1	0	0	0	0	0	0	0	

Figure D.17/X.36 – Single protocol encoding for IP

	8	7	6	5	4	3	2	1	Octet
	Low layer compatibility information element identifier								1
0	1	1	1	1	1	1	0	0	
	Length of the low layer compatibility contents								2
ext.	Coding standard		Information transfer capability						3
1	0	0	0	1	0	0	0	0	
ext.	Transfer mode		Reserved						4
1	0	1	0	0	0	0	0	0	
ext.	Layer 3 ident.		User information layer 3 protocol ITU-T Rec. X.263 ISO/IEC TR 9577						7*
1	1	1	0	1	0	1	1	1	
ext.	ITU-T Rec. X.263 ISO/IEC TR 9577 Initial Protocol Identifier (IPI) for SNAP (bits 8-2)								7a*
0	1	0	0	0	0	0	0	0	
ext.	IPI (bit 1)	Spare							7b*
1	0	0	0	0	0	0	0	0	
ext.	SNAP ID		Spare						8*
1	0	0	0	0	0	0	0	0	
	OUI octet 1								8.1*
	OUI octet 2								8.2*
	OUI octet 3								8.3*
	PID octet 1								8.4*
	PID octet 2								8.5*

Figure D.18/X.36 – Single protocol encoding for Protocol Identified via SNAP convention

	8	7	6	5	4	3	2	1	Octet
	Low layer compatibility information element identifier								1
0	1	1	1	1	1	1	0	0	
	Length of the low layer compatibility contents								2
ext.	Coding standard		Information transfer capability						3
1	0	0	0	1	0	0	0	0	
ext.	Transfer mode		Reserved						4
1	0	1	0	0	0	0	0	0	
ext.	Layer 2 ident.		User information layer 2 protocol ITU-T Rec. Q.922						7*
1	1	0	0	1	1	1	1	0	
ext.	User specified layer 3 protocol information								7a*
1	x	x	x	x	x	x	x	x	

**Figure D.19/X.36 – Single protocol encoding for Protocol Identified via Q.933 convention
(Layer 2: Q.922 Layer 3: User specified)**

	8	7	6	5	4	3	2	1	Octet
	Low layer compatibility information element identifier								1
0	1	1	1	1	1	1	0	0	
	Length of the low layer compatibility contents								2
ext.	Coding standard		Information transfer capability						3
1	0	0	0	1	0	0	0		
ext.	Transfer mode		Reserved						4
1	0	1	0	0	0	0	0		
ext.	Layer 2 ident.		User information layer 2 protocol ISO/IEC 7776 DTE to DTE operation						6
1	1	0	1	0	0	0	0	1	
	User specified layer 2 protocol information								
ext.	Reserved		SREJ	Modulo		Address inclusion			6a*
1	0	0	1	1	0	0	1		

Figure D.20/X.36 – Single protocol encoding for ISO/IEC 7776 with use of SREJ and modulo 32768

NOTE – Bits 5 to 1 of octet 6 were wrongly labelled "ITU-T Q.922". Address inclusion coding was missing.

D.8 Protocol encapsulation format

D.8.1 Multiprotocol encapsulation format

Formats described in D.1 to D.5 are applicable.

D.8.2 Mono encapsulation format

Figure D.21 describes, in case single protocol encapsulation is selected, the format used to encapsulate a PDU of the particular protocol in the information field of the FR frame. No protocol identifier related to the encapsulating FR technology is included.

	8	7	6	5	4	3	2	1	Octet
	Flag								1
	Address field first octet								2
	Address field second octet								3
	First octet of the encapsulated PDU								4
	...								
	last octets of the encapsulated PDU								N – 3
	Frame Check Sequence first octet								N – 2
	Frame Check Sequence second octet								N – 1
	Flag								N

Figure D.21/X.36 – Single protocol encapsulation format

Annex E

Usage of cause and location

E.1 Location field generation

This annex defines the encoding of the cause value, the location and diagnostic fields of the Cause information element. It also defines the semantics of each cause value to be used for frame relay SVC signalling at the DTE/DCE interface (see Figure E.1 and Table E.1).

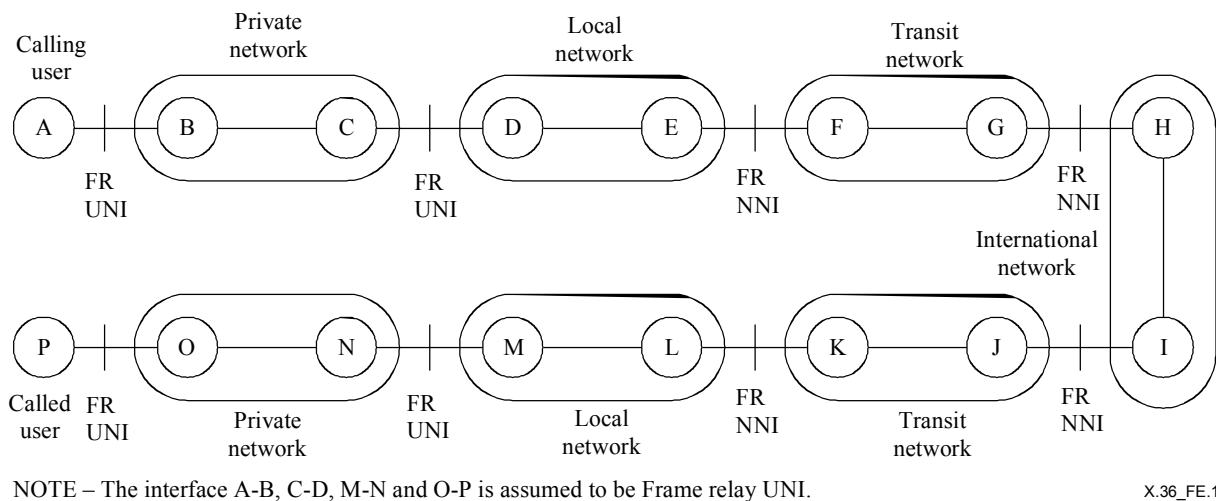

Figure E.1/X.36 – Reference configuration for location field generation

Table E.1/X.36 – Location field values

Node generating location field	Location field setting	Location setting expected by user A
B	LPN	LPN
C	LPN	LPN
D	LN	LN
E	LN	LN
F	TN	TN
G	TN	TN
H	INTL	INTL
I	INTL	INTL
J	TN	TN
K	TN	TN
L	LN or RLN	RLN
M	LN or RLN	RLN
N	LPN or RPN	RPN
O	LPN or RPN	RPN
P	U	U

NOTE – When both DTEs are connected to the same public network, both "public network serving the remote DTE" and "public network serving the local DTE" can be received by a DTE. "Public network serving the remote DTE" refers to the remote DTE/DCE interface and "public network serving the local DTE" refers to the local DTE/DCE interface.

E.2 Cause values

The cause values are defined in ITU-T Rec. Q.850. They are applicable to different protocols and services. The cause values relevant to frame relay switched virtual circuits are provided below.

Cause value: **No. 1 – Unallocated (unassigned number)**

Class (octet 4 bits 7 6 5): 0 0 0

Value (octet 4 bits 4 3 2 1): 0 0 0 1

Definition: This cause indicates that the called party cannot be reached because, although the number is in a valid format, it is not currently allocated (assigned).

Diagnostic: Condition

Cause value: **No. 2 – No route to specified transit network (national use)**

Class (octet 4 bits 7 6 5): 0 0 0

Value (octet 4 bits 4 3 2 1): 0 0 1 0

Definition: This cause indicates that the equipment sending this cause has received a request to route the call to a particular transit network which it does not recognize, either because the transit network does not exist or because while it does exist, does not serve the equipment which is sending this cause.

Diagnostic: Transit network identity

Cause value: **No. 3 – No route to destination**

Class (octet 4 bits 7 6 5): 0 0 0

Value (octet 4 bits 4 3 2 1): 0 0 1 1

Definition: This cause indicates that the called party cannot be reached because the network through which the call has been routed does not serve the destination.

Diagnostic: Condition

Cause value: **No. 6 – Channel unacceptable**

Class (octet 4 bits 7 6 5): 0 0 0

Value (octet 4 bits 4 3 2 1): 0 1 1 0

Definition: This cause indicates that the channel identified is not acceptable to the sender of this cause value. This cause value is used with an ISDN access.

Diagnostic: Not defined

Cause value: **No. 7 – Call awarded and being delivered in an established channel**

Class (octet 4 bits 7 6 5): 0 0 0

Value (octet 4 bits 4 3 2 1): 0 1 1 1

Definition: This cause indicates that the user has been awarded the incoming call and that the incoming call is being connected to a channel already established to that user for similar calls. This cause is used when the frame relay service is accessed through an ISDN circuit mode connection.

Diagnostic: Not defined

Cause value: **No. 16 – Normal call clearing**

Class (octet 4 bits 7 6 5): 0 0 1

Value (octet 4 bits 4 3 2 1): 0 0 0 0

Definition: This cause indicates that the call is being cleared because one of the users has requested that the call be cleared.

Diagnostic: Condition

Cause value: **No. 17 – User busy**

Class (octet 4 bits 7 6 5): 0 0 1

Value (octet 4 bits 4 3 2 1): 0 0 0 1

Definition: This cause indicates that the called party is unable to accept another call because a busy condition has been encountered. This cause value may be generated by either the called user or the network.

Diagnostic: Not applicable to the frame relay service

Cause value: **No. 18 – No user responding**

Class (octet 4 bits 7 6 5): 0 0 1

Value (octet 4 bits 4 3 2 1): 0 0 1 0

Definition: This cause indicates that the called user does not respond to a call establishment message within the prescribed period of time allocated.

Diagnostic: Not defined

Cause value: **No. 21 – Call rejected**

Class (octet 4 bits 7 6 5): 0 0 1

Value (octet 4 bits 4 3 2 1): 0 1 0 1

Definition: This cause indicates that the equipment sending this cause does not wish to accept this call, although it could have accepted the call because it is neither busy nor incompatible.

Diagnostic: Call rejected condition

Cause value: **No. 27 – Destination out of order**

Class (octet 4 bits 7 6 5): 0 0 1

Value (octet 4 bits 4 3 2 1): 1 0 1 1

Definition: This cause indicates that the destination cannot be reached because the interface is not functioning correctly. The phrase not *functioning correctly* indicates that a signalling message was unable to be delivered to the called user.

Diagnostic: Not defined

Cause value: **No. 28 – Invalid number format (address incomplete)**

Class (octet 4 bits 7 6 5): 0 0 1

Value (octet 4 bits 4 3 2 1): 1 1 0 0

Definition: This cause indicates that the called party cannot be reached because the called party number is not in a valid format or is not complete.

Diagnostic: Not defined

Cause value: **No. 29 – Facility rejected**

Class (octet 4 bits 7 6 5): 0 0 1

Value (octet 4 bits 4 3 2 1): 1 1 0 1

Definition: This cause is returned when a supplementary service requested by the user cannot be provided by the network.

Diagnostic: Facility identification

Cause value: **No. 30 – Response to STATUS ENQUIRY**

Class (octet 4 bits 7 6 5): 0 0 1

Value (octet 4 bits 4 3 2 1): 1 1 1 0

Definition: This cause is included in the STATUS message when the reason for generating the STATUS message was the receipt of a STATUS ENQUIRY message.

Diagnostic: Not defined

Cause value: **No. 31 – Normal, unspecified**

Class (octet 4 bits 7 6 5): 0 0 1

Value (octet 4 bits 4 3 2 1): 1 1 1 1

Definition: This cause is used to report a normal event only when no other cause in the normal call applies.

Diagnostic: Not defined

Cause value: **No. 34 – No circuit/channel available**

Class (octet 4 bits 7 6 5): 0 1 0

Value (octet 4 bits 4 3 2 1): 0 0 1 0

Definition: This cause indicates that there is no appropriate circuit/channel presently available to handle the call.

Diagnostic: Not defined

Cause value: **No. 38 – Network out of order**

Class (octet 4 bits 7 6 5): 0 1 0

Value (octet 4 bits 4 3 2 1): 0 1 1 0

Definition: This cause indicates that the network is not functioning correctly and that the condition is likely to last a relatively long period of time. Immediately re-attempting the call is not likely to be successful.

Diagnostic: Not defined

Cause value: **No. 39 – Permanent frame mode connection out of service**

Class (octet 4 bits 7 6 5): 0 1 0

Value (octet 4 bits 4 3 2 1): 0 1 1 1

Definition: This cause is included in a STATUS message to indicate that a permanently established frame mode connection is out of service due to equipment.

Diagnostic: Not defined

Cause value: **No. 40 – Permanent frame mode connection operational**

Class (octet 4 bits 7 6 5): 0 1 0

Value (octet 4 bits 4 3 2 1): 0 1 0 0

Definition: This cause is included in a STATUS message to indicate that a permanently established frame mode connection is operational and capable of carrying user information.

Diagnostic: Not defined

Cause value: **No. 41 – Temporary failure**

Class (octet 4 bits 7 6 5): 0 1 0

Value (octet 4 bits 4 3 2 1): 1 0 0 1

Definition: This cause indicates that the network is not functioning correctly and that the condition is not likely to last a long period of time. The user may wish to try another call attempt almost immediately.

Diagnostic: Not provided in ITU-T Rec. Q.850

Cause value: **No. 42 – Switching equipment congestion**

Class (octet 4 bits 7 6 5): 0 1 0

Value (octet 4 bits 4 3 2 1): 1 0 1 0

Definition: This cause indicates that the switching equipment generating this cause is experiencing a period of high traffic.

Diagnostic: Not defined

Cause value: **No. 43 – Access information discarded**

Class (octet 4 bits 7 6 5): 0 1 0

Value (octet 4 bits 4 3 2 1): 1 0 1 1

Definition: This cause indicates that the network could not deliver access information to the remote user as requested (subaddress, low layer compatibility, etc.) as indicated in the diagnostic. It is noted that the particular type of access information discarded is optionally included in the diagnostic.

Diagnostic: Discarded information element identifier

Cause value: **No. 44 – Requested circuit/channel not available**

Class (octet 4 bits 7 6 5): 0 1 0

Value (octet 4 bits 4 3 2 1): 1 1 0 0

Definition: This cause is returned when the circuit or channel indicated by the requesting entity cannot be provided by the other side of the interface.

Diagnostic: Not defined

Cause value: **No. 47 – Resource unavailable, unspecified**

Class (octet 4 bits 7 6 5): 0 1 0

Value (octet 4 bits 4 3 2 1): 1 1 1 1

Definition:

Diagnostic:

Cause value: **No. 49 – Quality of Service not available**

Class (octet 4 bits 7 6 5): 0 1 1

Value (octet 4 bits 4 3 2 1): 0 0 0 1

Definition: This cause indicates that the requested Quality of Service (specified in the link layer core parameters information element) cannot be provided.

Diagnostic: Condition

Cause value: **No. 50 – Requested facility not subscribed**

Class (octet 4 bits 7 6 5): 0 1 1

Value (octet 4 bits 4 3 2 1): 0 0 1 0

Definition: This cause indicates that the user has requested a supplementary service which is implemented by the equipment which generated this cause, but the user is not authorized to use.

Diagnostic: Facility identification

Cause value: **No. 57 – Bearer capability not authorized**

Class (octet 4 bits 7 6 5): 0 1 1

Value (octet 4 bits 4 3 2 1): 1 0 0 1

Definition: This cause indicates that the user has requested a bearer capability which is implemented but for which he is not authorized to use.

Diagnostic: Attribute identity

Cause value: **No. 58 – Bearer capability not presently available**

Class (octet 4 bits 7 6 5): 0 1 1

Value (octet 4 bits 4 3 2 1): 1 0 1 0

Definition: This cause indicates that the user has requested a bearer capability which is implemented but which is not available at this time.

Diagnostic: Attribute identity

Cause value: **No. 63 – Service or option not available, unspecified**

Class (octet 4 bits 7 6 5): 0 1 1

Value (octet 4 bits 4 3 2 1): 1 1 1 1

Definition: This cause is used to report a *service or option not available event* only when no other cause in the *service or option not available class* (class 011) applies.

Diagnostic: Not defined

Cause value: **No. 65 – Bearer capability not implemented**

Class (octet 4 bits 7 6 5): 1 0 0

Value (octet 4 bits 4 3 2 1): 0 0 0 1

Definition: This cause indicates that the equipment sending this cause does not support the bearer capability requested.

Diagnostic: Attribute identity

Cause value: **No. 66 – Channel type not implemented**

Class (octet 4 bits 7 6 5): 1 0 0

Value (octet 4 bits 4 3 2 1): 0 0 1 0

Definition: This cause indicates that the equipment sending this cause does not support the channel type requested. This cause is used with an ISDN access to the frame relay network.

Diagnostic: Not applicable to a non-ISDN access to the frame relay

Cause value: **No. 70 – Only restricted digital information bearer capability is available**

Class (octet 4 bits 7 6 5): 1 0 0

Value (octet 4 bits 4 3 2 1): 0 1 1 0

Definition: This cause indicates that the calling party has requested an unrestricted bearer service but that the equipment sending this cause only supports the restricted version of the requested bearer capability.

Diagnostic: Not defined

Cause value: **No. 79 – Service or option not implemented, unspecified**

Class (octet 4 bits 7 6 5): 1 0 0

Value (octet 4 bits 4 3 2 1): 1 1 1 1

Definition: This cause is used to report a *service or option not implemented event* only when no other cause in the *service or option not implemented class* (class 100) applies.

Diagnostic: Not defined

Cause value: **No. 81 – Invalid call reference value**

Class (octet 4 bits 7 6 5): 1 0 1

Value (octet 4 bits 4 3 2 1): 0 0 0 1

Definition: This cause indicates that the equipment sending this cause has received a message with a call reference which is not currently in use on the UNI.

Diagnostic: Not defined

Cause value: **No. 82 – Identified channel does not exist**

Class (octet 4 bits 7 6 5): 1 0 1

Value (octet 4 bits 4 3 2 1): 0 0 1 0

Definition: This cause indicates that the equipment sending this cause has received a request to use a channel not activated on the interface. This cause is mainly used when an ISDN circuit mode connection is used to access the frame relay network. This cause is used, for example, when a user has subscribed to those channels on a primary rate interface numbered from 1 to 12 and the user equipment or the network attempts to use channels 13 to 23.

Diagnostic: For further study

Cause value: **No. 87 – User not member of CUG**

Class (octet 4 bits 7 6 5): 1 0 1

Value (octet 4 bits 4 3 2 1): 0 1 1 1

Definition: This cause indicates that the called user for the incoming CUG call is not a member of the specified CUG or that the calling user is an ordinary subscriber calling a CUG subscriber.

Diagnostic: Not defined

Cause value: **No. 88 – Incompatible destination**

Class (octet 4 bits 7 6 5): 1 0 1

Value (octet 4 bits 4 3 2 1): 1 0 0 0

Definition: This cause indicates that the equipment sending this cause has received a request to establish a call which has a compatibility attributes (information element) which cannot be accommodated.

Diagnostic: (Incompatible) information element identifier

Cause value: **No. 90 – Non-existent CUG**

Class (octet 4 bits 7 6 5): 1 0 1

Value (octet 4 bits 4 3 2 1): 0 1 1 1

Definition: This cause indicates that the specified CUG does not exist.

Diagnostic: Not defined

Cause value: **No. 91 – Invalid transit network selection (national use)**

Class (octet 4 bits 7 6 5): 1 0 1

Value (octet 4 bits 4 3 2 1): 1 0 1 1

Definition: This cause indicates that a transit network identification was received which is of an incorrect format as defined in Annex C/Q.931.

Diagnostic: Not defined

Cause value: **No. 95 – Invalid message, unspecified**

Class (octet 4 bits 7 6 5): 1 0 1

Value (octet 4 bits 4 3 2 1): 1 1 1 1

Definition: This cause is used to report an *invalid message event* only when no other cause in the *invalid message class* (class 101) applies.

Diagnostic: Not defined

Cause value: **No. 96 – Mandatory information element is missing**

Class (octet 4 bits 7 6 5): 1 1 0

Value (octet 4 bits 4 3 2 1): 0 0 0 0

Definition: This cause indicates that the equipment sending this cause has received a message which is missing a mandatory information element.

Diagnostic: Information element identifier

Cause value: **No. 97 – Message type non-existent or not implemented**

Class (octet 4 bits 7 6 5): 1 1 0

Value (octet 4 bits 4 3 2 1): 0 0 0 1

Definition: This cause indicates that the equipment sending this cause has received a message type it does not recognize either because it is not defined or it is defined but not implemented.

Diagnostic: Message type

Cause value: **No. 98 – Message not compatible with call state or message type non-existent or not implemented**

Class (octet 4 bits 7 6 5): 1 1 0

Value (octet 4 bits 4 3 2 1): 0 0 1 0

Definition: This cause indicates that the equipment sending this cause has received a message not expected in the current call state. This cause is also sent when a STATUS message was received indicating an incompatible call state.

Diagnostic: Message type

Cause value: **No. 99 – Information element/parameter non-existent or not implemented**

Class (octet 4 bits 7 6 5): 1 1 0

Value (octet 4 bits 4 3 2 1): 0 0 1 1

Definition: This cause indicates that the equipment sending this cause has received a message which includes information element(s) not defined or not implemented. This cause indicates that the information element(s) was (were) discarded and not required to process the message.

Diagnostic: Information element identifier

Cause value: **No. 100 – Invalid information element contents**

Class (octet 4 bits 7 6 5): 1 1 0

Value (octet 4 bits 4 3 2 1): 0 1 0 0

Definition: This cause indicates that the equipment sending this cause has received an information element which it has implemented; however, the encoding of one or more fields of the information element is not supported or implemented.

Diagnostic: Information element identifier

Cause value: **No. 101 – Message not compatible with call state**

Class (octet 4 bits 7 6 5): 1 1 0

Value (octet 4 bits 4 3 2 1): 0 1 0 1

Definition: This cause indicates that a message has been received which is incompatible with the call state.

Diagnostic: Message type

Cause value: **No. 102 – Recovery on timer expiry**

Class (octet 4 bits 7 6 5): 1 1 0

Value (octet 4 bits 4 3 2 1): 0 1 1 0

Definition: This cause indicates that a procedure has been initiated by the expiry of a timer in association with error handling procedures.

Diagnostic: Timer number

Cause value: **No. 111 – Protocol error, unspecified**

Class (octet 4 bits 7 6 5): 1 1 0

Value (octet 4 bits 4 3 2 1): 1 1 1 1

Definition: This cause is used to report a *protocol error event* only when no other cause in the *protocol error class* (110) applies.

Diagnostic: Not defined

Cause value: **No. 127 – Interworking, unspecified**

Class (octet 4 bits 7 6 5): 1 1 1

Value (octet 4 bits 4 3 2 1): 1 1 1 1

Definition: This cause indicates that there has been interworking with a network which does not provide causes for actions it takes. Thus, the precise cause for a message which is being sent cannot be ascertained.

Diagnostic: Not defined

The following cause values are not relevant to this Recommendation:

- No. 4 – Send special information tone
- No. 5 – Misdialed trunk prefix (national use)
- No. 8 – Preemption
- No. 9 – Preemption – Circuit reserved for reuse
- No. 19 – No answer from user (user alerted)
- No. 20 – Subscriber absent
- No. 22 – Number changed
- No. 26 – Non-selected user clearing
- No. 46 – Precedence call blocked
- No. 47 – Resource unavailable, unspecified
- No. 53 – Outgoing calls barred within CUG
- No. 55 – Incoming calls barred within CUG
- No. 62 – Inconsistency in designated outgoing access information and subscriber class
- No. 69 – Requested facility not implemented
- No. 83 – A suspended call exits, but this call identity does not
- No. 84 – Call identity in use
- No. 85 – No call suspended
- No. 86 – Call having the requested call identity has been cleared
- No. 103 – Parameter non-existent or not implemented, passed on (used by ISUP only)
- No. 110 – Message with unrecognized parameter discarded (used by ISUP only)

E.3 Coding of the diagnostic field

E.3.1 Coding of condition

The condition diagnostic (octet 5) is coded as follows:

Bit

8

1

Bits

7 6 5

0 0 0

Bit

4

0 Network service provider

1 Network service user

Bit

3

0 Normal

1 Abnormal

Bits

2 1

0 0 Unknown

0 1 Permanent

1 0 Transient

E.3.2 Coding of Transit network identity

The diagnostic field contains the entire transit network selection information element.

E.3.3 Coding of call rejected diagnostic

The format of the diagnostic field for cause No. 21 is shown in Figure E.2 and Table E.2.

8	7	6	5	4	3	2	1	Octet
ext. 1	Rejection reason					Condition		5
IE type	Information element identifier							7

Figure E.2/X.36 – Coding of diagnostic field for cause No. 21

Table E.2/X.36 – Coding of diagnostic field for cause No. 21

<i>Rejection reason (octet 5)</i>	
Bits	
<u>7 6 5 4 3</u>	
0 0 0 0 1	Information element missing
0 0 0 1 0	Information element contents are not sufficient
All other values are reserved.	
<i>Condition (octet 5)</i>	
Bits	
<u>2 1</u>	
0 0	Unknown
0 1	Permanent
1 1	Transient
<i>IE type (octet 7)</i>	
Bit	
<u>8</u>	
0	Variable length information element
1	Fixed length information element
<i>IE identifier (octet 7)</i>	
Bits 7-1 are encoded with the information element identifier of the missing or insufficient information element (see E.2 for the code values).	

E.3.4 Coding of timer value

The timer number is coded using characters defined in ITU-T Rec. T.50, one character per decimal digit. The following coding is used in each octet starting with octet 5 of the diagnostic field:

Bit 8: Spare B'0'

Bits 7-1: IA5 character

NOTE – The most significant decimal digit of the timer is coded first (in octet 5), the other digits are coded in subsequent octets.

E.3.5 Coding of message type

The message type is coded as specified in 10.6.3, Table 10-12.

E.3.6 Coding of the facility type

The code point of the information element associated with the facility rejected, except for the simple CUG since it is not possible to code the code point of an information element.

Annex F

Use of NSAP at the DTE-DCE interface

F.1 Introduction

Network Service Access Point (NSAP) addresses are defined in Annex A of ITU-T Rec. X.213 | ISO/IEC 8348. Some public ATM networks use the NSAP structure known as an ATM End System Address (AESAs) to address end systems. To interwork between those ATM networks and frame relay networks using this Recommendation, it is essential to:

- Allow the encoding of frame relay DTE X.121 numbers as NSAP so that ATM networks and ATM end systems can use them in signalling messages.
- To allow frame relay DTEs to signal ATM end system address based on IDC, DCC and E.164 NSAP formats.

The purpose of this annex is to provide extensions to the basic signalling defined in clause 10 to allow the use of NSAP at the DTE-DCE interface and to recommend a coding of the Domain Specific Part (DSP) field of the NSAP. It also provides information on the coding of ICD, DCC and E.164 as supported in ATM networks.

It should be noted that the support of addresses coded according to the NSAP structure is a network option. Further, it does not imply that a public frame relay network will utilize a numbering plan other than E.164 or X.121 to identify DTEs.

F.2 Encoding of X.121 numbers as NSAP

Figure F.1 shows how to encode an X.121 number as an NSAP. There are two formats: The first one is with a null DSP and the second one with a non-null DSP. For case b) of Figure F.1, the DSP is structured according to ISO/IEC 10589. The same approach for embedding E.164 numbers in an NSAP structure is used in this annex for X.121 numbers.

1	2	3	4	5	6	7	8	9	10	11	12	13	14	15	16	17	18	19	20	Octet	
AFI	IDI							DSP													
37	X.121 number							All zeros Binary coded													

a) X.121 number with a Null DSP

1	2	3	4	5	6	7	8	9	10	11	12	13	14	15	16	17	18	19	20	Octet	
AFI	IDI							DSP													
37	X.121 number							HO-DSP					ESI					SEL			

b) X.121 number with a non-Null DSP

Figure F.1/X.36 – X.121 number embedded in NSAP format

Coding principles:

- The NSAP has a fixed length of 20 octets. It consists of three fields: The AFI, IDI and DSP.
- The AFI has a value of 37, it is encoded in "binary coded decimal" (BCD). The hexadecimal value of the AFI is "37".
- The IDI field contains an X.121 number of up to 14 digits. If the length of the X.121 number is less than 14 digits, padding is done according to the preferred padding method of Annex A to ITU-T Rec. X.213 | ISO/IEC 8348 (see below). The X.121 number is BCD coded.
- The DSP is 12 octets long and is binary coded. It contains either zeros (null DSP, case a) of Figure F.1) or contains the following three fields: HO-DSP, ESI and SEL following ISO/IEC 10589 structure of the DSP and the AESA using DCC, IDC and E.164 IDI.
- Padding of the IDI:
 - Step 1: If necessary the IDI is padded with leading zeros to obtain the maximum IDI length (14 digits for X.121 number).

- Step 2: If necessary pad the last half octet of the IDI with '1111' to obtain an integral number of octets.

Padding with zeros is the only allowed padding since no significant zeros are allowed in the IDI, the AFI value of 37 reflects this fact.

F.3 Encoding of E.164 numbers as NSAP

This clause provides the NSAP coding of E.164 used by some public ATM networks. The coding follows the preferred coding of Annex A of ITU-T Rec. X.213 | ISO/IEC 8348. The coding provided here is also applicable to frame relay networks using ITU-T Rec. E.164 as the numbering plan for DTEs.

1) E.164 AESA with a non-null DSP

1	2	3	4	5	6	7	8	9	10	11	12	13	14	15	16	17	18	19	20	Octet
AFI	IDI								DSP											
45	E.164 Number								HO-DSP				ESI				SEL			

2) Native E.164 embedded in an NSAP format

1	2	3	4	5	6	7	8	9	10	11	12	13	14	15	16	17	18	19	20	Octet
AFI	IDI								DSP											
45	E.164 Number								All zeros DSP											

F.4 Other ATM End System Address coding

Besides E.164 numbers coded as NSAP, ATM end system can be addressed using the following two formats: DCC and ICD.

1) ICD AESA format

1	2	3	4	5	6	7	8	9	10	11	12	13	14	15	16	17	18	19	20	Octet
AFI	IDI								DSP											
47	ICD	HO-DSP						ESI				SEL								

2) DCC AESA format

1	2	3	4	5	6	7	8	9	10	11	12	13	14	15	16	17	18	19	20	Octet
AFI	IDI								DSP											
39	DCC	HO-DSP						ESI				SEL								

Annex G

Enhancements to PVC management procedures

G.1 Introduction

The PVC management procedures, as defined in clause 11 imposes a limit on the number of PVC reporting status. This limit is caused by the maximum frame size that can be supported by the DTE and DCE. This annex defines optional enhanced PVC management procedures to increase the number of PVCs in Full Status reports. The enhanced procedures add a new Full Status Continued

report type to the Report Type Information Element in order to segment the Full Status message when the number of PVC status reporting cannot fit in one STATUS message.

NOTE – This annex shows only the changes to clause 11.

General requirements concerning the use of the segmentation capability:

- 1) It is optional for the network to support the segmentation capability.
- 2) The use of the segmentation capability is determined by bilateral agreement between the network and the user at subscription time.
- 3) The segmentation capability is used only to overcome the limitation caused by the frame size. It is used when it is not possible to include all full status reports in a single message.

G.2 List of changes to clause 11

G.2.1 Clause 11.3.2 Report type

A new code point is added to the report type (octet 3):

0000 0100 Full status continued (Note)

NOTE – This code point is used when the status of all PVCs cannot fit in a single STATUS message.

G.2.2 Procedures

- 1) Clause 11.4.1.1 Periodic polling. Item 1) is modified as follows:

Upon expiry of T391, the user equipment sends a STATUS ENQUIRY message to the network and resets its polling timer (T391). The T391 interval between such messages is called the polling interval.

The network may respond to a *full status* STATUS ENQUIRY message with a *full status continued* STATUS message. This indicates that the message contains only a partial list of PVC Status IEs. Upon receipt of a *full status continued* STATUS message, the user equipment must continue to request PVC status by sending *full status continued* STATUS ENQUIRY messages (without waiting for the next T391 interval). The user equipment will restart timer T391 each time it receives a *full status continued* STATUS message and subsequently transmits a *full status continued* STATUS ENQUIRY message. When the network responds with a *full status* STATUS message, all PVC Status IEs have been reported.

The user equipment is responsible for "pacing" of multiple *full status continued* STATUS ENQUIRY messages to control the rate of the request/response messaging.

- 2) The following is added to item 2):

The expiry of T391 will initiate sending of either the *link integrity verification status only* or the *full status* STATUS ENQUIRY. That is, every N391 expiry of T391 will initiate sending of the *full status* STATUS ENQUIRY – the remaining (N391 – 1) expiries will initiate sending of the *link integrity verification only* STATUS ENQUIRY. Sending of the *full status continued* STATUS ENQUIRY has no effect on the N391 count.

- 3) The following is added to item 3):

If the network cannot fit status for all PVCs in a single *full status* STATUS message, the network responds to a *full status* STATUS ENQUIRY message with a *full status continued* STATUS message. The network responds with a *full status* STATUS or *full status continued* STATUS message starting at the next DLCI that follows the last PVC Status IE reported by the network in the previous STATUS message. (The *full status* STATUS response is sent when the network can fit all remaining PVC Status IEs in the message).

For each *full status continued* STATUS message, the user equipment shall interpret omission of a previously reported PVC *up to the last DLCI received in the last PVC Status IE of that full status continued STATUS message* as an indication that the PVC is no longer provisioned. Once the final *full status* STATUS message is received, DLCIs with values greater than the last PVC Status IE can be considered no longer provisioned for the bearer channel.

G.2.3 Bidirectional procedures

The enhanced procedures supporting signalling of the full status continued STATUS and STATUS ENQUIRY messages may also apply to the optional bidirectional network procedures.

Annex H

Procedures defined in X.36 clause 11 and Q.933 Annex A

Q.933 Annex A defines procedures for the management of Frame Relay PVCs. It is extensively referenced in industry documentation. Accordingly, to ensure that existing implementations can claim compliance, the procedures defined in Q.933 Annex A remain in force.

It should be carefully noted that although the wording in X.36 clause 11 is not identical to that in Q.933 Annex A, the defined functionality is technically aligned. That is, the capabilities derived from the procedures defined in clause 11 are the same as those defined in Q.933 Annex A. Additionally, the X.36 PVC signalling capabilities have been enhanced by the development of a segmentation capability for the Status Enquiry Message.

Equipment manufacturers and network service providers are encouraged to adopt X.36 clause 11 as the reference to the PVC management procedures in their product and service specifications.

It is suggested that in the cases where ITU-T Rec. X.36 has been used as the definitive reference in equipment and network service specifications, the following clarifying note would be appropriate.

NOTE – Compliance to ITU-T Rec. X.36 clause 11 implies compliance to ITU-T Rec. Q.933 Annex A procedures.

Appendix I

Examples of PVC management error events

I.1 Loss of STATUS ENQUIRY message

The loss of a STATUS ENQUIRY message may be due to failure on the DTE/DCE interface. When STATUS ENQUIRY message is lost, T392 expires and the DCE counts an error event.

Since no STATUS message is transmitted by the DCE in such a case, T391 expires and the DTE counts an error event (see Figure I.1).

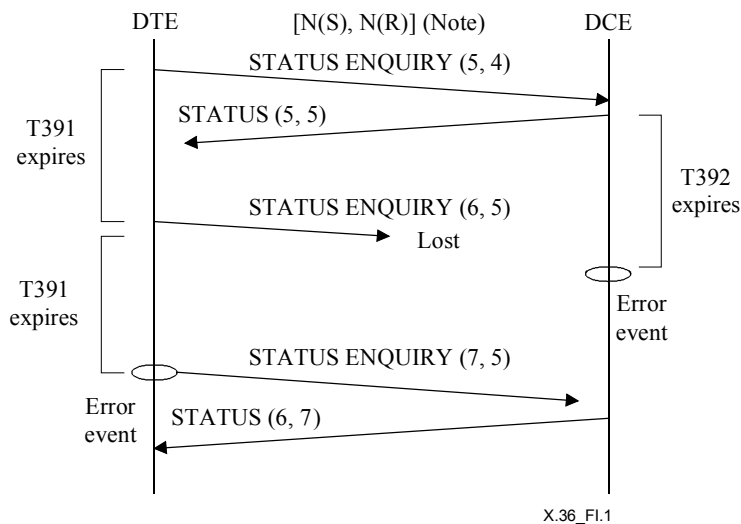

NOTE – For each STATUS message and STATUS ENQUIRY message (.) stands for sequence number [N(S), N(R)] sent in those messages.

Figure I.1/X.36 – Error event by STATUS ENQUIRY message loss

I.2 Loss of STATUS message

The loss of a STATUS message may be due to a DTE/DCE interface failure. When the STATUS message is lost, T391 expires and the DTE counts an error event. The DTE transmits a new STATUS ENQUIRY message. Upon reception of this STATUS ENQUIRY message, the DCE counts an error event since its last send sequence number is not equal to the receive sequence number contained in the STATUS ENQUIRY message (see Figure I.2).

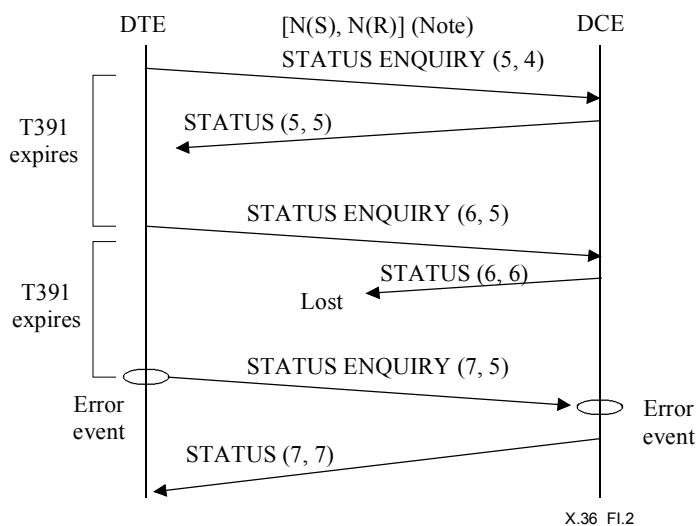

NOTE – For each STATUS message and STATUS ENQUIRY message (.) stands for sequence number [N(S), N(R)] sent in those messages.

Figure I.2/X.36 – Error event by STATUS message loss

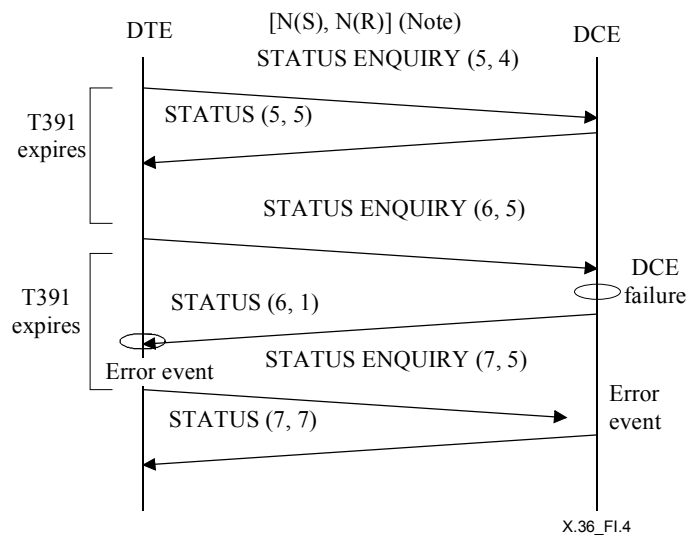

NOTE – For each STATUS message and STATUS ENQUIRY message (.) stands for sequence number [N(S), N(R)] sent in those messages.

Figure I.4/X.36 – Error event by Receive Sequence Number error in a STATUS message

Appendix II

DTE congestion detection methods and actions

The DTE may detect network congestion either through implicit or explicit detection. This appendix describes the methods used by the DTE to detect network congestion and the recommended action to be taken by the DTE at such times of congestion. More detailed information can be found in Appendix I/Q.922.

II.1 Implicit congestion detection

The DTE has the capability of automatically detecting congestion without receiving explicit congestion notification from the network. When the network becomes heavily congested, there is a high probability that frames will be discarded. Thus, to avoid further frame loss, the DTE should recognize congestion has occurred in the network when it detects that the number or percentage of discarded frames exceeds a specified threshold. Examples of methods which might be used to detect congestion include the assignment of sequence numbers to frames by the upper-level protocol or the use of the layer 2 procedure (e.g., timer or REJ frame) for use in detecting missing frames. The process whereby the DTE automatically detects a state of congestion without receiving notification of the congestion from the network is known as implicit congestion detection. When a state of congestion has been implicitly detected, the DTE must reduce the traffic to the network to control the overall flow. More information of the method of control can be found in Appendix I/Q.922.

II.2 Explicit congestion detection

At times of congestion, the network may use the BECN/FECN bits setting or CLLM message to inform the DTEs of the state of congestion, and require the DTE to reduce the traffic. At times of congestion the network may attempt to avoid further congestion by requesting the DTEs to reduce the traffic to the network. Continued congestion may result in the discarding of frames which will influence the communications quality.

Appendix III

Handling of physical layer loopback conditions when using frame relay PVC bidirectional procedures

III.1 Recommended procedures for DTE/DCE that can detect loopback at the physical layer

DTE/DCE should internally remove the interface from service as long as they can detect physical layer loopback conditions. It is strongly recommended that the DTE/DCE declares a service affecting condition at the DTE/DCE interface for the duration of the loopback condition.

III.2 Recommended procedures for DTE/DCE that cannot detect loopback at the physical layer

DTE/DCE that cannot detect loopback at the physical layer may perform the following sequence number processing to handle a loopback condition.

NOTE 1 – The procedures described here cannot detect the loopback is occurring at the physical layer. They only detect there is a loopback condition somewhere on the interface.

The DTE/DCE suspects a loopback condition exists if the send sequence number on a STATUS message received by a procedure is equal to the send sequence count of the opposite procedure (i.e., if the send sequence number of a received STATUS is equal to the send sequence count of the polling response procedure, or if the send sequence number of a received STATUS ENQUIRY is equal to the send sequence count of the polling initiation procedure). A STATUS message meeting this condition is discarded. The DTE/DCE then attempts to confirm the loopback condition.

NOTE 2 – Both DTE and DCE on an interface starting with the same send sequence number produces an initial false loopback condition. It is strongly recommended that the send sequence counts for the polling initiation and polling response procedures of both DTE and DCE be initialized to unique and different values. This significantly reduces the probability of an initial false loopback condition.

The procedure that suspects a loopback condition confirms it by incrementing its send sequence count by a value that may be fixed or randomly generated before it sends the next STATUS message (i.e., if the polling initiation procedures suspect loopback, the send sequence number of the next STATUS ENQUIRY is incremented by this value. If the polling response procedures suspect loopback, the send sequence number of the STATUS response is incremented by this value). A bilateral agreement should be reached to ensure that the DTE and DCE do not use the same sequence number. If the next STATUS message received by the procedure opposite the one suspecting the loopback condition contains a send sequence number that matches the incremented send sequence count, the loopback condition is confirmed. The STATUS message with the matching send sequence number is discarded.

Once the loopback condition is confirmed, each STATUS message received that meets the loopback condition is discarded. This results in a service affecting condition until the loopback condition is cleared.

The DTE/DCE detects that the loopback has been cleared when it receives N392 consecutive status messages where the send sequence number of the received STATUS message does not match the send sequence count of the opposite procedures.

Appendix IV

Information on address

IV.1 Main address and complementary address

A DTE address may include two components: a main address and a complementary address.

IV.1.1 Main address

The main address corresponds to the part of the DTE address the network may interpret. It conforms either to formats described in ITU-T Recs X.121 and X.301 or to formats described in ITU-T Rec. E.164.

IV.1.2 Complementary address

A complementary address is an address information additional to the main address, which may be used, for instance, for routing purposes inside the DTE.

Some networks allow the DTE to include a complementary address. When a complementary address is permitted by the network, the DTE is not obliged to use this complementary address. The complementary address may be as long as possible in considering the maximum length of the information element that contains the DTE address (i.e., calling party number, called party number and connected number information elements).

When a complementary address is contained in an information element of a message transmitted by the network to the DTE, this complementary address is always passed transparently from the remote DTE: it means that the network never creates a complementary address from itself.

When the type of number contained in an information element received by the DCE is set to "complementary address without main address", the DCE shall insert the main address before the complementary address to obtain a complete DTE address to be sent to the remote DTE.

When a complementary address is invoked in the following clauses, it is supposed that the network supports the use of complementary addresses.

IV.2 Addresses in SETUP message

Table IV.1 describes the possible types of address for calling party number and called party number information elements in SETUP messages.

Table IV.1/X.36 – Type of address in SETUP message

Information element	Calling DTE interface	Called DTE interface
Calling party number	All defined values.	All defined values except "complementary address without main address".
Called party number	All defined values except "complementary address without main address".	All defined values.

IV.3 Addresses in CONNECT message

Table IV.2 describes the possible types of address for connected number information element in CONNECT message.

Table IV.2/X.36 – Type of address in CONNECT message

Information element	Calling DTE interface	Called DTE interface
Connected number	All defined values except "complementary address without main address".	All defined values.

IV.4 Addresses processing by the network in SETUP message

Table IV.3 describes addresses processing by the network in SETUP message.

Table IV.3/X.36 – Addresses processing in SETUP message

Information element	Calling DTE interface	Called DTE interface
Called party number	Called DTE address must be present: main address possibly followed by a complementary address.	Called DTE address may be present. When present it can be either a main address, the main address plus a complementary address or the complementary address without the main address.
Calling party number	Calling DTE address may be present. When present it can be either a main address possibly followed by a complementary address or a complementary address without the main address.	Calling DTE address must be present: main address possibly followed by a complementary address.

IV.5 Addresses processing by the network in CONNECT message

Table IV.4 describes addresses processing by the network in CONNECT message.

Table IV.4/X.36 – Address processing in CONNECT message

Information element	Called DTE interface	Calling DTE interface
Connected number	Connected number may be present. When present it can be either a main address possibly followed by a complementary address or a complementary address without the main address.	Connected number may be present if it differs from the called party number presented in the SETUP message by the DCE at the called interface. When present the connected number must be a main address possibly followed by a complementary address.

Appendix V

International network identification according to ITU-T Rec. X.125 for networks providing frame relay services and numbered under the E.164 numbering plan

V.1 Introduction

For those public frame relay networks numbered under the E.164 numbering plan, the International identifier will consist of E.164 Country Code followed by a network identifier code. The maximum length of the International identifier is 8 octets (digits) coded according to ITU-T Rec. T.50. Only numeric values (0-9) shall be used.

Whilst the assignment of these network identification codes is a national matter, regular publication of such information is required to be made available to both users and operators of public frame relay networks.

V.2 Assignment and notification process

ITU-T Rec. X.125 defines the procedures for the assignment by a national authority and notification of ITU-T of the allocated network identification codes, in order that this information can be maintained in a central register and published on a regular basis.

The assignment of network identification codes to frame relay networks numbered under the E.164 numbering plan, in order to create an international identifier, is a purely national matter and will be made by a national authority in accordance with national laws and regulations or agreed national arrangements. The allocating authority will notify the Telecommunications Standardization Bureau (TSB) of any new or revised assignments. Assignments of frame relay network identification codes will be published in the ITU Operational Bulletin. A recapitulatory list is published annually in the Operational Bulletin.

Appendix VI

Call state diagrams at the DCE side of the DTE/DCE interface and DCE actions

VI.1 Foreword

The purpose of this appendix is to provide an overview of the call set-up and call clearing procedure, as seen at the interface level. Error cases and timer recovery procedures are not described.

VI.2 Symbol definition of the call state diagrams

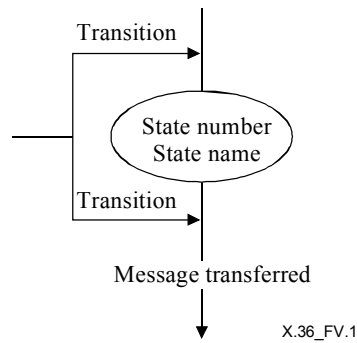

NOTE 1 – Each call state is represented by an ellipse wherein the state name and number are indicated.

NOTE 2 – Each state transition is represented by an arrow. The action on the arrow is the action at the DCE side of the DTE/DCE interface.

VI.3 Call state diagrams

See Figures VI.1, VI.2 and VI.3.

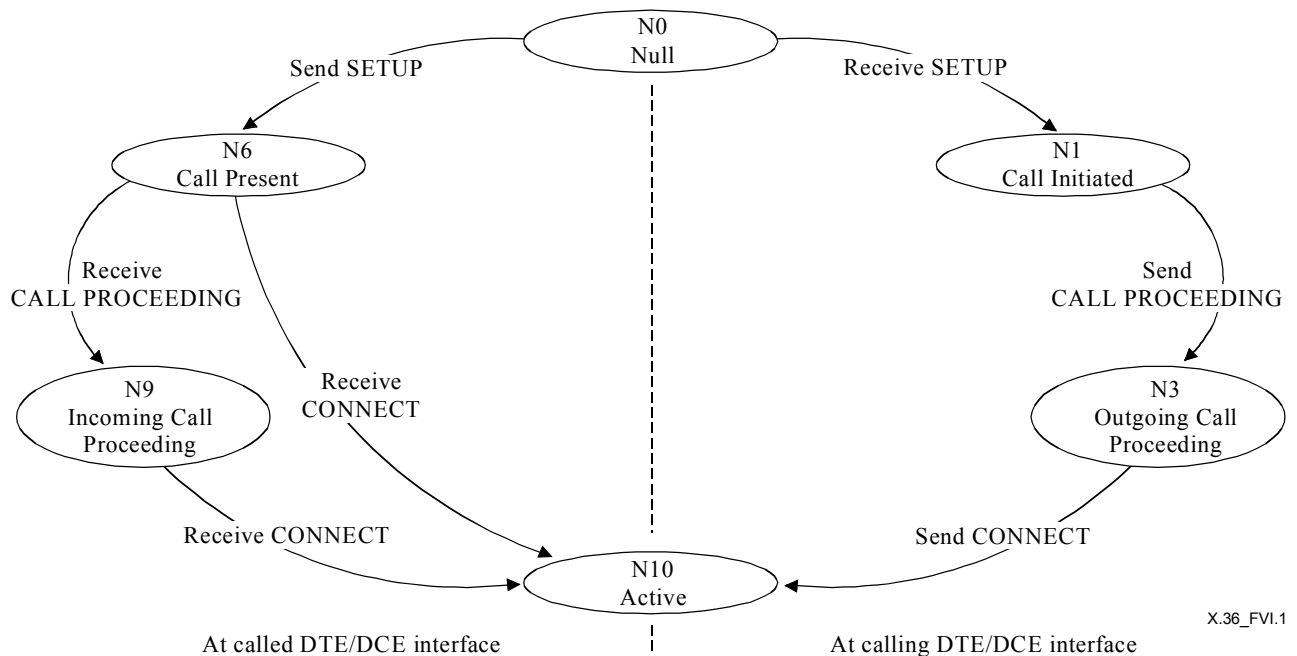

Figure VI.1/X.36 – Diagram of call states for the transfer of call establishment messages at the DCE side of the DTE/DCE interface

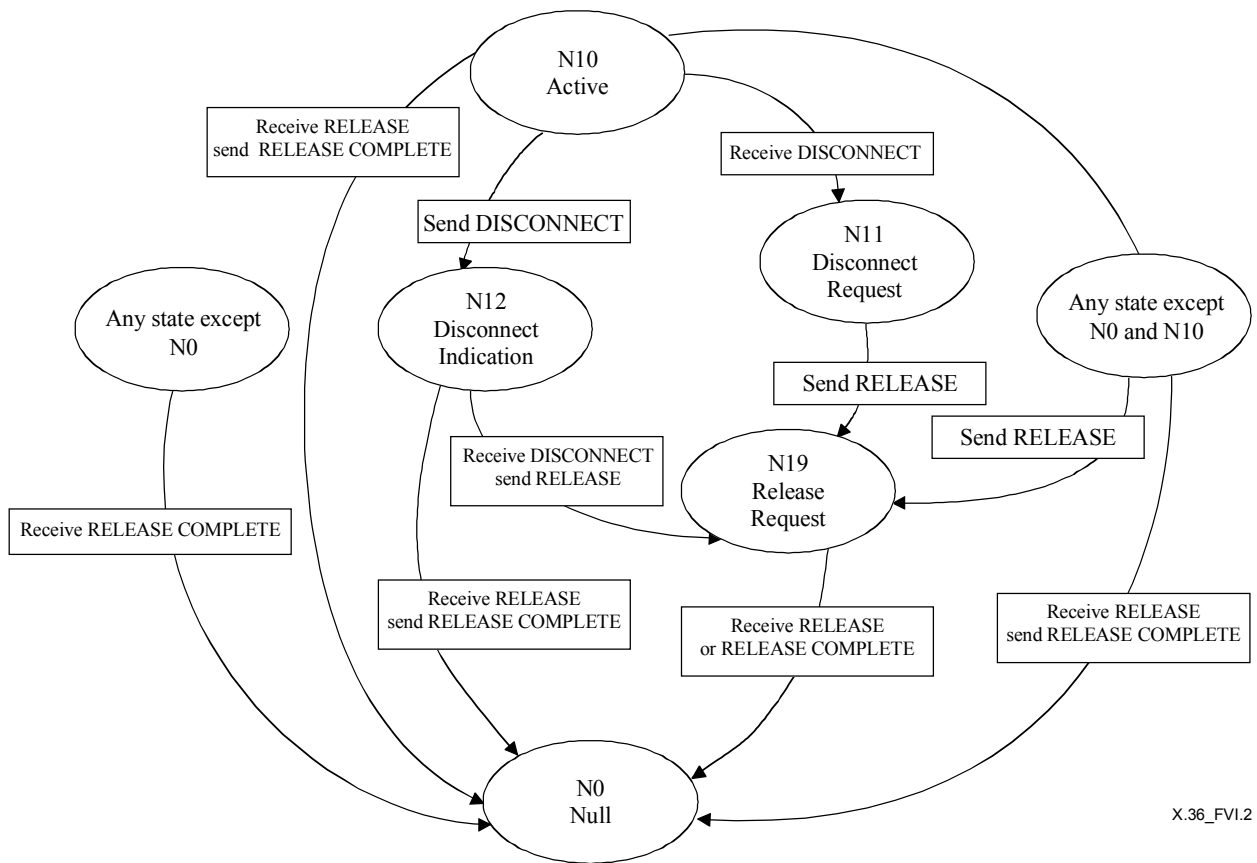
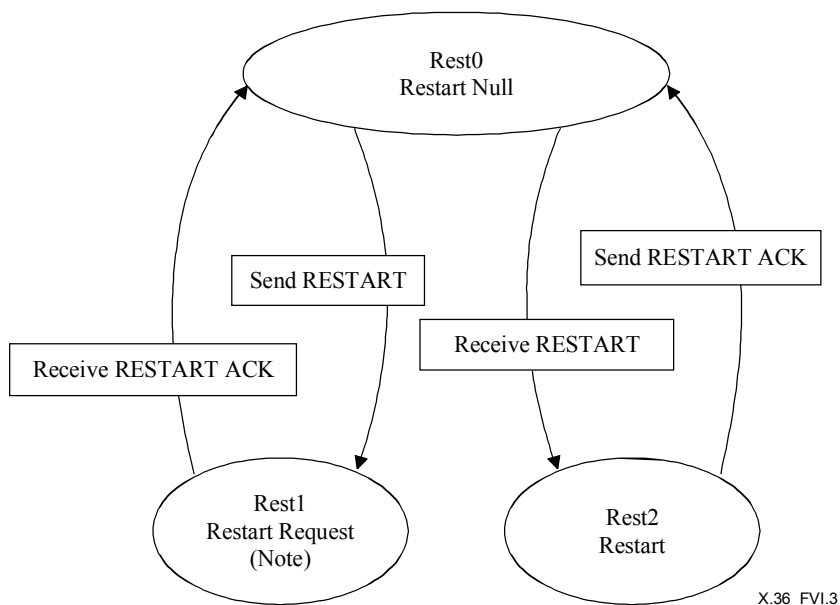

Figure VI.2/X.36 – Diagram of call states for the transfer of call clearing messages at the DCE side of the DTE/DCE interface



NOTE – A RESTART message received in the Restart Request State triggers an independent restart procedure as described in 10.9.1.

Figure VI.3/X.36 – Diagram of call states for the transfer of restart messages at the DCE side of the DTE/DCE interface

VI.4 Actions taken by the DCE on receipt of message in a given call state at the DCE side of the DTE/DCE interface

See Tables VI.1 and VI.2.

Table VI.1/X.36 – Actions taken by the DCE on receipt of message in a given call state at the DCE side of the DTE/DCE interface: call set-up and clearing procedure

Call state at the DCE side	N0 (Null)	N1 (Call Initiated)	N3 (Outgoing Call Proceeding)	N6 (Call Present)	N9 (Incoming Call Proceeding)	N10 (Active)	N11 (Disconnect Request)	N12 (Disconnect Indication)	N19 (Release Request)
Message from the DTE									
SETUP	NORMAL (N1)	DISCARD	DISCARD	DISCARD	DISCARD	DISCARD	DISCARD	DISCARD	DISCARD
CALL PROCEEDING	ERROR #81	ERROR #98	ERROR #98	NORMAL (N9)	ERROR #98	ERROR #98	ERROR #98	ERROR #98	ERROR #98
CONNECT	ERROR #81	ERROR #98	ERROR #98	NORMAL (N10)	NORMAL (N10)	ERROR #98	ERROR #98	ERROR #98	ERROR #98
DISCONNECT	ERROR #81	ERROR #98	ERROR #98	ERROR #98	ERROR #98	NORMAL (N11)	ERROR #98	ERROR #98	ERROR #98
RELEASE	ERROR #81	NORMAL Send Release complete (N0)	NORMAL Send Release complete (N0)	NORMAL Send Release complete (N0)	NORMAL Send Release complete (N0)	NORMAL Send Release complete (N0)	NORMAL Send Release complete (N0)	NORMAL Send Release complete (N0)	NORMAL Send Release complete (N0)
RELEASE COMPLETE	NORMAL (N0)	ERROR (N0)	ERROR (N0)	ERROR (N0)	NORMAL (N0)	ERROR (N0)	ERROR (N0)	ERROR (N0)	NORMAL (N0)
STATUS ENQUIRY	NORMAL #30	NORMAL #30	NORMAL #30	NORMAL #30	NORMAL #30	NORMAL #30	NORMAL #30	NORMAL #30	NORMAL #30
STATUS	NORMAL STATUS	NORMAL STATUS	NORMAL STATUS	NORMAL STATUS	NORMAL STATUS	NORMAL STATUS	NORMAL STATUS	NORMAL STATUS	NORMAL STATUS

Table VI.2/X.36 – Actions taken by the DCE on receipt of message in a given state at the DCE side of the DTE/DCE interface: restart procedure

Call state at the DCE side	Rest0 (Null)	Rest1 (Restart request)	Rest2 (Restart)
Message from the DTE			
RESTART	NORMAL (Rest2)	Initiate Independent Restart procedure as described in 10.9.1	NORMAL (Rest2)
RESTART ACK	DISCARD	NORMAL (Rest0)	DISCARD

The actions taken by the DCE are indicated in the following way:

- NORMAL (Ni): The action taken by the DCE follows the procedure as defined in 10.7 and the DCE enters state Ni;
- DISCARD: The DCE discards the received message and takes no subsequent action as a direct result of receiving that message; the DCE remains in the same state;
- ERROR #98: The DCE discards the received message, returns a STATUS message with cause No. 98 and the DCE remains in the same state;
- ERROR #81: The DCE discards the received message, returns a RELEASE COMPLETE message with cause No. 81 and the DCE remains in the Null state (N0);

- ERROR (N0): The action taken by the DCE follows the procedure as defined in 10.10.4 and the DCE enters state N0;
- NORMAL #30: The DCE returns a STATUS message, reporting the current call state with cause No. 30 and the DCE remains in the same state;
- NORMAL STATUS: The action taken by the DCE follows the procedure as defined in 10.8.

Appendix VII

Window size for a data link layer protocol

(This appendix does not form an integral part of this Recommendation. This appendix was previously Appendix I/Q.933 (1995).)

This appendix may be used to negotiate the window size parameter of the data link layer protocol. The following formula should be used to calculate the window size:

$$k = 2 + \frac{T_{td} \times R_u}{4 \times L_d}$$

where:

L_d data frame size in octets;

R_u throughput bits/sec;

T_{td} end-to-end transit delay in sec;

k window size (maximum number of outstanding I frames).

The window size should be negotiated as follows. The originating user should calculate k using the above formula substituting Maximum end-to-end transit delay and outgoing maximum frame size for T_{td} and L_d respectively. The SETUP message shall include the link layer protocol parameters, the link layer core parameters, and the end-to-end transit delay information elements. The destination user should calculate its own k using the above formula substituting cumulative end-to-end transit delay and its own outgoing maximum frame size for T_{td} and L_d respectively. The CONNECT message shall include the link layer core parameters and the end-to-end transit delay information element so that the originating user can adjust its k based on the information conveyed in these IEs. The originating user should calculate k using the above formula substituting cumulative end-to-end transit delay and Incoming maximum frame size for T_{td} and L_d respectively.

SERIES OF ITU-T RECOMMENDATIONS

Series A	Organization of the work of ITU-T
Series B	Means of expression: definitions, symbols, classification
Series C	General telecommunication statistics
Series D	General tariff principles
Series E	Overall network operation, telephone service, service operation and human factors
Series F	Non-telephone telecommunication services
Series G	Transmission systems and media, digital systems and networks
Series H	Audiovisual and multimedia systems
Series I	Integrated services digital network
Series J	Cable networks and transmission of television, sound programme and other multimedia signals
Series K	Protection against interference
Series L	Construction, installation and protection of cables and other elements of outside plant
Series M	TMN and network maintenance: international transmission systems, telephone circuits, telegraphy, facsimile and leased circuits
Series N	Maintenance: international sound programme and television transmission circuits
Series O	Specifications of measuring equipment
Series P	Telephone transmission quality, telephone installations, local line networks
Series Q	Switching and signalling
Series R	Telegraph transmission
Series S	Telegraph services terminal equipment
Series T	Terminals for telematic services
Series U	Telegraph switching
Series V	Data communication over the telephone network
Series X	Data networks and open system communications
Series Y	Global information infrastructure and Internet protocol aspects
Series Z	Languages and general software aspects for telecommunication systems