



INTERNATIONAL TELECOMMUNICATION UNION

ITU-T

TELECOMMUNICATION
STANDARDIZATION SECTOR
OF ITU

X.149

(10/2003)

SERIES X: DATA NETWORKS AND OPEN SYSTEM
COMMUNICATIONS

Public data networks – Network aspects

**Performance of IP networks when supported by
public Frame Relay data networks**

ITU-T Recommendation X.149

ITU-T X-SERIES RECOMMENDATIONS
DATA NETWORKS AND OPEN SYSTEM COMMUNICATIONS

PUBLIC DATA NETWORKS	
Services and facilities	X.1–X.19
Interfaces	X.20–X.49
Transmission, signalling and switching	X.50–X.89
Network aspects	X.90–X.149
Maintenance	X.150–X.179
Administrative arrangements	X.180–X.199
OPEN SYSTEMS INTERCONNECTION	
Model and notation	X.200–X.209
Service definitions	X.210–X.219
Connection-mode protocol specifications	X.220–X.229
Connectionless-mode protocol specifications	X.230–X.239
PICS proformas	X.240–X.259
Protocol Identification	X.260–X.269
Security Protocols	X.270–X.279
Layer Managed Objects	X.280–X.289
Conformance testing	X.290–X.299
INTERWORKING BETWEEN NETWORKS	
General	X.300–X.349
Satellite data transmission systems	X.350–X.369
IP-based networks	X.370–X.399
MESSAGE HANDLING SYSTEMS	X.400–X.499
DIRECTORY	X.500–X.599
OSI NETWORKING AND SYSTEM ASPECTS	
Networking	X.600–X.629
Efficiency	X.630–X.639
Quality of service	X.640–X.649
Naming, Addressing and Registration	X.650–X.679
Abstract Syntax Notation One (ASN.1)	X.680–X.699
OSI MANAGEMENT	
Systems Management framework and architecture	X.700–X.709
Management Communication Service and Protocol	X.710–X.719
Structure of Management Information	X.720–X.729
Management functions and ODMA functions	X.730–X.799
SECURITY	X.800–X.849
OSI APPLICATIONS	
Commitment, Concurrency and Recovery	X.850–X.859
Transaction processing	X.860–X.879
Remote operations	X.880–X.899
OPEN DISTRIBUTED PROCESSING	X.900–X.999

For further details, please refer to the list of ITU-T Recommendations.

ITU-T Recommendation X.149

Performance of IP networks when supported by public Frame Relay data networks

Summary

The key objective of this Recommendation is to provide an estimate of the IP layer performance obtained in the case where Frame Relay network infrastructure is used to provide the lower layer connectivity to transport the IP packets between the routers.

Mappings between Frame Relay and IP performance parameters are presented. Numerical values of IP performance parameters are estimated based on the objective values specified for the Frame Relay performance parameters specified in ITU-T Rec. X.146.

A general model for the calculation of transfer delay is presented. This model can be used to assist in the planning of networks. The analysis presented provides an upper bound on the performance that could be achieved by an IP network when carried over a Frame Relay network.

The performance mappings between FR and IP networks specified are seen as complementary to ITU-T Rec. Y.1541, since ITU-T Rec. Y.1541 is technology independent with regard to the provision of the physical and link layers. Accordingly, this Recommendation does not specify end-to-end performance objectives, but illustrates the way in which the Y.1541 objectives could be supported.

Source

ITU-T Recommendation X.149 was approved by ITU-T Study Group 17 (2001-2004) under the ITU-T Recommendation A.8 procedure on 29 October 2003.

Keywords

Frame Relay networks, IP networks, Performance.

FOREWORD

The International Telecommunication Union (ITU) is the United Nations specialized agency in the field of telecommunications. The ITU Telecommunication Standardization Sector (ITU-T) is a permanent organ of ITU. ITU-T is responsible for studying technical, operating and tariff questions and issuing Recommendations on them with a view to standardizing telecommunications on a worldwide basis.

The World Telecommunication Standardization Assembly (WTSA), which meets every four years, establishes the topics for study by the ITU-T study groups which, in turn, produce Recommendations on these topics.

The approval of ITU-T Recommendations is covered by the procedure laid down in WTSA Resolution 1.

In some areas of information technology which fall within ITU-T's purview, the necessary standards are prepared on a collaborative basis with ISO and IEC.

NOTE

In this Recommendation, the expression "Administration" is used for conciseness to indicate both a telecommunication administration and a recognized operating agency.

Compliance with this Recommendation is voluntary. However, the Recommendation may contain certain mandatory provisions (to ensure e.g. interoperability or applicability) and compliance with the Recommendation is achieved when all of these mandatory provisions are met. The words "shall" or some other obligatory language such as "must" and the negative equivalents are used to express requirements. The use of such words does not suggest that compliance with the Recommendation is required of any party.

INTELLECTUAL PROPERTY RIGHTS

ITU draws attention to the possibility that the practice or implementation of this Recommendation may involve the use of a claimed Intellectual Property Right. ITU takes no position concerning the evidence, validity or applicability of claimed Intellectual Property Rights, whether asserted by ITU members or others outside of the Recommendation development process.

As of the date of approval of this Recommendation, ITU had not received notice of intellectual property, protected by patents, which may be required to implement this Recommendation. However, implementors are cautioned that this may not represent the latest information and are therefore strongly urged to consult the TSB patent database.

© ITU 2004

All rights reserved. No part of this publication may be reproduced, by any means whatsoever, without the prior written permission of ITU.

CONTENTS

	Page
1 Scope	1
2 References.....	1
3 Definitions	2
3.1 Definition of IP and Frame Relay performance parameters.....	2
4 Abbreviations.....	3
5 Conventions	4
6 General model for interconnecting IP routers via Frame Relay	4
7 Layered model of performance for IP services.....	5
8 Generic IP service performance model.....	6
8.1 Network components, circuit sections and network sections.....	6
8.2 Reference path for UNI-to-UNI Quality of Service assessment	6
9 Encapsulation of an IP packet into a Frame Relay frame.....	7
10 Analytical relationship between IP and Frame Relay performance parameters.....	8
10.1 Loss performance	8
10.2 Delay performance	8
10.3 IP Delay Variation (IPDV) performance.....	8
11 Mapping IP performance to Frame Relay QoS classes	9
11.1 Mapping of FLR to IPLR	9
11.2 Mapping of FRTD to IPTD	10
12 Implications for planning IP networks	10
Annex A – General transfer delay model.....	10
A.1 Transfer delay model.....	10
A.2 Components of delay	11
Annex B – Use of the transfer delay model in planning IP networks.....	13
B.1 Use of the transfer delay model.....	13
B.2 Design of an IP section to meet the Classes 0 and 2 IPTD objective.....	14
Appendix I – Effect of packet/frame size on the IP transfer delay	16
I.1 Estimate of IP packet transfer delay using the model	16
Appendix II – Use of Frame Relay for support of the IP service classes defined in ITU-T Rec. Y.1541	18
II.1 Simple interconnection of IP routers.....	18
II.2 Calculation of end-to-end delay	19
II.3 Estimation of the IPDV	20
II.4 Estimation of IP Packet Loss ratio (IPLR).....	20
Appendix III – General network architecture for an IP network	21
III.1 General network architecture for an IP network	21
III.2 IP access network reference model	21

	Page
Appendix IV – Definition of network components, circuit sections and network sections.....	22
IV.1 Network components	22
IV.2 Circuit sections and network sections	23
Appendix V – IP network QoS classes (as per ITU-T Rec. Y.1541)	24

ITU-T Recommendation X.149

Performance of IP networks when supported by public Frame Relay data networks

1 Scope

The key objective of this Recommendation is to specify the end-to-end performance that could be achieved by an IP network when the backbone network providing the connectivity between the IP routers is provided by Frame Relay infrastructure. This Recommendation does not specify end-to-end performance objectives for IP networks. The Recommendation provides an estimate of the IP layer performance obtained when Public Frame Relay Data Networks are used to transport the IP packets and indicates how the IP QoS classes defined in ITU-T Rec. Y.1541 could be supported.

The Recommendation provides an analysis of the mappings between the Frame Relay and IP performance parameters. Numerical values of the expected IP performance parameters are derived from the objective values specified for the Frame Relay Performance parameters as specified in ITU-T Rec. X.146.

Using a general model an analysis of the expected performance for various IP packet sizes (corresponding to various IP applications) and the influence of the Frame Relay network infrastructure (e.g., inter-node transmission trunks) is provided. This analysis provides an upper bound on the performance that could be achieved by an IP network when carried over a Frame Relay network, since the IP network infrastructure could increase both the achieved IP packet transit delay and IP packet loss rate.

This Recommendation, and in particular the performance parameter mappings between Frame Relay and IP networks, is seen as complementary to ITU-T Rec. Y.1541, since ITU-T Rec. Y.1541 is technology independent with regard to the provision of the physical and link layers.

The scope of the Recommendation is limited to IP networks where the link infrastructure is provided by or supported by Public Frame Relay Data Networks.

2 References

The following ITU-T Recommendations and other references contain provisions which, through reference in this text, constitute provisions of this Recommendation. At the time of publication, the editions indicated were valid. All Recommendations and other references are subject to revision; users of this Recommendation are therefore encouraged to investigate the possibility of applying the most recent edition of the Recommendations and other references listed below. A list of the currently valid ITU-T Recommendations is regularly published. The reference to a document within this Recommendation does not give it, as a stand-alone document, the status of a Recommendation.

- ITU-T Recommendation E.651 (2000), *Reference connections for traffic engineering of IP access networks*.
- ITU-T Recommendation G.114 (2003), *One-way transmission time*.
- ITU-T Recommendation G.1000 (2001), *Communications Quality of Service: A framework and definitions*.
- ITU-T Recommendation G.1010 (2001), *End-user multimedia QoS categories*.
- ITU-T Recommendation X.36 (2003), *Interface between Data Terminal Equipment (DTE) and Data Circuit-terminating Equipment (DCE) for public data networks providing frame relay data transmission service by dedicated circuit*.

- ITU-T Recommendation X.76 (2003), *Network-to-network interface between public networks providing PVC and/or SVC frame relay data transmission service.*
- ITU-T Recommendation X.140 (1992), *General quality of service parameters for communication via public data networks.*
- ITU-T Recommendation X.144 (2003), *User information transfer performance parameters for public frame relay data networks.*
- ITU-T Recommendation X.145 (2003), *Connection establishment and disengagement performance parameters for public Frame Relay data networks providing SVC services.*
- ITU-T Recommendation X.146 (2000), *Performance objectives and quality of service classes applicable to frame relay.*
- ITU-T Recommendation Y.1221 (2002), *Traffic control and congestion control in IP-based networks.*
- ITU-T Recommendation Y.1231 (2000), *IP Access Network Architecture.*
- ITU-T Recommendation Y.1540 (2002), *Internet protocol data communication service – IP packet transfer and availability performance parameters.*
- ITU-T Recommendation Y.1541 (2002), *Network performance objectives for IP-based services.*
- IETF RFC 791 (1981), *Internet Protocol, DARPA Internet Program Protocol Specification.*

3 Definitions

The terms and their definitions used in this Recommendation are consistent with those defined in ITU-T Recs X.36, X.76, X.144, X.145, X.146, Y.1231, Y.1540, and Y.1541. Appendix III provides the general network architecture for an IP network as per ITU-T Rec. Y.1231. Appendix IV provides a description (based on ITU-T Rec. Y.1540) of the network components together with the circuit and network sections that provide the building blocks with which any end-to-end IP service may be represented.

3.1 Definition of IP and Frame Relay performance parameters

The definitions (as per ITU-T Rec. Y.1540) of IP Loss Ratio and Frame Loss Ratio are presented here for clarity.

3.1.1 IP Packet performance parameters

3.1.1.1 IP packet loss ratio (IPLR): IP Packet Loss Ratio is the ratio of the total lost IP packet outcomes to total transmitted IP packets in a population of interest. "Lost IP packet outcomes" and "Populations of Interest" are defined in ITU-T Rec. Y.1540.

3.1.1.2 IP packet transfer delay (IPTD): IP packet transfer delay is defined for all successful and errored packet outcomes across a basic section or an NSE. IPTD is the time ($t_2 - t_1$) between the occurrence of two corresponding IP packet reference events, ingress event IPRE₁ at time t_1 and egress event IPRE₂ at time t_2 , where ($t_2 > t_1$) and ($t_2 - t_1$) < T_{max} . Network Section Ensemble (NSE) and IP Reference Events (IPRE) are defined in ITU-T Rec. Y.1540.

3.1.2 Frame Relay performance parameters

The definition of Frame Loss Ratio and Frame Transfer Delay (as per packet transfer X.144) are presented here for clarity.

3.1.2.1 frame loss ratio: The user information Frame Loss Ratio (FLR) is defined as:

$$FLR = \frac{F_L}{F_L + F_S + F_E}$$

where, in a specified population:

- F_S is the total number of successively transferred frame outcomes;
- F_L is the total number of lost frame outcomes; and
- F_E is the total number of residually errored frame outcomes.

The objective values for frame loss ratio specified in the Frame Relay QoS classes in ITU-T Rec. X.146, correspond to a special case of the above ratio. This is the FLR_C . The FLR for frames marked with the discard eligibility bit set to zero $DE = 0$ should remain relatively constant as long as the total $DE = 0$ traffic does not exceed the Committed Information Rate (CIR). If the network accepts all conforming frames, FLR_C is the probability that a $DE = 0$ frame accepted as conforming will subsequently be lost. $DE = 0$ frames relayed with the DE bit changed to $DE = 1$ are included in the calculation of FLR_C .

3.1.2.2 user information frame transfer delay: The user information frame transfer delay (FTD) is defined as:

$$FTD = t_2 - t_1$$

where, in a specified population:

- t_1 is the time of occurrence for the first FE (Frame Layer Reference Event);
- t_2 is the time of occurrence for the second FE;
- $t_2 - t_1 \leq T_{max}$.

and T_{max} is the value used in defining a successfully transferred frame outcome.

4 Abbreviations

This Recommendation uses the following abbreviations:

CPE	Customer Premises Equipment
CPN	Customer Premises Network
DBDJ	Data Block Delay Jitter
DBDR	Data Block Delivered Ratio
DBLR	Data Block Loss Ratio
DBTD	Data Block Transfer Delay
DST	Destination
FCS	Frame Check Sequence
FLR	Frame Loss Ratio
FR	Frame Relay
FTD	Frame Transfer Delay
IP	Internet Protocol
IPDV	IP Delay Variation
IPLR	IP Packet Loss Ratio
IPRE	IP packet transfer Reference Event

IPTD	IP Packet Transfer Delay
PFRDN	Public Frame Relay Data Network
PVC	Permanent Virtual Connection or Permanent Virtual Circuit
SRC	Source
SVC	Switched Virtual Connection or Switched Virtual Circuit
TE	Terminal Equipment
UNI	User-Network Interface
VC	Virtual Connection

5 Conventions

Within this Recommendation the term "Public Frame Relay Data Network" can be used interchangeably with the term "Public Data Network" providing the "Frame Relay Data Transmission Service".

6 General model for interconnecting IP routers via Frame Relay

Figure 1 provides a general model for the interconnection of IP routers via Frame Relay virtual connections. This model applies in both the cases where the IP routers are either CPE Terminal Equipment or Gateway and Intermediate Routers belonging to IP service providers. The model assumes that the IP routers are interfaced to the Frame Relay network using the frame format and protocols defined in ITU-T Rec. X.36. The model applies to both the SVC and PVC cases. This model is a specific case of the general network architecture model for an IP network as defined in ITU-T Rec. Y.1231 (see Appendix III).

Figure 1 is a generalized reference model for an IP environment in which the basic infrastructure elements of an IP network (i.e., IP routing equipment) are interconnected using virtual circuits provided by Public Frame Relay Data Networks. The reference configuration also covers the case where the Frame Relay virtual connection is provided across multiple PFRDNs; i.e., the Frame Relay virtual connections may span more than one national or international transit network. In such cases, it is assumed that Public Frame Relay Data Networks will be interconnected utilizing the network-to-network interface defined in ITU-T Rec. X.76.

Within the context of this Recommendation, the Frame Relay virtual connections are only used to establish connectivity between a pair of IP routers. Accordingly, in establishing an IP network, the required connectivity may be provisioned by a multiplicity of Frame Relay networks. Each router may have multiple FR UNIs in order to connect to various Frame Relay networks.

NOTE – In establishing an IP network it is likely that the interconnecting links will be provided by a variety of lower-layer technologies of which Frame Relay is but one example.

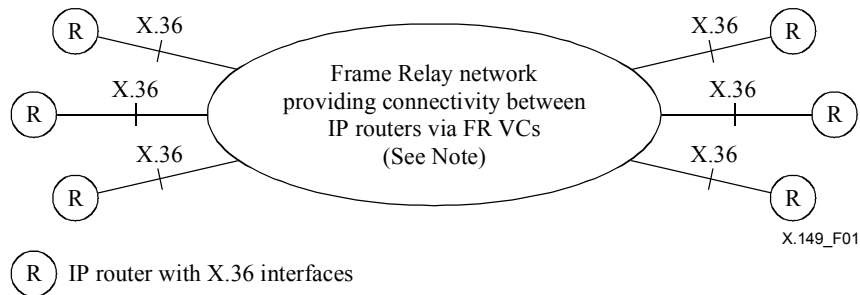

NOTE – The Frame Relay VCs may span more than one national or international FR network

Figure 1/X.149 – Use of Frame Relay VCs for the interconnection of IP routers

7 Layered model of performance for IP services

Figure 2 (an adaptation of the layered performance model defined in ITU-T Rec. Y.1540) illustrates the layered nature of the performance of IP service. (Within the scope of this Recommendation it is assumed that the lower layer connectivity is provided by Frame Relay infrastructure.) The performance provided to IP service users depends on the performance of other layers:

- Lower layers that provide (via "frame relay links") connection-oriented transport supporting the IP layer. Links are terminated at points where IP packets are forwarded (i.e., network routers, source routers and destination routers) and thus, have no end-to-end significance.
- The IP layer that provides connectionless transport of IP datagrams (i.e., IP packets). The IP layer has end-to-end significance for a given pair of source and destination IP addresses. Certain elements in the IP packet headers may be modified by IP network routers, but the IP user data may not be modified at or below the IP layer.
- Higher layers, supported by IP, that further enable end-to-end communications. Upper layers may include, for example, TCP, UDP, FTP, RTP and HTTP. The higher layers will modify and may enhance the end-to-end performance provided at the IP layer.

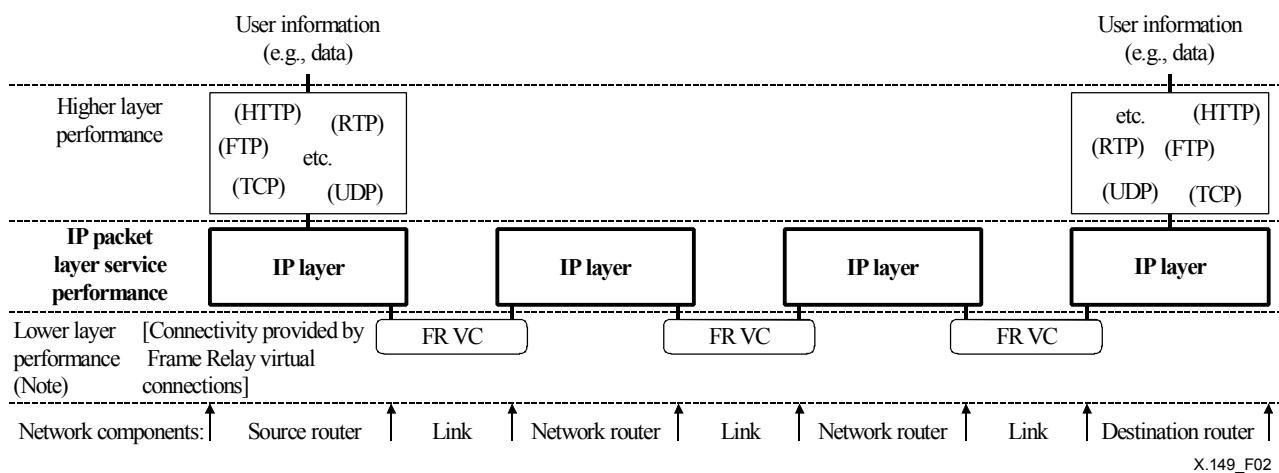

NOTE – For illustrative purposes only; 3 instances of FR VCs provide lower layer connectivity.

Figure 2/X.149 – Layered model of performance for IP service – Example only

8 Generic IP service performance model

This clause utilizes the IP service performance model as defined in ITU-T Rec. Y.1541. The model is primarily composed of two types of sections: IP network sections and circuit sections (internetwork links which provide lower layer connectivity). These sections are formally defined in 5.2/Y.1540. (See also Appendix IV.) The scope of this Recommendation covers the case where the basic infrastructure elements of an IP network (i.e., IP routing equipment) are interconnected using virtual circuits provided by Public Frame Relay Data Networks.

8.1 Network components, circuit sections and network sections

Appendix IV provides a description of the network components together with the circuit and network sections that provide the building blocks by which any end-to-end IP service may be represented.

NOTE – Appendix IV is technically aligned to clauses 5.1 and 5.2/Y.1540 but has been made specific to the case where Frame Relay is providing the lower layer connectivity.

8.2 Reference path for UNI-to-UNI Quality of Service assessment

Figure 3 provides a reference path for the assessment of the end-to-end performance of an IP packet flow. The UNI-to-UNI IP network path includes a set of IP Network Sections (NS) and internetwork links that provide the transport of IP packets transmitted from the UNI at the source side to the UNI at the destination side. Within the scope of this Recommendation it is assumed that the internetwork sections are provided by Frame Relay virtual connections. An IP network section may consist of one or more IP routers. It is also assumed that routers within an IP network section are interconnected utilizing Frame Relay virtual circuits.

NOTE – The performance objectives defined in ITU-T Rec. Y.1541 apply from User-Network Interface to User-Network Interface. The UNI-to-UNI performance objectives are defined for IP performance parameters corresponding to IP packet transfer reference events (IPREs).

In accordance with Y.1541, the IP reference paths have the following attributes:

- 1) IP clouds may support user-to-user connections, user-to-host connections, and other endpoint variations.
- 2) IP network sections may be represented as clouds with gateway routers on their edges, and some number of interior routers with various roles.
- 3) The number of IP network sections in a given path may depend upon the Class of Service offered, along with the complexity and geographic span of each IP network section.
- 4) An IP path may involve one or more network sections.
- 5) The IP network sections supporting the packets in a flow may change during its life.

IP connectivity generally spans international boundaries, and does not follow the traditional ITU packet switched conventions for national and international network portions. For example, there may not be identifiable gateways at an international boundary if the same IP network section is used on both sides of the boundary.

Within the context of this Recommendation, the end-to-end IP flow connectivity is provided by a concatenation of IP routers, Frame Relay switches and transmission links. Hence, the end-to-end performance (as characterized by packet loss, transfer delay and jitter) of an IP flow will be impacted on by both the level of network complexity and the geographic distance spanned.

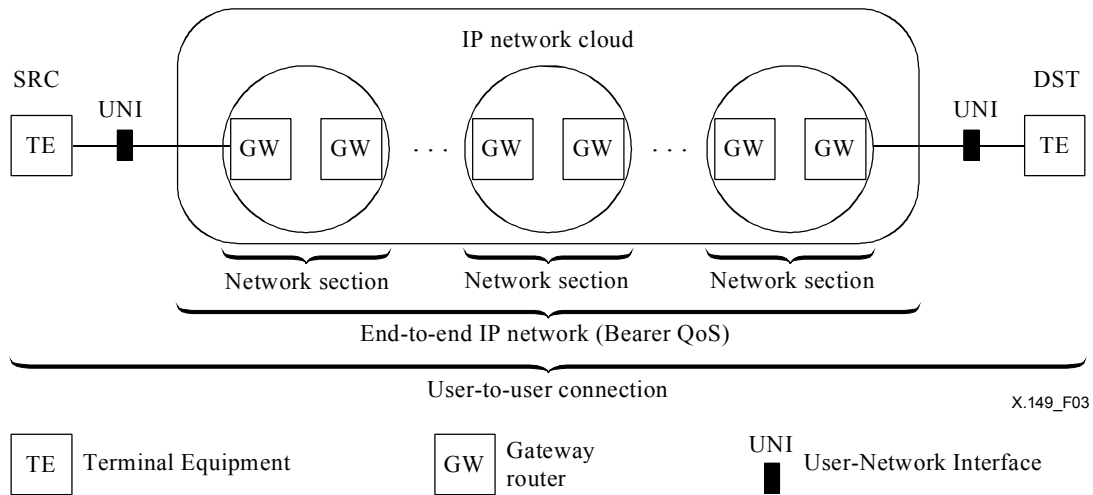

Figure 3/X.149 – UNI-to-UNI reference path for assessing IP QoS objectives

In particular, the following path components will contribute to performance:

- Access line transmission speed (source and destination);
- IP gateway routers (source and destination);
- Intermediate routers along the IP flow path;
- Contributions by Frame Relay virtual connections (FR switches, transmission link speed and propagation delay).

Annex A provides a general model for calculating Transfer Delay and information on the effect of Packet/Frame size and transmission speed on the Transfer Delay.

9 Encapsulation of an IP packet into a Frame Relay frame

The format used for encapsulation of IP datagrams into Frame Relay frames as specified in Annex D/X.36 is described in Figure 4. The protocol identifier is set to hexadecimal CC.

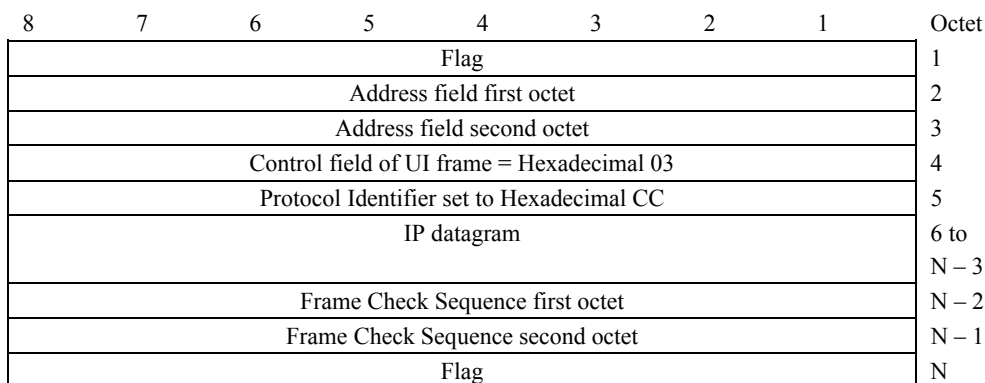

Figure 4/X.149 – Encapsulation of an IP datagram in a X.36 frame

NOTE 1 – Clause 8.2.6/X.36 specifies that all Frame Relay networks shall support a Frame Relay information field size of at least 1600 octets.

NOTE 2 – 1500 bytes is a commonly defined maximum for Ethernet packets.

10 Analytical relationship between IP and Frame Relay performance parameters

In order to develop an analytical relationship between each of the performance parameters defined for the IP and the Frame Relay layers, it is assumed that each IP packet is encapsulated into a single frame. Both the FR and IP protocols allow for varying frame and packet sizes. Hence, in the following analysis it is assumed that segmentation of the IP packet into multiple FR frames is not required. The impact of segmentation is for further study. Since IP packets may be of different sizes depending on the applications, the resulting FR frames will also have different sizes.

10.1 Loss performance

Consider the IP Packet Loss Ratio (IPLR). The probability of the loss of a single frame is given by the Frame Loss Ratio (FLR) as defined in clause 3. Since each IP packet is encapsulated into a single frame, the probability of losing an IP packet is the same as that of losing a FR frame.

Therefore, the minimum IP packet loss is given by: $IPLR = FLR$.

Errored frames are discarded by the frame handlers with a Frame Relay network. Therefore, error performance translates simply into loss at the frame layer. Hence, IP packet loss includes any loss due to error at the physical layer. However, the above relation assumes that the IP routers do not significantly contribute to IP packet loss. The above relation can be used to derive the level of Frame Relay network performance support provided to the IP layer. Also, this relationship is independent of the size of the IP packets.

10.2 Delay performance

In case of delay performance also, it is clearly seen that average IP packet transfer delay is directly related to average frame transfer delay.

Therefore, the minimum IP packet transfer delay is given by: $IPTD = FTD$.

As a first approximation, the IP packet processing delay is treated as a constant and is neglected here. (It is expected that the processing and queuing delay within an IP router will be at least an order of magnitude less than the end-to-end transit delay.) The above equation implies that the transit delay experienced by an IP packet carried in a Frame Relay network is the same as that for frames. The numerical objectives for frame transfer delay in ITU-T Rec. X.146 are specified for frames of length 256 bytes. If IP packets (frames) are of larger sizes, the delay experienced has to be calculated separately.

Annex A provides a general model for calculating transfer delay for various packet sizes and link transmission speeds.

10.3 IP Delay Variation (IPDV) performance

IP Delay Variation (IPDV) is defined in ITU-T Rec. Y.1541 as the maximum IP transfer delay ($IPTD_{max}$) minus the minimum IP transfer delay ($IPTD_{min}$) during a given measurement interval, consisting of a statistically significant number of delay measurements (N).

Since the IP packets are encapsulated in a single frame, as a first approximation we can consider that the IP delay variation to be equivalent to the Frame Delay Jitter (FDJ). However, under heavy traffic loads the IP routers are likely to contribute additional delay variation.

Therefore, the minimum IP Delay Variation is given by: $IPDV = FDJ$.

10.3.1 IPDV components

Since the end-to-end path is a concatenation of access links, IP routers, Frame Relay switches and transmission links, all the nodes (i.e., IP routers and Frame Relay switches) along the path may contribute to the end-to-end IPDV.

10.3.2 IPDV evaluation

In evaluating the end-to-end IPDV, it has to be considered that the behaviour of this parameter accumulates similarly to the standard deviation of roughly independent random variables. When independently random variables are summed, the resulting standard deviation is roughly the square root of the sum of the squares. It can be observed that the allocated IPTDs sum to more than the end-to-end IPDV. The calculation of the IPDV for k nodes uses the following formula:

$$IPDV = \sqrt{\sum_k IPDV_k^2}$$

11 Mapping IP performance to Frame Relay QoS classes

Table 1 shows the Frame Relay QoS classes and the numerical objectives for each of the Performance parameters as specified in ITU-T Rec. X.146.

**Table 1/X.149 – Frame Relay service class performance objectives
(as per ITU-T Rec. X.146)**

FR class	Network support	FLR _C	FTD (ms)
0	Mandatory, default class	No upper bound specified	No upper bound specified
1	Mandatory	Value < 1×10^{-3}	95th percentile < 400
2	Optional	Value < 3×10^{-5}	95th percentile < 400
3	Optional	Value < 3×10^{-5}	95th percentile < 150

These numerical objectives may be used in the analytical relationships (as defined in 10.1 and 10.2) to obtain an estimate of the IP-level performance that can be expected when using the various Frame Relay QoS service classes.

11.1 Mapping of FLR to IPLR

Table 2 shows the mappings for loss ratio. Table 3 shows the IPLR values corresponding to each Frame Relay QoS service class.

**Table 2/X.149 – IPLR values obtained using the
analytical relationship $IPLR = FLR$**

FLR	IPLR
3×10^{-5}	3×10^{-5}
1×10^{-3}	1×10^{-3}

Table 3/X.149 – IPLR values corresponding to each Frame Relay QoS service class

Frame Relay QoS service class	Frame Relay FLR	IPLR 40 bytes	IPLR 576 bytes	IPLR 1500 bytes
1	1×10^{-3}	1×10^{-3}	1×10^{-3}	1×10^{-3}
2	3×10^{-5}	3×10^{-5}	3×10^{-5}	3×10^{-5}
3	3×10^{-5}	3×10^{-5}	3×10^{-5}	3×10^{-5}

11.2 Mapping of FRTD to IPTD

The results of mapping IPTD to Frame Relay FTD are summarized in Table 4. The results for calculations based on 1.544 Mbit/s links in the reference connection are shown for convenience. The IPTD values for 40-byte IP packets is much lower than the specified objective of 400 ms and is not shown here.

Table 4/X.149 – IPTD values corresponding to Frame Relay service class delay objective

Frame Relay service class	95%-ile of FTD (as per ITU-T Rec. X.146)	Estimated 95%-ile of IPTD (Note)		
	Frame size: 256 bytes	< 256 bytes	576 bytes	1500 bytes
1	400 ms	400 ms	430 ms	515 ms
2	400 ms	400 ms	430 ms	515 ms
3	150 ms	150 ms	180 ms	265 ms

NOTE – The IPTD estimate utilizes the delay model described in Annex A. The estimate is based on a FR reference network consisting of 19 FR switches, utilizing 1.544 Mbit/s transmission links and spanning a distance such that the frame transfer delay objective calculated for 256-byte frames for each service class is just met. The use of higher speed transmission links will reduce the delay for large-size packets. See Appendix I for derivation of the IPTD values for 576- and 1500-byte packets.

12 Implications for planning IP networks

The results of the mappings in clause 11 indicate that IP layer loss performance is independent of the packet size when carried by frames. This is due to the fact that the Frame Relay loss objectives in the Frame Relay service classes of ITU-T Rec. X.146 apply to all committed frames regardless of size.

The IP layer performance values are also identical to those for Frame Relay when simple encapsulation of IP packets into frames is used. In the case of delay performance, the size of IP packets has an impact on the end-to-end delay experienced by the packet when encapsulated into a frame and transported across a PFRDN. The objectives for frame transfer delay specified for the Frame Relay QoS classes are for frames of size 256 bytes. Larger-size frames will result in larger clocking delays and will thus impact on achievable end-to-end IP packet delay. ITU-T Rec. Y.1541 specifies an IP packet size of 1500 octets for evaluating performance. Annex A provides a general model for calculating the end-to-end delay. This delay model can be used in planning IP networks as shown in Annex B.

Annex A

General transfer delay model

A.1 Transfer delay model

This annex describes a model that can be used for estimating the transfer delay for an IP flow in the case where the interconnection of the IP routers is provided by Frame Relay virtual connections.

A model illustrating the components of end-to-end delay is shown in Figure A.1. The end-to-end transfer delay is a simple sum of the delay contributions of the clocking (transmission) delay through each node (FR switch or IP router), the propagation delay (distance dependant – 5 ms per

1000 km for a terrestrial connection) of the transmission trunks connecting the nodes and the queuing and processing delay in each node.

The network transit delay can be calculated by a simple model which consists of a concatenation of the delay through each node and across the internode transmission links.

Using this model (as shown in Figure A.1), an active connection can be shown as a series of $(k - 1)$ transmission links (l_1 to l_{k-1}) interconnecting k nodes (N_1 to N_k).

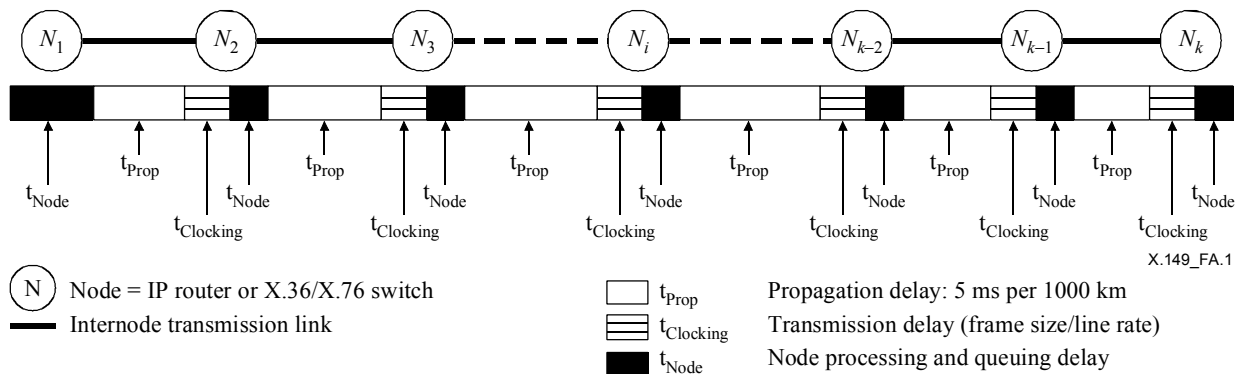

Figure A.1/X.149 – Model illustrating components of transfer delay

Define the following parameters:

- D_i is the mean processing and queuing delay of a node N_i in the path.
- D_{wc_i} is the maximum (worst case) processing and queuing delay of a node N_i in the path.
- L_i is the clocking delay (transmission time) on each internode transmission link l_i .
- T_i is the propagation delay (distance dependant) on each internode transmission link l_i .

The mean (or alternatively the upper-bound/worst-case) transfer delay across the network is readily calculated as:

$$Mean_Delay = \sum_{i=1}^{k-1} L_i + \sum_{i=1}^{k-1} T_i + \sum_{i=1}^k D_i$$

$$Mean_Delay = \sum_{i=1}^{k-1} L_i + \sum_{i=1}^{k-1} T_i + \sum_{i=1}^k D_{Dwc_i}$$

A lower bound is readily obtained when the Node Delay (D_i) is set to zero.

It should be noted that the above expressions are quite general in that both the node processing delays (D_i) and the link clocking delays (L_i) may vary across the path. The nodes can be either FR switches or IP routers.

A.2 Components of delay

A.2.1 Node delay

Node Delay represents the delay through an individual node (IP router or FR switch). This node delay can be further divided into two parts: Queuing delay and routing/switching delay. The routing/switching delay is the delay for processing a frame through the FR switch, or a packet through the IP router, and will be a minimum when there are no frames/packets queued up within the switch/router. The queuing delay is a reflection of the traffic switched through a node, and represents the congestion that can occur in switches or routers, and the resultant additional delay that frames/packets experience waiting to get through the queue.

NOTE – The average node delays within a Frame Relay network can be determined from the overall end-to-end delay measurements, by subtracting the known and fixed propagation and clocking delays that occur on the FR connection. The switching delays can generally be obtained from equipment manufacturer's documentation.

Typical queuing and switching delays for access and core Frame Relay nodes are given in Table A.1.

Table A.1/X.149 – Examples of delay contribution of FR access nodes and FR core nodes

Frame Relay node delay component	Typical value
FR access node – queuing delay	2.5 ms
FR access node – switching delay	~ 50 μ s
FR core node – queuing delay	1 to 2 ms
FR core node – switching delay	~ 50 μ s

Table A.2/X.149 (as per Table III.1/Y.1541) – Examples of typical delay contributions by IP router role

IP router role	Average total delay (sum of queuing and processing)	Delay variation
Access gateway	10 ms	16 ms
Internetworking gateway	3 ms	3 ms
Distribution	3 ms	3 ms
Core	2 ms	3 ms

NOTE – Router contribution to various parameters may vary according to their role. Internetworking gateways typically have performance characteristics different from access gateways.

A.2.2 Clocking delay

Clocking delay is caused by the fact that a node must first wait for a complete frame (or packet) to be clocked into memory, before any processing or switching of that frame (packet) can commence. There is a dependence on both the length of each frame, and the speed at which frames are clocked into the equipment. Table A.3 gives various clocking delays calculated for different transmission rates and frame sizes. Clocking delay of both Access Circuit Sections and Internetwork Circuit Sections can be a significant component of the end-to-end Transfer Delay, in particular in the case where large-sized frames are carried over low-speed transmission links.

NOTE – For the purpose of this Recommendation, low speed is implied to mean transmission rates less than 1.5 Mbit/s.

Table A.3/X.149 – Clocking delay for various transmission rates and frame sizes

Transmission speeds	Frame size (FR information field) (Note)						
	48 bytes	64 bytes	128 bytes	256 bytes	512 bytes	1024 bytes	1500 bytes
64 kbit/s	6.4 ms	8 ms	16 ms	32 ms	64 ms	128 ms	188 ms
128 kbit/s	3.25 ms	4 ms	8 ms	16 ms	32 ms	64 ms	94 ms
256 kbit/s	1.63 ms	2 ms	4 ms	8 ms	16 ms	32 ms	47 ms
512 kbit/s	0.81 ms	1 ms	2 ms	4 ms	8 ms	16 ms	23.5 ms
1024 kbit/s	406 μ s	0.5 ms	1 ms	2 ms	4 ms	8 ms	11.8 ms
1544 kbit/s	269 μ s	0.35 ms	0.68 ms	1.35 ms	2.67 ms	5.3 ms	7.8 ms
2048 kbit/s	203 μ s	0.25 ms	0.5 ms	1 ms	2 ms	4 ms	5.8 ms
34 368 kbit/s	12 μ s	16 μ s	31 μ s	61 μ s	120 μ s	240 μ s	350 μ s
44 736 kbit/s	9.3 μ s	12 μ s	24 μ s	46 μ s	92 μ s	184 μ s	269 μ s
155 520 kbit/s	2.7 μ s	3.5 μ s	7 μ s	13 μ s	27 μ s	53 μ s	77 μ s

NOTE – The frame size refers to the size of the FR information field (containing an IP packet). Also a 2-byte FR header size plus a 2-byte FCS are assumed.

A.2.3 Propagation delay

The propagation delay component represents the physical speed of light constraint on bits travelling over transmission links, and is simply calculated using the known distance between the nodes, and allocating a delay contribution of 5 ms per 1000 km of terrestrial route distance (in accordance with ITU-T Rec. G.114).

A.2.3.1 Impact of a satellite in the FR connection

If a satellite is included in, say, the international portion of the FR connection, the delay allocated to that portion is 270 ms. The other two portions of the FR connection are then allocated 40 ms each. However, the other two national portions could result in higher than 40-ms delay for frame sizes larger than 256 bytes.

Annex B

Use of the transfer delay model in planning IP networks

B.1 Use of the transfer delay model

This annex provides an example on how the general transfer delay model can be used in conjunction with the Y.1541 IP QoS delay objectives for the initial infrastructure planning of an IP network where the connectivity between the IP routers is to be provided by Frame Relay virtual connections.

Consider the delay across the path of an IP network section as shown in Figure B.1. The end-to-end path consists of 2 IP gateway routers and $(k - 2)$ IP nodes. The IP nodes are interconnected using Frame Relay virtual connections.

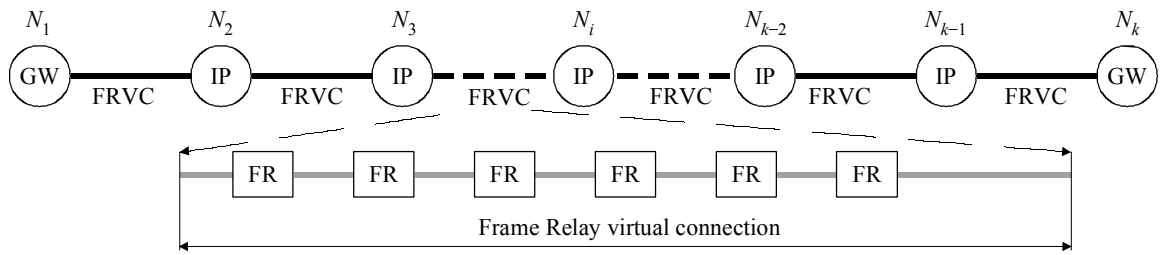

X.149_FB.1

Figure B.1/X.149 – IP network section utilizing FRVCs to provide router connectivity

From Annex A:
$$Mean_Delay = \sum_{i=1}^{k-1} L_i + \sum_{i=1}^{k-1} T_i + \sum_{i=1}^k D_i$$

Define the following parameters:

- k = number of IP routers in the path (including the IP gateways);
- D_{GW} = IP gateway processing delay;
- D_N = IP node processing delay;
- FR_{LD} = Frame Relay link delay (only includes the FR switching and clocking delays).

Hence:

$$IP\ Network\ Section\ Delay = 2 \times D_{GW} + (k - 2) \times D_N + (k - 1) \times FR_{LD} + Propagation\ Delay$$

$$FRLD = 2 \times (FR\ Access\ Line\ Delay) + \sum FR\ Node\ Delay + \sum FR\ Transmission\ Link\ Delay$$

The above equations simultaneously determine the performance of the IP network section. A number of approaches can be taken in planning the IP network section. The physical distance to be spanned will determine the propagation delay. Alternatively, the delay objective set for the IP section will determine the number of nodes which could be supported in the path and also place a constraint on the propagation delay. The equation can only be solved if the configuration of the Frame Relay connections (i.e., the number of switches and backbone transmission speed) is known.

B.2 Design of an IP section to meet the Classes 0 and 2 IPTD objective

For example only, assume:

- IPTD objective = 100 ms;
- Maximum IP packet size = 1500 bytes;
- All transmission links = 34 Mbit/s – Clocking delay = 350 μ s;
- Maximum of six FR nodes required to establish any of the FR virtual connections;
- Maximum Frame Relay node delay = 2 ms;
- Maximum IP gateway node delay = 10 ms;
- Maximum IP node delay = 2 ms.

NOTE – In reality the FR switch processing and queuing delay is likely to be significantly less than 2 ms and all the Frame Relay links will not have identical configurations. In the case where the FRVCs are provided by a single national network, the required number of FR switching stages is likely to be less than six. The use of high-speed transmissions links will significantly reduce the FR clocking delay contribution.

Worst-case FR Link Delay is given by:

$$FRLD = 2 \times (350 \mu\text{s}) + 6 \times (2 \text{ ms}) + (350 \mu\text{s}) = 14.45 \text{ ms}$$

Hence:

$$IP \text{ Network Section Delay} = 2 \times 10 \text{ ms} + (k - 2) \times 2 \text{ ms} + (k - 1) \times 14.45 \text{ ms} + \text{Propagation Delay}$$

Allow 16 ms for customer access line clocking delay. (Assumes 1.544 Mbit/s access line.)

$$\text{Therefore: } (100 - 16) \text{ ms} = 2 \times 10 \text{ ms} + (k - 2) \times 2 \text{ ms} + (k - 1) \times 14.45 + \text{Propagation Delay}$$

Hence:

$$\text{Propagation Delay} = 82.45 - 16.45 k \text{ or } k = (82.45 - \text{Propagation Delay}) / 16.45$$

Table B.1 shows the number of IP nodes allowed in the path for a given propagation delay in order to meet the IPTD objective set (100 ms) for the IP network section. It can clearly be seen that as the geographic distance to be spanned increases, the allowed number of routers in the path decreases. That is, there is a trade off between node processing delay and propagation delay. Accordingly, for networks spanning long distances the complexity needs to be minimized.

NOTE – Table B.1 reflects the results of the above analysis for a particular example and does not define prescribed limits.

Table B.1/X.149 – Relation between number of nodes allowed and propagation delay

Distance spanned (km)	Propagation delay (ms)	k	Number of IP nodes allowed in the path
125	0.625	4.97	5
250	1.25	4.9	4
500	2.5	4.8	4
1 000	5	4.7	4
2 000	10	4.4	4
4 000	20	3.8	3
6 000	30	3.2	3
8 000	40	2.6	2
10 000	50	1.97	2

Appendix I

Effect of packet/frame size on the IP transfer delay

This appendix provides the calculations for the estimated IPTD values specified in Table 4 and also demonstrates the impact of frame size and transmission link speed on the achieved transfer delay.

I.1 Estimate of IP packet transfer delay using the model

In order to assess the effect of packet size on the IP transfer delay, it is assumed that the frame relay reference connection consists of two national network portions, each with eight switching nodes, and an international portion with three switching nodes. It also assumes that use is made of either 1.544 Mbit/s or 2.048 Mbit/s transmission links to connect the FR switches. By assuming that the delay objective can just be met if the FRVC spans the reference connection, the contribution due to propagation delay can be estimated. An estimate of the delay for larger packet sizes can then be calculated utilizing the assumed propagation delay value.

I.1.1 Estimate of the contribution by propagation delay across the reference connection

Assume that for a 256-byte frame, the transfer delay objective (150 ms or 400 ms) is just met.

Utilizing the expression for transfer delay as developed in Annex A and the values for processing delay (Table A.1) and clocking delay (Table A.3) an estimate of the contribution by propagation delay for the reference connection can be obtained.

For 256-byte length IP packets using 1.544 Mbit/s links

For the Class 3 Frame Relay Service, we have:

$$150 \text{ ms} = 18 \times 1.35 \text{ ms} + \textit{Propagation Delay} + 19 \times 1 \text{ ms}$$

Hence:

- Assumed Propagation Delay = 107 ms

For the Classes 1 and 2 Frame Relay Service, we have:

$$400 \text{ ms} = 18 \times 1.35 \text{ ms} + \textit{Propagation Delay} + 19 \times 1 \text{ ms}$$

Hence:

- Assumed Propagation Delay = 357 ms

Utilizing the above values of assumed Propagation Delay, the delay for IP packet sizes of 576 and 1500 bytes can now be estimated.

For 576-byte length IP packets using 1.544 Mbit/s links

For the Class 3 Frame Relay Service (assumed Propagation Delay = 107 ms), we have:

$$\begin{aligned} \textit{Transfer Delay} &= 18 \times 3 \text{ ms} + \textit{Propagation Delay} + 19 \times 1 \text{ ms} \\ &= 180 \text{ ms} \end{aligned}$$

For the Classes 1 and 2 Frame Relay Service (assumed Propagation Delay = 357 ms), we have:

$$\begin{aligned} \textit{Transfer Delay} &= 18 \times 3 \text{ ms} + \textit{Propagation Delay} + 19 \times 1 \text{ ms} \\ &= 430 \text{ ms} \end{aligned}$$

For 1500-byte length IP packets using 1.544 Mbit/s links

For the Class 3 Frame Relay Service (assumed Propagation Delay = 107 ms), we have:

$$\begin{aligned} \text{Transfer Delay} &= 18 \times 7.8 \text{ ms} + \text{Propagation Delay} + 19 \times 1 \text{ ms} \\ &= 266 \text{ ms} \end{aligned}$$

For the Classes 1 and 2 Frame Relay Service (assumed Propagation Delay = 357 ms), we have:

$$\begin{aligned} \text{Transfer Delay} &= 18 \times 7.8 \text{ ms} + \text{Propagation Delay} + 19 \times 1 \text{ ms} \\ &= 516 \text{ ms} \end{aligned}$$

Now, consider the case when the transmission links are 2.048 Mbit/s.

For 256-byte length IP packets using 2.048 Mbit/s links

For the Class 3 Frame Relay Service, we have:

$$150 \text{ ms} = 18 \times 1.0 \text{ ms} + \text{Propagation Delay} + 19 \times 1 \text{ ms}$$

Hence:

- Assumed Propagation Delay = 113 ms

For the Classes 1 and 2 Frame Relay Service, we have :

$$400 \text{ ms} = 18 \times 1.0 \text{ ms} + \text{Propagation Delay} + 19 \times 1 \text{ ms}$$

Hence:

- Assumed Propagation Delay = 363 ms

Utilizing these values of Propagation Delay, the delay for IP packet sizes of 576 and 1500 bytes can be estimated.

For 576-byte length IP packets using 2.048 Mbit/s links

For the Class 3 Frame Relay Service (assumed Propagation Delay = 113 ms), we have:

$$\begin{aligned} \text{Transfer Delay} &= 18 \times 2.25 \text{ ms} + \text{Propagation Delay} + 19 \times 1 \text{ ms} \\ &= 172 \text{ ms} \end{aligned}$$

For the Classes 1 and 2 Frame Relay Service (assumed Propagation Delay = 363 ms), we have:

$$\begin{aligned} \text{Transfer Delay} &= 18 \times 2.25 \text{ ms} + \text{Propagation Delay} + 19 \times 1 \text{ ms} \\ &= 422 \text{ ms} \end{aligned}$$

For 1500-byte length IP packets using 2.048 Mbit/s links

For the Class 3 Frame Relay Service (assumed Propagation Delay = 113 ms), we have:

$$\begin{aligned} \text{Transfer Delay} &= 18 \times 5.8 \text{ ms} + \text{Propagation Delay} + 19 \times 1 \text{ ms} \\ &= 236 \text{ ms} \end{aligned}$$

For the Classes 1 and 2 Frame Relay Service (assumed Propagation Delay = 363 ms), we have:

$$\begin{aligned} \text{Transfer Delay} &= 18 \times 5.8 \text{ ms} + \text{Propagation Delay} + 19 \times 1 \text{ ms} \\ &= 486 \text{ ms} \end{aligned}$$

NOTE – The above calculations show that the use of higher-speed transmission links will reduce the end-to-end delay. The use of a 2.048-Mbit/s link in place of a 1.544-Mbit/s link will reduce the clocking delay by 2 ms on each transmission link. However, in the case where the (256-byte frame size) delay objective for the Classes 1 and 2 Frame Relay Service is just achieved, it is expected that the propagation delay will be a significant contribution.

The above results are summarized in Table I.1.

Table I.1/X.149 – Estimated IPTD values for various packet sizes and link transmission speeds

Frame Relay service class	Link transmission speed	95%-ile of FTD (as per ITU-T Rec. X.146)	Estimated 95%-ile of IPTD (Note)		
		Frame size: 256 bytes	< 256 bytes	576 bytes	1500 bytes
1	1.544 Mbit/s	400 ms	400 ms	430 ms	515 ms
2	1.544 Mbit/s	400 ms	400 ms	430 ms	515 ms
3	1.544 Mbit/s	150 ms	150 ms	180 ms	265 ms
1	2.048 Mbit/s	400 ms	400 ms	422 ms	486 ms
2	2.048 Mbit/s	400 ms	400 ms	422 ms	486 ms
3	2.048 Mbit/s	150 ms	150 ms	172 ms	236 ms

Appendix II

Use of Frame Relay for support of the IP service classes defined in ITU-T Rec. Y.1541

The purpose of this appendix is to illustrate the manner in which the Frame Relay QoS Classes (as defined in ITU-T Rec. X.146) are able to support the IP Service Classes defined in ITU-T Rec. Y.1541. The IP QoS objectives defined in ITU-T Rec. Y.1541 are end-to-end objectives and accordingly the contribution of the access line must be considered.

II.1 Simple interconnection of IP routers

Consider the reference model shown in Figure II.1 for the case where a Frame Relay Virtual Circuit is used to interconnect two IP networks. Depending on the situation, the FRVC may involve the use of an international Frame Relay connection. The IP network may consist of a number of IP routers.

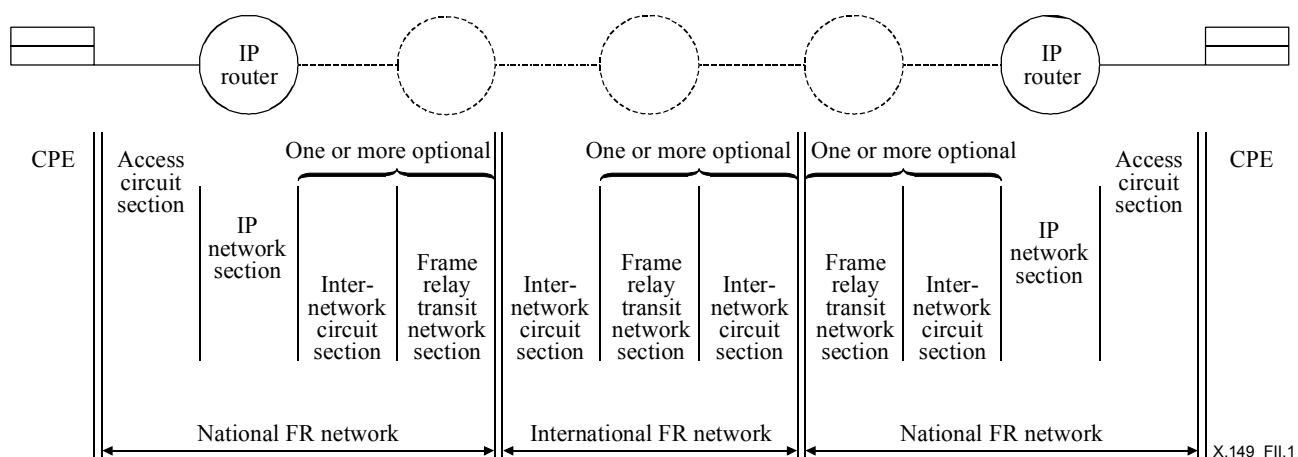

Figure II.1/X.149 – Use of FR virtual connections to interconnect IP routers

II.2 Calculation of end-to-end delay

The end-to-end transfer delay includes the contribution of all the IP and FR network sections and the associated circuit sections.

II.2.1 Contribution of access circuit and IP gateway

As defined in ITU-T Rec. Y.1541, the typical queuing and processing delay for each IP access gateway is 10 ms. The transmission delay contribution of the access circuit is a function of the Frame Length (FL) and the Access Transmission Rate (TS) ratio. Assume negligible propagation delay in the access circuit.

$$\text{Access Delay} = 10 \text{ ms} + FL/TS$$

II.2.2 Contribution of national and international Frame Relay network sections

The contribution of the Frame Relay connection can be calculated using the expression for delay developed in Annex A.

$$\text{Mean_Delay} = \sum_{i=1}^{k-1} L_i + \sum_{i=1}^{k-1} T_i + \sum_{i=1}^k D_i$$

Assume the queuing and processing delay of each FR core switch to be D ms.

The propagation delay PD is calculated based on 5 ms per 1000 kilometres of route.

Number of frame relay switches = k .

Hence:

$$\text{FR_Delay} = \frac{(k-1) \times FL}{\text{Link Transmission Speed}} + PD + k \times D$$

II.2.3 Examples of IPTD calculations for typical global connections

Assume that the international Frame Relay physical connection is composed of 19 FR switches (eight FR switches in each national portion and three FR switches in the international portion).

II.2.3.1 Example 1

Configuration parameters:

- Number of FR switches $k = 19$;
- Access rate = 2.048 Mbit/s;
- Core FR network links = 2.048 Mbit/s;
- Distance = 12 000 km – Propagation Delay = 60 ms;
- Frame size = 48 bytes (real-time applications);
- Assumed router delay = 10 ms;
- Assumed frame node delay = 1 ms.

$$\text{End-to-end delay} = 2 \times (10 \text{ ms} + 0.203 \text{ ms}) + 18 \times 0.203 \text{ ms} + 60 \text{ ms} + 19 \times 1 \text{ ms} = 103 \text{ ms}$$

This value just exceeds the Y.1541 IPTD objective for QoS Classes 0 and 2.

II.2.3.2 Example 2

Configuration parameters:

- Number of FR switches $k = 19$;
- Access rate = 2.048 Mbit/s;

- Core FR network links = 34 Mbit/s;
- Distance = 12 000 km – Propagation Delay = 60 ms;
- Frame size = 48 bytes (real-time applications);
- Assumed router delay = 10 ms;
- Assumed frame node delay = 1 ms.

$$\text{End-to-end delay} = 2 \times (10 \text{ ms} + 0.203 \text{ ms}) + 18 \times 12 \text{ } \mu\text{s} + 60 \text{ ms} + 19 \times 1 \text{ ms} = 99 \text{ ms}$$

This value just meets the Y.1541 IPTD objective for QoS Classes 0 and 2.

It should be noted that in the case where the packet size was greater than 48 bytes, the end-to-end objective would not be met. Also, if the route distance was increased, the QoS Classes 0 and 2 objective would not be met.

II.2.3.3 Example 3

Configuration parameters:

- Number of FR switches $k = 19$;
- Access rate = 34 Mbit/s;
- Core FR network links = 34 Mbit/s;
- Distance = 27 000 km – Propagation Delay = 135 ms;
- Frame size = 576 bytes (Data transfer application);
- Assumed router delay = 10 ms;
- Assumed frame node delay = 1 ms.

$$\text{End-to-end delay} = 2 \times (10 \text{ ms} + 135 \text{ } \mu\text{s}) + 18 \times 135 \text{ } \mu\text{s} + 135 \text{ ms} + 19 \times 1 \text{ ms} = 176 \text{ ms}$$

This value exceeds the Y.1541 IPTD objective for QoS Classes 0 and 2.

The above examples clearly demonstrate that the propagation delay is the dominant factor on long international connections.

II.3 Estimation of the IPDV

Using the formula in 10.3.2 and applying it to the case where the path consists of 18 Frame Relay core switches, each with FDJ of 25 ms and two IP access gateways, each with IPDV of 16 ms, we have the following result:

$$\text{IPDV (end-to-end)} = 25.11 \text{ ms}$$

It is thus seen that the IPDV performance meets the IPDV objective for IP QoS Classes 0, 1 and 2.

II.4 Estimation of IP Packet Loss ratio (IPLR)

As per 10.1: ($\text{IPLR} = \text{FLR}$).

Since for all FR QoS classes (except Class 0) the frame loss ratio is less than or equal to the IPLR, it is seen that use of a Frame Relay connection with QoS Classes 1, 2 or 3 should allow the IPLR for all IP QoS classes to be achieved.

Appendix III

General network architecture for an IP network

III.1 General network architecture for an IP network

Figure III.1 (as per ITU-T Rec. Y.1231) shows a general network architecture for an IP network. The model does not assume the use of any specific technology to provide the connection between the CPN and the IP access network or the interconnection of the IP routers/networks. The model allows for a variety of lower layer (layer 2) connectivity technologies to be used.

The reference points (RP) illustrated in Figure III.1 are logical separation between the functions and may not correspond to physical interfaces in certain network implementations. In certain network implementations, access and core networks may not be separable.

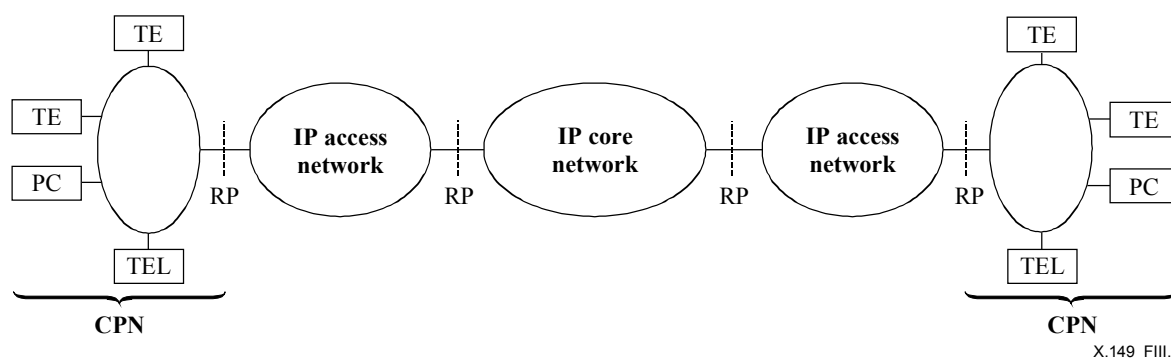

Figure III.1/X.149 – General network architecture of IP network

ITU-T Rec. Y.1231 defines the following terms:

III.1.1 IP access network: An implementation comprising network entities to provide the required access capabilities between an "IP user" and an "IP service provider" for the provision of IP services. "IP user" and "IP service provider" are logical entities which terminate the IP layer and/or IP-related functions, and may also include lower layer functions.

III.1.2 IP core network: IP service provider's network, including one or more IP service providers.

III.2 IP access network reference model

Figure III.2 shows an example of IP access network reference model. Within the scope of this Recommendation, the Access Network Transport Function can be provided by various access technologies (for example PSTN, ISDN, FR, ATM, ADSL, etc). In the case where the Access Network Transport Function is provided by a Frame Relay Virtual Circuit, the VC provides lower layer connectivity between the CPN and the IP service provider.

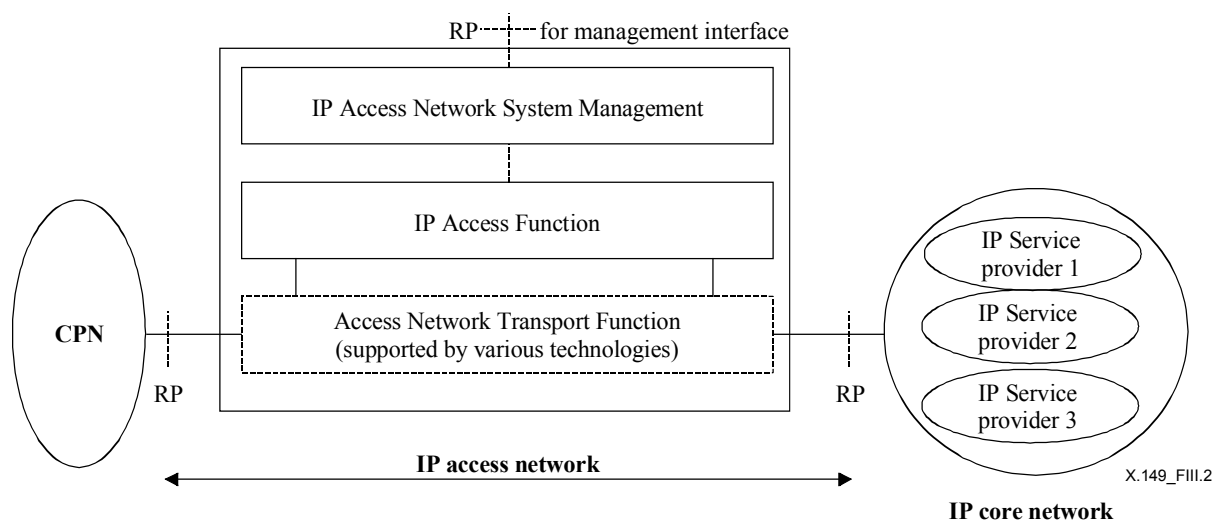

Figure III.2/X.149 – IP access network architecture example

Appendix IV

Definition of network components, circuit sections and network sections

IV.1 Network components

IV.1.1 host: A computer that communicates using the Internet protocols. A host implements routing functions (i.e., it operates at the IP layer) and may implement additional functions including higher layer protocols (e.g., TCP in a source or destination host) and lower layer protocols (e.g., ATM).

IV.1.2 router: A host that enables communication between other hosts by forwarding IP packets based on the content of their IP destination address field.

IV.1.3 source host (SRC): A host and a complete IP address where end-to-end IP packets originate. In general, a host may have more than one IP address; however, a source host is a unique association with a single IP address. Source hosts also originate higher layer protocols (e.g., TCP) when such protocols are implemented.

IV.1.4 destination host (DST): A host and a complete IP address where end-to-end IP packets are terminated. In general, a host may have more than one IP address; however, a destination host is a unique association with a single IP address. Destination hosts also terminate higher layer protocols (e.g., TCP) when such protocols are implemented.

IV.1.5 link: A point-to-point (virtual) connection used for transporting IP packets between a pair of hosts. It does not include any parts of the hosts or any other hosts; it operates below the IP layer. For the purposes of this Recommendation, a link is implemented as a logical connection on a Frame Relay network.

Figure IV.1 illustrates the network components relevant to IP service between a SRC and a DST. Links, which are Frame Relay VCs or Frame Relay networks, are illustrated as lines between hosts. Routers are illustrated as circles and both SRC and DST are illustrated as triangles.

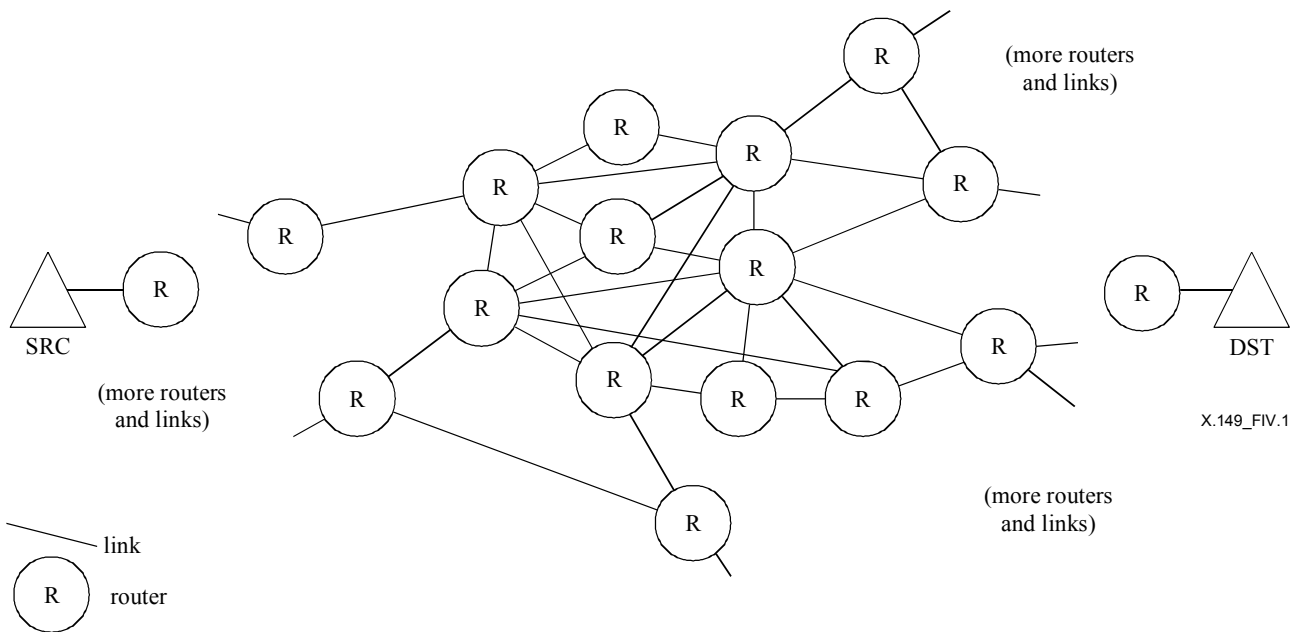

X.149_FIV.1

Figure IV.1/X.149 – IP network components

IV.2 Circuit sections and network sections

IV.2.1 circuit section (CS): The link (provided by a FRVC which may be established across one or more Frame Relay networks) connecting:

- 1) a source or destination host to its adjacent host (e.g., router) possibly in another jurisdiction; or
- 2) a router in one network section with a router in another network section.

Note that the responsibility for a circuit section, its capacity, and its performance is typically shared between the connected parties.

NOTE – "Circuit section" is roughly equivalent to the term "exchange" as defined in RFC 2330.

IV.2.2 network section (NS): A set of hosts together with all of their interconnecting links that together provide a part of the IP service between a SRC and a DST, and are under a single (or collaborative) jurisdictional responsibility. Some network sections consist of a single host with no interconnecting links. Source NS and destination NS are particular cases of network sections. Pairs of network sections are connected by circuit sections.

NOTE – "Network section" is roughly equivalent to the term "cloud" as defined in RFC 2330.

Any set of hosts interconnected by links could be considered a network section. However, for the (future) purpose of IP performance allocation, it will be relevant to focus on the set of hosts and links under a single (or collaborative) jurisdictional responsibility (such as an ISP or an NSP). These hosts typically have the same network identifier in their IP addresses. Typically, they have their own rules for internal routing. Global processes and local policies dictate the routing choices to destinations outside of this network section (to other NS via circuit sections). These network sections are typically bounded by routers that implement the IP exterior gateway protocols.

IV.2.3 source NS: The NS that includes the Source (SRC) within its jurisdictional responsibility. In some cases the SRC is the only host within the source NS.

IV.2.4 destination NS: The NS that includes the Destination (DST) within its jurisdictional responsibility. In some cases the DST is the only host within the destination NS.

Figure IV.2 illustrates the network connectivity relevant to IP service between a Source (SRC) and a Destination (DST). At the edges of each NS, gateway routers receive and send IP packets across circuit sections.

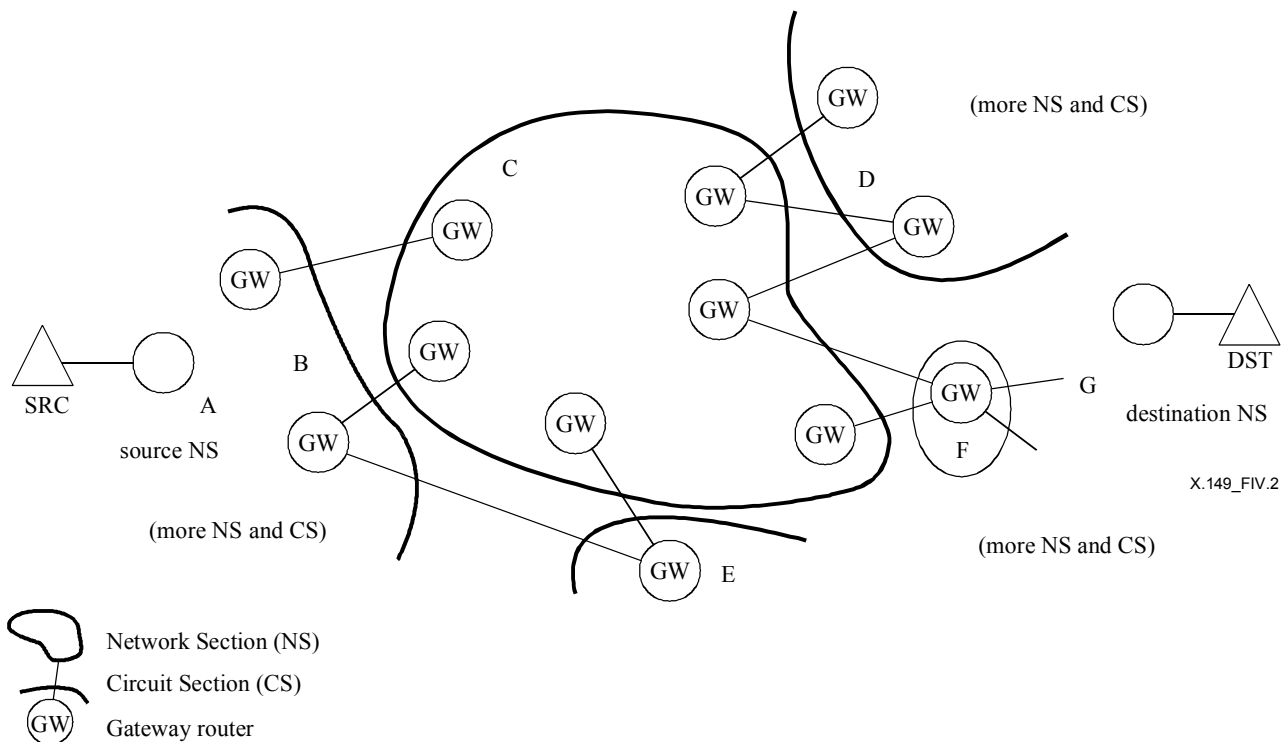

Figure IV.2/X.149 – IP network connectivity

Appendix V

IP network QoS classes (as per ITU-T Rec. Y.1541)

The contents of this appendix are only provided to assist understanding and describes the IP network QoS classes as specified in ITU-T Rec. Y.1541 (2002).

Table V.1/X.149 – Provisional IP network QoS class definitions and network performance objectives

Network performance parameter	Nature of network performance objective	QoS classes					
		Class 0	Class 1	Class 2	Class 3	Class 4	Class 5 Unspecified
IPTD	Upper bound on the mean IPTD (Note 1)	100 ms	400 ms	100 ms	400 ms	1 s	U
IPDV	Upper bound on the $1 - 10^{-3}$ quantile of IPTD minus the minimum IPTD (Note 2)	50 ms (Note 3)	50 ms (Note 3)	U	U	U	U
IPLR	Upper bound on the packet loss probability	1×10^{-3} (Note 4)	1×10^{-3} (Note 4)	1×10^{-3}	1×10^{-3}	1×10^{-3}	U
IPER	Upper bound	1×10^{-4} (Note 5)					U

GENERAL NOTES:

The objectives apply to public IP networks. The objectives are believed to be achievable on common IP network implementations. The network providers' commitment to the user is to attempt to deliver packets in a way that achieves each of the applicable objectives. The vast majority of IP paths advertising conformance with ITU-T Rec. Y.1541 should meet those objectives. For some parameters, performance on shorter and/or less complex paths may be significantly better.

An evaluation interval of 1 minute is provisionally suggested for IPTD, IPDV, and IPLR, and in all cases, the interval must be reported.

Individual network providers may choose to offer performance commitments better than these objectives.

"U" means "unspecified" or "unbounded". When the performance relative to a particular parameter is identified as being "U" the ITU-T establishes no objective for this parameter and any default Y.1541 objective can be ignored. When the objective for a parameter is set to "U", performance with respect to that parameter may, at times, be arbitrarily poor.

All values are provisional and they need not be met by networks until they are revised (up or down) based on real operational experience.

NOTE 1 – Very long propagation times will prevent low end-to-end delay objectives from being met. In these and some other circumstances, the IPTD objectives in Classes 0 and 2 will not always be achievable. Every network provider will encounter these circumstances and the range of IPTD objectives in this table provides achievable QoS classes as alternatives. The delay objectives of a class do not preclude a network provider from offering services with shorter delay commitments. According to the definition of IPTD in ITU-T Rec. Y.1540, packet insertion time is included in the IPTD objective. This Recommendation suggests a maximum packet information field of 1500 bytes for evaluating these objectives.

NOTE 2 – The definition and nature of the IPDV objective is under study. See Appendix II/Y.1541 for more details.

NOTE 3 – This value is dependent on the capacity of internetwork links. Smaller variations are possible when all capacities are higher than primary rate (T1 or E1), or when competing packet information fields are smaller than 1500 bytes (see Appendix IV/Y.1541).

NOTE 4 – The Classes 0 and 1 objectives for IPLR are partly based on studies showing that high-quality voice applications and voice codecs will be essentially unaffected by a 10^{-3} IPLR.

NOTE 5 – This value ensures that packet loss is the dominant source of defects presented to upper layers, and is feasible with IP transport on ATM.

SERIES OF ITU-T RECOMMENDATIONS

Series A	Organization of the work of ITU-T
Series B	Means of expression: definitions, symbols, classification
Series C	General telecommunication statistics
Series D	General tariff principles
Series E	Overall network operation, telephone service, service operation and human factors
Series F	Non-telephone telecommunication services
Series G	Transmission systems and media, digital systems and networks
Series H	Audiovisual and multimedia systems
Series I	Integrated services digital network
Series J	Cable networks and transmission of television, sound programme and other multimedia signals
Series K	Protection against interference
Series L	Construction, installation and protection of cables and other elements of outside plant
Series M	TMN and network maintenance: international transmission systems, telephone circuits, telegraphy, facsimile and leased circuits
Series N	Maintenance: international sound programme and television transmission circuits
Series O	Specifications of measuring equipment
Series P	Telephone transmission quality, telephone installations, local line networks
Series Q	Switching and signalling
Series R	Telegraph transmission
Series S	Telegraph services terminal equipment
Series T	Terminals for telematic services
Series U	Telegraph switching
Series V	Data communication over the telephone network
Series X	Data networks and open system communications
Series Y	Global information infrastructure, Internet protocol aspects and Next Generation Networks
Series Z	Languages and general software aspects for telecommunication systems