



INTERNATIONAL TELECOMMUNICATION UNION

ITU-T

TELECOMMUNICATION
STANDARDIZATION SECTOR
OF ITU

I.411

(03/93)

**INTEGRATED SERVICES DIGITAL
NETWORK (ISDN)
ISDN USER-NETWORK INTERFACES**

**ISDN USER-NETWORK INTERFACES –
REFERENCE CONFIGURATIONS**

ITU-T Recommendation I.411

(Previously “CCITT Recommendation”)

FOREWORD

The ITU Telecommunication Standardization Sector (ITU-T) is a permanent organ of the International Telecommunication Union. The ITU-T is responsible for studying technical, operating and tariff questions and issuing Recommendations on them with a view to standardizing telecommunications on a worldwide basis.

The World Telecommunication Standardization Conference (WTSC), which meets every four years, established the topics for study by the ITU-T Study Groups which, in their turn, produce Recommendations on these topics.

ITU-T Recommendation I.411 was revised by the ITU-T Study Group XVIII (1988-1993) and was approved by the WTSC (Helsinki, March 1-12, 1993).

NOTES

1 As a consequence of a reform process within the International Telecommunication Union (ITU), the CCITT ceased to exist as of 28 February 1993. In its place, the ITU Telecommunication Standardization Sector (ITU-T) was created as of 1 March 1993. Similarly, in this reform process, the CCIR and the IFRB have been replaced by the Radiocommunication Sector.

In order not to delay publication of this Recommendation, no change has been made in the text to references containing the acronyms "CCITT, CCIR or IFRB" or their associated entities such as Plenary Assembly, Secretariat, etc. Future editions of this Recommendation will contain the proper terminology related to the new ITU structure.

2 In this Recommendation, the expression "Administration" is used for conciseness to indicate both a telecommunication administration and a recognized operating agency.

© ITU 1993

All rights reserved. No part of this publication may be reproduced or utilized in any form or by any means, electronic or mechanical, including photocopying and microfilm, without permission in writing from the ITU.

CONTENTS

	<i>Page</i>
1 General	1
2 Definitions.....	1
3 Reference configuration	1
4 Physical realizations of reference configurations.....	3
4.4 Clarification of the reference point and interface point concepts	7

ISDN USER-NETWORK INTERFACES – REFERENCE CONFIGURATIONS

(Malaga-Torremolinos, 1984; revised at Helsinki, 1993)

1 General

1.1 This Recommendation provides the reference configurations for ISDN user-network interfaces.

1.2 From the user's perspective, an ISDN is completely described by the attributes that can be observed at an ISDN user-network interface, including physical, electromagnetic, protocol, service, capability, maintenance, operation and performance characteristics. The key to defining, and even recognizing, an ISDN is the specification of these characteristics.

1.3 An objective of ISDN is that a small set of compatible user-network interfaces can economically support a wide range of user applications, equipment and configurations. The number of different user-network interfaces is minimized to maximize user flexibility through terminal compatibility (from one application to another, one location to another, and one service to another) and to reduce costs through economies in production of equipment and operation of both ISDN and user equipment. However, different interfaces are required for applications with widely different information rates, complexity, or other characteristics, as well as for applications in the evolutionary stages. In this way, simple applications need not to be burdened with the cost of accommodating features employed by complex applications.

1.4 Another objective is to have the same interfaces used even though there are different configurations (e.g. single terminal versus multiple terminal connections, connections to a PABX versus direct connections into the network, etc.) or different national regulations.

2 Definitions

2.1 **reference configurations** are: Conceptual configurations useful in identifying various possible physical user access arrangements to an ISDN. Two concepts are used in defining reference configurations: reference points and functional groupings. Layout and application examples of reference configurations are given in 3.

2.2 **functional groups** are: Sets of functions which may be needed in ISDN user access arrangements. In a particular access arrangement, specific functions in a functional group may or may not be present. Note that specific functions in a functional group may be performed in one or more pieces of equipment.

2.3 **reference points** are: The conceptual points dividing functional groups. In a specific access arrangement, a reference point may correspond to a physical interface between pieces of equipment, or there may not be any physical interface corresponding to the reference point. Physical interfaces that do not correspond to a reference point (e.g. transmission line interfaces) will not be the subject of ISDN user-network interface Recommendations.

3 Reference configuration

3.1 The reference configurations for ISDN user-network interfaces define reference points and types of functions that can be provided between reference points. Figure 1 shows the reference configurations, while Figures 2, 3 and 4 show examples of applications of such configurations.

3.2 The ISDN user-network interface Recommendations in the I-Series apply to physical interfaces at reference points S and T, using the recommended interface structures according to Recommendation I.412. At reference point R, physical interfaces in accordance with other Recommendations (e.g. the X-Series interface Recommendations) may be used.

NOTES

- 1 Physical interfaces not included in CCITT Recommendations may appear at reference point R.
- 2 There is no reference point assigned to the transmission line, since an ISDN user-network interface is not envisaged at this location.

3.3 Figure 1a) defines the reference configuration with the functional groups NT1, NT2 and TE1. Figure 1b) illustrates that TE1 may be replaced by the combination of TE2 and TA.

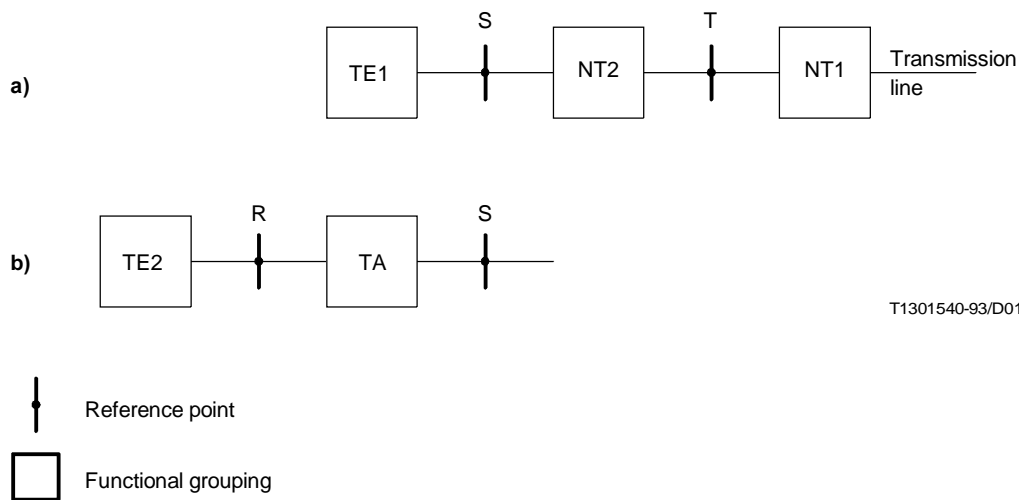

T1301540-93/D01

FIGURE 1/I.411
Reference configurations for the ISDN user-network interfaces

3.4 Lists of functions for each functional group are given below. Each particular function is not necessarily restricted to a single functional group. For example, “interface termination” functions are included in the function lists of NT1, NT2 and TE. The function lists for NT2, TE and TA are not exhaustive. For a particular access arrangement, specific functions in a functional group are either present or absent.

The functional groups are described in relation to the ISDN protocol reference model in Recommendation I.320.

3.4.1 Network termination 1 (NT1)

This functional group includes functions broadly equivalent to layer 1 (physical) of the OSI reference model. These functions are associated with the proper physical and electromagnetic termination of the network. NT1 functions are:

- line transmission termination;
- layer 1 line maintenance functions and performance monitoring;
- timing;
- power transfer;
- layer 1 multiplexing;
- interface termination, including multidrop termination employing layer 1 contention resolution.

3.4.2 Network termination 2 (NT2)

This functional group includes functions broadly equivalent to layer 1 and higher layers of the Recommendation X.200 reference model. PABXs, local area networks, and terminal controllers are examples of equipment or combinations of equipment that provide NT2 functions. NT2 functions include:

- layers 2 and 3 protocol handling;
- layers 2 and 3 multiplexing;
- switching;
- concentration;
- maintenance functions; and
- interface termination and other layer 1 functions.

For example, a simple PABX can provide NT2 functions at layers 1, 2 and 3. A simple terminal controller can provide NT2 functions at only layers 1 and 2. A simple time division multiplexer can provide NT2 functions at only layer 1. In a specific access arrangement, the NT2 functional group may consist of only physical connections.

3.4.3 Terminal equipment (TE)

This functional group includes functions broadly belonging to layer 1 and higher layers of the Recommendation X.200 reference model. Digital telephones, data terminal equipment, and integrated work stations are examples of equipment or combinations of equipment that provide the functions. The TE functions are:

- protocol handling;
- maintenance functions;
- interface functions;
- connection functions to other equipment.

3.4.3.1 Terminal equipment type 1 (TE1)

This functional group includes functions belonging to the functional group TE, and with an interface that complies with the ISDN user-network interface Recommendations.

3.4.3.2 Terminal equipment type 2 (TE2)

This functional group includes functions belonging to the functional group TE but with an interface that complies with interface Recommendations other than the ISDN interface Recommendation (e.g. the X-Series interface Recommendations) or interfaces not included in CCITT Recommendations.

3.4.4 Terminal adaptor (TA)

This functional group includes functions broadly belonging to layer 1 and higher layers of the Recommendation X.200 reference model that allow a TE2 terminal to be served by an ISDN user-network interface. Adaptors between physical interfaces at reference points R and S or R and T are examples of equipment or combinations of equipment that provide TA functions.

4 Physical realizations of reference configurations

4.1 Figure 2 gives examples of configurations illustrating combinations of physical interfaces at reference points R, S and T; Figures 2a) and 2b) show separate interfaces at S and T; Figures 2c) and 2d) show an interface at S but not T; Figures 2e) and 2f) show an interface at T but not S; Figures 2g) and 2h) show an interface at S and T where they coincide. Additionally, Figures 2b), 2d), 2f) and 2h) show an interface at reference point R.

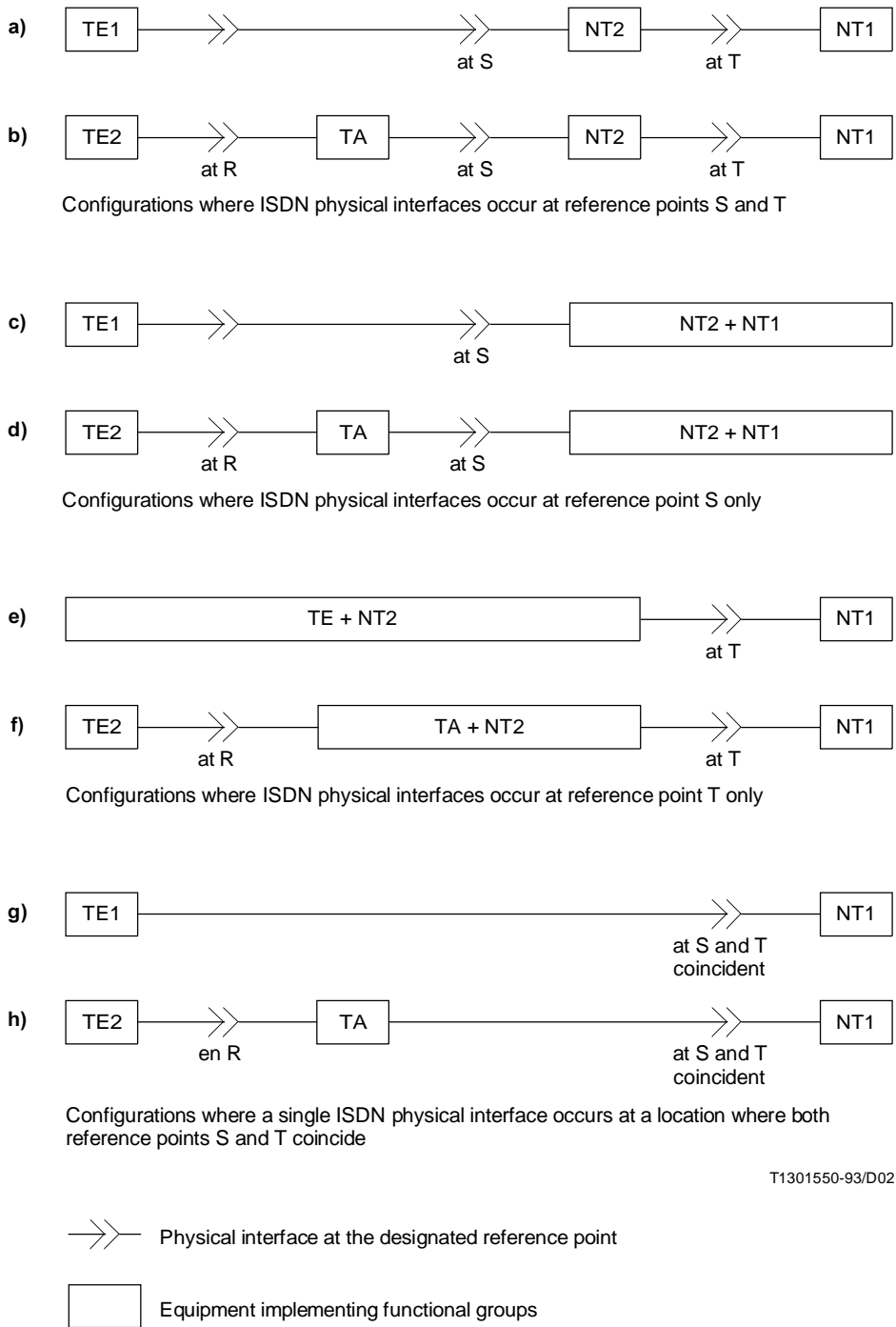

T1301550-93/D02

FIGURE 2/I.411
Examples of physical configurations

4.2 Figures 3 and 4 show examples of physical implementations. The examples given in Figure 3 show physical realizations of functional groups TE, NT1 and NT2, based on physical interfaces occurring at reference points R, S and T. The examples given in Figure 4 show applications of the reference configurations to physical configurations when multiple physical interfaces occur at a reference point.

The examples given in Figure 4 are not intended to be either exhaustive or mandatory. Square blocks in Figures 3 and 4 represent equipment implementing functional groupings.

NOTE – TE1 or TE2 + TA may be used interchangeably in Figure 4.

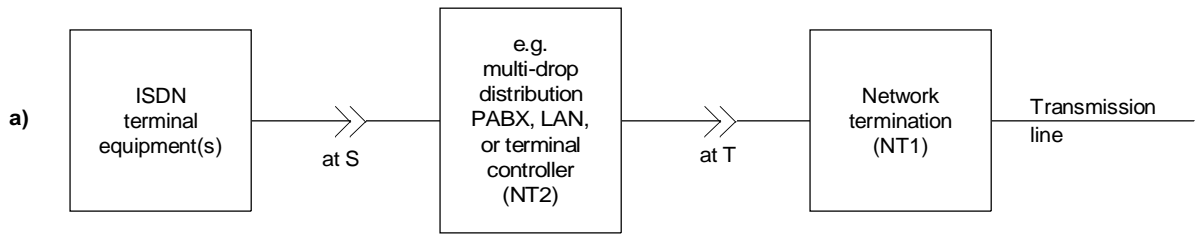

An implementation [see Figure 2a)] where ISDN physical interfaces occur at reference points S and T

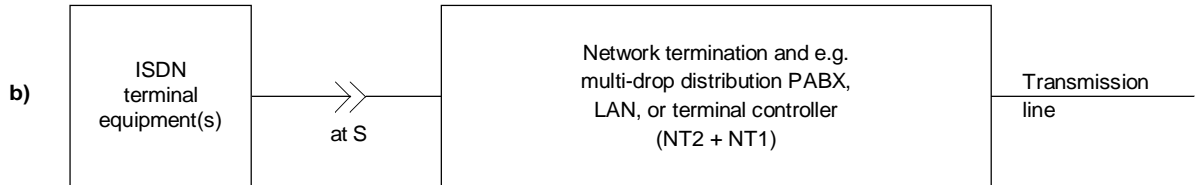

An implementation [see Figure 2c)] where an ISDN physical interface occurs at reference points S but not T

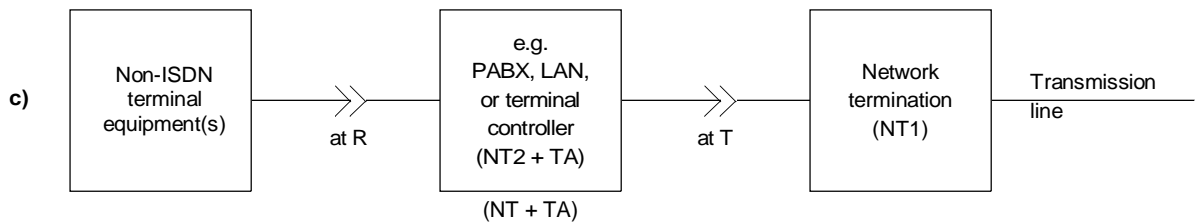

An implementation [see Figure 2f)] where an ISDN physical interface occurs at reference point T but not S

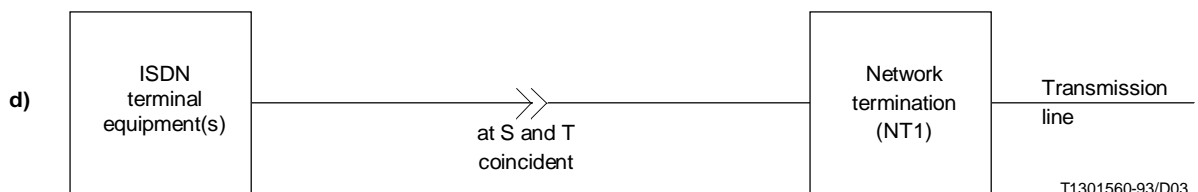

T1301560-93/D03

An implementation [see Figure 2g)] where a single ISDN physical interface occurs at a location where both reference points S and T coincide

→→ Physical interface at the designated reference point

□ Equipment implementing functional groups

FIGURE 3/I.411
Examples of implementation of NT1 and NT2 functions

4.2.1 Figures 4a) and 4b) show applications of the reference configurations in the cases where NT2 functions consist of only physical connections. Figure 4a) describes the direct physical connection of multiple TEs (TE1s or TE2s + TAs) to NT1 using a multidrop arrangement (i.e. a bus). Figure 4b) illustrates the separate connection of a number of TEs to NT1.

In these cases, all of the characteristics of the physical interfaces applied at reference points S and T must be identical.

4.2.2 Figure 4c) shows the provision of multiple connections between NT2 and TEs. NT2 may include various types of distribution arrangements, such as star, bus or ring configuration included within the equipment. Figure 4d) shows a case where a bus distribution is used between TEs and the NT2 equipment.

4.2.3 Figures 4e) and 4f) show arrangements where multiple connections are used between NT2 and NT1 equipment. In particular, Figure 4e) illustrates the case of multiple NT1 equipment, while Figure 4f) refers to the case where NT1 provides layer 1 upward multiplexing of the multiple connections.

4.2.4 Figure 4g) illustrates the case where NT1 and NT2 functions are merged in the same equipment; the corresponding merging of NT1 and NT2 functions for other configurations in Figure 4 may also occur.

4.2.5 Figure 4h) illustrates the case where TA and NT2 functions are merged in the same equipment; the corresponding merging of TA and NT2 functions for other configurations in Figure 4 may also occur.

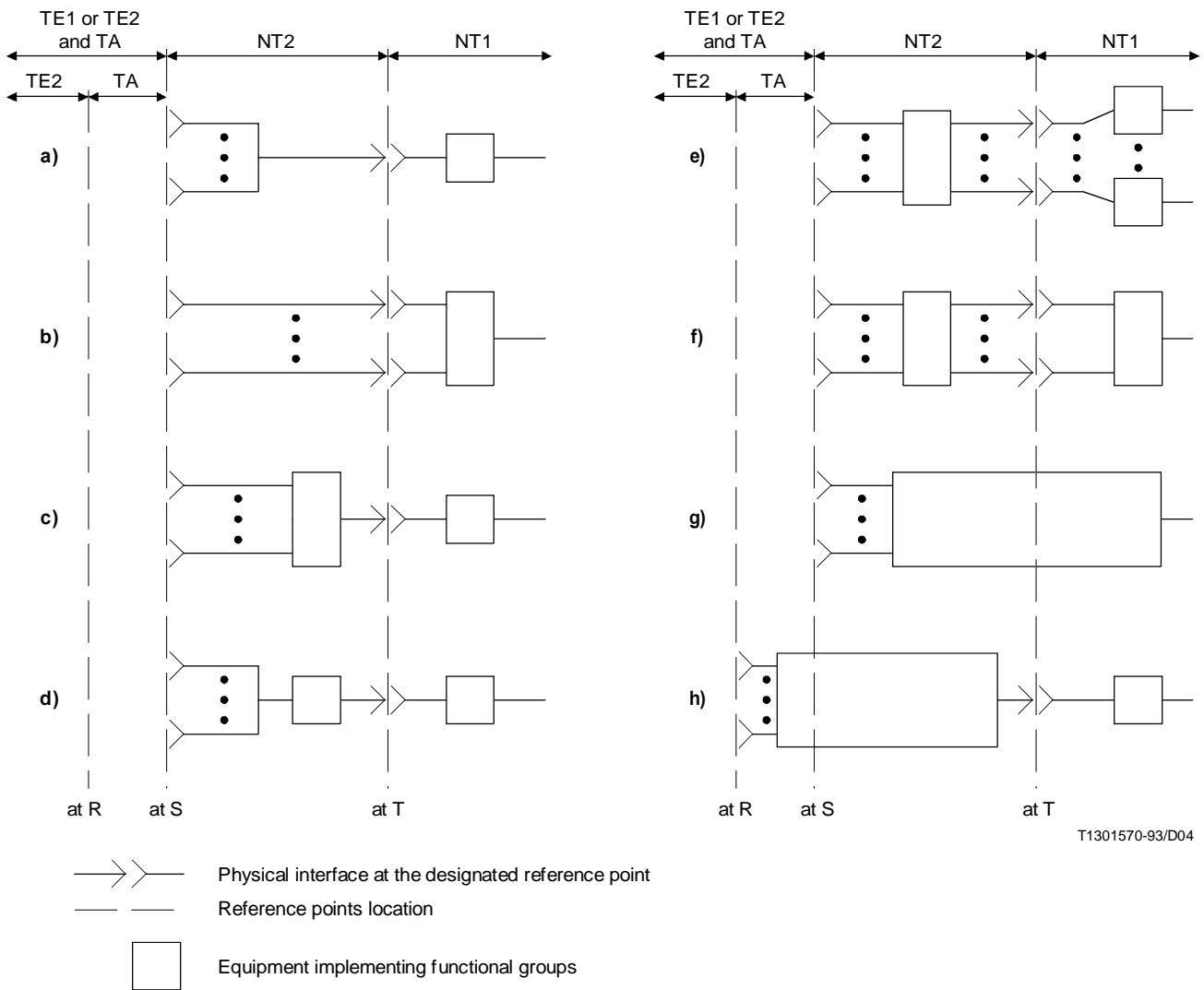

T1301570-93/D04

FIGURE 4/I.411

Examples of physical configurations employing multiple connections

4.2.6 In addition to the examples of physical implementation shown in Figures 3 and 4, a possible combination of NT1, NT2 and TA into one physical entity could be considered, in which both reference points S and T exist but are not realized as physical interfaces. Such an implementation is to be considered an interim means of providing connection to an ISDN and might be used to complement the recommended means of connecting terminals via physical interfaces at reference points S and T in the early stages of ISDN implementation. This should not be considered as a reference configuration because it poses significant problems in relation to the models of ISDN presently being studied.

4.2.7 These physical implementations are limited in their arrangements and combinations by the electrical and other characteristics of the interface specifications and equipment.

4.3 The reference-configurations given in Figure 1 apply for the specification of the interface structures and access arrangements given in Recommendation I.412.

4.4 Clarification of the reference point and interface point concepts

A reference point, when physically realized by an interface, requires the specification of at least two interface points (see Figure 5).

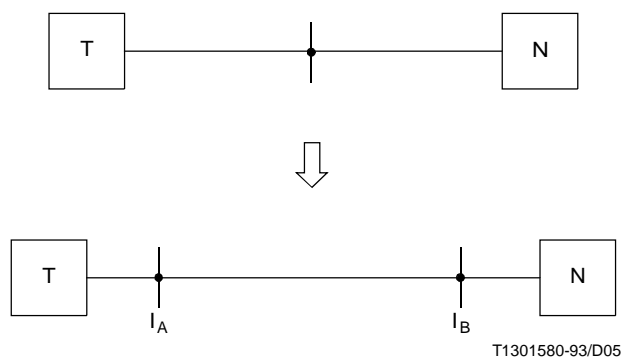
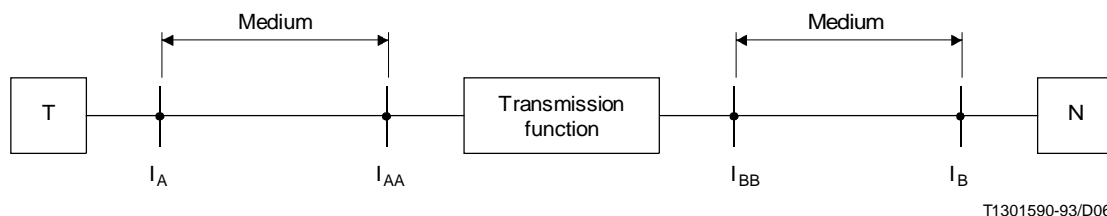

FIGURE 5/I.411

4.4.1 interface point

One of at least two physical locations associated with an interface. The interface points mark the end of the transmission medium which supports the interface and may be the location of connectors (if used).

The reach of any interface may be extended by the use of a transmission system, providing that the transmission system is transparent with regard to the functions transported by the interface. In such a case, two further interface points would be required (see Figure 6).



NOTE – The insertion of a transmission system to a specific interface may be limited by performance related requirements.

FIGURE 6/I.411