

International Telecommunication Union

**ITU-T**

TELECOMMUNICATION  
STANDARDIZATION SECTOR  
OF ITU

**H.242**

(03/2009)

SERIES H: AUDIOVISUAL AND MULTIMEDIA SYSTEMS

Infrastructure of audiovisual services – Communication  
procedures

---

**System for establishing communication  
between audiovisual terminals using  
digital channels up to 2 Mbit/s**

Recommendation ITU-T H.242



ITU-T H-SERIES RECOMMENDATIONS  
AUDIOVISUAL AND MULTIMEDIA SYSTEMS

CHARACTERISTICS OF VISUAL TELEPHONE SYSTEMS	H.100–H.199
INFRASTRUCTURE OF AUDIOVISUAL SERVICES	
General	H.200–H.219
Transmission multiplexing and synchronization	H.220–H.229
Systems aspects	H.230–H.239
<b>Communication procedures</b>	<b>H.240–H.259</b>
Coding of moving video	H.260–H.279
Related systems aspects	H.280–H.299
Systems and terminal equipment for audiovisual services	H.300–H.349
Directory services architecture for audiovisual and multimedia services	H.350–H.359
Quality of service architecture for audiovisual and multimedia services	H.360–H.369
Supplementary services for multimedia	H.450–H.499
MOBILITY AND COLLABORATION PROCEDURES	
Overview of Mobility and Collaboration, definitions, protocols and procedures	H.500–H.509
Mobility for H-Series multimedia systems and services	H.510–H.519
Mobile multimedia collaboration applications and services	H.520–H.529
Security for mobile multimedia systems and services	H.530–H.539
Security for mobile multimedia collaboration applications and services	H.540–H.549
Mobility interworking procedures	H.550–H.559
Mobile multimedia collaboration inter-working procedures	H.560–H.569
BROADBAND, TRIPLE-PLAY AND ADVANCED MULTIMEDIA SERVICES	
Broadband multimedia services over VDSL	H.610–H.619
Advanced multimedia services and applications	H.620–H.629
IPTV MULTIMEDIA SERVICES AND APPLICATIONS FOR IPTV	
General aspects	H.700–H.719
IPTV terminal devices	H.720–H.729
IPTV middleware	H.730–H.739
IPTV application event handling	H.740–H.749
IPTV metadata	H.750–H.759
IPTV multimedia application frameworks	H.760–H.769
IPTV service discovery up to consumption	H.770–H.779

*For further details, please refer to the list of ITU-T Recommendations.*

## **Recommendation ITU-T H.242**

### **System for establishing communication between audiovisual terminals using digital channels up to 2 Mbit/s**

#### **Summary**

Videophone, videoconferencing and other conversational multimedia services on fixed bit-rate networks (such as ISDN) depend on the multiplex structure described in Recommendation ITU-T H.221. The control channel within this multiplex is the so-called bit-rate allocation signal (BAS) position in each frame. This Recommendation describes all the point-to-point procedures involving the BAS codes: initial capability exchange and mode initialization, including restricted-network operation; in-session mode switching, including audiovisual mode changes and activation of data channels; other procedures, including single/multiple channel interconnection, encryption, mode-preference indication, conveyance of network addresses and use of BAS extension codes.

This revised version of Recommendation ITU-T H.242 introduces a number of enhancements and clarifications to the previous version, primarily the description on the usage of G.719 and Annex C of Recommendation ITU-T G.722.1 (14 kHz audio) in H.320 systems.

#### **Source**

Recommendation ITU-T H.242 was approved on 16 March 2009 by ITU-T Study Group 16 (2009-2012) under Recommendation ITU-T A.8 procedure.

## FOREWORD

The International Telecommunication Union (ITU) is the United Nations specialized agency in the field of telecommunications, information and communication technologies (ICTs). The ITU Telecommunication Standardization Sector (ITU-T) is a permanent organ of ITU. ITU-T is responsible for studying technical, operating and tariff questions and issuing Recommendations on them with a view to standardizing telecommunications on a worldwide basis.

The World Telecommunication Standardization Assembly (WTSA), which meets every four years, establishes the topics for study by the ITU-T study groups which, in turn, produce Recommendations on these topics.

The approval of ITU-T Recommendations is covered by the procedure laid down in WTSA Resolution 1.

In some areas of information technology which fall within ITU-T's purview, the necessary standards are prepared on a collaborative basis with ISO and IEC.

## NOTE

In this Recommendation, the expression "Administration" is used for conciseness to indicate both a telecommunication administration and a recognized operating agency.

Compliance with this Recommendation is voluntary. However, the Recommendation may contain certain mandatory provisions (to ensure e.g. interoperability or applicability) and compliance with the Recommendation is achieved when all of these mandatory provisions are met. The words "shall" or some other obligatory language such as "must" and the negative equivalents are used to express requirements. The use of such words does not suggest that compliance with the Recommendation is required of any party.

## INTELLECTUAL PROPERTY RIGHTS

ITU draws attention to the possibility that the practice or implementation of this Recommendation may involve the use of a claimed Intellectual Property Right. ITU takes no position concerning the evidence, validity or applicability of claimed Intellectual Property Rights, whether asserted by ITU members or others outside of the Recommendation development process.

As of the date of approval of this Recommendation, ITU had not received notice of intellectual property, protected by patents, which may be required to implement this Recommendation. However, implementers are cautioned that this may not represent the latest information and are therefore strongly urged to consult the TSB patent database at <http://www.itu.int/ITU-T/ipr/>.

© ITU 2009

All rights reserved. No part of this publication may be reproduced, by any means whatsoever, without the prior written permission of ITU.

## CONTENTS

	<b>Page</b>
1	Scope ..... 1
2	References..... 1
3	Definitions and conventions ..... 2
4	Abbreviations and acronyms ..... 3
5	Terminal capabilities ..... 3
5.1	Audio capabilities ..... 4
5.2	Video capabilities ..... 7
5.3	Transfer rate capabilities ..... 30
5.4	Data capabilities ..... 30
5.5	Terminals on restricted networks: capability ..... 30
5.6	Encryption and extension-BAS capabilities ..... 30
5.7	Null capability ..... 30
6	Transmission..... 30
6.1	Transmission modes ..... 30
6.2	Establishment of compatible modes of operation ..... 31
7	Frame structure ..... 31
8	Basic sequences for in-channel procedures ..... 32
8.1	Capability exchange sequence A ..... 32
8.2	Mode switching sequence B ..... 36
8.3	Frame reinstatement sequence C ..... 36
9	Mode initialization, dynamic mode switching and Mode 0 forcing ..... 37
9.1	Mode initialization procedure..... 37
9.2	Dynamic mode switching (see Figure 2)..... 39
9.3	Mode 0 forcing procedure ..... 41
9.4	Mode mismatch recovery procedure ..... 43
9.5	Procedure for influencing the mode transmitted from remote endpoint ..... 43
10	Recovery from fault conditions ..... 43
10.1	Unexpected loss of synchronization or frame alignment ..... 44
10.2	Recovery from loss of connection(s)..... 44
11	Network consideration: call connection, disconnection and call transfer ..... 45
11.1	Call connection..... 45
11.2	Terminal disconnection ..... 46
11.3	Call transfer ..... 47
11.4	Conferencing ..... 47
12	Procedure for activation and de-activation of data channels ..... 47
12.1	General ..... 47
12.2	Procedures applicable to all data types..... 47

12.3	Equipment capable of operating using protocol according to Recommendation ITU-T T.120 .....	48
12.4	Data equipment not conforming to Recommendation ITU-T T.120.....	48
12.5	Dummy data .....	49
13	Procedures for operation in restricted networks .....	49
13.1	Network aspects.....	49
13.2	Terminal-network configurations and properties .....	50
13.3	Transmission formats .....	52
13.4	Procedures .....	52
14	Procedure for use of BAS-extension codes .....	60
15	Bit occupancy and the sequencing of BAS codes .....	61
16	Procedure for dealing with single/multiple channel interconnection .....	64
17	Procedure for use of encryption control signal channel .....	64
18	Transmission of network addresses .....	65
18.1	Address of initial connection.....	65
18.2	Addresses of additional connections .....	65
19	Informative codes .....	67
19.1	Recommendation version identification.....	67
19.2	Manufacturer/type identification .....	67
Appendix I – Initialization: Case of videophone to Recommendation ITU-T H.320, type Xb .....		68
Appendix II – Mode-0 forcing: Case of videophone to Recommendation ITU-T H.320, type Xb .....		72
Appendix III – Example of use of message structure .....		74
III.1	Initial capability exchange, including MBE-cap .....	74
III.2	Subsequent capability exchange, including MBE capability message.....	74
III.3	Mode switch to non-standard mode using MBE command .....	75
Appendix IV – Examples of symmetrical and asymmetrical transmission modes.....		76
IV.1	Example of symmetrical transmission mode.....	76
IV.2	Example of asymmetrical transmission mode.....	76
IV.3	Example of unsymmetrical video mode .....	76
Appendix V – Examples relating to data transmissions .....		77
V.1	Transfer-rate 1B, audio at 48 kbit/s, no video or video off .....	77
V.2	Transfer-rate 1B, audio at 16 kbit/s, no video or video off .....	77
V.3	Transfer-rate 1B, audio at 16 kbit/s, video on .....	77
V.4	Transfer-rate 2B, audio at 48 kbit/s, video on .....	77
V.5	Transfer-rate 2B, audio at 16 kbit/s, video on .....	78
Appendix VI – Hierarchical capability BAS codes .....		79

	<b>Page</b>
Appendix VII – Interpretation of received audio capability BAS codes .....	81
Appendix VIII – Examples of legal and illegal capability BAS sequences.....	82
Appendix IX.....	84
Appendix X – An algorithm to determine whether an incoming bit stream was encoded by $\mu$ -law or A-law PCM .....	88
X.1    Basic determination algorithm .....	88
X.2    Possible extensions and refinements .....	89
Bibliography.....	90





## Recommendation ITU-T H.242

### System for establishing communication between audiovisual terminals using digital channels up to 2 Mbit/s

#### 1 Scope

This Recommendation should be associated with [ITU-T H.221] and [ITU-T H.230].

A number of applications utilizing narrow-band (3 kHz) and wideband (7 kHz) speech together with video and/or data have been identified, including high quality telephony, audio and videoconferencing (with or without various kinds of telematic aids), audiographic conferencing, and so on. More applications will undoubtedly emerge in the future.

To provide these services, a scheme is recommended in which a channel accommodates speech, and optionally video and/or data at several rates, in a number of different modes. Signalling procedures are required to establish a compatible mode upon call set-up, to switch between modes during a call and to allow for call transfer.

Some services will require only a single channel which could, according to the procedures in this Recommendation, be B (64 kbit/s), H<sub>0</sub> (384 kbit/s), H<sub>11</sub> (1536 kbit/s) or H<sub>12</sub> (1920 kbit/s). Other services will require the establishment of two or more connections providing B or H<sub>0</sub> channels: in such cases the first established is called hereafter the initial channel while the others are called additional channels. Unless otherwise specified, all references to frame alignment signal (FAS) bit-rate allocation signal (BAS) and service channel (SC) refer to the initial channel or, in the case of a higher-order channel, to the time-slot No. 1 of this channel.

All audio and audiovisual terminals using G.722 audio coding and/or G.711 speech coding or other standardized audio codings at lower bit rates should be compatible to permit connection between any two terminals. This implies that a common mode of operation has to be established for the call. The initial mode might be the only one used during a call or, alternatively, switching to another mode can occur as needed depending on the capabilities of the terminals. Thus, for these terminals, an in-channel procedure for dynamic mode switching is required.

The following clauses develop these considerations and describe recommended in-channel procedures.

#### 2 References

The following ITU-T Recommendations and other references contain provisions which, through reference in this text, constitute provisions of this Recommendation. At the time of publication, the editions indicated were valid. All Recommendations and other references are subject to revision; users of this Recommendation are therefore encouraged to investigate the possibility of applying the most recent edition of the Recommendations and other references listed below. A list of the currently valid ITU-T Recommendations is regularly published. The reference to a document within this Recommendation does not give it, as a stand-alone document, the status of a Recommendation.

- [ITU-T G.719] Recommendation ITU-T G.719 (2008), *Low-complexity full-band audio coding for high-quality conversational applications.*
- [ITU-T H.221] Recommendation ITU-T H.221 (2004), *Frame structure for a 64 to 1920 kbit/s channel in audiovisual teleservices.*
- [ITU-T H.224] Recommendation ITU-T H.224 (2000), *A real time control protocol for simplex applications using the H.221 LSD/HSD/MLP channels.*

- [ITU-T H.230] Recommendation ITU-T H.230 (2004), *Frame-synchronous control and indication signals for audiovisual systems*.
- [ITU-T H.241] Recommendation ITU-T H.241 (2003), *Extended video procedures and control signals for H.300-series terminals*.
- [ITU-T H.243] Recommendation ITU-T H.243 (2000), *Procedures for establishing communication between three or more audiovisual terminals using digital channels up to 1920 kbit/s*.
- [ITU-T H.244] Recommendation ITU-T H.244 (1995), *Synchronized aggregation of multiple 64 or 56 kbit/s channels*.
- [ITU-T H.245] Recommendation ITU-T H.245 (2008), *Control protocol for multimedia communication*.
- [ITU-T H.261] Recommendation ITU-T H.261 (1993), *Video codec for audiovisual services at  $p \times 64$  kbit/s*.
- [ITU-T H.262] Recommendation ITU-T H.262 (2000) | ISO/IEC 13818-2:2000, *Information technology – Generic coding of moving pictures and associated audio information: Video*.
- [ITU-T H.263] Recommendation ITU-T H.263 (2005), *Video coding for low bit rate communication*.
- [ITU-T H.264] Recommendation ITU-T H.264 (2003), *Advanced video coding for generic audiovisual services*.
- [ITU-T T.120] Recommendation ITU-T T.120 (1996), *Data protocols for multimedia conferencing*.
- [ISO/IEC 14496-3] ISO/IEC 14496-3:2005, *Information technology – Coding of audio-visual objects – Part 3: Audio*.

### 3 Definitions and conventions

This Recommendation defines the following terms:

**3.1 H.221 frame structure; H.221 framing:** Frame structure according to [ITU-T H.221].

**3.2 T.120 protocol:** See [ITU-T T.120].

**3.3 capset:** Abbreviation for "Capability set".

**3.4 calling end:** Endpoint which requests the first 64/56-channel connection of the whole session, resulting in the establishment of the "initial channel". If, during fault-recovery procedures, the initial channel is transferred to another connection, this does not affect the definition.

**3.5 called end:** Endpoint which accepts the first 64/56-channel connection request of the whole session, resulting in the establishment of the "initial channel". If, during fault-recovery procedures, the initial channel is transferred to another connection, this does not affect the definition.

**3.6 {capability}:** Capability values are those listed as attributes (100), (101), (110), in Tables A.1, A.2, A.3 and A.5 of [ITU-T H.221] together with some SBE values (Note) identified as capabilities in [ITU-T H.230]; brackets { } have been used in some places to enclose capability value(s).

NOTE – These SBE capabilities include the codes TIC, CIC, VIM and MIH.

**3.7 [command]:** Command values are those listed as attributes (000), (001), (010), and (011) in Table A.1 of [ITU-T H.221], and attributes labelled as Commands in Tables A.2, A.3 and A.5 of [ITU-T H.221]; brackets [ ] have been used in some places to enclose command value(s).

**3.8 restricted network:** See clause 13.1.

## **4 Abbreviations and acronyms**

This Recommendation uses the following abbreviations and acronyms:

BAS	Bit-rate Allocation Signal (see [ITU-T H.221])
capset	capability set
EPAR	Extended Pixel Aspect Ratio Code
FAS	Frame Alignment Signal (see [ITU-T H.221])
H.221	See [ITU-T H.221]
H-MLP	Logical data sub-channel named "H-MLP" (see [ITU-T H.221])
HSD	Logical data sub-channel named "HSD" (see [ITU-T H.221])
LATM	Low-overhead MPEG-4 Audio Transport Multiplex (see [ISO/IEC 14496-3])
LSD	Logical data sub-channel named "LSD" (see [ITU-T H.221])
MLP	Logical data sub-channel named "MLP" (see [ITU-T H.221])
MPI	Minimum Picture Interval (see [ITU-T H.263])
NCA	Network Command send_address (see [ITU-T H.230])
NIA	Network Indicate Address (see [ITU-T H.230])
NIC	Network Indicate Consecutive_addresses (see [ITU-T H.230])
NID	Network Indicate Double_addresses (see [ITU-T H.230])
NIS	Network Indicate Same_addresses (see [ITU-T H.230])
SBE	Single Byte Extension (see [ITU-T H.230])

## **5 Terminal capabilities**

The procedures in this Recommendation are intended to ensure that only those signals are transmitted which can be received and appropriately treated by the remote terminal, without ambiguity. This requires that the capabilities of each terminal to receive and decode be known to the other terminal. Some capabilities are defined with a hierarchical structure: a terminal with capability value *N* is then also capable of all lower values. Where there is no hierarchy, then two or more codes of the same type may have to be transmitted in successive frames.

The following clauses define audio, video, transfer rate, and data rate capabilities of a terminal. It is not necessary that a terminal understand or store all incoming capabilities. Those which are not understood, or which cannot be used (because the terminal has no means of transmitting corresponding information), can be ignored. The terminal shall ignore any escape sequences in the ranges (111)[15-18, 21-23](000-110)[0-31] which it does not recognize, when occurring within a capability set.

The capability of a terminal to receive and decode various signals is made known to the other terminal by transmission (see clause 8.1) of its capability set, consisting of the BAS-capability marker followed by all of the current capabilities. In this regard, "current" capability does not necessarily mean all the latent capabilities of the terminal, but those relevant to the intended application. If, for example, a terminal is equipped for operation on up to six connections but the user currently only desires operation on one or two, then capability {2B} rather than {6B} shall be sent. Again, if a terminal has an external data port but nothing is connected there, data capabilities

should not be sent, since they may cause the needless opening of a data channel from the remote end.

The capability codes are specified in Annex A of [ITU-T H.221]; Table 52 (see clause 15) summarizes the capabilities which may be included in a valid set. The transmission order is generally immaterial, with the exceptions that video picture format values shall be followed by minimum picture interval values and Nil\_Data may be used to separate real from dummy data rates supported (see clause 12.5); it is also strongly suggested that {restricted\_required} be placed at the beginning of the set, following cap-mark, so that the remote end may react quickly if it is necessary to transmit the frame structure in a different bit position. Any included MBE messages of capability (such as that for [ITU-T H.262] and [ITU-T H.263]) must, of course, follow the byte sequence specified in clause 2.2.3 of [ITU-T H.230].

## 5.1 Audio capabilities

Audio capability values are defined in Annex A of [ITU-T H.221].

All audiovisual terminals intended for interregional operation shall be capable of transmitting and receiving A- and  $\mu$ -law G.711.

Normally, it is not necessary to transmit G.711 capabilities in a set containing other audio capabilities. Inclusion of just one value (A or  $\mu$ ) shall be interpreted as a request not to send audio signals encoded to the other law (see clause 9.3.1).

### 5.1.1 ISO/IEC 14496-3 capabilities

The ISO/IEC 14496-3 (MPEG-4 audio) capabilities as defined in Annex H of [ITU-T H.245] shall be signalled as an MBE indication with the format:

```
{ Start-MBE / N / <ISO/IEC14496-3Capability> / profileAndLevelByte1 / profileAndLevelByte2 / MaxAudioObjects / muxConfig / optionalParameterId / optionalParameterValue }
```

The coding of the parameters within the MBE message avoids emulation of the escape codes defined in Table A.1 of [ITU-T H.221]. N is the number of following bytes within the MBE.

profileAndLevel, MaxAudioObjects, and audioObjectType are defined in Annex H of [ITU-T H.245].

profileAndLevel indicates the capability of processing the particular profiles in combination with the given level. This integer parameter is sent thus:

If profileAndLevel is  $\leq 127$ , profileAndLevelByte1 equals profileAndLevel and profileAndLevelByte2 is not present.

If profileAndLevel is  $> 127$ , profileAndLevelByte1 is constructed with the two high order bits (bit 1 and 2) equal to binary '10' and the least significant 6 bits of profileAndLevel placed into the least significant 6 bits of profileAndLevelByte1. profileAndLevelByte2 is constructed with the 6 high order bits (bit 1 to 6) equal to binary '000000' and the most significant 2 bits of profileAndLevel placed into the least significant 2 bits of profileAndLevelByte2. In this case, both profileAndLevelByte1 and profileAndLevelByte2 are present.

MaxAudioObjects is a byte that specifies the maximum number of multiplexed audio objects in the audio payload.

muxConfig is a byte that indicates the capability to receive a set of bit rates and bit positions as defined in [ITU-T H.221]. It also indicates the capability of simultaneous support of high bit rates and a H-MLP channel (HiRates+HMLPCap). The format of muxConfig is shown in Table 1.

optionalParameterId is an optional byte that, if present, takes a value of 3. Other values are for further study. An Id value of 3 (see Annex H of [ITU-T H.245]) indicates that an optionalParameterValue byte follows. This byte defines the optional audioObjectType parameter.

audioObjectType indicates the set of tools to be used by the decoder of the bitstream contained in the logical channel. It can be used to limit the capability within the specified profileAndLevel in capability exchange.

**Table 1 – H221MuxConfig**

MSB				LSB			
1	2	3	4	5	6	7	8
0	HiRates+ HMLPCap	Reserved	Reserved	128 kbit/s	64 kbit/s	56 kbit/s	48 kbit/s

Bit 1 (value 128) shall be set to 0 to avoid MBE emulation.

Bit 2 when 1 indicates the capability to simultaneously support bit rates of 64 kbit/s or 128 kbit/s and a H-MLP channel. This means that, for example, if MPEG-4 audio at 64 kbit/s is present, a simultaneous H-MLP-128k channel would be located in TS3 and TS4 (see [ITU-T H.221]).

Bits 3 and 4 are reserved and shall be set to 0.

Bit 5 when 1 indicates MPEG-4 audio at 128 kbit/s.

Bit 6 when 1 indicates MPEG-4 audio at 64 kbit/s.

Bit 7 when 1 indicates MPEG-4 audio at 56 kbit/s.

Bit 8 when 1 indicates MPEG-4 audio at 48 kbit/s.

Support for a set of bit rates and bit positions is indicated by setting the related bits to 1.

Terminals should support MPEG-4 audio at 48 kbit/s for interoperability purposes.

NOTE – The MBE could be extended by adding more parameter id/value pairs if, in the future, more parameters are added to Annex H of [ITU-T H.245].

#### 5.1.1.1 Example

This example assumes the following configuration:

profileAndLevel: Main Audio Profile = 1

MaxAudioObjects = 1

H221MuxConfig: MPEG-4 audio at 64 kbit/s and MPEG-4 audio at 56 kbit/s = 6

audioObjectType: AAC main = 1

{start-MBE / 6 / <ISO/IEC14496-3Capability> / 1 / 1 / 6 / 3 / 1}

#### 5.1.1.2 Usage of generic parameters in H.320 systems

To allow implementors to better understand the use of the parameters defined in Annex H of [ITU-T H.245], Table 2a provides a description of how these parameters are translated and used in H.320 systems.

**Table 2a – Generic parameters used in Annex H of [ITU-T H.245] capabilities**

<b>Id #</b>	<b>Name</b>	<b>Value</b>
0	profileAndLevel	Integer (0..255)
1	formatType	Logical
2	MaxAL-sduFrames	Integer (1..256)
3	audioObjectType	Integer (0..31)
4	audioSpecificConfig	octetString (unbounded length)
5	MaxAudioObjects	Integer (1..16)
6	MuxConfigPresent	Logical
7	EP_DataPresent	Logical
8	StreamMuxConfig	octetString (unbounded length)
9	ErrorProtection_SpecificConfig	octetString (unbounded length)

profileAndLevel is mandatory for capabilities and commands.

formatType shall always be 1 because of the mandatory use of LATM. It is not signalled explicitly since it is implied by the H.320 capability. The characteristics of the audio stream in H.320 systems mandate the use of the LATM format for the multiplex layer with the AudioPointerStream format for the synchronization layer. LATM also allows inband transmission of StreamMuxConfig. LATM is defined in [ISO/IEC 14496-3].

MaxAL-sduFrames is a parameter used for H.323 systems and shall not be signalled in H.320 systems. It is the task of a gateway between H.320 and H.245 systems to handle such a parameter.

audioObjectType is mandatory for commands, but optional for capabilities.

audioSpecificConfig shall not be signalled in H.320 systems since it is not applicable to LATM formats.

MaxAudioObjects is mandatory for both capabilities and commands since LATM is used.

MuxConfigPresent indicates the presence of StreamMuxConfig. This parameter shall always be 1 and is not signalled explicitly.

EP\_DataPresent indicates if the EPMuxElement has error resiliency. Due to the mandatory use of the AudioPointerStream format, EPMuxElement shall never be present in the bitstream.

StreamMuxConfig shall be included in the LATM multiplex because of the limited bandwidth of the BAS channel. StreamMuxConfig shall be sent before audio data is sent. StreamMuxConfig should be re-sent periodically for redundancy.

ErrorProtection\_SpecificConfig is never used with AudioPointerStream format and, therefore, is not available in H.320 systems.

### **5.1.2 G.719 capabilities**

The ITU-T G.719 capability shall be signalled as an MBE indication with the format:

{Start-MBE / N / <G.719Capability> / rateNchannel}

The coding of the parameters within the MBE message avoids emulation of the escape codes defined in Table A.1 of [ITU-T H.221]. N is the number of following bytes within the MBE.

rateNchannel is a byte that indicates the capability to receive a set of bit rates and bit positions as defined in [ITU-T H.221]. It indicates the capability to support two channels. When indicating support for two channels, the signalled rates shall apply to both single and dual channel operation, with the exception of 32 and 48 kbit/s (which shall only be used for single channel).

It also indicates the capability of simultaneous support of high bit rates and an H-MLP channel (HiRates+HMLPCap). The format of rateNchannel is shown in Table 2b.

NOTE – The MBE can be extended, if in the future, more parameters are added.

**Table 2b – H221MuxConfig for G.719 audio**

MSB				LSB			
1	2	3	4	5	6	7	8
0	Channels	HiRates+ HMLPCap	128 kbit/s	96 kbit/s	64 kbit/s	48 kbit/s	32 kbit/s

Bit 1 (value 128) shall be set to 0 to avoid MBE emulation.

Bit 2 when set to 1 indicates support for both one and two channels. A value of 0 indicates support for only one channel.

Bit 3 when 1 indicates the capability to simultaneously support bit rates of 64 kbit/s, 96 kbit/s or 128 kbit/s and an H-MLP channel. This means that, for example, if G.719 audio at 64 kbit/s is present, a simultaneous H-MLP-128k channel would be located in TS3 and TS4 (see [ITU-T H.221]).

Bit 4 when 1 indicates G.719 audio at 128 kbit/s.

Bit 5 when 1 indicates G.719 audio at 96 kbit/s.

Bit 6 when 1 indicates G.719 audio at 64 kbit/s.

Bit 7 when 1 indicates G.719 audio at 48 kbit/s.

Bit 8 when 1 indicates G.719 audio at 32 kbit/s.

Support for a set of bit rates and bit positions are indicated by setting the specified bits to 1.

Terminals that support G.719 audio should support the rate of 48 kbit/s for interoperability purposes.

### 5.1.2.1 Example

This example assumes the following configuration:

rateNchannel: G.719 audio at 96 kbit/s, G.719 audio at 48 kbit/s and stereo = 74  
{start-MBE / 2 / <G.719Capability> / 74}

## 5.2 Video capabilities

The following types of video encoding can be controlled by the procedures of these Recommendations: **H.260-series and ISO/MPEG-1**.

The H.261 and ISO/MPEG-1 video capabilities are conveyed by BAS codes defined in [ITU-T H.221], and the other H.260-series capabilities are conveyed by messages defined in this Recommendation. The possible operating modes and parameters for H.261, H.262, and H.263 are summarized thus:

- H.261 in one of two picture formats: QCIF or CIF; in both cases there is one parameter, the minimum picture interval (MPI), having four possible values;
- H.262 in one of three picture formats: SIF, 2SIF or 4SIF; there are two parameters – MPI (9 values) and two Profiles (Simple, Main);
- H.263 in either one of five standard picture formats: SQCIF, QCIF, CIF, 4CIF and 16CIF or a custom picture size with or without a custom pixel aspect ratio. In all cases, MPI values can be specified by the user with or without a custom picture clock frequency.

This Recommendation does not provide for details of formats or parameters for ISO/MPEG-1 and other H.260-series coded video streams. The possible operating modes and parameters for other video codecs are defined elsewhere.

The H.261, H.263 and H.262 capabilities are hierarchical: any terminal declaring H.263 capability shall also declare H.261 capability; in general terms, any terminal declaring H.262 capability shall also declare both H.261 and H.263 capabilities. There are related stipulations regarding spatial resolution and MPI values, as detailed in clauses 5.2.3 and 5.2.4.

### 5.2.1 H.261 capabilities

The H.261 quarter-CIF value shall be followed by one MPI value. The H.261 full-CIF value shall be followed by two MPI values, the first applicable to quarter-CIF and the other to CIF.

### 5.2.2 H.262 and H.263 capabilities MBE message format

For H.262 and H.263 operation, the capabilities exchange is handled by an MBE message (see 2.2.3 of [ITU-T H.230]). This MBE message uses the type identification byte <H.262/H.263> (see Table 2 of [ITU-T H.230]), which indicates that enhanced video capability information follows. A terminal shall signal the H.262 and H.263 capabilities by including within its capset the message:

$$\{\text{Start-MBE/N/}<\text{H.262/3}>/\text{B}_1/. . ./\text{B}_{\text{N}-1}\}$$

This message may contain one or more capabilities for H.263 alone, or capabilities for both H.262 and H.263. It is not allowed for a terminal to signal only H.262 capabilities in this message.

For H.262, one byte is needed to signal each capability for a particular image format with its associated parameters (see clause 5.2.3). H.263 capabilities are specified using a variable number of bytes depending on the features and options selected (see clause 5.2.4). The ordering of the bytes within the single MBE message is as follows:

- a) First byte  $\text{B}_1$  is {highest standard format of H.263} then follow 0, 1 or 2 optional parameter bytes
- b) then {further standard formats of H.263 if needed (see clause 5.2.4) in descending order of resolution – with any optional parameter bytes}
- c) then {highest format of H.262}
- d) then {further formats of H.262 if needed (see clause 5.2.3) in descending order of resolution}
- e) then {extension codeword 01111111 if additional H.263 capabilities are to be specified}
- f) then {enhancement bytes for additional H.263 capabilities of the highest format of H.263}
- g) then {enhancement bytes for additional H.263 capabilities of further formats of H.263 if needed in descending order of resolution}
- h) then {extension codeword 01111111 if second additional H.263 capabilities are to be specified}
- i) then {enhancement bytes for second additional H.263 capabilities of the highest format of H.263}
- j) then {enhancement bytes for second additional H.263 capabilities of further formats of H.263 if needed in descending order of resolution}

As shown above, the H.263 capability bytes for a format are not contiguous. The H.263 capabilities specified for a format prior to the extension codeword 01111111 will be referred to as **initial** H.263 capabilities. The H.263 capabilities specified after the first extension codeword will be referred to



as **additional** H.263 capabilities and the bytes used to describe them as **enhancement** bytes. The H.263 capabilities specified after the second extension codeword 01111111 will be referred to as **second additional** H.263 capabilities and the bytes used to describe them as **enhancement** bytes.

For future expansion of the H.262/H.263 capabilities, the extension codeword 01111111 will be used as follows:

- A decoder shall interpret the extension codeword when encountered for the first time in the H.262/H.263 capabilities message to mean that the following bytes will contain additional H.263 capabilities.
- A decoder shall interpret the extension codeword when encountered for the first time within the first byte of additional H.263 capabilities to mean that the following bytes will contain second additional H.263 capabilities.

However, if this extension codeword is encountered again within the first byte of second additional H.263 capabilities of a particular format, all of the data following the extension codeword until the end of this MBE message shall be ignored. The appearance of this code in an MBE message does not affect the meaning of any bytes **prior** to this code byte.

### 5.2.3 H.262 capability byte

For H.262, one byte is necessary to signal the capabilities for a given image size format.

Although declaration of a capability for one of the image formats does mean that the endpoint has the capability to receive all lower formats of the same profile, and if the profile declared is MPML, then the endpoint can receive all SPML formats up to the stated value; it may still be necessary to transmit one or more further separate bytes (still in the same MBE message) to convey a different MPI value or profile for lower formats, thus:

- the MPI value specified in each byte applies to the format and profile specified therein; it also applies to all lower formats in that profile, unless an MPI value is explicitly defined in one or more separate capability bytes for lower formats;
- the MPI value specified for an MPML format also applies to SPML at that format and all lower formats, unless MPI values are explicitly defined in either MPML or SPML bytes for lower formats; an MPI value in an MPML byte never applies to an SPML format equal to or lower than that for which an explicit SPML value has been included in the message.

As an example, the sequence {(4SIF,MPML,MPI\_x); (2SIF/SPML/MPI\_y); (SIF,MPML,MLI\_z)} shall be taken to mean that there is also capability to receive (4SIF,SPML,MPI\_x); (2SIF,MPML,MPI\_x); and (SIF,SPML,MPI\_y).

The H.262 capability byte is structured as shown in Table 3 and its field values are defined in Table 4.

**Table 3 – H.262 capability byte**

1	2	3	4	5	6	7	8
0	MPI				H.262_Format		Profile

The first bit of an H.262 capability has a value of zero.

The MPI field defines the minimum picture interval that the decoder can process at the given format and profile.

The H.262\_Format field defines the resolution group.

The Profile field indicates whether the capability byte applies to the simple profile or to the main profile.

**Table 4 – H.262 capability byte field values**

MPI parameter		H.262_Format		Profile parameter	
0000	MPI_1	00	Reserved	0	H.262_SPML
0001	MPI_2	01	H.262_SIF	1	H.262_MPML
0010	MPI_3	10	H.262_2SIF		
0011	MPI_4	11	H.262_4SIF		
0100	MPI_5				
0101	MPI_6				
0110	MPI_10				
0111	MPI_15				
1000	MPI_30				
1001-1110	Reserved				
1111	Forbidden				

### Format capability values

- H.262\_SIF Can decode H.262 video to any of the three SIF image formats (CIF, SIF30, SIF25).
- H.262\_2SIF Can decode H.262 video to either of the two 2SIF formats (2SIF30, 2SIF25), and to all SIF image formats.
- H.262\_4SIF Can decode H.262 video to either of the two 4SIF formats (4SIF30, 4SIF25), and to all SIF and 2SIF image formats.

### Parameters

- MPI\_m Can decode video, having a minimum picture interval of  $m/29.97$  seconds for H.263 and H.262 30 Hz formats, and  $m/25$  seconds for H.262 25 Hz formats. The value of m is either 1, 2, 3, 4, 5, 6, 10, 15 or 30.
- H.262\_MPML Can decode H.262 Main Profile, Main Level video, as well as Simple Profile, Main Level video.
- H.262\_SPML Can decode H.262 Simple Profile, Main Level video.

### 5.2.4 H.263 capability bytes

A minimum of one byte to a maximum of three bytes is used to signal the **initial** H.263 capabilities for a particular standard format. For the initial H.263 capabilities, a baseline H.263 capability byte for a specific spatial resolution and MPI code may be followed by one or two optional bytes.

Although declaration of a baseline capability for one of the standard image formats does mean that the endpoint has the capability to receive all lower standard formats, it may be necessary to transmit a separate baseline byte (still in the same MBE message) to convey a different MPI value or optional enhancements for lower standard formats, thus:

- the MPI value specified in the baseline byte applies to the standard format specified therein; it also applies to all lower standard formats, unless an MPI value is explicitly defined in one or more separate baseline capability bytes for lower standard formats;
- optional capabilities specified in the optional bytes apply to the standard format specified in the preceding baseline byte; they also apply to all lower standard formats, unless applicable enhanced capabilities are explicitly defined in optional bytes following a separate baseline capability byte for a lower standard format.

**Additional** H.263 capabilities for the standard formats specified in the initial H.263 capabilities declaration may be specified using a variable number of **enhancement** bytes. These enhancement bytes shall also be used to specify H.263 capabilities for any custom formats including the custom picture size, custom picture clock frequency and custom pixel aspect ratio. The additional H.263 capabilities declaration shall specify the capabilities for each of the standard H.263 formats in the order used in the initial capabilities message. The additional H.263 capabilities of all smaller standard resolutions can be skipped if their capabilities are the same as that of the last declared larger format. However, if some smaller formats have particular additional capabilities to support, their capabilities cannot be skipped. Capabilities for a custom picture format are inserted between its respective "equivalent" standard resolution and the next larger standard resolution where the equivalent resolution is the largest standard resolution smaller than or equal to the upper bound of the resolution range specified in the custom picture format in both height and width. For example, if the formats signalled are the standard formats CIF, 4CIF and the custom source format range  $[176..528] \times [144..432]$ , then the following illustrates how the capabilities are ordered:

Initial H.263 @ 4CIF capabilities, initial H.263 @ CIF capabilities, H.262 capabilities, extension codeword, additional H.263 @ 4CIF capabilities, additional H.263 @  $[176..528] \times [144..432]$  capabilities, additional H.263 @ CIF capabilities.

The following hierarchical rules are used when any of the custom format features are used:

- Any coder with a custom picture size shall support the "equivalent" standard picture size, where the equivalent size is the largest standard picture size smaller than or equal to the upper bound of the resolution range specified in the custom picture size in both height and width. If a custom picture size is smaller than QCIF, the equivalent resolution will be QCIF. For example, if the custom picture size range is  $[176..528] \times [144..432]$ , the equivalent standard size is CIF ( $352 \times 288$ ). If the custom picture size is  $120 \times 90$ , the equivalent standard size is QCIF ( $176 \times 144$ ).
- If a H.320 terminal supports a custom pixel aspect ratio for any standard picture size, it shall also support the standard pixel aspect ratio (12:11) for that picture size. If a H.320 terminal supports a custom pixel aspect ratio for a custom picture size, it shall also support the standard pixel aspect ratio (12:11) for the equivalent standard picture size.
- If a H.320 terminal supports a minimum picture interval (MPI) of greater than or equal to  $1001/30\ 000$  seconds with a custom picture clock frequency for any standard picture size, it shall also support a better (i.e., smaller) or equal MPI for all smaller standard picture sizes at the standard picture clock frequency ( $30\ 000/1001$  Hz, approximately 29.97 Hz) where MPI is measured in seconds (and not picture clock ticks). If a H.320 terminal supports a MPI of less than  $1001/30\ 000$  seconds (necessarily with a custom picture clock frequency) for any standard picture size, it shall also support a MPI of  $1001/30\ 000$  seconds for all smaller standard picture sizes at the standard picture clock frequency (i.e., the terminal shall support a MPI of 1 picture clock tick at the standard picture clock frequency). If a H.320 terminal supports a MPI of greater than or equal to  $1001/30\ 000$  seconds with a custom picture clock frequency for a custom picture format, it shall also support a better (i.e., smaller) or equal MPI for the equivalent standard picture size and all smaller standard picture sizes at the standard picture clock frequency. If a H.320 terminal supports a MPI of less than  $1001/30\ 000$  seconds (necessarily with a custom picture clock frequency) for a custom picture format, it shall also support a MPI of  $1001/30\ 000$  seconds for the equivalent standard picture size and all smaller standard picture sizes at the standard picture clock frequency (i.e., the terminal shall support a MPI of 1 picture clock tick at the standard picture clock frequency).

### 5.2.4.1 Baseline H.263 capability byte

The byte structure for the first byte for initial H.263 capabilities is shown in Table 5.

**Table 5 – Initial capabilities first byte**

1	2	3	4	5	6	7	8
0	MPI			H.263_Format		Options	

The first bit has a value of one.

The 4-bit MPI field is identical to the field used for [ITU-T H.262] (see clause 5.2.3).

The H.263\_Format field defines the resolution as specified in Table 6.

**Table 6 – H.263\_Format**

Value	Description
00	H.263_QCIF/SQCIF
01	H.263_CIF
10	H.263_4CIF
11	H.263_16CIF

If the Options field is zero, the same optional capabilities, if any, signalled for the higher resolutions apply also to this resolution; if this is the highest resolution, then only the baseline capabilities apply at this resolution. If the Options field has a value of one, a second byte follows containing the optional capabilities (see clause 5.2.4.2).

#### Format capability values

**H.263\_QCIF/SQCIF** Can decode H.263 algorithm to QCIF and sub-QCIF (SQCIF) picture formats. Only one set of capabilities is sent for these two resolutions, as the MPI values for QCIF and SQCIF shall be identical.

**H.263\_CIF** Can decode H.263 algorithm to CIF, QCIF and sub-QCIF picture formats.

**H.263\_4CIF** Can decode H.263 algorithm to 4CIF, CIF, QCIF and sub-QCIF picture formats.

**H.263\_16CIF** Can decode H.263 algorithm to 16CIF, 4CIF, CIF, QCIF and sub-QCIF picture formats.

#### MPI values

**MPI\_m** Can decode video, having a minimum picture interval of  $m/29.97$  seconds for H.263 and H.262 30 Hz formats, and  $m/25$  seconds for H.262 25 Hz formats. The value of  $m$  is either 1, 2, 3, 4, 5, 6, 10, 15 or 30.

### 5.2.4.2 Options bytes

The format of the optional second byte for initial H.263 capabilities is shown in Table 7 and its field values are defined in Table 8.

**Table 7 – Initial capabilities second byte**

1	2	3	4	5	6	7	8
0	CPM	UMV	AMP	AC	PB	Specify HRD-B	Specify BPPmax KB

**Table 8 – Initial capabilities second byte field definition**

Name	Value	Description
CPM	0	Reserved for future use. Shall be set to zero.
	1	Value of one not allowed.
UMV	0	Not capable of using unrestricted motion vectors.
	1	Capable of unrestricted motion vectors.
AMP	0	Not capable of using advanced motion prediction.
	1	Capable of using advanced motion prediction.
AC	0	Not capable of using arithmetic coding option.
	1	Capable of using arithmetic coding option.
PB	0	Not capable of using PB Frames option.
	1	Capable of using PB Frames option.
Specify HRD-B	0	Use HRD-B scaling factor from higher resolution format, or use default value (HRD-B_Default) if this is the highest resolution format.
	1	Use HRD-B value found in the first four bits of the following byte.
Specify BPPmaxKB	0	Use BPPmaxKB scaling factor from higher resolution format, or use default value (BPPmaxKB_Default) if this is the highest resolution format.
	1	Use BPPmaxKB value found in the last four bits of the following byte.

If either of the HRD-B or BPPmaxKB fields is set to one, a third byte is sent that gives the value that shall be used. If only one of the two bits is set to one, the default value shall be used for the field that is set to zero, independent of the value in the third byte. This third byte has the format shown in Table 9.

**Table 9 – Initial capabilities third byte**

1	2	3	4	5	6	7	8
HRD-B				BPPmaxKB			

The values for the HRD-B and BPPmaxKB fields are given in Table 10.

**Table 10 – HRD-B and BPPmaxKB field values**

HRD-B Size		BPPmaxKB	
0000	HRD-B_Default	0000	BPPmax_Default
0001	HRD-B × 1.25	0001	BPPmaxKB × 1.25
0010	HRD-B × 1.5	0010	BPPmaxKB × 1.5
0011	HRD-B × 1.75	0011	BPPmaxKB × 1.75
0100	HRD-B × 2	0100	BPPmaxKB × 2
0101	HRD-B × 2.5	0101	BPPmaxKB × 2.5
0110	HRD-B × 3	0110	BPPmaxKB × 3
0111	HRD-B × 4	0111	BPPmaxKB × 4
1000	HRD-B × 8	1000	BPPmaxKB × 8
1001	HRD-B × 16	1001	BPPmaxKB × 16
1010	HRD-B × 32	1010	BPPmaxKB × 32
1011	HRD-B × 64	1011	BPPmaxKB × 64

**Table 10 – HRD-B and BPPmaxKB field values**

HRD-B Size		BPPmaxKB	
1100	HRD-B × 128	1100	BPPmaxKB × 128
1101	HRD-B × 256	1101	BPPmaxKB × 256
1110-1111	Reserved	1110-1111	Reserved

- HRD-B\_Default Decoder can only support the default H.263 HRD buffer parameter B, which has the value of  $4 \times R_{max}/29.97$ , where  $R_{max}$  is the maximum video bit rate to be used in the connection. (Typically, total connection bit rate is used as the value  $R_{max}$ .)
- HRD-B × M Decoder can support M times the default H.263 HRD buffer parameter B. The value of M may be 1.25, 1.5, 1.75, 2, 2.5, 3, 4, 8, 16, 32, 64, 128 or 256.
- BPPmaxKB\_Default Decoder can only support the default H.263 maximum bits per picture value BPPmaxKB.
- BPPmaxKB × M Decoder can support M times the default H.263 maximum bits per picture value BPPmaxKB. The value of M is either 1.25, 1.5, 1.75, 2, 2.5, 3, 4, 8, 16, 32, 64, 128 or 256.

### 5.2.4.3 Examples

Some examples of valid initial H.263 capabilities are as follows:

- {start-MBE/2/<H.262/H.263>/H.263\_4CIF + MPI\_2}
- {start-MBE/4/<H.262/H.263>/H.263\_4CIF + MPI\_4/H.263\_CIF + MPI\_3/H.263\_QCIF/SQCIF + MPI\_2}
- {start-MBE/7/<H.262/H.263>/H.263\_4CIF + MPI\_4 + Options/AC/H.263\_CIF + MPI\_3 + Options/AC + PB/H.263\_QCIF/SQCIF + MPI\_2 + Options/AC + PB + UMV}
- {start-MBE/8/<H.262/H.263>/H.263\_4CIF + MPI\_4 + Options/UMV + AMP/H.263\_CIF + MPI\_3 + Options/UMV + AMP + AC + define BPPmaxKB/BPPmaxKB × 4/H.263\_QCIF/SQCIF + MPI\_2 + Options/UMV + AMP + AC + PB}

### 5.2.4.4 Additional H.263 capabilities

The additional H.263 capabilities are specified using a variable number of enhancement bytes from the bytes described in this clause. The bytes shall be transmitted in the order described in this clause.

In summary, this clause specifies that the following byte(s) (described in detail below) are present for each format "larger than or equal to the smallest format for which distinct H.263 additional capabilities are declared". These are presented in the same order as the baseline H.263 Capability Byte(s) above, except that any Custom Picture Formats "are inserted between its respective 'equivalent' standard resolution and the next larger standard resolution". Commas (,) and brackets ([,]) separate bytes. [ Bracketed ] text indicates optional byte(s).

```
additionalH.263CapByte
[ minCustomPictureHeight, minCustomPictureWidth
  [ maxCustomPictureHeight, maxCustomPictureWidth ] ]
[ customPCFByte1, customPCFByte2
  [ HRDBPPmaxKB ] ]
[ customPixelWidth, customPixelHeight ]
[ profileExtensionByte (for further study - not currently used)]
```

```

[ individualOptionIndicator
  [ optionByte1 ]
  [ optionByte2 ]
  [ optionByte3 ]
  [ refSliceParamters ]
  [ scalabilityDescriptor, enhancementLayerInfo
    [ enhancmentLayerInfo ... ] ] ]

```

The leading H.263 enhancement byte (additionalH.263CapByte) shall be transmitted for all formats larger than or equal to the smallest format for which distinct H.263 additional capabilities are declared. The additionalH.263CapByte is structured as shown in Table 11.

**Table 11 – Additional H.263 capabilities byte**

1	2	3	4	5	6	7	8
formatIndicator		0	customP CFFlag	customP ARFlag	optionsIndicator		

The formatIndicator field indicates if additional capabilities that follow are defined for a standard H.263 format or for a custom format.

The third bit has a value of zero.

The customPCFFlag indicates if a custom picture clock frequency is supported.

The customPARFlag indicates if a custom pixel ratio is supported.

The optionsIndicator field indicates if H.263 options will be inherited, individually signalled or if profiles will be used. The H.263 options in the additional capabilities message shall refer to all the H.263 options signalled in the additional H.263 capabilities message only.

**Table 12 – formatIndicator**

Value	Description
00	Enhancements defined for the ordered standard format in initial H.263 capability message
01	Reserved
10	Presence of custom picture format. Equal bounds. Enhancements defined for the custom picture format and the equivalent standard format.
11	Presence of custom picture format. Two distinct bounds. Enhancements defined for the larger of the two formats and the equivalent standard format.

Either a range of custom picture sizes, or one distinct custom picture size, can be supported. If formatIndicator is 10, then only a single distinct custom picture size support is indicated such as  $528 \times 432$ . If formatIndicator is 11, then a specific range of custom picture sizes indicated within two distinct bounds is supported such as  $[176..528] \times [144..432]$ .

**Table 13 – CustomPCFFlag**

Value	Description
0	No custom picture clock frequency is supported.
1	Custom picture clock frequency is supported.

**Table 14 – CustomPARFlag**

Value	Description
0	No custom pixel aspect ratio is supported.
1	Custom pixel aspect ratio is supported.

**Table 15 – OptionsIndicator**

Value	Description
000	H.263 options are signalled separately and/or H.263 scalability mode defined in Annex O of [ITU-T H.263] is supported. Initial H.263 options are inherited from the "equivalent" standard picture size, as defined in clause 5.2.4 (the immediately smaller standard format).
001	Inherit H.263 options from immediately larger format.
010	H.263 Profile 1 supported
011	Forbidden
100	Forbidden
101	No additional H.263 options are supported.
110	Reserved.
111	Reserved

NOTE – Values 011 and 100 were used to indicate support for Profile/Level 1 and 2 and Profile/Level 1, 2, and 3 respectively in a previous version of this Recommendation.

Inheritance shall imply inheritance of both the H.263 options signalled in the additional H.263 capabilities and of any options signalled in the initial H.263 capabilities.

Annex X of [ITU-T H.263] Profile 1 (H.320 coding efficiency version 2 backward-compatibility profile) was known as "Profile/Level 1" in a previous version of this Recommendation. The level parameters defined in Annex X of [ITU-T H.263] are signalled by the H.263 capability bytes which include the format indicator and the MPI for that format.

The following bytes are optional. They shall be sent in the order presented below (Tables 16, 17, 18, and 19).

The minCustomPictureHeight byte shall be present if formatIndicator is either 10 or 11.

The minCustomPictureWidth byte shall be present if formatIndicator is either 10 or 11.

The maxCustomPictureHeight byte shall be present if formatIndicator is 11.

The maxCustomPictureWidth byte shall be present if formatIndicator is 11.

**Table 16 – minCustomPictureHeight**

Octet binary value	Description
00000000-10001111	MinFrameHeight/8 – 1
10010000-11111111	Forbidden



**Table 17 – minCustomPictureWidth**

Octet binary value	Description
00000000-11011111	MinFrameWidth/8 – 1
11100000-11111111	Forbidden

**Table 18 – maxCustomPictureHeight**

Octet binary value	Description
minCustomPictureHeight-10001111	MaxFrameHeight/8 – 1
10010000-11111111	Forbidden

**Table 19 – maxCustomPictureWidth**

Octet binary value	Description
minCustomPictureWidth-11011111	MaxFrameWidth/8 – 1
11100000-11111111	Forbidden

The parameters minFrameHeight, minFrameWidth, maxFrameHeight and maxFrameWidth indicate the range of sizes that an encoder or decoder can use. If formatIndicator is 10, then only the custom picture format with minFrameHeight lines and minFrameWidth pixels per line is supported. Note that although minFrameHeight, minFrameWidth, maxFrameHeight and maxFrameWidth can only signal even multiples of 4, odd as well as even multiples of 4 within the specified range shall also be supported by the video decoder.

The customPCFByte1 and customPCFByte2 shall be present if customPCFFlag in additionalH.263CapByte is 1. These indicate the parameters for custom picture clock frequency. the customPCFByte1 is structured as shown in Table 20 and its field values are defined in Tables 21 and 22.

**Table 20 – customPCFByte1**

1	2	3	4	5	6	7	8
clockDivisor							clock Conversion Code

**Table 21 – clockDivisor**

Octet binary value	Description
0000000	Any Picture clock frequency is supported.
0000001-1101111	Allowed
1110000-1111111	Forbidden

**Table 22 – clockConversionCode**

Bit	Value
0	1000
1	1001

clockDivisor indicates the natural binary representation of the value of the clock divisor.

clockConversionCode indicates a clock conversion code when custom picture clock frequency is used.

The custom picture clock frequency is given by  $1'800'000 / (\text{clock divisor} \times \text{clock conversion code})$ .

The customPCFByte2 is structured as shown in Table 23.

**Table 23 – customPCFByte2**

1	2	3	4	5	6	7	8
customMPIIndicator						Specify HRD-B	Specify BPPmax KB

**Table 24 – customMPIIndicator**

Octet binary value	Description
000000-110111	Allowed
111000-111111	Forbidden

customMPIIndicator indicates the minimum picture interval in conjunction with the custom picture clock frequency. The minimum picture interval is given by  $(\text{custom MPI Indicator} + 1) / \text{custom picture clock frequency}$ .

The Specify HRD-B and Specify BPPMaxKB specify if either of HRD-B or BPPmaxKB shall be specified.

HRDBPPmaxKB byte shall be present if either of the Specify HRD-B or Specify BPPmaxKB bits are 1. Its structure is shown in Table 25.

**Table 25 – HRDBPPmaxKB byte**

1	2	3	4	5	6	7	8
HRD-B				BPPmaxKB			

The HRD-B and BPPmaxKB are defined in clause 5.2.4.2. If present, these shall take precedence over the values specified in the initial H.263 capabilities.

The customPixelWidth byte and customPixelHeight byte shall be present if customPARFlag bit in additionalH.263CapByte is 1.

**Table 26 – customPixelWidth**

Octet binary value	Description
00000000	Any pixel width between 1-223 is supported.
00000001-11011111	Pixel width
11100000-11111111	Forbidden

**Table 27 – customPixelHeight**

Octet binary value	Description
00000000	Any pixel height between 1-223 is supported.
00000001-11011111	Pixel height
11100000-11111111	Forbidden

The pixel height and pixel width shall be relatively prime to each other. The pixel height and pixel width indicate the capability to support the pixel aspect ratio as indicated by the H.263 extended pixel aspect ratio code (EPAR).

The profileExtensionByte shall be present if optionsIndicator is 111. It shall be used in the future for defining additional H.263 profiles and shall take values from 0-223 only. Current decoders shall be designed to discard this byte for backward compatibility.

The individualOptionIndicator byte shall be present if optionsIndicator is 000 and is structured as shown in Table 28.

**Table 28 – Individual option indicator byte**

1	2	3	4	5	6	7	8
0	option Byte1Flag	option Byte2Flag	option Byte3Flag	scalability Flag	errorCom pensation	Reserved	Reserved

If any of the flags are 1, then the supported options shall be further specified using further bytes in the capabilities message as described below. If scalabilityFlag is 1, then it indicates the capability to transmit or receive scalable bit streams as described in Annex O of [ITU-T H.263]. The exact form of scalability shall be specified later in the capabilities message. If errorCompensation is 1, it indicates the capability to transmit and/or receive feedback information for error compensation such as that illustrated in Appendix I of [ITU-T H.263]. When part of a transmit capability, it indicates the ability of the encoder to process videoNotDecodedMBs indications and compensate errors. When part of a receive capability, it indicates the ability of the decoder to identify erroneous MBs, treat them as not coded and send appropriate videoNotDecodedMBs indications (see [ITU-T H.230]).

optionByte1 shall be present if optionByte1Flag is 1 and is structured as shown in Table 29.

**Table 29 – optionByte1**

Bit	Name	Value	Description
1		0	Fixed
2	advancedIntraCodingMode	0 1	Not capable of using advancedIntraCodingMode Capable of using advancedIntraCodingMode
3	deblockingFilterMode	0 1	Not capable of using deblockingFilterMode Capable of using deblockingFilterMode
4	fullPictureFreeze	0 1	Not capable of using fullPictureFreeze Capable of using fullPictureFreeze
5	modifiedQuantizationMode	0 1	Not capable of using modifiedQuantizationMode Capable of using modifiedQuantizationMode
6	unlimitedUnrestrictedMotionVectors	0 1	Not capable of using unlimitedUnrestrictedMotionVectors Capable of using unlimitedUnrestrictedMotionVectors
7	dynamicPictureResizingByFour	0 1	Not capable of using dynamicPictureResizingByFour Capable of using dynamicPictureResizingByFour
8	refPictureSelection	0 1	Not capable of using refPictureSelection Capable of using refPictureSelection.

deblockingFilterMode, when 1, indicates the capability to transmit or receive the Deblocking Filter Mode (Annex J of [ITU-T H.263]).

fullPictureFreeze, when 1, indicates the capability of the encoder to send, or the decoder to receive, Full Picture Freeze commands as described in Annex L of [ITU-T H.263].

modifiedQuantizationMode, when 1, indicates the capability of an encoder or decoder to support the Modified Quantization Mode (Annex T of [ITU-T H.263]).

unlimitedUnrestrictedMotionVectors, when 1, indicates the capability of the encoder or decoder to support unlimited motion vector range when Unrestricted Motion Vector Mode (Annex D of [ITU-T H.263]) is also indicated. unlimitedUnrestrictedMotionVectors shall be 0 if UMV bit is set to 0 in the initial H.263 capabilities of a particular format.

dynamicPictureResizingByFour, when 1, indicates the capability of an encoder or decoder to support the picture resizing-by-four (with clipping) submode of the implicit Reference Picture Resampling Mode (Annex P of [ITU-T H.263]).

The declaration of the capability dynamicPictureResizingByFour with a given picture size, referred to here as the native picture size, implies the support for up to two other picture sizes, referred to here as derived picture sizes. Defining the native picture size as having picture width W, and picture height H; the supported derived picture sizes shall have picture width W/2 and picture height H/2, and picture width W/4 and picture height H/4, subject to the following constraint. Each derived picture size shall be supported provided its picture width is not less than 128 and its picture height is not less than 96 (128 and 96 being the picture width and height of the SQCIF format). The derived picture sizes shall be supported with the same optional modes, minimum picture interval (MPI) and clock frequency as supported with the native picture size.

refPictureSelection indicates the capability of Reference Picture Selection mode (Annex N of [ITU-T H.263]). The supported parameters are specified in the refSliceParam byte which shall be transmitted later.

optionByte2 shall be present if optionByte2Flag is 1 and is structured as shown in Table 30.

**Table 30 – optionByte2**

Bit	Name	Value	Description
1		0	Fixed
2	sliceStructuredMode	0	Not capable of using sliceStructuredMode
		1	Capable of using sliceStructuredMode
3	independentSegmentDecoding	0	Not capable of using independentSegmentDecoding
		1	Capable of using independentSegmentDecoding
4	reducedResolutionUpdate	0	Not capable of using reducedResolutionUpdate
		1	Capable of using reducedResolutionUpdate
5	transparencyChromaKey	0	Not capable of using transparencyChromaKey
		1	Capable of using transparencyChromaKey
6	improvedPBFrames	0	Not capable of using improvedPBFrames
		1	Capable of using improvedPBFrames
7	partialPictureFreezeAndRelease	0	Not capable of using partialPictureFreezeAndRelease
		1	Capable of using partialPictureFreezeAndRelease
8	alternateInterVLC	0	Not capable of using alternateInterVLC
		1	Capable of using alternateInterVLC

sliceStructuredMode, when 1, indicates the capability of slice structured mode (Annex K of [ITU-T H.263]). The supported parameters are specified in the refSliceParam byte which shall be transmitted later.

independentSegmentDecoding, when 1, indicates the capability of an encoder or decoder to support the Independent Segment Decoding Mode (Annex R of [ITU-T H.263]).

reducedResolutionUpdate, when 1, indicates the capability of an encoder or decoder to support the Reduced Resolution Update mode defined in Annex Q of [ITU-T H.263].

transparencyChromaKeying, when 1, indicates that a transparent video layer (Annex L of [ITU-T H.263]) is supported. The parameters allowed shall be zero offsets and no scaling only.

improvedPBframes Mode, when 1, indicates the capability to transmit or receive the Improved PB frames Mode (Annex M of [ITU-T H.263]).

partialPictureFreezeAndRelease, when 1, indicates the capability of the encoder to send or the decoder to receive partial Picture Freeze and Release commands as described in Annex L of [ITU-T H.263].

alternateInterVLCMode, when 1, indicates the capability of an encoder or decoder to support Alternate Inter VLC Mode (Annex S of [ITU-T H.263]).

optionByte3 shall be present if optionByte3Flag is 1 and is structured as shown in Table 31.

**Table 31 – optionByte3**

Bit	Name	Value	Description
1-2	dynamicWarping	00	No dynamic warping supported
		01	dynamicWarpingHalfPel
		10	dynamicWarpingSixteenthPel
		11	Forbidden
3	fullPictureSnapshot	0	Not capable of using fullPictureSnapshot
		1	Capable of using fullPictureSnapshot
4	partialPictureSnapshot	0	Not capable of using partialPictureSnapshot
		1	Capable of using partialPictureSnapshot
5	videoSegmentTagging	0	Not capable of using videoSegmentTagging
		1	Capable of using videoSegmentTagging
6	progressiveRefinement	0	Not capable of using progressiveRefinement
		1	Capable of using progressiveRefinement
7	dynamicPictureResizingSixteenthPel	0	Not capable of using dynamicPictureResizingSixteenthPel
		1	Capable of using dynamicPictureResizingSixteenthPel
8	temporalSpatialTradeOffCapability	0	Not capable of using temporalSpatialTradeOffCapability
		1	Capable of using temporalSpatialTradeOffCapability

dynamicWarpingHalfPel, when present, indicates the capability of an encoder or decoder to support the arbitrary picture warping operation within the Reference Picture Resampling mode (Annex P of [ITU-T H.263]) (with any fill mode) using half-pixel accuracy warping.

dynamicWarpingSixteenthPel, when present, indicates the capability of an encoder or decoder to support the arbitrary picture warping operation within the Reference Picture Resampling mode (Annex P of [ITU-T H.263]) (with any fill mode) using either half-pixel or sixteenth pixel accuracy warping.

fullPictureSnapshot, when 1, indicates the capability of the encoder to send, or the decoder to receive, Full Picture snapshots of the video content as described in Annex L of [ITU-T H.263].

partialPictureSnapshot, when 1, indicates the capability of the encoder to send, or the decoder to receive, Partial Picture Snapshots of the video content as described in Annex L of [ITU-T H.263].

videoSegmentTagging, when 1, indicates the capability of the encoder to send, or the decoder to receive, Video Segment tagging for the video content as described in Annex L of [ITU-T H.263].

progressiveRefinement, when 1, indicates the capability of the encoder to send, or the decoder to receive, Progressive Refinement tagging as described in Annex L of [ITU-T H.263]. In addition, when 1, the encoder shall respond to the progressive refinement commands doOneProgression, doContinuousProgressions, doOneIndependentProgression, doContinuousIndependentProgressions, progressiveRefinementAbortOne, and progressiveRefinementAbortContinuous (see [ITU-T H.221]). In addition, the encoder shall insert the Progressive Refinement Segment Start Tags and the Progressive Refinement Segment End Tags as defined in the "Supplemental Enhancement Information Specification" (Annex L of [ITU-T H.263]).

dynamicPictureResizingSixteenthPel, when 1, indicates the capability of an encoder or decoder to support resizing a reference picture to any supported width and height using the implicit Reference Picture Resampling mode (Annex P of [ITU-T H.263] (with clipping)).

The supported picture sizes include all the declared picture sizes through capability exchange and those derived from dynamicPictureResizingByFour.

If dynamicPictureResizingSixteenthPel is 1, then dynamicPictureResizingByFour shall be 1. If dynamicWarpingSixteenthPel is 1, then dynamicWarpingHalfPel, dynamicPictureResizingByFour, and dynamicPictureResizingSixteenthPel shall be supported.

If dynamicPictureResizingByFour is supported, all the derived picture sizes from this capability shall also be considered supported.

temporalSpatialTradeOffCapability, when 1, indicates that the encoder is able to vary its trade-off between temporal and spatial resolutions as commanded by the remote terminal (see [ITU-T H.230]). It has no meaning when part of a receive capability.

The following refSliceParameters byte shall be present if either refPictureSelection (optionByte1 bit 8) or sliceStructuredMode (optionByte2 bit 2) is 1. Its structure is shown in Table 32.

**Table 32 – Reference slice parameters byte**

1	2	3	4	5	6	7	8
videoBackChannel			additionalPictureMemory			sliceType	

The videoBackChannel takes on the values specified in Table 33.

**Table 33 – videoBackChannel**

Value	Description
000	ackMessageOnly
001	nackMessageOnly
010	ackOrNackMessageOnly
011	ackAndNackMessage

**Table 33 – videoBackChannel**

100	none
101	Reserved
110	Reserved
111	Forbidden

ackMessageOnly indicates that the encoder is capable of sending, or the decoder is capable of receiving, an H.263 bit stream which contains requests for only acknowledgement back channel messages to be returned.

nackMessageOnly indicates that the encoder is capable of sending, or the decoder is capable of receiving, an H.263 bit stream which contains requests for only non-acknowledgement back channel messages to be returned.

ackOrNackMessageOnly indicates that the encoder is capable of sending, or the decoder is capable of receiving, an H.263 bit stream which contains requests for either acknowledgement or non-acknowledgement back channel messages to be returned, but only one for a particular video bit stream.

ackAndNackMessage indicates that the encoder is capable of sending, or the decoder is capable of receiving an H.263 bit stream which contains requests for acknowledgement and non-acknowledgement back channel messages to be returned. This also indicates support for any of the subsets of these capabilities namely none, ackMessageOnly, nackMessageOnly and ackOrNackMessageOnly.

none indicates that the encoder is not capable of sending, or the decoder is not capable of receiving, an H.263 bit stream which contains requests for any back-channel messages to be returned. The ability to operate without back channel message requests is implied with any of the above back channel capabilities.

additionalPictureMemory takes on values from 0-7. If present, as shown in Table 34, additionalPictureMemory indicates the presence of the extra amount of memory in addition to that which can be used by a normal decoder which does not support reference picture selection mode. It is meaningful only if refPictureSelection (optionByte1 bit 8) is 1.

**Table 34 – additionalPictureMemory**

Value	Description
000-111	Number of Additional Picture Memories

**Table 35 – sliceType**

Value	Description
00	slicesInOrder-NonRect
01	slicesInOrder-RectOrNonRect
10	slicesAnyOrder-NonRect
11	slicesAnyOrder-RectOrNonRect

slicesInOrder-NonRect indicates the capability of an encoder or decoder to support the submode of Slice Structured Mode (Annex K of [ITU-T H.263]) where slices are transmitted in order and contain macroblocks in scanning order of the picture.

slicesInOrder-RectOrNonRect indicates the capability of an encoder or decoder to support the submode of Slice Structured Mode (Annex K of [ITU-T H.263]) where slices are transmitted in order and the slice either occupies a rectangular region of the picture or the slice contains macroblocks in scanning order of the picture.

slicesAnyOrder-NonRect indicates the capability of an encoder or decoder to support the submode of Slice Structured Mode (Annex K of [ITU-T H.263]) where slices contain macroblocks in scanning order of the picture and need not be transmitted in order.

slicesAnyOrder-RectOrNonRect indicates the capability of an encoder or decoder to support the submode of Slice Structured Mode (Annex K of [ITU-T H.263]) where slices occupy either rectangular regions of the picture or macroblocks in scanning order of the picture, and need not be transmitted in order.

The following optional bytes are used to describe scalability support. Only hierarchical scalability is allowed in which decoding any layer will require decoding of all the lower SNR and spatial scalable layers. All the layers will use the capabilities of the base layer consistent with their own kind of scalabilities. No further options are specified for each layer.

The scalabilityDescriptor optional byte shall be present if scalabilityFlag in the individualOptionIndicator byte is 1. Its structure is specified in Table 36.

**Table 36 – Scalability descriptor optional byte**

1	2	3	4	5	6	7	8
numberOfScalableLayers-1				maximumBitRateOfBaseLayer			

**Table 37 – numberOfScalableLayers-1**

Value	Description
0000-1101	Number of scalable Layers – 1
1110-1111	Forbidden

**Table 38 – maximumBitRateOfBaseLayer**

Value	Bit rate of base layer
0000	64 kbit/s
0001	128 kbit/s
0010	192 kbit/s
0011	256 kbit/s
0100	320 kbit/s
0101	384 kbit/s
0110	768 kbit/s
0111	1152 kbit/s
1000	1536 kbit/s
1001	16 kbit/s
1010	32 kbit/s
1011	48 kbit/s
1100	Unrestricted
1101-1111	Reserved



Number of enhancement layers supported is  $\text{numberOfScalableLayers} - 1 + 1$ .  
 $\text{maximumBitRateOfBaseLayer}$  specifies the maximum bit rate of the base layer.

The  $\text{scalabilityDescriptor}$  byte is followed by  $\text{enhancementLayerInfo}$  bytes, one for each enhancement layer. The  $\text{enhancementLayerInfo}$  byte specifies the characteristics of an enhancement layer. The number of  $\text{enhancementLayerInfo}$  bytes present shall equal the number of enhancement layers. The  $\text{enhancementLayerInfo}$  bytes shall be ordered from the lowest to the highest layer. The structure of  $\text{enhancementLayerInfo}$  byte is shown in Table 39.

**Table 39 – Enhancement layer info byte**

1	2	3	4	5	6	7	8
$\text{maxBitRateOfEnhancementLayer}$				spatial Scalable1D	spatial Scalable2D	snr Scalable	temporal Scalable

**Table 40 –  $\text{maxBitRateOfEnhancementLayer}$**

Value	maximum bit rate of enhancement layer
0000	64 kbit/s
0001	128 kbit/s
0010	192 kbit/s
0011	256 kbit/s
0100	320 kbit/s
0101	384 kbit/s
0110	768 kbit/s
0111	1152 kbit/s
1000	1536 kbit/s
1001	¼ of previous layer
1010	½ of previous layer
1011	Same as previous layer
1100	3/2 of previous layer
1101	Unrestricted
1110-1111	Forbidden

If more than one of the following bits (bits 5-8) is 1, any of the indicated enhancement layer types may be sent, but the encoder shall not change enhancement layer types within a single stream.

If  $\text{spatialScalable1D}$  ( $\text{enhancementLayerInfo}$  bit 5) is 1, then the enhancement layer may be a spatial scalable layer of one dimension. Note that the picture header of H.263 shall specify if the scalability is in vertical direction or in horizontal direction.

If  $\text{spatialScalable2D}$  ( $\text{enhancementLayerInfo}$  bit 6) is 1, then the enhancement layer may be a spatial scalable layer in both horizontal and vertical dimensions.

If  $\text{snrScalable}$  ( $\text{enhancementLayerInfo}$  bit 7) is 1, then the enhancement layer may be snr scalable.

If  $\text{temporalScalable}$  ( $\text{enhancementLayerInfo}$  bit 8) is 1, then the enhancement layer may be temporal scalable with one B picture.

### 5.2.4.5 Examples

Following are some examples of valid H.263 capabilities including the additional capabilities. These have been obtained from extending the examples in clause 5.2.4.3.

- {start-MBE/4/<H.262/H.263>/H.263\_4CIF + MPI\_2/extension codeword/H.263 4CIF + H.263 Profiles level 1 supported}

Additional H.263 capabilities bytes are: additionalH.263CapByte.

- {start-MBE/13/<H.262/H.263>/H.263\_4CIF + MPI\_4/H.263\_CIF + MPI\_3/H.263\_QCIF/SQCIF + MPI\_2/extension codeword/ H.263\_4CIF + No additional H.263 capabilities/H.263 CIF + deblock filter/H.263 QCIF/SQCIF/deblock filter + improved PB frames}

Additional H.263 capability bytes are: additionalH.263CapByte/additionalH.263CapByte/  
individualOptionsIndicatorByte/optionByte1/additionalH.263CapByte/  
individualOptionsIndicatorByte/optionByte1/optionByte2

- {start-MBE/14/<H.262/H.263>/H.263\_4CIF + MPI\_4 + Options/AC/H.263\_CIF + MPI\_3 + Options/AC + PB/H.263\_QCIF/SQCIF + MPI\_2 + Options/AC + PB + UMV/extension codeword/H.263\_4CIF + No additional H.263 capabilities/H.263 @ [176..528] × [144..432] + No additional H.263 capabilities}

Additional H.263 capability bytes are: additionalH.263CapByte/additionalH.263CapByte/  
minCustomPictureHeight/minCustomPictureWidth/maxCustomPictureHeight/  
maxCustomPictureWidth.

- {start-MBE/12/<H.262/H.263>/H.263\_4CIF + MPI\_4 + Options/UMV + AMP/H.263\_CIF + MPI\_3 + Options/UMV + AMP + AC + define BPPmaxKB/BBPmaxKB × 4/H.263\_QCIF/SQCIF + MPI\_2 + Options/UMV + AMP + AC + PB/extension codeword/H.263\_4CIF + Custom PCF 25 Hz + No Options}

Additional H.263 capability bytes are additional H.263CapByte/customPCFByte1/  
customPCFByte2.

### 5.2.4.6 Second additional H.263 capabilities

The second additional H.263 capabilities are specified using a variable number of enhancement bytes from the bytes described in this clause. The bytes shall be transmitted in the order described in this clause.

The second additional H.263 capabilities and second extension codeword 01111111 shall not be transmitted unless the "H.263(2000)" capability has been previously received from the far-end terminal, indicating support of the second additional H.263 capabilities described in this clause.

The leading H.263 enhancement byte, secondAdditionalH.263CapByte, shall be transmitted for all formats larger than or equal to the smallest format for which distinct H.263 second additional capabilities are declared. The secondAdditionalH.263CapByte is structured as shown in Table 41.

**Table 41 – Second additional H.263 capabilities byte**

Bit	Name	Value	Description
1-2	inherit/enhancedReferencePicSelect	00	Inherit second additional options from immediately larger format
		01	Not capable of using enhancedReferencePicSelect
		10	Capable of using enhancedReferencePicSelect without sub-picture removal
		11	Capable of using enhancedReferencePicSelect with sub-picture removal
3	Forbidden	0	Set to 0 to avoid emulation of extension codeword
4	dataPartitionedSlices	0	Not capable of using dataPartitionedSlices
		1	Capable of using dataPartitionedSlices
5	fixedPointIDCT0	0	Not capable of using FixedPointIDCT0
		1	Capable of using FixedPointIDCT0
6	interlacedFields	0	Not capable of using interlacedFields
		1	Capable of using interlacedFields
7	currentPictureHeaderRepetition	0	Not capable of using currentPictureHeaderRepetition
		1	Capable of using currentPictureHeaderRepetition
8	secondOptionExtByteFlag	0	secondOptionExtByte does not follow
		1	secondOptionExtByte follows

inherit/enhancedReferencePicSelect, when 00, indicates inheritance of the H.263 second additional options signalled for the immediately larger video format. In this case, the remainder of the Second Additional H.263 Capabilities Byte shall be set to 0.

inherit/enhancedReferencePicSelect, when 01, indicates that the decoder cannot use Annex U of [ITU-T H.263] Enhanced reference picture selection mode.

inherit/enhancedReferencePicSelect, when 10, indicates the capability of the decoder to use Annex U of [ITU-T H.263] Enhanced Reference Picture Selection mode without sub-picture removal. It also indicates the capability of an encoder to receive and respond to the three new messages: lostPicture, lostPartialPicture, and recoveryReferencePicture.

inherit/enhancedReferencePicSelect, when 11, indicates the capability of the decoder to use Annex U of [ITU-T H.263] Enhanced Reference Picture Selection mode with sub-picture removal. In this case, mpuHorizMBs, mpuVertMBs, and mpuTotalNumber values shall follow the second additional H.263 capabilities byte or, if present, the second additional H.263 extensions capabilities byte, as specified respectively in Tables 43, 44, 45, 46, and 47. It also indicates the capability of an encoder to receive and respond to the three new messages: lostPicture, lostPartialPicture, and recoveryReferencePicture.

dataPartitionedSlices, when 1, indicates the capability of a decoder to support the Data Partitioned Slice mode defined in Annex V of [ITU-T H.263]. dataPartitionedSlices shall be 0 if slicesInOrder-NonRect and slicesInOrder-Rect and slicesNoOrder-NonRect and slicesNoOrder-Rect are all 0 in the same H263Options message.

fixedPointIDCT0, when 1, indicates the capability of a decoder to support Reference IDCT0 defined in Annex W of [ITU-T H.263].

interlacedFields, when 1, indicates the capability of a decoder to support interlaced field coding as defined in Annex W of [ITU-T H.263].

currentPictureHeaderRepetition, when 1, indicates the capability of a decoder to support repetition of the current picture header as defined in Annex W of [ITU-T H.263].

secondOptionExtByteFlag, when 1, indicates the presence of an extension byte immediately following the second additional H.263 capabilities byte, as specified in Table 42.

**Table 42 – Second additional H.263 extensions capabilities byte**

Bit	Name	Value	Description
1	previousPictureHeaderRepetition	0	Not capable of using previousPictureHeaderRepetition
		1	Capable of using previousPictureHeaderRepetition
2	NextPictureHeaderRepetition	0	Not capable of using nextPictureHeaderRepetition
		1	Capable of using nextPictureHeaderRepetition
3	Forbidden	0	Set to 0 to avoid emulation of extension codeword
4	PictureNumber	0	Not capable of using pictureNumber
		1	Capable of using pictureNumber
5	SpareReferencePictures	0	Not capable of using spareReferencePictures
		1	Capable of using spareReferencePictures
6-8	Reserved	0	Reserved for future use

previousPictureHeaderRepetition, when 1, indicates the capability of a decoder to support repetition of the previous picture header as defined in Annex W of [ITU-T H.263].

nextPictureHeaderRepetition, when 1, indicates the capability of a decoder to support repetition of the next picture header (with or without a reliable temporal reference indication) as defined in Annex W of [ITU-T H.263].

currentPictureHeaderRepetition, previousPictureHeaderRepetition, and nextPictureHeaderRepetition, when 1, and when part of receiver capabilities, indicate that a decoder can recover from a picture header corruption or loss by replacing the corrupted or lost picture header with a picture header transmitted according to Annex W of [ITU-T H.263].

pictureNumber, when 1, indicates the capability of a decoder to detect reference picture losses from transmitted picture numbers according to Annex W of [ITU-T H.263]. It also indicates the capability of an encoder to receive and respond to the three new messages: lostPicture, lostPartialPicture, and recoveryReferencePicture.

spareReferencePictures, when 1, indicates the capability of a decoder to use a spare reference picture if it lacks the actual reference picture as defined in Annex W of [ITU-T H.263].

**Table 43 – MPU horizontal size in macroblocks  
(16 luminance samples)**

Bit	Description
00000000	Forbidden
00000001-10000000	Valid mpuHorizMBs
10000001-11111111	Forbidden

mpuHorizMBs indicates the horizontal size, in units of 16 luminance samples, of the minimum picture unit for sub-picture removal using Annex U of [ITU-T H.263].

**Table 44 – MPU vertical size in macroblocks  
(16 luminance samples)**

Bit	Description
00000000	Forbidden
00000001-01001000	Valid mpuVertMBs
01001001-11111111	Forbidden

mpuVertMBs indicates the vertical size, in units of 16 luminance samples, of the minimum picture unit for sub-picture removal using Annex U of [ITU-T H.263].

mpuTotalNumber indicates the total memory, in MPUs, available at the decoder for use in buffering reference frames when using Annex U of [ITU-T H.263] Enhanced Reference Picture Selection Mode, including that memory which would be assumed for a normal decoder. mpuTotalNumber is transmitted using two or three bytes, mpuTotalByte1 and mpuTotalByte2 and optionally mpuTotalByte3 as specified respectively in Tables 45, 46, and 47.

mpuTotalNumber shall take a value between 1 and 65536. mpuTotalNumber is calculated by concatenating mpuTotalBits1, mpuTotalBits2 and mpuTotalBits3 if present, making a 14- or 28-bit word with mpuTotalBits1 as MSB.

**Table 45 – mpuTotalByte1**

Bit	Description
1	thirdByteIndicator
2-8	mpuTotalBits1

thirdByteIndicator, when 1, indicates the presence of mpuTotalByte3 immediately following mpuTotalByte2. mpuTotalByte3 shall be present if mpuTotalNumber is larger than 16383.

**Table 46 – mpuTotalByte2**

Bit	Description
1	Set to 0
2-8	mpuTotalBits2

**Table 47 – mpuTotalByte3**

Bit	Description
1	Set to 0
2-8	mpuTotalBits3

mpuTotalByte3 is only present if thirdByteIndicator is 1.

### 5.2.5 H.264 capabilities MBE message format

The H.264 capabilities are defined in [ITU-T H.241], and the capability exchange is handled by an MBE message (see clause 2.2.3 of [ITU-T H.230]). This MBE message uses the type identification byte <H.264> (see Table 2 of [ITU-T H.230]). A terminal shall signal the H.264 capability by including within its capset the message:

{ Start-MBE / N / <H.264> / B1 / ... / BN – 1 }

### 5.3 Transfer rate capabilities

Transfer rate capabilities are defined in [ITU-T H.221].

The capability to receive a given number of multiple 64 kbit/s channels includes the capability to receive fewer 64 kbit/s channels. Similarly, the capability to receive a given number of  $H_0$  channels includes the capability to receive fewer  $H_0$  channels. In both cases, the receiving terminal will synchronize the connected additional channels to the initial channel and maintain that synchronism throughout the period of connection.

All other ranges of capability shall be signalled by inclusion in the capability set of more than one transfer rate capability code. For example, a terminal may list its transfer rate capabilities as {2B and  $H_0$  and  $H_{11}$  and  $H_{12}$ }; in this case, 1B capability is also implied.

No transfer rate capability value shall be transmitted which exceeds the limit imposed by the physical connection to the network; for example, a terminal on an  $H_0$  access shall not declare  $H_{12}$  capability.

### 5.4 Data capabilities

Data capabilities are defined in [ITU-T H.221]. Except for MLP\_Set1, MLP\_Set2 and the variable-rate codes, each capability conveys only the stated data rate.

If a terminal is able to accept more than one data rate of whatever type (LSD, HSD, MLP, H-MLP), then BAS codes covering all relevant values shall be included in the capability set.

### 5.5 Terminals on restricted networks: capability

A terminal connected to a network whose B-channels are effectively restricted to  $p \times 56$  kbit/s ( $p = 1$  to 24), or whose channels at  $H_0$  or higher are restricted by ones-density considerations, as well as terminals intended for interworking with terminals on restricted networks, shall conform to clause 13.

### 5.6 Encryption and extension-BAS capabilities

The capabilities are defined in [ITU-T H.221].

### 5.7 Null capability

This capability is transmitted only by a channel aggregation unit [ITU-T H.244]; it shall not be transmitted by a terminal.

## 6 Transmission

### 6.1 Transmission modes

Audio modes of operation are defined in Annex A of [ITU-T H.221] audio commands.

For analogue telephone terminals, it may be assumed that the speech signal is converted to G.711 encoding at a digital network interface. These terminals are viewed as working in Mode 0U when connected to wideband speech terminals.

The video transmission is governed by the H.26x-on<sup>1</sup>, video-MPEG-1-on and video-off commands. When switched on, the video signal occupies all of the capacity, both in the initial channel and in any additional channels, which is not specifically allocated to other signals by other commands. Thus, different video bit rates result from audio, transfer-rate, ECS and data commands, the

---

<sup>1</sup> "H.26x" means any BAS code defined to command the use of a Recommendation of the H.260-series.

resultant video bit rate being: {transfer rate, less audio rate, less data rate if present, less encryption control channel if present, less FAS and BAS in all the channels/time-slots where they are present}.

The video channel may be operated in an asymmetrical mode of operation, unless an MMS command is received from the other side. In the asymmetrical mode of operation, the two terminals may send their video in a different mode from each other. As an example, one terminal may be sending video encoded by H.263 while the other terminal is sending video encoded by H.262. If a terminal receives the MMS command from the remote side, it shall immediately begin encoding its video in the same manner as the remote side. If a terminal receives the cancel-MMS command, it may begin sending in an asymmetrical manner.

Transfer-rate modes are defined in [ITU-T H.221], and specify the total capacity of the communication effective in the sub-multiframe following the BAS command.

Data modes are defined in [ITU-T H.221], and specify only the bit rate and bit positions used for a user data signal. The protocol used for data applications is defined by the terminals, but see also clause 12.

## 6.2 Establishment of compatible modes of operation

At the beginning of the communication phase of a call, all terminals start to work in Mode 0F (outgoing signal framed). Terminals other than those limited to G.711 capability will then begin an initialization procedure.

This procedure (further described in clause 9) consists of:

- the transmission of information concerning the capabilities of the respective terminals for receiving and decoding audio, video, transfer rate, data rates and other capabilities;
- the determination of a suitable transmission mode, consistent with the known capabilities of both terminals. An example is given in clause IV.1, in which the transmission mode is the same in both directions, but the H.242 procedures are equally applicable to systems in which asymmetric bidirectional communication is optimal (examples are surveillance (see clause IV.2) and retrieval services);
- switching to this mode, and establishing additional channels, if relevant.

The terminals connected to a call may change during the call. This may require reinitialization in order to identify the terminal type and to re-establish the desired mode of operation. In particular, this feature is used in Mode 0 forcing, which is necessary in the case of a call transfer (see clause 11).

## 7 Frame structure

The frame structure described in [ITU-T H.221] is used for mode initialization and dynamic mode switching (see the following clauses) and more generally to define the multiplex of the various bit streams (audio, video, data, encryption control signal, frame structure) within the frame.

[ITU-T H.221] defines a bit-rate allocation signal (BAS) which is used *inter alia* to allocate sub-channels and to indicate the coding algorithm(s).

BAS codes are classified by the value of the first three bits which represent the BAS attribute: each attribute may therefore have up to 32 defined values.

Four BAS attributes are commands: they define the multiplex within the next and following sub-multiframes, as well as audio coding algorithm, and therefore command the distant receiver to treat the signals accordingly. The use of commands must be constrained as set out in clause 15 (see Table 53).

Further BAS attributes are defined to signal terminal capabilities to the distant terminal. When received, these attributes do not directly affect the current transmission mode. However, they may lead to the initiation of a specific action to be carried out by the terminal. This feature is utilized in the mode initialization procedure and in the Mode 0 forcing procedure (see clause 9.3).

The third bit of the H.221 frame alignment signal (FAS) in odd frames of the initial channel, called the A-bit, is set to 1 on loss of frame or multiframe alignment, and is set to 0 on acquiring both frame and multiframe alignment (see Note). Consequently, a terminal which is receiving a framed signal with the A-bit set to 0 can assume that the distant terminal is able to act upon a change of BAS.

NOTE – A terminal having capabilities only for single-channel working, and without encryption capability, does not need to seek and gain multiframe alignment since the latter serves for numbering and synchronizing multiple channels.

## **8 Basic sequences for in-channel procedures**

Three signalling sequences are defined in this clause. These sequences are used as the building blocks for the procedures defined in clauses 9 and 10.

### **8.1 Capability exchange sequence A**

In sequence A, each terminal sends its own capability set as prescribed in this clause. It is forbidden to change the capability set during sequence A, and there shall be no commands or any other BAS codes interposed between repetitions of the capability set.

#### **8.1.1 Sequence A at the start of a call**

At the start of a call (see clause 9.1.1) both terminals (designated here X and Y) shall set timer T1 (minimum value 10 seconds) and each shall begin transmitting its own capability set repetitively, including Cap-mark as appropriate, continuing to do so until the end of sequence A (see clause 8.1.3 below).

#### **8.1.2 Sequence A during a call**

The arrangements of this clause are effective for both normal and neutral capability exchanges.

At any time during a call, the terminal can initiate sequence A, which may include a capability set different from the one used at the call set-up for changing communication modes (e.g., from Mode  $a_0$  to Mode  $b_0$ , from Mode  $b_1$  to Mode  $a_2$  as per [ITU-T H.320]). When a terminal has received such a capability set of the remote terminal during the call, it shall respond by sending its own capability set, but the set need not be changed in response to the remote terminal's new capability.

When a terminal activates sequence A during a call, it shall maintain the current mode of multimedia multiplexing, including FAS and BAS in additional channels if relevant. For example, if transmitted video is ON, it shall not be switched off immediately prior to sending a capability set unless explicitly required for a fault recovery procedure.

Oscillation of the capability exchange can be avoided by the arrangements to identify the end of sequence A as given below.

The capability exchange sequence forces framing in both directions of transmission and the exchange of terminal capability codes. Either terminal may initiate the sequence and there is no problem caused by both doing so simultaneously or nearly simultaneously. Capability BAS shall not be sent unnecessarily when the incoming signal is unframed. A terminal capable of communicating on a single channel with a channel aggregator conforming to [ITU-T H.244], receiving the command [capex] shall immediately initiate this sequence A, unless a capability exchange is already in progress: in the latter case, the terminal shall continue the sequence, ensuring that at least one complete capability set is transmitted after receipt of [capex].



A terminal X which initiates a capability exchange sequence shall first reinstate framing by using sequence C (see clause 8.3) if previously transmitting unframed; it then shall set a timer T1 (minimum value 10 seconds) and transmit its current capability set (see clause 5) repetitively, including Cap-mark as appropriate, or at least one complete set followed by the marker code (to indicate completion of the set); these capabilities will be one or more of the set listed in Table 52.

When Y first detects any incoming capability code except neutral (see clause 8.3), it shall begin transmission of its own set of capability codes. This, of course, requires switching to a framed mode if transmission had been unframed. To ensure that each receives the complete set of capabilities of the other, they shall continue repetitive transmission of capsets beyond the time they detect incoming A = 0 by at least one complete set and the marker code, and during this time the transmission of commands or any other BAS codes is prohibited.

### **8.1.3 Identification of the end of sequence A**

The end of sequence A is identified by Terminals X and Y as follows.

#### **8.1.3.1 Terminal activating sequence A**

This applies to both terminals during initialization (see clause 9.1.1), and to Terminal X for other exchanges.

The terminal sends capability sets until both the following conditions are met:

- i) one complete set has been transmitted since receiving A = 0;
- ii) it detects an incoming cap-mark followed by at least one normal capability code (to await a full capset is better as it increases robustness).

It then completes transmission of the current set (since partial capsets are not allowed) followed by cap-mark and at least one command from Table A.1 of [ITU-T H.221] (see clause Note 1).

It identifies the end of sequence A when it receives a command following the capability sets from the remote terminal Y. If sequence A is not completed within T1 seconds, the sequence must be terminated, a command from Table A.1 of [ITU-T H.221] (see Note 1) sent, and then a new sequence started (see Note 2).

At any time after the end of sequence A, the terminal shall respond to reception of a capability set by returning its own capability set.

NOTE 1 – If it is desired to send an SBE command, for example from Table A.2 of [ITU-T H.221], it shall be preceded by a Table A.1 of [ITU-T H.221] command such as (000)[0].

NOTE 2 – If i) above has been completed and yet the incoming signal continues to contain only capsets, and if no commands are received for a further two seconds, it may be advantageous to terminate the sequence at that point, send a command, and then recommence sequence A.

#### **8.1.3.2 Terminal Y responding to the reception of capability code**

Terminal Y responds by returning its own capability set until at least a complete set is transmitted after having received A = 0. Then it starts to send commands. The end of sequence A is identified by receiving a command from the remote terminal X.

At any time after the end of sequence A, the terminal Y shall respond to reception of a capability set by returning its own capability set.

#### **8.1.3.3 Possible outcomes**

There are three possible outcomes:

- Outcome I: Within the timer expiration period, multiframe alignment has been gained, the A-bit is received with a value of zero and the complete set of capability BAS codes of the distant terminal has been validated. In this case, the sequence is completed successfully.

NOTE 1 – If sequence A is initiated while incoming A = 0, repetition of the set is not necessary.

- Outcome II: The timer has expired without the terminal finding the incoming multiframe alignment. In this case, the sequence failed.

NOTE 2 – This is the expected case of connection to a PCM telephony terminal, so the communication will be audio only.

- Outcome III: The timer has expired with multiframe alignment achieved, but without either the validation of the A-bit as 0 or the receiving of the complete set of the distant terminal's capability BAS codes (or both). In this case, the sequence is restarted. Outcome III should be notified to the user as a potential fault condition (which might, however, be in the remote terminal). See Figure 1.

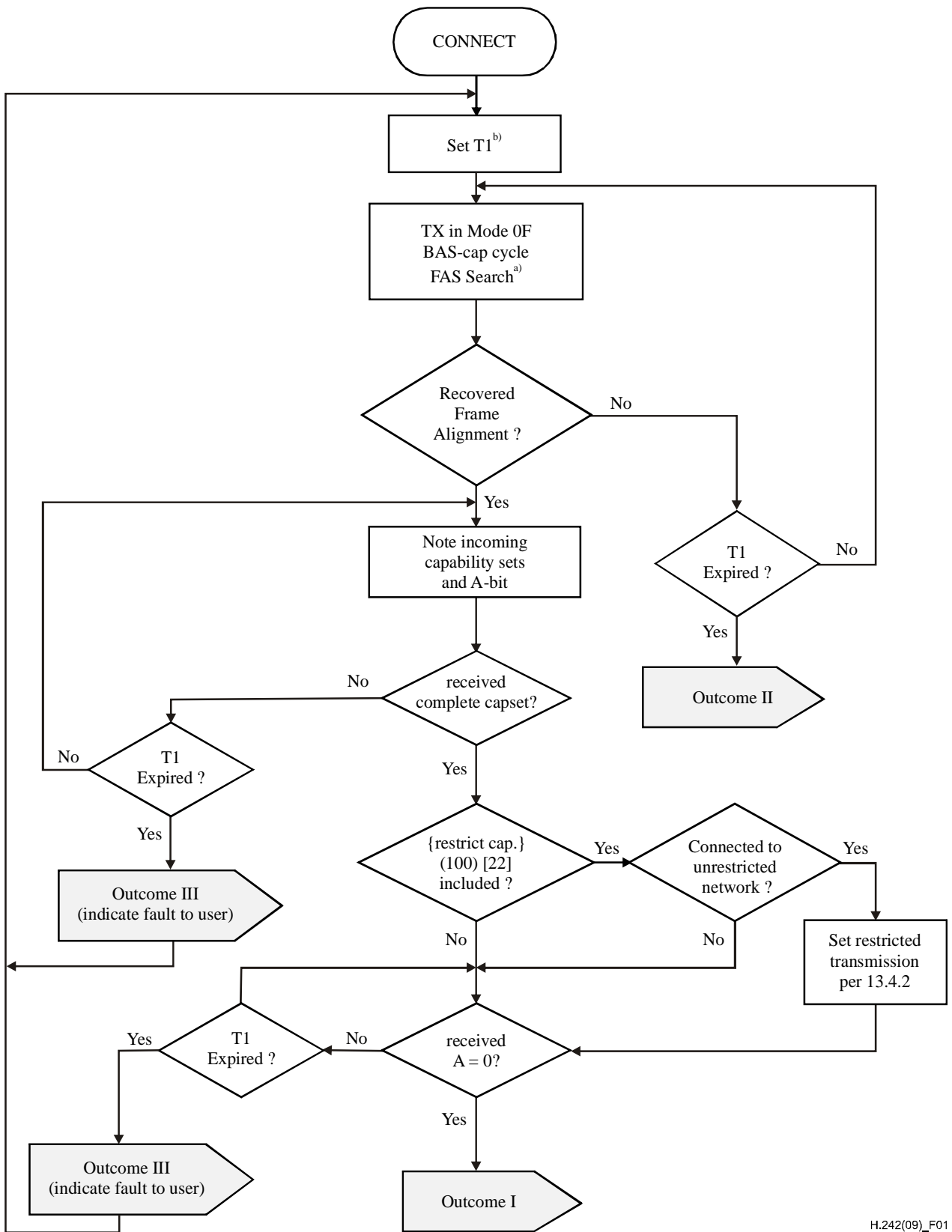

H.242(09)\_F01

<sup>a)</sup> FAS should at this point be sought throughout the incoming signal.

<sup>b)</sup> The terminal should mute the loudspeaker(s) until the encoding law of the audio received from the remote terminal has been determined.

**Figure 1 – Initial capability exchange – General case**

## 8.2 Mode switching sequence B

Mode switching is performed using BAS command codes, each being effective from the beginning of the even frame following the sub-multiframe in which the code is first transmitted. Mode switching is possible at any time during a communication, after the initialization procedure has been completed.

When the transmitting terminal signals the mode of operation, this is valid from the next sub-multiframe. It is essential to note that transmitted signals shall always be in accordance with the known capabilities of the remote terminal to receive and decode; in the absence of such knowledge, only Mode 0F or 0U (audio to [b-ITU-T G.711]) shall be sent. If a change of capability, indicated in performing sequence A, has the result that the current mode is no longer receivable/decodable, there shall be a switch as soon as possible after the end of sequence A to a mode which can be received and decoded.

BAS commands which exceed the current transmission capacity shall not be transmitted (e.g., transmission of 2B transfer rate command before the second channel is established).

The receiving terminal decodes and validates the BAS code, and switches its receive mode of operation accordingly. If for any reason a terminal receives a BAS command it cannot obey, a mode mismatch may result (see clause 9.3).

In addition to switching of the audio mode, mode switching includes turning video off or on, or changing the video algorithm; the adoption/cessation of use of additional channels; the opening/closing of the encryption control channel; the opening/closing of a data channel.

The mode switching is, in principle, performed independently for the two transmission directions; some applications may be fundamentally asymmetric (see Note). Symmetry is *not* mandatory according to this Recommendation. It is possible for a terminal to choose symmetrical operation from within its application software without further recourse to standards. However, it is unwise to incorporate a mechanism in a terminal which automatically sets the outgoing mode to be the same as the incoming mode: there is a risk that two terminals programmed in this way might oscillate between two modes, or remain in Mode 0. It is better practice to select the transmitted mode in one of the following ways:

- a) according to the received capability set (for example, as set out in Table 3 of [ITU-T H.320]);
- b) user selection, within the received capability set but perhaps overriding automatic selection a;
- c) according to mode-preference codes received from the remote end (see clause 9.5).

NOTE – See Appendix IV for some examples of symmetrical and asymmetrical transmission modes.

## 8.3 Frame reinstatement sequence C

If terminal A is transmitting unframed but receiving framed, frame reinstatement consists of the insertion of FAS and BAS into the first 16 bits of the service channel, waiting up to T1 seconds for incoming A = 0; the overlaid frame can contain neutral BAS capability to avoid triggering a full capacity exchange.

Neutral capability (100)[0] shall always be enclosed between BAS capability markers. It should be noted that the neutral-cap shall never be included in a capability set.

Terminal A which is receiving unframed may wish the remote terminal B to reinstate framing: to do this, A shall first itself reinstate framing if it is not already transmitting framed and then begin sequence A (see Note); B shall respond by reinstating framing in order to return its own capability set and A = 0 according to clause 8.1.

NOTE – Alternatively, neutral BAS capability may be sent; B then responds with either its own capability set or neutral capability.

## **9 Mode initialization, dynamic mode switching and Mode 0 forcing**

Audiovisual terminals will be connected to digital networks where other kinds of terminals will also be connected: G.711 terminals but also data terminals, telematic terminals, servers, etc. When compatibility between the different services involving those terminals is required, an initialization procedure is necessary.

When automatic compatibility is required, a procedure based on the sequences defined in clause 8 is used.

For call transfer or mode mismatch recovery, it is necessary for terminals to operate in the common Mode 0F and a Mode 0 forcing procedure is required, again based on the sequences defined in clause 8.

At the commencement of the call, after call transfer and after the procedure of clause 9.3, there is a need for an initialization procedure to ensure that the two connected terminals can operate in the most suitable common mode.

### **9.1 Mode initialization procedure**

#### **9.1.1 Single channel**

##### **9.1.1.1 Procedure**

The initialization procedure begins as soon as a connection message is received from the network, or any indication meaning that the physical connection is established.

At the beginning of mode initialization, the terminal shall transmit in Mode 0F, and may (see Note) send the commands [1B][A- or  $\mu$ -law][restrict (if appropriate)] repetitively for  $450 \pm 50$  ms. The receive part of the terminal shall be in frame search and the audio decoding in Mode 0F(A/ $\mu$ ).

NOTE – Although not mandatory, this transmission of commands is strongly recommended, to give the earliest possible indication of the G.711 law in use, as well as the [restrict] condition when applicable. Receiving terminals should take the repetition of the above commands as definitive, rather than a single value.

Sequence A shall be started within 500 ms of establishment of the connection.

Upon completion of sequence A according to Outcome I (see Figure 1), sequence B shall commence. The BAS code which is sent in sequence B is calculated from the knowledge of the capabilities of the local and distant terminals and is used to switch to a suitable working mode. This process may involve terminal procedures effecting choices made by the user or preset in the terminal (see clause 8.2). An example illustrating conformance to a defined teleservice is given in [ITU-T H.320].

In the event of Outcome II, the terminal will switch its transmission and reception to Mode 0U. The receive part of the terminal shall remain in frame search throughout the call.

In the event of Outcome III, timer T1 is reset and the terminal remains within sequence A.

The initialization procedure is completed when both terminals have switched to the desired working mode(s).

### 9.1.1.2 Audio encoding

At the beginning of the call, the G.711 encoding by each terminal shall be according to the law prevailing in its own region, unless there is prior information that the remote terminal cannot decode this, in which case it shall transmit the other law. The outgoing audio should not normally be muted if the users expect immediate conversation as in normal telephony.

If the incoming signal is unframed and statistical analysis (e.g., Appendix X) indicates that the other law is being received, and furthermore the incoming law has not changed since the start of the call, then the terminal should switch its transmission to that law, on the basis that the remote endpoint supports telephony only and so can decode only the law it transmits.

In the case where both terminals transmit framed signals, once the capability exchange is completed and this confirms that they can decode to both laws, they may transmit in either PCM mode if desired.

### 9.1.1.3 Audio decoding and presentation

Until the audio encoding law in use by the remote terminal is known, the loudspeaker should be muted to avoid inconvenience to the users.

The decoder shall adapt to the coding law of the incoming signals. In a framed signal this will be clear when the BAS command (000) [18 or 19] is received (see Note 1); for unframed audio, and for framed audio before the BAS command is received, the result of statistical analysis should be applied if available (see Note 2). In the absence of both command and statistical indication, local knowledge may be used or the loudspeaker should remain muted.

NOTE 1 – The position of any stuffing bits must also be known, though this is usually the case.

NOTE 2 – Not only must the analyser itself be available, but the test cannot start before the audio structure is known, which involves some or all of network timing, FAW and stuffing bits. It is highly recommended that terminals incorporate a method such as that of Appendix X.

## 9.1.2 Additional channels

A possibility of adding more channels is established from the capability exchange sequence. The calling terminal may then immediately begin establishing the additional connections. When each is established, it transmits only FAS and BAS on that channel, setting a timer  $T_a$  of minimum value 10 seconds. Synchronization with the initial channel is performed according to clause 2.7 of [ITU-T H.221]. When the incoming A-bits on additional channels are observed to be 0, mode switching to occupy sequentially numbered channels is initiated by an appropriate transfer-rate command BAS. If the timer  $T_a$  has expired without receiving  $A = 0$ , it is dealt with as a fault condition.

If the buffering process involves the insertion of additional delay in the *initial* channel, which is already carrying encoded user information (speech, video, data), it is necessary to make provision for this interruption. In particular, disagreeable noises from loudspeakers should be avoided, by muting (as briefly as possible) or otherwise. To minimize the recovery of a G.728 decoder, it should be frozen while the delay insertion has been completed. During this frozen period, the zero-valued samples should be played out from the speech decoder, but the internal state of the G.728 decoder should not be changed, so that it can immediately resume decoding when delay insertion has been completed. Note that in some implementations, the encoder of the terminal may be reset at the same time.

As additional channels achieve synchronization, they are sequentially numbered using both FAS and BAS numbering as provided in [ITU-T H.221]. Subsequent mode switching is specified in clause 9.2.1.

An example of mode initialization on two channels is given in Appendix I.

## **9.2 Dynamic mode switching (see Figure 2)**

The mode switching procedure makes use of the frame structure specified in clause 7 and of the sequences defined in clause 8. It should be noted that all terminal receivers shall remain in frame search throughout the call.

When the terminal is receiving in a framed mode, that is, it is capable of decoding bit A, mode switching should be delayed if the A-bit is set to 1; frame reinstatement and mode mismatch recovery procedures should be followed as necessary.

The procedure depicted in Figure 2 should be followed.

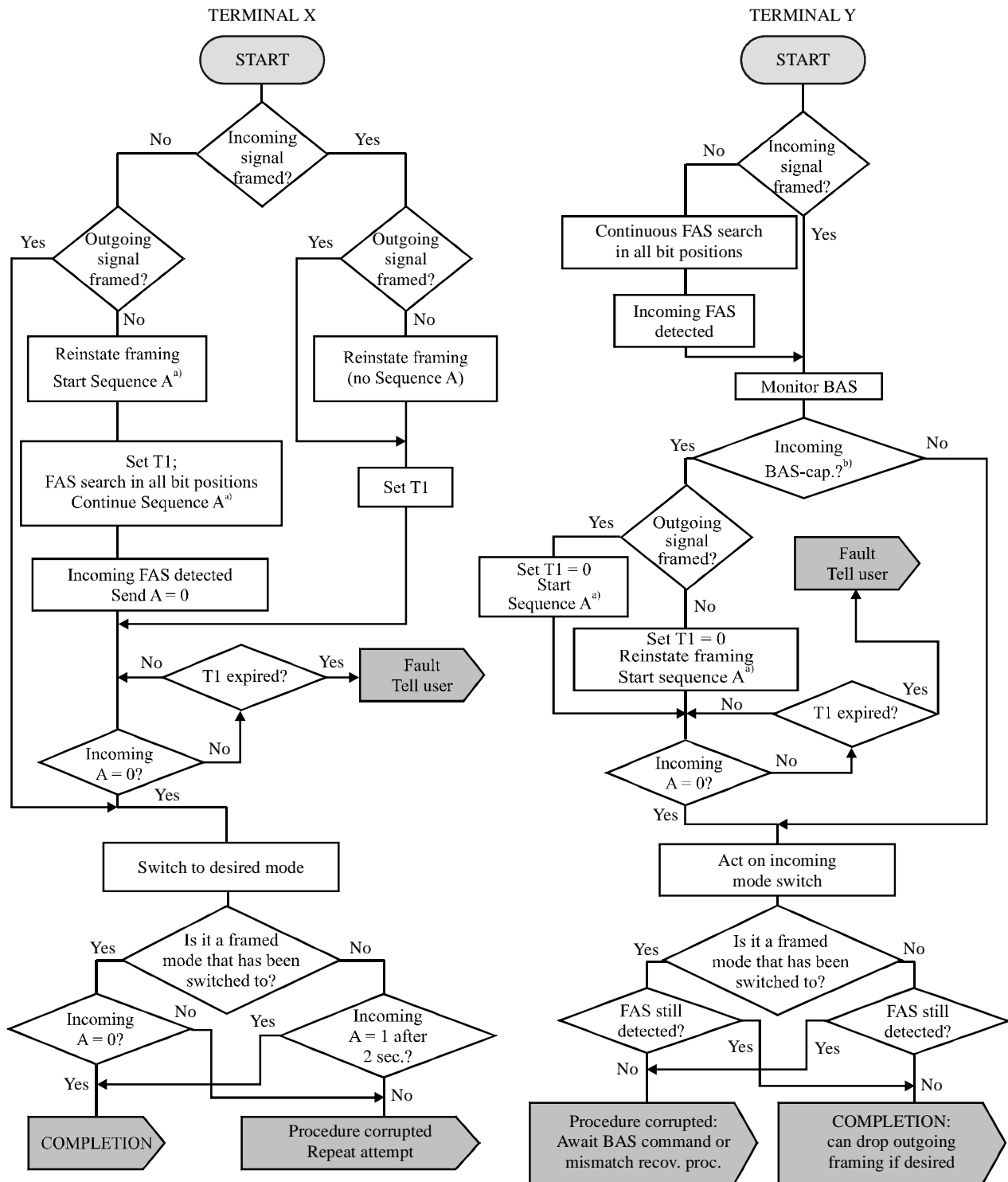

H.242(09)\_F02

a) Normal capability set or neutral may be used.  
 b) Incoming BAS-cap outgoing frame reinstatement.

**Figure 2 – Mode switching – Terminal X initiates the mode**



### **9.2.1 Dynamic mode switching from a framed mode to another framed mode**

The basic sequence mode switching described in clause 8.2 is used.

At the transmitting terminal, if a BAS command is transmitted to signal a new mode, the transmitter shall operate in the appropriate mode from the first octet of the next sub-multiframe.

Similarly, at the receiving terminal, if the received BAS signals a new mode, the receiver shall operate in the appropriate mode from the first octet of the next sub-multiframe.

### **9.2.2 Dynamic mode switching from a framed mode to an unframed mode**

Unframed modes are less robust, and so should be avoided if possible. The main use of unframed audio-on or audio-off modes is at the end of a multimedia session, to avoid causing the "unexpected loss of frame alignment" condition (clause 10.1) at the remote end.

As in clause 9.2.1, the basic sequence mode switching described in clause 8.2 is used.

However, as the BAS for signalling an unframed mode is transmitted for a single sub-multiframe, a mode mismatch may occur in drastic error conditions. Optionally, a method may be used to improve the reliability of the switching: the new BAS value is repeated three times; this will cause a temporary corruption (no more than 40 ms) of the least significant bit of the received information.

### **9.2.3 Dynamic mode switching from an unframed mode to another mode (framed or unframed)**

The basic sequences frame reinstatement and mode switching are sequentially transmitted, the former including capability exchange if necessary (see Figure 2).

### **9.2.4 Dynamic mode switching involving change of active additional channels**

Since the HSD channel is defined as occupying the highest numbered additional channel(s), a change of transfer rate (such as is necessary when activating or deactivating additional channels) would cause a displacement of the data stream within the aggregated frames. Therefore, HSD shall be turned OFF prior to such a transfer rate change, and ON again subsequently (see also clause 15).

## **9.3 Mode 0 forcing procedure**

See Figure 3.

Mode 0 forcing may be activated at any time during the call; receipt of a Mode 0 forcing sequence should not be interpreted as an indication of impending termination of the call. Since Mode 0 forcing comprises sequence B (mode switching) followed by sequence A (capability exchange), the forced terminal may not recognize "forcing", but shall respond to the capability exchange first by returning its ordinary capability set and then reduced commands corresponding to the capability set of the forcing terminal.

Certain terminal designs may include recognition of "being forced", thus returning reduced commands first and then responding to the capability exchange.

If 1B transfer rate is included in the capability set of the forcing terminal, the contents of the additional channel(s) are not concerned; they may include only FAS and BAS with any bits in other bit positions, or may even become vacant without FAS and BAS.

NOTE – Removal of FAS and BAS from additional channels may cause some terminals to drop those channels.

After Mode 0 forcing is activated and both terminals start to operate at the intended forcing mode, re-activation of sequence A for ordinary capability exchange, activation of additional channel(s), disconnection, or other mode changes may take place according to the terminal procedure.

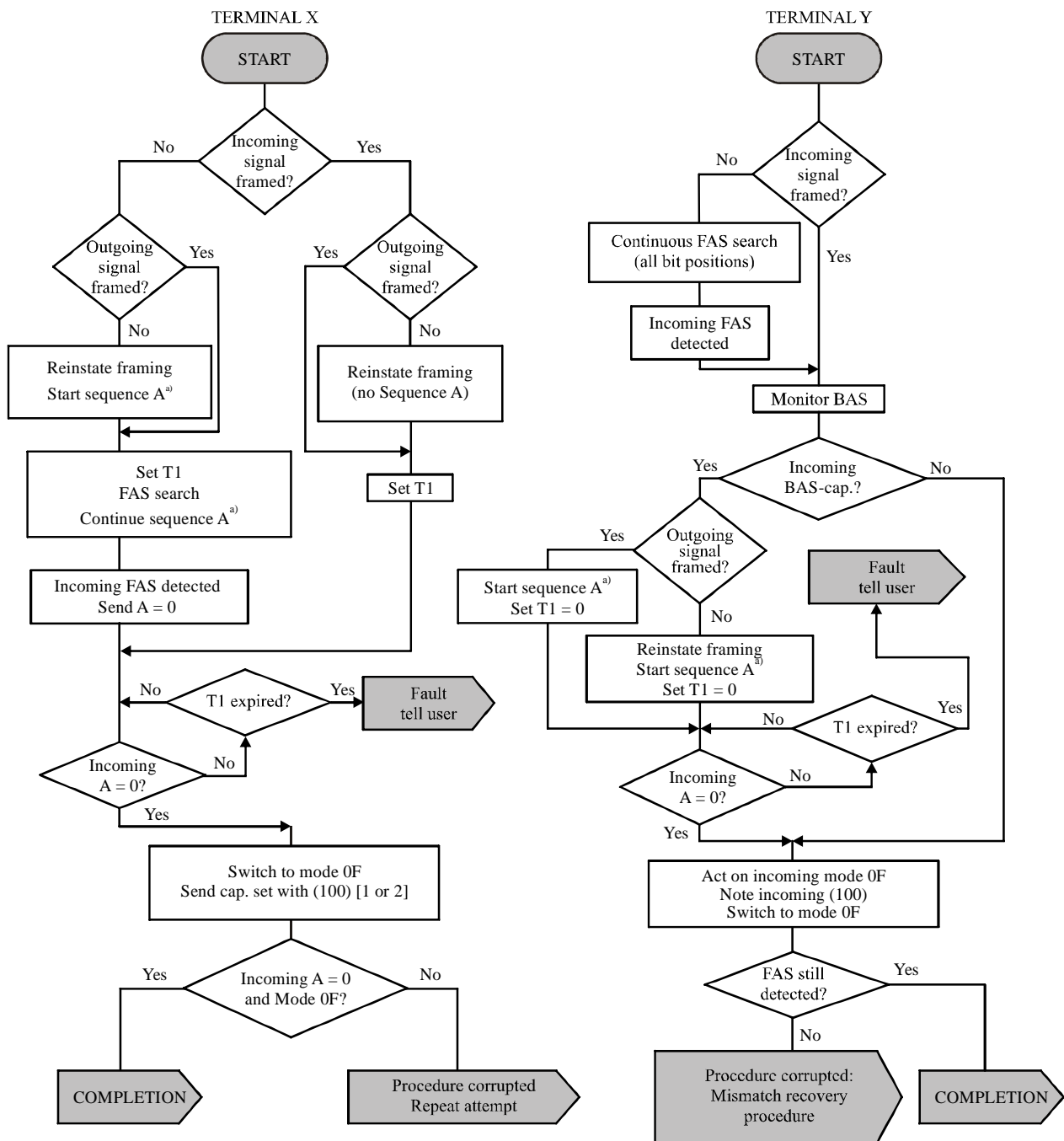

H.242(09)\_F03

<sup>a)</sup> Normal or reduced capsets or neutral cap. may be used.

**Figure 3 – Mode zero forcing – Terminal X initiates the forcing**

### 9.3.1 Single-channel operation

Where it is necessary to ensure that both terminals are operating in Mode 0 (for instance, before call transfer), this procedure is used. These single-channel procedures apply to all single channels regardless of rate. The transmitted mode is confined to audio G.711 A-law or  $\mu$ -law, framed.

The forcing terminal uses dynamic mode switching (see clause 9.2) with BAS audio command to switch to Mode 0F, followed by sequence A using a reduced capability set indicating only G.711 audio capability and the appropriate transfer rate (e.g., (001) [0] for a B-channel, (001) [6] for an  $H_0$  channel, etc.). The value for A- or  $\mu$ -law appropriate to the terminal's own region is used in case the call is to be transferred to a local G.711-only terminal.

The content of the reduced capability set is:

- single channel in use {capability marker, G.711(A) or/and G.711( $\mu$ )};
- two or more channels in use:
  - {capability marker, A-law and/or  $\mu$ -law, 1B}; or
  - {capability marker, A-law and/or  $\mu$ -law, H<sub>0</sub>}.

On receipt of this, the remote terminal is obliged to switch to Mode 0F also using the indicated law for its encoder and decoder. The procedure is complete when the forcing terminal detects incoming Mode 0F. Changes of network configuration can now be implemented (see clause 11).

NOTE – Time-slots other than TS1 are vacated during this procedure.

### 9.3.2 Two or more channels

In this case, the Mode 0 forcing is applied to the initial channel only, and separate considerations apply to treatment of the additional channels. These considerations apply whether the single channels are 64 kbit/s or any higher rate. Three cases are considered here by way of guidance for the multiple-B channel case:

- a) Additional channels dropped: This would be necessary, for example, prior to disconnection. The procedure is as for one channel, the forcing terminal declaring capability of PCM audio only with transfer rate capability of 1B, H<sub>0</sub>, H<sub>11</sub> or H<sub>12</sub>; this will result in mode switches successively to "data OFF", "video OFF" and audio Mode 0F or 0U, such that all additional channels are vacated and can be disconnected.
- b) Additional channels idle: This is the same as a), except that the forcing terminal makes no move to disconnect; the channels carry FAS, the multiframe number and the BAS indicating channel number; the content of the remainder of the idle channels is irrelevant.
- c) Additional channels maintained active: This might be beneficial in some recovery procedures. The forcing terminal declares a capability of PCM audio plus transfer rate unchanged from its previous value, and then itself switches to the appropriate mode.

An example of Mode 0 forcing case a is given in Appendix II.

## 9.4 Mode mismatch recovery procedure

In the case where mode mismatch has occurred, the Mode 0 forcing procedure may be used to establish a common working mode. Following this procedure, reinitialization can be achieved by using the mode initialization procedure.

NOTE – A mode mismatch could occur due to a corrupted BAS channel. Recovery in this case could be achieved by BAS command repetition. Mode 0 forcing should not be started immediately to allow the BAS command repetition process to complete. An interval of at least two seconds is suggested.

## 9.5 Procedure for influencing the mode transmitted from remote endpoint

An endpoint at which it is desired to receive a Mode different from that currently being received (including changes to the MLP rate) may send any SBE symbol from the range (100) [0..15], even if the sending endpoint has not declared that capability. An endpoint receiving such a symbol may or may not respond by changing to the Mode indicated; if there is no change of mode within a few seconds, the requesting endpoint must assume that the remote end will not make the requested change, for whatever reason.

## 10 Recovery from fault conditions

In general, it is expected that fault conditions will be rare and it may be uneconomical to provide elaborate recovery procedures to cover all eventualities. It is mandatory that proper indications of fault conditions be transmitted on the outgoing channel(s), in particular, A shall be set to 1 where

appropriate conditions for  $A = 0$  are not met. Clause 10.1 describes other actions, which should be taken on losing frame alignment, multiframe alignment, or synchronism; possible action upon loss of connection is presented in clause 10.2 for guidance.

## **10.1 Unexpected loss of synchronization or frame alignment**

### **10.1.1 Loss of frame alignment in the initial channel**

If a terminal unexpectedly loses frame alignment on its receive path, a timer T3 is set (minimum value 1 second) and incoming information is discarded if unintelligible. During this time, the status of the framing in the receive direction is monitored:

- a) if framing is recovered before the timer expires, the normal operation is resumed;
- b) if framing is not recovered before the timer expires, the terminal goes to the Mode 0 forcing procedure followed by reinitialization.

### **10.1.2 Loss of frame alignment or synchronization in an additional channel**

If a terminal unexpectedly loses synchronization (including that due to loss of frame alignment) on an additional channel, a timer T3 is set, outgoing A-bit is set to 1 and incoming information discarded if unintelligible; if the loss of this information also causes information on other channels to become meaningless, that also may be discarded:

- a) if synchronization is recovered before the timer expires, normal operation is resumed; this takes into account recoverable synchronization loss due to bit or synchronization errors on the transmission line;
- b) if synchronization is not recovered before the timer expires, the Mode 0 forcing procedure may be used.

## **10.2 Recovery from loss of connection(s)**

Loss of a connection means that end-to-end transmission on that channel has been discontinued, so that all apparently received bits are meaningless. The receiver will, of course, lose frame alignment and may follow the procedures of clause 10.1. However, an indication may be available from the network (D-channel or otherwise) that the connection has been lost; in this case, the procedures of this clause are followed. It is assumed that connection loss is bidirectional; the case of loss in one direction only is for further study.

### **10.2.1 Renumbering of channels**

This procedure is used for reconstructing the remaining normal additional channels when one additional channel breaks down:

- i) make the transmission mode of all channels into "framed";
- ii) vacate the sending additional channel(s);
- iii) renumber the additional channel(s) and examine the received channel numbers in the FAS; if the channel numbers are out of sequence, the mode 0 forcing procedure should be followed;

NOTE 1 – When an intermediate channel is lost, the remaining channels are renumbered sequentially starting at the next higher channel after the lost channel. When the channel with the highest number is lost, channel renumbering is unnecessary.

NOTE 2 – The FAS and BAS channel numbers must agree as specified in [ITU-T H.221].

- iv) wait for the synchronization establishment of the remote terminal and then expand communication onto the additional channels. A timer should be set (minimum value 10 seconds) to prevent waiting forever for the remote terminal to establish synchronization of the additional channels.

### 10.2.2 Loss of an additional connection

If any remaining channels are unframed (for example, data transmission), they shall immediately have frame structure (according to [ITU-T H.221]) re-imposed and maintained until conditions have returned to normal. The outgoing A-bit on additional channels is set to 1 if the incoming direction is unframed or out of sequence, or if synchronism has been lost.

If the lost channel was carrying part of a signal (such as encoded video) which also involved other channels, so that its loss renders the information in those other channels meaningless, then by dynamic mode switching those channels are vacated.

The next step is to renumber the available channels if appropriate, to obtain a continuous sequence; this is done using the procedure of clause 10.2.1.

Dynamic mode switching is applied to re-establish the video or other transmission on the channels for which incoming A-bits are zero.

In the event that the lost channel be reconnected, it is added to the capacity in the same way as at the start of the call after the channel renumbering procedure is completed.

### 10.2.3 Loss of the initial connection

This results in the loss of the initial channel in both directions. Both terminals immediately regard the next higher channel as the initial channel and transmit thereon the following BAS:

- i) reinstatement of FAS and BAS in any unframed channels;
- ii) transfer rate (001) [0 or 6]; 64 kbit/s or 384 kbit/s code having the effect of vacating all additional channels; also audio command (000) unchanged from previous value;
- iii) transfer rate (001) [17] on original second channel, this code "loss-i.c." indicating loss of original channel, and from next sub-multiframe original second channel substitutes for original initial channel;
- iv) any additional channels are renumbered in sequence;  
NOTE 1 – The FAS and BAS channel numbers must agree as specified in [ITU-T H.221].
- v) wait for confirmation that the synchronism at the remote terminal is retained/regained (all incoming  $A_n = 0$ ); a timer should be set (minimum value 10 seconds) to prevent waiting forever for the remote terminal to establish synchronization of the additional channels;
- vi) expand communication onto all channels using appropriate transfer-rate command;  
NOTE 2 – As a result of this procedure, sending and receiving initial channels may not be on the same connection.
- vii) the terminal tries to re-establish the lost channel.

## 11 Network consideration: call connection, disconnection and call transfer

### 11.1 Call connection

#### 11.1.1 Initial channel

It is assumed that the terminals for switched network operation will have a signalling arrangement for originating calls over the network.

Upon answering a call, the terminal shall begin the mode initialization procedure. Terminals for use on leased circuits may have a means for sending the alerting signal to the distant terminal and for answering the alerting signal. In this case, the sending of the alerting signal is equivalent to dialling and the foregoing procedures apply.

Whenever a terminal is manually reset, or recovers from a fault condition, the terminal shall begin the Mode 0 forcing procedure of clause 9.3. Then the terminal shall begin mode initialization.

### 11.1.2 Additional channels

Call connection to provide additional channels may be initiated by one of the following:

- a) manually (independently of the capability exchange through the initial channel);
- b) on completion of the capability exchange sequence indicating mutual additional-channel capability;
- c) at some time later than in b, prompted by user action.

The choice between these will depend on service provision and/or terminal procedures.

NOTE – The additional channel may already have been established in the case of private circuits.

For ISDN switched services, the initial connection shall be first established and according to the outcome of the in-band capability exchange the additional connections shall be established. This means that only choices b and c are allowed in this case.

Consequently, for 2B or 2H<sub>0</sub> communications, the initial connection contains the initial channels of both directions, and the additional connection contains the additional channels of both directions as well. Another implication of this sequencing of in-channel negotiation and additional call establishment is that the capability set shall include "2B (or 2H<sub>0</sub>) or higher transfer rate" at the first capability exchange; otherwise, the additional call set-up is not activated at the start of communication.

The capabilities in both directions shall indicate the intentions/ability of the two to use the additional B/H<sub>0</sub>-channel:

- the calling terminal signals both its ability to decode and (implicitly) its intention to make a second call request;
- the called terminal signals its ability (or inability) to cope with a second B-channel, and (implicitly) its intention to answer an incoming call request if one is forthcoming.

When two or more connections are to be established between two units (terminals or MCUs or one of each), one unit shall make all of the call requests: it is not permitted that a terminal, having answered an incoming call, should make a request for an additional-channel connection back to the same unit. If more than two connections are used, all the additional connections may be called simultaneously. Each additional channel number is allocated in the order of call establishment at the transmitter, a connection may convey two channels with different channel numbers in each direction.

When the establishment of connection is known to the terminal, the mode initialization procedure of clause 9.1.2 is applied.

During call establishment, an originating terminal shall reserve additional channels by not answering incoming calls on those channels until it is determined whether the additional channels should be used in the connection. This prevents multiple call collisions and contention for the available channels.

### 11.2 Terminal disconnection

It is strongly recommended that all terminals switch to transmitting Mode 0U before disconnection. If, for any reason, a terminal can no longer use one (or more) of the additional connections, it should first switch itself to a mode occupying the desired lower capacity, then send a capset showing the lower transfer rate as maximum, then wait for the incoming signals to drop to the lower rate, and finally disconnect the unwanted connections. The capset is to prevent any attempt from the other end to remake the connection. There is no need to force all the way down to Mode-0 in this case, though under some fault conditions it may still turn out to be the best route to recovery.

### 11.3 Call transfer

As a consequence of the above, the terminal which continues to participate in a transferred call will be receiving in a PCM-forced state and, therefore, will be transmitting its capability set in framed PCM. When the transferred-to terminal answers, mode initialization will occur in both directions.

Before call transfer, in the case where both terminals can transmit framed audio, the distant terminal's encoder and decoder must be forced by the relevant BAS capabilities and commands to the coding law of the region where the transfer is to take place.

### 11.4 Conferencing

Conferencing will be accomplished by means of a multipoint control unit (MCU). Each terminal will be connected to a port of the MCU by a switched connection or a leased circuit. Each connection between the terminal and the MCU is considered to be a point-to-point connection as far as call connection, terminal disconnection and call transfer procedures are concerned.

## 12 Procedure for activation and de-activation of data channels

### 12.1 General

[ITU-T H.221] provides capability and command BAS codes for four types of logical data channel: MLP, H-MLP, LSD, HSD. A number of alternative bit rates are provided for each type. The following rules apply to the simultaneous activation of two or more types:

- a) MLP and H-MLP may be activated simultaneously and then, when both are open, a single MLP sub-channel at the combined rate shall result (e.g., MLP rates of about 100 kbit/s on a 2B call, see Note to Figure 5j of [ITU-T H.221]).
- b) Neither LSD nor HSD may be opened when MLP and/or H-MLP are open, with the exception of the case when the remote equipment has declared the capability {H.224-sim} – see [ITU-T H.224]; similarly, and again with this exception, neither MLP nor H-MLP may be opened when either LSD or HSD is open.
- c) The commands [var-MLP] and [var-LSD] both identify as a data path the whole of the I-channel capacity not otherwise allocated by other commands; they shall not be used together.

A terminal may declare capabilities of more than one data type even though its ability to process applications may be limited to one data type at a time. In such a case, if it receives more than one data type simultaneously, it should send a reduced capability set, omitting all except the preferred type. However, correct demultiplexing operation according to Table 53 shall be maintained at all times.

### 12.2 Procedures applicable to all data types

Each terminal shall transmit a data-rate capability code (see [ITU-T H.221]) for each data type and rate it is able to receive (see also clause 12.5 concerning dummy data capability). This may be done during the capability exchange sequence at the start of the call or at a later time by initiating a new capability exchange.

A terminal may transmit a data stream (simultaneous use of two or more data channels is dealt with in clause 12.1 above) of any type and at any rate which has been indicated in the data capability codes it has received from the remote equipment (see Note). The appropriate data command (see [ITU-T H.221]) is sent and, in the following sub-multiframe, the data channel is opened, occupying the bits within each frame defined in [ITU-T H.221]. However, at the time the data command is first sent, these bits shall be unoccupied or contain only video information; therefore, audio or any other signals shall be removed from this part of the frame with the prior transmission of an appropriate

command. In the case of occupancy by video information, commands are not available to reduce the video rate, but the video decoder continues to operate correctly on the lower flow of information. However, if the video rate is being made very low (for example, less than 30.4 kbit/s) or stopped altogether by the introduction of a data stream, it is advisable first to send freeze-picture request, followed by the video OFF command.

NOTE – Sometimes symmetrical data transmission is required, e.g., in data transmission through the V.24/V.28 interface. If more than one data rate has been identified as common between two terminals, asymmetrical data transmission may take place according to different terminal procedures. This can be avoided by using the highest common rate.

To close a data channel, the appropriate OFF command (MLP-off, etc.) shall be sent. If video or a variable data channel is ON, it will then occupy the bits freed in the next sub-multiframe and thereafter; otherwise, those bits remain unoccupied until another command is sent.

At any time during data transmission, the rate may be changed by an appropriate data command, subject to the provisions given above.

### **12.3 Equipment capable of operating using protocol according to Recommendation ITU-T T.120**

The following provisions apply equally to the use of MLP on the I-channel and to H-MLP in other channels or time-slots, although only MLP is mentioned.

Each terminal capable of operating according to [ITU-T T.120] shall transmit one or more of the MLP-capability codes and also the T.120 capability value (Table A.3 of [ITU-T H.221]). This may be done during the capability exchange sequence at the start of the call, or at a later time by initiating a new capability exchange.

When a terminal or MCU wishes to transmit T.120 protocol in a point-to-point call, it shall transmit an MLP-on command at the appropriate rate and then T.120-on; for multipoint calls, see [ITU-T H.243]. When a terminal receives MLP-ON, it shall establish an MLP channel at an appropriate rate (the same rate, if [MCC] is in force) in the return direction.

To change the MLP rate, an appropriate MLP command is sent.

To discontinue use of the T.120 protocol, this matter may first be negotiated within the T.120 protocol itself; then one or both terminals transmit MLP-OFF. T.120-off may be used to discontinue T.120 operation without closing the MLP channel.

### **12.4 Data equipment not conforming to Recommendation ITU-T T.120**

Following opening of a data channel, a code from Table A.3 of [ITU-T H.221] may be sent, indicating the content of the channel applicable from the start of the next sub-multiframe. During the communication session, changes of content may be indicated by transmission of another code from Table A.3 of [ITU-T H.221].

Before closing a data channel, a code from Table A.3 of [ITU-T H.221] may be sent, if applicable, and if desired.

NOTE – In the case where 64 kbit/s HSD, for example, has been transmitted in the highest-numbered channel of a multiple-B channel connection, a slip during this data transmission would leave a misalignment when the HSD is turned off. To avoid corruption of video under these circumstances, it may be advisable to switch off the video stream before sending HSD-off, switching it on again as soon as A = 0 is received on the erstwhile data channel.



## 12.5 Dummy data

Terminals which have no data capability at specific rates may experience a loss of video service when engaged in a multipoint call with other terminals which have data capabilities at those rates and begin to use them. To overcome this, the terminal may optionally be designed to transmit "dummy data" at some rates, consisting of all Ones, whenever this is necessary to comply with the received command [MCC] as defined in [ITU-T H.230]. At the same time, the terminal must be able to digest the incoming multiplexed signal containing data at the given rate(s), correctly processing the reduced video rate but discarding the data.

Such a terminal shall construct its capability set as follows: first, all the real capabilities shall be sent, including the rates at which data applications can really operate, then the value {Nil\_Data}, and finally, a list of the data capabilities that can only be dealt with as Dummy, including, as a minimum, the value {MLP-6.4k} if not available as real data.

When connected to an MCU, the latter will send [MCC] according to [ITU-T H.243], and thereafter, the simple terminal shall mode-switch to transmit a multiplex of the same audio, video and data rates as it receives, but only Ones are sent in the Dummy Data channel. The data bits of the incoming signal are discarded and the video correctly decoded at the lower rate.

In point-to-point connection, the remote terminal may open a data channel; the simple terminal is not obliged to reciprocate (since [MCC] is absent), but it may do so, operating in the same way as for multipoint working, above.

## 13 Procedures for operation in restricted networks

### 13.1 Network aspects

In this Recommendation, the term "restricted network" applies to:

- networks having restricted 64 kbit/s transfer capability, defined in [b-ITU-T I.464] as 64 kbit/s octet-structured capability with the restriction that an all-zero octet is not permitted;
- networks in which the restriction is in the form of a constraint on Ones density which is not as strict as above, but is satisfied by not allowing an all-zero octet;
- 56 kbit/s networks.

The term "unrestricted network" applies to those providing transparent bearers at rates of 64 kbit/s or other transfer rates listed in Table A.1 of [ITU-T H.221].

A significant factor in the procedures is the availability or non-availability of the 8 kHz network clock at the H.221 processor within the terminal: the use of expressions such as "network timing is available" in clause 13 refers to this aspect. In many situations, it is not possible to get access to the network timing, for example, when an RS-449 or V.35 interface is used; it is then not possible to ensure that the SC of the H.221 frame will be inserted in Bit 7 with respect to the network clock.

The following two definitions for bit numbering apply.

**13.1.1 physical bit position:** This is the position relative to the network timing; that is, it is aligned with the network's definition of the eight bit positions on a 64 kbit/s network.

**13.1.2 logical bit position:** This is the position relative to the H.221 framing. In unrestricted connections, the SC is always in logical Bit 8, and in restricted connections it is always in logical Bit 7. The other bit positions precede the SC in descending order, as described in [ITU-T H.221].

There are two restricted modes of operation, according to whether physical or logical Bit 8 is stuffed:

**Restrict\_P:** Stuffing is in physical Bit 8; the SC may be in any other position than Bit 8.

**Restrict\_L:** Stuffing is in logical Bit 8, adjacent to the SC which is in Bit 7; the SC may be in any physical bit position.

In the particular case that the SC is in Bit 7 by network timing, the two modes coincide, this mode being referred to where necessary as "**Restrict\_PL**".

The Restrict\_P mode requires octet timing from the network at the point where the stuff bit is inserted, but does not require octet or septet timing at the H.221 multiplexer/demultiplexer of the terminal; it occurs at T1 interfaces where a CSU/DSU implements the stuffing, and also wideband ISDN connections that use V.110 rate adaptation to connect to restricted endpoints. It is **not** possible to implement Restrict\_P mode on interfaces that do not have access to network timing either directly or indirectly.

Lack of network timing results in the Restrict\_L mode of operation.

Examples of Restrict\_P and Restrict\_L modes are depicted in Figure 4.

The sub-channel arrangement for the 64 kbit/s Restrict\_L and Restrict\_P modes is shown in Table B.1 of [ITU-T H.221].

The capabilities Restrict\_P and Restrict\_L are conveyed in the capset by codes defined in Table A.1 of [ITU-T H.221]. A third relevant BAS value is the NoRestrict capability, applicable to an endpoint which cannot interwork with restricted networked endpoints. Terminals conforming to the 1993 and 1990 versions of this Recommendation do not use or recognize the capability values "Restrict\_P", "Restrict\_L" and "NoRestrict", and are referred to in clause 13 as "Old" terminals; later terminals are referred to as "New".

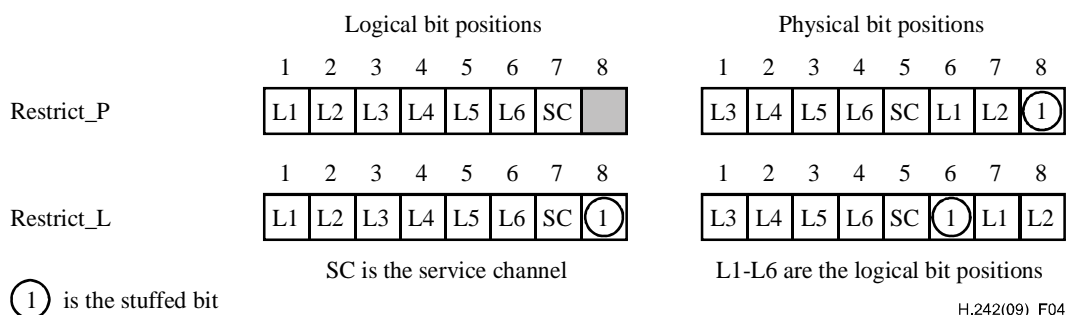

**Figure 4 – Restrict\_P and Restrict\_L modes**

## 13.2 Terminal-network configurations and properties

### 13.2.1 Terminals connected to restricted networks providing 56 kbit/s bearers

With reference to Figure 5, VT1B is a terminal connected directly to a 56 kbit/s network, such that the 8 kHz timing is available. Such a terminal is able to operate in Mode Restrict\_P only.

VT2B is a terminal consisting of two parts: an H.320 visual telephone is connected indirectly via a device X (such as a terminal adapter) which itself uses the 8 kHz clock to process the stuffing in Bit 8 but does not make this timing available to the H.320 unit. Such a terminal is able to operate in Mode Restrict\_P only.

Each terminal may utilize one, two or more connections.

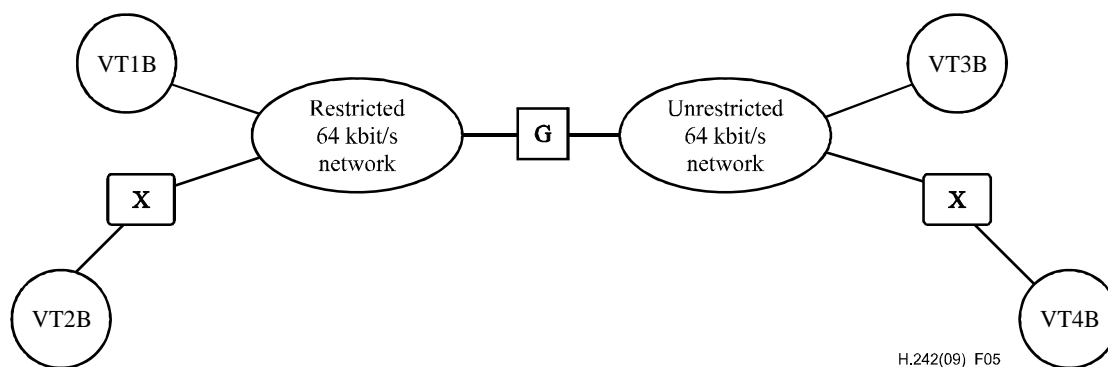

**Figure 5 – Unrestricted/restricted 64 kbit/s network**

### 13.2.2 Terminals connected to unrestricted networks providing 64 kbit/s bearers

Again with reference to Figure 5, VT3B is a terminal connected directly to a 64 kbit/s network, such that the 8 kHz timing is available. Such a terminal may be able to operate in Mode Restrict\_P or Mode Restrict\_L, or both or neither.

VT4B is a terminal consisting of two parts: an H.320 visual telephone is connected indirectly via a device X (such as a terminal adaptor) which itself uses the 8 kHz clock to process the stuffing in Bit 8 but does not make this timing available to the H.320 unit. Such a terminal may be able to operate in Mode Restrict\_L, or Mode Restrict\_P (using a method such as that described in clause 13.4.6 below), or both or neither.

Each terminal may utilize one, two or more connections.

### 13.2.3 Terminals connected to restricted networks providing higher rate bearers

With reference to the example of Figure 6, VT1H is a terminal connected directly to a 384 kbit/s network, such that the 8 kHz timing is available. Such a terminal is able to operate in Mode Restrict\_P or Mode Restrict\_L or both.

VT2H is a terminal consisting of two parts: an H.320 visual telephone is connected indirectly via a device X (such as a terminal adaptor) which itself uses the 8 kHz clock to process the stuffing in Bit 8 but does not make this timing available to the H.320 unit. Such a terminal is able to operate in Mode Restrict\_P or Mode Restrict\_L or both.

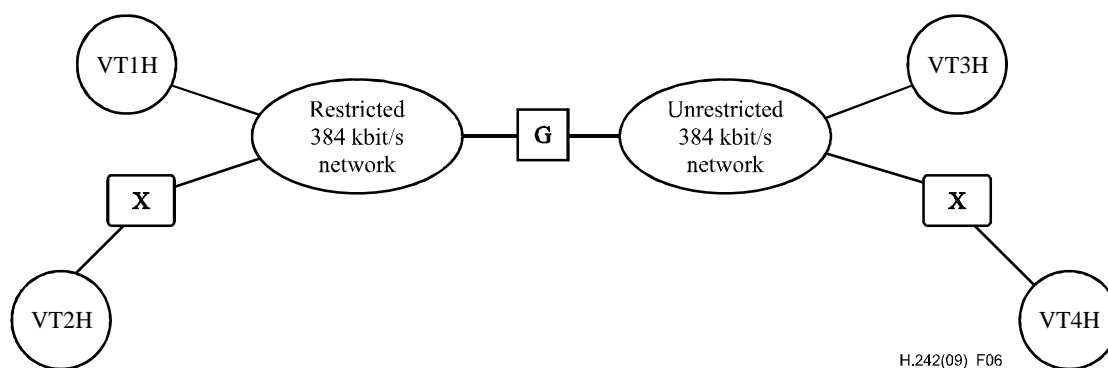

**Figure 6 – Unrestricted/restricted 384 kbit/s network**

### 13.2.4 Terminals connected to unrestricted networks providing higher rate bearers

With reference to the example of Figure 6, VT3H is a terminal connected directly to a 384 kbit/s network, such that the 8 kHz timing is available. Such a terminal is able to operate in Mode Restrict\_P or Mode Restrict\_L or both or neither.

VT4H is a terminal consisting of two parts: an H.320 visual telephone is connected indirectly via a device X (such as a terminal adaptor) which itself uses the 8 kHz clock to process the stuffing in Bit 8 but does not make this timing available to the H.320 unit. Such a terminal is able to operate in Mode Restrict\_P or Mode Restrict\_L or both or neither.

### **13.2.5 56 kbit/s interconnecting a 64 kbit/s network**

A 64 kbit/s terminal will interwork with a 56 kbit/s terminal as a rate adapted data call over a 64 kbit/s bearer channel. The terminal connected to the 64 kbit/s connection will rate adapt according to [ITU-T H.221]. In the case of a 64 kbit/s terminal connected to ISDN, the terminal may optionally be equipped to intercommunicate through an ISDN V.35 terminal adaptor. In any case, because the 56 kbit/s terminal cannot transmit correctly aligned septets, the terminal at the 64 kbit/s end cannot assume septet timing.

## **13.3 Transmission formats**

### **13.3.1 Framing signal (56 kbit/s)**

The transmission shall be arranged in 80 septet frames as specified in [ITU-T H.221].

### **13.3.2 Transmission formats (56 kbit/s operation)**

In 56 kbit/s operation the septets of each  $7 \times 80$  bit frame will be transmitted in order, most significant bit first at the 56 kbit/s rate. Septet alignment will be recovered from the frame alignment signal as specified in [ITU-T H.221].

### **13.3.3 $n \times 56$ kbit/s operation**

In  $n \times 56$  kbit/s operation, each 56 kbit/s connection will be framed and transmitted separately. Septet timing will be recovered independently from the frame alignment signal of each channel, and the differential delay between the channels will be compensated for on the basis of the multiframe numbering method specified in [ITU-T H.221].

The voice signal will be carried in the initial connection and video, graphics and auxiliary data may be carried in the initial and/or other connections.

### **13.3.4 $n \times H_0$ operation**

In  $n \times H_0$  operation, each connection will be framed separately and differential delay between the channels will be compensated according to [ITU-T H.221].

### **13.3.5 Dynamic allocation within a primary-rate connection**

Intelligent terminals may have a means for dynamically increasing or decreasing the bit rate during a connection. The means for controlling these allocations will be performed according to [ITU-T H.221]. There may be a need to recover framing by extraction from the received signal independently.

## **13.4 Procedures**

The procedures described here take place after any adaptation has been made to take account of the D-channel messages. The capset-generator part of the terminal must be aware of the situation with respect to network timing.

### **13.4.1 Capability values to be transmitted**

#### **Restrict\_Required**

An endpoint which can only send and receive restricted signals shall include {Restrict\_Required} in its capset; this value should be placed at the beginning of the capset, following cap-mark; such a terminal shall not include the value {NoRestrict}. When a terminal is connected to a restricted

network, it shall send Restrict\_Required in the initial capability set, as well as subsequent capability sets. However, it is allowable to delete the Restrict\_Required capability in subsequent capability sets if the restricted condition no longer exists. In this case, the transmit frame structure shall remain in the restricted mode until a Derestrict command has been sent. Likewise, if the Restrict\_Required capability was not included in the initial capability set, it may be included in subsequent capability sets if a restricted condition exists at a later time.

A terminal which is connected to an unrestricted network shall not normally include Restrict\_Required in its capset; however, if for any reason (such as the case of clause 13.4.5) restricted operation is necessary, a terminal may then include the Restrict\_Required capability. An MCU on an unrestricted network may send Restrict\_Required capability, if necessary, for interworking with terminals connected to restricted networks.

NOTE 1 – The "restrict required" capability was known as "restrict" capability in 1993 and earlier versions of [ITU-T H.242] and [ITU-T H.221].

### **NoRestrict**

An endpoint which is unable to send and receive restricted signals shall (see Note 2) include {NoRestrict} in its capset, and shall not include any of the values {Restrict\_P, Restrict\_L, Restrict\_Required}.

NOTE 2 – A terminal conforming to earlier versions of this Recommendation cannot send the NoRestrict value.

### **Restrict\_P and Restrict\_L**

An endpoint which can send and receive Restrict\_P shall (see Note 3) include {Restrict\_P} in its capset, whether or not it is itself connected to a restricted network.

An endpoint which can send and receive Restrict\_L shall (see Note 3) include {Restrict\_L} in its capset, whether or not it is itself connected to a restricted network.

An endpoint which can send and receive both Restrict\_P and Restrict\_L shall (see Note 3) include {Restrict\_P, Restrict\_L} in its capset, whether or not it is itself connected to a restricted network. Two cases may be distinguished:

- network timing is available at the (de)multiplexer, so the terminal can transmit and receive Mode Restrict\_PL;
- network timing is not available at the (de)multiplexer, but in addition to Restrict\_L the terminal is able to send and receive Restrict\_P by using a technique such as that described in clause 13.4.6.

NOTE 3 – A terminal conforming to earlier versions of this Recommendation cannot send Restrict\_P or Restrict\_L values.

Table 48 defines the nine types of terminals that can be distinguished by their transmitted restrict-related capabilities. Note that terminal type T9 is the only allowable combination that uses the NoRestrict\_Cap. Terminal types T6 and T8 are not allowed on restricted narrow-band networks because Restrict\_L cannot be used on these networks. Thus, T7 is the only type applicable to such networks.

**Table 48 – Terminal classification based on restricted capabilities**

Terminal classification	Restrict_Required	Restrict_P_Cap	Restrict_L_Cap	NoRestrict_Cap	New/Old	Requires octet timing
T7	Yes	Yes	No	No	New	(Note 2)
T6	Yes	No	Yes (Note 1)	No	New	No
T8	Yes	Yes	Yes (Note 1)	No	New	(Note 2)
T2	No	No	Yes	No	New	No
T3	No	Yes	No	No	New	(Note 2)
T4	No	Yes	Yes	No	New	(Note 2)
T9	No	No	No	Yes	New	No
T5	Yes	No	No	No	Old	(Note 3)
T1	No	No	No	No	Old	(Note 4)

NOTE 1 – Restrict\_L cannot be used on restricted narrow-band networks, so Types T6 and T8 can exist only on wideband networks.

NOTE 2 – Restrict\_P can be implemented using [b-ITU-T V.110] in the terminal adapter, octet timing, or a technique similar to that described in clause 13.4.6.

NOTE 3 – This terminal must use Restrict\_P on restricted narrow-band channels and (usually?) Restrict\_L on restricted wideband channels.

NOTE 4 – It cannot be determined which restricted modes this terminal supports based on its capabilities: when restricted operation is initiated, there is no assurance of interoperability in this case.

### 13.4.2 Selection of appropriate restricted mode

The mode selection is made according to the capabilities in the current received and transmitted capability sets. The same mode shall be used in both directions.

Table 49 shows the modes of operation between the new types of terminals. There are several cases where restricted operation is not possible. Manufacturers should support both restricted modes when possible to increase the chance of interoperation.

Tables 50 and 51 show the mode of operation between old and new terminals on narrow-band and wideband connections respectively. When one or both endpoints have sent Restrict\_Required, Restrict\_P is used on restricted narrow-band connections, and Restrict\_L is used on restricted wideband connections. Terminal type T1 is an old terminal that does not send any restrict-related capabilities. When T1 is connected to an unrestricted terminal, the restricted mode is undefined.

**Table 49 – Mode of operation between new terminals**

Local terminal type	Local restricted mode supported	Remote terminal type	Remote restricted mode supported	Possible working modes	Resulting mode used
T2	RL	T2	RL	Unrestricted or RL	Unrestricted
		T6	RL	RL	Restrict_L
		T4	RL, RP	Unrestricted or RL	Unrestricted
		T8	RL, RP	RL	Restrict_L
		T3	RP	Unrestricted	Unrestricted
		T7	RP	None	No communication possible
		T9	None	Unrestricted	Unrestricted
T6	RL	T2, T6	RL	RL	Restrict_L
		T4, T8	RL, RP	RL	Restrict_L
		T3, T7	RP	None	No communication possible
		T9	None	None	No communication possible
T4	RP, RL	T2	RL	Unrestricted or RL	Unrestricted
		T6	RL	RL	Restrict_L
		T4	RL, RP	Unrestricted or RL	Unrestricted
		T8	RL, RP	RL	Restrict_L
		T3	RP	Unrestricted or RP	Unrestricted
		T7	RP	RP	Restrict_P
		T9	None	Unrestricted	Unrestricted
T8	RL, RP	T2, T6	RL	RL	Restrict_L
		T4, T8	RL, RP	RL	Restrict_L
		T3, T7	RP	RP	Restrict_P
		T9	None	None	No communication possible
T3	RP	T2	RL	Unrestricted	Unrestricted
		T6	RL	None	No communication possible
		T4	RL, RP	Unrestricted or RP	Unrestricted
		T8	RL, RP	RP	Restrict_P
		T3	RP	Unrestricted or RP	Unrestricted
		T7	RP	RP	Restrict_P
		T9	None	Unrestricted	Unrestricted
T7	RP	T2, T6	RL	None	No communication possible
		T4, T8	RL, RP	RP	Restrict_P
		T3, T7	RP	RP	Restrict_P
		T9	None	None	No communication possible
T9	None	T2, T3, T4, T9		Unrestricted	Unrestricted
		T6, T7, T8		None	No communication possible

**Table 50 – Mode of operation between new and old terminals  
on narrow-band connections**

Local terminal type	Local restricted mode supported	Remote terminal type (Note 2)	Remote restricted mode supported	Possible working modes	Resulting mode used
T1	(Note 1)	T2, T3, T4	–	Unrestricted (Note 1)	Unrestricted
		T9		Unrestricted	Unrestricted
		T7	–	RP or none	Restrict_P if T1 can do this
T5	RP	T2	RL	None	No communication possible
		T3, T7, T8	RP (Note 2)	RP	Restrict_P
		T4	RL, RP	RP	Restrict_P
		T9, T6	None (Note 2)	None	No communication possible
NOTE 1 – A T1 terminal may be capable of RP and/or RL modes, but whether or which cannot be determined remotely.					
NOTE 2 – Terminals T6 and T8: Restrict_L cannot be used on restricted narrow-band networks.					

**Table 51 – Mode of operation between new and old terminals on wideband connections**

Local terminal type	Local restricted mode supported	Remote terminal type	Remote restricted mode supported	Possible working modes	Resulting mode used
T1	(see Note 4 of Table 48)	T2, T3, T4, T9	–		Unrestricted
		T6	RL		Restrict_L if T1 can do this
		T7	RP		Restrict_P if T1 can do this
		T8	RL, RP		RL or RP if T1 can do this
T5	RL and/or RP (see Note 3 of Table 48)	T2, T6	RL		Restrict_L if T1 can do this
		T3, T7	RP		Restrict_P if T1 can do this
		T4, T8	RL, RP		RL or RP if T1 can do this
		T9	None		No communication possible



## V.110 rate adaptation

The Restrict\_Required code shall be sent by an endpoint attached to a narrow-band connection when V.110 rate adaptation is used, even if the network itself is unrestricted. V.110 rate adaptation stuffs a "1" in physical bit position 8, and it is not possible to operate in an unrestricted mode in this situation. V.110 rate adaptation is used to enable interoperation between unrestricted ISDN networks and restricted networks. For example, V.110 rate adaptation can be used when connecting from a switched 56 kbit/s site to a BRI site, or even when connecting between two BRI sites when there is a restricted segment somewhere along the communications path.

### Backward compatibility with old terminals

Old systems do not send the restrict capability if they do not require operation in the restricted mode of operation. There is no way of knowing if an old terminal attached to an unrestricted network is capable of the restricted mode of operation. Under this procedure, if the remote terminal does not send any of the new restricted operations capabilities, the local terminal shall assume that the remote terminal may or may not be capable of the restricted mode of operation.

If restrict capabilities are not received, and the restricted mode is not required by the local terminal, the local terminal shall not use the restrict commands.

If the restricted mode is required by the local terminal, call establishment will be attempted anyway. There are three possible outcomes:

- 1) frame alignment is not achieved, either:
  - i) because the remote end has no restrict capabilities – this can be automatically detected and signalled to the user; or
  - ii) for some other reason, such as a fault condition;
- 2) frame alignment is achieved, but the two sites are operating in different restricted modes which will corrupt the audio, video and data; this can be detected if CRCs are in use, or may otherwise be clear from the failure of the video decoder to synchronize, in which case the user may be informed of an incompatibility. It will be obvious to the user that something is wrong;
- 3) the two sites will successfully connect in the same restricted mode of operation.

### 13.4.3 Restricted mode transmitted

An endpoint which is required to switch from unrestricted to a restricted transmission shall first send [restrict] and then adopt the restricted mode according to Table 49 at the next sub-multiframe. An endpoint which is required to switch from restricted to unrestricted transmission shall first send [derestrict] and then adopt unrestricted transmission at the next sub-multiframe.

An endpoint already transmitting a restricted mode shall include the command [restrict] in all repetitive transmissions of valid commands in force. An endpoint transmitting unrestricted after previously transmitting a restricted mode shall include the command [derestrict] in all repetitive transmissions of valid commands in force.

An endpoint which receives the capability value {RestrictRequired} shall, if it is not already transmitting in the appropriate mode according to Tables 49 to 51, perform a mode switch to that mode according to the procedure of clause 9.2. In the case that it has previously received [MCC], if it is in the process of transmitting a capset when {RestrictRequired} arrives and, at the same time it is receiving A = 0, it shall first complete this capset according to clause 8.1; if receiving A = 1, the mode switch shall be performed immediately.

In a point-to-point connection, a restrict command may be sent at any time, as long as it is within the capability sets of both terminals. It is allowable for one system to send in the unrestricted mode

while the other system is sending in a restricted mode. Switching from the restricted mode to the unrestricted mode should be done in a clean manner without any loss of framing or data.

Prior to switching to the restricted mode, the audio and data channels shall be set to data rates that are consistent with the restricted mode of operation. As an example, 56 kbit/s G.711 audio shall not be in use immediately before a switch from unrestricted to restricted operation is made. In this situation, the audio shall be changed to 48 kbit/s G.711 prior to switching to the restricted mode. The 48 kbit/s G.711 command (000) [20 or 21] may only be sent immediately before the restrict command in the unrestricted mode. Likewise, when switching from restricted with G.711 audio at 48 kbit/s to unrestricted operation, the "derestrict" command shall be immediately followed by the audio command (000) [18 or 19].

### Calls involving an MCU

The restrict and derestrict commands as described in Annex A of [ITU-T H.221], shall be used to downgrade a non-restricted call involving an MCU and upgrade a restricted call involving an MCU.

#### 13.4.4 Restricted mode received

An endpoint which receives the command value [Restricted] shall demultiplex accordingly from the beginning of the subsequent sub-multiframe, destuffing according to the mode identified in Tables 49 to 51.

#### 13.4.5 Restricted "bottleneck" between two unrestricted networks

If a call is made from a terminal on an unrestricted network to a terminal on another unrestricted network, it may happen that the connection is made via a restricted network (see Figure 7). If the request for an unrestricted 64 kbit/s connection is rejected at the first gateway according to [b-ITU-T Q.931], a new request shall be made, this time for a 56 kbit/s bearer. However, if there is no such rejection and the call is connected, the terminals will initially be unaware of the restriction, either because the transmitted capsets do not contain Restrict\_Request or because no BAS is conveyed at all (overwritten by stuffing bits). Terminals likely to encounter this situation should be able to send capabilities {Restrict\_Required and Restrict\_P or Restrict\_L}, and to transmit the appropriate restricted mode, under one of the following conditions:

- i) detecting all Ones in physical Bit 8 or logical Bit 8.  
NOTE – There is no guarantee that the restricted network will insert only Ones in Bit 8.
- ii) if no FAS is detected within 5 seconds;
- iii) including the restricted capabilities and transmitting in the restricted mode from the outset.

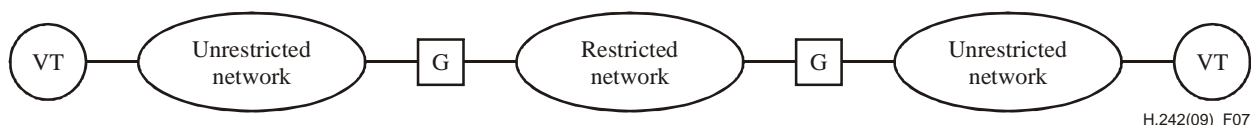

**Figure 7 – Interconnection of two unrestricted networks via a restricted network**

#### 13.4.6 Interworking between Restrict\_L and Restrict\_P endpoints

All terminals shall respond to the digital loopback command LCD and the Loop-off command (codes (010) [20 and 21] in Table A.1 of [ITU-T H.221]). A terminal which has received LCD and {Restrict\_P} before the initial capability exchange is complete shall suspend timer T1 until it receives Loop-off.

Terminal E<sub>L</sub> is attached to an ISDN operating at 64 kbit/s, but has no access to network timing; it is able to work in the Restrict\_L mode. The following method may be used to achieve interworking in

Mode Restrict\_P. A terminal capable of achieving Restrict\_P operation by this or a similar method shall include {Restrict\_P} in its capability set, in addition to {Restrict\_L}.

If the signals received at  $E_L$  have included the capability {Restrict\_P} but not {Restrict\_L}, and either {Restrict\_Required} or command [restrict], it terminates the current transmission of capability sets, if any, sends Au-off, F (see Table A.1 of [ITU-T H.221]) and LCD; if any video or data signals are active, they are also switched off. Each Bit position of the transmitted stream is filled with a different repetitive pattern other than all Ones or all Zeros, such that each logical bit position 1-7 may be identified. When this transmission reaches Terminal  $E_P$ , one of the logical bit positions has been stuffed: two cases are considered, that where one of the Bits 1-7 is stuffed, and that in which the SC position is stuffed.

### 13.4.6.1 Stuffing in one of Bits 1-7

In the following illustration, logical Bit 2 has been stuffed.

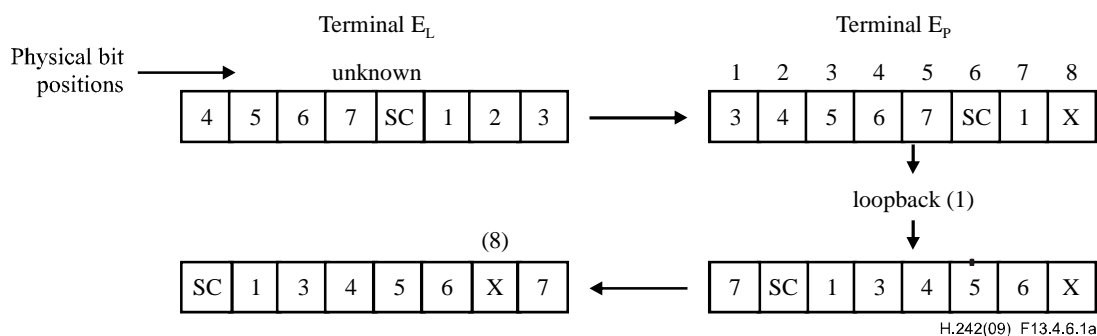

The digital loopback (1) returns the same bits as received at  $E_P$ , with no particular relationship to the network timing, but of course the stuffing bit is correctly positioned.

The returned signal to  $E_L$  has Bit 2 missing, so it is now known that outgoing Bit 2 occupies transmitted physical Bit 8. Moreover, the returned signal to  $E_L$  also has a stuffed bit X interposed at random: this bit X shall now be interpreted as identifying the incoming physical Bit 8.

Terminal  $E_L$  now makes a step change in its transmission, thus (following the above example):

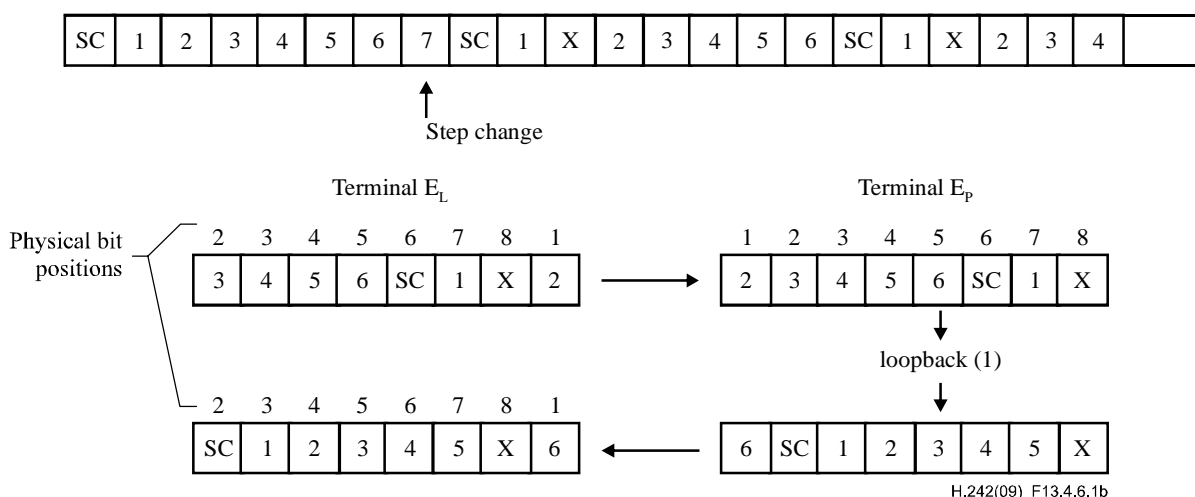

It is now the Bit 8 which is lost.  $E_L$  now sends Loop-off, audio on, and repetitive capability sets, entering mode initialization procedure of clause 9.1. On the receive side, the signal from  $E_P$  probably has the SC in a different position, since its framer does not see the network timing, but physical Bit 8 continues to be stuffed, and so  $E_L$  discards this; a1-a6 denote PCM audio bits.

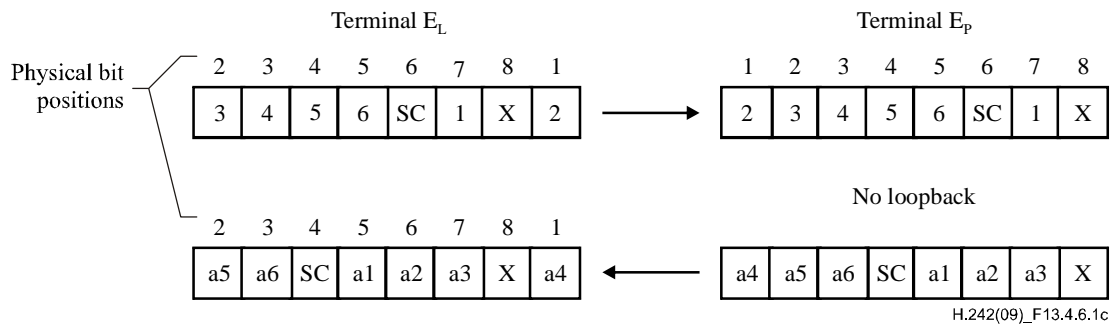

### 13.4.6.2 Stuffing in SC position

If the SC is the bit position which is lost, overstuffed by the network, the LCD value does not reach  $E_P$ , and  $E_L$  continues to receive the signal from  $E_P$ .

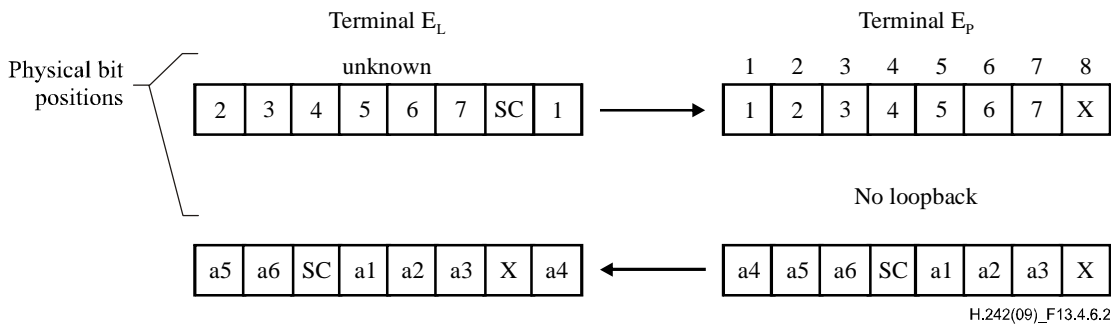

In this case, the first step change must be to move the SC itself and stuff the outgoing bit which will be lost. Then the same loopback procedure is used to identify which of the incoming bits is to be discarded.

## 14 Procedure for use of BAS-extension codes

[ITU-T H.221] provides for the attribute (111) for extension of the use of the BAS position in the subsequent sub-multiframe(s) for other purposes. There are 32 values [0]..[31] of this attribute, the meaning of these being defined in [ITU-T H.221].

Note that the value (111) [24] is the capability marker (see [ITU-T H.230]) which is followed by normal BAS codes, not by any escape values. Non-ITU-T capabilities messages should not contain this byte (111) [24], thereby emulating cap-mark, as this may hinder error-recovery procedures.

Values [0..14] are reserved for future extension of the scheme to include attribute class and family. They shall not be transmitted to an endpoint which has not declared the capability esc-CF, (101) [29] in Table A.1 of [ITU-T H.221], otherwise serious misoperations may occur.

Values [15..23] are defined as single-byte extension (SBE); codes of SBE type may be transmitted at any time and to any terminal.

Value [18] gives access to a table of values specifying applications of a data channel (LSD or HSD or MLP). The application is active from the submultiframe following that in which the relevant specific application command BAS is transmitted. The closure of the data channel (using LSD/HSD/MLP-off) effectively closes the application.

All terminals shall recognize the SBE attributes, at least to the extent of ignoring the subsequent code, whose meaning is not prescribed in this Recommendation. However, when (111) [17] is received, the subsequent code may be one of the mandatory values specified in [ITU-T H.230]. The ability of a terminal to use the content of other such codes is governed by other Recommendations.

For example, [ITU-T H.320] defines the requirements for visual telephone terminals to act upon some of the control and indication values.

Values [25..31] are of multiple byte extension (MBE); codes of MBE shall only be transmitted to a terminal which has previously indicated its capability to receive MBE. It follows that a non-ITU-T capabilities message shall not be transmitted in the initial capability exchange, until the MBE-cap has been received. An example of the structure of MBE messages is given in Appendix III.

## 15 Bit occupancy and the sequencing of BAS codes

In general, when there is no set procedure governing the sequence of BAS codes, the order is determined by the sending terminal. When there is no other demand for use of the BAS position, all the valid BAS commands in force, as indicated in Appendix IX, shall be repeated, so that in the event of a temporary disturbance, the proper mode will be restored as soon as possible thereafter.

Table 52 summarizes the BAS capabilities that can be simultaneously valid.

**Table 52 – BAS capabilities that can be included in a valid capability set (Note 1)**

Audio	Absent or One or more values (Note 2) from A-law, $\mu$ -law, G.719, G.722-48, G.722-64, G.722.1-24, G.722.1-32, G.722.1 Annex C-48, G.722.1 Annex C-32, G.722.1 Annex C-24, G.723.1, G.728, G.729, ISO/IEC 14496-3
Video	Absent, or (H.261-QCIF plus one MPI value), or (H.261-CIF plus two MPI values), and/or video-MPEG-1, and optionally MBE messages for H.260-series Recommendations
Transfer rate	Absent [meaning rate = 64 kbit/s only (Note 3)] or: max. no. of 64 kbit/s channels; max. no. of 384 kbit/s channels; and in addition any relevant values from {128, 192, 256, 320, 512, 768, 1152, 1472, 1536, 1920 kbit/s} and Table A.5 of [ITU-T H.221]
Restricted network	Either i) absent; or ii) No_Restrict only; or iii) one or more of Restrict_required, Restrict_P, Restrict_L
Single/Multiple channel compatibility	Absent or {SM-comp} or {6B-H <sub>0</sub> -comp}
Low-Speed Data (LSD)	Absent or all relevant values
High-Speed Data (HSD)	Absent or all relevant values (Note 4)
Low-speed MLP	Absent or all relevant values or MLP_Set1 or MLP_Set2
High-speed MLP	Absent or all relevant values
Applications in data channel	Absent or all relevant values
Capabilities defined in [ITU-T H.230]	Absent or all relevant values
Audio-ISO capabilities	Absent or all relevant values
Encryption	Absent or present
Multiple-byte extension	Absent or present
NOTE 1 – See Appendix VI for hierarchical capability BAS codes.	
NOTE 2 – See Appendix VII for interpretation of received audio capabilities.	
NOTE 3 – When reducing the transfer-rate capability to 64 kbit/s from a higher value, the value transfer-capacity = 64 kbit/s shall be included.	
NOTE 4 – A capability set shall not include any HSD capabilities whose bit rates exceed the transfer rate capability (e.g., 256 kbit/s HSD for 2B transfer rate).	

The capability set consists of the capability marker (111) [24] followed by all currently valid values; the values may be in any order except for the provisions of clauses 5.2, 12.5 and 13.4.1. No values other than null shall be repeated within a set (and Null shall not be transmitted by a terminal, see [ITU-T H.244]). The set may in turn be followed by a repetition of the set, or by the marker alone to indicate completion of the set prior to sending commands. Repetitions of the set shall be without any change whatsoever, either in content or order. The length of the capability set iteration is not limited, but the last capability set shall be followed by a cap-marker and at least one command listed in Table 53. If it is desired to change the capability set during its transmission, the existing set shall first be completed without change, followed by the marker alone and at least one BAS command before the new, changed set is started. See Appendix VIII for some examples of legal and illegal BAS sequences.

Table 53 summarizes the BAS commands that can be simultaneously in force.

**Table 53 – Command summary**

<b>Attribute</b>	<b>Alternative values (last value only is valid)</b>	<b>Default assumed</b>	<b>Comments</b>
Audio (000)	[0, 4..7, 10..15, 18..19, 24..31]	[18 or 19]	
Transfer rate (001)	[0..16, 23, 24, 26, 29] [17]	[0]	[17] – see clause 10.2.3
Restrict (010)	[27, 28]	[28]	
Video and other (010)	[0..4, 8, 9] [6, 7] [10,11,12,13] [14,15] [16] [17] [18, 21] [19, 21] [20, 21] [23..26]	[0] [7] [13] [15]  [21] [21] [21] [24]	Cancelled by command in video frame Expires after fast update completed
LSD and MLP (011)	[0..15, 31] [16..30] and (010) [5]	[0] [16]	Simultaneous LSD and MLP may be sent only if {H.224-sim} has been received – see [ITU-T H.224]
HSD and H-MLP and Au-ISO	(011) [0, 1, 17..26] (011) [2..8, 12..14] (001) [0..22] (001) [23, 24] (001) [25..28]	[0] [14] [0] [24] [25]	Reached from Escape table (111) [16]

Only one value in each row can be in force at any one instant, up to 19 values on the initial channel (all the above values except (001) [18..22] apply only to the initial channel); however, in practice, many of the combinations are precluded by the fact that they would affect the same bits of the channel (for example, (011) [31] and (011) [19] cannot coexist).

A command remains in force until another from the same row is transmitted. A command shall not be transmitted if to obey it would cause a simultaneous mode change on another row; in such a case, the other row value shall be changed first (for this purpose, a change of bit-rate of video or any of the variable data values does not constitute a mode change).

In general, unless specified otherwise, a BAS code which is invalid or which contravenes the provisions of Table 53, or otherwise indicates an impossible frame structure or system status, shall not be transmitted.

In general, a terminal is not required to recognize BAS-commands which do not correspond to capabilities it has previously declared; however, it is better practice to recognize such commands and classify them as:

- i) those which can be ignored; and
- ii) those which may result in a mode mismatch (see clause 9.4).

It is important not to initiate a recovery procedure unnecessarily (for example, on receipt of LSD-off when it had never been declared or turned on), since this could result in system lock-up between two terminals having different internal procedures.

The following notes serve to clarify the application of these rules to the multiplexing of audio, video and the various forms of data. Some examples relating to data transmission are given in Appendix V.

- a) Audio cannot penetrate into fixed rate data (LSD or MLP) bit positions. It can expand its capacity into vacant or video or variable data bit positions. It can reduce its capacity within the audio bit positions currently occupied.
- b) Video occupies all bit positions which are not assigned by other commands (ECS, audio, LSD/MLP regardless of being fixed rate or variable rate).

Video can be turned on at any time even if the available capacity for video is zero at the corresponding sub-multiframe (it may happen, for example, that video is switched on just before the variable rate LSD or MLP channel is closed); the demultiplexer shall not ignore "video on" even in this case, otherwise a mode mismatch occurs. However, if video capacity is less than about 30 kbit/s averaged over several sub-multiframes, it may not be practical to decode and display the picture; this is left to local decision in the terminal.

It should be noted that video-off, (010) [0], should be preceded by freeze-picture request, (010) [16].

To ensure that the picture builds up quickly when the video transmission first begins, the encoder shall transmit in INTRA mode (see [ITU-T H.261] and other H.26x-series of Recommendations).

Since this INTRA can be received completely only if the remote decoder is ready, the encoder shall estimate when it should start INTRA. One way may be to repeat INTRA appropriate times or send Fill bits (defined in clause 5.4.3 of [ITU-T H.261]) before sending INTRA. Another way may be that the decoder estimates when the remote encoder is ready and issues a VCU command at an appropriate timing.

- c) Fixed rate LSD/MLP cannot penetrate into audio bit positions nor into fixed rate MLP/LSD bit positions. It can expand its capacity into vacant or video or variable MLP/LSD bit positions. It can reduce its capacity within the data bit positions currently occupied. As a combination, fixed rate LSD/MLP can occupy new bit positions which have previously been either vacant, video, variable rate MLP/LSD or occupied by the same type of fixed rate data.
- d) Variable rate LSD/MLP occupies all bit positions which are not assigned by other fixed rate commands (ECS, audio, fixed rate MLP/LSD). If video has been on, it is excluded from the initial channel when variable rate LSD or MLP is turned on. If variable rate LSD/MLP has been on, opening a variable rate MLP/LSD channel shall be preceded by closing the existing variable rate LSD/MLP channel.

Variable rate LSD or MLP can be turned on at any time even if the available capacity for it is zero at the corresponding sub-multiframe; (it may happen, for example, that the

variable MLP is switched on just before closing the LSD channel which has been occupying all the capacity other than audio); the decoder shall not ignore "variable rate LSD or MLP on" even in this case, otherwise a mode mismatch occurs.

- e) LSD/MLP rate may be changed without first closing the data channel: this applies equally to changes between fixed and variable rate. It is emphasized that there can only be one LSD and one MLP channel at any instant.
- f) Capacity of video or variable LSD/MLP can be temporarily reduced to zero in a sub-multiframe as part of dynamic bit rate allocations.
- g) The rules for the use of HSD and H-MLP (in other than the I-channel) are identical to those given above for LSD and MLP in the I-channel.
- h) Any code can be sent in bit positions which have not yet been opened by the BAS commands. In a 2B communication, for example, the additional channel may send "0" or "1" or any combinations in bit positions except those for FAS and BAS till a 2B transfer rate command is sent. It should be noted that, although the terminal may set the "unopened" bits to any values, there is no assurance that those bits will be delivered to other terminals in a multipoint conference by the MCU.

## **16 Procedure for dealing with single/multiple channel interconnection**

Terminals that have single channel network access (e.g., 384) are able to interwork with terminals that use multiple channels to access a digital network (e.g., 6B). This is accomplished by the use of the SM-comp or 6B-H<sub>0</sub>-comp BAS capability and command codepoints (refer to clauses A.3 and A.7 of [ITU-T H.221]) and the use of an MCU or a channel aggregation unit (CAU).

If the terminal possesses this capability, that terminal shall declare it along with its transfer rate capabilities in its capability set. The "comp" capability applies to all of the transfer rates supported by the terminal.

When the [SM-comp] or [6B-H<sub>0</sub>-comp] command has been received at such a terminal, it discards the least significant bits in the first 16 octets of the received bit stream except those in TS1; it also sets those same bits to "1" in the transmitted bit stream.

A terminal using multiple channel access does not receive [SM-comp] or [6B-H<sub>0</sub>-comp].

Full procedures for CAU operation may be found in [ITU-T H.244], and for MCU operation in [ITU-T H.243].

## **17 Procedure for use of encryption control signal channel**

Each terminal shall transmit the encryption capability code if it is able to handle the ECS channel. No terminal may activate the channel without first receiving the corresponding capability code. Once an ECS capability code has been transmitted, it cannot be cancelled by omission from a subsequent capability exchange. That is to say, a terminal having once received, stored and made use of an ECS capability code shall assume continued validity until cancelled by the local user. Thus, encryption can be discontinued by the users themselves but not by a third party tampering with the BAS-capability exchange.

The initiating terminal transmits the command "ECS channel ON"; from the next sub-multiframe it opens the 800 bit/s ECS channel defined in [ITU-T H.221], whose use is specified in the Recommendation defining the encryption system (FAS, BAS and the ECS channel itself are in any case not encrypted).

When encryption has been turned off, the BAS command "ECS channel OFF" is used to close the ECS channel.



## **18 Transmission of network addresses**

The SBE and MBE symbols referred to in this clause are defined in [ITU-T H.230].

The optional procedures of this clause provide for an endpoint to request network-address information from the remote endpoint to which it is connected. An "endpoint" may be a terminal, MCU, channel aggregator or other equipment conforming to this Recommendation. An endpoint which cannot recognize or act upon a received request shall simply disregard it.

NOTE – Some networks require the use of the same network address for additional connections as for the initial connection; however, in other networks, this may not be the case. It is strongly recommended that, wherever possible, additional-channel network addresses should be such as is conveyed by one of the single SBE symbols NIS, NIC, NID, and terminals should be able to transmit and receive NCA-a, NIS, NIC and NID.

### **18.1 Address of initial connection**

#### **18.1.1 Calling endpoint**

If the network address of the destination is not already known, the calling endpoint may elicit the address of the initial channel connection by sending the SBE symbol NCA-i; this may be necessary following a Call Transfer, for example. The remote end is not obliged to divulge this information, which is sometimes kept "ex-directory" according to the user's wish; in this case, it should respond by sending NIR.

#### **18.1.2 Called endpoint**

A called endpoint may respond to NCA-i in one of two ways:

- using the SBE symbol sequence NIA-s;
- using the MBE message NIA-m: in this case, the calling endpoint must have included {MBE-cap} in its capability set.

### **18.2 Addresses of additional connections**

#### **18.2.1 Calling endpoint**

If the network addresses of potential additional channels at the destination are not already known, the calling endpoint may elicit these by sending the SBE symbol NCA-a; it then expects to receive NIS, NIC, NID, NIA-s, or NIA-m in reply. Such a request may be made after sequence A is complete, or at other times during the call, if necessary. If no reply is received, then the calling end may assume that additional-connection addresses have the relationship which is customary on that network, if known, or may take other appropriate action. For example, in some regions, 2B videotelephony is provided with identical addresses for both channels.

The called endpoint is not obliged to divulge the additional-channel full address, which may be "ex-directory" according to the user's wish; in this case, it should respond by sending NIR.

Any terminal which is able to recognize the symbol NIQ-s or NIQ-m shall not try to request additional connections without first obtaining the appropriate address(es); to do this, it shall first complete sequence A with Outcome I, then send one or more valid commands in force, then NCA-a, and then continue as specified in this Recommendation. When a valid response (NIA-s or NIA-m) is received, the information shall then be used in requesting any additional connections.

If no valid response is received within two seconds, NCA-a may be repeated; unless and until a valid response is received, the call shall remain as a 1B call.

NOTE – A terminal which is unable to respond to NCA-a but which is called via a supplementary service (diversion, transfer, etc.) will not advise the calling terminal how to address any request for additional connections; the calling terminal may then make such a request to the same address as for the initial connection, but in many circumstances the additional requests will be abortive and may even inconvenience

other users. Likewise, a calling terminal which is  $n \times B$  capable but cannot recognize NIQ is likely to attempt to set up additional channels in a way which could be abortive when supplementary services are invoked at the called end.

### 18.2.2 Called endpoint

A called endpoint, all the addresses of which are the same, shall be able to respond to receipt of NCA-a by returning the SBE symbol NIS (see Note).

A called endpoint which has consecutive addresses above that for the initial connection shall be able to respond to receipt of NCA-a by returning the SBE symbol NIC (see Note).

A called endpoint which has address for connection #2 the same as that for the initial connection, and pairs or connections on consecutive addresses above this, shall be able to respond to receipt of NCA-a by returning the SBE symbol NID (see Note).

A called endpoint which has different network addresses for its multiple ports, and these addresses cannot be conveyed by any of the SBE symbols NIS, NIC or NID, shall respond in one of two ways:

- using the SBE symbol sequence NIA-s;
- using the MBE message NIA-m: in this case, the calling endpoint must have included {MBE-cap} in its capability set.

In either case, the number of addresses conveyed by this message shall be consistent with the transfer-rate capability declared by that called endpoint.

NOTE – Terminals should always return the full address NIA-s or NIA-m; the reason for this is that if a terminal returns a differential address after a call transfer (etc.), then there are problems for the remote terminal. The differential address codes NIS, NIC, NID would not be valid in the case where an endpoint has been called on an initial connection only and as a result of a diversion from another address. Terminals which often receive transferred or diverted calls should always respond in this way and, in addition, may signal this situation to the calling endpoint using NIQ-s or NIQ-m, to avoid the latter attempting to obtain additional connections using the wrong addresses. Thus NIS, NIC, NID should only be used by MCUs and Channel Aggregators.

Such an endpoint may include either NIQ-s or NIQ-m in its capset at a position preceding the  $\{n \times B\}$  value. Having done so, it shall respond to NCA-a using NIA-s or NIA-m. The symbol NIQ-m may only be declared if MBE-cap is also declared; in this case, the terminal shall also be able to send and receive NIA-m.

A terminal having declared an NIQ in its capset, noted any NIQ in the incoming capset, and now having received NCA-a, shall respond as follows:

<i>Declaration in capset sent</i>	<i>Declaration in capset received</i>	<i>Action</i>
NIQ-s	NIQ-s or NIQ-m or none	message NIA-s
NIQ-m	NIQ-s (or NIQ-m but not MBE-cap)	message NIA-s
NIQ-m	both NIQ-m and MBE-cap	message NIA-m

### 18.2.3 Extension addresses

The SBE code TCS-4 (see [ITU-T H.230]) may be used to obtain a desired extension address (for example when dialling from ISDN into a LAN environment) in the form of an IIS string; the detailed procedure is for further study.

## **19 Informative codes**

### **19.1 Recommendation version identification**

The SBE code "1997 Recs." (see [ITU-T H.230]) may be transmitted after the completion of Sequence A (including at least one command following the last cap-mark) to identify the endpoint as conforming to the 1997 revised versions of [ITU-T H.221], [ITU-T H.230] and [ITU-T H.242].

### **19.2 Manufacturer/type identification**

The MBE message using the type-identifier <ident> (see Table 2 of [ITU-T H.230]) may be transmitted after the completion of Sequence A (including at least one command following the last cap-mark) to identify the manufacturer and other desired details. The format of this message is identical to that of "non-ITU capabilities" as exemplified in Appendix III, but the <ident> message shall not be included in a capability set and does not imply any non-standard capabilities.

## Appendix I

### Initialization: Case of videophone to Recommendation ITU-T H.320, type Xb

(This appendix does not form an integral part of this Recommendation)

This videophone is equipped with G.711, G.722 and G.728 audio codecs and capable of operating at  $2 \times 64$  kbit/s. Underlined letters in the comments column correspond to points in the associated Figure I.1.

**Table I.1 – Successive sub-multiframes at terminal "X" only (Initialization)**

Transmitted					Received					Comments
FAS, A-bit	BAS Attr.	Value	Audio mode	Video rate	FAS, A-bit	BAS Attr.	Value	Audio mode	Video rate	
xx	xx	xx	xx	xx	xx	Xx	xx	xx	xx	
F,1	(111)	[24]	0	(off)	xx	Xx	xx	xx	xx	<u>A</u> cap-mark
F,1	(100)	[5]	0	(off)	xx	xx	xx	xx	xx	Audio BAS-cap 1
F,1	(100)	[4]	0	(off)	xx	xx	xx	xx	xx	Audio BAS-cap 2
F,1	(101)	[20]	0	(off)	xx	xx	xx	xx	xx	Video Capability-H.261-QCIF
F,1	(101)	[24]	0	(off)	xx	xx	xx	xx	xx	MPI 3/29.97
F,1	(100)	[17]	0	(off)	xx	xx	xx	xx	xx	Transfer rate capability 2B
F,1	(111)	[24]	0	(off)	xx	xx	xx	xx	xx	Repeat capability set
F,1	(100)	[5]	0	(off)	xx	xx	xx	xx	xx	
(Continue to cycle caps)					(Searching for frame alignment)					About one transit?
F,1	(101)	[24]	0	(off)	xx	xx	xx	xx	xx	
F,1	(100)	[17]	0	(off)	F,1	[111]	[24]	0	(off)	<u>B</u> incoming capability set
F,1	(111)	[24]	0	(off)	F,1	(100)	[5]	0	(off)	...
F,1	(100)	[5]	0	(off)	F,1	(100)	[4]	0	(off)	...
F,1	(100)	[4]	0	(off)	F,1	(101)	[20]	0	(off)	...
F,1	(101)	[20]	0	(off)	F,1	(101)	[24]	0	(off)	...
F,1	(101)	[24]	0	(off)	F,1	(100)	[17]	0	(off)	...
F,1	(100)	[17]	0	(off)	F,1	(111)	[24]	0	(off)	Capability set complete
					(Searching for multiframe alignment)					up to 320 ms
F,0	(101)	[24]	0	(off)	F,1	(100)	[17]	0	(off)	<u>C</u> MFA achieved, A = 0
F,0	(100)	[17]	0	(off)	F,1	(111)	[24]	0	(off)	
					(Waiting for incoming A = 0)					
F,0	(100)	[17]	0	(off)	F,1	(111)	[24]	0	(off)	
F,0	(111)	[24]	0	(off)	F,0	(100)	[5]	0	(off)	<u>D</u> incoming A = 0
F,0	(100)	[5]	0	(off)	F,0	(100)	[4]	0	(off)	...
F,0	(100)	[4]	0	(off)	F,0	(101)	[20]	0	(off)	...
F,0	(101)	[20]	0	(off)	F,0	(101)	[24]	0	(off)	...

**Table I.1 – Successive sub-multiframes at terminal "X" only (Initialization)**

Transmitted					Received					Comments
FAS, A-bit	BAS Attr.	Value	Audio mode	Video rate	FAS, A-bit	BAS Attr.	Value	Audio mode	Video rate	
xx	xx	xx	xx	xx	xx	Xx	xx	xx	xx	
F,0	(101)	[24]	0	(off)	F,0	(100)	[17]	0	(off)	...
F,0	(100)	[17]	0	(off)	F,0	(111)	[24]	0	(off)	
F,0	(111)	[24]	0	(off)	F,0	(100)	[5]	0	(off)	Capability set complete
F,0	(000)	[29]	0	(off)	F,0	(100)	[4]	0	(off)	<u>E</u> start mode switch
F,0	(010)	[1]	7	(off)	F,0	(101)	[20]	0	(off)	(Note)
F,0	(000)	[29]	7	46.4	F,0	(101)	[24]	0	(off)	
F,0	(010)	[1]	7	46.4	F,0	(100)	[17]	0	(off)	
F,0	(000)	[29]	7	46.4	F,0	(111)	[24]	0	(off)	
F,0	(010)	[1]	7	46.4	F,0	(100)	[5]	0	(off)	
(Waiting for incoming mode changes)										
F,0	(010)	[1]	7	46.4	F,0	(101)	[24]	0	(off)	
F,0	(000)	[29]	7	46.4	F,0	(000)	[29]	0	(off)	<u>F</u> incoming switch
F,0	(010)	[1]	7	46.4	F,0	(010)	[1]	<u>7</u>	(off)	16 kbit/s audio
F,0	(000)	[29]	7	46.4	F,0	(000)	[29]	7	46.4	video ON
F,0	(010)	[1]	7	46.4	F,0	(010)	[1]	7	46.4	repeat valid commands in force
F,0	(000)	[29]	7	46.4	F,0	(000)	[29]	7	46.4	
(Now deal with second B-channel, once connection is completed)										
FF,01	(010)	[1]	7	46.4	Fx.0x	(000)	[29]	7	46.4	<u>G</u>
FF,01	(000)	[29]	7	46.4	Fx.0x	(010)	[1]	7	46.4	
(Searching for frame alignment on channel No. 2)										
FF,01	(010)	[1]	7	46.4	FF,01	(000)	[29]	7	46.4	<u>H</u> alignment recovered
FF,01	(000)	[29]	7	46.4	FF,01	(010)	[1]	7	46.4	
(Finding multiframe alignment and buffering to synchronize)										
FF,00	(010)	[1]	7	46.4	FF,01	(000)	[29]	7	46.4	<u>I</u> send A = 0 on channel No. 2
FF,00	(000)	[29]	7	46.4	FF,01	(010)	[1]	7	46.4	
(Waiting for incoming A <sub>2</sub> = 0)										
FF,00	(010)	[1]	7	46.4	FF,00	(000)	[29]	7	46.4	<u>J</u> incoming A <sub>2</sub> = 0
FF,00	(001)	[1]	7	46.4	FF,00	(010)	[1]	7	46.4	start mode switch to expand
FF,00	(001)	[1]	7	108.8	FF,00	(000)	[29]	7	46.4	video (Note)
FF,00	(010)	[1]	7	108.8	FF,00	(010)	[1]	7	46.4	
FF,00	(000)	[29]	7	108.8	FF,00	(000)	[29]	7	46.4	
FF,00	(001)	[1]	7	108.8	FF,00	(010)	[1]	7	46.4	

**Table I.1 – Successive sub-multiframes at terminal "X" only (Initialization)**

Transmitted					Received					Comments
FAS, A-bit	BAS Attr.	Value	Audio mode	Video rate	FAS, A-bit	BAS Attr.	Value	Audio mode	Video rate	
xx	xx	xx	xx	xx	xx	Xx	xx	xx	xx	
(Continue to cycle BAS commands)					(Waiting for incoming mode changes)					
FF,00	(010)	[1]	7	108.8	FF,00	(001)	[1]	7	46.4	<u>K</u> incoming mode switch
FF,00	(000)	[29]	7	108.8	FF,00	(001)	[1]	7	108.8	
(Initialization completed)										
NOTE – The modes selected for switching are governed by terminal procedures which, in general, depend on the application; in the present case of videophone service, the procedure is specified in [ITU-T H.320].										

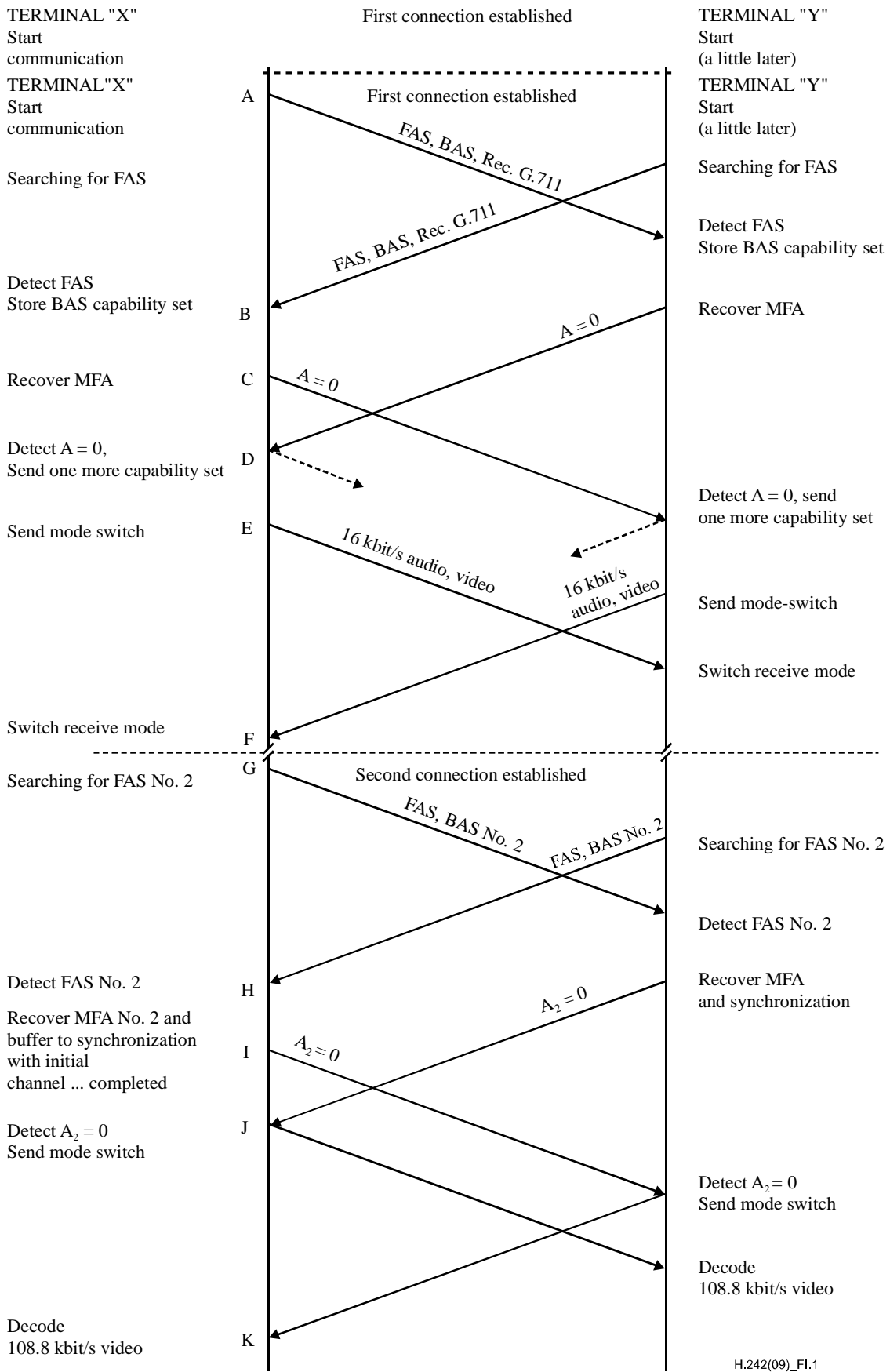

H.242(09)\_F1.1

**Figure I.1 – Initialization**

## Appendix II

### Mode-0 forcing: Case of videophone to Recommendation ITU-T H.320, type Xb

(This appendix does not form an integral part of this Recommendation)

This videophone is equipped with G.711, G.722 and G.728 audio codecs and capable of operating at  $2 \times 64$  kbit/s. Underlined letters in the comments column correspond to points in the associated Figure II.I.

**Table II.1 – Successive sub-multiframes at terminal "X" only (Mode-0 forcing)**

Transmitted					Received					Comments
FAS, A-bit	BAS Attr.	Value	Audio mode	Video rate	FAS, A-bit	BAS Attr.	Value	Audio mode	Video rate	
FF,00	(010)	[1]	7	107.6	FF,00	(000)	[29]	7	107.6	Video is ON [ITU-T H.261]
FF,00	(000)	[29]	7	107.6	FF,00	(001)	[1]	7	107.6	Audio is 16 kbit/s
FF,00	(001)	[1]	7	107.6	FF,00	(011)	[2]	7	107.6	Transfer rate is $2 \times 64$
FF,00	(011)	[2]	7	107.6	FF,00	(010)	[1]	7	107.6	Data is ON at 1.2 kbit/s
FF,00	(010)	[1]	7	107.6	FF,00	(000)	[29]	7	107.6	
FF,00	(011)	[0]	7	107.6	FF,00	(001)	[1]	7	107.6	<u>L</u> data to go off
FF,00	(010)	[0]	7	108.8	FF,00	(011)	[2]	7	107.6	Video to go off
FF,00	(001)	[0]	7	(off)	FF,00	(010)	[1]	7	107.6	Transfer rate 64 kbit/s
FF,00	(000)	[18]	7	(off)	FF,00	(000)	[29]	7	107.6	Audio A-law, 0F
FF,00	(000)	[18]	0F	(off)	FF,00	(001)	[1]	7	107.6	
FF,00	(010)	[0]	0F	(off)	FF,00	(011)	[2]	7	107.6	
FF,00	(000)	[18]	0F	(off)	FF,00	(010)	[1]	7	107.6	
FF,00	(111)	[24]	0F	(off)	FF,00	(000)	[29]	7	107.6	<u>M</u> capability mark
FF,00	(100)	[16]	0F	(off)	FF,00	(001)	[1]	7	107.6	64 kbit/s-capability only
FF,00	(100)	[1]	0F	(off)	FF,00	(011)	[2]	7	107.6	A-law capability only
FF,00	(111)	[24]	0F	(off)	FF,00	(010)	[1]	7	107.6	Capability mark
(continue to repeat this capset)					(Awaiting incoming mode change and capability set)					
FF,00	(100)	[16]	0F	(off)	FF,00	(000)	[29]	7	107.6	
FF,00	(100)	[1]	0F	(off)	FF,00	(011)	[0]	7	107.6	<u>N</u> incoming data to go off
FF,00	(111)	[24]	0F	(off)	FF,00	(010)	[0]	7	108.8	Incoming video to go off

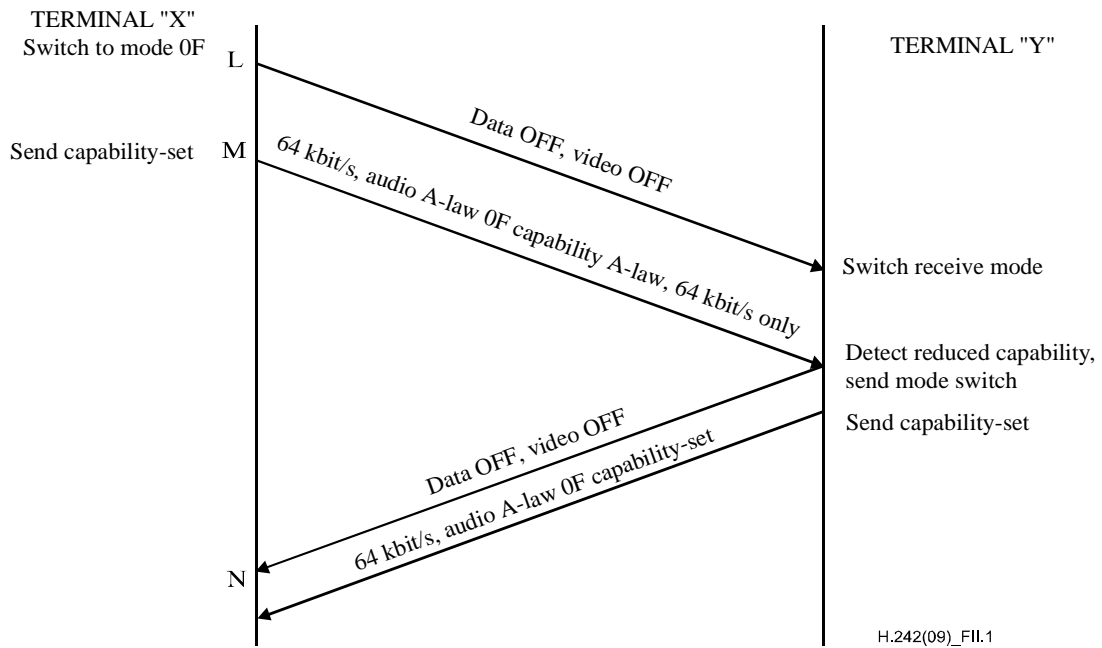

**Table II.1 – Successive sub-multiframes at terminal "X" only (Mode-0 forcing)**

Transmitted					Received					Comments
FAS, A-bit	BAS Attr.	Value	Audio mode	Video rate	FAS, A-bit	BAS Attr.	Value	Audio mode	Video rate	
FF,00	(010)	[0]	0F	(off)	FF,00	(001)	[0]	7	(off)	Incoming channel No. 2 off Incoming audio to be 0F
FF,00	(001)	[0]	0F	(off)	FF,00	(000)	[18]	7	(off)	
FF,00	(000)	[18]	0F	(off)	FF,00	(111)	[24]	0F	(off)	
FF,00	(011)	[0]	0F	(off)	FF,00	(100)	[5]	0F	(off)	
FF,00	(010)	[0]	0F	(off)	FF,00	(100)	[4]	0F	(off)	
FF,00	(001)	[0]	0F	(off)	FF,00	(101)	[20]	0F	(off)	
FF,00	(000)	[18]	0F	(off)	FF,00	(101)	[24]	0F	(off)	
FF,00	(011)	[0]	0F	(off)	FF,00	(100)	[17]	0F	(off)	
FF,00	(010)	[0]	0F	(off)	FF,00	(111)	[24]	0F	(off)	

(Continue to cycle all valid BAS commands in force)

The Mode 0 forcing procedure is not complete: subsequent action depends on the terminal procedure, according to the reason for performing the switch to Mode 0.



**Figure II.1 – Mode-0 forcing**

## Appendix III

### Example of use of message structure

(This appendix does not form an integral part of this Recommendation)

Send

Receive

#### III.1 Initial capability exchange, including MBE-cap

(111) [24] Capability-mark  
(100) [4] Audio type 2 ([b-ITU-T G.722], 56 kbit/s)  
(100) [17]  $2 \times 64$  kbit/s transfer rate  
(101) [21] H.261-CIF video capability  
(101) [22] 1/29.97 MPI for H.261-QCIF  
(101) [23] 2/29.97 MPI for H.261-CIF  
(101) [31] MBE-capability  
(111) [16] Set to escape table for HSD  
(101) [17] 64 kbit/s HSD-capability  
(111) [24] Capability-mark, repetition of capability set  
(100) [4] Audio type 2 ([b-ITU-T G.722], 56 kbit/s)  
... ..

Decode incoming BAS capabilities:  
these include (101) [31], so remote end  
can handle MBE codes

#### III.2 Subsequent capability exchange, including MBE capability message

(111) [24] Capability-mark  
(100) [4] Audio type 2 ([b-ITU-T G.722], 56 kbit/s)  
(100) [17]  $2 \times 64$  kbit/s transfer rate  
(101) [21] H.261-CIF video capability  
(101) [22] 1/29.97 MPI for H.261-QCIF  
(101) [23] 2/29.97 MPI for H.261-CIF  
(101) [31] MBE-capability  
(111) [16] Set to escape table for HSD  
(101) [17] 64 kbit/s HSD-capability  
(111) [30] Start of non-ITU-T capability message  
{M} Information will be M-bytes  
{byte 1} Country code according to Annex A of [b-ITU-T T.35]  
{byte 2} Country code assigned nationally, unless the first byte is 1111 1111, in which case  
this field shall contain the country code according to Annex B of [b-ITU-T T.35]

{bytes 3, 4} Manufacturer code (Company XYZ)  
{bytes 5-M} Type identity

Send Receive

(111) [24] Capability-mark, repetition of capability set

(100) [4] Audio type 2 ([b-ITU-T G.722], 56 kbit/s)

... ..

Incoming capability cycle now includes  
the same non-standard mode

### **III.3 Mode switch to non-standard mode using MBE command**

(111) [31] Start of non-ITU-T command message

{N} Information will be N-bytes

{byte 1} Country code according to Annex A of [b-ITU-T T.35]

{byte 2} Country code assigned nationally, unless the first byte is 1111 1111, in which case this field shall contain the country code according to Annex B of [b-ITU-T T.35]

{bytes 3, 4} Manufacturer code (Company XYZ)

{bytes 5-N} Type identity

The mode switch is effective from the sub-multiframe following that containing byte N.

## Appendix IV

### Examples of symmetrical and asymmetrical transmission modes

(This appendix does not form an integral part of this Recommendation)

#### IV.1 Example of symmetrical transmission mode

	Audio	Video	Transfer rate	LSD	HSD	MLP
Capabilities of Terminal X	16 kbit/s	Yes	1B	1.2 kbit/s	–	No
Capabilities of Terminal Y	Type 2 + 16 kbit/s	Yes	2B	1.2 kbit/s	–	Yes
Mode in X-to-Y direction	16 kbit/s	ON	1B	1.2 kbit/s	–	OFF
Mode in Y-to-X direction	16 kbit/s	ON	1B	1.2 kbit/s	–	OFF

#### IV.2 Example of asymmetrical transmission mode

	Audio	Video	Transfer rate	LSD	HSD	MLP
Capabilities of Terminal X	PCM	Yes	2B	1.2 kbit/s	No	No
Capabilities of Terminal Y	16 kbit/s	No	2B	56 kbit/s	No	No
Mode in X-to-Y direction	OFF	OFF	2B	56 kbit/s	–	OFF
Mode in Y-to-X direction	OFF	ON	2B	1.2 kbit/s	–	OFF

#### IV.3 Example of unsymmetrical video mode

	Audio	Video	Transfer rate	LSD	HSD	MLP
Capabilities of Terminal X	PCM	H.261, H.263, H.262S	2B	1.2 kbit/s	No	No
Capabilities of Terminal Y	PCM	H.261, H.263, H.262S	2B	1.2 kbit/s	No	No
Mode in X-to-Y direction	ON	H.262S	2B	1.2 kbit/s	–	OFF
Mode in Y-to-X direction	ON	H.263	2B	1.2 kbit/s	–	OFF

NOTE – Even though the video mode is unsymmetrical, in this specific example, the audio, video and data rates are symmetrical.

## Appendix V

### Examples relating to data transmissions

(This appendix does not form an integral part of this Recommendation)

NOTE – For the examples given below:

\* These rates are reduced by 800 bit/s when the ECS is active.

# "Video-on" may not be practical in these cases.

#### V.1 Transfer-rate 1B, audio at 48 kbit/s, no video or video off

MLP	LSD	Forbidden next commands (example)
4k	1200	#, LSD = 4.8k/6.4k/14.4k and over, MLP = 6.4k
4k	8k	Au = 56k, #, LSD = 4.8k/6.4k/14.4k and over
4k	var	#, LSD = 4.8k/6.4k/14.4k and over, MLP = var
6.4*k	8k	Au = 56k, #, LSD = 300/1200/4.8k/6.4k/9.6k/14.4k and over
var	1200	#, LSD = 16k and over/var, MLP = 6.4k
var	6.4k	#, LSD = 16k and over/var, MLP = 4k/6.4k
var	9.6k	Au = 56k, #, LSD = 16k and over/var, MLP = 6.4k

#### V.2 Transfer-rate 1B, audio at 16 kbit/s, no video or video off

MLP	LSD	Forbidden next commands (example)
4k	300	LSD = 4.8k/6.4k/14.4k/48k and over, MLP = 6.4k
4k	8k	Au = 56k, LSD = 4.8k/6.4k/14.4k/48k and over
4k	16k	Au = 48k/56k, #, LSD = 4.8k/6.4k/14.4k/48k and over
4k	var	#, LSD = 4.8k/6.4k/14.4k/48k and over, MLP = var
6.4*k	8k	Au = 56k, LSD = 300/1200/4.8k/6.4k/9.6k/14.4k/48k and over
6.4*k	40k	Au = 48k/56k, #, LSD = 300/1200/4.8k/6.4k/9.6k/14.4k/48k and over
var	4.8k	#, LSD = 48k and over/var, MLP = 4k/6.4k
var	9.6k	Au = 56k, #, LSD = 48k and over/var, MLP = 6.4k
var	16k	Au = 48k/56k, #, LSD = 48k and over/var

#### V.3 Transfer-rate 1B, audio at 16 kbit/s, video on

MLP	LSD	Forbidden next commands (example)
4k	1200	LSD = 4.8k/6.4k/14.4k/48k and over, MLP = 6.4k
4k	8k	Au = 56k, LSD = 4.8k/6.4k/14.4k/48k and over
6.4*k	8k	Au = 56k, LSD = 300/1200/4.8k/6.4k/9.6k/14.4k/48k and over

#### V.4 Transfer-rate 2B, audio at 48 kbit/s, video on

MLP	LSD	Forbidden next commands (example)
var	1200	LSD = 16k and over/var, MLP = 6.4k

var	4.8k	LSD = 16k and over/var, MLP = 4k/6.4k
var	9.6k	Au = 56k, LSD = 16k and over/var, MLP = 6.4k
4k	8k	Au = 56k, LSD = 4.8k/6.4k/14.4k/16k and over

### **V.5 Transfer-rate 2B, audio at 16 kbit/s, video on**

MLP	LSD	Forbidden next commands (example)
var	1200	LSD = 48k and over/var, MLP = 6.4k
var	4.8k	LSD = 48k and over/var, MLP = 4k/6.4k
var	8k	Au = 56k, LSD = 48k and over/var
var	16k	Au = 48k/56k, LSD = 48k and over/var
4k	8k	Au = 56k, LSD = 4.8k/6.4k/14.4k/48k and over

var Variable

LSD Low-speed data

HSD High-speed data

MLP Multi-layer-protocol

## Appendix VI

### Hierarchical capability BAS codes

(This appendix does not form an integral part of this Recommendation)

The following capability codes are hierarchically structured:

G.711 (A or  $\mu$  or both) < G.719  
G.711 (A or  $\mu$  or both) < G.722-64 < G.722-48  
G.711 (A or  $\mu$  or both) < G.722.1-24  
G.711 (A or  $\mu$  or both) < G.722.1-32  
G.711 (A or  $\mu$  or both) < G.722.1 Annex C-48  
G.711 (A or  $\mu$  or both) < G.722.1 Annex C-32  
G.711 (A or  $\mu$  or both) < G.722.1 Annex C-24  
G.711 (A or  $\mu$  or both) < G.723.1  
G.711 (A or  $\mu$  or both) < G.728  
G.711 (A or  $\mu$  or both) < G.729  
G.711 (A or  $\mu$  or both) < ISO/IEC 14496-3  
1B < 2B < 3B < 4B < 5B < 6B  
1H<sub>0</sub> < 2H<sub>0</sub> < 3H<sub>0</sub> < 4H<sub>0</sub> < 5H<sub>0</sub>  
H.261-QCIF < H.261-CIF  
4/29.97 < 3/29.97 < 2/29.97 < 1/29.97

The following H.262/H.263 capability codes are hierarchically structured:

H.263\_QCIF < H.263\_CIF < H.263\_4CIF < H.263\_16CIF when only standard formats are used.  
H.262\_SIF < H.262\_2SIF < H.262\_4SIF  
H.262S\_SIF < H.262M\_SIF  
H.262S\_2SIF < H.262M\_2SIF  
H.262S\_4SIF < H.262M\_4SIF  
MPI\_30 < MPI\_15 < MPI\_10 < MPI\_6 < MPI\_5 < MPI\_4 < MPI\_3 < MPI\_2 < MPI\_1

If a custom picture format is used within H.263, then the hierarchical rules described in clause 5.2.4 shall be used to derive the hierarchy. If a custom picture size is used in H.263, then its position in the hierarchy shall be immediately to the right of the "equivalent" standard resolution as defined in clause 5.2.4. For example:

H.263 QCIF < H.263 CIF < H.263 [176..528] × [144..432]

If a custom pixel aspect ratio (PAR) is supported for a standard format, then the standard PAR shall be supported for that format. If a custom PAR is supported for a custom format, then the standard PAR (12:11) shall be supported at the equivalent standard resolution. For example:

standard PAR for CIF < custom PAR for [176..528] × [144..432].

standard PAR for CIF size < custom PAR for CIF size.

If a minimum picture interval (MPI) with a custom picture clock frequency is used, then a better or equal MPI, measured in seconds for all equivalent and smaller standard resolutions at standard picture clock frequency (30 000/1001 or approx. 29.97 Hz), shall be supported.

For example:

1/29.97 Hz @ 29.97 Hz. < 1/25 Hz @ 25 Hz

The meaning of these expressions is that in every case a terminal having the capability to the right of a "<" sign shall also have the capability to the left thereof.

The capset shall conform to Table 53, which summarizes the capabilities that can be simultaneously valid, and shall not contain more than one item from any of the following groups:

G.722-64; G.722-48

1B; 2B; 3B; 4B; 5B; 6B

1H<sub>0</sub>; 2H<sub>0</sub>; 3H<sub>0</sub>; 4H<sub>0</sub>; 5H<sub>0</sub>

H.261-QCIF; H.261-CIF

If H.261-QCIF is included, it shall be followed immediately by one (only one) MPI value; if H.261-CIF is transmitted, it shall be followed by two MPI values. It is permitted to send both A-law and  $\mu$ -law audio capabilities.



## Appendix VII

### Interpretation of received audio capability BAS codes

(This appendix does not form an integral part of this Recommendation)

If the following BAS codes are received, then the local terminal understands that the remote terminal can decode:

1)	no audio capability	both A-law and $\mu$ -law
2)	G.711-A and G.711- $\mu$	both A-law and $\mu$ -law
3)	G.711-A	A-law only
4)	G.711- $\mu$	$\mu$ -law only
5)	G.722-48 only	G.722 (Modes 1, 2, and 3) and A-law and $\mu$ -law
6)	G.722-48 and G.711-A and G.711- $\mu$	G.722 (Modes 1, 2, and 3) and A-law and $\mu$ -law
7)	G.722-48 and G.711-A	G.722 (Modes 1, 2, and 3) and A-law
8)	G.722-48 and G.711- $\mu$	G.722 (Modes 1, 2, and 3) and $\mu$ -law

Either of 1 or 2 is allowed and the terminal should be able to correctly interpret both cases. The same is true for the case of 5 or 6.

## Appendix VIII

### Examples of legal and illegal capability BAS sequences

(This appendix does not form an integral part of this Recommendation)

To be clear about legal and illegal capability BAS sequences, it may be appropriate to quote the following examples (A1, A2 represent audio capabilities):

#### Allowed:

{cap-mark, A1, A2, H.261-QCIF, 2/29.97} cap-mark  
{cap-mark, A1, A2, H.261-QCIF, 2/29.97} {repeat} {repeat} ..... {repeat} cap-mark  
{cap-mark, A1, A2, H.261-QCIF, 2/29.97} cap-mark; command; {cap-mark, A1, A2, H.261-QCIF, 2/29.97, 2B} cap-mark  
{cap-mark, neutral} cap-mark  
{cap-mark, A1, H.261\_CIF, 2/29.97, start-MBE, 3, <H.262/H.263>, H.263\_CIF+MPI\_2+Options, AC} cap-mark  
{cap-mark, A1, H.261\_CIF, 2/29.97, start-MBE, 3, <H.262/H.263>, H.263\_CIF+MPI\_2, H.262\_SIF+MPI\_2} cap-mark

#### Not allowed:

{cap-mark, A1, A2, H.261-QCIF, 2/29.97}; command  
(*final cap-mark missing*)  
{cap-mark, A1, A2, H.261-QCIF, 2/29.97} {repeat} {repeat}; command  
(*final cap-mark missing*)  
{cap-mark, A1, A2, A1, H.261-QCIF, 2/29.97} cap-mark  
(*repeated value*)  
{cap-mark, neutral}; command  
(*final cap-mark missing*)  
command; neutral; command  
(*both cap-marks missing*)  
{cap-mark, A1, A2, H.261-QCIF, 2/29.97}  
cap-mark {cap-mark A1, A2, H.261-QCIF, 2/29.97, 2B} cap-mark  
(*changed capset without command between*)  
{cap-mark, A1, A2, H.261-QCIF, 1/29.97, 2/29.97} cap-mark  
(*two MPI values*)  
{cap-mark, A1, A2, H.261-CIF, 2/29.97} cap-mark  
(*one MPI value*)  
cap-mark, cap-mark  
(*no capabilities*)  
command; {A1, A2, H.261-QCIF, 2/29.97}; command  
(*no cap-marks*)  
{cap-mark, A1, start-MBE, 2, H.262/H.263, H.263\_CIF+MPI\_2} cap-mark  
(*no H.261 capabilities*)  
{cap-mark, A1, H.261\_QCIF, 2/29.97, start-MBE, 2, H.262/H.263, H.262\_SIF+MPI\_2} cap-mark  
(*no H.263 capabilities*)

{cap-mark, A1, H.261\_CIF, 2/29.97, 1/29.97, start-MBE, 3, H.262/H.263, H.262\_SIF+MPI\_2, H.263\_QCIF+MPI\_2} cap-mark  
(no H.263\_CIF capability when H.262\_SIF capability is present. Additionally H.262 capability is given before H.263. See clause 5.2.2)

{cap-mark, A1, H.261\_CIF, 2/29.97, 1/29.97, start\_MBE, 3, H.262/H.263, H.263\_CIF+MPI\_4, H.262\_SIF+MPI\_2} cap-mark  
(H.263 CIF MPI is larger than H.262 SIF MPI)

{cap-mark, A1, H.261\_CIF, 2/29.97, 1/29.97, start\_MBE, 8, H.262/H.263, H.263\_CIF+MPI\_4, H.262\_SIF+MPI\_2, extension codeword, H.263\_CIF + No additional H.263 capabilities, H.263\_QCIF + deblock filter} cap-mark  
(No initial H.263 capabilities specified for QCIF)

{cap-mark, A1, H.261\_CIF, 2/29.97, 1/29.97, start\_MBE, 10, H.262/H.263, H.263\_4CIF+MPI\_4, H.263\_CIF + MPI\_4, extension codeword, H.263\_4CIF + No additional H.263 capabilities, H.263\_CIF + MPI\_4 + No additional H.263 capabilities, H.263 @ 528 × 432 + H.263 Profiles – level 1.} cap-mark  
(H.263 @ 528 × 432 capset should be positioned between H.263\_CIF and H.263\_4CIF capset)

## Appendix IX

(This appendix does not form an integral part of this Recommendation)

NOTE – Table IX.1 is a partial list of BAS control and indication codes (see also [ITU-T H.221] and [ITU-T H.230]).

**Table IX.1 – BAS control and indication codes**

BAS C&I	Code (Note 1)	Notes	Command name (Note 2)	Comments
AIA	(000) [3]	r	Audio Indicate Active	Complementary to AIM
AIM	(000) [2]	r	Audio Indicate Muted	No audio or tone generated
CCA	(010) [4]	n	Chair Command Acquire	Request T <sub>CC</sub>
CCD	(010) [1]	n, E <sub>S</sub>	Chair Command Disconnect	Drop terminal SBE-num
CCK	(010) [3]	n	Chair Command Kill	Drop all terminals from the conference
CCR	(010) [6]	n	Chair Command Release/Refuse	Withdraw T <sub>CC</sub>
CIR	(010) [2]	n	Chair Indicate Release/Refuse	Used by MCU to refuse CCD
CIS	(010) [7]	n	Chair Indicate Stopped-using-token	Chair frees T <sub>CC</sub>
CIT	(010) [5]	r	Chair Indicate Token	Assign T <sub>CC</sub>
DCA-H	(010) [24]	n, E <sub>S</sub>	Data Command Acquire HSD	Request HSD token with rate from Table 3 of [ITU-T H.243]
DCA-L	(010) [16]	n, E <sub>S</sub>	Data Command Acquire LSD	Request LSD token with rate from Table 3 of [ITU-T H.243]
DCC-H	(010) [28]	n	Data Command Close	Free T <sub>H</sub> and close channel
DCC-L	(010) [20]	n	Data Command Close	Free T <sub>L</sub> and close channel
DCIP	(010) [13]	r	Do continuous independent progressions	Request progressive refinement of consecutive frames starting with intra frame in H.263
DCP	(010) [11]	r	Do continuous progressions	Request progressive refinement of consecutive frames in H.263
DCR-H	(010) [26]	n	Data Command Release/Refuse	Withdraw/refuse assignment of T <sub>H</sub>
DCR-H	(010) [26]	n	Data Command Release	Sent by chair to cause withdrawal of T <sub>H</sub>
DCR-L	(010) [18]	n	Data Command Release/Refuse LSD	Withdraw/refuse assignment of T <sub>L</sub>
DCR-L	(010) [18]	n	Data Command Release	Sent by chair to cause withdrawal of T <sub>L</sub>
DIS-H	(010) [27]	n	Data Indicate Stopped-using-token	Free T <sub>H</sub>
DIS-L	(010) [19]	n	Data Indicate Stopped-using-token	Free T <sub>L</sub>

**Table IX.1 – BAS control and indication codes**

BAS C&I	Code (Note 1)	Notes	Command name (Note 2)	Comments
DIT-H	(010) [25]	r	Data Indicate Token	Give T <sub>H</sub>
DIT-L	(010) [17]	r	Data Indicate Token	Give T <sub>L</sub>
DOIP	(010) [12]	r	Do one independent progression	Request progressive refinement of one frame starting with intra frame in H.263
DOP	(010) [10]	r	Do one progression	Request progressive refinement of one frame in H.263
IIS	0000 0011	n, E <sub>M</sub>	Information Indicate String	Sent in response to TCS-n
LCA	(010) [18]	FFS	Loopback Command Audio	Audio loop request
LCD	(010) [20]	FFS, n	Loopback Command Digital	Digital loop request
LCO	(010) [21]	r	Loopback Command Off	Disconnect all loopbacks
LCV	(010) [19]	FFS	Loopback Command Video	Video loop request
MCC	(001) [0]	r	Multipoint Command Conference	Terminal must slave to MCU
cancel-MCC	(001) [1]	r	Cancel Multipoint Command Conference	Terminal may initiate mode changes, etc.
MCN	(001) [21]	r	Multipoint Command Negating	Undo MCS
MCS	(001) [20]	r	Multipoint Command Symmetrical	Request Symmetrical-Data-Transmission
MCV	(001) [16]	r	Multipoint Command Visualize	Forces broadcast of video terminals
cancel-MCV	(001) [17]	r	Cancel Multipoint Command Visualize	Revert to voice activated video switching
MIL	(001) [31]	n, E <sub>S</sub>	Multipoint Indicate Loop	For loopback detection by MCU
MIM	(001) [6]	r	Multipoint Indicate Master	Sent by MCU claiming master role
MIS	(001) [4]	r	Multipoint Indication Secondary-status	Terminal is secondary
cancel-MIS	(001) [5]	r	Cancel Multipoint Indicate Secondary-status	Term is primary
MIV	(001) [18]	r	Multipoint Indicate Visualize	On-air
cancel-MIV	(001) [19]	r	Cancel Multipoint Indicate Visualize	Not on-air
MIZ	(001) [2]	r	Multipoint Indicate Zero	First/last terminal in conference
cancel-MIZ	(001) [3]	r	Cancel Multipoint Indicate Zero	Cancel MIZ indication
MMS	(001) [28]	r	Multipoint Mode Symmetry	Request symmetrical audio/video mode

**Table IX.1 – BAS control and indication codes**

<b>BAS C&amp;I</b>	<b>Code (Note 1)</b>	<b>Notes</b>	<b>Command name (Note 2)</b>	<b>Comments</b>
cancel-MMS	(001) [29]	r	Cancel Multipoint Mode Symmetry	Revert to asymmetrical audio/video mode
MVA	(010) [13]	n	Multipoint Visualization Achieved	Visualization granted in response to MCV
MVR	(010) [14]	n	Multipoint Visualization Refused/Revoked	Visualization refused or revoked in response to MCV or cancel-MCV
PRAC	(010) [15]	r	Progressive refinement abort continuous	Terminate progressive refinements
PRAO	(010) [14]	r	progressive refinement abort one	Terminate current frame refinements
RAN	(001) [9]	E <sub>S</sub>	Random number	Master/slave contention resolution
TCA	(001) [15]	n	Token Command Association	Request list of token owners
TCI	(000) [8]	n	Terminal Command Identify	Request TII+SBE-NUM+TIS information
TCP	(011) [4]	n, E <sub>S</sub>	Terminal Command Personal-identifier	Request identity string gathered by TCS-2 specified by terminal number
TCS-1	(011) [1]	n	Terminal Command String-One	Request IIS MBE containing password
TCS-2	(011) [2]	n	Terminal Command String-Two	Request IIS MBE containing term ID
TCS-3	(011) [3]	n	Terminal Command String-Three	Request IIS MBE for conference ID
TCU	(001) [14]	n	Terminal Command Update	Terminal requests assigned terminal numbers
TIA	(001) [11]	r, E <sub>S</sub>	Terminal Indicate Assign	Assign terminal number
TID	(001) [13]	n, E <sub>S</sub>	Terminal Indicate Dropped	Terminal dropped out
TIF	(010) [8]	n, E <sub>S</sub>	Terminal Indicate Floor	Terminal requests floor from MCU
TII	(000) [9]	n, E <sub>S</sub>	Terminal Indicate Identity	Precedes each terminal id string SBE
TIL	0000 0010	n, E <sub>M</sub>	Terminal Indicate List	Transmit list of terminal numbers
TIN	(001) [12]	n, E <sub>S</sub>	Terminal Indicate Number	MCU informs term of assigned terminal number
TIP	0000 0100	n, E <sub>M</sub>	Terminal Indicate Personal-identifier	Response to TCP
TIR	0000 0101	n, E <sub>M</sub>	Token Indicate Response	Response to TCA
TIS	(000) [10]	n	Terminal Indicate identity-Stop	End of TII coded terminal id string

**Table IX.1 – BAS control and indication codes**

<b>BAS C&amp;I</b>	<b>Code (Note 1)</b>	<b>Notes</b>	<b>Command name (Note 2)</b>	<b>Comments</b>
TIX	(001) [8]	r, E <sub>S</sub>	Terminal Indicate additional-channel-X	Associate additional channel with term's TIA
VCB	(001) [23]	r, E <sub>S</sub>	Video Command Broadcast	Chair forces broadcasting
cancel-VCB	(001) [24]	r	Cancel Video Command Broadcast	Revert to Voice Activated Switching
VCF	(010) [16]	FFS	Video Command Freeze picture request	Freeze video prior to switch
VCR	(001) [27]	n	Video Command Reject	Reject terminal command
VCS	(001) [25]	r	Video Command Select	Select viewed party
cancel-VCS	(001) [26]	r	Cancel Video Command Select	Undo select viewed party, revert to BAS
VCU	(010) [17]	n	Video command fast update request	Update video after switch
VIA	(000) [17]	r	Video Indicate Active	Video Source "One" is active
VIA2	(000) [18]	r	Video Indicate Active	Video Source "Two" is active
VIA3	(000) [19]	r	Video Indicate Active	Video Source "Three" is active
VIN	(001) [22]	r	Video Indicate Number	Identifies video source
VIR	(000) [31]	r	Video Indicate Ready-to-activate	Will do video if far end does
VIS	(000) [16]	r	Video Indicate Suppressed	No video input available. Complementary to VIA
<p>NOTE 1 – The bit coding for each BAS code is represented as (b0, b1, b2) [d3-7], where d3-7 is the decimal value of b3, b4, b5, b6, b7. For BAS codes using start-MBE, this column specifies the MBE type identification byte.</p> <p>NOTE 2 – The letters in this column have the following meaning:</p> <p>r      Should be included in repeating command set.</p> <p>n      Not included in repeating command set.</p> <p>E<sub>S</sub>    One or more SBE codes follow this BAS code as defined in [ITU-T H.230].</p> <p>E<sub>M</sub>    Uses start-MBE as defined in [ITU-T H.230].</p>				

## Appendix X

### An algorithm to determine whether an incoming bit stream was encoded by $\mu$ -law or A-law PCM

(This appendix does not form an integral part of this Recommendation)

This appendix gives information concerning a method to determine the PCM coding law from the observation of the incoming bit streams. It should be used in the absence of other indications regarding the PCM coding law.

#### X.1 Basic determination algorithm

The following algorithm determines whether an incoming bit stream was encoded by  $\mu$ -law or A-law PCM. The algorithm comprises two stages:

- i) data accumulation;
- ii) decision.

A decision can be made after data has been accumulated for 10 ms or longer. Decisions can be produced several times with an increasing amount of accumulated data. The period in which data is accumulated is called the test period.

#### Data accumulation

For each incoming sample, observe the combination in bits 2, 3 and 4. (Bit 1 is defined as the most significant bit. Bits 2, 3 and 4 are the segment number, as defined in [b-ITU-T G.711]). Count the number of occurrences of each segment number throughout the test period. That is, obtain 8 numbers corresponding to the numbers of occurrences of each of the possible combinations.

#### Decision

- 1) Place the counters as illustrated in the  $\mu$ -law column of Figure X.1. If there is a counter that contains a number greater than zero above a counter that contains zero, then the  $\mu$ -law hypothesis is "improbable".
- 2) Place the counters as illustrated in the A-law column of Figure X.1 (the arrangement in the figure includes even-bit inversion, specified in [b-ITU-T G.711]). If there is a counter that contains a number greater than zero above a counter that contains zero, then the A-law hypothesis is "improbable".
- 3) If only one coding law hypothesis is probable, decide accordingly.
- 4) If neither coding law hypothesis is probable, the test period was too short. Obtain more data, then repeat the decision process.
- 5) If both coding laws are probable, then select a counter to represent each coding law according to the following:
  - if all 8 counters contain numbers greater than 0, then counter 000 represents  $\mu$ -law, and counter 010 represents A-law;
  - if 4 counters contain numbers greater than 0, then counter 100 represents  $\mu$ -law, and counter 110 represents A-law.

Compare the numbers in the two representative counters. Decide on the coding law represented by the counter containing the smaller number.



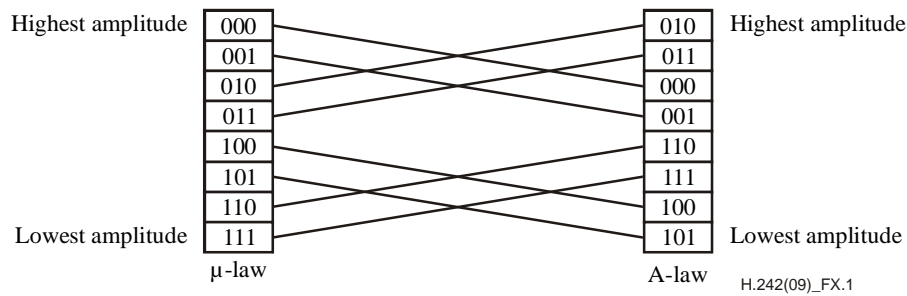

**Figure X.1 – Order of segments according to amplitude,  $\mu$ -law and A-law PCM**

## X.2 Possible extensions and refinements

The list below specifies some possible extensions to the algorithm. These extensions may be used to produce a result based on additional data. The exact way one might use this data is beyond the scope of this appendix.

- i) It is possible to obtain separate counts for positive and negative samples, i.e., take into consideration bit 1 (sign bit) of the samples.
- ii) It is possible to define a threshold other than zero for consideration of a non-zero counter (i.e., consider all counters that contain numbers less than the threshold as if they contained zero). This extension may be useful in preventing spurious bit errors from affecting the decision.
- iii) The decision criterion in step 5 of clause X.1 is less robust than that of step 3. The following enhancements to step 5 may be considered:
  - in order to avoid an erroneous decision because of close valued numbers when the step 5 criterion is employed, it is possible to require that the difference between numbers in the two representative counters exceed a certain threshold. Alternatively, (taking the above suggestion to the extreme), it is possible not to decide at all according to the step 5 criterion, and to discard the data if both coding laws produce allowed distributions;
  - it is possible to represent each coding law with two counters, rather than one. In case of 8 non-zero counters, counter 001 (for  $\mu$ -law) is compared against counter 011 (for A-law), in addition to the comparison given in the algorithm. In case of 4 non-zero counters, counter 101 (for  $\mu$ -law) is compared against counter 111 (for A-law), in addition to the comparison given in the algorithm. It is also possible to use the sum of the two representative counters of each coding law in a comparison.

## Bibliography

- [b-ITU-T G.711] Recommendation ITU-T G.711 (1988), *Pulse code modulation (PCM) of voice frequencies.*
- [b-ITU-T G.722] Recommendation ITU-T G.722 (1988), *7 kHz audio-coding within 64 kbit/s.*
- [b-ITU-T G.722.1] Recommendation ITU-T G.722.1 (2005), *Low-complexity coding at 24 and 32 kbit/s for hands-free operation in systems with low frame loss.*
- [b-ITU-T G.723.1] Recommendation ITU-T G.723.1 (2006), *Dual rate speech coder for multimedia communications transmitting at 5.3 and 6.3 kbit/s.*
- [b-ITU-T G.728] Recommendation ITU-T G.728 (1992), *Coding of speech at 16 kbit/s using low-delay code excited linear prediction (CS-ACELP).*
- [b-ITU-T G.729] Recommendation ITU-T G.729 (2007), *Coding of speech at 8 kbit/s using conjugate-structure algebraic-code-excited linear prediction.*
- [b-ITU-T H.320] Recommendation ITU-T H.320 (2004), *Narrow-band visual telephone systems and terminal equipment.*
- [b-ITU-T I.464] Recommendation ITU-T I.464 (1999), *Multiplexing, rate adaption and support of existing interfaces for restricted 64 kbit/s transfer capability.*
- [b-ITU-T Q.931] Recommendation ITU-T Q.931 (1998), *ISDN user-network interface layer 3 specification for basic call control.*
- [b-ITU-T T.35] Recommendation ITU-T T.35 (2000), *Procedure for the allocation of ITU-T defined codes for non-standard facilities.*
- [b-ITU-T V.110] Recommendation ITU-T V.110 (2000), *Support by an ISDN of data terminal equipments with V-series type interfaces.*
- [b-ISO/IEC 13871] ISO/IEC 13871:1995, *Information technology – Telecommunications and information exchange between systems – Private telecommunications networks – Digital channel aggregation.*



## SERIES OF ITU-T RECOMMENDATIONS

Series A	Organization of the work of ITU-T
Series D	General tariff principles
Series E	Overall network operation, telephone service, service operation and human factors
Series F	Non-telephone telecommunication services
Series G	Transmission systems and media, digital systems and networks
<b>Series H</b>	<b>Audiovisual and multimedia systems</b>
Series I	Integrated services digital network
Series J	Cable networks and transmission of television, sound programme and other multimedia signals
Series K	Protection against interference
Series L	Construction, installation and protection of cables and other elements of outside plant
Series M	Telecommunication management, including TMN and network maintenance
Series N	Maintenance: international sound programme and television transmission circuits
Series O	Specifications of measuring equipment
Series P	Terminals and subjective and objective assessment methods
Series Q	Switching and signalling
Series R	Telegraph transmission
Series S	Telegraph services terminal equipment
Series T	Terminals for telematic services
Series U	Telegraph switching
Series V	Data communication over the telephone network
Series X	Data networks, open system communications and security
Series Y	Global information infrastructure, Internet protocol aspects and next-generation networks
Series Z	Languages and general software aspects for telecommunication systems