



INTERNATIONAL TELECOMMUNICATION UNION

ITU-T

TELECOMMUNICATION
STANDARDIZATION SECTOR
OF ITU

G.842

(04/97)

SERIES G: TRANSMISSION SYSTEMS AND MEDIA,
DIGITAL SYSTEMS AND NETWORKS

Digital transmission systems – Digital networks – SDH
network characteristics

**Interworking of SDH network protection
architectures**

ITU-T Recommendation G.842

(Previously CCITT Recommendation)

ITU-T G-SERIES RECOMMENDATIONS
TRANSMISSION SYSTEMS AND MEDIA, DIGITAL SYSTEMS AND NETWORKS

INTERNATIONAL TELEPHONE CONNECTIONS AND CIRCUITS	G.100–G.199
INTERNATIONAL ANALOGUE CARRIER SYSTEM	
GENERAL CHARACTERISTICS COMMON TO ALL ANALOGUE CARRIER-TRANSMISSION SYSTEMS	G.200–G.299
INDIVIDUAL CHARACTERISTICS OF INTERNATIONAL CARRIER TELEPHONE SYSTEMS ON METALLIC LINES	G.300–G.399
GENERAL CHARACTERISTICS OF INTERNATIONAL CARRIER TELEPHONE SYSTEMS ON RADIO-RELAY OR SATELLITE LINKS AND INTERCONNECTION WITH METALLIC LINES	G.400–G.449
COORDINATION OF RADIOTELEPHONY AND LINE TELEPHONY	G.450–G.499
TRANSMISSION MEDIA CHARACTERISTICS	
DIGITAL TRANSMISSION SYSTEMS	
TERMINAL EQUIPMENTS	G.700–G.799
DIGITAL NETWORKS	G.800–G.899
General aspects	G.800–G.809
Design objectives for digital networks	G.810–G.819
Quality and availability targets	G.820–G.829
Network capabilities and functions	G.830–G.839
SDH network characteristics	G.840–G.849
Telecommunications management network	G.850–G.859
DIGITAL SECTIONS AND DIGITAL LINE SYSTEM	G.900–G.999
General	G.900–G.909
Parameters for optical fibre cable systems	G.910–G.919
Digital sections at hierarchical bit rates based on a bit rate of 2048 kbit/s	G.920–G.929
Digital line transmission systems on cable at non-hierarchical bit rates	G.930–G.939
Digital line systems provided by FDM transmission bearers	G.940–G.949
Digital line systems	G.950–G.959
Digital section and digital transmission systems for customer access to ISDN	G.960–G.969
Optical fibre submarine cable systems	G.970–G.979
Optical line systems for local and access networks	G.980–G.999

For further details, please refer to ITU-T List of Recommendations.

ITU-T RECOMMENDATION G.842

INTERWORKING OF SDH NETWORK PROTECTION ARCHITECTURES

Summary

This Recommendation provides specifications for the interworking of network protection architectures. Specifically covered are single and dual node interconnection between MS-shared protection rings and SNCP rings of like or unlike types.

Source

ITU-T Recommendation G.842 was prepared by ITU-T Study Group 15 (1997-2000) and was approved under the WTSC Resolution No. 1 procedure on the 8th of April 1997.

FOREWORD

ITU (International Telecommunication Union) is the United Nations Specialized Agency in the field of telecommunications. The ITU Telecommunication Standardization Sector (ITU-T) is a permanent organ of the ITU. The ITU-T is responsible for studying technical, operating and tariff questions and issuing Recommendations on them with a view to standardizing telecommunications on a worldwide basis.

The World Telecommunication Standardization Conference (WTSC), which meets every four years, establishes the topics for study by the ITU-T Study Groups which, in their turn, produce Recommendations on these topics.

The approval of Recommendations by the Members of the ITU-T is covered by the procedure laid down in WTSC Resolution No. 1.

In some areas of information technology which fall within ITU-T's purview, the necessary standards are prepared on a collaborative basis with ISO and IEC.

NOTE

In this Recommendation, the expression "Administration" is used for conciseness to indicate both a telecommunication administration and a recognized operating agency.

INTELLECTUAL PROPERTY RIGHTS

The ITU draws attention to the possibility that the practice or implementation of this Recommendation may involve the use of a claimed Intellectual Property Right. The ITU takes no position concerning the evidence, validity or applicability of claimed Intellectual Property Rights, whether asserted by ITU members or others outside of the Recommendation development process.

As of the date of approval of this Recommendation, the ITU had/had not received notice of intellectual property, protected by patents, which may be required to implement this Recommendation. However, implementors are cautioned that this may not represent the latest information and are therefore strongly urged to consult the TSB patent database.

© ITU 1997

All rights reserved. No part of this publication may be reproduced or utilized in any form or by any means, electronic or mechanical, including photocopying and microfilm, without permission in writing from the ITU.

CONTENTS

	Page
1	Scope..... 1
2	References..... 1
3	Terms and definitions 1
4	Abbreviations..... 3
5	Interworking criteria/objectives..... 4
5.1	Criteria for ring interworking with an MS-shared protection ring..... 4
6	Interworking architectures 5
6.1	Single node interconnection..... 5
6.2	Dual node interconnection 5
6.2.1	Generalized architecture 5
6.2.2	Ring interworking with an MS-shared protection ring..... 7
6.2.3	Ring interworking with an SNCP ring..... 21
6.2.4	Multiple rings 32
7	Interworking among network layers..... 32
8	Switch contention 32

Recommendation G.842

INTERWORKING OF SDH NETWORK PROTECTION ARCHITECTURES

(Geneva, 1997)

1 Scope

This Recommendation describes mechanisms for interworking between network protection architectures. The network protection architectures are described in Recommendation G.841. Interworking is described for single and dual node interconnection for exchanging traffic between rings. Each ring may be configured for MS-shared protection or for SNCP protection.

2 References

The following ITU-T Recommendations, and other references contain provisions which, through reference in this text, constitute provisions of this Recommendation. At the time of publication, the editions indicated were valid. All Recommendations and other references are subject to revision; all users of this Recommendation are therefore encouraged to investigate the possibility of applying the most recent edition of the Recommendations and other references listed below. A list of the currently valid ITU-T Recommendations is regularly published.

- ITU-T Recommendation G.803 (1997), *Architecture of transport networks based on the Synchronous Digital Hierarchy (SDH)*.
- ITU-T Recommendation G.841 (1995), *Types and characteristics of SDH network protection architectures*.
- ITU-T Recommendation G.783 (1997), *Characteristics of Synchronous Digital Hierarchy (SDH) equipment functional blocks*.

3 Terms and definitions

NOTE – These definitions need to be reviewed with respect to the emerging Recommendation on SDH vocabulary.

This Recommendation defines the following terms.

- 3.1 drop-and-continue:** A function within a ring node where traffic is both extracted from the working channels on the ring (drop), and transmitted onwards on the ring (continue).
- 3.2 dual hubbed:** Dual hubbed traffic can be routed to either or both of two central offices (or similar sites). Dual hubbed traffic is survivable under a failure of one of the two hubs.
- 3.3 dual node interconnection:** An architecture between two rings where two nodes in each ring are interconnected.
- 3.4 hold-off time:** The time that a protection switch controller waits after detecting a failure before initiating the switch.
- 3.5 path selector:** Within an SNCP architecture, the node function that selects a tributary which is extracted from the working channels arriving from one side of the node or from the other side of the node, according to path level criteria.
- 3.6 primary node:** Within an MS-shared protection ring interworking architecture, the node which provides the service selection and drop-and-continue functions for a tributary. Different tributaries may have different designated primary nodes.

- 3.7 propagation of switching:** One protection switch leading to another. Propagation of switching is often, though not always, undesirable from a maintenance point of view.
- 3.8 ring interconnection:** An architecture between two rings where one or more nodes in each ring are interconnected.
- 3.9 ring interworking:** A network topology whereby two rings are interconnected at two nodes on each ring, and the topology operates such that a failure at either of these two nodes will not cause loss of any working traffic. This is illustrated in Figure 1.
- 3.10 secondary circuit:** Within an MS-shared protection ring interworking architecture, this is the alternate routing that traffic travelling from one ring to another follows. This alternate additional routing is used when the service circuit is interrupted.
- 3.11 secondary node:** Within an MS-shared protection ring interworking architecture, the node which provides the alternate interworking route for a tributary.
- 3.12 service circuit:** Within an MS-shared protection ring interworking architecture, this is the preferred original routing that traffic travelling from one ring to another normally follows.
- 3.13 service selector:** Within an MS-shared protection ring architecture, the node function used for ring interworking. It selects traffic from either the channels arriving from one side of the node, or from traffic entering the ring, according to some criteria.
- 3.14 single node interconnection:** An architecture between two rings where one node in each ring is interconnected.
- 3.15 termination node:** The node (other than a primary or secondary node) where a tributary enters or exits the ring.

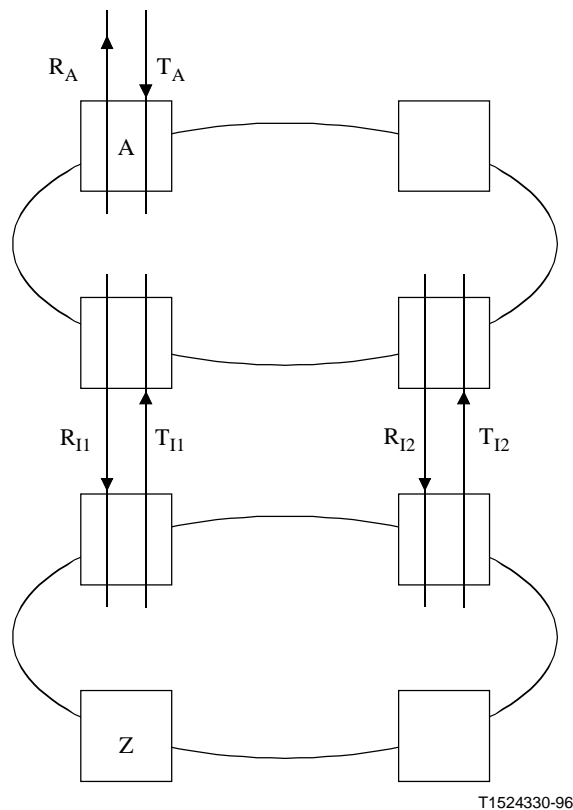

Failure free state (from perspective of top ring)

$$\begin{aligned}
 R_{I1} &= R_{I2} = T_A \\
 R_A &= T_{I1} \text{ or } T_{I2} \\
 T_{I1} &= T_{I2}
 \end{aligned}$$

Figure 1/G.842 – Generalized ring interworking

4 Abbreviations

This Recommendation uses the following abbreviations:

ADM	Add/Drop Multiplexer
AIS	Alarm Indication Signal
AU	Administrative Unit
HO	Higher Order
HP	Higher order Path
HPC	Higher order Path Connection
HPOM	Higher order Path Overhead Monitor
LO	Lower Order
LOF	Loss of Frame
LOP	Loss of Pointer
LOS	Loss of Signal
LPC	Lower order Path Connection
LPOM	Lower order Path Overhead Monitor

MS	Multiplex Section
SDH	Synchronous Digital Hierarchy
SNC	SubNetwork Connection
SNCP	SubNetwork Connection Protection
SNC/I	SubNetwork Connection Protection with Inherent Monitoring
SNC/N	SubNetwork Connection Protection with Non-Intrusive Monitoring
STM(-N)	Synchronous Transport Module (-N)
TIM	Trace Identifier Mismatch
UNEQ	Unequipped
VC	Virtual Container

5 Interworking criteria/objectives

Interworking SDH protection architectures are meant to provide an even greater degree of protection within a network. Some considerations for interworking criteria are as follows:

- end-to-end availability requirements;
- robustness against various failure events;
- implementation complexity and costs.

The following is a list of interworking objectives:

- 1) Ring interworking shall be accommodated in such a way that if two rings are connected at more than one node each, a failure at one of these nodes shall not cause loss of any service.
- 2) It should be possible to avoid propagation of switching between interworking rings.
- 3) The ring shall be able to drop traffic at multiple nodes, i.e. working traffic can be dropped at two, or more, nodes on a ring without compromising the ability to restore traffic that is dual hubbed (or any other traffic).
- 4) Ring interconnection may occur among multiple rings. Interconnection boundaries should be the same for all similar instances of interworking between two ring types.

5.1 Criteria for ring interworking with an MS-shared protection ring

The following objectives apply to the particular case of ring interworking with an MS-shared protection ring:

- MS-shared protection ring nodes should support the capability to interconnect with another architecture at two nodes. In particular, MS-shared protection ring nodes should support the capability to interconnect with another ring at two nodes, regardless of the type of protection switching employed by the other ring (e.g. SNCP or MS-shared protection rings).
- For a tributary being protected against ring interconnection failures, the interconnection architecture should be capable of protecting against the failure of one interconnecting node, two interconnecting nodes (each on different rings, but on the same interconnect), or the connection between the two interconnecting nodes.
- The two interconnecting nodes should not need to be adjacent.
- The ring interconnect architecture should support STM-1 electrical or STM-N optical interconnection (where STM-N signals may contain concatenated payloads).
- The ring interconnection architecture should not require inter-ring signalling. Providing protection for the interconnecting line is not considered inter-ring signalling.

- Protection for ring interconnection failures should be based on detecting path defects.
- To avoid propagation of failures when possible, a hold-off time should be allowed.
- Ring interworking using protection bandwidth between ring interworking nodes will be accommodated. The details of ring interworking using protection bandwidth are for further study.

6 Interworking architectures

This clause describes the interworking between multiple instances of protection architectures within the same network layer intersecting at one or more network nodes (e.g. two or more SNC rings exchanging traffic within a single office).

6.1 Single node interconnection

Single node interconnection is an architecture between two rings where one node in each ring is interconnected.

This architecture (shown in Figure 2) has a single point of failure at the point where the rings are interconnected. Interconnection protection can be provided by multiplex section protection of the interconnecting span, but no protection is available due to failure of either interconnecting node.

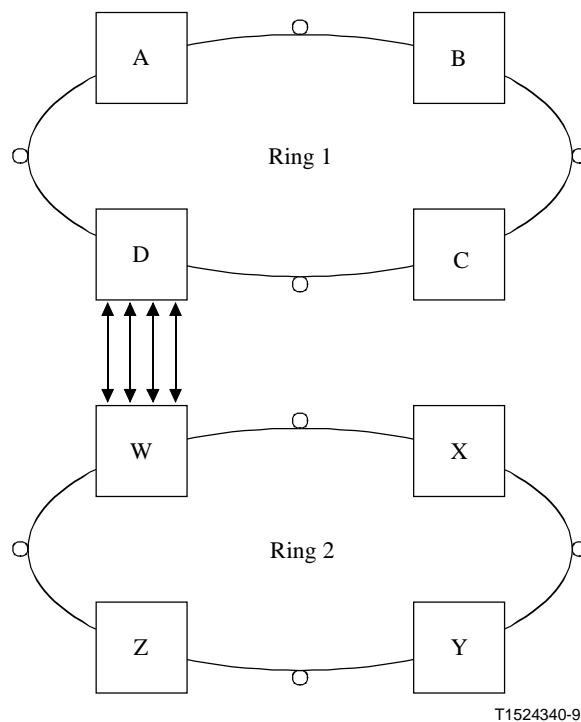

Figure 2/G.842 – Example of single node interconnection

6.2 Dual node interconnection

6.2.1 Generalized architecture

Dual node interconnection is an architecture between two rings where two nodes in each ring are interconnected. This is illustrated in Figure 3. The two interconnections between the two rings can be arranged to provide protection of the traffic crossing from one ring to the other. A special form of

dual node interconnection is given the term ring interworking. Ring interworking is a network topology whereby two rings are interconnected at two nodes on each ring, and the topology operates such that a failure at either of these two nodes will not cause loss of any working traffic. This is illustrated in Figure 1. In this figure, there is a tributary that enters and exits the top ring from Node A, and also enters and exits the bottom ring from Node Z. Using the following notation:

- T_A = the transmit signal at Node A;
- R_A = the receive signal at Node A;
- T_{I1} = the transmit signal at one of the interconnection nodes;
- R_{I1} = the receive signal at one of the interconnection nodes;
- T_{I2} = the transmit signal at the other interconnection node;
- R_{I2} = the receive signal at the other interconnection node.

In ring interworking, the interfaces between the two set of interconnecting nodes is such that:

- $R_{I1} = R_{I2} = T_A$;
- $T_{I1} = T_{I2}$; and
- $R_A = T_{I1}$ or T_{I2} .

In other words, the signal transmitted from Node A towards Node Z is present at both interconnection interfaces. Similarly, the signal transmitted from Node Z back to Node A is also present at both interconnection interfaces. Eventually only one copy of the duplicated signals at the interconnection interfaces is chosen at either Node A or Node Z. Specific examples of ring interworking architectures are described below.

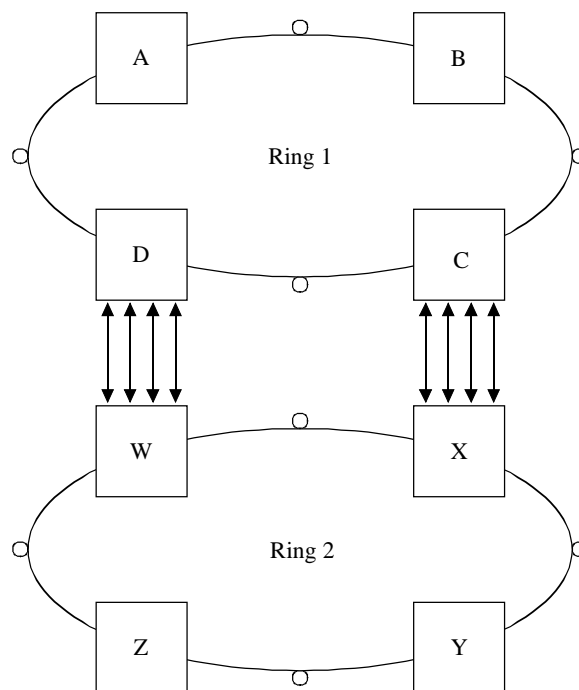

T1524350-96

Figure 3/G.842 – Example of dual node interconnection

6.2.2 Ring interworking with an MS-shared protection ring

6.2.2.1 Architecture

Figure 4 shows the nominal failure free state of a simple MS-shared protection ring and illustrates a particular tributary handed-off at two ring interconnection nodes and to be terminated at the node A. The two ring interconnection nodes are referred to as the primary node and the secondary node. These interconnection nodes need not be adjacent. Starting from the top in Figure 4, a bidirectional tributary from the (uppermost) termination node A is assigned counter-clockwise towards the bottom on the ring. Although there is symmetry in the hand-off to the other ring, the primary node would normally be the one "closest" to the terminating node without respect to ring orientation. Primary and secondary nodes are defined on a per tributary basis. The MS-shared protection ring nodes can interface with any architecture at the interconnection nodes so long as the interface requirements illustrated in Figure 4 are met.

This architecture includes recovery from the following failure scenarios:

- 1) Within the MS-shared protection ring, any failure outside of the termination, primary, or secondary nodes are handled in standard fashion. The MS-shared protection ring is assumed to behave as described in Recommendation G.841. The nature of the failure – whether an electronics failure, a cable cut, or even a node failure – has no impact on the configuration of the termination, primary, or secondary nodes. A cable cut failure is illustrated in Figure 5.
- 2) A failure of the primary node in the MS-shared protection ring results in a secondary connection of the tributary. Normally such a tributary would be squelched, but for this architecture this particular tributary remains unsquelched. All other (undesired) crossed traffic is squelched. Failure of the primary node is illustrated in Figure 6. The ring interworking behavior for this case remains the same even if a disaster is large enough (e.g. central office lost) to cause a failure of both the primary node on one ring and its interconnected node on the other ring.
- 3) For a failure of the secondary node, the tributary at the terminating node (see Node A in Figure 7) is unaffected, since it receives its tributary from the primary node. Because of the ring signalling, the primary node knows that the secondary node has failed. The primary node chooses its tributary from the traffic entering it from the other ring. The secondary node has a failed tributary R_S sent to the second ring. The failure of this signal may unavoidably lead to a switch in the second ring depending on its ring type.
- 4) For a failure of either of the signals coming in from the other ring (i.e. T_{I1} or T_{I2}), the primary node in the MS-shared protection ring chooses the signal that is not failed. Figure 8 illustrates a failure of the hand-off to the secondary node. Here the primary node remains switched to its own good hand-off. Figure 9 illustrates a failure of the hand-off to the primary node. In this case, the primary node switches to choose a good tributary from the secondary node.
- 5) This architecture also protects against a single failure in each of the two rings (i.e. the MS-shared protection ring and the other ring), provided that these failures are not terminating node failures, or these failures do not combine to affect both interconnections between the rings.

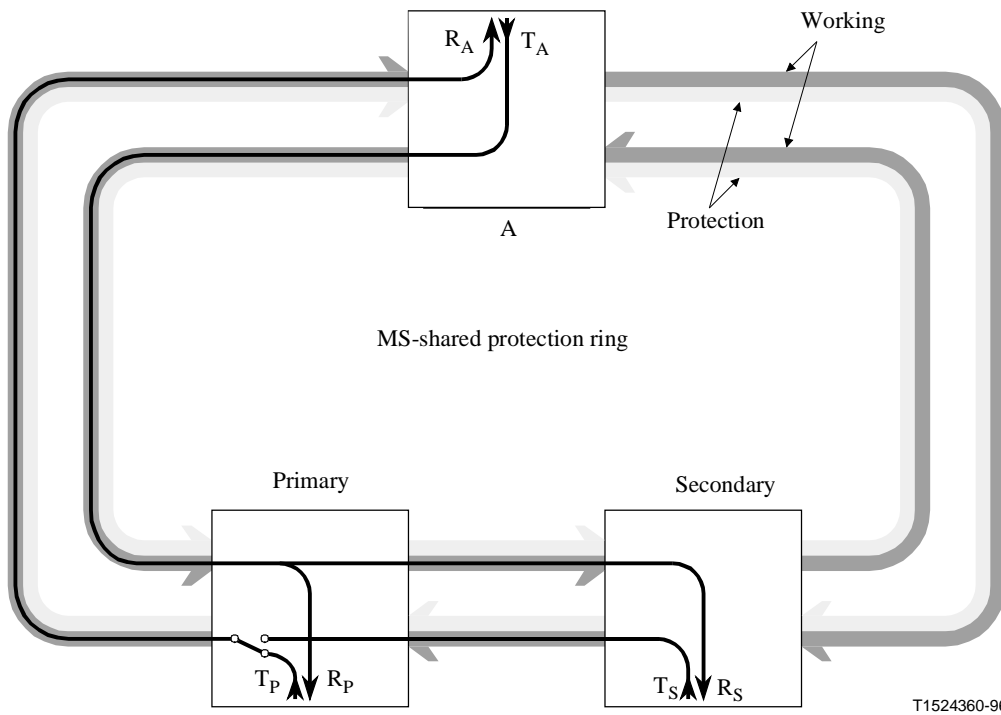

Nominal failure free state of A-Z tributary in MS-shared protection ring:

$$R_P = R_S = T_A$$

$$R_A = T_P = (T_S)$$

Figure 4/G.842 – Ring interworking with an MS-shared protection ring

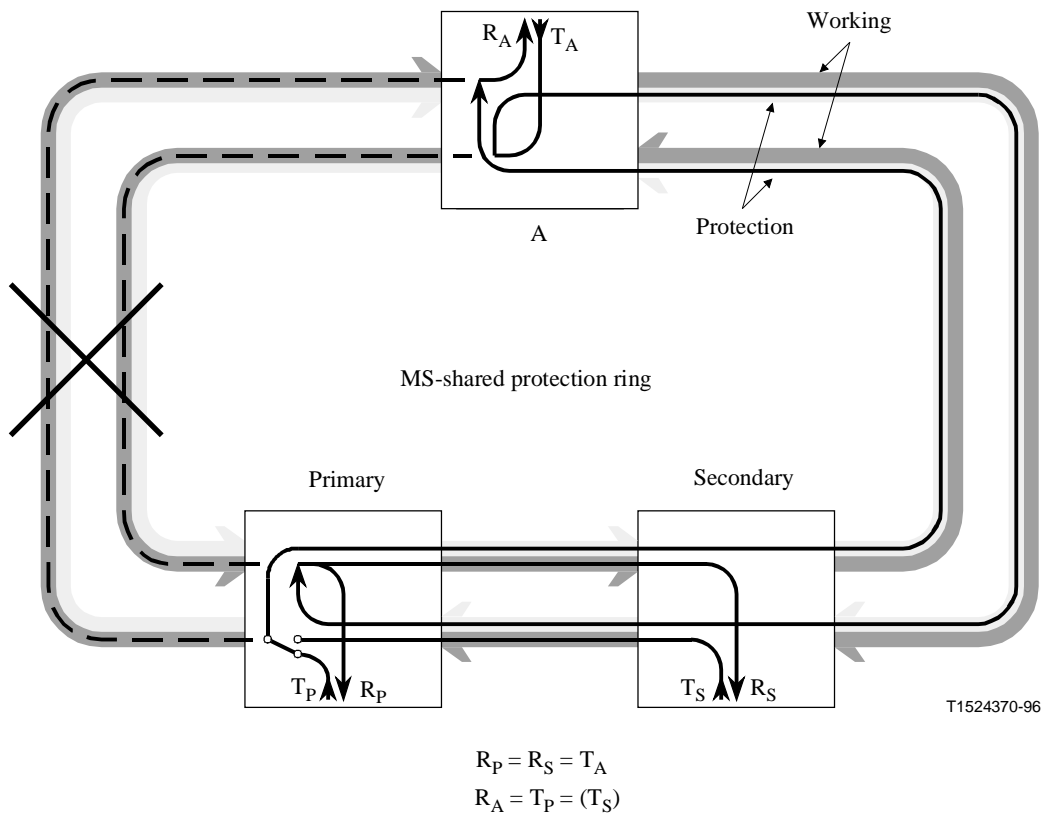

Figure 5/G.842 – Signal response to any ring failure outside of termination, primary, or secondary nodes (cable cut between primary and Node A shown)

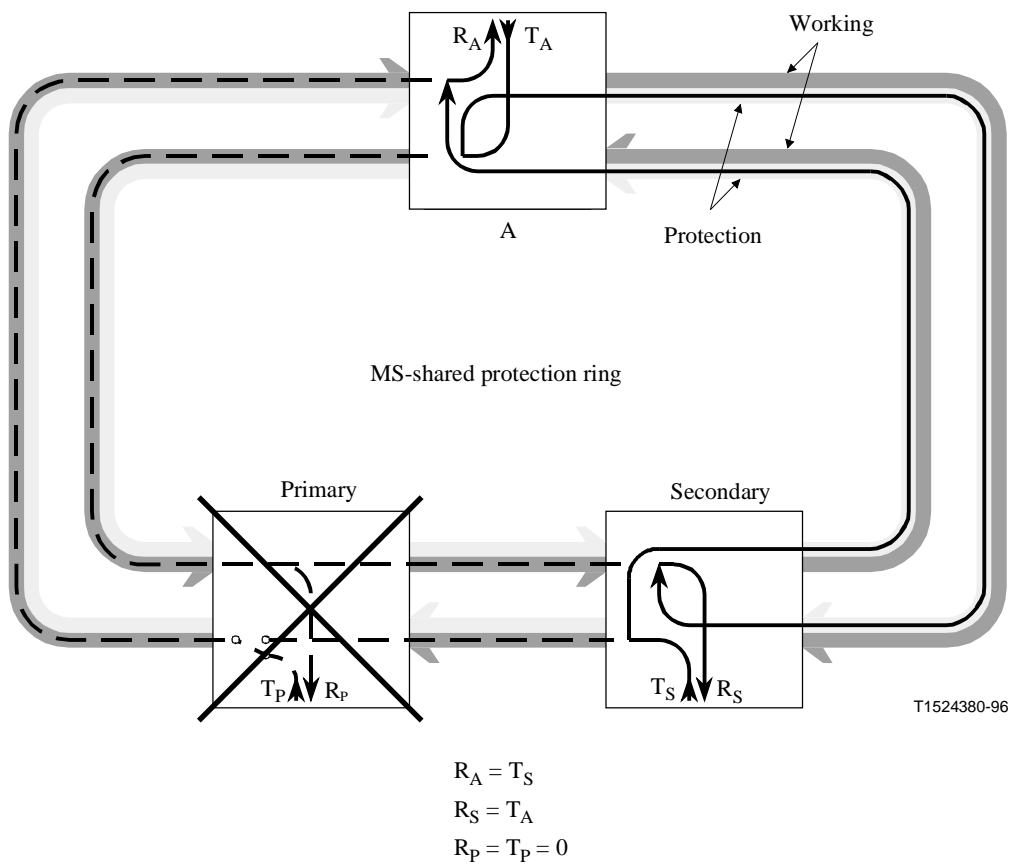

Figure 6/G.842 – Signal response to complete primary node failure

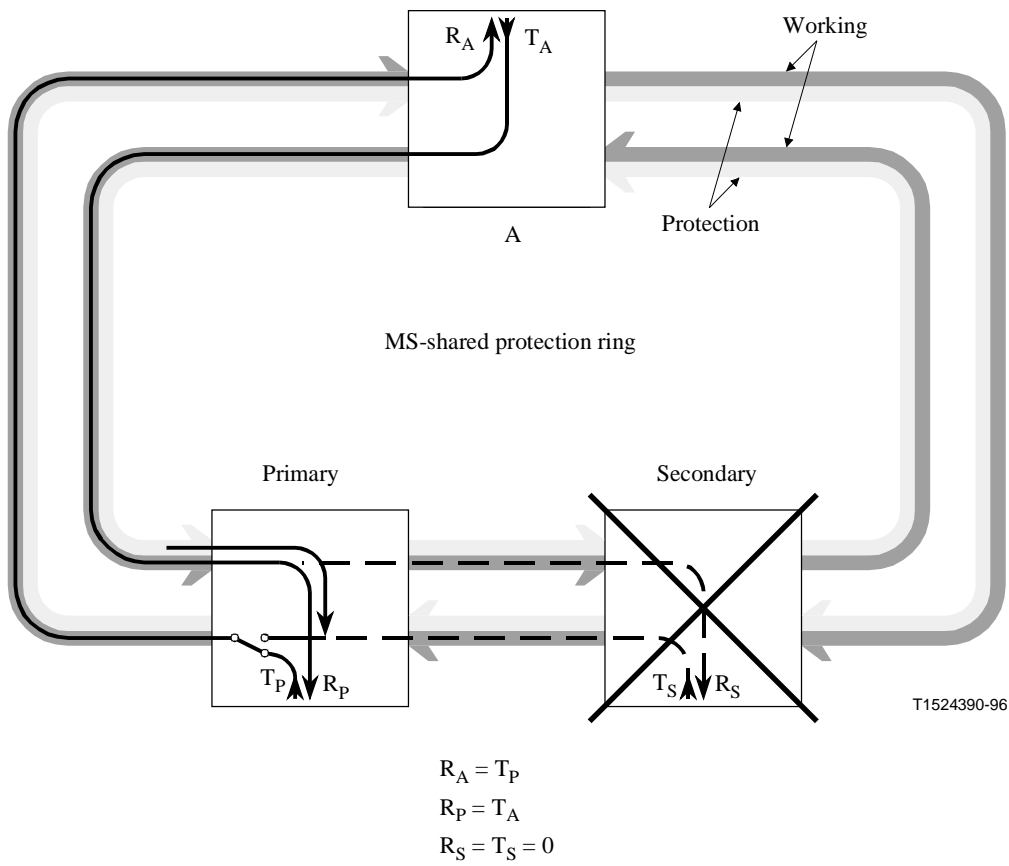
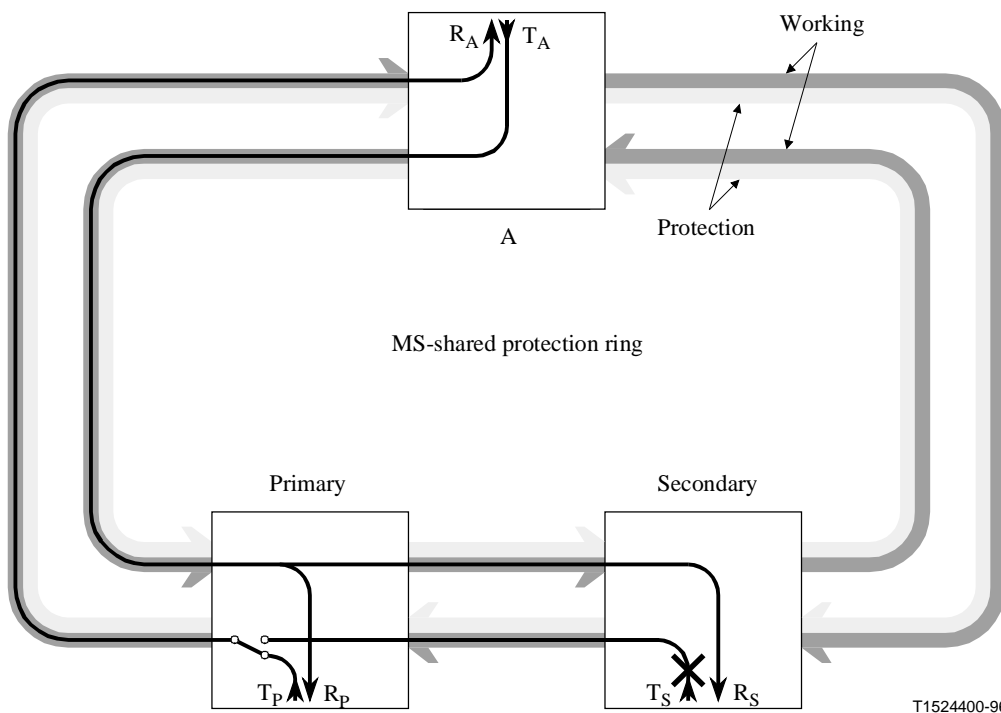

Figure 7/G.842 – Signal response to complete secondary node failure



$$\begin{aligned}
 R_A &= T_P \\
 R_P &= R_S = T_A \\
 T_S &= 0
 \end{aligned}$$

Figure 8/G.842 – Failure of the transmit hand-off at the secondary node

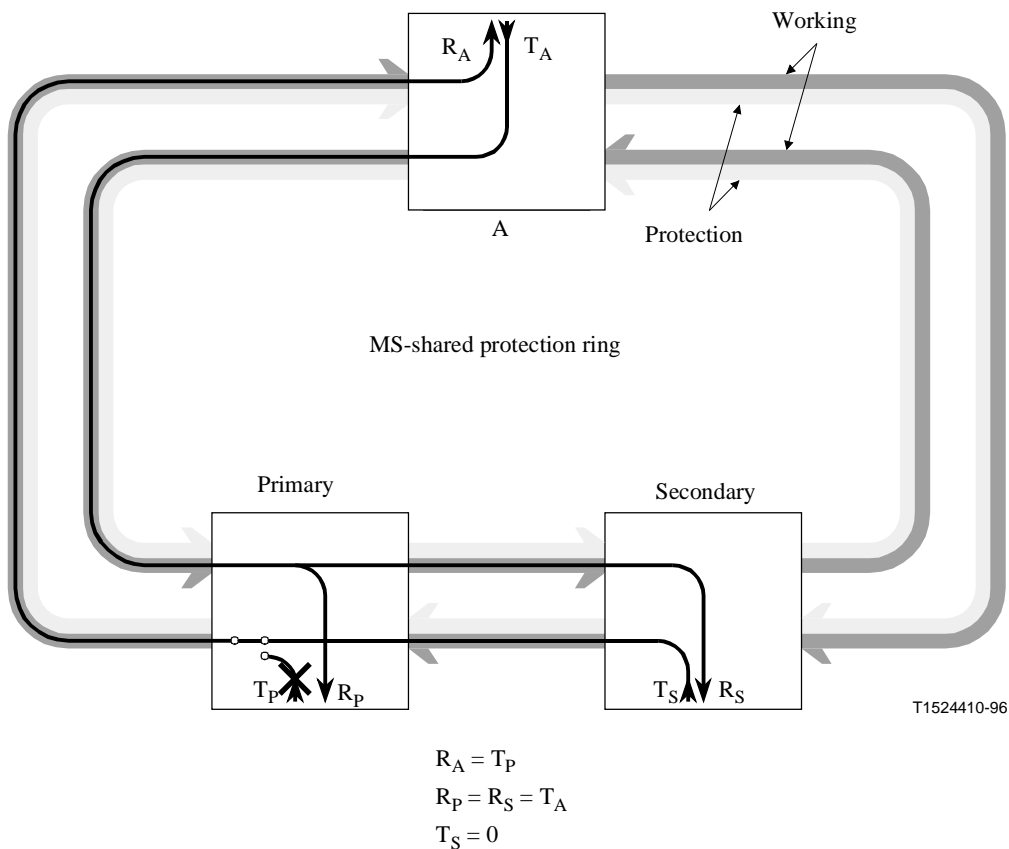

Figure 9/G.842 – Failure of the transmit hand-off at the primary node

6.2.2.1.1 Routing with all traffic on working channels

For the unidirectional signal transmitted from the node A, the primary node dual feeds that signal both towards its own interface and towards the multiplex section to the secondary node. This function is often referred to as drop-and-continue. In the other direction, the primary node selects, via a service selector, between the hand-offs to the primary and secondary nodes from the other ring, and transmits that selection to the upper terminating node. The interconnections are at the STM-1 electrical or STM-N optical level. The same channel assignment on the multiplex section used between the secondary and primary nodes is the same as that used between the primary and terminating nodes. Figures 10 and 11 give two ring interworking examples. Interworking of an MS-shared protection ring with a lower order SNCP ring may require further study. With the switching criteria from 6.2.2.3 and squelching logic from 6.2.2.4, this interconnection architecture provides protection against the failure of one or both interconnecting nodes (each on different rings, but on the same interconnect), or the connection between the two interconnecting nodes. Furthermore, the interconnection architecture does not require inter-ring signalling.

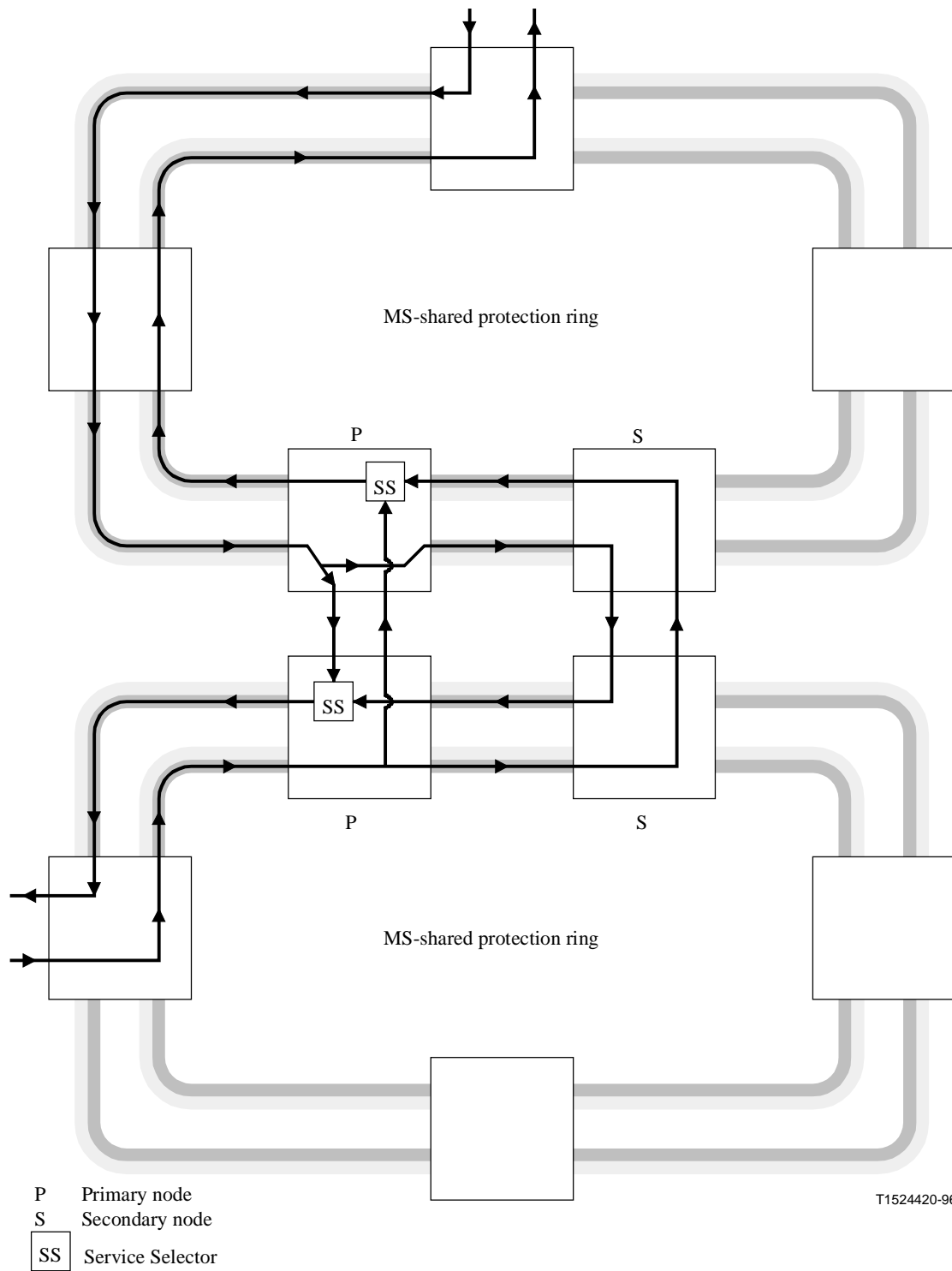

Figure 10/G.842 – Ring interworking between two MS-shared protection rings

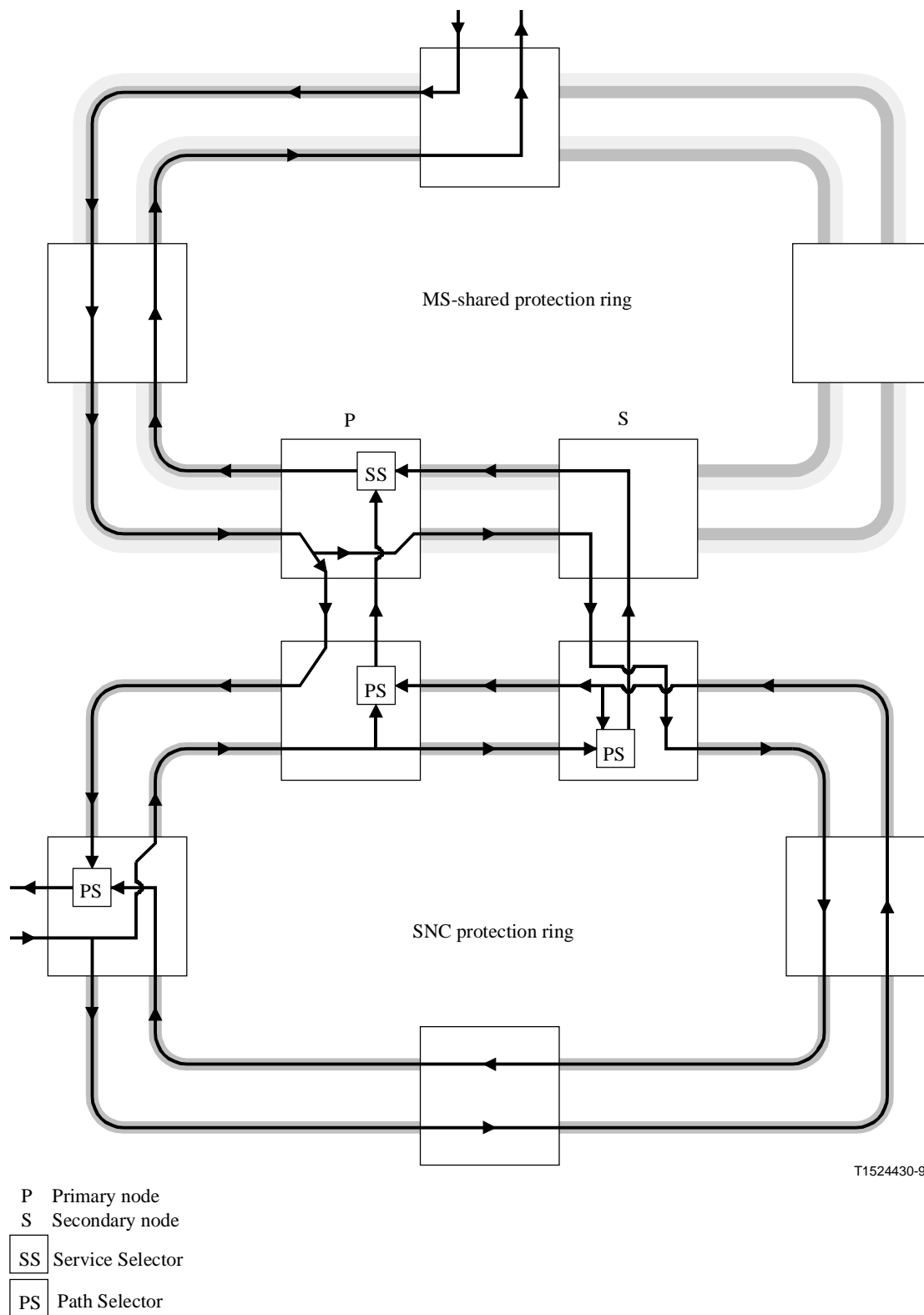

Figure 11/G.842 – Ring interworking between an MS-shared protection ring and a HO SNCP ring

6.2.2.1.2 Routing with continue traffic on protection channels between primary and secondary nodes

This describes general considerations associated with using protection bandwidth for ring interconnection. Further details of ring interworking using protection bandwidth are under study.

This alternative method to ring interworking takes advantage of the protection bandwidth between primary and secondary ring interworking nodes to address the capacity issue that arises when drop-and-continue in conjunction with a service selector is used for ring interconnection on an MS-shared protection ring. This is illustrated in Figure 12. The issue is one of early bandwidth exhaust between primary and secondary nodes when using only working bandwidth for drop-and-continue in conjunction with a service selector.

The problem can be illustrated by referring to Figure 10, which shows two interconnected MS-shared protection rings. The two interconnecting ring nodes in each MS-shared protection ring use the working bandwidth for the extra circuit between them that allows for dual node ring interworking, i.e. the combination of the "continue" portion of the drop-and-continue (from the primary to the secondary node), along with the duplicate feed from the other ring (from the secondary node to the service selector in the primary node). This extra circuit is called the secondary circuit.

By taking advantage of the protection bandwidth between the interconnection nodes on the MS-shared protection ring, less working bandwidth would be consumed as compared to the method of using only working bandwidth for ring interconnection. For example, either one, or both, of the secondary circuits in Figure 10 can use the protection bandwidth between the primary and secondary nodes, instead of using the working bandwidth. The protection bandwidth between the primary and secondary nodes on an MS-shared protection ring can be used even if the other interconnected ring is an SNCP ring (see Figure 11).

The following options for ring interworking using combinations of working and protection bandwidth between interconnecting ring nodes (i.e. between primary and secondary nodes) are possible:

- a) ring interconnection using working bandwidth only;
- b) ring interconnection using working bandwidth in one ring and protection bandwidth in the other; and
- c) ring interconnection using protection bandwidth in both rings.

These ring interworking options may be used on interconnected rings with either same-side or opposite-side routing. Same-side routing is illustrated in Figure 10, while opposite-side routing is illustrated in Figure 6. Note that same-side routing requires two extra, or secondary circuits, i.e. one per ring, for dual node interworking (see Figure 10), while opposite-side routing requires only one extra, or secondary circuit (see Figure 13). In the bottom ring of Figure 13, the traffic already passes through both the primary and secondary nodes for opposite-side ring interworking; this is known as the service circuit. For opposite-side routing, extra bandwidth for a secondary circuit is only used in one ring (e.g. the top ring in Figure 13).

The option of using only working bandwidth provides the highest level of survivability. If less survivability can be tolerated, certain options that take advantage of protection bandwidth between interconnecting ring nodes may be used, including:

- a) same-side ring interworking with one secondary circuit on working and one secondary circuit on protection;
- b) same-side ring interworking with both secondary circuits on protection;
- c) opposite-side ring interworking with the service circuit on working and the secondary circuit on protection.

Assigning the service circuit to protection bandwidth in opposite-side ring interworking is not recommended.

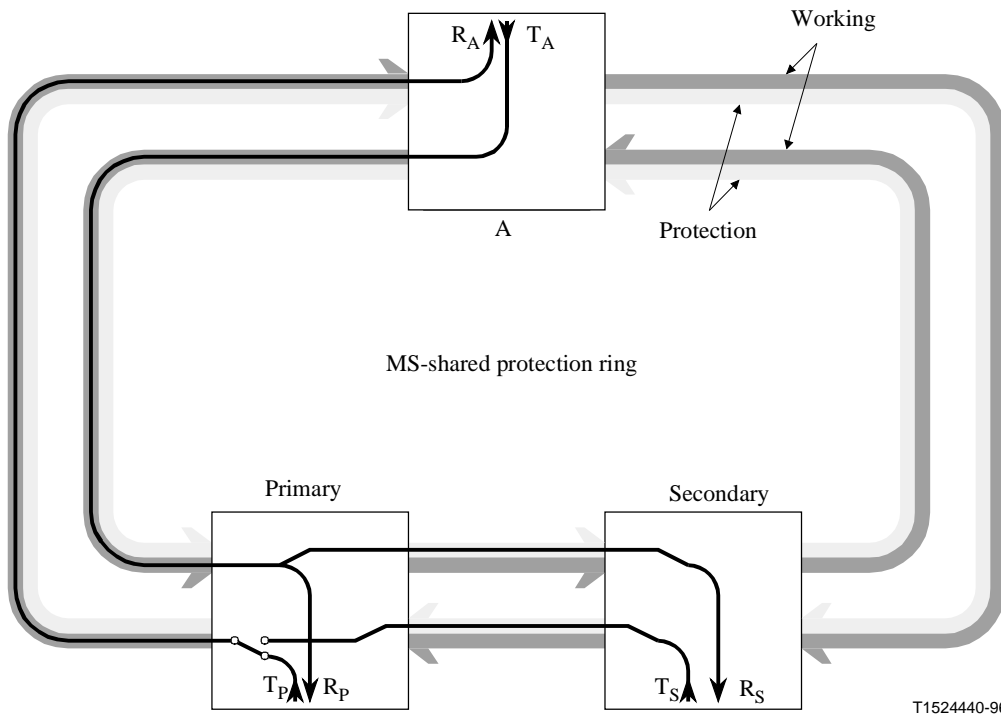

Nominal failure free state of A-Z tributary in MS-shared protection ring:

$$R_P = R_S = T_A$$

$$R_A = T_P = (T_S)$$

Tributary assignment for secondary connection = Protection tributary for working path

Figure 12/G.842 – Ring interworking using protection capacity

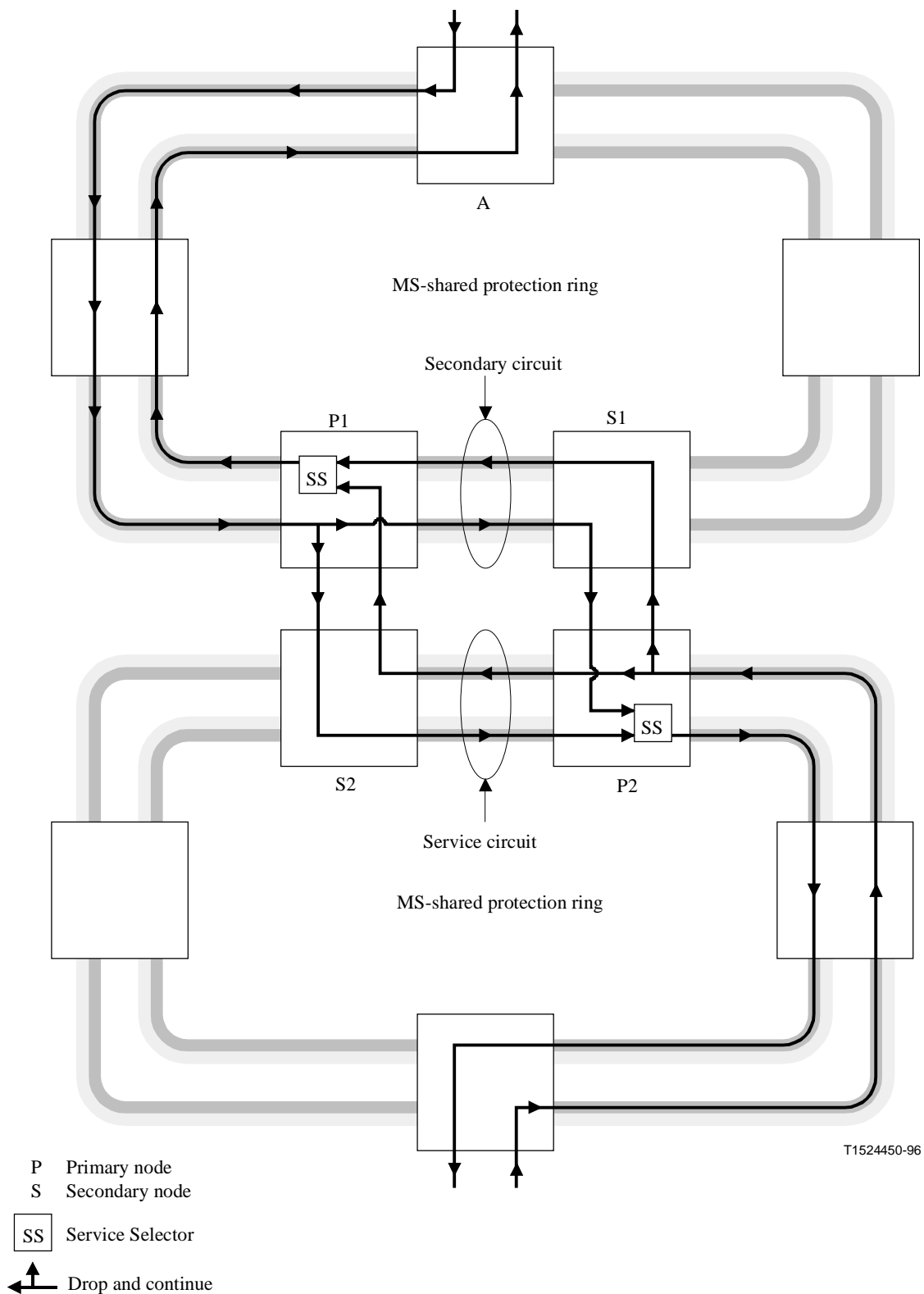

Figure 13/G.842 – Ring interworking between two MS-shared protection rings, with opposite-side routing

6.2.2.2 Functional model

Figures 14 and 15 illustrate the functional model associated with a primary node in an MS-shared protection ring. In this example, an electrical STM-1 signal is connected at the tributary side of the ADM equipment and two STM-N optical signals are connected at both west and east line sides.

A HOVC out of the STM-1 signal has a 1 + 1 SNC protection relation with a HOVC out of the west STM-N signal; the selected HOVC signal is connected to the east STM-N signal. In the other direction the associated HOVC at the east STM-N signal is dual-fed to both the STM-1 and west STM-N signals.

For the case of SNC/N protection (Figure 15), the HOVC out of the STM-1 is also connected to the interface with a HPOM function. Similarly, the HOVC out of the west STM-N is connected also to a HPOM function.

Figure 16 illustrates the matrix connections within the HPC that realise the "service selector". For the case of SNC/I three matrix connections are required: (1) .. (3). For the case of SNC/N five matrix connections are required: (1) .. (5).

NOTE – The HPC interfaces A, B, C, D, E in Figure 16 represent the same interfaces in Figures 14 and 15.

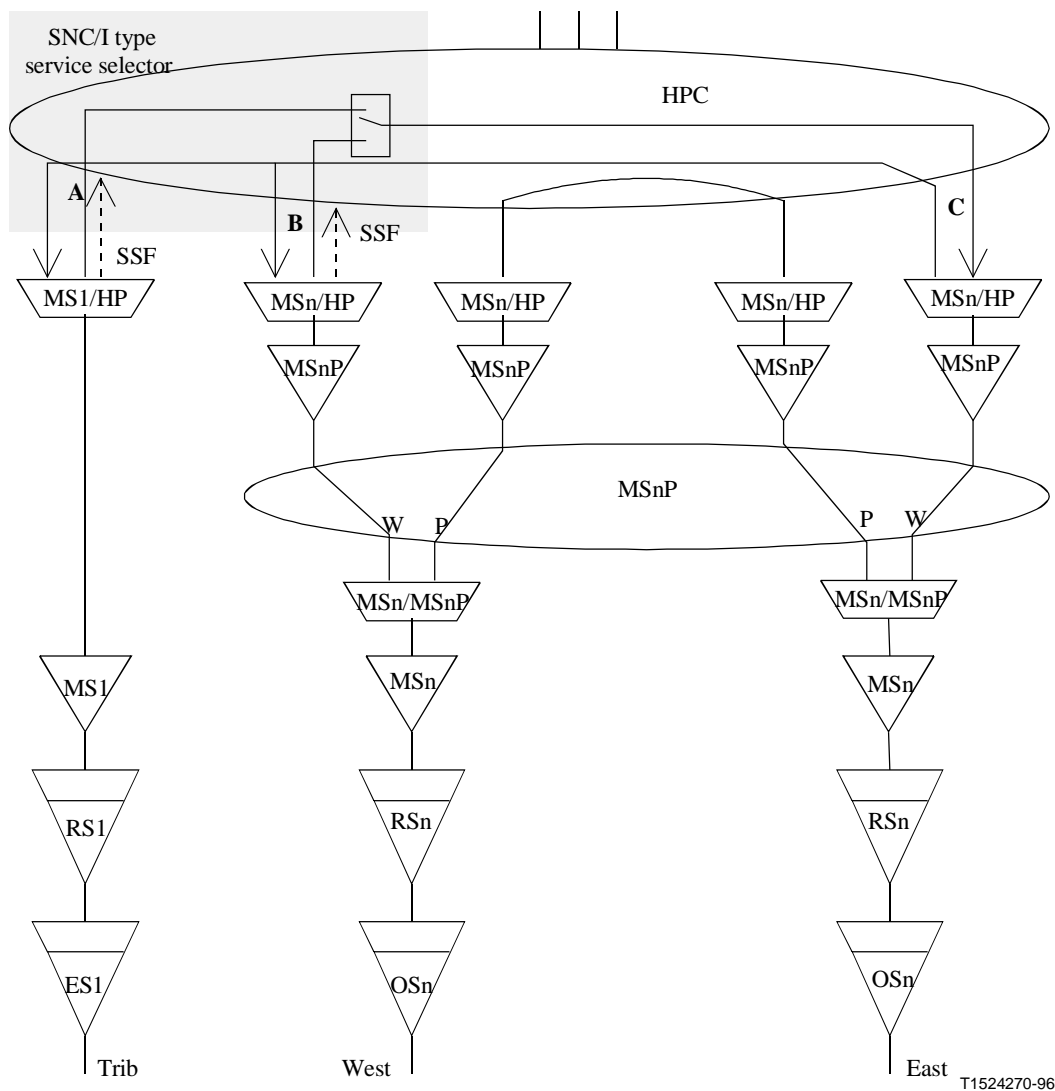

Figure 14/G.842 – Example of functional model for network element with service selector of type SNC/I

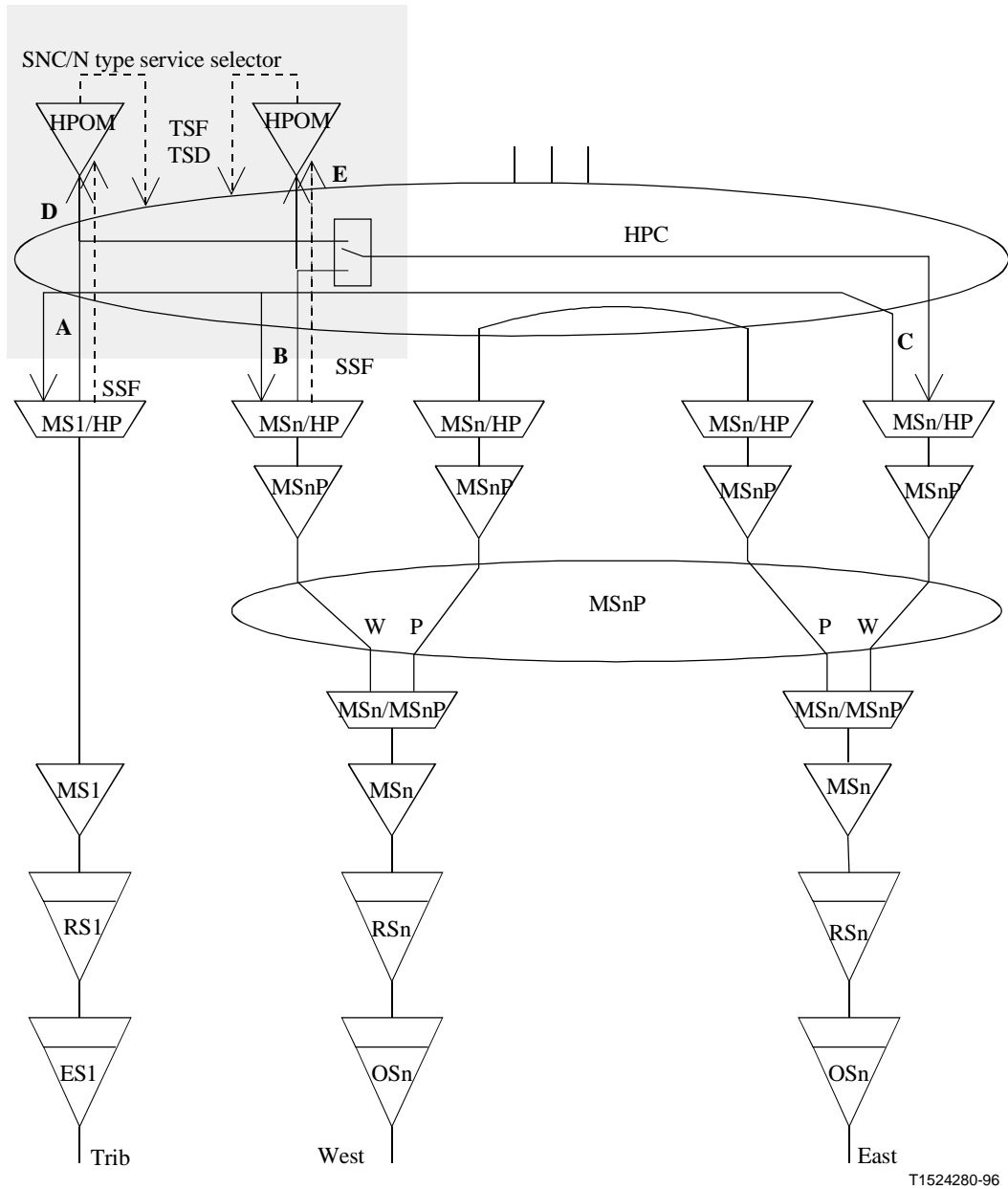

Figure 15/G.842 – Example of functional model for network element with service selector of type SNC/N

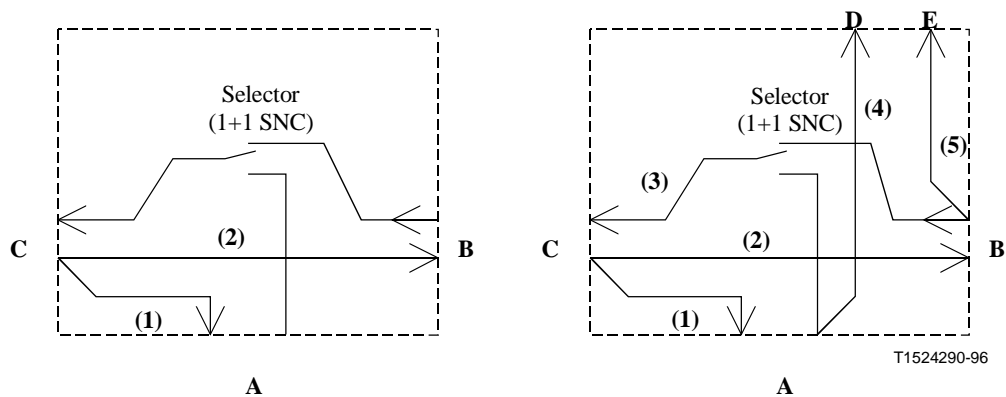

Figure 16/G.842 – Service selector's HPC connectivity

6.2.2.3 Switching criteria and operation

At the primary node, a service selector is used to select the better of two incoming tributaries, i.e. the tributary from the interconnecting line or the tributary from the secondary node. The service selectors trigger on path layer criteria. The hierarchy of conditions for MS-shared protection ring service selection switch initiation is listed in Table 1. The switching hierarchy must select the least impacted signal under multiple failures occurring at different levels on the same path.

Table 1/G.842 – Hierarchy of conditions for service selector (see Note 3)

Condition	Priority (see Note 1)
AIS, LOP, UNEQ defect, TIM (optional), or server signal fail (see Note 2)	1 (hard failure)
Excessive error defect (optional)	2 (hard failure)
Signal degrade	3
NOTE 1 – The highest priority (1) corresponds to the worst impairment, and the lowest priority (3) corresponds to the least impairment.	
NOTE 2 – Server signal fail arises as a result of section defects; e.g. LOS, LOF.	
NOTE 3 – For the case of SNC/I, only AIS, LOP, or server signal fail are applicable.	

The service selector shall be capable of revertive or non-revertive operation. To have a known failure-free state, it may be desirable to have the service selector be revertive. In the case of conditions of identical severity arriving on both incoming tributaries, the service selector shall select the preferred route in the case of revertive operation, or the current (i.e. active or currently selected) route in the case of non-revertive operation. This may be subject to a hold-off time.

In a future revision, when Recommendations G.841, G.783, and this Recommendation are aligned, Table 1 can be replaced by a reference to Recommendations G.841 and G.783.

6.2.2.4 Squelching logic

For the case of the failure of the primary node, the connection of the signal between the termination A and the secondary node is maintained. This is called a secondary connection.

An MS-shared protection ring providing the sort of ring interworking described here must be provisionable on a per channel basis to allow a secondary connection or to squelch the traffic in the case of a node failure as required for the particular application and circuit. The squelching for a ring interworking circuit is simply based on the failure of either of the endpoints for the interconnected circuit, because a switching node should squelch the channel in Figure 4 if and only if node A fails or the secondary node fails. If the secondary node fails and the primary node is the switching node, observe that the primary squelches bidirectionally with respect to the signal towards the secondary node, but that the bidirectional connection from the primary node to node A is maintained.

The rules for squelching logic when interworking using protection capacity are for further study.

6.2.3 Ring interworking with an SNCP ring

6.2.3.1 Architecture

Figure 17 shows the architecture of SNCP ring interworking. For each direction of transmission, the signal is dual-fed from the source node around both sides of the ring. When each of the dual-fed signals hits an interconnection node, it is dropped at that node and continued onto the other interconnection node using the drop-and-continue feature. Thus, each interconnection node can select

from two signals sent on a different way around the ring. The output of the selector in each interconnection node is then transmitted to the second ring. Each of the interconnection nodes in the second ring takes its respective signal and transmits it towards the sink node, away from the other interconnection node. Finally, the sink node makes the selection between the two signals from the two directions around the ring.

Due to the symmetry of this scheme, the two interconnection nodes are completely equivalent.

Interworking between higher order SNCP rings and lower order SNCP rings may require further study.

Some examples of reconfiguration in case of failure are shown in Figures 18 through 23:

- Figure 18 shows a bidirectional span failure in one ring;
- Figure 19 shows a bidirectional failure of one interconnection link;
- Figure 20 shows a nodal failure at one interconnection point;
- Figure 21 shows a bidirectional failure between interconnecting nodes on the same ring;
- Figures 22 and 23 show unidirectional failures in each direction assuming unidirectional working of SNCP.

In each figure, the nodes where switching should occur to restore the interworking traffic are shadowed. Due to different switching time of network elements, different final configurations are possible (see clause 8).

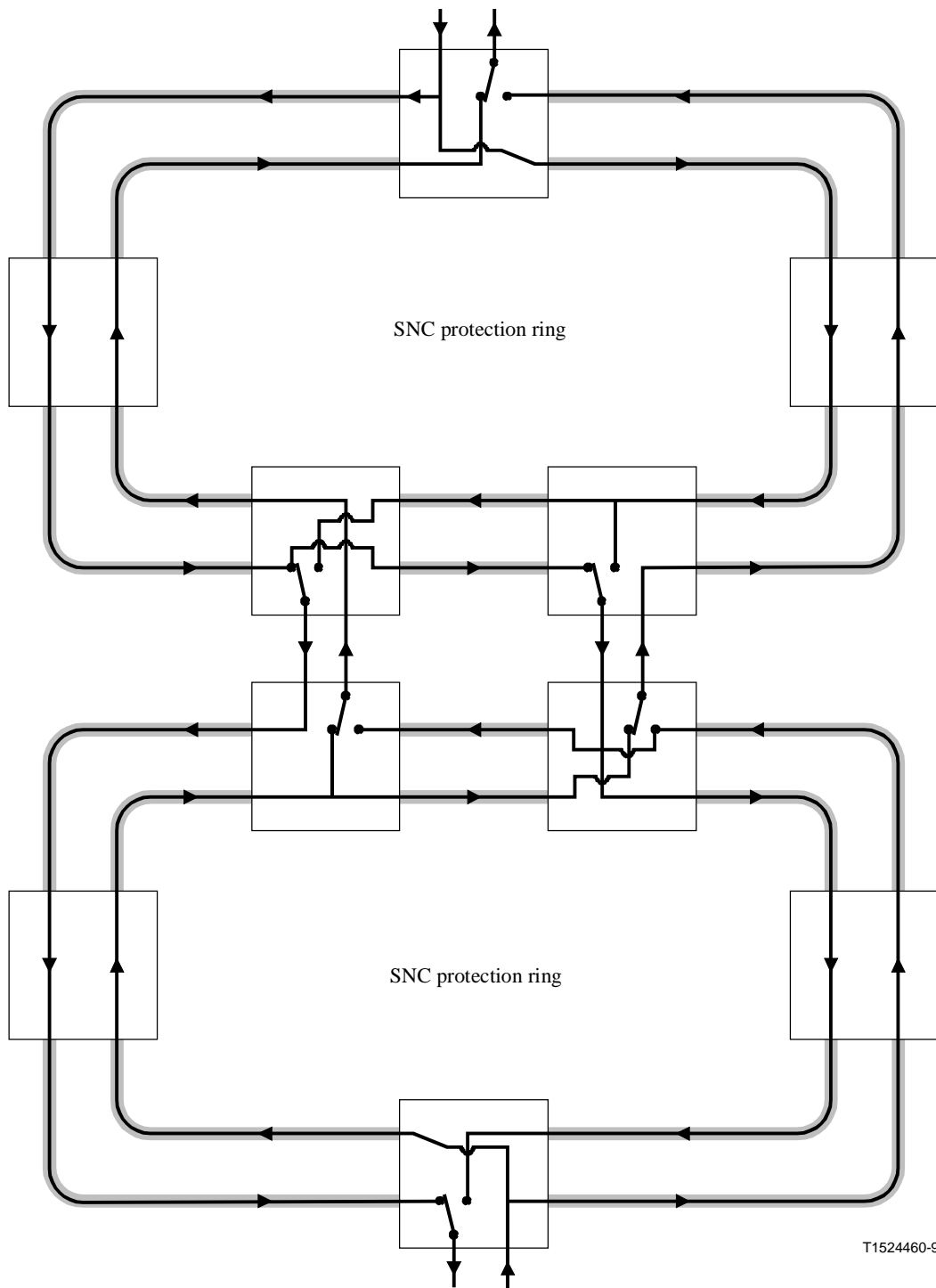

 Path selector

Figure 17/G.842 – SNCP ring interworking architecture



T1524470-96

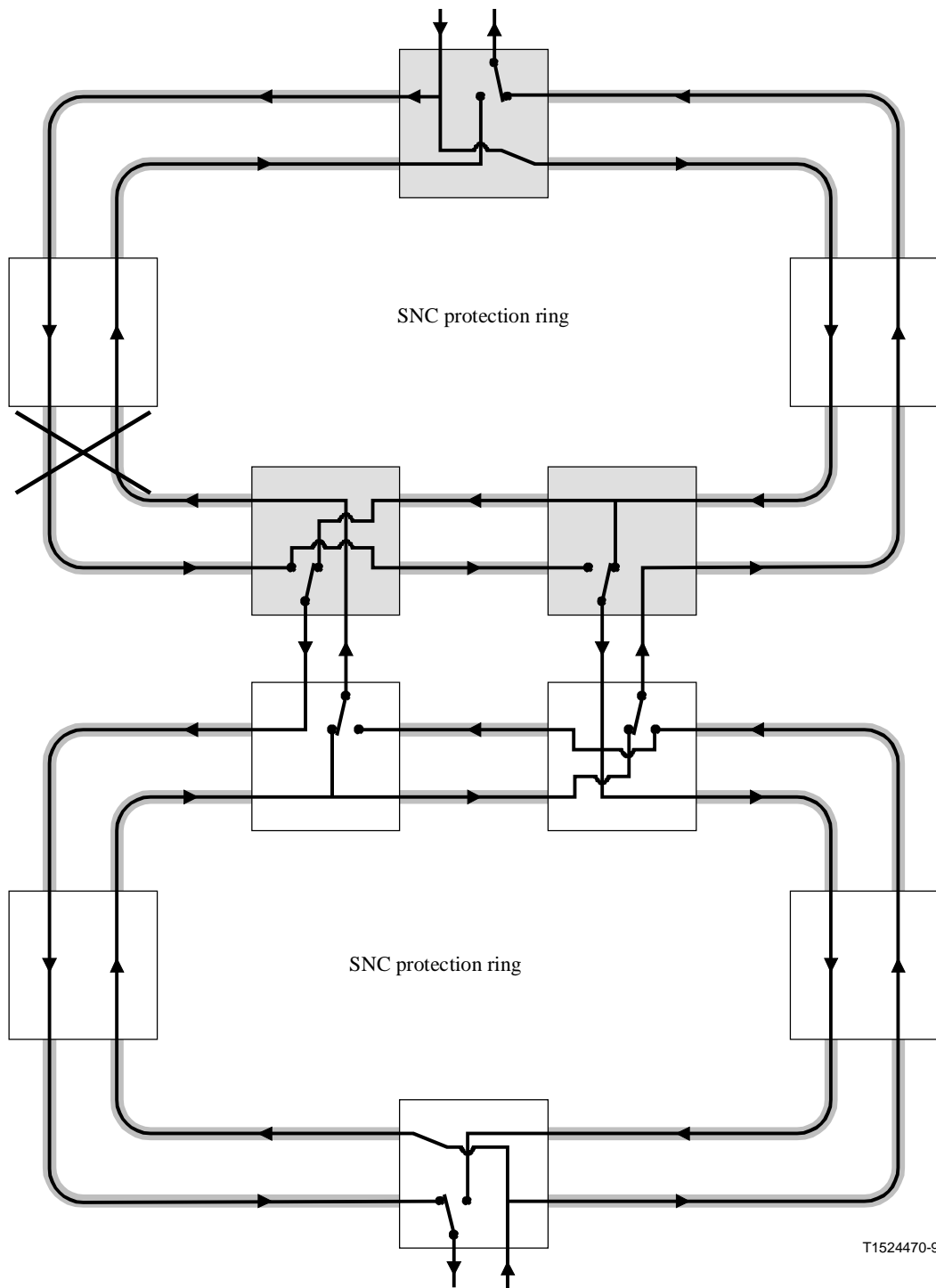

 Path selector

Figure 18/G.842 – Interworking between SNCP rings: bidirectional failure in one ring

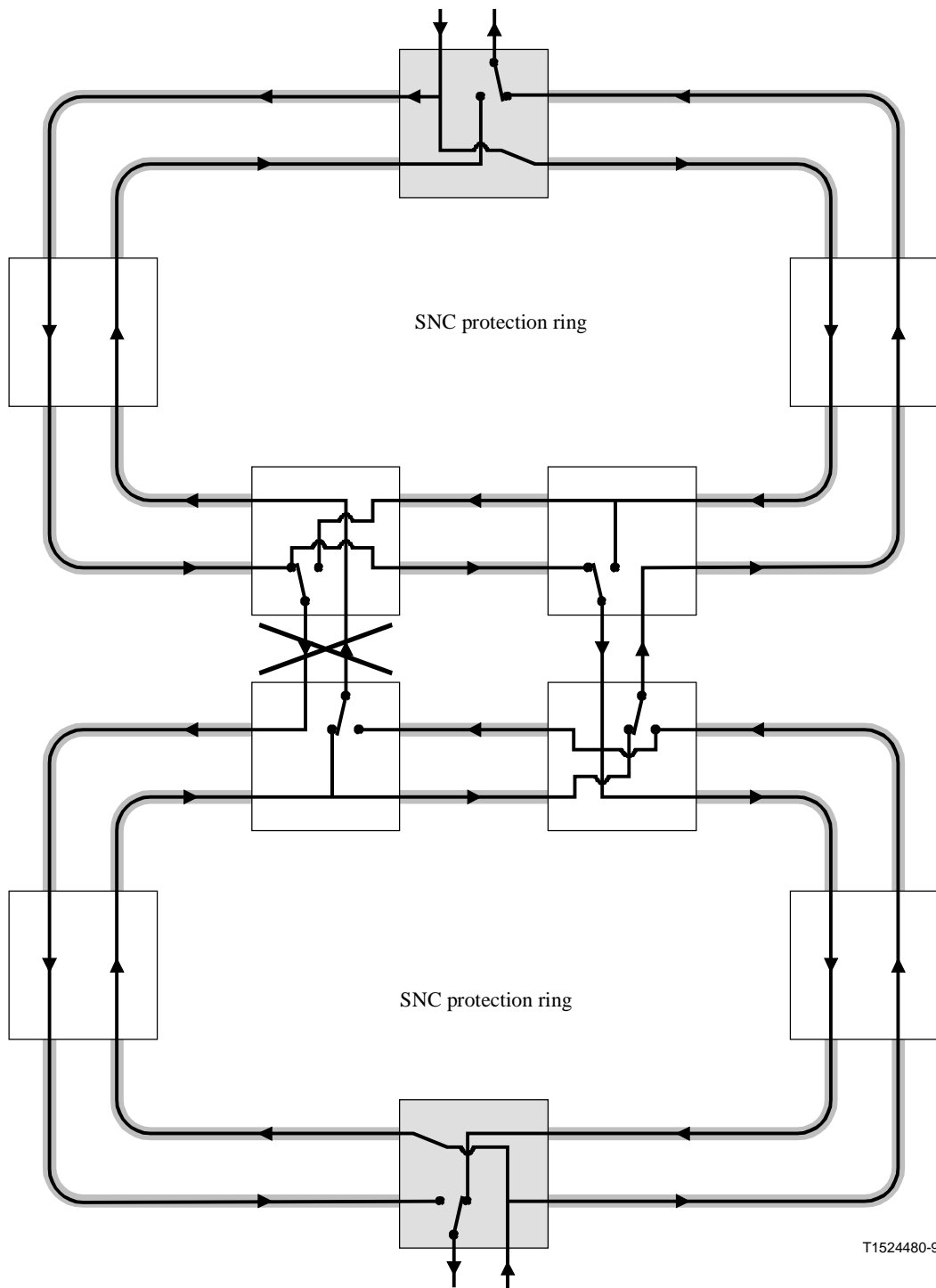

T1524480-96

 Path selector

**Figure 19/G.842 – Interworking between SNCP rings:
bidirectional failure of one interconnection point**

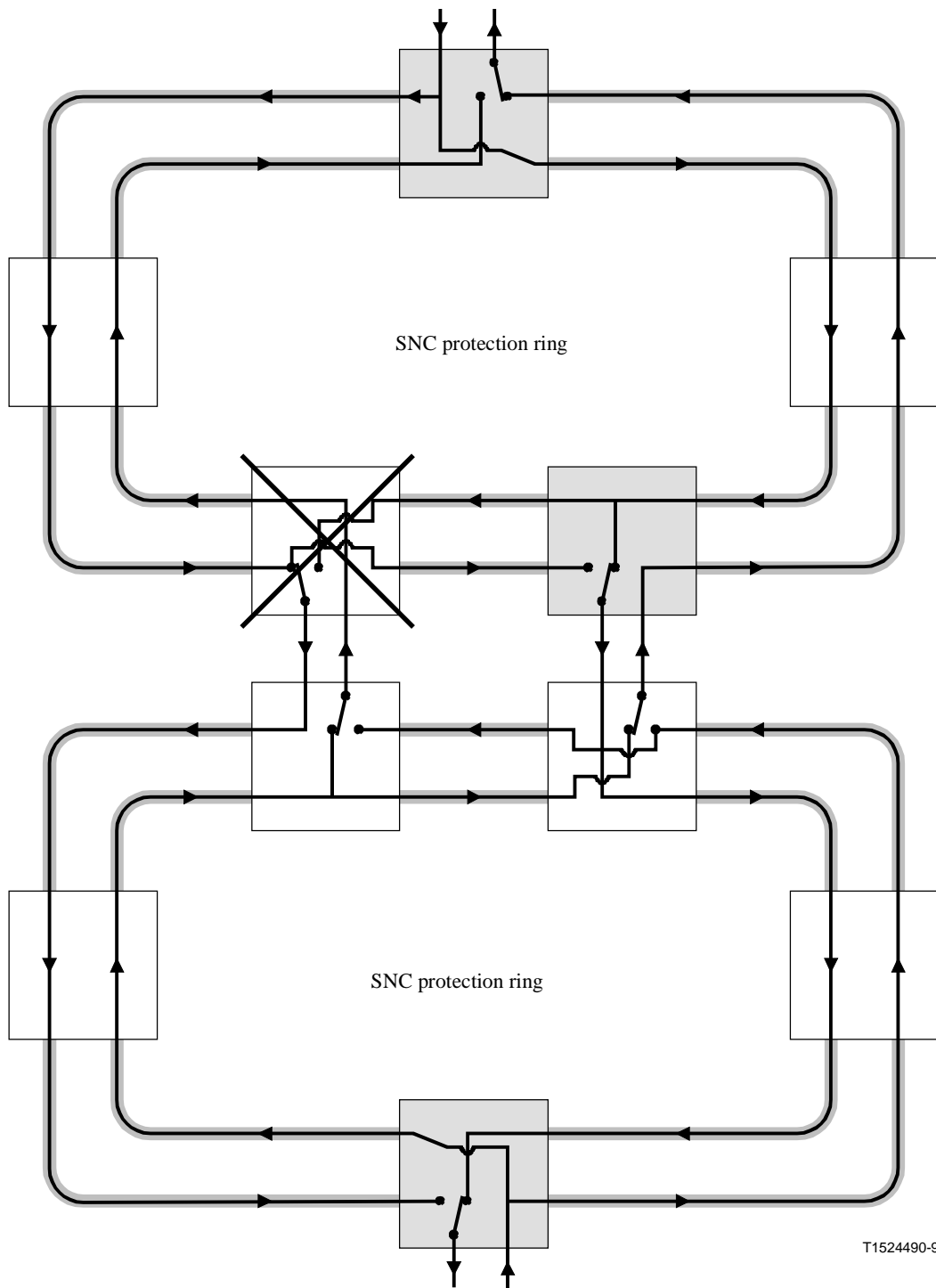

T1524490-96

 Path selector

**Figure 20/G.842 – Interconnection between SNCP rings:
failure of one interconnection node**

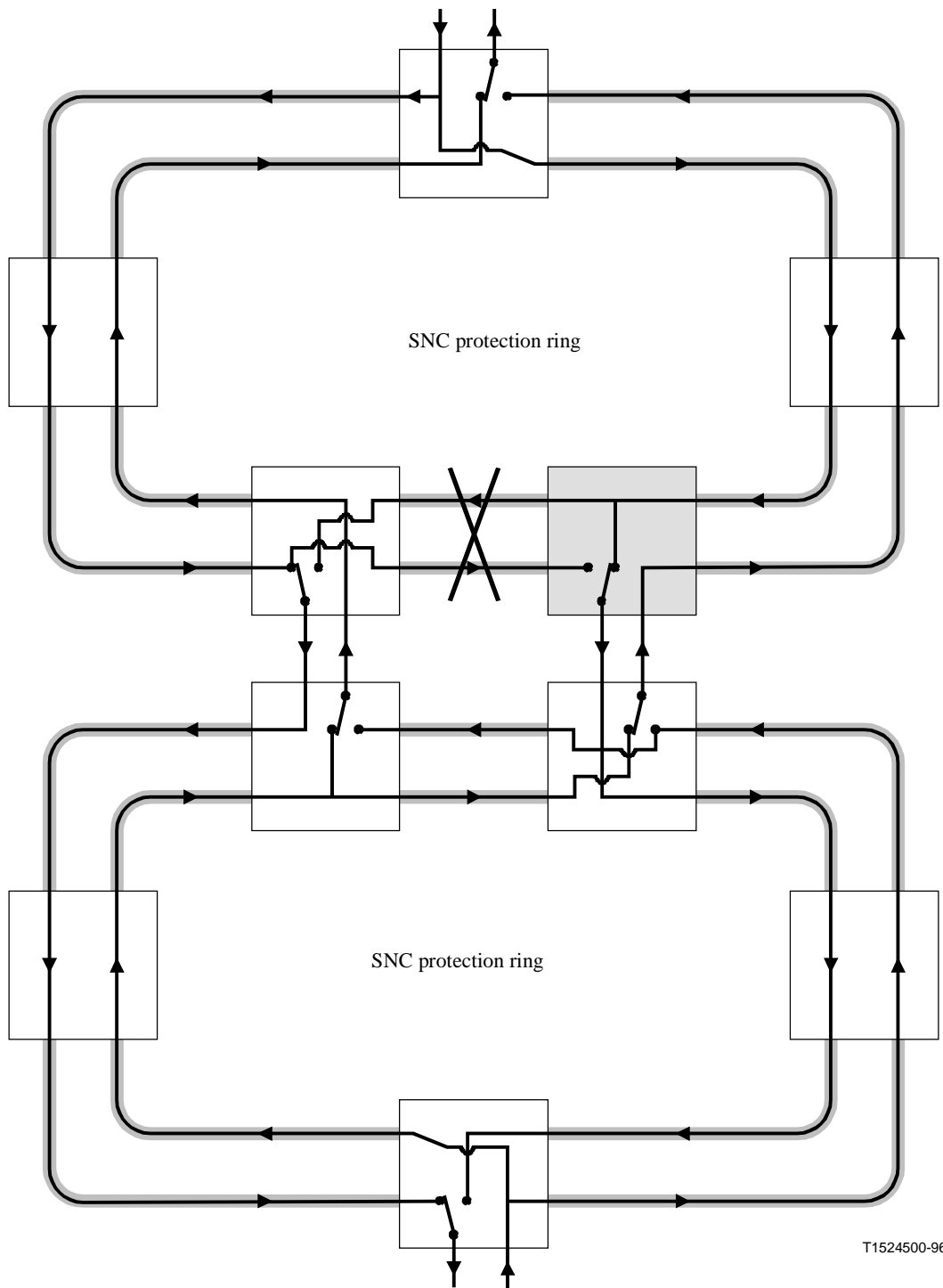

 Path selector

**Figure 21/G.842 – Interworking between SNCP rings:
bidirectional failure between interconnecting nodes on the same ring**

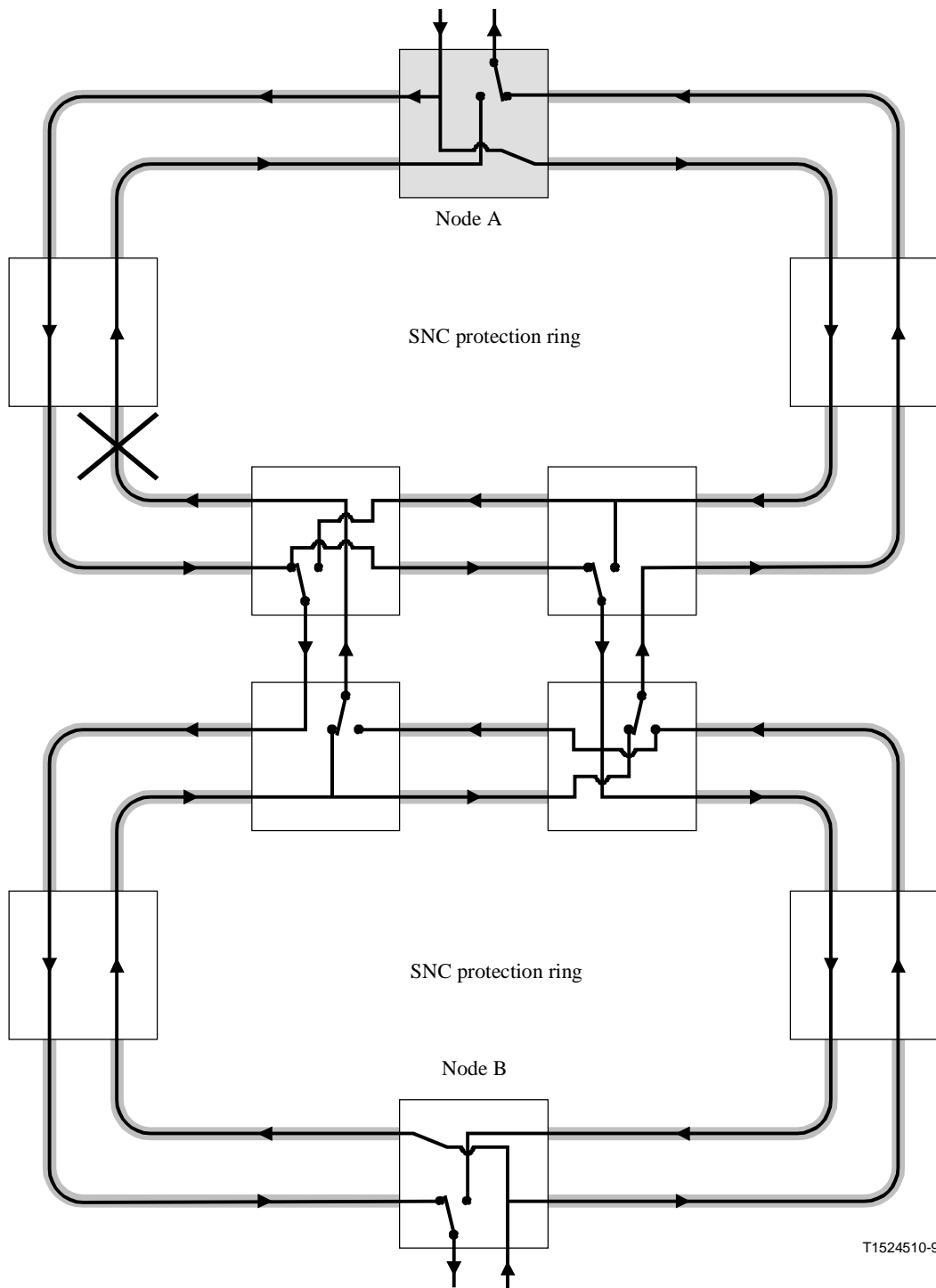

T1524510-96

 Path selector

**Figure 22/G.842 – Interworking between SNCP rings:
unidirectional failure from Node B to Node A**

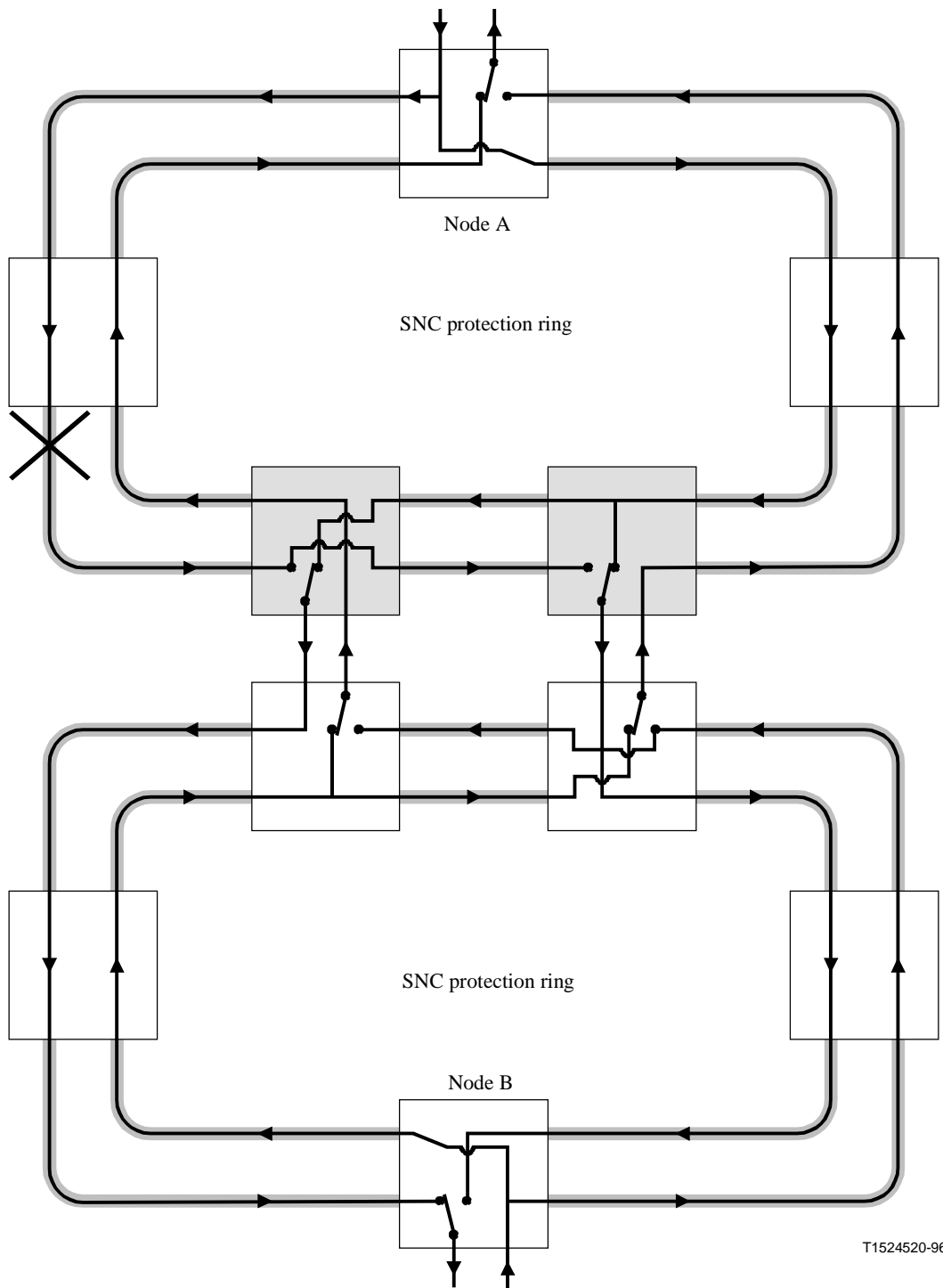

T1524520-96

 Path selector

**Figure 23/G.842 – Interworking between SNCP rings:
unidirectional failure from Node A to Node B**

6.2.3.2 Functional model

Figures 24 and 25 illustrate the functional model associated with an interconnecting node in an LO SNCP protected ring. In this example, an electrical STM-1 signal is connected at the tributary side of the ADM equipment and two STM-N optical signals are connected at both west and east line sides.

A LOVC out of the east STM-N signal has a 1+1 SNC protection relation with a LOVC out of the west STM-N signal; the selected LOVC signal is connected to the STM-1 signal. In the other direction the associated LOVC in the STM-1 signal is connected to the east STM-N signal. The received LOVC in the east STM-N signal is also connected to the west STM-N signal.

For the case of SNC/N protection (Figure 25), the LOVC signals out of the east and west STM-N signals are also connected to interfaces with a LPOM function.

Figure 26 illustrates the matrix connections within the LPC that realise the "path selector". For the case of SNC/I three matrix connections are required: (1) .. (3). For the case of SNC/N five matrix connections are required: (1) .. (5).

NOTE – The LPC interfaces A, B, C, D, E in Figure 26 represent the same interfaces in Figures 16 and 24.

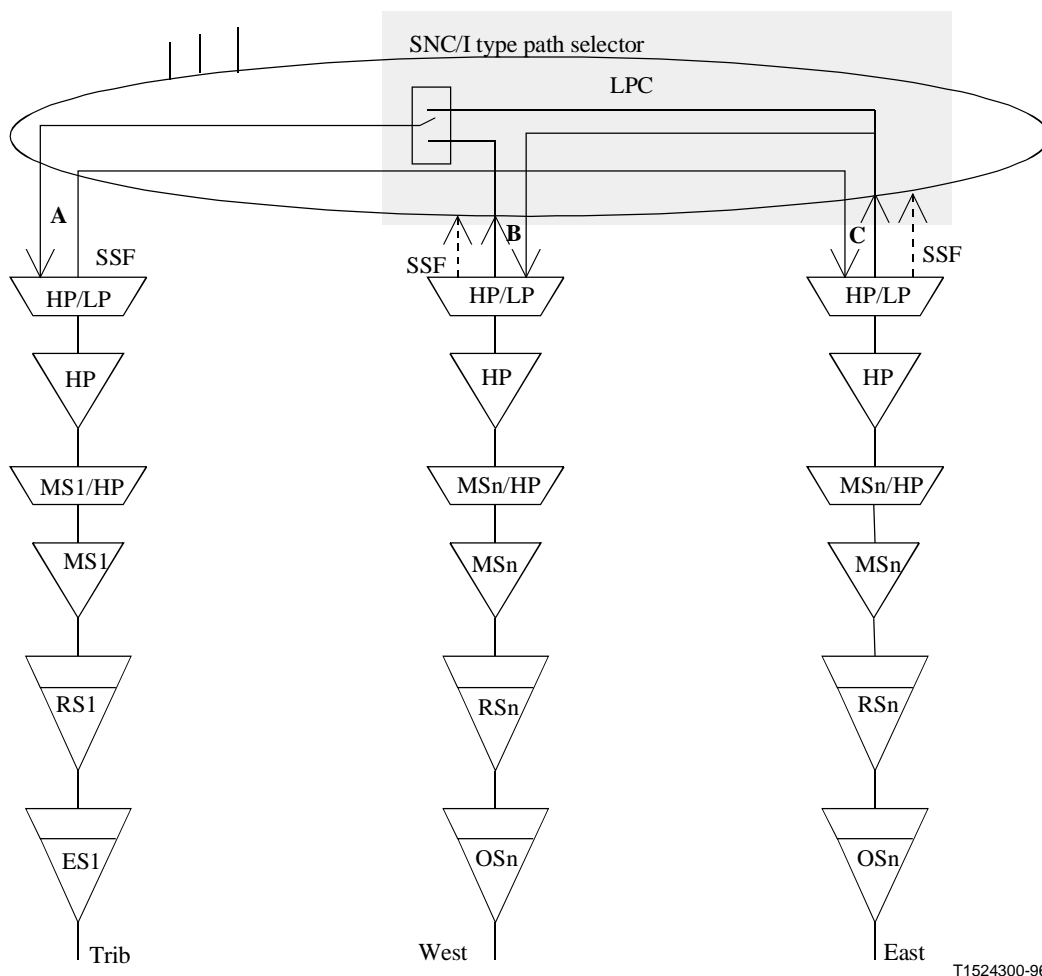
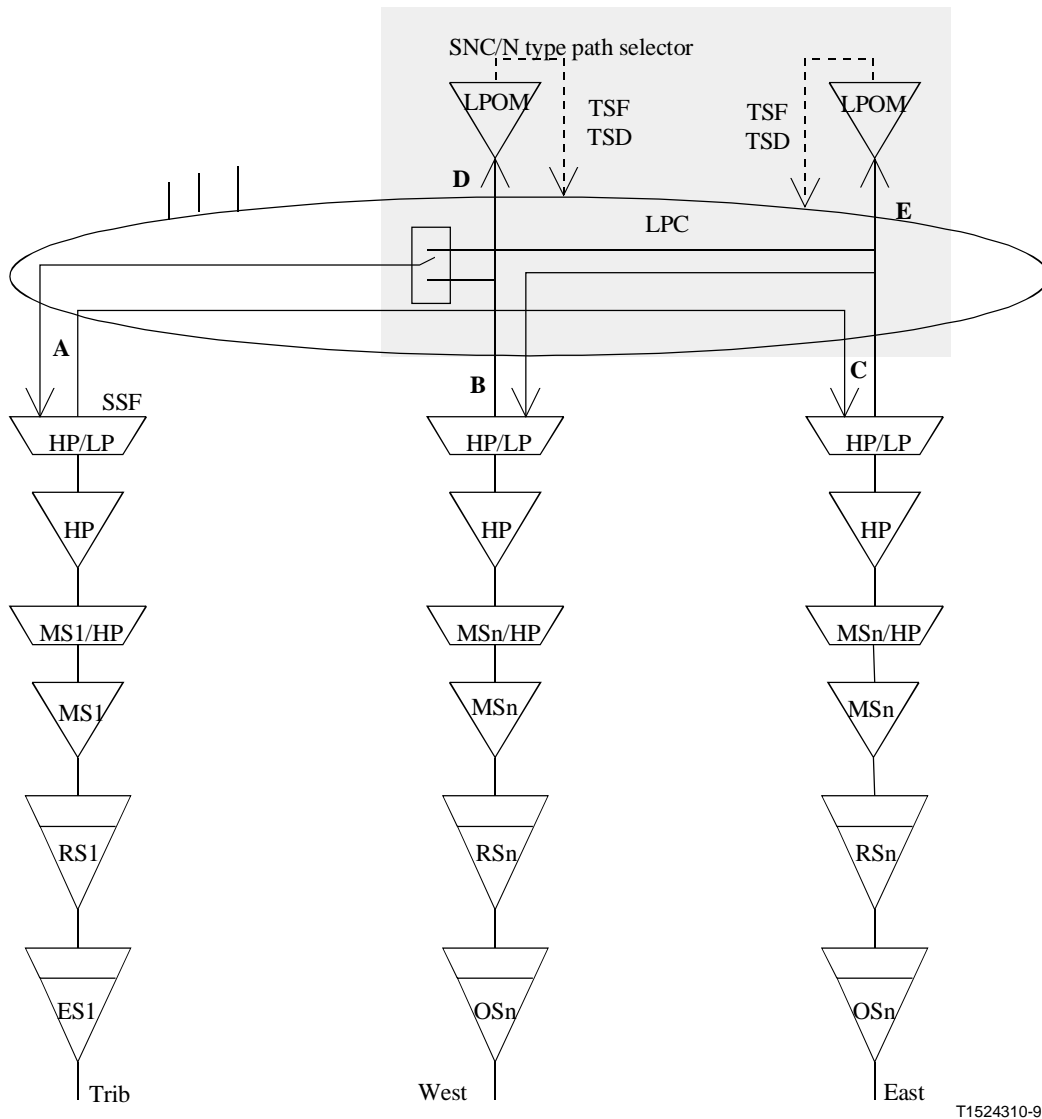
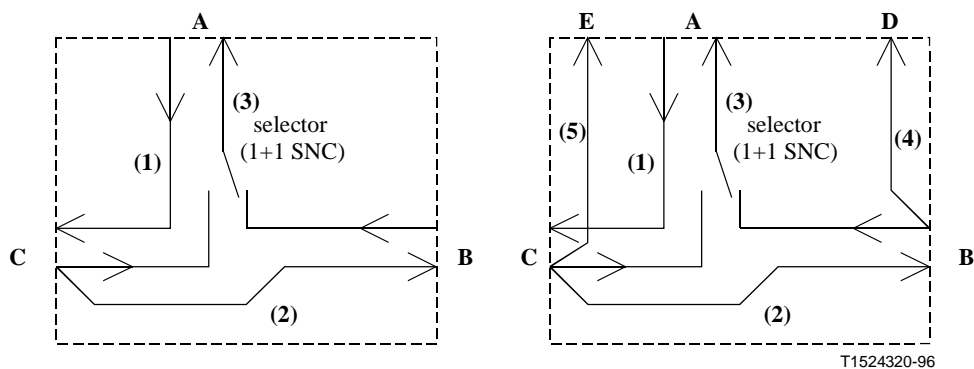

Figure 24/G.842 – Example of functional model for network element with path selector of type SNC/I



T1524310-96

Figure 25/G.842 – Example of functional model for network element with path selector of type SNC/N



T1524320-96

Figure 26/G.842 – Path selector's LPC connectivity

6.2.3.3 Switching criteria and operation

The switching criteria for the path selector in SNCP protection interworking is the same as for the service selector in MS-shared protection ring interworking. See 6.2.2.3.

6.2.4 Multiple rings

(One issue that may be described here is the mixing of traffic that is dual-node coupled with traffic that is only single-node coupled. Another is the interworking of rings that hand off LO VC traffic onto rings that incorporate this traffic into either HO SNC architectures, or MS-shared protection rings).

7 Interworking among network layers

[This clause describes the interworking between protection applications within different layers of the network (e.g. between MS-shared protection rings and VC trail protection).]

8 Switch contention

It is recognized that problems may occur due to contention between protection switch operation in interworking protection architectures. The contention may be inter-layer or intra-layer. This contention may result in multiple hits being introduced and may leave the switches in an indeterminate state. The outcome of the switching actions which are in contention is dependent upon the relative speed of operation of the protection switches and on the relative transmission delay on alternative routes. These problems may be solved by the use of hold-off times or by defining default positions for the switches (which would require revertive operation) in the absence of failures.

The detailed definition of these problems and the exploration of possible solutions are left for further study.

ITU-T RECOMMENDATIONS SERIES

Series A	Organization of the work of the ITU-T
Series B	Means of expression: definitions, symbols, classification
Series C	General telecommunication statistics
Series D	General tariff principles
Series E	Overall network operation, telephone service, service operation and human factors
Series F	Non-telephone telecommunication services
Series G	Transmission systems and media, digital systems and networks
Series H	Audiovisual and multimedia systems
Series I	Integrated services digital network
Series J	Transmission of television, sound programme and other multimedia signals
Series K	Protection against interference
Series L	Construction, installation and protection of cables and other elements of outside plant
Series M	TMN and network maintenance: international transmission systems, telephone circuits, telegraphy, facsimile and leased circuits
Series N	Maintenance: international sound programme and television transmission circuits
Series O	Specifications of measuring equipment
Series P	Telephone transmission quality, telephone installations, local line networks
Series Q	Switching and signalling
Series R	Telegraph transmission
Series S	Telegraph services terminal equipment
Series T	Terminals for telematic services
Series U	Telegraph switching
Series V	Data communication over the telephone network
Series X	Data networks and open system communication
Series Z	Programming languages