

## Recommendation

# **ITU-T G.8273.4/Y.1368.4 (2020) Amd. 2 (11/2022)**

SERIES G: Transmission systems and media, digital systems and networks

Packet over Transport aspects – Synchronization, quality and availability targets

SERIES Y: Global information infrastructure, Internet protocol aspects, next-generation networks, Internet of Things and smart cities

Internet protocol aspects – Transport

---

Timing characteristics of telecom boundary clocks and telecom time slave clocks for use with partial timing support from the network

**Amendment 2**



ITU-T G-SERIES RECOMMENDATIONS  
**TRANSMISSION SYSTEMS AND MEDIA, DIGITAL SYSTEMS AND NETWORKS**

|  |                      |
|--|----------------------|
| INTERNATIONAL TELEPHONE CONNECTIONS AND CIRCUITS   | G.100–G.199          |
| GENERAL CHARACTERISTICS COMMON TO ALL ANALOGUE CARRIER-TRANSMISSION SYSTEMS  | G.200–G.299          |
| INDIVIDUAL CHARACTERISTICS OF INTERNATIONAL CARRIER TELEPHONE SYSTEMS ON METALLIC LINES  | G.300–G.399          |
| GENERAL CHARACTERISTICS OF INTERNATIONAL CARRIER TELEPHONE SYSTEMS ON RADIO-RELAY OR SATELLITE LINKS AND INTERCONNECTION WITH METALLIC LINES | G.400–G.449          |
| COORDINATION OF RADIOTELEPHONY AND LINE TELEPHONY  | G.450–G.499          |
| TRANSMISSION MEDIA AND OPTICAL SYSTEMS CHARACTERISTICS   | G.600–G.699          |
| DIGITAL TERMINAL EQUIPMENTS  | G.700–G.799          |
| DIGITAL NETWORKS   | G.800–G.899          |
| DIGITAL SECTIONS AND DIGITAL LINE SYSTEM   | G.900–G.999          |
| MULTIMEDIA QUALITY OF SERVICE AND PERFORMANCE – GENERIC AND USER-RELATED ASPECTS   | G.1000–G.1999        |
| TRANSMISSION MEDIA CHARACTERISTICS   | G.6000–G.6999        |
| DATA OVER TRANSPORT – GENERIC ASPECTS  | G.7000–G.7999        |
| PACKET OVER TRANSPORT ASPECTS  | G.8000–G.8999        |
| Ethernet over Transport aspects  | G.8000–G.8099        |
| MPLS over Transport aspects  | G.8100–G.8199        |
| <b>Synchronization, quality and availability targets</b>   | <b>G.8200–G.8299</b> |
| Mobile network transport aspects   | G.8300–G.8399        |
| Service Management   | G.8600–G.8699        |
| ACCESS NETWORKS  | G.9000–G.9999        |

*For further details, please refer to the list of ITU-T Recommendations.*

# Recommendation ITU-T G.8273.4/Y.1368.4

## Timing characteristics of telecom boundary clocks and telecom time slave clocks for use with partial timing support from the network

### Amendment 2

#### Summary

Recommendation ITU-T G.8273.4/Y.1368.4 specifies minimum requirements for time and phase synchronization equipment used in synchronization networks that operates in the assisted partial timing support (APTS) and partial timing support (PTS) architectures.

Amendment 2 provides the following updates:

- Changes in clause 7.3
- Changes in clause 7.5
- Changes in clause 8.3
- Changes in clause 8.6.1
- Changes in clause 9
- Add a note in Annex B
- Changes in Appendix VI
- Adds Appendices VII and VIII

#### History

| Edition | Recommendation                        | Approval   | Study Group | Unique ID*  |
|---------|---------------------------------------|------------|-------------|---|
| 1.0     | ITU-T G.8273.4/Y.1368.4               | 2020-03-15 | 15          | <a href="http://handle.itu.int/11.1002/1000/14214">11.1002/1000/14214</a> |
| 1.1     | ITU-T G.8273.4/Y.1368.4 (2020) Amd. 1 | 2021-05-29 | 15          | <a href="http://handle.itu.int/11.1002/1000/14626">11.1002/1000/14626</a> |
| 1.2     | ITU-T G.8273.4/Y.1368.4 (2020) Amd. 2 | 2022-11-13 | 15          | <a href="http://handle.itu.int/11.1002/1000/15154">11.1002/1000/15154</a> |

#### Keywords

Assisted partial time support, boundary clock, partial time support, phase synchronization, time synchronization.

---

\* To access the Recommendation, type the URL <http://handle.itu.int/> in the address field of your web browser, followed by the Recommendation's unique ID. For example, <http://handle.itu.int/11.1002/1000/11830-en>.

## FOREWORD

The International Telecommunication Union (ITU) is the United Nations specialized agency in the field of telecommunications, information and communication technologies (ICTs). The ITU Telecommunication Standardization Sector (ITU-T) is a permanent organ of ITU. ITU-T is responsible for studying technical, operating and tariff questions and issuing Recommendations on them with a view to standardizing telecommunications on a worldwide basis.

The World Telecommunication Standardization Assembly (WTSA), which meets every four years, establishes the topics for study by the ITU-T study groups which, in turn, produce Recommendations on these topics.

The approval of ITU-T Recommendations is covered by the procedure laid down in WTSA Resolution 1.

In some areas of information technology which fall within ITU-T's purview, the necessary standards are prepared on a collaborative basis with ISO and IEC.

## NOTE

In this Recommendation, the expression "Administration" is used for conciseness to indicate both a telecommunication administration and a recognized operating agency.

Compliance with this Recommendation is voluntary. However, the Recommendation may contain certain mandatory provisions (to ensure, e.g., interoperability or applicability) and compliance with the Recommendation is achieved when all of these mandatory provisions are met. The words "shall" or some other obligatory language such as "must" and the negative equivalents are used to express requirements. The use of such words does not suggest that compliance with the Recommendation is required of any party.

## INTELLECTUAL PROPERTY RIGHTS

ITU draws attention to the possibility that the practice or implementation of this Recommendation may involve the use of a claimed Intellectual Property Right. ITU takes no position concerning the evidence, validity or applicability of claimed Intellectual Property Rights, whether asserted by ITU members or others outside of the Recommendation development process.

As of the date of approval of this Recommendation, ITU had not received notice of intellectual property, protected by patents/software copyrights, which may be required to implement this Recommendation. However, implementers are cautioned that this may not represent the latest information and are therefore strongly urged to consult the appropriate ITU-T databases available via the ITU-T website at <http://www.itu.int/ITU-T/ipr/>.

© ITU 2023

All rights reserved. No part of this publication may be reproduced, by any means whatsoever, without the prior written permission of ITU.

## Table of Contents

|     | <b>Page</b>  |
|-----|--|
| 1   | Scope ..... 1  |
| 2   | References..... 1  |
| 3   | Definitions ..... 2  |
| 3.1 | Terms defined elsewhere ..... 2  |
| 3.2 | Terms defined in this Recommendation..... 2  |
| 4   | Abbreviations and acronyms ..... 2   |
| 5   | Conventions ..... 3  |
| 6   | Physical layer frequency performance requirements..... 3   |
| 7   | Performance requirements for T-BC-A and T-TSC-A..... 4   |
| 7.1 | Frequency accuracy ..... 4   |
| 7.2 | Time error noise generation..... 4   |
| 7.3 | Noise tolerance ..... 5  |
| 7.4 | Local time reference (1PPS) to PTP and local time reference (1PPS) to<br>1PPS noise transfer..... 5  |
| 7.5 | PTP output and 1PPS output transient response (short term) due to loss and<br>restoration of local time reference (1PPS) input ..... 5             |
| 7.6 | Holdover performance..... 6  |
| 8   | Performance requirements for T-BC-P and T-TSC-P ..... 8  |
| 8.1 | Frequency accuracy ..... 8   |
| 8.2 | Time error noise generation..... 8   |
| 8.3 | Noise tolerance ..... 8  |
| 8.4 | Noise transfer..... 9  |
| 8.5 | Transient response (short-term)..... 9   |
| 8.6 | Holdover performance..... 10   |
| 9   | Interfaces..... 11   |
| 9.1 | Phase and time interfaces ..... 12   |
| 9.2 | Frequency interfaces..... 12   |
|     | Annex A – T-TSC-A and T-BC-A functional model ..... 13   |
|     | Annex B – T-TSC-P and T-BC-P functional model..... 16  |
|     | Appendix I – Consideration of slave clocks embedded in end applications..... 19  |
|     | Appendix II – Consideration of variable temperature testing..... 20  |
|     | Appendix III – Consideration of the use of a synchronous equipment clock to maintain<br>time holdover for partial timing support networks ..... 21 |
|     | Appendix IV – Use of a synchronous equipment clock to assist a PTP time lock..... 22   |
|     | Appendix V – Synchronization interworking function P-F node limits ..... 23  |
|     | Appendix VI – PTP noise tolerance testing for PTS and APTS clocks..... 24  |
|     | VI.1 Testing set-up for PTP noise tolerance testing..... 24  |

|  | <b>Page</b> |
|--|-------------|
| VI.2 Statistical PDV model .....   | 25          |
| VI.3 Parameters for the PDV model.....   | 26          |
| VI.4 Different requirements for APTS and PTS models.....   | 27          |
| VI.5 Example delay patterns.....   | 28          |
| VI.6 Output requirements .....   | 32          |
| Appendix VII – Analysis of conversion of network limits to equipment specification for<br>APTS ..... | 33          |
| VII.1 Total noise budget between network limits.....   | 33          |
| VII.2 Holdover operation.....  | 34          |
| VII.3 Transient operation and switching.....   | 35          |
| VII.4 Dynamic noise accumulation for APTS .....  | 35          |
| Appendix VIII – Analysis of conversion of network limits to equipment specification for<br>PTS ..... | 37          |
| VIII.1 Total noise between network limit C and network limit D .....                                 | 37          |
| VIII.2 Holdover operation.....   | 38          |
| VIII.3 Transient operation and switching.....  | 38          |
| VIII.4 Dynamic noise accumulation for PTS (constant temperature).....                                | 39          |
| Bibliography.....  | 40          |

# Recommendation ITU-T G.8273.4/Y.1368.4

## Timing characteristics of telecom boundary clocks and telecom time slave clocks for use with partial timing support from the network

### Amendment 2

*Editorial note: This is a complete-text publication. Modifications introduced by this amendment are shown in revision marks relative to Recommendation ITU T G.8273.4/Y.1368.4 (2020) and its Amendment 1.*

#### 1 Scope

This Recommendation specifies minimum requirements for time and phase synchronization equipment used in synchronization networks that operates in the assisted partial timing support (APTS) and partial timing support (PTS) architectures.

The APTS and PTS architectures are specified in [ITU-T G.8271], [ITU-T G.8271.2] and [ITU-T G.8275]. The applicable profile is established in [ITU-T G.8275.2], which specifies unicast PTS/APTS time or phase synchronization distribution for packet-based networks.

This Recommendation allows for proper network operation for phase/time synchronization distribution when a network equipment embedding an APTS or a PTS clock is timed from another telecom boundary clock (T-BC) or a telecom grandmaster (T-GM). This Recommendation specifies the minimum requirements for APTS and PTS clocks in network elements (NEs). These requirements apply under the normal environmental conditions specified for the equipment.

This Recommendation includes noise generation, noise tolerance, noise transfer, and transient response for APTS and PTS clocks.

Synchronous equipment clocks (per [ITU-T G.8262]) are optional in this Recommendation, and they are not used for APTS. For PTS, if a piece of equipment implements a synchronous equipment clock, as described in Appendix III and in Appendix IV, then the requirements in clause 8 still apply.

NOTE – For APTS, double failure (coincident failure of both global navigation satellite system (GNSS) and precision time protocol (PTP) input references) is not addressed in this Recommendation, except for short-term holdover scenarios (see clause 7.6.1) when the primary GNSS source is lost and a backup PTP source is temporarily unavailable. APTS double failure is for further study.

#### 2 References

The following ITU-T Recommendations and other references contain provisions which, through reference in this text, constitute provisions of this Recommendation. At the time of publication, the editions indicated were valid. All Recommendations and other references are subject to revision; users of this Recommendation are therefore encouraged to investigate the possibility of applying the most recent edition of the Recommendations and other references listed below. A list of the currently valid ITU-T Recommendations is regularly published. The reference to a document within this Recommendation does not give it, as a stand-alone document, the status of a Recommendation.

- [ITU-T G.703] Recommendation ITU-T G.703 (2016), *Physical/electrical characteristics of hierarchical digital interfaces.*
- [ITU-T G.709] Recommendation ITU-T G.709/Y.1331 (2020), *Interfaces for the optical transport network*
- [ITU-T G.781] Recommendation ITU-T G.781 (2020), *Synchronization layer functions for frequency synchronization based on the physical layer.*

- [ITU-T G.810] Recommendation ITU-T G.810 (1996), *Definitions and terminology for synchronization networks*.
- [ITU-T G.811] Recommendation ITU-T G.811 (1997), *Timing characteristics of primary reference clocks*.
- [ITU-T G.813] Recommendation ITU-T G.813 (2003), *Timing characteristics of SDH equipment slave clocks (SEC)*.
- [ITU-T G.8260] Recommendation ITU-T G.8260 (2022~~0~~), *Definitions and terminology for synchronization in packet networks*.
- [ITU-T G.8262] Recommendation ITU-T G.8262/Y.1362 (2018), *Timing characteristics of a synchronous equipment slave clock*.
- [ITU-T G.8264] Recommendation ITU-T G.8264/Y.1364 (2017), *Distribution of timing information through packet networks*.
- [ITU-T G.8271] Recommendation ITU-T G.8271/Y.1366 (2020), *Time and phase synchronization aspects of telecommunication networks*.
- [ITU-T G.8271.2] Recommendation ITU-T G.8271.2/Y.1366.2 (2021), *Network limits for time synchronization in packet networks with partial timing support from the network*.
- [ITU-T G.8272] Recommendation ITU-T G.8272/Y.1367 (2018), *Timing characteristics of primary reference time clocks*.
- [ITU-T G.8273.2] Recommendation ITU-T G.8273.2/Y.1368.2 (2022~~0~~), *Timing characteristics of telecom boundary clocks and telecom time slave clocks for use with full timing support from the network*.
- [ITU-T G.8275] Recommendation ITU-T G.8275/Y.1369 (2020), *Architecture and requirements for packet-based time and phase distribution*.
- [ITU-T G.8275.2] Recommendation ITU-T G.8275.2/Y.1369.2 (2022~~0~~), *Precision time protocol telecom profile for phase/time synchronization with partial timing support from the network*.

### **3 Definitions**

#### **3.1 Terms defined elsewhere**

This Recommendation uses the following terms defined elsewhere:

Terms related to synchronization are defined in [ITU-T G.810] and [ITU-T G.8260].

#### **3.2 Terms defined in this Recommendation**

None.

### **4 Abbreviations and acronyms**

This Recommendation uses the following abbreviations and acronyms:

|      |                                 |
|------|---------------------------------|
| APTS | Assisted Partial Timing Support |
| BMCA | Best Master Clock Algorithm     |
| cTE  | constant Time Error             |
| dTE  | dynamic Time Error              |



|         |  |
|---------|--|
| EEC     | Ethernet Equipment Clock                                     |
| ESMC    | Ethernet Synchronization Messaging Channel                   |
| GbE     | Gigabit Ethernet   |
| GNSS    | Global Navigation Satellite System                           |
| I/O     | Input/Output   |
| IWF     | Interworking Function  |
| MTIE    | Maximum Time Interval Error                                  |
| NE      | Network Element  |
| OSMC    | OTN Synchronization Message Channel                          |
| OTN     | Optical Transport Network                                    |
| PEC     | Packet-based Equipment Clock                                 |
| P-F     | PTS to full timing support (FTS)                             |
| PPS     | Pulse Per Second   |
| PRC     | Primary Reference Clock                                      |
| PRS     | Primary Reference Source                                     |
| PRTC    | Primary Reference Time Clock                                 |
| PTP     | Precision Time Protocol                                      |
| PTS     | Partial Timing Support                                       |
| SDH     | Synchronous Digital Hierarchy                                |
| SEC     | Synchronous digital hierarchy (SDH) Equipment slave Clock    |
| SSM     | Synchronization Status Message                               |
| STM-N   | Synchronous Transport Module – level N                       |
| SyncE   | Synchronous Ethernet   |
| T-BC    | Telecom Boundary Clock                                       |
| T-BC-A  | Telecom Boundary Clock for Assisted partial timing support   |
| T-BC-P  | Telecom Boundary Clock for Partial timing support            |
| TE      | Time Error   |
| T-GM    | Telecom Grandmaster  |
| ToD     | Time of Day  |
| T-TSC-A | Telecom Time Slave Clock for Assisted partial timing support |
| T-TSC-P | Telecom Time Slave Clock for Partial timing support          |

## 5 Conventions

None.

## 6 Physical layer frequency performance requirements

Synchronous equipment clock interfaces and the synchronous equipment clock are optional in this Recommendation. When used on the telecom time slave clock for partial timing support (T-TSC-P)

or telecom boundary clock for partial timing support (T-BC-P), the synchronous equipment clock shall meet the performance requirements specified in [ITU-T G.8262]. It shall generate and process Ethernet synchronization messaging channel (ESMC) messages as specified in [ITU-T G.8264]. For OTN equipment, it shall generate and process OTN synchronization message channel (OSMC) to transport SSM messages as specified in [ITU-T G.709].

Synchronous digital hierarchy (SDH) interfaces and SDH equipment clocks are optional. When used on the T-TSC-P or T-BC-P, the SDH equipment clocks shall meet the performance requirements specified in [ITU-T G.813], and shall generate and process synchronization status messages (SSMs) as specified in [ITU-T G.781].

## **7 Performance requirements for T-BC-A and T-TSC-A**

### **7.1 Frequency accuracy**

Under free-running conditions, the clock output frequency accuracy should not be greater than 4.6 ppm with respect to a reference traceable to a [ITU-T G.811] or [ITU-T G.8272] clock.

### **7.2 Time error noise generation**

The time error (TE) noise generation of a telecom boundary clock for assisted partial timing support (T-BC-A) and telecom time slave clock for assisted partial timing support (T-TSC-A) represents the amount of noise (i.e., TE) produced at the output of the T-BC-A/T-TSC-A when locked to an ideal, wander-free time reference at the 1 pulse per second (1PPS) or PTP time input (see Figure A.1). This is equivalent to having an external local time reference at reference point L as shown in Figure 1 of [ITU-T G.8271.2].

If an external local time reference is connected using a PTP timing signal instead of a 1PPS signal, the TE noise generation is for further study.

In the case of an integrated local time reference (e.g., a GNSS signal at the time input), there may not be an accessible 1PPS or PTP time input. In this case, the requirements of this clause are not applicable, except in the case of maximum TE noise generation, which is for further study.

The output of the T-BC-A is measured at both the 1PPS output and packet input/output (I/O) PTP master port; the output of the T-TSC-A is measured at the 1PPS output.

NOTE – The values in in this clause are valid for 1PPS interfaces and for 1 gigabit Ethernet (GbE), 10 GbE, 25 GbE, 40 GbE and 100 GbE interfaces. Values for other interfaces are for further study.

#### **7.2.1 Maximum absolute time error ( $\max|TE|$ ) noise generation**

Under normal, locked operating conditions, the time output of the T-BC-A and the T-TSC-A should be accurate to within the maximum absolute TE ( $\max|TE|$ ). This value includes all the noise components, i.e., the constant time error (cTE) and the dynamic time error (dTE).

The  $\max|TE|$  limit is for further study.

In the case of an integrated local time reference, the  $\max|TE|$  value is 100 ns greater than it would be for the case of an external local time reference. The total value is also for further study.

#### **7.2.2 Constant time error generation**

The permissible range of cTE noise generation is shown in Table 7-1.

**Table 7-1 – T-BC-A/T-TSC-A permissible range of constant time error**

| <b>T-BC-A/T-TSC-A class</b> | <b>Permissible range of cTE (ns)</b> |
|-----------------------------|--------------------------------------|
| A                           | ±50                                  |
| B                           | ±20                                  |

NOTE 1 – The cTE definition and its method of estimation are given in [ITU-T G.8260]. For the purpose of testing the limits in Table 7-1, an estimate of cTE should be obtained by averaging the TE sequence over at least 10 000 s.

NOTE 2 – The cTE is measured at constant temperature (within ±1 K).

### **7.2.3 Dynamic time error low-pass filtered noise generation**

The dynamic TE low-pass filtered noise generation ( $dTE_L$ ) is a maximum of 50 ns peak-to-peak.

NOTE – This should be measured under constant temperature (within ±1 K) and using a first-order low-pass measurement filter with a bandwidth of 0.1 Hz for a minimum of 10 000 s.

### **7.2.4 Dynamic time error high-pass filtered noise generation**

The dynamic TE high-pass filtered noise generation ( $dTE_H$ ) is for further study.

## **7.3 Noise tolerance**

The noise tolerance of the equipment clock indicates the minimum TE level at the input of the clock that should be accommodated while not causing:

- any alarms;
- the clock to switch reference;
- the clock to go into holdover.

An equipment clock must be capable of tolerating the following levels of noise at its time input:

- $\max|TE|$  according to clause 7.1 of [ITU-T G.8271.2] network limit

NOTE 1 – This requirement on the time input is not applicable in the case of an integrated local time reference (e.g., a GNSS signal at the time input).

In the event of failure of the time input, when the backup PTP input is selected, an equipment clock must be capable of tolerating the following levels of noise at its PTP input:

- peak-to-peak  $\text{pktSelected2wayTE}$  according to clause 7.3.1 of [ITU-T G.8271.2] network limit

In addition, a T-TSC-A and a T-BC-A must maintain the  $\max|TE_L|$  at its 1PPS output-(s), and in the case of a T-BC-A on its PTP output(s), below the level indicated in clause 7.4.1 of [ITU-T G.8271.2].

NOTE 2 – To compute  $\max|TE_L|$ , a first-order low-pass measurement filter with bandwidth of 0.1 Hz is used, and it is applied to the TE samples measured at the 1PPS output and PTP output(s) prior to evaluating the  $\max|TE|$ .

## **7.4 Local time reference (1PPS) to PTP and local time reference (1PPS) to 1PPS noise transfer**

The phase gain of the T-BC-A or T-TSC-A should be smaller than 0.1 dB (1.1%).

## **7.5 PTP output and 1PPS output transient response (short term) due to loss and restoration of local time reference (1PPS) input**

The requirements in this clause reflect the performance of the clock if the local time reference input is ideal.

The response of the T-BC-A and T-TSC-A due to the loss and restoration of the local time reference may be generalized by the following sequence of events:

- the clock is locked to the local time reference;
- the local time reference is lost;
- the clock enters holdover;
- the clock maintains holdover state;
- the local time reference is restored;
- the clock selects the local time reference;
- the clock is locked to the local time reference.

The following requirements apply:

- 1) ~~upon loss of the local time reference, the initial transient response needs to be less than 22 ns. This is referenced in clause 7.6 as parameter 'c' the transient response due to the loss of the local time reference shall be less than 22 ns maximum time interval error (MTIE);~~
- 2) ~~in addition, the phase error needs to be within the requirements of clause 7.6 for the duration of the loss of the local time reference the period of loss of the local time reference while in holdover shall comply with clause 7.6;~~
- 3) ~~upon restoration of the local time reference, the phase is corrected to align with the local time reference and eliminate the phase error accumulated during holdover. The allowed transient response of the clock depends on the duration of the loss of the local time reference and the allowed phase error during holdover as specified in clause 7.6 the transient response due to the restoration of the local time reference shall be less than 22 ns MTIE.~~

## 7.6 Holdover performance

### 7.6.1 Holdover based on oscillator

This requirement bounds the maximum excursions in the output timing signal.

It specifies the phase/time performance of the T-BC-A or T-TSC-A clock if an ideal local time reference input is disconnected, and the backup PTP time source from the network cannot be used (e.g., during a switching process or very short unavailability of the PTP source). This offers temporary assistance (up to the limit indicated in Figure 7-1) to maintain phase/time previously set by the primary master. Other failure scenarios are for further study, including that in which the primary GNSS source is the first to be lost and the PTP is used as backup source for some time before finally failing.

When a T-BC-A or T-TSC-A clock loses all its references, it enters the holdover state. The phase error,  $\Delta T$ , at the output of T-BC-A/T-TSC-A relative to the input at the moment of loss of reference should meet the following:

$$|\Delta T(t)| \leq [(a_1 + a_2)t + 0.5bt^2 + c] \quad (\text{ns})$$

where:

- $a_1$  = 1 ns/s (see Note 1);
- $a_2$  = for further study (see Note 2);
- $b$  =  $1.16 \times 10^{-5}$  ns/s<sup>2</sup> (see Note 3);
- $c$  = 22 ns (see Note 4).

NOTE 1 – The frequency offset  $a_1$  represents an initial frequency offset corresponding to 1 ns/s.

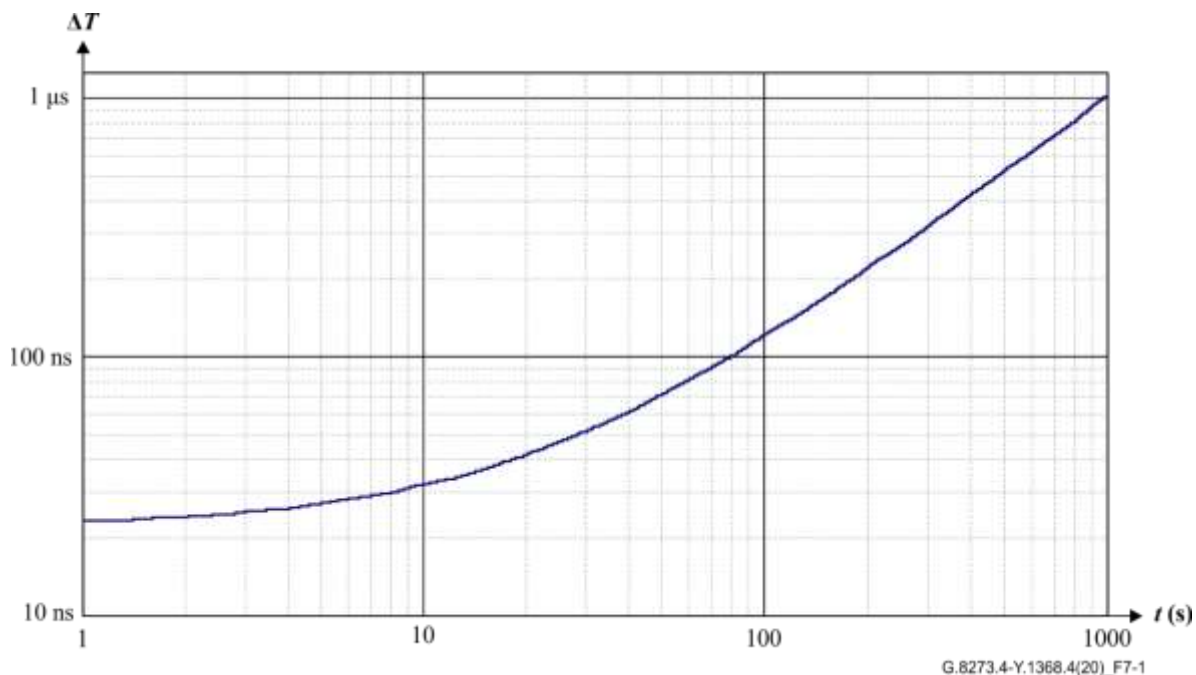
NOTE 2 – The frequency offset  $a_2$  accounts for temperature variations after the clock goes into holdover and requires further study. If there are no temperature variations, the term  $a_2$  should not contribute to the phase error; thus for constant temperature,  $a_2 = 0$  ns/s.

NOTE 3 – The drift  $b$  is caused by ageing:  $1.16 \times 10^{-5}$  ns/s<sup>2</sup> corresponds to a frequency drift of  $1 \times 10^{-9}$ /day (1 ppb/day).

NOTE 4 – The phase offset  $c$  takes accounts for any additional phase shift that may arise during the transition at the entry into and exit from the holdover state.

Under constant temperature conditions (within  $\pm 1$  K) the maximum observation interval is 1 000 s. The resultant overall requirement for constant temperature (i.e., when the temperature effect is negligible) is summarized in Figure 7-1.

$$|\Delta T(t)| \leq (a_1 t + 0.5 b t^2 + c) \quad (\text{ns})$$



**Figure 7-1 – Permissible phase error under holdover operation at constant temperature**

### 7.6.2 Holdover based on PTP

This clause describes the phase/time performance of a T-BC-A or T-TSC-A during loss of the local time reference based on the use of a PTP input as a backup source of time or frequency.

This requirement reflects the performance of the clock if the local time reference input is ideal followed by disconnection of the local time reference input after a stabilization period. The PTP input is ideal.

Under constant temperature conditions (within  $\pm 1$  K) the maximum observation interval is 10 000 s.

**Table 7-2 – Performance allowance during loss of local time reference input (MTIE) for T-BC-A or T-TSC-A with constant temperature**

| MTIE limit (ns)  | Observation interval $\tau$ (s) |
|--|---------------------------------|
| $200 + c$  | $1 \leq \tau \leq 10\,000$      |
| <p>Here <math>c = 22</math> ns (see Note 1).</p> <p>NOTE 1 – The phase offset <math>c</math> is associated with the phase transient response from clause 7.5.</p> <p>NOTE 2 – The main contributor to the holdover performance is the noise generation of the equipment clock when locked to a PTP input. The value of 200 ns is consistent with the noise generation in clause 8.2.3.</p> |                                 |

## 8 Performance requirements for T-BC-P and T-TSC-P

### 8.1 Frequency accuracy

Under free-running conditions, the clock output frequency accuracy should not be greater than 4.6 ppm with respect to a reference traceable to a [ITU-T G.811] or [ITU-T G.8272] clock.

### 8.2 Time error noise generation

The TE noise generation of a T-BC-P or T-TSC-P represents the amount of noise (i.e., TE) produced at the output of the T-BC-P or T-TSC-P when locked to an ideal, wander-free PTP time reference at the packet I/O PTP slave port (see Figure B.1).

The output of the T-BC-P is measured at both the 1PPS output and packet I/O PTP master port; the output of the T-TSC-P is measured at the 1PPS output.

NOTE – The values in this clause are valid for 1PPS interfaces and for 1 GbE, 10 GbE, 25 GbE, 40 GbE and 100 GbE interfaces. Values for other interfaces are for further study.

#### 8.2.1 Maximum absolute time error noise generation (max|TE|)

Under normal, locked operating conditions, the time output of the T-BC-P and the T-TSC-P should be accurate to within the max|TE| limit. This value includes all the noise components, i.e., the cTE and the dTE.

The max|TE| noise generation limit is for further study.

#### 8.2.2 Constant time error noise generation

The permissible range of cTE noise generation is shown in Table 8-1.

**Table 8-1 – T-BC-P/T-TSC-P permissible range of constant time error**

| T-BC-P/T-TSC-P class | Permissible range of cTE (ns) |
|----------------------|-------------------------------|
| A                    | ±50                           |
| B                    | ±20                           |

NOTE 1 – The definition of cTE and its method of estimation are found in clause 3.1.20 of [ITU-T G.8260]. For the purpose of testing the limits in Table 8-1, an estimate of cTE should be obtained by averaging the TE sequence over at least 10 000 s.

NOTE 2 – The cTE is measured at constant temperature (within ±1 K).

#### 8.2.3 Dynamic time error low-pass filtered noise generation

The dTE<sub>L</sub> is a maximum of 200 ns peak-to-peak.

NOTE – This should be measured under constant temperature (within ±1 K) and using a first-order low-pass measurement filter with a bandwidth of 0.1 Hz for a minimum of 10 000 s.

#### 8.2.4 Dynamic time error high-pass filtered noise generation

The dTE<sub>H</sub> is for further study.

### 8.3 Noise tolerance

The noise tolerance of the equipment clock indicates the minimum TE level at the input of the clock that should be accommodated while not causing:

- any alarms;
- the clock to switch reference;
- the clock to go into holdover.

An equipment clock must be capable of tolerating the following levels of noise at its input:

- $\max|\text{pktSelected2wayTE}|$  according to the network limit given in clause 7.3.2.1 of [ITU-T G.8271.2] at the PTP input;
- wander tolerance according to clause 9.1 of [ITU-T G.8262] at the synchronous equipment clock input;

In addition, a T-TSC-P and a T-BC-P must maintain the  $\max|\text{TE}_L|$  at its 1PPS output(s), and in the case of a T-BC-P on its PTP output(s), below the level indicated in clause 7.4.2 of [ITU-T G.8271.2].

NOTE – To compute  $\max|\text{TE}_L|$ , a first-order low-pass measurement filter with bandwidth of 0.1 Hz is used, applied to the TE samples measured at the 1PPS output and PTP output(s) prior to evaluating the  $\max|\text{TE}|$ .

## **8.4 Noise transfer**

### **8.4.1 PTP to PTP and PTP to 1PPS noise transfer**

The phase gain of the T-BC-P or T-TSC-P should be smaller than 0.1 dB (1.1%).

### **8.4.2 Physical layer frequency assistance to PTP and physical layer frequency assistance to 1PPS noise transfer**

The noise transfer specification in the case of physical layer frequency assistance is for further study. For more information on the use of synchronous Ethernet (SyncE) to assist a partially aware clock, refer to Appendix IV.

## **8.5 Transient response (short-term)**

### **8.5.1 PTP output and 1PPS output transient response due to loss and restoration or switching of PTP input**

The requirements in this clause reflect the performance of the clock if the PTP input is ideal.

The response of the T-BC-P and T-TSC-P due to the loss and restoration of PTP may be generalized by the following sequence events:

- the clock is locked to a PTP reference;
- the PTP reference is lost;
- the clock enters holdover;
- the clock maintains holdover state;
- a PTP reference is available;
- the clock selects the PTP reference;
- the clock is locked to the PTP reference.

The following requirements apply:

- 1) the transient response due to the loss of the PTP reference shall be less than 22 ns MTIE;
- 2) the period of loss of PTP while in holdover shall comply with clause 8.6;
- 3) the transient response due to the restoration of the PTP shall be less than 22 ns MTIE.

### **8.5.2 PTP output and 1PPS output transient response due to switching physical layer input while maintaining PTP input**

PTP output and 1PPS output transient response due to switching physical layer input while maintaining PTP input are for further study.

### 8.5.3 PTP output and 1PPS output transient response due to switching simultaneously the physical layer input and the PTP input

PTP output and 1PPS output transient response due to switching physical layer input while maintaining PTP input are for further study.

## 8.6 Holdover performance

### 8.6.1 Holdover based on oscillator

The phase/time performance during loss of the PTP input based on a local oscillator applicable to a T-BC-P or T-TSC-P is as follows.

This requirement bounds the maximum excursions in the output timing signal.

This requirement reflects the performance of the clock if the PTP input is ideal, followed by disconnection of the PTP input.

When a T-BC-P or T-TSC-P clock loses all its references, it enters the holdover state. The phase error,  $\Delta T$ , at the output of the T-BC-P/T-TSC-P relative to the input at the moment of loss of reference should meet the following condition:

$$|\Delta T(t)| \leq [(a_1 + a_2)t + 0.5bt^2 + c] \quad (\text{ns})$$

where:

$$a_1 = 1 \text{ ns/s (see Note 1);}$$

$$a_2 = \text{for further study (see Note 2);}$$

$$b = 1.16 \times 10^{-5} \text{ ns/s}^2 \text{ (see Note 3);}$$

$$c = 22 \text{ ns (see Note 4).}$$

NOTE 1 – The frequency offset  $a_1$  represents an initial frequency offset corresponding to 1 ns/s.

NOTE 2 – The frequency offset  $a_2$  accounts for temperature variations after the clock went into holdover and requires further study. If there are no temperature variations, the term  $a_2$  should not contribute to the phase error; thus for constant temperature,  $a_2 = 0$  ns/s.

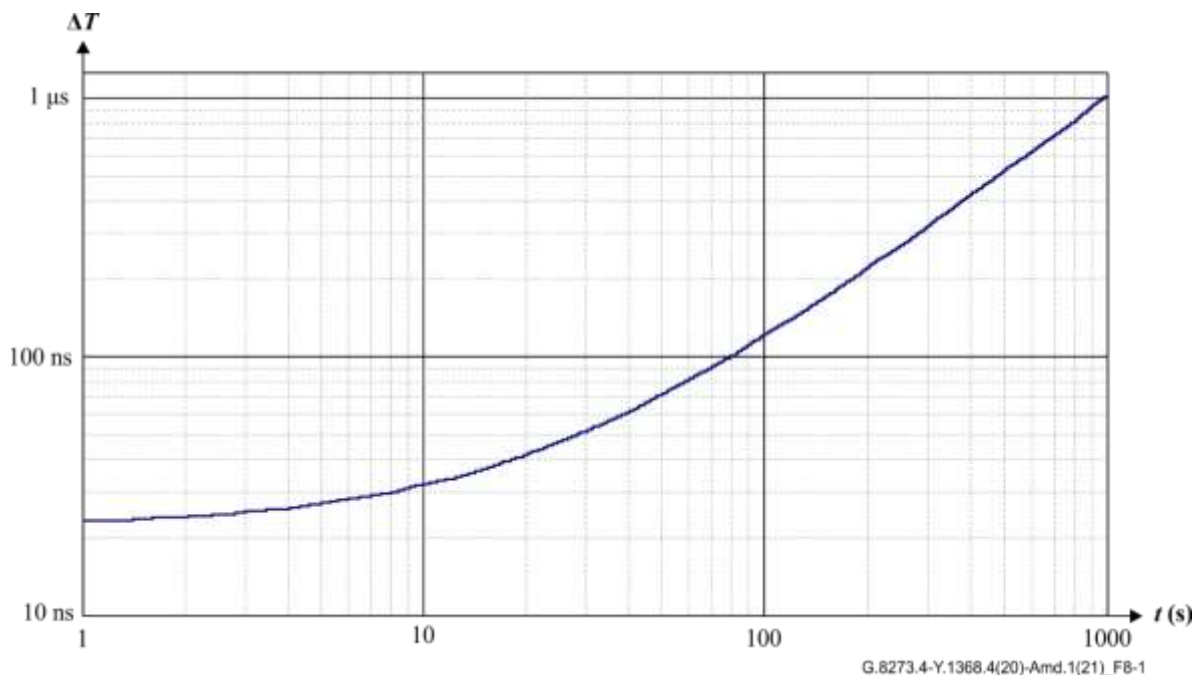
NOTE 3 – The drift  $b$  is caused by ageing:  $1.16 \times 10^{-5} \text{ ns/s}^2$  corresponds to a frequency drift of  $1 \times 10^{-9}$ /day (1 ppb/day).

NOTE 4 – The phase offset  $c$  accounts for any additional phase shift that may arise during the transition at the entry into and exit from the holdover state.

Under constant temperature conditions (within  $\pm 1$  K), the maximum observation interval is 1 000 seconds. The resultant overall requirement for constant temperature (i.e., when the temperature effect is negligible) is summarized in Figure 8-1.

$$|\Delta T(t)| \leq (a_1t + 0.5bt^2 + c) \quad (\text{ns})$$





**Figure 8-1 – Permissible phase error under holdover operation at constant temperature**

### 8.6.2 Holdover based on physical layer frequency assistance

When a T-BC-P or T-TSC-P loses all of its input phase and time references, it enters the phase/time holdover state. Under these circumstances, the T-BC-P or T-TSC-P may rely on a physical layer frequency assistance reference traceable to a primary reference clock (PRC).

This requirement reflects the performance of the clock if an ideal PTP input is disconnected. The physical layer frequency input is also ideal.

The requirements on phase/time performance during loss of the PTP input reference are defined in clause 7.4.2.2 of [ITU-T G.8273.2].

## 9 Interfaces

The requirements in this Recommendation are related to reference points that may be internal to the equipment or NE in which the T-BC-A, T-BC-P, T-TSC-A or T-TSC-P is embedded and are therefore not necessarily available for measurement or analysis by the user. Consequently, the performance of the T-BC-A, T-BC-P, T-TSC-A or T-TSC-P is not specified at these internal reference points, but rather at the external interfaces of the equipment.

Note that not all interfaces mentioned in this clause need to be implemented on all equipment.

Table 9-1 summarizes the differences with respect to interfaces between different clock types and the applicability of clauses of this Recommendation to the T-TSC-A, T-TSC-P, T-BC-A and T-BC-P equipment clocks. The following terms are used:

- "applicable" means requirements apply to the clock;
- "optional" means requirements apply to the clock if the optional local time reference input is supported;
- "not Applicable" means that the PTP output is not available on the equipment clock.

**Table 9-1 – Differences with respect to interfaces between different clock types**

| Equipment clock | Local time reference input | PTP output     |
|-----------------|----------------------------|----------------|
| T-TSC-A         | Applicable                 | Not applicable |
| T-TSC-P         | Not applicable             | Not applicable |
| T-BC-A          | Applicable                 | Applicable     |
| T-BC-P          | Not applicable             | Applicable     |

### 9.1 Phase and time interfaces

The phase and time interfaces specified for the equipment in which the T-BC-A, T-BC-P, T-TSC-A or T-TSC-P may be contained are:

- Ethernet interface carrying PTP messages;  
NOTE – Ethernet interfaces can combine SyncE for frequency and PTP messages. These interfaces may also carry other traffic in addition to PTP traffic.
- ITU-T V.11-based time/phase distribution interface, as specified in [ITU-T G.703] and [ITU-T G.8271];
- 1PPS 50  $\Omega$  phase-synchronization measurement interface, as specified in [ITU-T G.703] and [ITU-T G.8271];
- Interface carrying GNSS signal;
- other interfaces are for further study.

### 9.2 Frequency interfaces

The frequency interfaces specified for the equipment in which the T-BC-P, or T-TSC-P may be contained are:

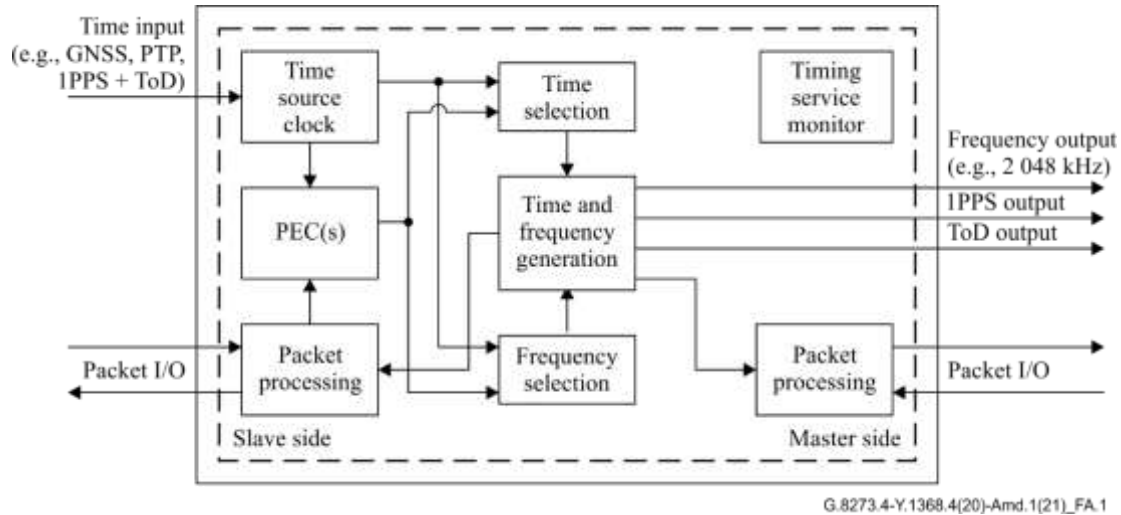
- 2 048 kHz interfaces according to [ITU-T G.703] with additional wander requirements as specified herein;
- 1 544 kbit/s interfaces according to [ITU-T G.703] with additional wander requirements as specified herein;
- 2 048 kbit/s interfaces according to [ITU-T G.703] with additional wander requirements as specified therein;
- synchronous transport module – level N (STM-N) traffic interfaces;
- SyncE interfaces;  
NOTE – Ethernet interfaces can combine PTP and SyncE. These interfaces may also carry other traffic in addition to PTP and ESMC traffic.
- other interfaces are for further study.

## Annex A

### T-TSC-A and T-BC-A functional model

(This annex forms an integral part of this Recommendation.)

Figure A.1 illustrates the T-TSC-A and T-BC-A functional model.



**Figure A.1 – The T-TSC-A and T-BC-A functional model**

NOTE 1 – Figure A.1 is a functional model. It is not intended to specify any specific implementation. Any implementation specific detail lies outside the scope of this Recommendation.

NOTE 2 – Not all interfaces are required to be present in an implementation.

NOTE 3 – Not all functional blocks are required to be present in an implementation.

NOTE 4 – The functional model shows interfaces that lie within the scope of this Recommendation; additional functions and interfaces can be integrated in a specific implementation, but are not shown in the functional model.

Table A.1 describes the functionality of the blocks depicted in Figure A.1.

**Table A.1 – T-TSC-A and T-BC-A clock model functional blocks**

| Functional block label        | Functionality   |
|-------------------------------|---|
| Time and frequency generation | Generates the local time scale of the clock (local PTP clock) using the time source information supplied by the time selection block and frequency source information supplied by the frequency selection block.  |
| Time selection                | Selects the local time source to be used by the clock from among various possible available time inputs. In normal deployment, the time source clock will be the primary time input, with the PEC providing a secondary time source for backup purposes.. This block may support combining more than one time source. |
| Frequency selection           | Selects the local frequency source to be used by the clock from among various possible available frequency inputs. In normal deployment, the time source clock will be the primary frequency input, with the PEC providing a secondary frequency source for backup.   |

**Table A.1 – T-TSC-A and T-BC-A clock model functional blocks**

| Functional block label | Functionality   |
|------------------------|---|
| Packet processing      | <p>On the slave side, processes ingress PTP packets according to the PTP profile and passes the timestamps from these PTP packets to the PEC. Generates egress PTP packets according to the PTP profile and passes the timestamps from these PTP packets to the PEC.</p> <p>In the case of the T-BC-A, on the master side, processes ingress PTP packets and generates egress PTP packets according to the PTP profile. Time-stamping is based on the local time scale (local PTP clock) provided by the time and frequency generation block.</p> |
| Timing service monitor | <p>Provides monitoring of the timing service received by the clock according to key performance indicators. As an example, it may monitor the PTP timing service by analysing the PTP timestamps from the packet processing block (slave side) when the local time scale is following a stable time reference source from the time source clock.</p>  |
| Time source clock      | <p>Synchronizes to a time reference (e.g., GNSS, PTP, 1PPS and time of day (ToD)) and provides this as a time reference to the time selection block, as well as a frequency reference to the frequency selection block. Provides time reference to the PEC(s) for asymmetry compensation.</p>   |
| PEC(s)                 | <p>Synchronizes to a PTP master, using PTP timestamps from the packet processing (slave side) block, and provides this as a time reference to the time selection block or as a frequency reference to the frequency selection block. Receives time reference from the time source clock for asymmetry compensation.</p>   |

Table A.2 describes the functionality of the interfaces depicted in Figure A.1.

**Table A.2 – T-TSC-A and T-BC-A clock model external interfaces**

| External interfaces label                   | Functionality   |
|---|---|
| Packet I/O                                  | <p>Interfaces to transmit and receive PTP packets from the packet processing block. On the slave side, it will act as a PTP port in the slave state to interact with external PTP master devices, and on the master side it will act as a PTP port in the master state to interact with external PTP slave devices. The PTP reference received on the slave port is used as a backup time or frequency reference in the event of a failure of the primary time input reference.</p> |
| Time input<br>(e.g., GNSS, PTP, 1PPS + ToD) | <p>Time interface to receive from applicable interfaces available on the clock (e.g., GNSS, PTP, 1PPS phase input and ToD serial time information). Provides timing information to the time source clock block. This interface is the primary time and frequency input reference to the device. This interface corresponds to reference point L in Figure 1 of [ITU-T G.8271.2].</p>  |

**Table A.2 – T-TSC-A and T-BC-A clock model external interfaces**

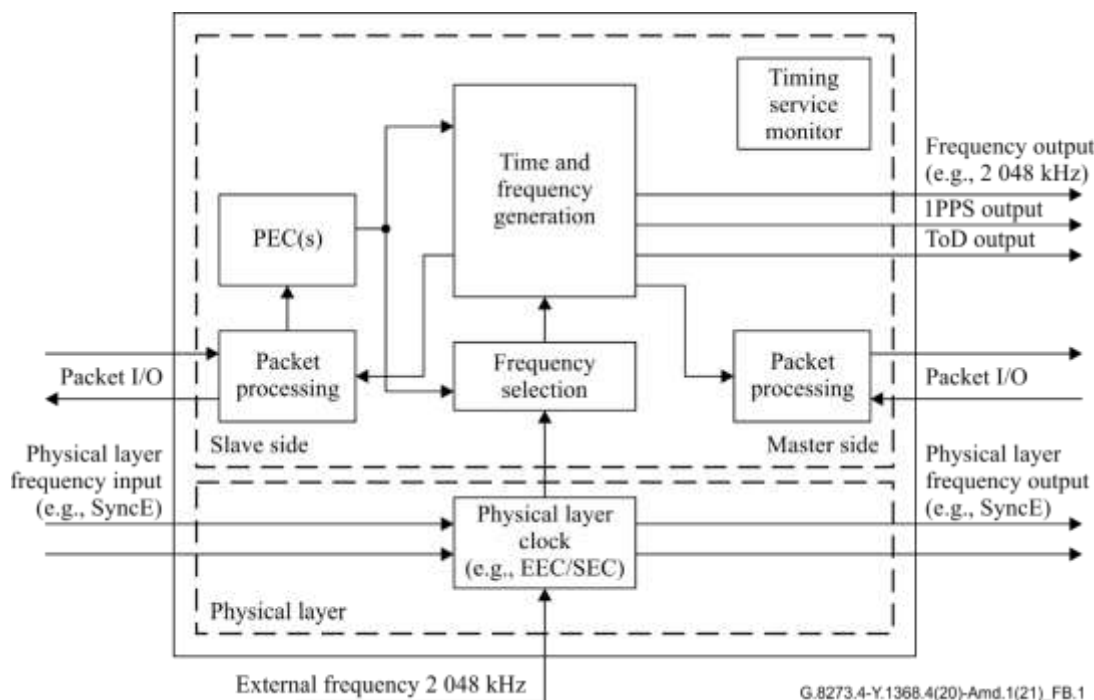
| <b>External interfaces label</b>      | <b>Functionality</b>   |
|---------------------------------------|--|
| 1PPS output                           | 1PPS phase output ([ITU-T G.703]) generated by the time and frequency generation block.  |
| ToD output                            | ToD serial time information output generated by the time and frequency generation block.   |
| Frequency output<br>(e.g., 2 048 kHz) | Frequency output (e.g., [ITU-T G.703] 2 048 kHz) provides frequency information. Generated by the time and frequency generation block. |

## Annex B

### T-TSC-P and T-BC-P functional model

(This annex forms an integral part of this Recommendation.)

Figure B.1 illustrates the T-TSC-P and T-BC-P functional model.



**Figure B.1 – T-TSC-P and T-BC-P functional model**

NOTE 1 – Figure B.1 is a functional model. It is not intended to specify any specific implementation. Any implementation specific detail lies outside the scope of this Recommendation.

NOTE 2 – Not all interfaces are required to be present in an implementation.

NOTE 3 – Not all functional blocks are required to be present in an implementation.

NOTE 4 – The functional model shows interfaces that lie within the scope of this Recommendation; additional functions and interfaces can be integrated in a specific implementation, but are not shown in the functional model.

Table B.1 describes the functionality of the blocks depicted in Figure B.1.

**Table B.1 – T-TSC-P and T-BC-P clock model functional blocks**

| Functional block label        | Functionality  |
|-------------------------------|--|
| Time and frequency generation | Generates the local time scale of the clock (local PTP clock) using the time source information supplied by the time selection block and frequency source information supplied by the frequency selection block. |
| Frequency selection           | Selects the local frequency source to be used by the clock from among various possible available frequency inputs, including the time source clock, PEC and physical layer clock.                                |

**Table B.1 – T-TSC-P and T-BC-P clock model functional blocks**

| Functional block label  | Functionality  |
|---|--|
| Packet processing   | <p>On the slave side, processes ingress PTP packets according to the PTP profile and passes the timestamps from these PTP packets to the PEC. Generates egress PTP packets according to the PTP profile and passes the timestamps from these PTP packets to the PEC.</p> <p>In the case of the T-BC-P, on the master side, processes ingress PTP packets and generates egress PTP packets according to the PTP profile.</p> <p>Time-stamping is based on the local time scale (local PTP clock) provided by the time and frequency generation block.</p> |
| Timing service monitor  | <p>Provides monitoring of the timing service received by the clock according to key performance indicators. As an example, it may monitor the PTP timing service by analysing the PTP timestamps from the packet processing block (slave side) when the local time scale is following a stable time reference source from the time source clock.</p>   |
| PEC   | <p>Synchronizes to a PTP master, using PTP timestamps from the packet processing (slave side) block, and provides this as a time reference to the time selection block or as a frequency reference to the frequency selection block.</p>   |
| Physical layer clock<br>(e.g., Ethernet equipment clock (EEC)/synchronous digital hierarchy (SDH) equipment clock ) | <p>Synchronizes to a physical layer frequency input or external frequency input and provides this as a frequency reference to the frequency selection block. Includes selection among various frequency inputs when more than one source is available. It would typically implement a synchronous clock as specified in [ITU-T G.8262]/[ITU-T G.813].</p>  |

Table B.2 describes the functionality of the interfaces depicted in Figure B.1.

**Table B.2 – T-TSC-P and T-BC-P clock model external interfaces**

| External interfaces label  | Functionality   |
|--|---|
| Packet I/O   | Interfaces to transmit and receive PTP packets from the packet processing block. On the slave side, it acts as a PTP port in the slave state to interact with external PTP master devices; on the master side, it acts as a PTP port in the master state to interact with external PTP slave devices. |
| 1PPS output  | 1PPS phase output ([ITU-T G.703]) generated by the time and frequency generation block.   |
| ToD output   | ToD serial time information output generated by the time and frequency generation block.  |
| Frequency output<br>(e.g., 2 048 kHz)  | Frequency output (e.g., [ITU-T G.703] 2 048 kHz) provides frequency information. Generated by the time and frequency generation block. <u>(Note)</u>  |
| Physical layer frequency input<br>(e.g., SyncE)  | Physical layer frequency input from applicable interfaces available on the clock (e.g., SyncE). Provides frequency information to the physical layer clock block.   |
| Physical layer frequency output<br>(e.g., SyncE)   | Physical layer frequency output provides frequency information on applicable interfaces available on the clock (e.g., SyncE). Generated from the physical layer clock block.  |
| External frequency input<br>(e.g., 2 048 kHz)  | External frequency input from applicable interfaces available on the clock (e.g., [ITU-T G.703] 2 048 kHz or 2 048 kbit/s). Provides frequency information to the physical layer clock block.   |
| <p><u>NOTE – The frequency output may be used to provide frequency to the end application described in Appendix IV.1 of [ITU-T G.8275]. The performance of the frequency output as shown in Figure IV.1 of [ITU-T G.8275], and whether it meets the required network limits (see clause 9.2.2 of [ITU-T G.8261]), are for further study.</u></p> |   |



## **Appendix I**

### **Consideration of slave clocks embedded in end applications**

(This appendix does not form an integral part of this Recommendation.)

A [ITU-T G.8271.2] time synchronization deployment is comprised of many network clocks, such as a primary reference time clock (PRTC), T-GM, T-BC-P, other modules without timing support, T-TSC-A and TSC-P, and end application time clocks. Multiple time synchronization deployment cases are shown in Appendix I of [ITU-T G.8271.2]. In those deployment cases, there is an "end application time clock" that is shown as providing the output clock at interface E. The requirements of these end application time clocks and the performance at interface E lie outside the scope of this Recommendation.

When the T-TSC-A or T-TSC-P is embedded inside the end application, as shown in Appendix I of [ITU-T G.8271.2], the combination of the T-TSC-A or T-TSC-P and the end application time clock is implementation specific, where the combined performance may not behave as the stand-alone T-TSC-A or T-TSC-P described in this Recommendation. The T-TSC-A and T-TSC-P output interface D may not be available external to the equipment for measurement.

In many end applications, there is a need to have coherent frequency and time synchronization or to generate coherent frequency and time outputs. In such cases, it is important to properly design the end application time clock to implement the coherency.

## **Appendix II**

### **Consideration of variable temperature testing**

(This appendix does not form an integral part of this Recommendation.)

For information related to variable temperature testing methodology, refer to Appendix I of [b-ITU-T G.8273].

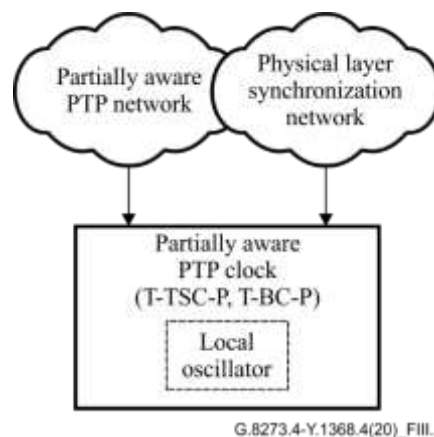
For information related to variable temperature holdover testing methodology, refer to Appendix II of [b-ITU-T G.8273].

## Appendix III

### Consideration of the use of a synchronous equipment clock to maintain time holdover for partial timing support networks

(This appendix does not form an integral part of this Recommendation.)

A partially aware equipment clock may have multiple sources of time synchronization available for selection, such as GNSS and PTP. In addition to the time synchronization sources, there may be frequency synchronization sources available to the equipment, as shown in Figure III.1. When the time synchronization source(s) are no longer available (such as signal fail), or degraded (such as poor clockClass), the equipment may enter holdover depending on the best master clock algorithm (BMCA) and operator configuration. During holdover, the equipment may benefit from using an external, traceable physical layer frequency reference, instead of its internal oscillator in order to achieve improved performance. This would be most applicable when the traceability information of the physical layer frequency reference indicates quality level PRC, primary reference source (PRS), PRTC or similar and the synchronous equipment clock stability available to the equipment is better than the local oscillator. A network traceable from a chain of enhanced synchronous equipment clocks (see [ITU-T G.8262.1]) is preferred over a network traceable reference from a chain of synchronous equipment clocks.



**Figure III.1 – Partially aware clock with diverse synchronization sources**

Note that in Figure III.1 the PTP time synchronization source and the physical layer frequency source are shown separately. This is simply for illustrative purposes; they may be received on the same Ethernet interface of the equipment.

NOTE – The following can degrade the stability of a chain of synchronous equipment clocks (see [ITU-T G.8262]) or enhanced synchronous equipment clocks (see [ITU-T G.8262.1]):

- temperature changes that affect the Ethernet cable delay and introduce wander on the synchronous equipment clock input;
- phase transients caused by physical layer synchronization network rearrangements.

## Appendix IV

### Use of a synchronous equipment clock to assist a PTP time lock

(This appendix does not form an integral part of this Recommendation.)

A partially aware equipment clock typically includes a stable local oscillator as a frequency reference to use to assist in synchronizing to incoming PTP packets. In addition to the PTP synchronization source, there may be frequency synchronization sources available to the equipment, as shown in Figure III.1.

When the situation arises that:

- a physical layer frequency reference is available at the input of the equipment clock; and
- the partially aware equipment clock supports the use of such an input; and
- the equipment is configured by the operator to use the physical layer reference,

then it may be advantageous to use the externally available physical layer frequency input to assist in the stabilization of the slave clock within the equipment, rather than relying solely on the local oscillator, while locking to the PTP network reference source. This would be most applicable when the traceability information of the physical layer frequency reference indicates quality level PRC, PRS, PRTC or similar. It is assumed that an enhanced synchronous equipment clock (see [ITU-T G.8262.1]) would be used in order for the clock to meet wander generation specifications.

## **Appendix V**

### **Synchronization interworking function P-F node limits**

(This appendix does not form an integral part of this Recommendation.)

[ITU-T G.8275] specifies the concept of a synchronization interworking function (IWF), where a node is used to translate between different segments of a network that are running different PTP profiles.

For a synchronization IWF from PTS to full timing support (FTS) (P-F) node, distributing PTP timing from a PTS profile to a FTS profile, the clock performance limits mainly consider the PTS type of network used on the slave port, regardless of the FTS used on the master port.

Therefore, all limits applied to the PTS clocks within the scope of this Recommendation may also apply to such a synchronization IWF P-F node, even if it is not strictly a PTS one.

## Appendix VI

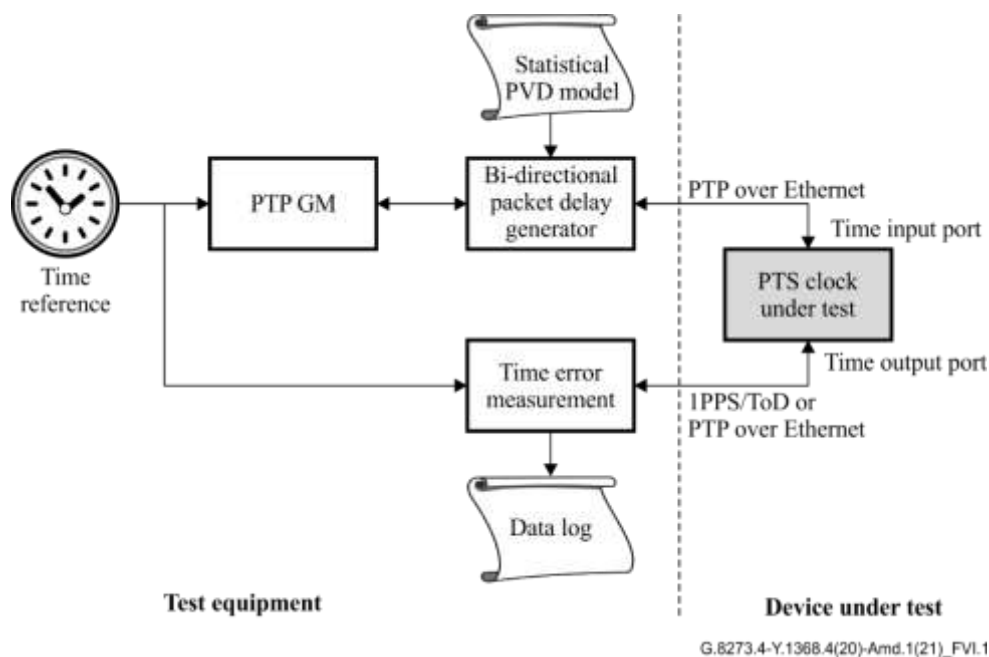
### PTP noise tolerance testing for PTS and APTS clocks

(This appendix does not form an integral part of this Recommendation.)

The PTP noise tolerance of a PTS or APTS clock is defined as the network limit at reference point C in [ITU-T G.8271.2] (see clauses 7.3 and 8.3). This appendix describes how to generate suitable test signals to check conformance with this requirement. This is based on a similar method used in [b-ITU-T G.8263] for testing of the PEC-S-F.

#### VI.1 Testing set-up for PTP noise tolerance testing

The general testing set-up for PTP noise tolerance testing of a PTS Clock (T-TSC-P or T-BC-P) is shown in Figure VI.1.



**Figure VI.1 – PTP noise tolerance testing of a PTS clock (T-TSC-P or T-BC-P)**

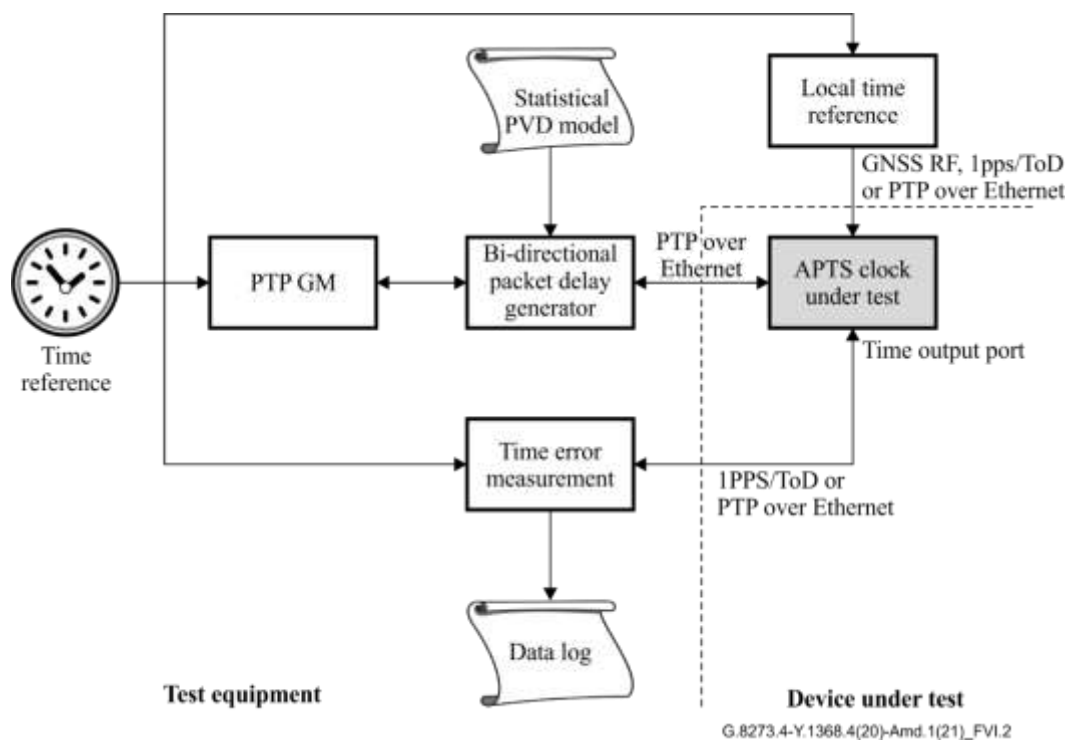
The PTP GM and the time error measurement block are both timed from the same time reference.

The delay sequences are generated by means of a statistical model, with the parameters chosen to generate a delay distribution with properties similar to the network limits defined in [ITU-T G.8271.2].

The output from the clock under test is either a 1PPS/ToD (for a T-TSC-A or T-TSC-P) or PTP over Ethernet (for a T-BC-A or T-BC-P).

When testing an APTS clock (T-TSC-A or T-BC-A), a local time reference is also required. This could be a GNSS simulator generating a GNSS RF signal, or a 1PPS/ToD or PTP time signal generator. The local time reference should be locked to the central time reference. This is shown in Figure VI.2.

The initial condition is for the APTS clock under test to use this local time reference as its primary input, and then to switch to the PTP input on failure of the local time reference. This is simulated by squelching the output signal of the local time reference.



**Figure VI.2 – PTP noise tolerance testing of an APTS clock (T-TSC-A or T-BC-A)**

The test procedure is to be carried out under constant temperature conditions (within  $\pm 1\text{K}$ ). Any stress testing under a noisy thermal environment is for further study.

## VI.2 Statistical PDV model

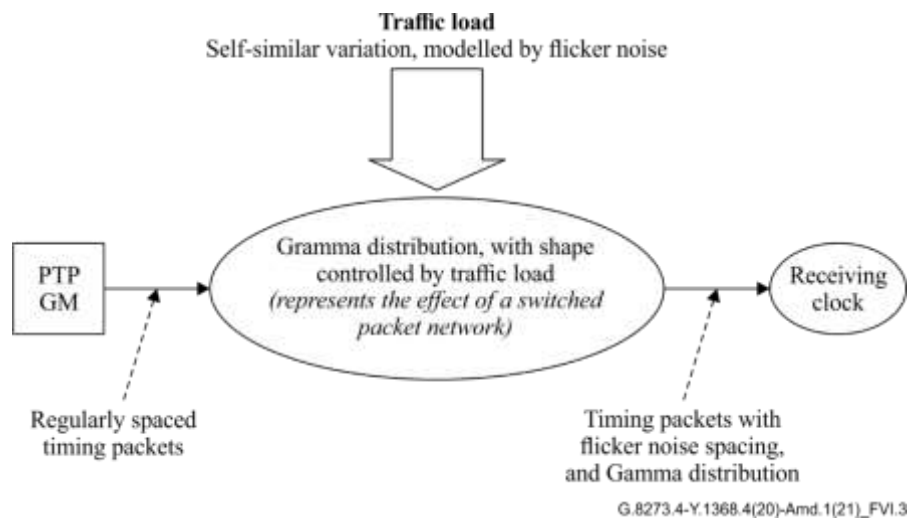
The packet delay sequences used in this method are based on a simple statistical model for a network experiencing bursty traffic. This is similar to the first method described in Appendix I of [b-ITU-T G.8263].

Studies of Internet traffic ([b-Leland], [b-Sahinoglu]) have shown that the traffic distribution is bursty at many different scales, and that this self-similar behaviour can be modelled by using flicker noise to represent the traffic load.

Second, it can be shown that the queuing action of a packet switch or router imposes a gamma ( $\Gamma$ ) distribution<sup>1</sup> on the probability density function of the delays through the switch or router. The  $\alpha$  (or shape) parameter of the  $\Gamma$  distribution varies with the traffic load.

The resulting statistical model is shown schematically in Figure VI.3.

<sup>1</sup> The probability density function of a gamma distribution is controlled by two parameters,  $\alpha$  (or "shape") and  $\beta$  (or "scale"). It is described by the equation  $f(x; \alpha, \beta) = \frac{\beta^\alpha x^{\alpha-1} e^{-\beta x}}{\Gamma(\alpha)}$ , for  $x, \alpha$  and  $\beta > 0$ , and where the gamma function,  $\Gamma(\alpha) = (\alpha - 1)!$



**Figure VI.3 – Statistical model of packet delay variation for timing packets**

It does not include the potential transients that can occur in packet networks, such as floor delay steps. In addition, it may not model accurately a network that has significant non-bursty traffic (e.g., constant bit rate (CBR) traffic).

This method is therefore considered suitable as a minimum test for characterizing the noise tolerance of a packet slave clock. Additional testing is recommended to ensure that the packet slave clock will tolerate more complex network situations with transients.

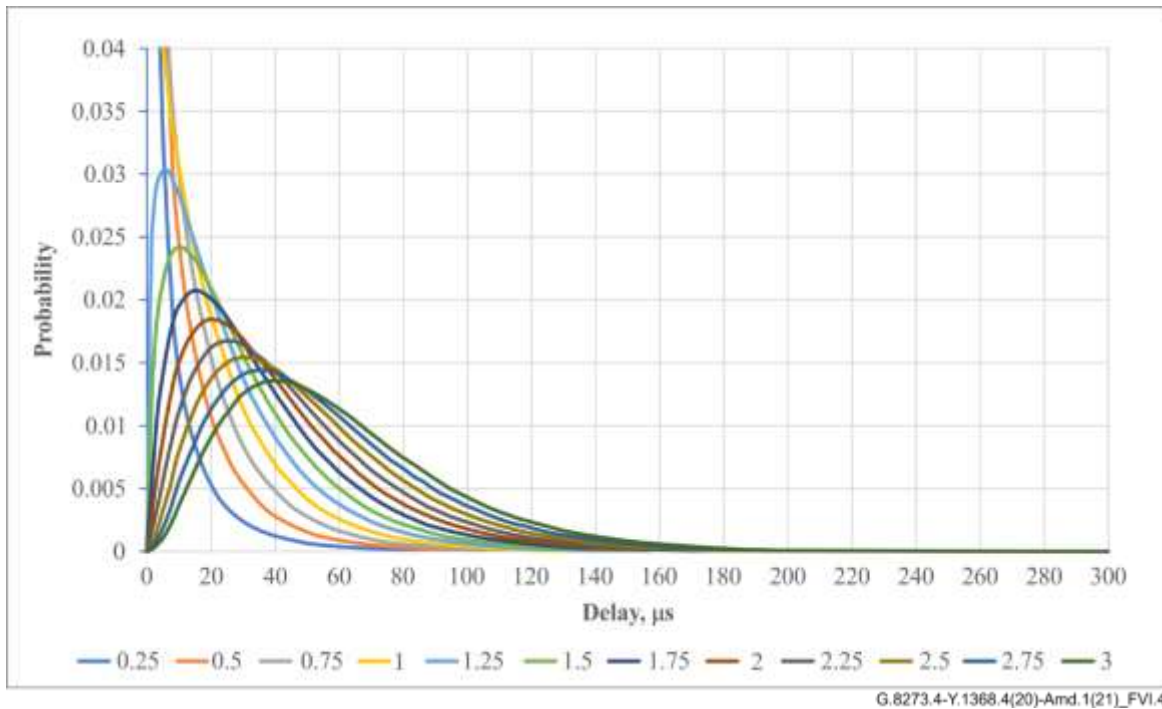
### VI.3 Parameters for the PDV model

In this model, the individual values of the distribution represent packet delays in the network, and are in units of time. The  $\alpha$  parameter describing the shape of the  $\Gamma$ - distribution is controlled by a flicker noise sequence representing the traffic load. This is adjusted once per second. The  $\beta$  (or scale) parameter is chosen to give a reasonable spread of packet delays, and has the units of inverse time. When using microseconds as the time unit, a  $\beta$  value of  $20 \mu\text{s}^{-1}$  yields a range of values of approximately  $300 \mu\text{s}$ , as shown in Figure VI.4.

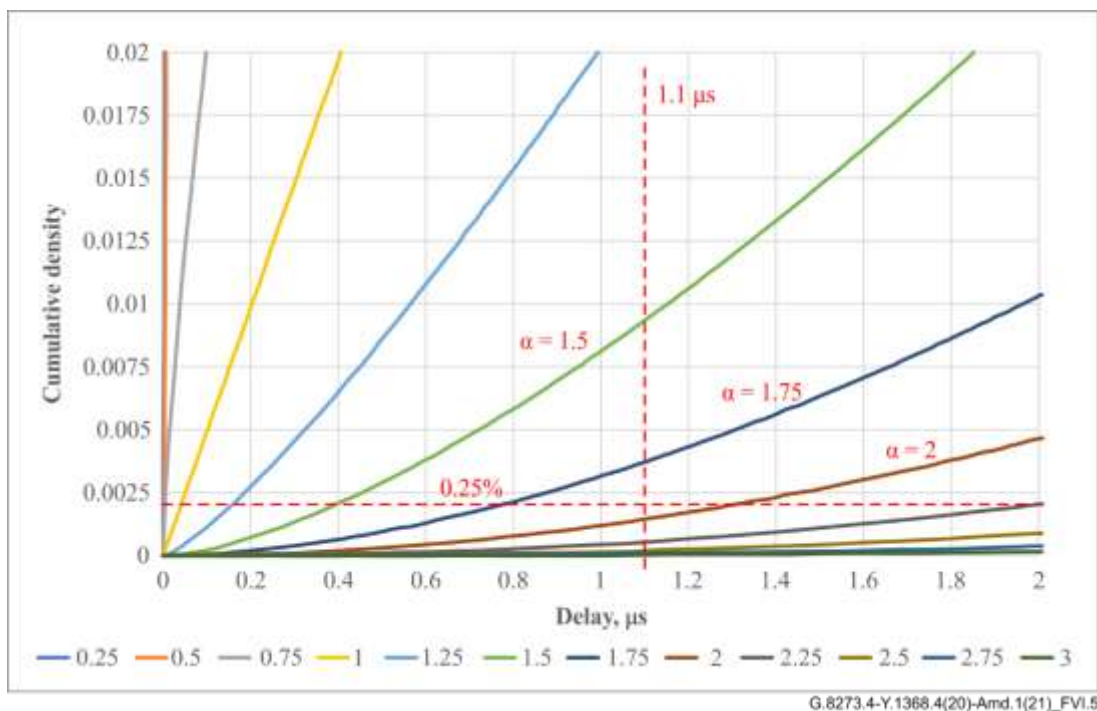
The range of variation of the  $\alpha$  parameter is chosen to give a probability of 0.25% that a delay value will be within  $1.1 \mu\text{s}$  of the minimum delay. Figure VI.5 shows the cumulative density function at 0.25% starts to exceed  $1.1 \mu\text{s}$  at an  $\alpha$  value of just under 2. However, the mean  $\alpha$  value would have to remain above 2 for the entire 200 s window for the mean delay of the selected percentile to be above  $1.1 \mu\text{s}$ . Second, this represents only one direction of packet flow. The probability of both the forward and reverse directions lining up to produce a `pktSelected2WayTE` of  $1.1 \mu\text{s}$  is quite small. Empirically, a range of 0 to 4 has been found to be suitable for the  $\alpha$  parameter.

The same model is adopted to generate the delays for both *sync* and *delay\_req* packets, but with independent random variables for each.





**Figure VI.4 – Probability density function of gamma distributions with  $\beta$  value of 20 for varying  $\alpha$  values**



**Figure VI.5 – Cumulative density function of gamma distributions with  $\beta$  value of 20 and varying  $\alpha$  parameters**

#### VI.4 Different requirements for APTS and PTS models

While there are several similar requirements to the patterns for APTS and PTS clocks, allowing the same basic statistical model to be used, there are also some differences.

Common requirements from [ITU-T G.8271.2]:

- Metric: pktSelected2WayTE

- Selection method: percentile average packet selection
- Selection window: 200 s
- Selection Percentage: 0.25%
- Window step size: 20 s

Specific requirements for APTS:

- Peak-to-peak  $\text{pktSelected2WayTE} \leq 1100 \text{ ns}$
- $|\text{cTE}|$  should be much higher than 1100 ns (this is not mentioned in [ITU-T G.8271.2], but part of the capability of the T-TSC-A should be to compensate for cTE created by network asymmetry, therefore any test pattern should have a large asymmetry to verify the compensation accuracy)

Specific requirements for PTS:

- $\text{Max}|\text{pktSelected2WayTE}| \leq 1100 \text{ ns}$
- $|\text{cTE}|$  should be much smaller than 1100 ns

#### VI.4.1 APTS pattern generation

The set of PDV patterns for use in testing APTS clocks may be generated in the following way:

1. Two independent sets of delays are generated for the *sync* and *delay\_req* packets using the method described above. The  $\alpha$  and  $\beta$  values for the gamma distribution are chosen to give the required profile of packet delays.
2. An arbitrary fixed delay (e.g., 100  $\mu\text{s}$ ) is added to both sets of packet delays, representing the minimum packet delay through the network.
3. An additional "asymmetry" delay is added to one set of patterns. This is chosen to be much larger than the required maximum time error, to verify the clock's ability to compensate for it. For example, 20  $\mu\text{s}$  is a suitable value, resulting in a cTE of 10  $\mu\text{s}$ .

#### VI.4.2 PTS pattern generation

The set of PDV patterns for use in testing PTS clocks may be generated in the following way:

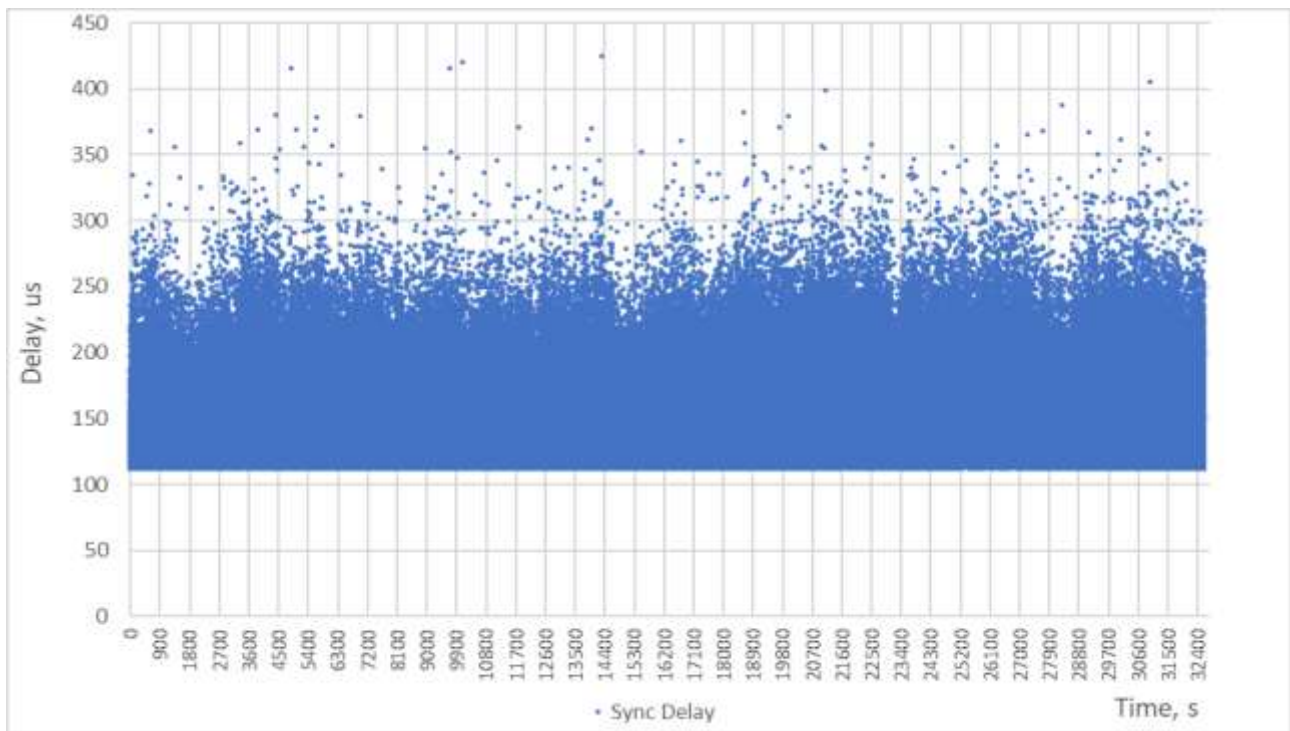
1. Two independent sets of delays are generated for the *sync* and *delay\_req* packets using the method described above.
2. An arbitrary fixed delay (e.g., 100  $\mu\text{s}$ ) is added to both sets of packet delays, representing the minimum packet delay through the network.
3. An additional "asymmetry" delay is added to one set of patterns. This is chosen to be smaller than the required maximum time error, to keep the overall time error within  $\pm 1.1 \mu\text{s}$ . For example, 1  $\mu\text{s}$  is a suitable value, resulting in a cTE of 500 ns.

As for the APTS patterns, the  $\alpha$  and  $\beta$  values, the fixed delay and asymmetry may be adjusted to generate a pattern with the required characteristics.

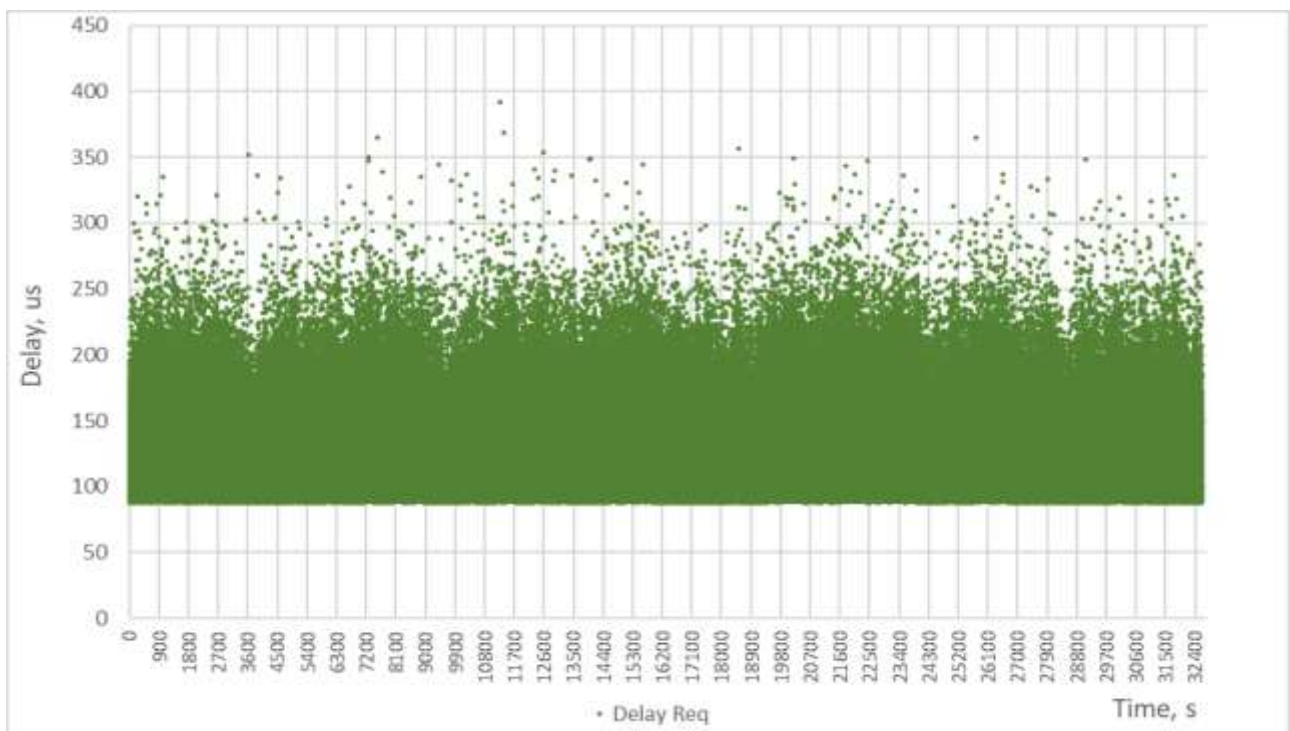
#### VI.5 Example delay patterns

The following figures show an example set of patterns generated for APTS using the method described. This particular example was generated at 32 packets/s, using a range of  $\alpha$  values between 0 and 3, a  $\beta$  value of 20  $\mu\text{s}^{-1}$ , together with a fixed delay of 100  $\mu\text{s}$  and an asymmetry of 24  $\mu\text{s}$ .

Figure VI.6 shows the *sync* delays generated using these parameters. A clear floor or minimum delay is seen at 112  $\mu\text{s}$ . The corresponding plot for *delay\_req* packets in Figure VI.7 also has a clear floor delay, but at 88  $\mu\text{s}$ , demonstrating the 24  $\mu\text{s}$  asymmetry between the two delay distributions. Both distributions have a range of delays of just over 300  $\mu\text{s}$ .



**Figure VI.6 – Sync packet delay variation**

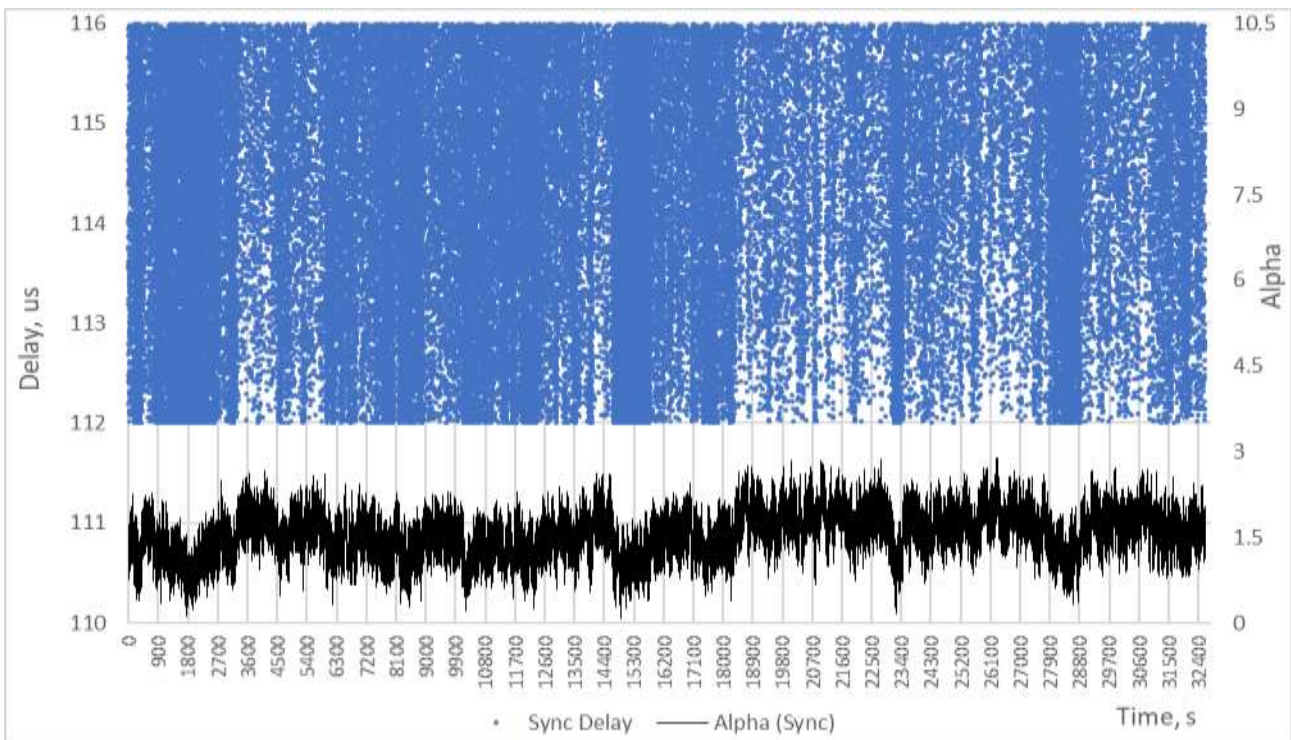


**Figure VI.7 – Delay\_req packet delay variation**

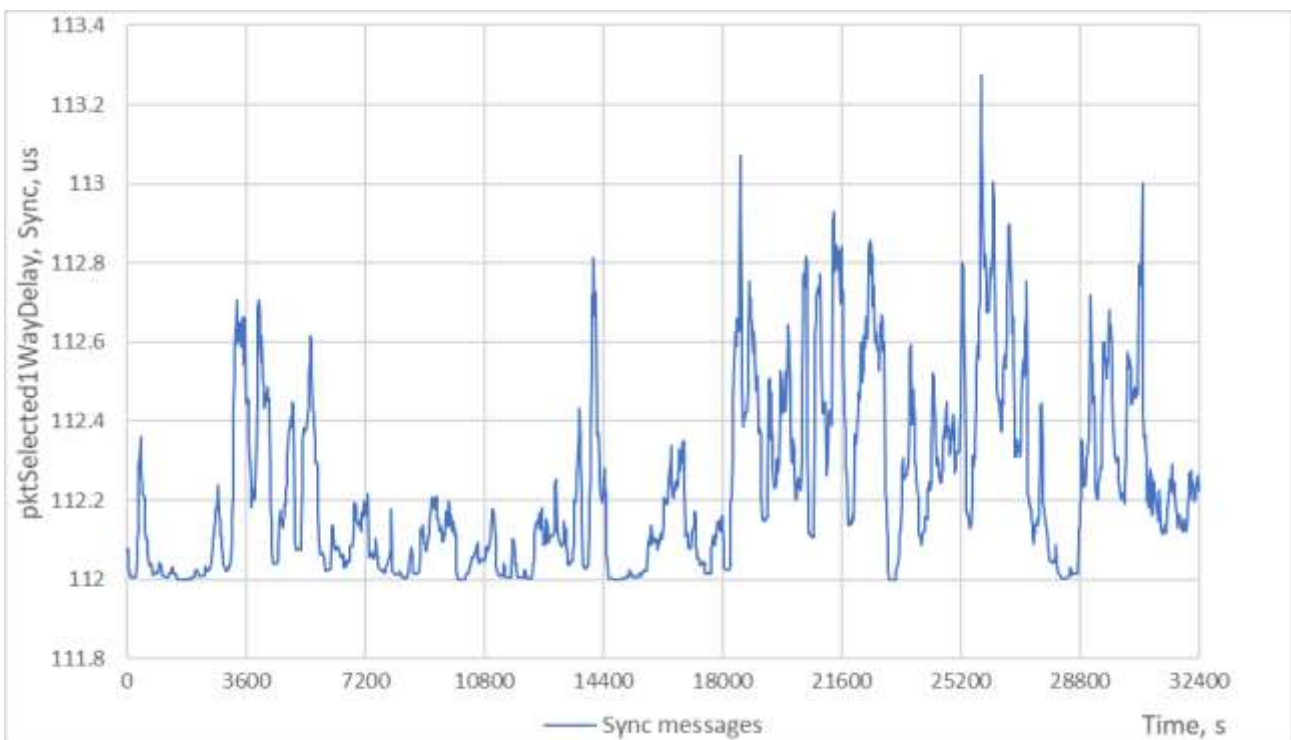
Figure VI.8 zooms in on the floor of the sync packet distribution, showing how the thickness of the floor varies with  $\alpha$ . This is what should be expected for real traffic with an increase in traffic load.

The floor thickness is calculated by averaging the delays of the fastest 0.25% of packets in each 200 s window. This is shown in Figure VI.9. It can be seen that the peak-to-peak value of this is about 1.3  $\mu$ s, which is higher than the network limit for APTS of 1.1  $\mu$ s. However, the network limit applies

to the two-way combination of forward and reverse delays, and it is unlikely that the "worst case" delays will line up exactly in each set of packet delays.



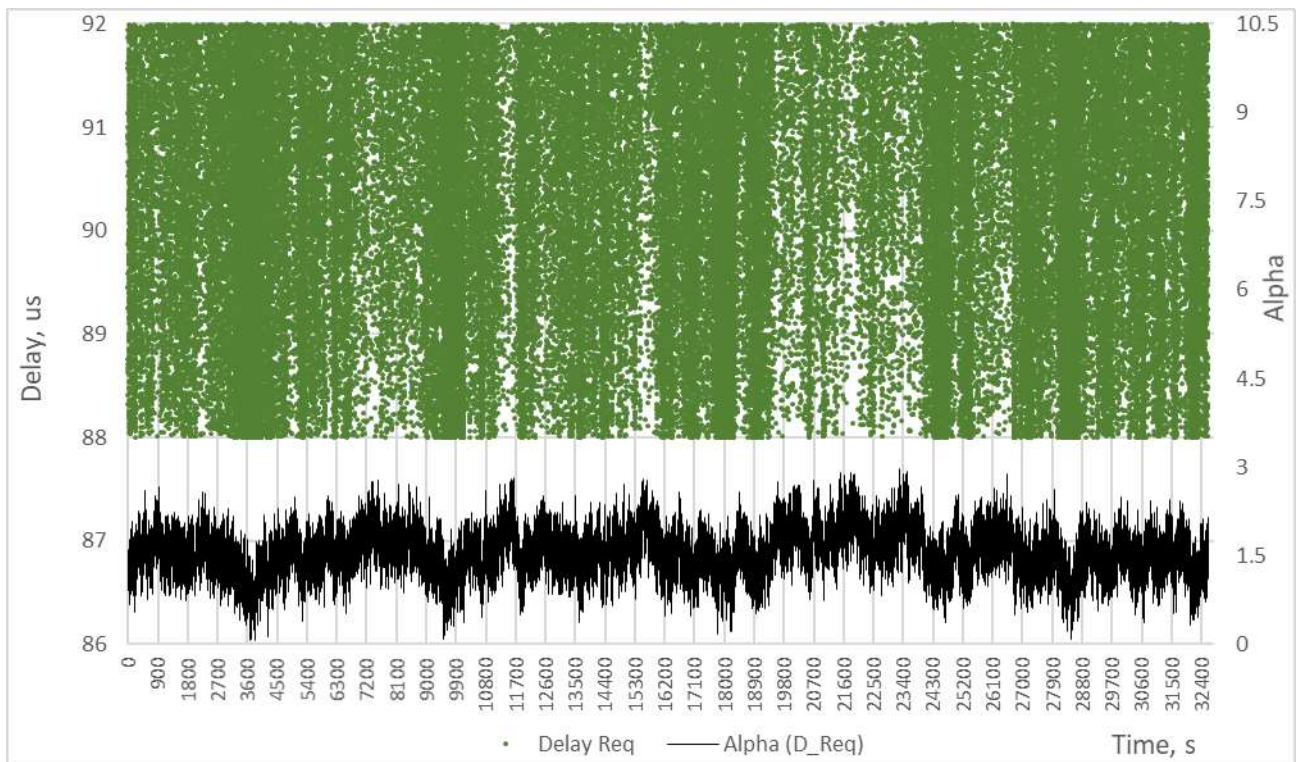
**Figure VI.8 – Zoom-in on the floor delay variation for sync packets and  $\alpha$  parameter**



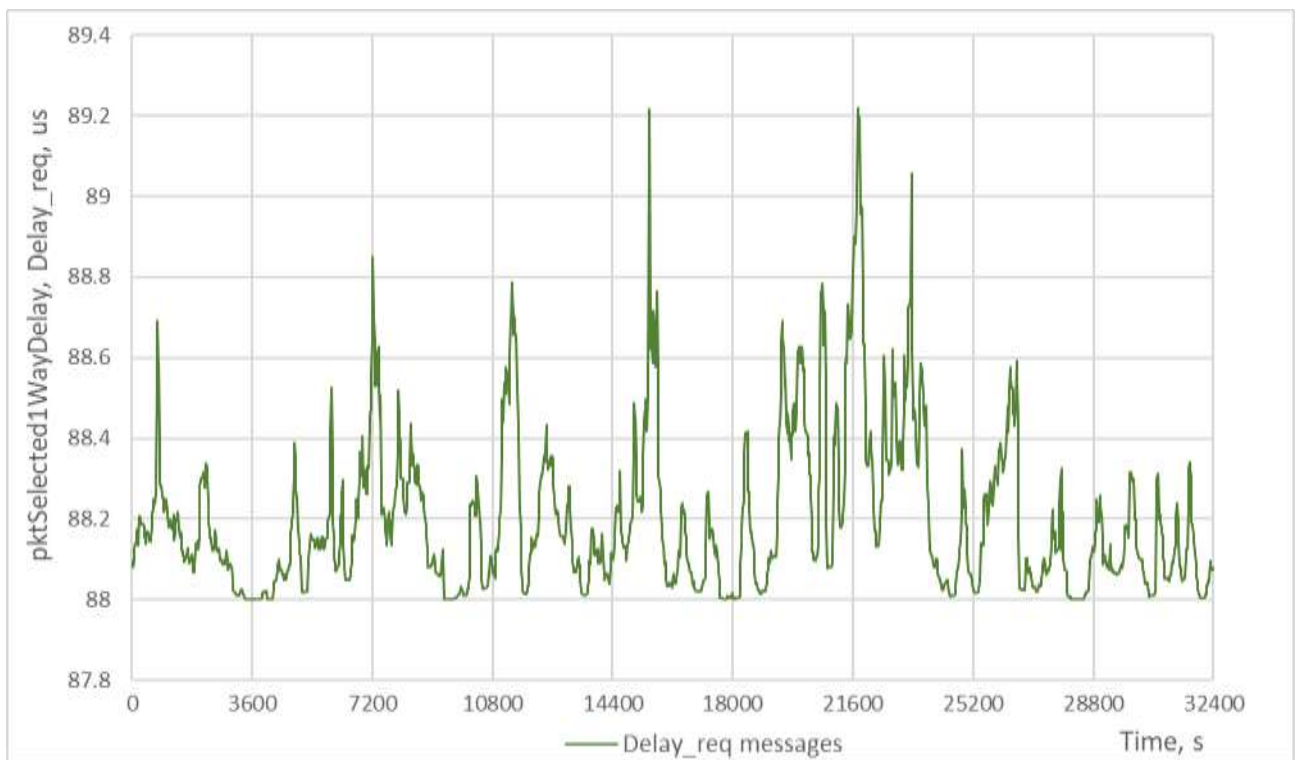
**Figure VI.9 – Average delay of selected sync packets**

Figures VI.10 and VI.11 show the same plots, but for the delay\_req packets. The  $\alpha$  sequence is independently generated from that for the sync packets, therefore there is no correlation between sync and delay\_req packet delays.



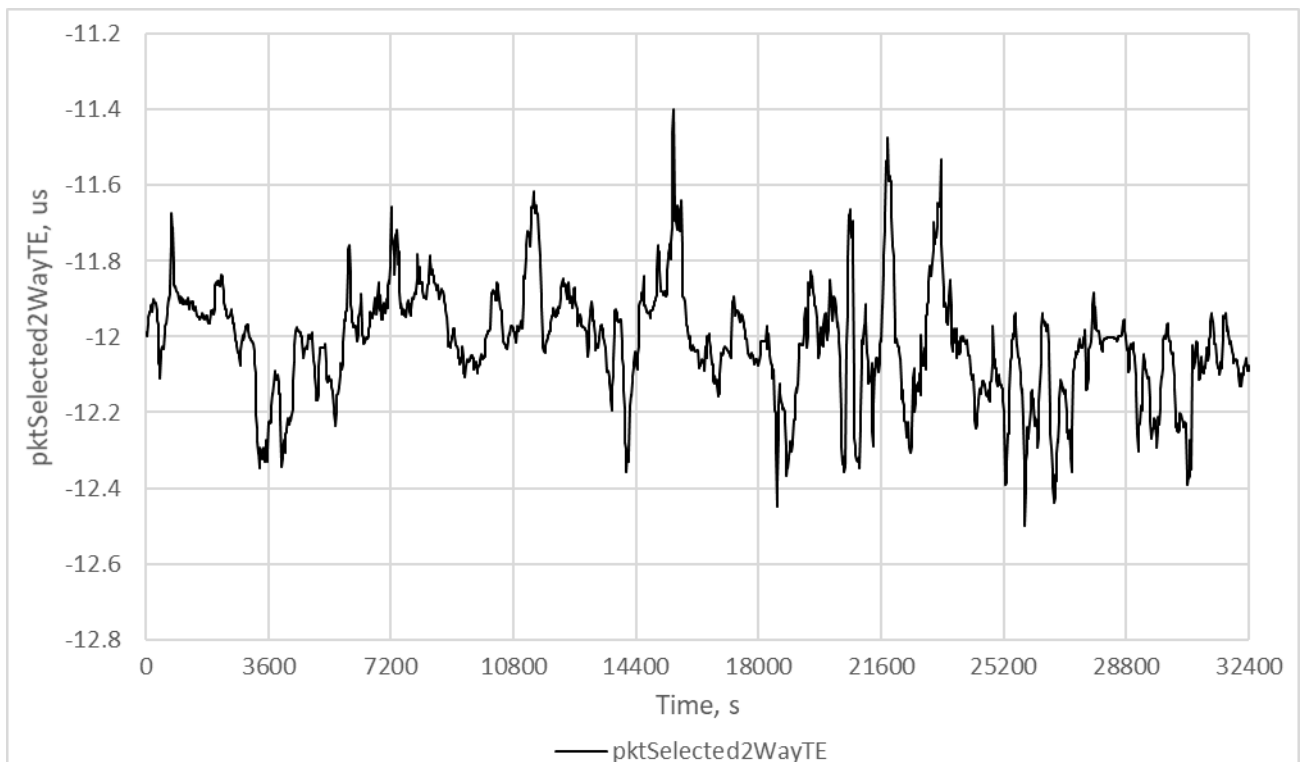


**Figure VI.10 – Zoom-in on the floor delay variation for delay\_req packets, with  $\alpha$  parameter**



**Figure VI.11 – Average delay of selected delay\_req packets**

Finally, Figure VI.12 shows the pktSelected2WayTE measured from two the sets of packet delays. The peak-to-peak value of the pktSelected2WayTE is 1.1  $\mu$ s, with a mean value (cTE) of  $-12 \mu$ s.



**Figure VI.12 – pktSelected2WayTE**

Similar patterns can be generated for PTS clocks, adjusting the asymmetry value and  $\alpha$  values to generate the desired peak-to-peak range while keeping the  $\max|\text{pktSelected2WayTE}|$  within the  $1.1 \mu\text{s}$  network limit.

## VI.6 Output requirements

The required behaviour of a clock in the presence of noise up to the network limit at its input is described in clauses 7.3 and 8.3.

In particular the clock should:

- not generate any alarms,
- not switch references,
- not go into holdover.

In addition, the  $\max|\text{TE}_L|$  of the clock output should remain within the limits defined at reference point D in [ITU-T G.8271.2]. This requirement is only applicable in case of T-TSC-A or T-TSC-P external to the end application. Therefore, in the case of a T-TSC-A or T-TSC-P integrated within an end application, this reference point may not always be accessible.

## Appendix VII

### Analysis of conversion of network limits to equipment specification for APTS

(This appendix does not form an integral part of this Recommendation.)

This appendix shows some of the background calculations that were used to develop the requirements in clause 7 of this Recommendation based on the [ITU-T G.8271.2] network limits for APTS deployment.

The following network limits we already known as input for the equipment noise:

- Limit C, PTP input from [ITU-T G.8271.2]
- Limit L, local time reference input from [ITU-T G.8271.2]
- Limit D, TE at output towards end application from [ITU-T G.8271.2]

The equipment noise requirement was developed based on the following: the total noise of the equipment, when combined with the noise existing at the equipment input (network limit at either reference point C or L of [ITU-T G.8271.2]), must be less than the network limit at reference point D of [ITU-T G.8271.2].

#### VII.1 Total noise budget between network limits

Table VII.1 covers the following two different APTS scenarios:

- APTS with time/phase holdover based on PTP after loss of local time reference
- AAPT with time/phase holdover based on oscillator after loss of local time reference

**Table VII.1 – APTS budget analysis (Class B equipment clock)**

| <u>Allocation</u>  | <u>Reference</u>                                      | <u>APTS with Holdover based on PTP</u> | <u>APTS with Holdover based on Oscillator</u> |
|--|---|--|---|
| <u>Input point C</u>   | <u>Clause 7.3 of [ITU-T G.8271.2]</u>                 | <u>1100</u>                            | <u>N/A (Note 1)</u>                           |
| <u>Local time reference point L</u>  | <u>Clause 7.1 of [ITU-T G.8271.2]</u>                 | <u>100</u>                             | <u>100</u>                                    |
| <u>Noise generation cTE</u>  | <u>Clause 7.2.2 [ITU-T G.8273.4]</u>                  | <u>20 (Note 4)</u>                     | <u>20 (Note 4)</u>                            |
| <u>Dynamic noise budget from combining LTR input noise with noise generation dTE</u> | <u>[ITU-T G.8271.2] and [ITU-T G.8273.4] (Note 3)</u> | <u>10 (Note 3)</u>                     | <u>10 (Note 3)</u>                            |
| <u>Noise transfer</u>  | <u>Clause 7.4 of [ITU-T G.8273.4]</u>                 | <u>5 (Note 5)</u>                      | <u>5 (Note 5)</u>                             |
| <u>Holdover</u>  | <u>None (Note 2)</u>                                  | <u>93 (Note 2)</u>                     | <u>1193 (Note 1)</u>                          |
| <u>Transients and switching</u>  | <u>Clause 7.5 of [ITU-T G.8273.4]</u>                 | <u>22</u>                              | <u>22</u>                                     |
| <u>Output point D</u>  | <u>[ITU-T G.8271.2] Clause 7.4</u>                    | <u>1350</u>                            | <u>1350</u>                                   |

**Table VII.1 – APTS budget analysis (Class B equipment clock)**

| <u>Allocation</u>   | <u>Reference</u> | <u>APTS with Holdover based on PTP</u> | <u>APTS with Holdover based on Oscillator</u> |
|---|------------------|--|---|
| <p><u>NOTE 1 – Holdover is based on local oscillator. In this case, the network PDV at network limit C is not applicable (as the PTP input is unused). Therefore, the 1100 ns noise budget of network limit C may be allocated to holdover of the equipment clock.</u></p> <p><u>NOTE 2 – Holdover is based on synchronization to a backup PTP source. See Table VII.2 for breakdown of the sub-components. As detailed in Appendix VII.2, this value is the remaining noise budget after all other components and limits were considered.</u></p> <p><u>NOTE 3 – This value represents the additive dTE noise when the equipment clock is locked to the Local Time Reference, which means that it is not the noise generation of the equipment. This is the increase in noise after computing the RSS of the input noise and noise generation; meaning it is the RSS(input noise and noise generation) minus input noise, or stated differently, the output noise minus the input noise. See Appendix VII.4 for more details.</u></p> <p><u>NOTE 4 – The analysis in this appendix shows the Class B equipment clock (with cTE of 20 ns). The same analysis may be performed with Class A equipment clock (with cTE of 50 ns). In the case of Class A, the holdover budget is reduced by 30 ns.</u></p> <p><u>NOTE 5 – Noise gain of 0.1 dB on LTR at point L with 100 ns pk-pk amplitude is about 1 ns (table rounds up to 5 ns).</u></p> |                  |  |   |

**VII.2 Holdover operation**

In Table VII.1 there is a value assigned to holdover (based on PTP or local oscillator). The holdover value does not represent the holdover performance requirements of the equipment. The holdover value represents the amount of error that may accumulate while the equipment is in holdover, while still meeting the network limit at reference point D of [ITU-T G.8271.2]. The holdover value was not selected, but instead was the remainder of the noise error allowed after the noise tolerance, noise transfer, noise generation and switching events were analysed. Therefore, there is no special significance to the holdover value that appears in Table VII.1.

In Table VII.1, when the holdover is based on PTP, the analysis was done for noise of each sub-components as shown in Table VII.2. In this case, the model is that the PTP clock (that maintains holdover by synchronizing to the PTP packets) will have noise generation (from local oscillator) and noise transfer (phase gain peaking from the input PTP noise) components.

**Table VII.2 – APTS budget analysis for PTP holdover use (Class B equipment clock)**

| <u>Component</u>   | <u>Holdover based on PTP (Note 1)</u> |
|--|---------------------------------------|
| <u>Noise generation cTE</u>  | <u>0</u>                              |
| <u>Dynamic noise budget from combining PTP input noise with noise generation dTE</u> | <u>78</u><br><u>(Note 2, 3)</u>       |
| <u>Noise transfer</u>  | <u>15</u><br><u>(Note 4)</u>          |
| <u>Total</u>   | <u>93</u>                             |

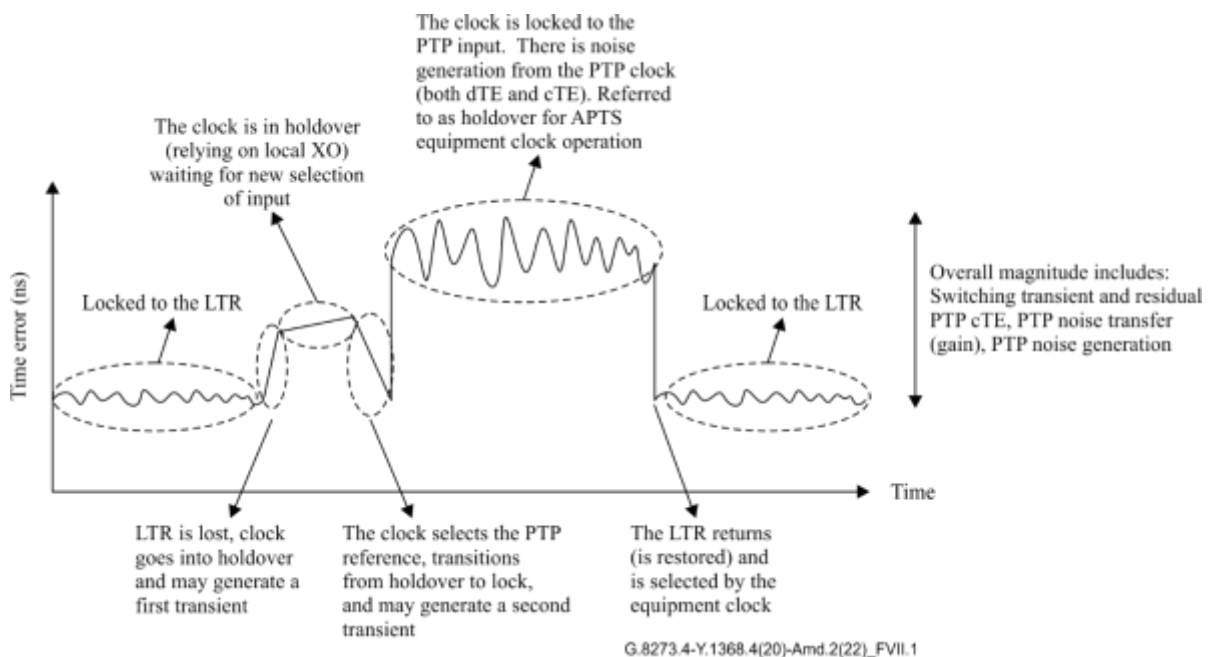


**Table VII.2 – APTS budget analysis for PTP holdover use (Class B equipment clock)**

| <u>Component</u>  | <u>Holdover based on PTP</u><br><u>(Note 1)</u> |
|---|---|
| <p><u>NOTE 1 – The values in this table are not reflected in the equipment clock specification as individual components, as the requirements when locked to PTP falls under holdover requirements (see clause 7.6.2).</u></p> <p><u>NOTE 2 – This value represents the additive dTE noise when the equipment clock is locked to the PTP input, which means that it is not the noise generation of the equipment. This is the increase in noise after computing the RSS of the input noise and noise generation; meaning it is the RSS(input noise and noise generation) minus input noise, or stated differently, the output noise minus the input noise.</u></p> <p><u>NOTE 3 – The noise generation dTE was the larger of the expected increase in noise after following RSS computation (combining the input PDV noise and the local noise generation), and the remainder of the noise error allowed to reach the total holdover budget of 93 ns. Therefore, the value is larger than expected based only on RSS computation analysis.</u></p> <p><u>NOTE 4 – Noise gain of 0.1 dB on PTP input at point C with 1100 ns pk-pk amplitude is about 13 ns (table rounds up to 15 ns).</u></p> |   |

### **VII.3 Transient operation and switching**

Figure VII.1 shows a representation of holdover and transient (switching) operation. It is intended to show the combined value for the entire operation of loss of reference to restoration of reference, and individual sub-stages that an implementation may follow.



**Figure VII.1 – Transients operation and switching budgeting**

### **VII.4 Dynamic noise accumulation for APTS**

In the dynamic noise analysis, the following assumptions were used:

- Dynamic noise (dTE) may be analysed using a root-sum-square (RSS) approach
- The dynamic noise is centreed around the constant time error
- The cTE portion of the local time reference noise at reference point L of [ITU-T G.8271.2] is a maximum of 74 ns (of the 100 ns limit).

A maximum value for cTE was used to take into consideration that constant noise adds linearly whereas dynamic noise adds with RSS. If a larger portion of the noise is considered to be cTE, then there is less benefit to the RSS dynamic noise accumulation, which reduces the budget of the equipment for dynamic noise wander generation, which in turn increases the complexity of the equipment design (for example a more stable oscillator may be needed). Note that the limit at the reference point L of [ITU-T G.8271.2] is not currently specified or sub-divided between dTE and cTE in [ITU-T G.8271.2].

In Table VII.3, the worst-case assumption of 100 ns is taken for the limit at the reference point L of [ITU-T G.8271.2], with worst-case maximum value of cTE of 74 ns, leaving 52 ns for dTE (when the noise is centred).

**Table VII.3 – APTS dynamic noise key values**

| <u>Limit L dTE</u> | <u>Dynamic time error low-pass filtered noise generation (dTE<sub>r</sub>)</u> |
|--------------------|--|
| <u>52 ns</u>       | <u>50 ns</u>   |

Note that the values in Table VII.4 are peak-peak values of dynamic noise.

From Table VII.3, the combined noise using RSS can be computed.

- $\text{SQRT}(52^2 + 50^2)/2 + 74 = 110 \text{ ns}$

This 110 ns dynamic noise for the worst-case assumption matches the maximum budget from Table VII.1 related to local time reference L of [ITU-T G.8271.2] and Noise generation dTE.

- $100 \text{ ns} + 10 \text{ ns} = 110 \text{ ns}$

## Appendix VIII

### Analysis of conversion of network limits to equipment specification for PTS

(This appendix does not form an integral part of this Recommendation.)

This appendix shows some of the background calculations that were used to develop the requirements in clause 8 of this Recommendation based on the [ITU-T G.8271.2] network limits for PTS deployment.

The following network limits we already known as input for the equipment noise:

- Network limits at reference point C of [ITU-T G.8271.2], PTP input
- Network limits at reference point D of [ITU-T G.8271.2], TE at output towards end application

The equipment noise requirements were developed based on the following: the total noise of the equipment, when combined with the noise existing at the equipment input (network limit at reference point C of [ITU-T G.8271.2]), must be less than the network limit at reference point D of [ITU-T G.8271.2].

#### VIII.1 Total noise between network limit C and network limit D

Table VIII.1 covers two different PTS scenarios:

- PTP with phase/time holdover based on oscillator after loss of local time reference
- PTS with phase/time holdover based on frequency layer frequency assistance after loss of local time reference

**Table VIII.1 – PTS budget analysis (Class B equipment clock)**

| <u>Allocation</u>  | <u>Reference</u>   | <u>PTS with Holdover based on Oscillator</u> | <u>PTS with Holdover based on SEC</u> |
|--|--|--|---------------------------------------|
| <u>Input point C</u>   | <u>Clause 7.3 of [ITU-T G.8271.2]</u>                          | <u>1100</u>                                  | <u>1100</u>                           |
| <u>Local time reference point L</u>  | <u>Clause 7.1 of [ITU-T G.8271.2]</u>                          | <u>N/A</u>                                   | <u>N/A</u>                            |
| <u>Noise generation cTE</u>  | <u>Clause 8.2.2 of [ITU-T G.8273.4]</u>                        | <u>20</u><br><u>(Note 3)</u>                 | <u>20</u><br><u>(Note 3)</u>          |
| <u>Dynamic noise budget from combining PTP input noise with noise generation dTE</u> | <u>[ITU-T G.8271.2 and [ITU-T G.8273.4]</u><br><u>(Note 1)</u> | <u>48</u><br><u>(Note 1)</u>                 | <u>48</u><br><u>(Note 1)</u>          |
| <u>Noise transfer</u>  | <u>Clause 8.4 of [ITU-T G.8273.4]</u>                          | <u>30</u><br><u>(Note 4)</u>                 | <u>30</u><br><u>(Note 4)</u>          |
| <u>Holdover</u>  | <u>None</u><br><u>(Note 2)</u>                                 | <u>130</u><br><u>(Note 2)</u>                | <u>130</u><br><u>(Note 2)</u>         |
| <u>Transients and switching</u>  | <u>Clause 8.5.1 of [ITU-T G.8273.4]</u>                        | <u>22</u>                                    | <u>22</u>                             |
| <u>Output point D</u>  |  | <u>1350</u>                                  | <u>1350</u>                           |

**Table VIII.1 – PTS budget analysis (Class B equipment clock)**

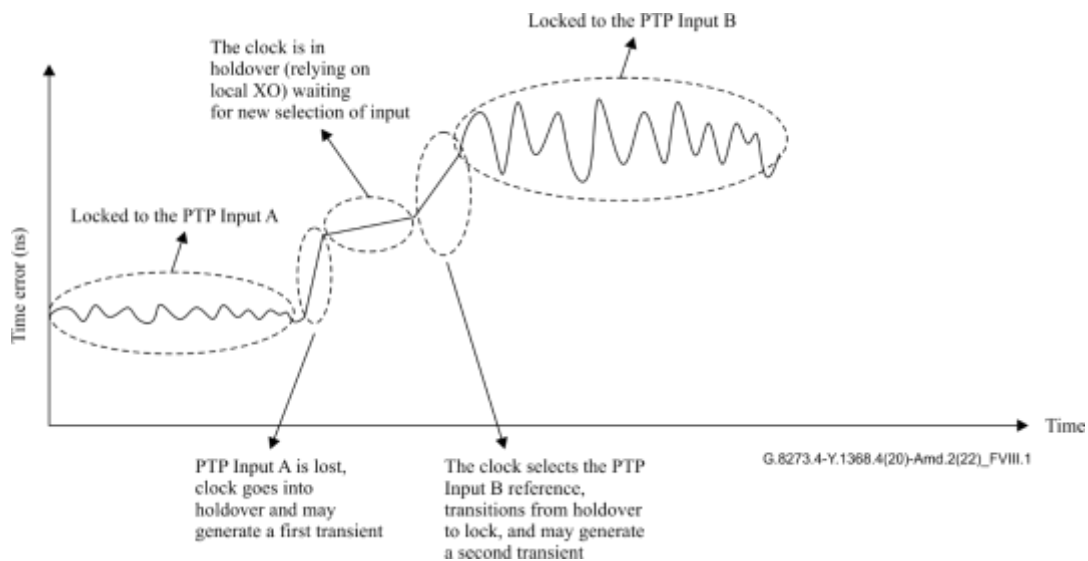
| <u>Allocation</u>   | <u>Reference</u> | <u>PTS with Holdover based on Oscillator</u> | <u>PTS with Holdover based on SEC</u> |
|---|------------------|--|---------------------------------------|
| <p>NOTE 1 – This value represents the additive dTE noise when the equipment clock is locked to PTP, which means that it is not the noise generation of the equipment. This is the increase in noise after computing the RSS of the input noise and noise generation; meaning it is the RSS (input noise and noise generation) minus input noise, or stated differently, the output noise minus the input noise. See Appendix VIII.4 for more details.</p> <p>NOTE 2 – As detailed in Appendix VIII.2, this value is the remaining noise budget after all other components and limits were considered.</p> <p>NOTE 3 – The analysis in this appendix shows the Class B equipment clock (with cTE of 20 ns). The same analysis may be performed with Class A equipment clock (with cTE of 50 ns). In the case of Class A, the holdover budget is reduced by 30 ns.</p> <p>NOTE 4 – Noise gain of 0.1 dB on PTP input at point C with 2200 ns pk-pk amplitude is about 26 ns (table rounds up to 30 ns).</p> |                  |  |                                       |

**VIII.2 Holdover operation**

In Table VIII.1 there is a value assigned to holdover (based on SyncE or local oscillator). The holdover value does not represent the holdover performance requirements of the equipment. The holdover value represents the amount of error that may accumulate while the equipment is in holdover, while still meeting the network limit at reference point D of [G.8271.2]. The holdover value was not selected, but instead was the remainder of the noise error allowed after the noise tolerance, noise transfer, noise generation and switching events were analysed. Therefore, there is no special significance to the holdover value that appears in Table VIII.1.

**VIII.3 Transient operation and switching**

Figure VIII.1 shows a representation of holdover and transient (switching) operation. It is intended to show the combined value for the entire operation of loss of reference to restoration of reference, and individual sub-stages that an implementation may follow.



**Figure VIII.1 – Transients operation and switching budgeting**

#### **VIII.4 Dynamic noise accumulation for PTS (constant temperature)**

In the dynamic noise analysis, the following assumptions were used:

- Dynamic noise (dTE) may be analysed using a root-sum-square (RSS) approach
- The dynamic noise is centred around the constant time error
- The cTE portion of the noise at reference point C of [ITU-T G.8271.2] is a maximum of 1020 ns (of the 1100 ns limit)

A maximum value of cTE was used to take into consideration that constant noise adds linearly whereas dynamic noise adds with RSS. If a larger portion of the noise is considered to be cTE, then there is less benefit to the RSS dynamic noise accumulation, which reduces the budget of the equipment dynamic noise wander generation, which in turn increases the complexity of the equipment design (for example a more stable oscillator may be needed). Note that the network limit at the reference point C of [ITU-T G.8271.2] is not currently specified or sub-divided between dTE and cTE in [ITU-T G.8271.2].

In Table VIII.2 the worst-case assumption of 1100 ns is taken for the limit at the reference point C of [ITU-T G.8271.2], with a worst-case maximum value of cTE of 1020 ns, leaving 160 ns for dTE (when the noise is centred).

**Table VIII.2 – PTS dynamic noise key values (Constant temperature)**

| <u>Limit C dTE</u> | <u>Dynamic time error low-pass filtered noise generation (dTE<sub>L</sub>)</u> |
|--------------------|--|
| <u>160 ns</u>      | <u>200 ns</u>  |

Note the values in the Table VIII.2 are peak-peak values of dynamic noise.

From Table VIII.2, the combined noise using RSS can be computed.

- $\text{SQRT}(160^2 + 200^2)/2 + 1020 = 1148 \text{ ns}$

This 1148 ns dynamic noise for the worst-case assumption matches the maximum budget from Table VIII.1 related to input network limit at the reference point C of [ITU-T G.8271.2] and noise generation dTE.

- $1100 \text{ ns} + 48 \text{ ns} = 1148 \text{ ns}$

## Bibliography

- [b-ITU-T G.8262.1] Recommendation ITU-T G.8262.1/Y.1362.1 (2019), *Timing characteristics of an enhanced synchronous equipment slave clock*.
- [b-ITU-T G.8263] Recommendation ITU-T G.8263/Y.1363 (2017), *Timing characteristics of packet-based equipment clocks*.
- [b-ITU-T G.8273] Recommendation ITU-T G.8273/Y.1368 (2018), *Framework of phase and time clocks*.
- ~~[b-ITU-T V.11] Recommendation ITU-T V.11/X.27 (1996), *Electrical characteristics for balanced double-current interchange circuits operating at data signalling rates up to 10 Mbit/s*.~~
- [b-Leland] Leland, W.E., Taqqu, M.S., Willinger, W., Wilson, D.V. (1994). *On the self-similar nature of Ethernet traffic* (extended version). IEEE /ACM Trans. Networking, 2, pp. 1–15.
- [b-Sahinoglu] Sahinoglu, Z., Tekinay, S. (1999). *On multimedia networks: self-similar traffic and network performance*. IEEE Commun. Mag., 37, pp. 48–52.

ITU-T Y-SERIES RECOMMENDATIONS  
**GLOBAL INFORMATION INFRASTRUCTURE, INTERNET PROTOCOL ASPECTS, NEXT-  
GENERATION NETWORKS, INTERNET OF THINGS AND SMART CITIES**

|  |                      |
|--|----------------------|
| <b>GLOBAL INFORMATION INFRASTRUCTURE</b>                           |                      |
| General  | Y.100–Y.199          |
| Services, applications and middleware                              | Y.200–Y.299          |
| Network aspects  | Y.300–Y.399          |
| Interfaces and protocols   | Y.400–Y.499          |
| Numbering, addressing and naming                                   | Y.500–Y.599          |
| Operation, administration and maintenance                          | Y.600–Y.699          |
| Security   | Y.700–Y.799          |
| Performances   | Y.800–Y.899          |
| <b>INTERNET PROTOCOL ASPECTS</b>                                   |                      |
| General  | Y.1000–Y.1099        |
| Services and applications  | Y.1100–Y.1199        |
| Architecture, access, network capabilities and resource management | Y.1200–Y.1299        |
| <b>Transport</b>   | <b>Y.1300–Y.1399</b> |
| Interworking   | Y.1400–Y.1499        |
| Quality of service and network performance                         | Y.1500–Y.1599        |
| Signalling   | Y.1600–Y.1699        |
| Operation, administration and maintenance                          | Y.1700–Y.1799        |
| Charging   | Y.1800–Y.1899        |
| IPTV over NGN  | Y.1900–Y.1999        |
| <b>NEXT GENERATION NETWORKS</b>                                    |                      |
| Frameworks and functional architecture models                      | Y.2000–Y.2099        |
| Quality of Service and performance                                 | Y.2100–Y.2199        |
| Service aspects: Service capabilities and service architecture     | Y.2200–Y.2249        |
| Service aspects: Interoperability of services and networks in NGN  | Y.2250–Y.2299        |
| Enhancements to NGN  | Y.2300–Y.2399        |
| Network management   | Y.2400–Y.2499        |
| Computing power networks   | Y.2500–Y.2599        |
| Packet-based Networks  | Y.2600–Y.2699        |
| Security   | Y.2700–Y.2799        |
| Generalized mobility   | Y.2800–Y.2899        |
| Carrier grade open environment                                     | Y.2900–Y.2999        |
| <b>FUTURE NETWORKS</b>   | <b>Y.3000–Y.3499</b> |
| <b>CLOUD COMPUTING</b>   | <b>Y.3500–Y.3599</b> |
| <b>BIG DATA</b>  | <b>Y.3600–Y.3799</b> |
| <b>QUANTUM KEY DISTRIBUTION NETWORKS</b>                           | <b>Y.3800–Y.3999</b> |
| <b>INTERNET OF THINGS AND SMART CITIES AND COMMUNITIES</b>         |                      |
| General  | Y.4000–Y.4049        |
| Definitions and terminologies                                      | Y.4050–Y.4099        |
| Requirements and use cases   | Y.4100–Y.4249        |
| Infrastructure, connectivity and networks                          | Y.4250–Y.4399        |
| Frameworks, architectures and protocols                            | Y.4400–Y.4549        |
| Services, applications, computation and data processing            | Y.4550–Y.4699        |
| Management, control and performance                                | Y.4700–Y.4799        |
| Identification and security  | Y.4800–Y.4899        |
| Evaluation and assessment  | Y.4900–Y.4999        |

*For further details, please refer to the list of ITU-T Recommendations.*

## SERIES OF ITU-T RECOMMENDATIONS

- Series A Organization of the work of ITU-T
- Series D Tariff and accounting principles and international telecommunication/ICT economic and policy issues
- Series E Overall network operation, telephone service, service operation and human factors
- Series F Non-telephone telecommunication services
- Series G Transmission systems and media, digital systems and networks**
- Series H Audiovisual and multimedia systems
- Series I Integrated services digital network
- Series J Cable networks and transmission of television, sound programme and other multimedia signals
- Series K Protection against interference
- Series L Environment and ICTs, climate change, e-waste, energy efficiency; construction, installation and protection of cables and other elements of outside plant
- Series M Telecommunication management, including TMN and network maintenance
- Series N Maintenance: international sound programme and television transmission circuits
- Series O Specifications of measuring equipment
- Series P Telephone transmission quality, telephone installations, local line networks
- Series Q Switching and signalling, and associated measurements and tests
- Series R Telegraph transmission
- Series S Telegraph services terminal equipment
- Series T Terminals for telematic services
- Series U Telegraph switching
- Series V Data communication over the telephone network
- Series X Data networks, open system communications and security
- Series Y Global information infrastructure, Internet protocol aspects, next-generation networks, Internet of Things and smart cities**
- Series Z Languages and general software aspects for telecommunication systems