

ITU-T

TELECOMMUNICATION
STANDARDIZATION SECTOR
OF ITU

G.8271/Y.1366

Amendment 2
(11/2018)

SERIES G: TRANSMISSION SYSTEMS AND MEDIA,
DIGITAL SYSTEMS AND NETWORKS

Packet over Transport aspects – Synchronization, quality
and availability targets

SERIES Y: GLOBAL INFORMATION
INFRASTRUCTURE, INTERNET PROTOCOL ASPECTS,
NEXT-GENERATION NETWORKS, INTERNET OF
THINGS AND SMART CITIES

Internet protocol aspects – Transport

Time and phase synchronization aspects of
telecommunication networks

Amendment 2

Recommendation ITU-T G.8271/Y.1366 (2017) –
Amendment 2

ITU-T G-SERIES RECOMMENDATIONS
TRANSMISSION SYSTEMS AND MEDIA, DIGITAL SYSTEMS AND NETWORKS

INTERNATIONAL TELEPHONE CONNECTIONS AND CIRCUITS	G.100–G.199
GENERAL CHARACTERISTICS COMMON TO ALL ANALOGUE CARRIER-TRANSMISSION SYSTEMS	G.200–G.299
INDIVIDUAL CHARACTERISTICS OF INTERNATIONAL CARRIER TELEPHONE SYSTEMS ON METALLIC LINES	G.300–G.399
GENERAL CHARACTERISTICS OF INTERNATIONAL CARRIER TELEPHONE SYSTEMS ON RADIO-RELAY OR SATELLITE LINKS AND INTERCONNECTION WITH METALLIC LINES	G.400–G.449
COORDINATION OF RADIOTELEPHONY AND LINE TELEPHONY	G.450–G.499
TRANSMISSION MEDIA AND OPTICAL SYSTEMS CHARACTERISTICS	G.600–G.699
DIGITAL TERMINAL EQUIPMENTS	G.700–G.799
DIGITAL NETWORKS	G.800–G.899
DIGITAL SECTIONS AND DIGITAL LINE SYSTEM	G.900–G.999
MULTIMEDIA QUALITY OF SERVICE AND PERFORMANCE – GENERIC AND USER-RELATED ASPECTS	G.1000–G.1999
TRANSMISSION MEDIA CHARACTERISTICS	G.6000–G.6999
DATA OVER TRANSPORT – GENERIC ASPECTS	G.7000–G.7999
PACKET OVER TRANSPORT ASPECTS	G.8000–G.8999
Ethernet over Transport aspects	G.8000–G.8099
MPLS over Transport aspects	G.8100–G.8199
Synchronization, quality and availability targets	G.8200–G.8299
Service Management	G.8600–G.8699
ACCESS NETWORKS	G.9000–G.9999

For further details, please refer to the list of ITU-T Recommendations.

Recommendation ITU-T G.8271/Y.1366

Time and phase synchronization aspects of telecommunication networks

Amendment 2

Summary

Recommendation ITU-T G.8271/Y.1366 defines time and phase synchronization aspects in packet networks. It specifies the suitable methods to distribute the reference timing signals that can be used to recover the phase synchronization and/or time synchronization according to the required quality.

The requirements for the synchronization characteristics that are specified in this Recommendation must be adhered to in order to ensure interoperability of equipment produced by different manufacturers and a satisfactory network performance.

This 2017 edition of the Recommendation integrates G.8271/Y.1366 (2016) Amd.1 (2017) into the base text. It does not add any new technical content.

Amendment 1 provides the following update:

- Addition to Appendix IV on network asymmetry.

Amendment 2 provides the following updates:

- Added abbreviations and acronyms
- Modified Tables 1 and 2
- Enhanced description of FCS field in Annex A.1.3.2
- Modified Table A.7
- Added text to clause I.7.2
- Modified Table II.1
- Replaced Table II.2
- Added references to the Bibliography

History

Edition	Recommendation	Approval	Study Group	Unique ID*
1.0	ITU-T G.8271/Y.1366	2012-02-13	15	11.1002/1000/11527
1.1	ITU-T G.8271/Y.1366 (2012) Amd. 1	2013-08-29	15	11.1002/1000/12033
1.2	ITU-T G.8271/Y.1366 (2012) Amd. 2	2015-01-13	15	11.1002/1000/12391
2.0	ITU-T G.8271/Y.1366	2016-07-07	15	11.1002/1000/12812
2.1	ITU-T G.8271/Y.1366 (2016) Amd. 1	2017-08-13	15	11.1002/1000/13322
3.0	ITU-T G.8271/Y.1366	2017-08-13	15	11.1002/1000/13383
3.1	ITU-T G.8271/Y.1366 (2017) Amd. 1	2018-03-16	15	11.1002/1000/13549
3.2	ITU-T G.8271/Y.1366 (2017) Amd. 2	2018-11-29	15	11.1002/1000/13767

Keywords

Methods and interfaces, time and phase synchronization requirements.

* To access the Recommendation, type the URL <http://handle.itu.int/> in the address field of your web browser, followed by the Recommendation's unique ID. For example, <http://handle.itu.int/11.1002/1000/11830-en>.

FOREWORD

The International Telecommunication Union (ITU) is the United Nations specialized agency in the field of telecommunications, information and communication technologies (ICTs). The ITU Telecommunication Standardization Sector (ITU-T) is a permanent organ of ITU. ITU-T is responsible for studying technical, operating and tariff questions and issuing Recommendations on them with a view to standardizing telecommunications on a worldwide basis.

The World Telecommunication Standardization Assembly (WTSA), which meets every four years, establishes the topics for study by the ITU-T study groups which, in turn, produce Recommendations on these topics.

The approval of ITU-T Recommendations is covered by the procedure laid down in WTSA Resolution 1.

In some areas of information technology which fall within ITU-T's purview, the necessary standards are prepared on a collaborative basis with ISO and IEC.

NOTE

In this Recommendation, the expression "Administration" is used for conciseness to indicate both a telecommunication administration and a recognized operating agency.

Compliance with this Recommendation is voluntary. However, the Recommendation may contain certain mandatory provisions (to ensure, e.g., interoperability or applicability) and compliance with the Recommendation is achieved when all of these mandatory provisions are met. The words "shall" or some other obligatory language such as "must" and the negative equivalents are used to express requirements. The use of such words does not suggest that compliance with the Recommendation is required of any party.

INTELLECTUAL PROPERTY RIGHTS

ITU draws attention to the possibility that the practice or implementation of this Recommendation may involve the use of a claimed Intellectual Property Right. ITU takes no position concerning the evidence, validity or applicability of claimed Intellectual Property Rights, whether asserted by ITU members or others outside of the Recommendation development process.

As of the date of approval of this Recommendation, ITU had received notice of intellectual property, protected by patents, which may be required to implement this Recommendation. However, implementers are cautioned that this may not represent the latest information and are therefore strongly urged to consult the TSB patent database at <http://www.itu.int/ITU-T/ipr/>.

© ITU 2019

All rights reserved. No part of this publication may be reproduced, by any means whatsoever, without the prior written permission of ITU.

Table of Contents

	Page
1 Scope.....	1
2 References.....	1
3 Definitions	2
4 Abbreviations and acronyms	2
5 Conventions	4
6 The need for time and phase synchronization	4
7 Time and phase synchronization methods.....	6
7.1 Distributed PRTC	7
7.2 Packet based methods with timing support of intermediate nodes.....	8
8 Network reference model	9
8.1 Access section of HRM with PTP/native access IWF.....	11
9 Time and phase synchronization interfaces.....	12
Annex A – One pulse-per-second (1PPS) time and phase synchronization interface specification.....	13
A.1 1PPS ITU-T V.11 interface	13
A.2 1PPS 50 Ω phase synchronization measurement interface	20
Appendix I – Time and phase noise sources in time distribution chains.....	21
I.1 Noise introduced by a primary reference time clock (PRTC).....	21
I.2 Noise introduced by a packet master clock function.....	21
I.3 Noise introduced by a packet slave clock function	21
I.4 Noise introduced by a telecom transparent clock	21
I.5 Noise introduced by a link.....	22
I.6 Derivation of delay asymmetry	22
I.7 Characteristics of the noise sources.....	24
I.8 Time error accumulation in a chain of clocks	26
Appendix II – Time and phase end application synchronization requirements.....	27
Appendix III – Asymmetry compensation for use of different wavelengths.....	32
Appendix IV – Link and network asymmetry compensation	33
Appendix V – Delay asymmetry resulting from interface rate change in PTP-unaware network elements.....	36
Bibliography.....	39

Recommendation ITU-T G.8271/Y.1366

Time and phase synchronization aspects of telecommunication networks

Amendment 2

Editorial note: This is a complete-text publication. Modifications introduced by this amendment are shown in revision marks relative to Recommendation ITU-T G.8271/Y.1366 (2017) plus its Amendment 1.

1 Scope

This Recommendation defines time and phase synchronization aspects in telecommunication networks. It specifies the suitable methods to distribute the reference timing signals that can be used to recover the phase synchronization and/or time synchronization according to the required quality. It also specifies the relevant time and phase synchronization interfaces and related performance.

The telecommunication networks that are in the scope of this Recommendation are currently limited to the following scenarios:

- Ethernet ([IEEE 802.3] and [IEEE 802.1Q]).
- MPLS ([IETF RFC 3031] and [ITU-T G.8110]).
- IP ([IETF RFC 791] and [RFC 2460]).
- OTN ([ITU-T G.709]).

The physical layers that are relevant to this specification are the Ethernet media types, as defined in [IEEE 802.3] and, for OTN, the Optical OCh layer with OTU frame as defined in [ITU-T G.709].

2 References

The following ITU-T Recommendations and other references contain provisions which, through reference in this text, constitute provisions of this Recommendation. At the time of publication, the editions indicated were valid. All Recommendations and other references are subject to revision; users of this Recommendation are therefore encouraged to investigate the possibility of applying the most recent edition of the Recommendations and other references listed below. A list of the currently valid ITU-T Recommendations is regularly published. The reference to a document within this Recommendation does not give it, as a stand-alone document, the status of a Recommendation.

- [ITU-T G.703] Recommendation ITU-T G.703 (2016), *Physical/electrical characteristics of hierarchical digital interfaces.*
- [ITU-T G.709] Recommendation ITU-T G.709/Y.1331 (2016), *Interfaces for the optical transport network.*
- [ITU-T G.810] Recommendation ITU-T G.810 (1996), *Definitions and terminology for synchronization networks.*
- [ITU-T G.8110] Recommendation ITU-T G.8110/Y.1370 (2005), *MPLS layer network architecture.*
- [ITU-T G.8260] Recommendation ITU-T G.8260 (2015), *Definitions and terminology for synchronization in packet networks.*
- [ITU-T G.8261] Recommendation ITU-T G.8261/Y.1361 (2013), *Timing and synchronization aspects in packet networks.*
- [ITU-T G.8272] Recommendation ITU-T G.8272/Y.1367 (2015), *Timing characteristics of primary reference time clocks.*

- [ITU-T V.11] Recommendation ITU-T V.11/X.27 (1996), *Electrical characteristics for balanced double-current interchange circuits operating at data signalling rates up to 10 Mbit/s*.
- [IEEE 802.1Q] IEEE 802.1Q-2014, *IEEE Standard for Local and metropolitan area networks – Bridges and Bridged Networks*
<<http://standards.ieee.org/findstds/standard/802.1Q-2014.html>>
- [IEEE 802.3] IEEE 802.3-2015, *IEEE Standard for Ethernet*.
<<http://standards.ieee.org/findstds/standard/802.3-2015.html>>
- [IEEE 1588] IEEE 1588-2008, *Standard for a Precision Clock Synchronization Protocol for Networked Measurement and Control Systems*.
<<http://standards.ieee.org/findstds/standard/1588-2008.html>>.
- [IETF RFC 791] IETF RFC 791 (1981), *Internet Protocol (IP)*.
<<http://www.ietf.org/rfc/rfc0791.txt?number=791>>.
- [IETF RFC 2460] IETF RFC 2460 (1998), *Internet Protocol, Version 6 (IPv6) Specification*.
<<http://www.ietf.org/rfc/rfc2460.txt?number=2460>>
- [IETF RFC 3031] IETF RFC 3031 (2001), *Multiprotocol Label Switching Architecture*.
<<http://www.ietf.org/rfc/rfc3031.txt?number=3031>>

3 Definitions

The terms and definitions used in this Recommendation are contained in [ITU-T G.810], [ITU-T G.8260] and [IEEE 1588].

4 Abbreviations and acronyms

This Recommendation uses the following abbreviations and acronyms:

1PPS	One Pulse Per Second
<u>BBU</u>	<u>Base Band Unit</u>
<u>CA</u>	<u>Carrier Aggregation</u>
CDMA	Code Division Multiple Access
<u>CoMP</u>	<u>Co-ordinated Multi-Point</u>
<u>CRC</u>	<u>Cyclic Redundancy Check</u>
<u>CU</u>	<u>Centralized Unit</u>
DCF	Dispersion Compensating Fibre
<u>DU</u>	<u>Distributed Unit</u>
<u>eNB</u>	<u>E-UTRAN Node B</u>
<u>EN-DC</u>	<u>E-UTRAN New radio – Dual Connectivity</u>
<u>E-UTRAN</u>	<u>Evolved Universal Terrestrial Radio Access Network</u>
FCS	Frame Check Sequence
FDD	Frequency Division Duplexing
<u>FR1</u>	<u>Frequency Range 1</u>
<u>FR2</u>	<u>Frequency Range 2</u>
GBAS	Ground Based Augmentation System

<u>GLONASS</u>	<u>GLObalnaya NAVigazionnaya Sputnikovaya Sistema (Global Navigation Satellite System)</u>
<u>gNB</u>	<u>5G (NR) Node B</u>
GNSS	Global Navigation Satellite System
GPS	Global Positioning System
HRPD	High Rate Packet Data
IP	Internet Protocol
IRNSS	Indian Regional Navigation Satellite System
LTE	Long Term Evolution
LTE-A	Long Term Evolution – Advanced
MAC	Medium Access Control
MBMS	Multimedia Broadcast Multicast Service
MBSFN	MBMS based on Single Frequency Network
<u>MIMO</u>	<u>Multiple Input Multiple Output</u>
<u>MRTD</u>	<u>Maximum Received Time Difference</u>
M2M	Machine to Machine
<u>NR</u>	<u>New Radio</u>
NTP	Network Time Protocol
<u>OTDOA</u>	<u>Observed Time Difference of Arrival</u>
OTN	Optical Transport Network
PDV	Packet Delay Variation
PHY	Physical Layer Protocol
PRTC	Primary Reference Time Clock
PSN	Packet Switched Network
PTP	Precision Time Protocol
QZSS	Quasi-Zenith Satellite System
RTT	Radio Transmission Technology
SBAS	Satellite Based Augmentation System
<u>TAE</u>	<u>Time Alignment Error</u>
TAI	International Atomic Time
TDD	Time Division Duplexing
TD-SCDMA	Time Domain Synchronized CDMA
T-BC	Telecom Boundary Clock
T-GM	Telecom Grandmaster
T-TC	Telecom Transparent Clock
T-TSC	Telecom Time Slave Clock
<u>TX</u>	<u>Transmit</u>

UDP	User Datagram Protocol
<u>UE</u>	<u>User Equipment</u>
UTC	Universal Time Co-ordinated
UTRA	Universal Terrestrial Radio Access
WCDMA	Wideband CDMA
WDM	Wavelength-Division-Multiplexing
WiMAX	Worldwide Interoperability for Microwave Access

5 Conventions

Within this Recommendation, the following conventions are used: The term precision time protocol (PTP) is the protocol defined by [IEEE 1588]. As an adjective, it indicates that the modified noun is specified in or interpreted in the context of [IEEE 1588].

6 The need for time and phase synchronization

Time synchronization has traditionally been required to support billing and alarm functions (maintenance or fault isolation). In this context, synchronization must in general be accurate to within hundreds of milliseconds.

Another time synchronization application is the monitoring of delays in Internet protocol (IP) networks. In this case, the requirement is accuracy to within some hundreds of microseconds (the actual requirement depends on the application).

Stringent time synchronization requirements (i.e., in the range of a few microseconds) apply to the generation of signals over the air interface of some mobile systems, such as CDMA2000 or LTE FDD unicast, when it is required to support synchronous CDMA2000 interworking.

Phase synchronization is often needed to support requirements for the air interface of some mobile systems, as in the case of time division duplexing (TDD) systems (for instance, LTE TDD), or when supporting multimedia broadcast/multicast service (MBMS). Note that ordinary WCDMA MBMS does not require accurate phase synchronization since it has been specified and designed to work properly in networks that satisfy the 50 ppb frequency accuracy requirement. This requirement, which is guaranteed by the WCDMA node synchronization function (see [b-3GPP TS 25.402]), limits phase drift to between 10 and 20 ns. But when MBMS is based on single-frequency network (MBSFN) mode, timing must be accurate to within a few microseconds. This is because identical waveforms are transmitted simultaneously from multiple cells. The signals from these cells are then combined as the multipath components of a single cell. Terminals must thus perceive the signals of an entire group of transmitting cells as though they came from a single cell. Therefore, all transmissions must be very tightly synchronized and deliver exactly the same content to each base station.

The main requirements applicable at the output of the application (e.g., on the radio interface in the case of a wireless application) are summarized in Appendix II.

Based on Table II.1, it is possible to classify the applications into classes of requirements, as shown in Table 1 below.

NOTE – In the case of mobile applications as described in Table II.1, the requirements are generally expressed in terms of phase error between base stations. In the case of a centralized master, the requirement could be expressed as \pm half of the accuracy requirement applicable to the specific technology. Table 1 presents the requirement in this format in order to allow the analysis of time error budgeting as distributed from a primary reference time clock (PRTC) towards the end application.

Table 1 – Time and phase requirement classes

Level of accuracy	Time error requirements (Note 1)	Typical applications (for information)
1	500 ms	Billing, alarms
2	100 μ s	IP Delay monitoring Asynchronous Dual Connectivity
3	5 μ s	LTE TDD (large cell) Synchronous Dual Connectivity (for up to 7 km propagation difference between eNBs/gNBs in FR1 eNodeBs) (Note 2)
4	1.5 μ s	UTRA-TDD, LTE-TDD (small cell), NR TDD, WiMAX-TDD (some configurations) Synchronous Dual Connectivity (for up to 9 km propagation difference between eNodeBs/gNBs in FR1) (Note 2) <u>NR Intra-band non-contiguous and Inter-band carrier aggregation, with or without MIMO or transmit (TX) diversity.</u>
5	1 μ s	WiMAX-TDD (some configurations)
6	x ns (Note 34)	Various applications, including location based services and some <u>coordination</u> LTE-A features (Note 23)

NOTE 1 – The requirement is expressed in terms of time error with respect to a common reference. Some of the original requirements were expressed in terms of relative time error.

NOTE 2 – FR1: 450 MHz – 6 GHz; FR2: 24.25 – 52.6 GHz

NOTE 23 – The performance requirements of ~~the LTE-A~~ some of these features are under study. For information purposes only, values between 500 ns and 1.5 μ s have been mentioned for some ~~LTE-A~~ features. Depending on the final specifications developed by 3GPP, ~~LTE-A~~ these applications may be handled in a different level of accuracy.

NOTE 34 – For the value x, refer to Table 2 and Table II.2 of Appendix II.

Based on Table II.2, it is possible to classify the class 6 level of accuracy into a further three sub-classes, as shown in Table 2.

Table 2 – Time and phase requirements for cluster based synchronisation

Level of accuracy	Maximum Relative Time error requirements (Note)	Typical applications (for information)
<u>3A</u>	<u>5 μs</u>	<u>LTE MBSFN</u>
<u>4A</u>	<u>3 μs</u>	<u>NR Intra-band non-contiguous and Inter-band carrier aggregation; with or without MIMO or TX diversity.</u>
6A	260 ns	<u>LTE</u> Intra-band non-contiguous carrier aggregation with or without MIMO or TX diversity, and inter-band carrier aggregation with or without MIMO or TX diversity

Table 2 – Time and phase requirements for cluster based synchronisation

Level of accuracy	Maximum Relative Time error requirements (Note)	Typical applications (for information)
		<u>NR (FR1) Intra-band contiguous carrier aggregation, with or without MIMO or TX diversity</u>
6B	130 ns	<u>LTE Intra-band contiguous carrier aggregation, with or without MIMO or TX diversity</u> <u>NR (FR2) Intra-band contiguous carrier aggregation, with or without MIMO or TX diversity</u>
6C	65 ns	<u>LTE and NR MIMO or TX diversity transmissions, at each carrier frequency</u>
<p>NOTE – The maximum relative time error requirements represent the <u>largest peak-to-peak time timing difference measured between the any two elements in of the cluster only</u>. See Appendix VII of [ITU-T G.8271.1] for illustration of how requirements are specified in a cluster. In 3GPP terminology this is equivalent to time alignment error (TAE), <u>which is defined as the largest timing difference between any two signals</u>.</p>		

This Recommendation deals mainly with the Class 4, 5, and 6A levels of accuracy requirement, as indicated in Table 2.

7 Time and phase synchronization methods

Packet-based methods (typically using network time protocol (NTP)) without timing support from the network are traditionally used to support applications with less strict time and phase synchronization requirements (class 1 according to Table 1).

This Recommendation focuses on applications corresponding to classes 4, 5, and 6 according to Table 1.

For these applications, the following options are considered in this Recommendation:

- A distributed primary reference time clock (PRTC) approach, implementing a global navigation satellite system (GNSS) receiver in the end application (a global positioning system (GPS) receiver, for example).
- Packet-based methods with timing support of intermediate nodes.

NOTE 1 – Additional solutions may be considered as a complement to the above solutions. As an example, timing may be carried over the radio interface of mobile systems. Applicability to the general HRMs is for further study.

NOTE 2 – The use of packet-based methods with limited timing support, or without timing support of intermediate nodes, is considered capable of addressing applications corresponding to class 4.

The following clauses provide details on the synchronization methods based on the distributed PRTC approach, and packet based methods with timing support of intermediate nodes.

7.1 Distributed PRTC

One method to achieve time and phase synchronization is to distribute a synchronization signal directly to each clock in the network. This method is referred to as a "Distributed Primary Reference Time Clock" and, in general, is feasible with radio distribution because a network-wide wire-based distribution would require a complete extra network, which may be impractical. However, in some cases a remote distribution of the PRTC signal via cables might also be possible. The radio distribution is normally achieved by means of GNSS, as for instance the GPS. Other radio systems may also be used.

The main objective of a synchronization network is to synchronize the end applications which require a timing reference. If there are several end applications in one site, a single PRTC reference can be deployed in the site and the time/phase reference can be further distributed within the site from a centralized function. The details of the centralized function are for further study.

Figure 1 below gives a generic representation of the distributed PRTC method. In the case of GNSS-based synchronization, the reference timing signal is distributed by the satellite signals and the GNSS receiver acts as the PRTC of the network. The receiver (Rx in the figure) processes the GNSS signal and extracts a reference signal for the end applications.

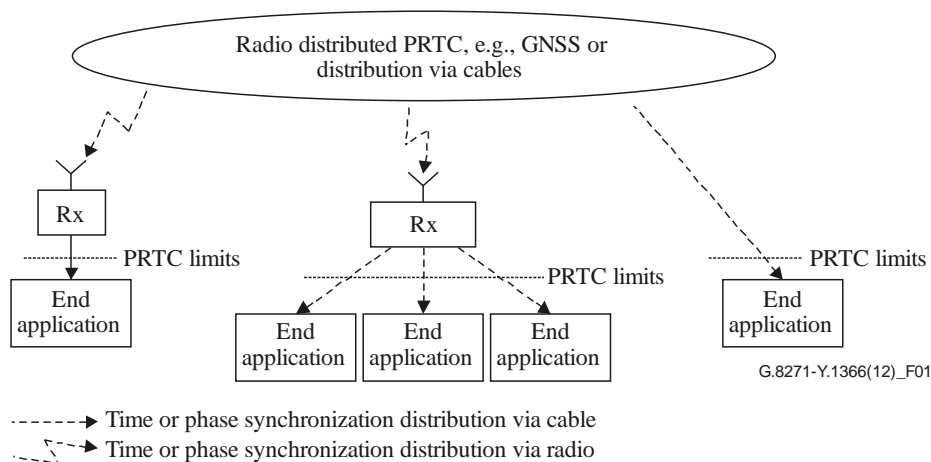

Figure 1 – Example of a distributed PRTC synchronization network

Main characteristics

One of the main advantages for a distributed PRTC approach is that the reference timing signals are available world-wide in the case of GNSS. This approach also allows for a flat distribution hierarchy with no risk of timing loops. In general, the overall network planning is also easier.

The main disadvantages of this approach are the dependency on the operator of the navigation system, the requirements for an antenna with a wide-angle view to the sky, the need to address lightning protection and, in general, the issues related to the antenna cabling.

Finally, GNSS-based systems present a risk of interference, e.g., by TV systems, saturation, and jamming.

It should, however, be mentioned that evolution of the technology reduces some of the main drawbacks (e.g., installation, reliability, etc.). Moreover, it should be possible to secure the GNSS receivers, for instance when an accurate frequency reference, such as a synchronous Ethernet signal, is available. The options for securing GNSS receivers are for further study.

In terms of performance, the accuracy that can be achieved by means of a PRTC system is defined in [ITU G.8272].

7.2 Packet based methods with timing support of intermediate nodes

Time synchronization can be distributed via timing protocols such as PTP (see [IEEE 1588]). This Recommendation currently focuses on the cases where the timing reference is carried with support from the network.

The timing support in the intermediate nodes (e.g., Ethernet switches) concerns specific hardware as well as software timing functions (see Figure 2).

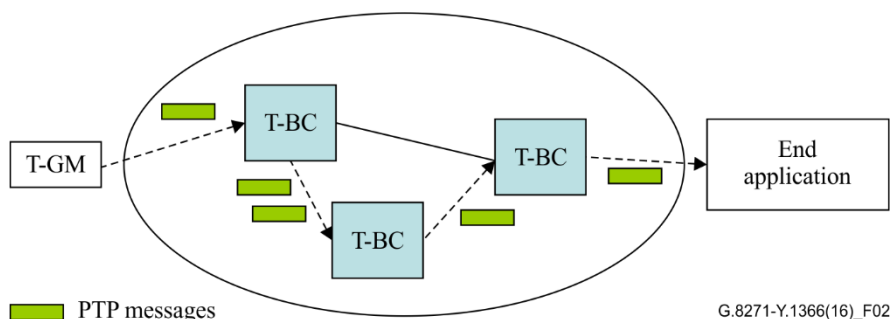

Figure 2 – Example of packet-based method with support from network nodes

In the case of PTP, these functions can correspond either to the T-BC or to the T-TC, with hardware timestamping at the related interfaces.

The T-BC terminates and regenerates timestamp messages.

The T-TC provides a means of measuring the delays that have been added by the network element and by the links connected to the network element. This Recommendation considers only T-BC support in this version. The use of T-TC in telecom applications is for further study.

The following figure shows an example of phase/time synchronization distributed via packet-based methods with timing support from the network. A packet master clock function in a T-GM having access to a reference timing signal compliant with the PRTC limits originates the packet timing distribution, and every transport node implements a T-BC.

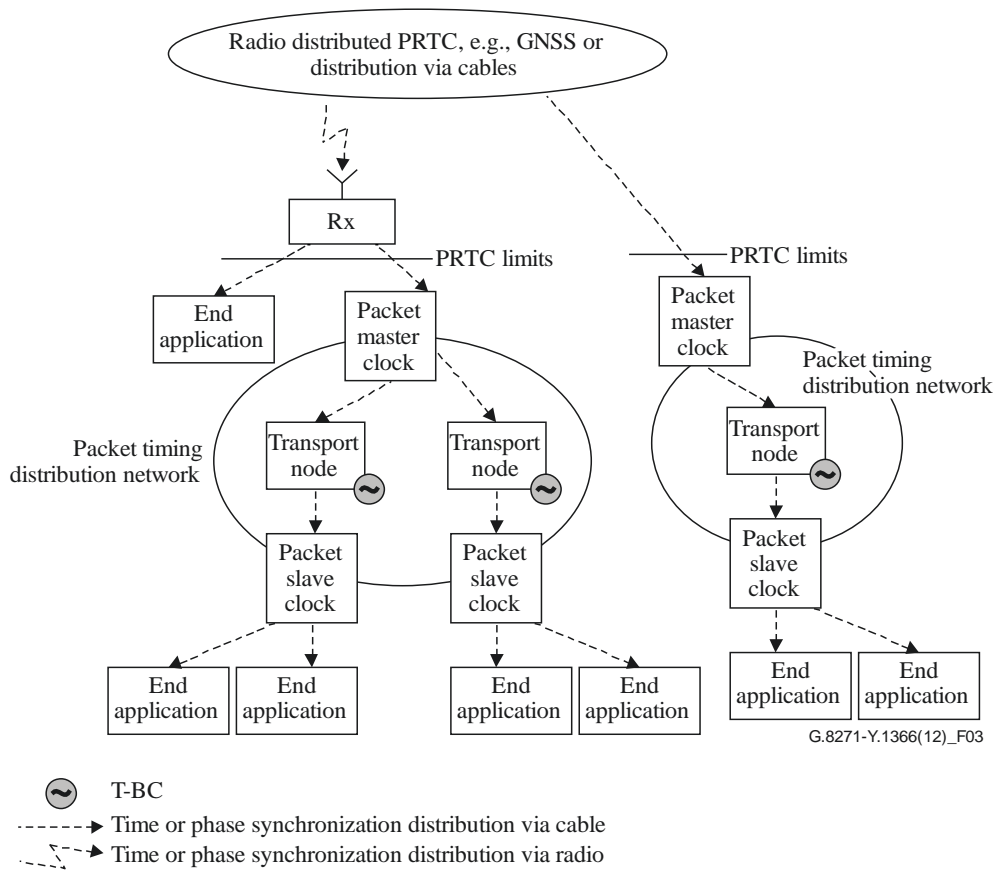

Figure 3 – Example of time synchronization distributed via packet based methods

Main characteristics

The main advantage of a time synchronization distribution solution via packet-based methods is the significantly reduced number of GNSS receivers. Note that if the PRTC is based on GNSS, then GNSS receivers would be required at the PRTC locations.

Among the disadvantages, it can be noted that the network planning is in this case more complex (e.g., with risk of timing loops). In addition, noise accumulation has also to be taken into account. Finally, another issue with this methodology is the time error due to asymmetries in the network that needs to be controlled (e.g., implying calibration of fibre lengths).

8 Network reference model

Figure 4 describes the network reference model used to define the time and phase synchronization performance objectives when the reference timing signal is carried over the transport network:

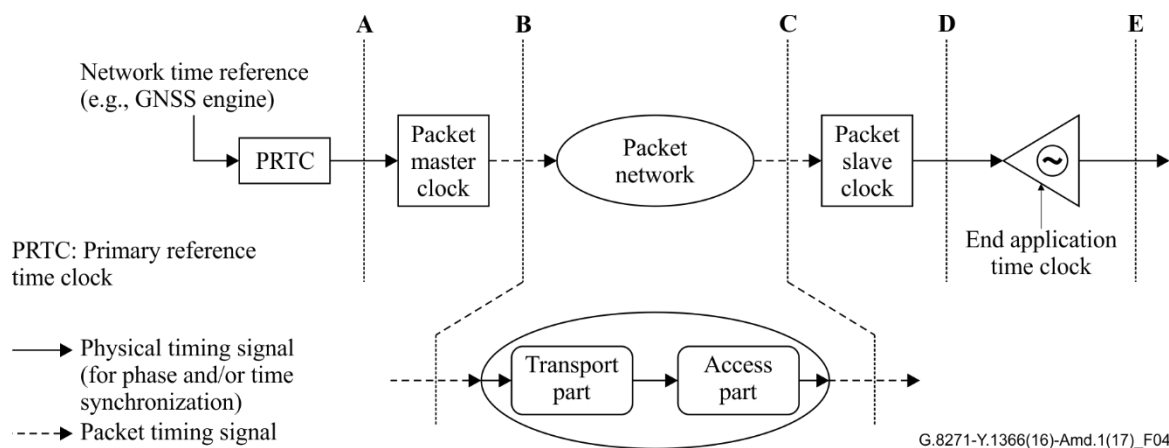

Figure 4 – Network reference model

The following reference points are defined. All the requirements related to these reference points are defined with respect to a common time reference, i.e., any recognized time reference such as GPS time.

- A: PRTC output
- B: Packet master clock output
- C: Packet slave clock input
- D: Packet slave clock output
- E: End application output

Some specific access technologies may need to be considered in the network reference model in some cases. For instance, the network between points B and C can be composed in some cases of a transport part and an access part. Each part would then have its own phase/time budget derived from the media specific mechanisms that have been developed to transport frequency and time synchronization.

NOTE 1 – In Figure 4 the packet master clock could correspond to a T-GM and the packet slave clock could correspond to a T-TSC (telecom time slave clock).

NOTE 2 – The performance studies documented in [ITU-T G.8271.1] are based on a full timing support in the network with hardware timestamping (e.g., T-BC in every node in the case of [IEEE 1588]) and with physical layer frequency synchronization support (e.g., synchronous Ethernet support). The case of partial timing support, where some or all of the nodes are not capable of providing timing support to the PTP layer, is covered in [ITU-T G.8271.2].

NOTE 3 – In some cases, specific access technologies may need to be considered in the network reference model. For instance in some cases, the packet network between points B and C can be composed of a transport part and an access part. Each part would then have its own phase/time budget. In some radio access networks (RAN) scenarios, for instance when the RAN is split based on different radio functions, from the point of view of timing, the starting point for the RAN may be present between points B and C shown in Figure 4. Alternatively, the entire network model may be present within the RAN. Details are for further study.

NOTE 4 – Additional detail for the network reference model of Figure 4 for the case of PTP over non-packet technologies (e.g., OTN, GPON, microwave) is for further study.

The overall budget relates to measurement point 'E' (i.e., the time error at E with respect to the common time reference).

'A', 'B', 'C' and 'D' define the other relevant measurement reference points and related network limits, that also indicate the budget of the noise that can be allocated to the relevant network segments (e.g., 'A to C', 'A to D', etc.).

The measurement points that are of interest for a specific application may depend on where the network administrative domain borders apply.

Also, as described above, the measurement in some cases needs to be performed on a two-way timing signal, which would require a specific test set-up and metrics to be used.

The measurement set-up for two-way timing signals as well as the noise that can be added by the measurement test equipment is an item for further study.

Another possibility is to perform the measurement using an external dedicated output phase/time reference, such as a 1PPS interface. Annex A in this Recommendation provides guidance about this type of interface.

8.1 Access section of HRM with PTP/native access IWF

The general network reference model in Figure 4 can be further expanded to illustrate different types of access technology that may be used at the edge of the network such as microwave, DSL or PON.

Generally access technologies can be categorized as either point-to-multipoint shared technologies or point-to-point technologies. An example of a point-to-multipoint shared media technology is a PON with a single multi-port head end and multiple end devices. An example of a point to point technology is a microwave system. Figure 5 expands the access section to show the media conversion that occurs between the Ethernet technology that forms the existing synchronization HRM of the transport section and the technologies in the access section of the HRM. The time error budget of this section may depend on the specific type of technology.

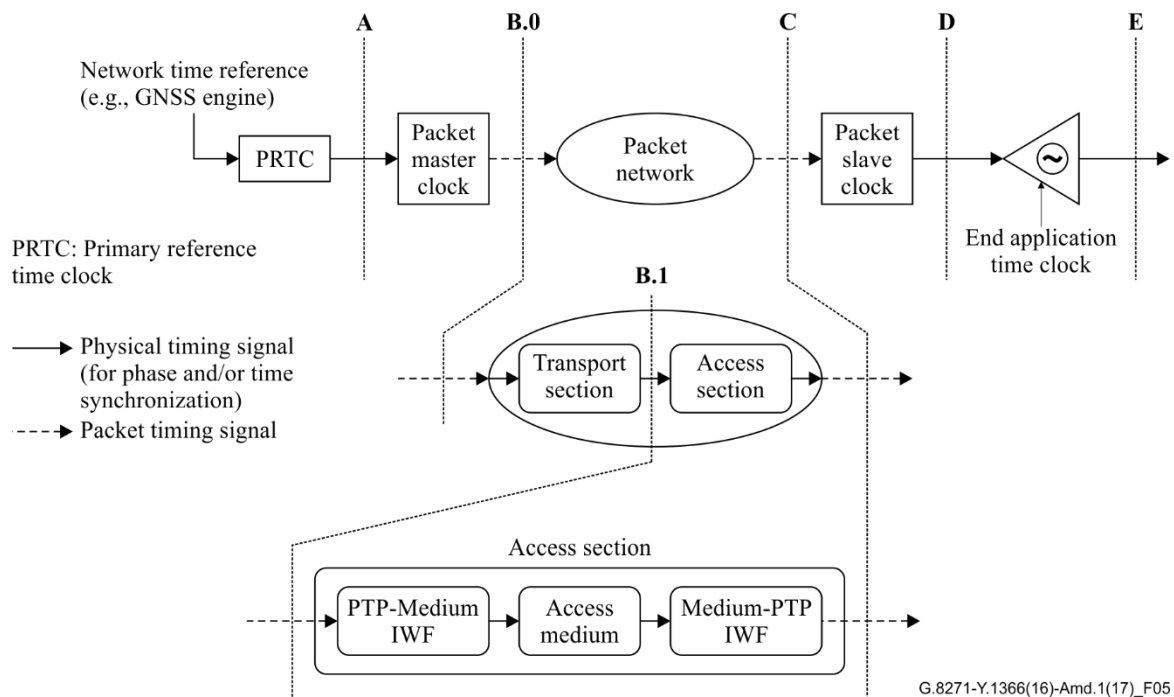

Figure 5 – Network reference model with access section

For example, between B.0 and B.1 the transport section consists of a network chain from [ITU-T G.8271.1] comprised of full timing aware ITU-T G.8273.2 T-BCs using PTP & SyncE. Between B.1 and C of the access section, there may also be T-BCs, and in this case they are connected to and from native access clocks. These native access clocks provide the direct connection to the medium. Essentially, the T-BC and native access clock provides an Interworking Function (IWF) that converts between Ethernet carrying PTP and the access medium.

The access section will have a time error that is a combination of the constant and dynamic components of the medium as well as contribution from the clocks in the access section.

9 Time and phase synchronization interfaces

Time and phase synchronization interfaces are needed for the following purposes:

1) Measurement interface:

In order to allow network operators to measure the quality of the time/phase synchronization distributed along a synchronization chain, each PRTC, T-GM, T-BC and T-TSC must have a dedicated external phase/time output interface implemented.

A one pulse-per-second (1PPS) interface is an adequate measurement interface, and should be implemented according to one of the interfaces specified in Annex A. Additional measurements interfaces are for further study.

2) Distribution interface:

Time and phase synchronization interfaces are sometimes needed to connect systems belonging to a time/phase synchronization distribution chain.

A typical application is the case of a T-TSC connected to an end-application, such as a base station, which is equipped with an existing input 1PPS interface. The details of the distribution interfaces are for further study.

Figure 6 shows examples of both types of time and phase synchronization interfaces: measurement interfaces (reference point 1) and distribution interfaces (reference point 2). Different requirements may apply to these points.

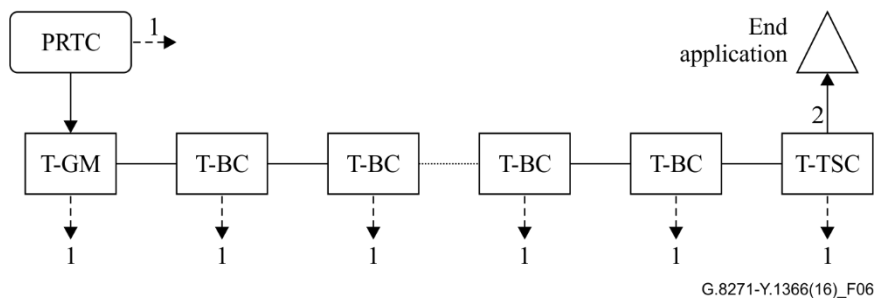

Figure 6 – Possible locations of external time and phase interfaces in a chain of Telecom-boundary clocks

Annex A

One pulse-per-second (1PPS) time and phase synchronization interface specification

(This annex forms an integral part of this Recommendation.)

A.1 1PPS ITU-T V.11 interface

The 1PPS time/phase interface uses a point-to-point ITU-T V.11 interface as specified in [ITU-T V.11] with an additional requirement on the rise/fall times of the 1PPS signal as defined in [ITU-T G.703]. This is needed to provide the accuracy required for the 1PPS signal.

This interface can be used for time synchronization distribution as well as for time measurement.

The interface is a balanced interface that can tolerate significant common mode noise.

The 1PPS interface consists of a balanced 100 ohm 1PPS differential signal that can be used to connect to the next clock or to measurement equipment.

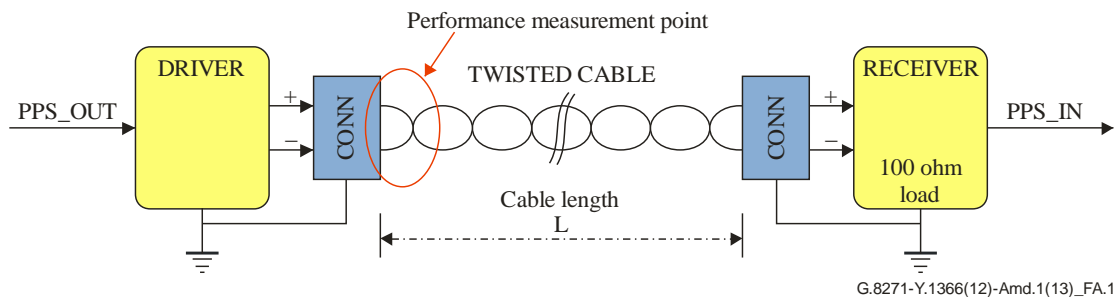

Figure A.1 – Balanced 1PPS V.11 interface

A.1.1 Interface signals

The signals of this interface are defined in this clause as follows:

- 1PPS_OUT+/1PPS_OUT-: This output signal pair indicates the significant event occurring on the leading edge of the signal and is generated by the time master.
- 1PPS_IN+/1PPS_IN-: This input signal pair indicates the significant event occurring on the leading edge of the signal and is used by the time slave.
- TX+/TX-: This output signal pair is used for a serial communication channel for transfer of time messages and status messages between the time master and the time slave.
- RX+/RX-: This input signal pair is used for a serial communication channel for transfer of messages between the time master and the time slave.

The connector is defined in [ITU-T G.703], which specifies the physical aspects of this interface.

The connection requires the use of a crossed cable that connects the signal pairs as specified in Table A.1.

Table A.1 – Cable connections

Connector A	Connector B
1PPS_OUT+/1PPS_OUT-	1PPS_IN+/1PPS_IN-
1PPS_IN+/1PPS_IN-	1PPS_OUT+/1PPS_OUT-
TX+/TX-	RX+/RX-
RX+/RX-	TX+/TX-
NOTE – Not all the signals in Table A.1 will necessarily be needed at the same time (e.g., one direction only might be sufficient in some cases). The backward direction of the messaging channel is for further study.	

A.1.2 Automatic cable delay compensation (optional)

The 1PPS ITU-T V.11 interface can optionally support automatic cable delay compensation. The enhanced 1PPS ITU-T V.11 interface adds support for automatic cable and ITU-T V.11 transceiver compensation using a feedback loop that allows the time master to measure the round-trip delay of the 1PPS signal and compensate for the path delay when generating the 1PPS signal.

The 1PPS signal is initially generated by the timing master at the 1-second boundary, T1. This signal is delayed through the cable before it arrives at the timing slave. The 1PPS signal is looped back at the slave and sent to the time master. The time master captures the time of reception of the 1PPS signal from the time slave, T2, and measures the round-trip delay as the time since the generation of the 1PPS signal.

Assuming that the path is symmetrical, the time master calculates the mean cable delay as: $(T2 - T1)/2$ and either compensates for the cable delays by advancing the 1PPS signal by the mean cable delay or alternatively informs the time slave about the mean cable delay through the ITU-T V.11 serial communication channel so that the slave can perform the compensation.

The protocol used on the serial communication channel is defined in clause A.1.3 below.

The time slave performs a loopback of the 1PPS signal at some point after the ITU-T V.11 transceiver.

A.1.3 Serial communication channel

A.1.3.1 Transmission characteristics

The following characteristics apply to the serial communication channel:

1. The default baud rate is 9600, without parity check.
2. When every byte data is sent, it shall include one start bit denoted by low voltage level, eight bits data and one end bit denoted by high voltage level. During non-data interval, it should be kept at high voltage level.
3. The message data should be sent no sooner than 1ms after the rising edge of 1PPS and must be finished within 500 ms.
4. The message represents the time at which the current 1PPS starts.
5. The messages should be sent once per second.

A.1.3.2 Message structure

The message structure is defined in Figure A.2:

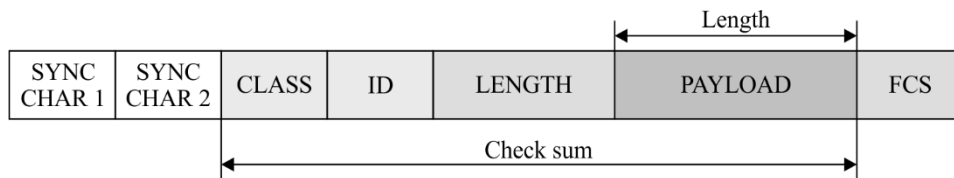

G.8271-Y.1366(16)_FA.2

Figure A.2 – TOD message structure

Each message is a multiple of 8 bits (octets) with frame check sequence (FCS). The messages are identified by the message CLASS and message ID. The transmission order of octets within multi-octet fields should comply with "Big Endian" rules, i.e., from the most significant octet first to the least significant octet last. The transmission of bits within one octet should be from bit 0 to bit 7. The transmission of the payload should start from offset 0 (see Tables A.3, A.5 and A.7).

Multiple messages may be sent on the serial communications channel. The messages can be sent with either no delay between messages or with a non-zero delay between messages. However the transmission of all messages must be completed within the time period indicated in clause A.1.3.1.

The interpretation of each message field is as follows:

1. Start of message

The start of a message has two octets: SYNC CHAR 1 and SYNC CHAR 2. These two octets are used for message alignment. A common value of 0x43 and 0x4D has been given to each octet representing the ASCII characters "C" and "M" respectively.

2. Header

The message header includes the sub-fields CLASS (1 octet) and message ID (1 octet). CLASS shows the basic type of the message. ID is encoded as the subtype of each class of message.

3. Length

The length field has two octets which indicates the length of the payload (not including the length of Sync Char 1, Sync Char 2, Header, Length and FCS field).

4. Payload

The payload field contains the contents of the message. This field may vary in length, depending on the message type.

5. FCS

~~The FCS has one octet. The checksum includes message Header, Length and Payload fields. The polynomial for generating FCS is $G(x) = x^8 + x^5 + x^4 + 1$. The initial value of the field should be set to 0xFF. The right shift operation should be used. There should be no bit inversion of the input and output value. The transmission of the octet should follow the same bit order as other data octets.~~

~~Further details are for further study.~~

The FCS has one octet, consisting of a CRC-8 calculated over the Header, Length and Payload fields of each message type (excluding Sync Chars 1 and 2). The CRC-8 uses the generator polynomial $G(x) = x^8 + x^5 + x^4 + 1$, and is calculated as follows:

- The input bits are taken in network transmission order, i.e., the most significant octet first, and within each octet the least significant bit first, to form an N -bit pattern representing the coefficients of a polynomial $M(x)$ of degree $N-1$ (where N is the number of bits in the message).
- $M(x)$ is pre-pended with the hexadecimal value 0xFC, then multiplied by x^8 . The result is then divided (modulo 2) by $G(x)$, producing a remainder $R(x)$.

- c) The coefficients of $R(x)$ are considered to be an 8-bit sequence, where x^7 is the most significant bit.
- d) This 8-bit sequence is the CRC-8 where the first bit of the CRC-8 to be transmitted is the coefficient of x^7 and the last bit transmitted is the coefficient of x^0 .

The de-mapper process performs the above calculation in the same manner as the mapper process, except that here, the $M(x)$ polynomial of step (a) includes the CRC-8 bits of the FCS field, resulting in $M(x)$ having degree $N+7$. In the absence of bit errors, the remainder shall be 0000 0000.

Alternatively, the de-mapper may exclude the FCS field in which case, in the absence of bit errors, the remainder shall be equal to the value of the FCS field.

The following table shows an example of a time-of-day time event message. Using the CRC-8 calculation method defined above, the calculated CRC-8 value in network transmission order is 1010 0100. Represented as an octet field, the FCS value is 0x25.

Field	Sync Char 1	Sync Char 2	Class	ID	Length	
Hexadecimal Value	43	4D	01	01	00	0E
Transmission order (first bit on left)	1100 0010	1011 0010	1000 0000	1000 0000	0000 0000	0111 0000

Field	Payload													
	Time						R	F	cUTC0		R			
Hexadecimal Value	00	00	59	09	DF	B8	00	06	16	0F	00	00	00	00
Transmission order (first bit on left)	0000 0000	0000 0000	1001 1010	1001 0000	1111 1011	0001 1101	0000 0000	0110 0000	0110 1000	1111 0000	0000 0000	0000 0000	0000 0000	0000 0000

Field	FCS
Hexadecimal Value	25
Transmission order (first bit on left)	1010 0100

NOTE – In step (b), the polynomial $M(x)$ is pre-pended with the value 0xFC. In the optimized implementation used by most actual CRC-generators, this is the mathematical equivalent of setting the initial value to 0xFF for the generator polynomial defined, but without pre-pending the value 0xFC.

A.1.3.3 Message Contents

There are three message types defined for the serial communication channel of the 1PPS V.11 interface:

- **Time event message** – timestamp and basic traceability information
This message is typically transmitted by all clock types using this interface.
- **Time announce message** – virtual PTP announce message
This message is typically transmitted by a PTP clock.
- **GNSS status message** – provides information about the status of a GNSS timing receiver
This message is typically transmitted by a GNSS-based clock.

Time event message

This message is used to output the time of day across the 1PPS V.11 interface.

Table A.2 – Time event message

Name	Time event message						
Description	Time event information						
Type	Reported every second						
Frame structure	Sync Char 1	Sync Char 2	Class	ID	Length	Payload	FCS
	0x43	0x4D	0x01	0x01	0x000E	See Table A.3	See clause A.1.3.2

Table A.3 – Time event message payload

Offset	Length (octets)	Name	Notes
0	6	Time	PTP seconds (unsigned 48-bit integer)
6	1	Reserved	Reserved
7	1	Flags	Bit 0: leap61 – Positive Leap Second pending Bit 1: leap59 – Negative Leap Second pending Bit 2: UTC offset valid Bit 3: Reserved Bit 4: timeTraceable – time traceable to a primary time standard Bit 5: frequencyTraceable – frequency traceable to a primary frequency standard Bits 6, 7: Reserved
8	2	currentUTCOffset	Current value of the offset between TAI and UTC (i.e., TAI – UTC)
10	4	Reserved	Reserved

Time announce message

This message is used to output the quality and traceability of the time delivered across the 1PPS V.11 interface of equipment containing a PTP clock.

Use of this message on an output interface of a PRTC is for further study, unless the equipment containing a PRTC also contains a T-GM.

The fields of this message are direct copies of the equivalent named fields of the PTP announce message, as described in [IEEE 1588]. A PTP clock receiving the ToD information may treat this information as having been received on a virtual PTP port according to the relevant PTP profile (e.g., [ITU-T G.8275.1]).

Table A.4 – Time announce message

Name	Time announce message						
Description	Provides information on the quality and traceability of the time source, equivalent to that contained in a PTP announce message.						
Type	Reported every second						
Frame structure	Sync Char 1	Sync Char 2	Class	ID	Length	Payload	FCS
	0x43	0x4D	0x01	0x02	0x0020	See Table A.5	See clause A.1.3.2

Table A.5 – Time announce message payload

Offset	Length (octets)	Name	Notes
0	1	versionPTP	PTP version number
1	1	domainNumber	PTP domain number
2	2	flagField	PTP flag field (see Note)
4	8	sourcePortIdentity.clockIdentity	clockIdentity of the sending clock
12	2	sourcePortIdentity.portNumber	Port number of the sending virtual PTP port
14	1	grandmasterPriority1	Priority1 value of the PTP Grandmaster
15	1	grandmasterPriority2	Priority2 value of the PTP Grandmaster
16	1	grandmasterClockQuality.clockClass	clockClass of the PTP Grandmaster
17	1	grandmasterClockQuality.clockAccuracy	clockAccuracy of the PTP Grandmaster
18	2	grandmasterClockQuality.offsetScaledLogVariance	offsetScaledLogVariance of the PTP Grandmaster
20	8	grandmasterClockIdentity	clockIdentity of the PTP Grandmaster
28	2	stepsRemoved	StepsRemoved from the PTP Grandmaster
30	1	timeSource	Type of the source of time provided by the PTP Grandmaster
31	1	Reserved	Reserved

NOTE – This is copied directly from the flagfield in the header portion of the PTP announce message, even though some of the flags are not relevant.

GNSS status message

This message is used to output the status or alarms of GNSS receivers across the 1PPS V.11 interface of a PRTC. It is not normally produced by a PTP clock, unless they are contained within the same equipment as a GNSS timing receiver.

Table A.6 – GNSS status message

Name	GNSS status message						
Description	Current status of GNSS timing receiver						
Type	Reported every second						
Frame structure	Sync Char 1	Sync Char 2	Class	ID	Length	Payload	FCS
	0x43	0x4D	0x01	0x03	0x0008	See Table A.7	See clause A.1.3.2

Table A.7 – GNSS status message payload

Offset	Length (octets)	Name	Notes
0	1	Types of time source	0x00: Beidou (Compass) 0x01: GPS 0x02: PTP 0x03: Galileo 0x04: Glonass 0x05: QZSS 0x06: IRNSS 0x07: GNSS (Combination of constellations) 0x08: Unknown (in case there is no information about which GNSS timescale is really used and no possible action to compel the module to work with a specific GNSS timescale) 0x09 ~ 0xFF: Reserved
1	1	Status of time source	GNSS Fix Type: 0x00: Position unknown 0x01: dead reckoning only (see Note 1) 0x02: 2D-fix 0x03: 3D-fix 0x04: GNSS + dead reckoning combined 0x05: Time only fix 0x06: A-GNSS 0x07: GNSS + SBAS 0x08: GNSS + GBAS 0x09 ~ 0xFF: reserved
32	2	Alarm Status Monitor	Time source alarm status: Bit 0: Reserved Bit 1: Antenna open Bit 2: Antenna shorted Bit 3: Not tracking satellites Bit 4: Reserved Bit 5: Survey-in progress Bit 6: no stored position Bit 7: Leap second pending

Table A.7 – GNSS status message payload

Offset	Length (octets)	Name	Notes
			Bit 8: In test mode Bit 9: GNSS solution (i.e., derived position and time) is uncertain (see Note 2) Bit 10: Reserved Bit 11: Almanac not complete Bit 12: PPS was generated Bit 13 ~ Bit 15: Reserved
4	4	Reserved	Reserved

NOTE 1 – Dead Reckoning Only – Position from GNSS is lost. Current position is estimated from the last-known position, plus knowledge of the velocity and acceleration of the antenna since the GNSS-based position was known.

NOTE 2 – GNSS solution is uncertain. When this bit is 1, it indicates that the accuracy of the position derived from GNSS is uncertain, possibly due to not being able to see enough satellites. This alarm may indicate that the antenna has been moved or fallen from place since the unit completed the last self-survey.

A.2 1PPS 50 Ω phase synchronization measurement interface

The 1PPS interface consists of an unbalanced 50-ohm 1PPS signal that can be used to connect to measurement equipment (see Figure A.3).

The physical characteristics of this interface are defined in [ITU-T G.703].

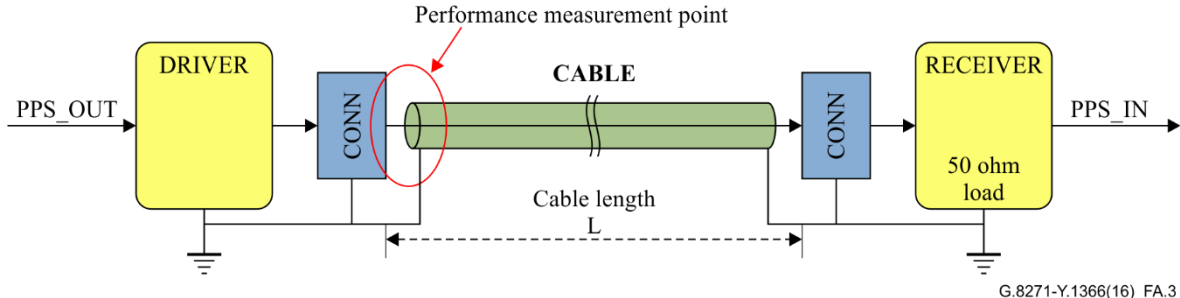

Figure A.3 – Unbalanced 1PPS 50 Ω measurement interface

The system must compensate for the internal delays in the system to ensure that the 1PPS signal timing is met at the edge of the box.

The measurement equipment is expected to compensate for the delays associated with the interconnection of the 1PPS interface.

Appendix I

Time and phase noise sources in time distribution chains

(This appendix does not form an integral part of this Recommendation.)

Quantifying the sources of errors in the time distribution chain is essential in the process to defining noise budget in the network reference model.

The sources of errors listed in this appendix are based on a network with full timing support provided by telecom boundary clocks (T-BCs).

In the case of no timing support in some of the nodes, (or in all the nodes), additional sources of noise should be considered. This is for further study.

The sources of noise due to timing support provided by telecom transparent clocks (T-TCs) are also for further study.

I.1 Noise introduced by a primary reference time clock (PRTC)

The table below provides the sources of errors in a PRTC.

	Source of error	Explanation/Assumptions
1	Reference time error	See clause I.7.1

I.2 Noise introduced by a packet master clock function

The table below provides the sources of errors in a packet master clock function. The packet master clock function may be a part of a telecom grandmaster (T-GM) or a T-BC.

	Source of error	Explanation/Assumptions
1	Physical layer protocol (PHY) latency asymmetry internal to the nodes	See clause I.7.2

I.3 Noise introduced by a packet slave clock function

The table below provides the sources of errors in a packet slave clock function. The packet slave clock function may be part of a telecom time slave clock (T-TSC) or a T-BC.

	Source of error	Explanation/Assumptions
1	Local oscillator phase noise	See clause I.7.4
2	PHY latency asymmetry internal to the nodes	See clause I.7.2
3	Timestamping granularity	See clause I.7.3
4	Frequency reference phase error	See clause I.7.5
5	Time transients	See clause I.7.6

I.4 Noise introduced by a telecom transparent clock

The sources of error in a telecom transparent clock are for further study.

I.5 Noise introduced by a link

The table below provides the sources of errors in a link.

	Source of error	Explanation/Assumptions
1	Link asymmetry	See clause I.7.7

I.6 Derivation of delay asymmetry

Figure I.1 illustrates the delays between a packet slave clock function, or requestor (denoted as slave throughout this clause), and a packet master clock function, or responder (denoted as master throughout this clause). The mean propagation delay is measured at the slave after exchange of event messages. If the Delay Request and the Delay Response mechanism is used (see [IEEE 1588]), the slave sends Delay_Req and the master sends Delay_Resp and, separately, Sync and Follow_Up (i.e., the sending of Sync and Follow_Up are not part of the Delay_Req/Delay_Resp exchange; the Follow_Up message is sent if, and only if, the clock is two-step). If the Peer Delay mechanism is used (see [IEEE 1588]), the slave sends Pdelay_Req and the master sends Pdelay_Resp and, if the clock is two-step, Pdelay_Resp_Follow_Up.

The figure shows the effective points in the protocol stack of each clock where timestamps are generated, after any corrections for ingress and egress latencies are made (see section 7.3.4 and Figure 19 of [IEEE 1588]). These points would ideally be at the reference plane, i.e., the boundary point between the PHY and the network physical medium. However, in practice, the corrections for ingress and egress latencies are not perfect, and the effective points at which the timestamps are generated differ from the reference plane. The delays between the effective points where timestamps are taken and the reference plane are denoted $d_{tx}^{PHY,M}$ and $d_{rx}^{PHY,M}$ for egress and ingress, respectively, at the master, and $d_{tx}^{PHY,S}$ and $d_{rx}^{PHY,S}$ for egress and ingress, respectively, at the slave. In this notation, the subscript t (transmit) is used for egress and the subscript r (receive) is used for ingress. In general, these four quantities can all be different.

The figure also shows the link delays, which are measured from the reference plane of one clock to the reference plane of the other clock. The delay from the master to the slave is denoted d_{ms}^{link} , and the delay from the slave to the master is denoted d_{sm}^{link} .

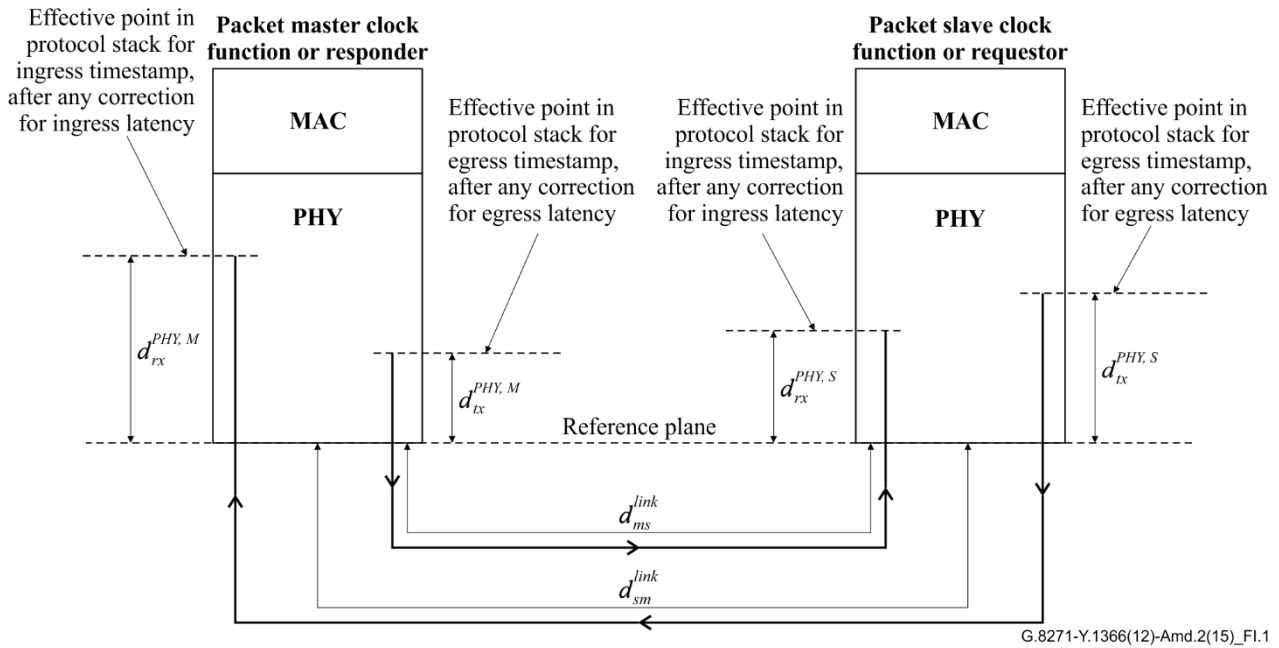

Figure I.1 – Illustration of delays between a packet slave clock function, or requestor, and a packet master clock function, or responder

The total delay from the master to the slave, t_{ms} , is the sum of the delays in that direction:

$$t_{ms} = d_{tx}^{PHY,M} + d_{ms}^{link} + d_{rx}^{PHY,S} \quad (I-1)$$

Similarly, the total delay from the slave to the master, t_{sm} , is the sum of the delays in that direction:

$$t_{sm} = d_{tx}^{PHY,S} + d_{sm}^{link} + d_{rx}^{PHY,M} \quad (I-2)$$

For the sign convention for the delay asymmetry, the same convention as in section 7.4.2 of [IEEE 1588] is adopted. Let D_{mean} denote the measured mean path delay (i.e., the measured result of the exchange of Delay_Req and Delay_Resp or of Peer Delay messages), and D_{asym} denote the total delay asymmetry. Then, D_{asym} is defined to be positive when the delay from the master to the slave is larger than the delay from the slave to the master. Likewise, D_{asym} is defined to be negative when the delay from the master to the slave is smaller than the delay from the slave to the master. Then:

$$\begin{aligned} t_{ms} &= D_{mean} + D_{asym} \\ t_{sm} &= D_{mean} - D_{asym} \end{aligned} \quad (I-3)$$

Equations (I-3) imply that:

$$D_{mean} = \frac{t_{ms} + t_{sm}}{2} \quad (I-4)$$

as required. Substituting equations (I-1) and (I-2) into equation (I-4) gives:

$$D_{mean} = \frac{(d_{tx}^{PHY,M} + d_{ms}^{link} + d_{rx}^{PHY,S}) + (d_{tx}^{PHY,S} + d_{sm}^{link} + d_{rx}^{PHY,M})}{2} \quad (I-5)$$

Either of the two equations (I-3) may be used with equation (I-4) to obtain the delay asymmetry in terms of the component delays. Using the first of equations (I-3) produces:

$$\begin{aligned}
D_{asym} &= t_{ms} - D_{mean} \\
&= (d_{tx}^{PHY,M} + d_{ms}^{link} + d_{rx}^{PHY,S}) - \frac{(d_{tx}^{PHY,M} + d_{ms}^{link} + d_{rx}^{PHY,S}) + (d_{tx}^{PHY,S} + d_{sm}^{link} + d_{rx}^{PHY,M})}{2} \\
&= \frac{d_{tx}^{PHY,M} - d_{rx}^{PHY,M}}{2} + \frac{d_{ms}^{link} - d_{sm}^{link}}{2} + \frac{d_{rx}^{PHY,S} - d_{tx}^{PHY,S}}{2} \\
&= e_{phy}^M + e_{link-asym} - e_{phy}^S
\end{aligned} \tag{I-6}$$

where:

$$e_{phy}^M = \frac{d_{tx}^{PHY,M} - d_{rx}^{PHY,M}}{2} \tag{I-7}$$

$$e_{link-asym} = \frac{d_{ms}^{link} - d_{sm}^{link}}{2} \tag{I-8}$$

$$e_{phy}^S = \frac{d_{tx}^{PHY,S} - d_{rx}^{PHY,S}}{2} \tag{I-9}$$

Equations (I-7) and (I-9) are the errors due to PHY latency asymmetry at the master and slave respectively. Equation (I-8) is the error due to link asymmetry. Equation (I-6) indicates that, in computing the total asymmetry, the errors due to PHY latency at the master and due to the link are added, while the error due to PHY latency at the slave is subtracted.

I.7 Characteristics of the noise sources

Each of the sources of noise identified in previous clauses has different characteristics in terms of modelling and accumulation. As an example, the noise due to cascaded T-BC could be analysed according to the traditional approach followed in ITU-T for a chain of clocks.

The following clauses analyse the noise sources listed in the table above.

I.7.1 Reference time error

The packet master clock function of the T-GM receives a reference time to distribute. The error can be attributed to:

GNSS time error. Distribution schemes that use different GNSS systems (e.g., both GPS and future Galileo) might have an inherent time error due to the difference between the atomic clock ensembles that drive the systems.

GNSS implementation limitations. A GNSS receiver may produce a time signal that has an offset from another GNSS receiver that uses the same satellite system.

This noise source is applicable to PRTCs only.

The way the noise source, e_{ref} , is modelled is for further study.

I.7.2 PHY latency variation and asymmetry

This noise source is related to the hardware timestamping function, i.e., to the difference between the timestamp measurement point and the interface to the medium (e.g., 802.3bf defines the minimum and maximum transmit and receive values possible for each PHY supporting 802.3bf). For a proper

implementation, this will typically be in the range of nanoseconds. The PHY latency asymmetry is defined as $(d_{tx}-d_{rx})/2$, where d_{tx} is the delay on the transmit path and d_{rx} is the delay on the receive path, as indicated in clause I.6 and Figure I.1.

The delays (d_{tx}, d_{rx}) discussed here can be further divided into static delays, which may change based on triggers such as link status reset and power reset, and dynamic delays, which may vary from packet to packet based on triggers such as varying traffic. Depending on the characteristics of any particular delay component, it may or may not be possible to measure and compensate for it. Further detail about the different types of delays involved and their impact on PTP performance of a system is for further study.

This noise source is applicable to the packet master clock function (in a T-GM or a T-BC) and packet slave clock function (in a T-BC or in a T-TSC).

The way the noise source, e_{phy} , is modelled is for further study.

I.7.3 Timestamping granularity

The timestamping granularity depends on the rate of the timestamping clock. The timestamping granularity error is limited in extent by $T_{ts,rx}$, the increment in the timestamp counter at the receiver:

$$0 \leq e_{ts} < T_{ts,rx} \quad (\text{I-10})$$

If the timestamping clock rate at the receiver is an integer multiple/submultiple of the rate at the sender then the beating effect may be observed and the error e_{ts} is almost static and cannot be reduced by the low-pass filtering inherent in phase-locked loops. If the rates are relatively prime then the error e_{ts} is randomized and is well modelled as white noise (flat spectrum).

This noise source is applicable to time-of-arrival measurements at the packet master and packet slave. The same model may apply for the time-of-departure measurements.

I.7.4 Local oscillator phase noise

The packet slave clock function uses the master timing data as reference to filter out its local reference phase noise, so as to produce a time error as small as possible. The better the local oscillator, the less noise it produces. Not all of the phase noise can be filtered out.

This noise source is applicable to the packet slave clock function (in a T-BC or in a T-TSC) when the frequency is recovered from the PTP messages (i.e., there is no physical layer frequency synchronization support).

The way the noise source, e_{ϕ} , is modelled is for further study.

I.7.5 Frequency reference phase error

The packet slave clock function (in a T-BC or in a T-TSC) may use an external frequency reference instead of its local oscillator to help with the recovery of time. The frequency reference will have much better timing characteristics than the local oscillator, but it will not be perfect.

This noise source is applicable to packet slave clock.

This noise source, e_{syncE} , is defined by the network limits in clause 9.2 of [ITU-T G.8261]. The way this noise source is modelled is for further study.

I.7.6 Time transients

Reference switches or short interruptions may cause time transients. Failure in the grandmaster or in a link may produce network rearrangement. During such period, time error can accumulate due to some form of holdover functionality.

This noise source is applicable to packet slave clock.

The way the noise source, $e_{transient}$, is modelled is for further study.

I.7.7 Link asymmetry

Packet timing protocols (such as the network time protocol and the precision time protocol (PTP)) measure the round-trip delay through a network, i.e., the delay from a server to a client and back (or vice versa). The one-way delay is then estimated using the assumption that the forward delay through a network is the same as the reverse delay. Any difference between the forward and reverse delay, (known as delay asymmetry), creates an error in the estimate of the client clock's offset from the server.

The use of full timing support (such as T-BC or T-TC in every node) can eliminate delay asymmetry due to packet delay variation (PDV), and different traffic load on the two traffic directions and asymmetry caused by packets taking different routes in each direction (in this case an end-to-end transparent clock however would not solve the issue). However, it is unable to correct delay asymmetry on point-to-point links between network elements. This asymmetry arises because the forward and reverse paths travel down different fibres or copper pairs in the same cable. These fibres or pairs may have different lengths and different electrical or optical characteristics which are sufficient to create delay differences.

Delay asymmetry created by fibre links can have several nanoseconds per metre of difference in each direction. When used over multiple fibre links, the magnitude of this error can become significant relative to the very tight tolerances required by some of the applications being considered.

The link asymmetry is defined as $(d_{ms}-d_{sm})/2$, where d_{ms} is the delay on the path from the master clock or responder to the slave clock or requestor, and d_{sm} is the delay on the path from the slave clock or requestor to the master clock or responder, as indicated in clause I.6 and Figure I.1.

This noise source is applicable to links.

The way the noise source, $e_{link-asym}$, is modelled is for further study.

I.7.8 Error in distributing time inside a node

This error is due to various internal delays when distributing a time reference from a centralized location in a node (e.g., system card) to other locations in a node (e.g., line card). This error might be attributed, for example, to the length of backplane traces, connectors, and various logic functions.

NOTE – These delays might be non-negligible and proper design and compensation should be performed.

This noise source is defined as $e_{intranode}$, and is for further study. This noise source is applicable to T-GM, T-BC and T-TSC.

I.8 Time error accumulation in a chain of clocks

The total time error can be viewed as the sum of a constant time error component and a dynamic time error component.

NOTE – It is assumed that frequency offset and drift components are not present; therefore, only random components are included in the dynamic time error.

These two components have different characteristics in terms of modelling and accumulation. See Appendix IV of [b-ITU-T G.8271.1] for further details.

Appendix II

Time and phase end application synchronization requirements

(This appendix does not form an integral part of this Recommendation.)

The following table summarizes the main requirements applicable at the output of the application (e.g., on the radio interface in the case of wireless application).

Table II.1 – Time and phase end-application requirements

Application/ Technology	Accuracy	Specification
CDMA2000	$\pm 3 \mu\text{s}$ with respect to CDMA System Time, which uses the GPS timescale (which is traceable and synchronous to UTC except for leap second corrections). $\pm 10 \mu\text{s}$ with respect to CDMA System Time for a period not less than 8 hours (when the external source of CDMA system time is disconnected).	[b-3GPP2 C.S0002] section 1.3 [b-3GPP2 C.S0010] section 4.2.1.1
TD-SCDMA (NodeB TDD mode)	$3 \mu\text{s}$ maximum deviation in frame start times between any pair of cells on the same frequency that have overlapping coverage areas.	[b-3GPP TS 25.123] section 7.2
WCDMA-TDD (NodeB TDD mode)	In TDD mode, to support Intercell Synchronization and Handoff, a common timing reference among NodeB is required, and the relative phase difference of the synchronization signals at the input port of any NodeB in the synchronized area shall not exceed $2.5 \mu\text{s}$.	[b-3GPP TS 25.402] sections 6.1.2 and 6.1.2.1
W-CDMA MBSFN	$12.8 \mu\text{s}$ for MBMS over a single frequency network, where the transmission of NodeB is closely time synchronized to a common reference time.	[b-3GPP TS 25.346] sections 7.1A and 7.1B.2.1
LTE MBSFN	Values $\leq \pm 1 \mu\text{s}$ with respect to a common time reference (continuous timescale) have been mentioned. The cell phase synchronization accuracy measured at BS antenna connectors shall be better than $5 \mu\text{s}$.	[b-3GPP TS 36.133] Section 7.25.2 Under study
W-CDMA (Home NodeB TDD mode)	Microsecond level accuracy (no hard requirement listed).	[b-3GPP TR 25.866] section 8
WiMAX	1) The downlink frames transmitted by the serving base station and the Neighbour base station shall be synchronized to a level of at least 1/8 cyclic prefix length (<i>which is equal to $1.428 \mu\text{s}$</i>). At the base station, the transmitted radio frame shall be time-aligned with the 1PPS timing pulse. 2) The base station transmit reference timing shall be time-aligned with the 1PPS pulse with an accuracy of $\pm 1 \mu\text{s}$.	[b-IEEE 802.16] Table 6-160, section 8.4.13.4 [b-WMF T23-001] section 4.2.2

Table II.1 – Time and phase end-application requirements

Application/ Technology	Accuracy	Specification
LTE-TDD (Wide-Area Base station)	3 μ s for small cell (< 3 km radius) ₂ 10 μ s for large cell (> 3 km radius) ₂ maximum absolute deviation in frame start timing between any pair of cells on the same frequency that have overlapping coverage areas ₂	[b-3GPP TS 36.133] section 7.4.2
LTE-TDD (home-area base station)	1) 3 μ s for small cell (< 500m radius). For large cell (> 500 m radius), $1.33 + T_{propagation}$ μ s time difference between base stations, where $T_{propagation}$ is the propagation delay between the Home base station and the cell selected as the network listening synchronization source. In terms of the network listening synchronization source selection, the best accurate synchronization source to GNSS should be selected. If the Home base station obtains synchronization without using network listening, the small cell requirement applies. 2) The requirement is 3.475 μ s but in many scenarios a 3 μ s sync requirement can be adopted.	[b-3GPP TS 36.133] section 7.4.2 [b-3GPP TR 36.922] section 6.4.1.2
LTE-TDD to CDMA 1xRTT and HRPD handovers	eNB/eNodeB shall be synchronized to GPS time. With external source of CDMA system time disconnected, the eNB/eNodeB shall maintain the timing accuracy within ± 10 μ s with respect to CDMA system time for a period of not less than 8 hours ₂	[b-3GPP TS 36.133] section 7.5.2.1
NR TDD/LTE-A	Phase/Time requirements for the applications listed below are currently under study: • Carrier aggregation • Coordinated multipoint transmission (also known as Network MIMO) • Relaying function <u>The cell phase synchronization accuracy measured at BS antenna connectors shall be better than 3 μs.</u>	[b-3GPP TS 38.133 36.814] <u>Section 7.4.2</u>
IP network delay monitoring	The requirement depends on the level of quality that shall be monitored. As an example ± 100 μ s with respect to a common time reference (e.g., UTC) may be required. ± 1 ms has also been mentioned ₂	NOTE – There is no standard requirement yet. Requirements are operator dependent (depending on the application) ₂
Billing and alarms	± 100 ms with respect to a common time reference (e.g., UTC) ₂	
<p>NOTE 1 – In the case of mobile applications, the requirements are generally expressed in terms of phase error between base stations. In the case of a centralized master, the requirement could be expressed as \pm half of the accuracy requirement applicable to the specific technology.</p> <p>NOTE 2 – The requirements are generally valid during normal conditions. The applicable requirements during failure conditions are for further study.</p>		

Table II.2—Other time and phase requirements

Typical applications (for information)	Synchronization requirements	Specification
Asynchronous dual connectivity (note, applicable only for FDD-FDD inter-band dual connectivity)	500 μ s (Note 4)	[b-3GPP TS 36.133]
Synchronous dual connectivity (note, applicable only for TDD-TDD and FDD-FDD inter-band dual connectivity)	33 μ s (Note 4)	[b-3GPP TS 36.133] section 7.13 and 7.15.2
Intra-band non-contiguous carrier aggregation with or without MIMO or TX diversity, and inter-band carrier aggregation with or without MIMO or TX diversity	260 ns (Note 3)	[b-3GPP TS 36.104] section 6.5.3.1
Intra-band contiguous carrier aggregation, with or without MIMO or TX diversity	130 ns (Note 3)	[b-3GPP TS 36.104] section 6.5.3.1
Location Based Services using OTDOA (Note 2)	100 ns	
MIMO or TX diversity transmissions, at each carrier frequency	65 ns (Note 3)	[b-3GPP TS 36.104] section 6.5.3.1
More emerging LTE-A features that require multiple antenna co-operation within a cluster.	x ns (Note 1) (Note 3)	
<p>NOTE 1—The performance requirements of the LTE-A features are under study. The value for x is for further study.</p> <p>NOTE 2—100 ns supports approximately 30–40m of location accuracy when using OTDOA with a minimum of three base stations.</p> <p>NOTE 3—The requirements are expressed in terms of time alignment error (TAE) in the 3GPP specifications, which is defined as the largest timing difference between any two signals (i.e., radio signal transmitted from base station sectors). In ITU-T terminology, this is equivalent to maximum relative time error between any two radio signals (i.e., base station sectors), both of which have the same timing reference. Although phase/time accuracy requirements for CA and CoMP are generic and are not defined for any particular network topology, this level of phase error budget in general could be achieved by antennas that are co-located with or connected to the same BBU via direct links. The support of some of these synchronization requirements for scenarios where the antennas are neither co-located (e.g., as related to Inter-site carrier aggregation) nor connected via direct links to the same BBU is under study.</p> <p>NOTE 4—Maximum absolute timing mismatch between subframes which are transmitted by Master eNB (MeNB) and Secondary eNB (SeNB) and are scheduled for the same UE. This means that part of this budget should be allocated to propagation time difference between MeNB and SeNB. As an example 9 km propagation difference accounts for approximately 30 μs, which leaves 3 μs time error between the eNBs. 7 km propagation difference accounts for approximately 23 μs, which leaves 10 μs time error between the eNBs.</p>		

Other classes of applications that require accurate time and phase synchronization include Machine to Machine (M2M) communication and Industrial Internet (e.g., transportation and connected vehicles, smart power grids, financial trading, remote medical & health care systems, enhanced safety and security surveillance, etc.). The actual synchronization requirements depend on the specific application, and are for further study.

Table II.2 – Other time and phase requirements

<u>Typical applications (for information)</u>	<u>Synchronization requirements (MRTD or TAE) (Note 1)</u>	<u>Specification</u>
<u>LTE asynchronous dual connectivity (Note: applicable only for FDD–FDD inter-band dual connectivity).</u>	<u>No network synchronization requirement (Note 2)</u>	<u>[b-3GPP TS 36.133] section 7.15.2</u>
<u>LTE synchronous dual connectivity.</u>	<u>33 μs MRTD</u>	<u>[b-3GPP TS 36.133] sections 7.13 and 7.15.2</u>
<u>Inter-band asynchronous EN-DC (E-UTRAN NR Dual Connectivity) (Note 3)</u>	<u>No network synchronization requirement (Note 2)</u>	<u>[b-3GPP TS 38.133] section 7.6.2</u>
<u>Inter-band synchronous EN-DC (E-UTRAN NR Dual Connectivity) (Note 3).</u>	<u>33 μs MRTD</u>	<u>[b-3GPP TS 38.133] section 7.6.2</u>
<u>NR Inter-band carrier aggregation.</u>	<u>33μs MRTD (FR1) 8 μs MRTD (FR2) (Notes 4, 5)</u>	<u>[b-3GPP TS 38.133] section 7.6.4</u>
<u>NR Intra-band synchronous EN dual connectivity (Note: applicable for E-UTRA TDD – NR TDD and E-UTRA FDD – NR FDD).</u>	<u>3 μs MRTD (Note 6)</u>	<u>[b-3GPP TS 38.133] section 7.6.3</u>
<u>NR Inter-band carrier aggregation; with or without MIMO or TX diversity.</u>	<u>3 μs TAE</u>	<u>[b-3GPP TS 38.104] sections 9.6.3.2, 9.6.3.3</u>
<u>NR Intra-band non-contiguous carrier aggregation, with or without MIMO or TX diversity.</u>	<u>3 μs TAE (Note 7)</u>	<u>[b-3GPP TS 38.104] sections 9.6.3.2, 9.6.3.3</u>
<u>NR Intra-band contiguous carrier aggregation, with or without MIMO or TX diversity.</u>	<u>260 ns TAE (FR1) 130 ns TAE (FR2) (Notes 4, 7, 8)</u>	<u>[b-3GPP TS 38.104] sections 9.6.3.2, 9.6.3.3</u>
<u>LTE Intra-band non-contiguous carrier aggregation with or without MIMO or TX diversity, and inter-band carrier aggregation with or without MIMO or TX diversity.</u>	<u>260 ns TAE (Notes 9, 10)</u>	<u>[b-3GPP TS 36.104] section 6.5.3.1</u>
<u>LTE Intra-band contiguous carrier aggregation, with or without MIMO or TX diversity.</u>	<u>130 ns TAE (Notes 8, 9)</u>	<u>[b-3GPP TS 36.104] section 6.5.3.1</u>
<u>Location-based services using OTDOA.</u>	<u>100 ns TAE (Note 11)</u>	
<u>NR MIMO or TX diversity transmissions, at each carrier frequency.</u>	<u>65 ns TAE (Note 8)</u>	<u>[b-3GPP TS 38.104] sections 9.6.3.2, 9.6.3.3</u>
<u>LTE MIMO or TX diversity transmissions, at each carrier frequency.</u>	<u>65 ns TAE (Notes 8)</u>	<u>[b-3GPP TS 36.104] section 6.5.3.1</u>
<u>NOTE 1 – The synchronization requirements in the 3GPP specifications are expressed in terms of either maximum received timing difference (MRTD) or time alignment error (TAE):</u>		

Table II.2 – Other time and phase requirements

<u>Typical applications (for information)</u>	<u>Synchronization requirements (MRTD or TAE) (Note 1)</u>	<u>Specification</u>
<ul style="list-style-type: none"> – <u>MRTD concerns the maximum absolute timing mismatch between subframes which are transmitted by Master eNB (MeNB) and Secondary eNB (SeNB) and are scheduled for the same user equipment (UE). This means that part of this budget should be allocated to propagation time difference between MeNB and SeNB. As an example, a 9 km propagation difference accounts for approximately 30 μs, which leaves 3 μs time error between the eNBs. A 7 km propagation difference accounts for approximately 23 μs, which leaves 10 μs time error between the eNBs. The same is applicable for NR.</u> – <u>TAE is defined in [b-3GPP TS 36.104] and [b-3GPP TS 38.104] as the largest timing difference between any two radio signals at the antenna connectors of the base stations. For further details, refer to the relevant 3GPP specifications. In ITU-T terminology, this is equivalent to the maximum relative time error between the two radio signals.</u> <p><u>NOTE 2 – For asynchronous dual connectivity there is no network synchronization requirement implied for the base stations. The MRTD values indicated in the 3GPP specification are tolerance requirements on the UE to accept MRTD of up to half of the corresponding time slot length (e.g., half of 1 ms). This is the maximum possible delay difference, since if it is larger than this, the next time slot would be referenced.</u></p> <p><u>NOTE 3 – For inter-band dual connectivity, it is mandatory for the UE to support the asynchronous mode. For intra-band FDD-FDD dual connectivity, it is optional for the UE to support asynchronous mode.</u></p> <p><u>NOTE 4 – FR1: 450 MHz – 6 GHz; FR2: 24.25 – 52.6 GHz.</u></p> <p><u>NOTE 5 – The requirement for FR1–FR2 carrier aggregation is under discussion.</u></p> <p><u>NOTE 6 – Intra-band synchronous EN-DC is defined for co-located deployments only (therefore no budget related to the propagation time differences is allocated to the MRTD in this case).</u></p> <p><u>NOTE 7 – For NR intra-band carrier aggregation, only co-located deployment is applicable.</u></p> <p><u>NOTE 8 – The requirement assumes co-located deployments (e.g., antennas installed on the same roof).</u></p> <p><u>NOTE 9 – Although phase/time accuracy requirements for CA and CoMP are generic and are not defined for any particular network topology, this level of phase error budget in general could be achieved by antennas that are co-located with or connected to the same base band unit (BBU) or centralized unit/ distributed unit (CU/DU) via direct links. The support of some of these synchronization requirements for scenarios where the antennas are neither co-located (e.g., as related to Inter-site carrier aggregation) nor connected via direct links to the same BBU or CU/DU is for further study.</u></p> <p><u>NOTE 10 – For the cases of LTE Intra-band non-contiguous carrier aggregation and inter-band carrier aggregation, MRTD requirements are also provided (30.26 μs, see [b-3GPP 36.133] sections 7.9.2 and 7.9.3).</u></p> <p><u>NOTE 11 – 100 ns supports approximately 30-40m of location accuracy when using OTDOA with a minimum of three base stations.</u></p>		

Appendix III

Asymmetry compensation for use of different wavelengths

(This appendix does not form an integral part of this Recommendation.)

The compensation of asymmetry due to the use of different wavelengths is obtained by calculating the group delay applicable to wavelengths used in the forward and in the reverse direction.

Indicating with A the asymmetry, the following applies:

$$A = d_f - d_r = L * (n_r - n_f)/c$$

Where L is the distance, c is the speed of light, d_f and d_r are the forward and reverse transmission delay, and n_r and n_f are the group refractive indexes applicable at the wavelength used in the forward and reverse direction, respectively.

The evaluation of the refractive indexes can be done either using known chromatic dispersion data (e.g., from the optical fibre data-sheet) or, in the case that the dispersion is unknown, making a direct delay measurement at three different wavelengths (the refractive index for an arbitrary wavelength can then be derived by quadratic interpolation).

These data can then be used to derive the group delay of a generic wavelength. In particular, in the case of an ITU-T G.652 compliant fibre, the group delay at the applicable wavelengths can be calculated making use of the Sellmeier equations as described in [ITU-T G.652].

Appendix IV

Link and network asymmetry compensation

(This appendix does not form an integral part of this Recommendation.)

In order to compensate for link delay asymmetry, it might be desirable to have in place some automatic link asymmetry calibration procedure. This could be based on calculating the propagation delays by means of two-way measurements made on the fibres used by the traffic.

The procedure can be done separately on both fibres (in the fibre used in the forward direction and in the fibre used for the reverse direction) providing the forward propagation delay d_f and the reverse propagation delay d_r . This is shown in Figure IV.1.

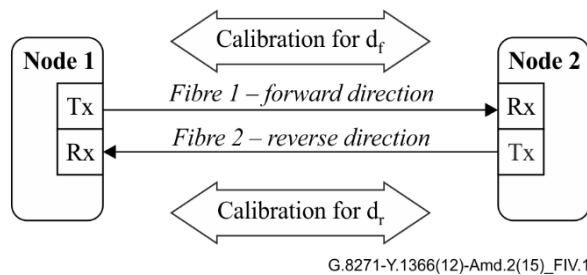

Figure IV.1 – Link asymmetry calibration process (performed separately on both fibres)

Alternatively, the round trip measurement could be done in two steps on both fibres by reversing the direction of transmission. This is shown in Figure IV.2.

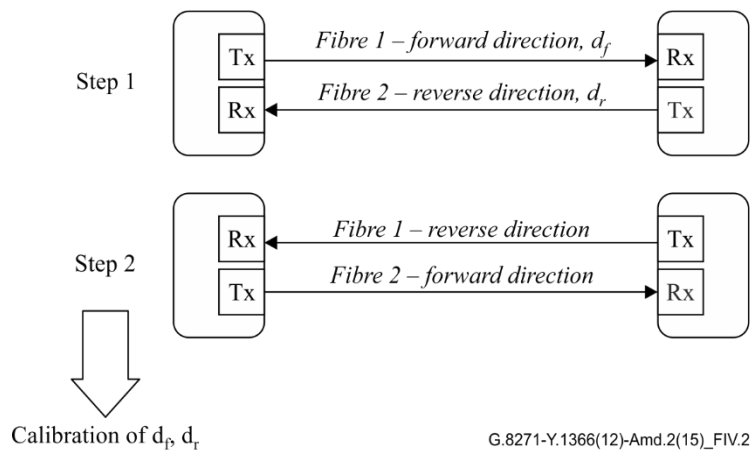

Figure IV.2 – Link asymmetry calibration process (performed on both fibres at the same time)

NOTE 1 – In the case of the connection between master and slave, as shown in Figure I.1, the following would apply:

$$d_f = d_{ms}$$

$$d_r = d_{sm}$$

The link asymmetry calibration mechanism must meet an accuracy objective for d_f and d_r estimations. This limit is for further study.

NOTE 2 – In the case during the asymmetry calculation procedure where one node enters holdover (e.g., caused by the fibres-swapping if this is required by the procedure), the effect of the frequency holdover needs to be taken into account as it might impact the accuracy of the measurement.

Several implementations are possible, e.g., based on optical switches or fixed or tunable add drop filters. Depending on the implementation, it may not be required to interrupt the traffic during the calibration process and hence in-service operation might be possible. However, the asymmetry compensation is a process that is only required at start-up or during rearrangements in the network.

This measurement is applicable for wavelength-division-multiplexing (WDM) systems (including optical transport network (OTN)) and non-WDM systems. In the case of wavelength-division-multiplexing systems, this measurement should also take into account possible delay due to dispersion-compensating fibre (DCF).

NOTE 3 – In the case of WDM systems, the asymmetry due to the use of different wavelengths in the two directions should also be taken into account. Indeed, the use of different wavelengths on the two fibres, (or in a single fibre in the case of a transmission system using a single fibre), would result in different delays even if the fibres have the same length. Note also that a compensation related to the same aspect would be required if the wavelength used during the link asymmetry calibration process is different from the wavelength used by the traffic. Suitable methodologies to address this point are introduced in Appendix III.

The difference ($d_f - d_r$) can be used in the evaluation of the delay asymmetry to be used in the time recovering process. In particular the *delayAsymmetry* parameter as defined in section 7.4 of [IEEE 1588] would be half of that difference.

NOTE 4 – If a T-BC is implemented in every node, the compensation can be triggered directly by the T-BC, which would know the difference ($d_f - d_r$). If this is not the case, some means have to be provided in order to make the difference ($d_f - d_r$) available at the points in the network where the precision time protocol (PTP) messages are processed. This is for further study.

NOTE 5 – In the case of a time synchronization carried by PTP, the PTP connection may have asymmetry due to a variety of reasons, including network paths, loading levels or cable lengths. The asymmetry of a PTP connection may be evaluated at a PTP network element, if the network element has access to a second time synchronization source that is not significantly impacted by asymmetry (such as a GNSS receiver, or a time synchronization reference carried via timing protocols such as PTP with proper accuracy) as shown in Figure IV.3. If the asymmetry of the PTP connection is evaluated using such a second time synchronization source, then the offset caused by the asymmetry may be compensated by the network element. The same principle could be applied between network elements in a chain.

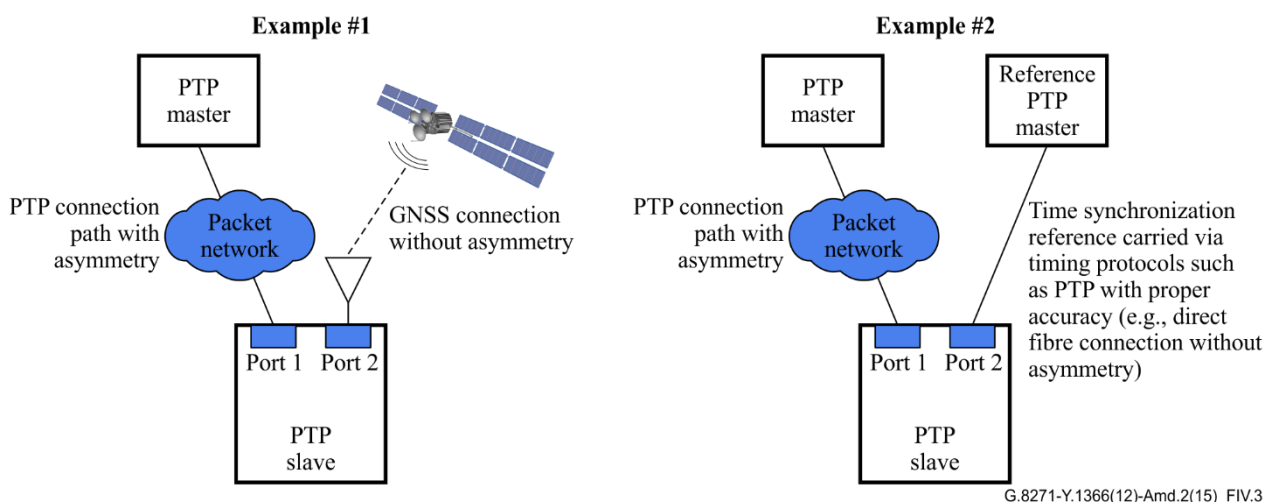

Figure IV.3 – PTP slave evaluating PTP connection asymmetry

There are cases when asymmetry is generally static but can change over time due to rare network rearrangements, or the re-start of network nodes. This could happen, for example, in the case of OTN networks. In these cases, it has been reported that clients carried over OTN may be impacted by

changes in the asymmetry whenever a network node is re-started or there are network rearrangements. These can be considered relatively rare events (e.g., in the order of weeks/months), but with an impact that could be on the order of microseconds. Similar events may happen in packet networks (e.g., re-routing).

These cases can be referred to as "*semi-static asymmetry*".

For these cases, assuming the phase change in one of the references is sufficiently large compared with the relevant level of accuracy (see Table 1), and sufficiently fast compared with the relevant clock bandwidth, changes in semi-static asymmetry may be controlled when at least 2 independent timing references are available, with the assumptions that only one at the time is impacted by such changes. This is illustrated in Figure IV.4.

In this example, it is assumed that the asymmetry from all links is first compensated at the start-up by means of a trusted synchronization reference (e.g., via temporary connection to a GNSS reference, or via availability of the GNSS reference as a regular synchronization input).

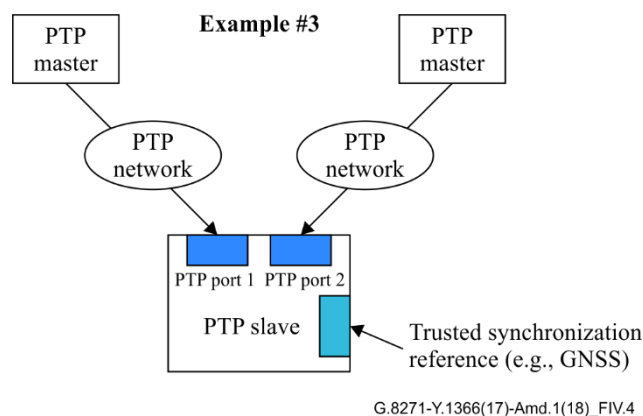

Figure IV.4 – Monitoring of semi-static asymmetry

The PTP network in this example could be based on full timing support or (assisted) partial timing support.

Assuming only one reference at the time is impacted by changes of network asymmetry (and that, as mentioned earlier, the phase step is sufficiently large and fast), the second reference (not experiencing significant and sudden changes of the relevant parameters, e.g., meanPathDelay, offsetFromMaster) can be used to correct for changes in asymmetry and/or issue an alarm. This may assume that full exchange of PTP messages is present also on the PTP port which is not in the SLAVE state.

The correction for asymmetries during normal operation requires proper operation in the slave as to control phase transients, according to the relevant clock specification.

NOTE 6 – Correction for asymmetry may not be sufficiently accurate after several compensations. Therefore, recalibration with a trusted source would be required.

NOTE 7 – The PTP slave shown in Figures IV.3 and IV.4 could be implemented in a T-BC (i.e., there could be downstream nodes connected to the node correcting for asymmetries in the network).

NOTE 8 – The procedures for scheduled or on-demand measurement of asymmetry are for further study.

Appendix V

Delay asymmetry resulting from interface rate change in PTP-unaware network elements

(This appendix does not form an integral part of this Recommendation.)

In case the master and slave are not connected to a PTP aware network element (e.g., BC or TC) and are not using the same Ethernet line speed, a delay asymmetry can be generated due to the "store and forwarding" nature of Ethernet switches, meaning the switch needs to receive the entire frame before starting transmission on port with a faster line speed, to ensure that the packet data is available for transmission. The minimal time necessary to transfer the packet across the switch depends on the length of the packet and the ingress line rate. Sync and Delay_Req PTP packets have been defined to have the same length in order to reduce delay asymmetry caused by different transition delay, however Ethernet speed mismatch will generate asymmetry.

The expected asymmetry can be estimated based on the PTP event message packet size and interfaces speed.

In case the static asymmetry caused by the speed mismatch is known, it can be compensated by the slave using asymmetric delay compensation mechanism defined in [IEEE 1588], section 11.6.

The following example is used to illustrate the asymmetry generated by a speed mismatch:

- Packet format uses UDP/IPv4/Ethernet header, giving total packet size of 86 bytes (excluding preamble and FCS).
- Preamble is 8 bytes.
- FCS is 4 bytes.
- PTP Grand Master timestamp event interface is GE (1000 Mbit/s).
- PTP slave timestamp event interface is FE (100 Mbit/s).
- The packet switched network (PSN) delay is assumed to be symmetrical.

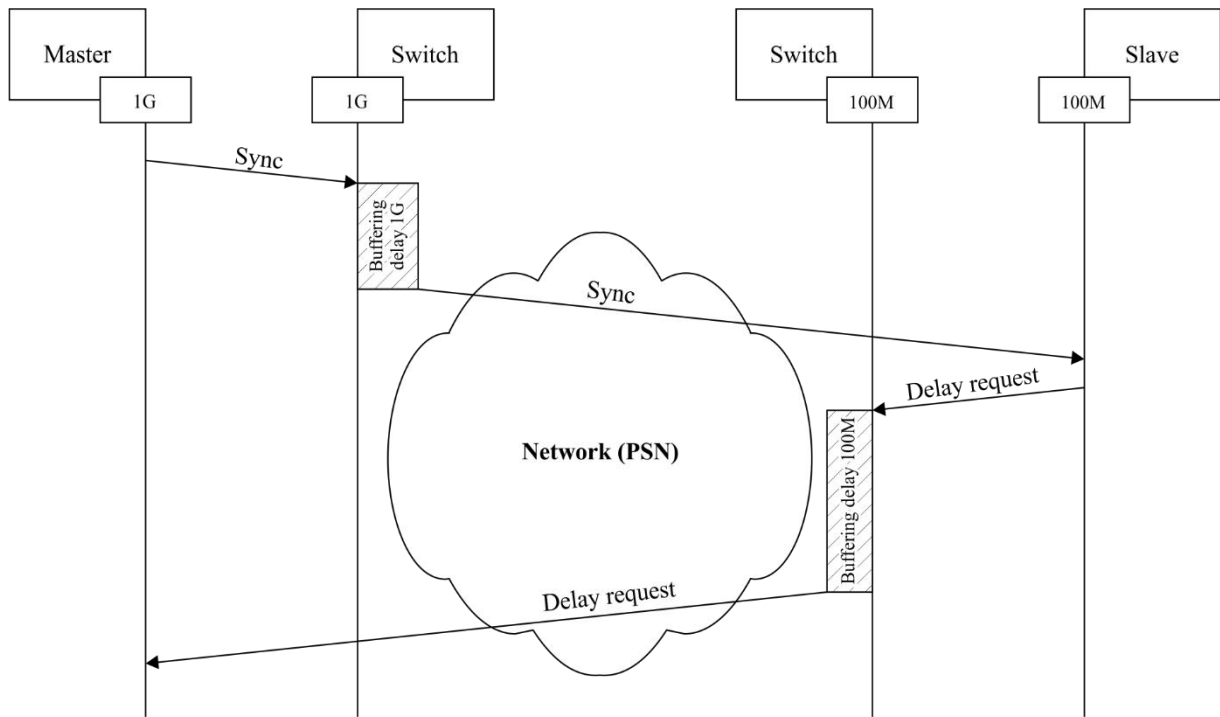

G.8271-Y.1366(16)_FV.1

Figure V.1 – Speed mismatch example

This yields the following equation for delay between the timestamp event points.

In the forward direction from the master to the slave, the delay between the timestamp event points is:

$$t2 = (L_{PKT} + L_{FCS})_{bytes} \times 8_{bits/byte} \times GE_{ns/bit} + D_{PSN} + (L_{Pre-amble})_{bytes} \times 8_{bits/byte} \times FE_{ns/bit} + t1 \quad (V-1)$$

In the reverse direction from the slave to the master, the delay between the timestamp event points is:

$$t4 = (L_{PKT} + L_{FCS})_{bytes} \times 8_{bits/byte} \times FE_{ns/bit} + D_{PSN} + (L_{Pre-amble})_{bytes} \times 8_{bits/byte} \times GE_{ns/bit} + t3 \quad (V-2)$$

The <meanPathDelay> formula from equation (V-2) is:

$$\langle meanPathDelay \rangle = \frac{[(t2 - t1) + (t4 - t3)]}{2} \quad (V-3)$$

Substituting $(t2 - t1)$ for equation (V-1) and $(t4 - t3)$ for equation (V-2) then:

$$\langle meanPathDelay \rangle = \frac{(L_{PKT} + L_{FCS} + L_{Pre-amble}) \times 8 \times (GE + FE)_{ns} + 2 \times D_{PSN}}{2} \quad (V-4)$$

$$\langle meanPathDelay \rangle = (L_{PKT} + L_{FCS} + L_{Pre-amble}) \times 8 \times \frac{GE + FE}{2}_{ns} + D_{PSN} \quad (V-5)$$

By convention the <delayPathAsymmetry> is positive when the forward path is longer than the reverse path.

The delay path asymmetry is then the difference between equations (V-1) and (V-5).

$$\langle delayPathAsymmetry \rangle = (L_{PKT} + L_{FCS}) \times 8 \times \left(\frac{GE - FE}{2}\right)_{ns} + (L_{Pre-amble}) \times 8 \times \left(\frac{FE - GE}{2}\right)_{ns} \quad (V-6)$$

or as the difference between equations (V-5) and (V-2)

$$\langle \text{delayPathA symmetry} \rangle = (L_{PKT} + L_{FCS}) \times 8 \times \left(\frac{GE - FE}{2} \right)_{ns} + (L_{Pre-amble}) \times 8 \times \left(\frac{FE - GE}{2} \right)_{ns} \quad (\text{V-7})$$

Substituting for real values into equation (V-6) we obtain:

$$\begin{aligned} \langle \text{delayPathA symmetry} \rangle &= (86 + 4) \times 8 \times \left(\frac{1 - 10}{2} \right)_{ns} + (8) \times 8 \times \left(\frac{10 - 1}{2} \right)_{ns} \\ \langle \text{delayPathA symmetry} \rangle &= -2952_{ns} \end{aligned}$$

The general term for the delay asymmetry caused by the speed mismatch:

$$\langle \text{delayPathA symmetry} \rangle = (L_{PKT} + L_{FCS}) \times 8 \times \left(\frac{V_{Master} - V_{Slave}}{2} \right) + (L_{Pre-amble}) \times 8 \times \left(\frac{V_{Master} - V_{Slave}}{2} \right) \quad (\text{V-8})$$

Where:

- L_{PKT} is the length of the packet (excluding the preamble and FCS) in bytes
- L_{FCS} is the length of the packet FCS in bytes
- $L_{Pre-amble}$ is the length of the packet preamble in bytes
- V_{Master} is the timestamp interface bit period on the PTP Master Clock in seconds/bit
- V_{Slave} is the timestamp interface bit period on the PTP Slave Clock in seconds/bit

Bibliography

- [b-ITU-T G.652] Recommendation ITU-T G.652 (2009), *Characteristics of a single-mode optical fibre and cable*.
- [b-ITU-T G.8271.1] Recommendation ITU-T G.8271.1/Y.1366.1 (2013), *Network limits for time synchronization in packet networks*.
- [b-ITU-T G.8271.2] Recommendation ITU-T G.8271.1/Y.1366.1 (2017), *Network limits for time synchronization in packet networks with partial timing support from the network*.
- [b-IEEE 802.16] IEEE 802.16-2012, *IEEE Standard for Local and Metropolitan Area Networks Part 16: Air Interface for Broadband Wireless Access Systems*.
<<http://standards.ieee.org/findstds/standard/802.16-2012.html>>
- [b-IEEE 802.3bf] IEEE 802.3-2011, *IEEE Standard for Information technology – Local and metropolitan area networks – Part 3: CSMA/CD Access Method and Physical Layer Specifications Amendment 7: Media Access Control (MAC) Service Interface and Management Parameters to Support Time Synchronization Protocols*.
<<http://www.techstreet.com/ieee/searches/13964866>>
- [b-WMF T23-001] WMF-T23-001-R015v03 (2012), *WiMAX Forum® Air Interface Specifications – Mobile System Profile Specification*
<http://resources.wimaxforum.org/sites/wimaxforum.org/files/technical_document/2012/04/WMF-T23-001-R015v03_MSP-Common-Part.pdf>
- [b-3GPP TR 25.836] 3GPP TR 25.836 (2001), *Node B synchronization for TDD*.
<<http://www.3gpp.com/ftp/Specs/html-info/25836.htm>>
- [b-3GPP TR 25.866] 3GPP TR 25.866 (2009), *1.28 Mcps TDD Home NodeB (HNB) study item technical report*.
<<http://www.3gpp.com/ftp/Specs/html-info/25866.htm>>
- [b-3GPP TR 36.814] 3GPP TR 36.814 (2010), *Evolved Universal Terrestrial Radio Access (E-UTRA); Further advancements for E-UTRA physical layer aspects*.
<<http://www.3gpp.com/ftp/Specs/html-info/36814.htm>>
- [b-3GPP TR 36.922] 3GPP TR 36.922 (2015), *Evolved Universal Terrestrial Radio Access (E-UTRA); TDD Home eNode B (HeNB) Radio Frequency (RF) requirements analysis*.
<<http://www.3gpp.com/ftp/Specs/html-info/36922.htm>>
- [b-3GPP TS 25.123] 3GPP TS 25.123 (2015), *Requirements for support of radio resource management (TDD)*.
<<http://www.3gpp.com/ftp/Specs/html-info/25123.htm>>
- [b-3GPP TS 25.346] 3GPP TS 25.346 (2016), *Introduction of the Multimedia Broadcast/Multicast Service (MBMS) in the Radio Access Network (RAN); Stage 2*.
<<http://www.3gpp.com/ftp/Specs/html-info/25346.htm>>
- [b-3GPP TS 25.402] 3GPP TS 25.402 (2016), *Universal Mobile Telecommunications Systems (UMTS); Synchronization in UTRAN Stage 2*.
<<http://www.3gpp.com/ftp/Specs/html-info/25402.htm>>
- [b-3GPP TS 36.104] 3GPP TS 36.104 (2016), *Evolved Universal Terrestrial Radio Access (E-UTRA); Base Station (BS) radio transmission and reception*.
<<http://www.3gpp.com/ftp/Specs/html-info/36104.htm>>

- [b-3GPP TS 36.133] 3GPP TS 36.133 (2016), *Evolved Universal Terrestrial Radio Access (E-UTRA); Requirements for support of radio resource management.*
<<http://www.3gpp.com/ftp/Specs/html-info/36133.htm>>
- [b-3GPP TS 38.104] 3GPP TS 38.104 (2018), *NR; Base Station (BS) radio transmission and reception.*
<<http://www.3gpp.com/ftp/Specs/html-info/38104.htm>>
- [b-3GPP TS 38.133] 3GPP TS 38.133 (2018), *NR; Requirements for support of radio resource management.*
<<http://www.3gpp.com/ftp/Specs/html-info/38133.htm>>
- [b-3GPP2 C.S0010] 3GPP2 C.S0010-E v2.0 (2014), *Recommended Minimum Performance Standards for cdma2000 Spread Spectrum Base Stations.*
<http://www.3gpp2.org/Public_html/specs/C.S0010-E_v2.0_20140321.pdf>
- [b-3GPP2 C.S0002] 3GPP2 C.S0002-F v2.0 (2014), *Physical layer standard for cdma2000 Spread Spectrum Systems.*
<http://www.3gpp2.org/Public_html/specs/C.S0002-F_v2.0_20140519.pdf>

ITU-T Y-SERIES RECOMMENDATIONS

GLOBAL INFORMATION INFRASTRUCTURE, INTERNET PROTOCOL ASPECTS, NEXT-GENERATION NETWORKS, INTERNET OF THINGS AND SMART CITIES

GLOBAL INFORMATION INFRASTRUCTURE	
General	Y.100–Y.199
Services, applications and middleware	Y.200–Y.299
Network aspects	Y.300–Y.399
Interfaces and protocols	Y.400–Y.499
Numbering, addressing and naming	Y.500–Y.599
Operation, administration and maintenance	Y.600–Y.699
Security	Y.700–Y.799
Performances	Y.800–Y.899
INTERNET PROTOCOL ASPECTS	
General	Y.1000–Y.1099
Services and applications	Y.1100–Y.1199
Architecture, access, network capabilities and resource management	Y.1200–Y.1299
Transport	Y.1300–Y.1399
Interworking	Y.1400–Y.1499
Quality of service and network performance	Y.1500–Y.1599
Signalling	Y.1600–Y.1699
Operation, administration and maintenance	Y.1700–Y.1799
Charging	Y.1800–Y.1899
IPTV over NGN	Y.1900–Y.1999
NEXT GENERATION NETWORKS	
Frameworks and functional architecture models	Y.2000–Y.2099
Quality of Service and performance	Y.2100–Y.2199
Service aspects: Service capabilities and service architecture	Y.2200–Y.2249
Service aspects: Interoperability of services and networks in NGN	Y.2250–Y.2299
Enhancements to NGN	Y.2300–Y.2399
Network management	Y.2400–Y.2499
Network control architectures and protocols	Y.2500–Y.2599
Packet-based Networks	Y.2600–Y.2699
Security	Y.2700–Y.2799
Generalized mobility	Y.2800–Y.2899
Carrier grade open environment	Y.2900–Y.2999
FUTURE NETWORKS	Y.3000–Y.3499
CLOUD COMPUTING	Y.3500–Y.3999
INTERNET OF THINGS AND SMART CITIES AND COMMUNITIES	
General	Y.4000–Y.4049
Definitions and terminologies	Y.4050–Y.4099
Requirements and use cases	Y.4100–Y.4249
Infrastructure, connectivity and networks	Y.4250–Y.4399
Frameworks, architectures and protocols	Y.4400–Y.4549
Services, applications, computation and data processing	Y.4550–Y.4699
Management, control and performance	Y.4700–Y.4799
Identification and security	Y.4800–Y.4899
Evaluation and assessment	Y.4900–Y.4999

For further details, please refer to the list of ITU-T Recommendations.

SERIES OF ITU-T RECOMMENDATIONS

- Series A Organization of the work of ITU-T
- Series D Tariff and accounting principles and international telecommunication/ICT economic and policy issues
- Series E Overall network operation, telephone service, service operation and human factors
- Series F Non-telephone telecommunication services
- Series G Transmission systems and media, digital systems and networks**
- Series H Audiovisual and multimedia systems
- Series I Integrated services digital network
- Series J Cable networks and transmission of television, sound programme and other multimedia signals
- Series K Protection against interference
- Series L Environment and ICTs, climate change, e-waste, energy efficiency; construction, installation and protection of cables and other elements of outside plant
- Series M Telecommunication management, including TMN and network maintenance
- Series N Maintenance: international sound-programme and television transmission circuits
- Series O Specifications of measuring equipment
- Series P Telephone transmission quality, telephone installations, local line networks
- Series Q Switching and signalling, and associated measurements and tests
- Series R Telegraph transmission
- Series S Telegraph services terminal equipment
- Series T Terminals for telematic services
- Series U Telegraph switching
- Series V Data communication over the telephone network
- Series X Data networks, open system communications and security
- Series Y Global information infrastructure, Internet protocol aspects, next-generation networks, Internet of Things and smart cities**
- Series Z Languages and general software aspects for telecommunication systems