

Superseded by a more recent version



INTERNATIONAL TELECOMMUNICATION UNION

ITU-T

TELECOMMUNICATION
STANDARDIZATION SECTOR
OF ITU

G.663

(10/96)

SERIES G: TRANSMISSION SYSTEMS AND MEDIA,
DIGITAL SYSTEMS AND NETWORKS

Transmission media characteristics – Characteristics of
optical components and sub-systems

**Application related aspects of optical fibre
amplifier devices and sub-systems**

ITU-T Recommendation G.663
Superseded by a more recent version

(Previously CCITT Recommendation)

Superseded by a more recent version

ITU-T G-SERIES RECOMMENDATIONS

TRANSMISSION SYSTEMS AND MEDIA, DIGITAL SYSTEMS AND NETWORKS

INTERNATIONAL TELEPHONE CONNECTIONS AND CIRCUITS	G.100–G.199
INTERNATIONAL ANALOGUE CARRIER SYSTEM	
GENERAL CHARACTERISTICS COMMON TO ALL ANALOGUE CARRIER-TRANSMISSION SYSTEMS	G.200–G.299
INDIVIDUAL CHARACTERISTICS OF INTERNATIONAL CARRIER TELEPHONE SYSTEMS ON METALLIC LINES	G.300–G.399
GENERAL CHARACTERISTICS OF INTERNATIONAL CARRIER TELEPHONE SYSTEMS ON RADIO-RELAY OR SATELLITE LINKS AND INTERCONNECTION WITH METALLIC LINES	G.400–G.449
COORDINATION OF RADIOTELEPHONY AND LINE TELEPHONY	G.450–G.499
TRANSMISSION MEDIA CHARACTERISTICS	
General	G.600–G.609
Symmetric cable pairs	G.610–G.619
Land coaxial cable pairs	G.620–G.629
Submarine cables	G.630–G.649
Optical fibre cables	G.650–G.659
Characteristics of optical components and sub-systems	G.660–G.699
DIGITAL TRANSMISSION SYSTEMS	
TERMINAL EQUIPMENTS	G.700–G.799
DIGITAL NETWORKS	G.800–G.899
DIGITAL SECTIONS AND DIGITAL LINE SYSTEM	G.900–G.999

For further details, please refer to ITU-T List of Recommendations.

Superseded by a more recent version

ITU-T RECOMMENDATION G.663

APPLICATION RELATED ASPECTS OF OPTICAL FIBRE AMPLIFIER DEVICES AND SUB-SYSTEMS

Summary

This Recommendation covers application related aspects of OFA devices and sub-systems, primarily used in digital systems and is valid only for systems operating in the 1550 nm region. Applications include both single-channel and multi-channel systems used in point-to-point and point-to-multipoint configurations for use in long-distance networks and optical access networks. The purpose of this Recommendation is to identify which aspects should be considered for each application and to specify appropriate parameter values and ranges for each type of OFA device.

Source

ITU-T Recommendation G.663 was prepared by ITU-T Study Group 15 (1993-1996) and was approved by WTSC (Geneva, 9-18 October 1996).

Superseded by a more recent version

FOREWORD

ITU (International Telecommunication Union) is the United Nations Specialized Agency in the field of telecommunications. The ITU Telecommunication Standardization Sector (ITU-T) is a permanent organ of the ITU. The ITU-T is responsible for studying technical, operating and tariff questions and issuing Recommendations on them with a view to standardizing telecommunications on a worldwide basis.

The World Telecommunication Standardization Conference (WTSC), which meets every four years, establishes the topics for study by the ITU-T Study Groups which, in their turn, produce Recommendations on these topics.

The approval of Recommendations by the Members of the ITU-T is covered by the procedure laid down in WTSC Resolution No. 1.

In some areas of information technology which fall within ITU-T's purview, the necessary standards are prepared on a collaborative basis with ISO and IEC.

NOTE

In this Recommendation, the expression "Administration" is used for conciseness to indicate both a telecommunication administration and a recognized operating agency.

INTELLECTUAL PROPERTY RIGHTS

The ITU draws attention to the possibility that the practice or implementation of this Recommendation may involve the use of a claimed Intellectual Property Right. The ITU takes no position concerning the evidence, validity or applicability of claimed Intellectual Property Rights, whether asserted by ITU members or others outside of the Recommendation development process.

As of the date of approval of this Recommendation, the ITU had/had not received notice of intellectual property, protected by patents, which may be required to implement this Recommendation. However, implementors are cautioned that this may not represent the latest information and are therefore strongly urged to consult the TSB patent database.

© ITU 1997

All rights reserved. No part of this publication may be reproduced or utilized in any form or by any means, electronic or mechanical, including photocopying and microfilm, without permission in writing from the ITU.

Superseded by a more recent version

CONTENTS

	Page
1 Scope.....	1
2 References.....	1
3 Terminology.....	2
4 Abbreviations.....	2
5 Applications	3
5.1 Power (booster) amplifier	4
5.2 Pre-amplifier	4
5.3 Line amplifier	4
5.4 Optically amplified transmitter.....	5
5.5 Optically amplified receiver	5
5.6 Single-channel applications	5
5.7 Multi-channel applications	5
5.8 Point-to-point applications.....	6
5.9 Point-to-multipoint applications	6
6 Operation, administration and maintenance aspects.....	6
7 Parameter values and ranges for OFA devices	6
7.1 Power (booster) amplifier	6
7.1.1 Point-to-point.....	6
7.1.2 Point-to-multipoint	7
7.2 Pre-amplifier	7
7.2.1 Point-to-point.....	7
7.3 Line amplifier	7
7.3.1 Point-to-point.....	7
7.3.2 Point-to-multipoint	7
8 Parameter values and ranges for OFA related aspects of OFA sub-systems.....	8
8.1 Optically amplified transmitter.....	8
8.2 Optically amplified receiver	8
9 Environmental conditions.....	8
10 Optical safety aspects	8
Appendix I – Parameter values and ranges for OFA devices in single-channel point-to-point systems.....	8
I.1 Power (booster) amplifier	8

Superseded by a more recent version

	Page
I.2 Pre-amplifier	9
Appendix II – Transmission-related aspects	9
II.1 Purpose.....	9
II.2 Factors influencing the OFA transmission applications	10
II.3 Optical non-linearities	10
II.3.1 Stimulated Brillouin scattering.....	11
II.3.2 Four-wave mixing.....	12
II.3.3 Modulation instability	15
II.3.4 Self phase modulation	16
II.3.5 Soliton formation.....	17
II.3.6 Cross phase modulation.....	18
II.3.7 Stimulated Raman scattering	18
II.3.8 Fibre non-linearity summary	19
II.4 Polarization properties	19
II.4.1 Polarization mode dispersion	19
II.4.2 Polarization dependent loss	22
II.4.3 Polarization hole burning	23
II.5 Dispersion properties	24
II.5.1 Chromatic dispersion.....	24
II.6 Other OFA-related properties	25
II.6.1 Noise accumulation	25
II.6.2 Self-filtering effect	26
II.6.3 Optical surge generation.....	27
Appendix III – Pre-amplifier parameters	29
Appendix IV – OAM aspects of OFAs	31
IV.1 OFA sub-systems.....	31
IV.2 OFA devices	31

Superseded by a more recent version

Recommendation G.663

APPLICATION RELATED ASPECTS OF OPTICAL FIBRE AMPLIFIER DEVICES AND SUB-SYSTEMS¹

(Geneva, 1996)

1 Scope

This Recommendation covers application related aspects of Optical Fibre Amplifiers (OFA) devices and sub-systems, primarily used in digital systems and is valid only for systems operating in the 1550 nm region. Generic characteristics of OFA devices and sub-systems are described in Recommendation G.662. Applications include both single-channel and multi-channel systems used in point-to-point and point-to-multipoint configurations for use in long-distance networks and optical access networks.

The purpose of this Recommendation is to identify which aspects should be considered for each application and to specify common parameter values and ranges for each type of OFA device (booster amplifier, pre-amplifier, and line amplifier). This Recommendation pertains to the development of new equipment including OFA devices and includes guidelines to apply OFA devices and OFA sub-systems to existing equipment. As an objective, for systems specified as transversely compatible, the degree of compatibility should not be changed by the use of OFA devices.

Important topics contained in this Recommendation include transmission aspects, maintenance aspects, and optical safety.

2 References

The following ITU-T Recommendations and other references contain provisions which, through reference in this text, constitute provisions of this Recommendation. At the time of publication, the editions indicated were valid. All Recommendations and other references are subject to revision; all users of this Recommendation are therefore encouraged to investigate the possibility of applying the most recent edition of the Recommendations and other references listed below. A list of the currently valid ITU-T Recommendations is regularly published.

- ITU-T Recommendation G.650 (1997), *Definition and test methods for the relevant parameters of single-mode fibres.*
- ITU-T Recommendation G.652 (1997), *Characteristics of a single-mode optical fibre cable.*
- ITU-T Recommendation G.653 (1997), *Characteristics of a dispersion-shifted single-mode optical fibre cable.*
- ITU-T Recommendation G.655 (1996), *Characteristics of a non-zero dispersion single-mode optical fibre cable.*

¹ This Recommendation will constitute part of a series of Recommendations on optical networking, as follows:

Components and sub-systems	G.660 and G.670-Series
Functional characteristics	G.680-Series
Physical layer aspects	G.690-Series

Superseded by a more recent version

- ITU-T Recommendation G.661 (1996), *Definition and test methods for the relevant generic parameters of optical fibre amplifiers.*
- ITU-T Recommendation G.662 (1995), *Generic characteristics of optical fibre amplifier devices and sub-systems.*
- ITU-T Recommendation G.671 (1996), *Transmission characteristics of passive optical components.*
- ITU-T Recommendation G.681 (1996), *Functional characteristics of interoffice and long-haul line systems using optical amplifiers, including optical multiplexers.*
- ITU-T Recommendation G.783 (1997), *Characteristics of Synchronous Digital Hierarchy (SDH) equipment.*
- ITU-T Recommendation G.955 (1996), *Digital line systems based on the 1544 kbit/s and the 2048 kbit/s hierarchy on optical fibre cables.*
- ITU-T Recommendation G.957 (1995), *Optical interfaces for equipments and systems relating to the synchronous digital hierarchy.*
- ITU-T Recommendation G.958 (1994), *Digital line systems based on the synchronous digital hierarchy for use on optical fibre cables.*
- IEC 721-3:1984, *Classification of groups of environmental parameters and their severities.*
- IEC 825-1:1993, *Safety of laser products – Part 1: Equipment classification, requirements and user's guide.*
- IEC 825-2:1993, *Safety of laser products – Part 2: Safety of optical fibre communication systems.*

3 Terminology

For the purposes of this Recommendation, the definitions given in Recommendations G.661 and G.662 apply.

4 Abbreviations

This Recommendation uses the following abbreviations:

AM	Amplitude Modulation
ASE	Amplified Spontaneous Emission
BA	Booster (power) Amplifier
BER	Bit-Error Ratio
CD	Chromatic Dispersion
CMC	Coherent Multi-channel
CW	Continuous Wave
DA	Dispersion Accommodation
EDFA	Erbium-Doped Fibre Amplifier
FDM	Frequency-Division Multiplexing
FWHM	Full Width at Half Maximum
FWM	Four-Wave Mixing

Superseded by a more recent version

LA	Line Amplifier
LOS	Loss of Signal
MI	Modulation Instability
OAM	Operation, Administration and Maintenance
OAN	Optically Amplified Networks
OAR	Optically Amplified Receiver
OAT	Optically Amplified Transmitter
OFA	Optical Fibre Amplifier
OFDM	Optical Frequency Domain Multiplexing
ORL	Optical Return Loss
PA	Pre-Amplifier
PM	Phase Modulation
PDH	Plesiochronous Digital Hierarchy
PDL	Polarization Dependent Loss
PHB	Polarization Hole Burning
PMD	Polarization Mode Dispersion
PSK	Phase Shift Keying
SBS	Stimulated Brillouin Scattering
SDH	Synchronous Digital Hierarchy
SMF	Single-Mode Fibre
SNR	Signal-to-Noise Ratio
SPM	Self Phase Modulation
SRS	Stimulated Raman Scattering
TRE	Terminal Receiver Equipment
WDM	Wavelength Division Multiplexing
XPM	Cross Phase Modulation

5 Applications

Application of OFAs in optical transmission systems offers a number of advantages. Chief among these advantages is the ability to realize very significant unrepeated system lengths, as well as very long unregenerated system lengths. Deployment of OFAs is likely to permit the retirement of many existing conventional regenerator sites and, in the case of new routes, to render unnecessary the construction of many new sites. OFAs also enable serious consideration of new optical system architectures for application in terrestrial and submarine long haul, and access networks. Two examples of this are wavelength division multiplexing and point-to-multipoint applications, approaches heretofore generally considered prohibitively complex and expensive. OFAs also offer potential advantages with respect to network upgrade options due to their independence from modulation format and bit rate.

However, the application of OFAs also brings to light some new and potentially serious system impairments, which result from the high power levels produced by the OFAs and the long distances between regeneration. These transmission effects include optical fibre non-linearities, polarization effects and effects due to the amplification characteristics of the OFA itself. Chromatic dispersion

Superseded by a more recent version

also becomes increasingly significant for the long unregenerated systems enabled by the OFA. In addition to determining chromatic dispersion limitations, the dispersion characteristics of the fibre influence the severity of the impairment produced by several of the dominant non-linear effects. As a result, dispersion management has emerged as a critical consideration in system design. In the following subclauses, the OFA applications are described and important considerations for each application are identified.

If the characteristics are longitudinally compatible, the OFA devices specified in this Recommendation can also be used to increase the distance in G.955 Plesiochronous Digital Hierarchy (PDH) optical line systems (which are not transversely compatible). To ensure transverse compatibility between OFA devices and Synchronous Digital Hierarchy (SDH) equipments and to satisfy the requirements of G.690-Series Recommendations, either G.957 equipment in accordance with 6.1/G.957 and 6.22/G.957 or a transponder(s) may be used.

5.1 Power (booster) amplifier

The power (booster) amplifier (BA) is a high saturation-power OFA device to be used directly after the optical transmitter to increase its signal power level. The BA does not need stringent requirements for noise and optical filtering. The Operation, Administration and Maintenance (OAM) functions for the BA may or may not be shared with the optical transmitter.

The application of BAs (often in conjunction with pre-amplifiers) is very attractive, especially in those cases where intermediate locations with active equipment are either undesirable or inaccessible, as in submarine systems. In any case, fewer intermediate locations implies easier maintenance for the network operator. The most direct and simple means to increase the available power budget is to use either a BA directly after the regular transmitter or an optically amplified transmitter (see 5.4).

Because of the relatively high level of output power, the undesirable Amplified Spontaneous Emission (ASE) noise, inherently present due to the statistical process of photon generation inside the OFA, is usually negligible. However, application of BAs may result in fibre non-linearity induced system penalties due to the high optical power levels produced by BAs and the long interactive lengths provided by the optical path.

5.2 Pre-amplifier

The Pre-Amplifier (PA) is a very low noise OFA device to be used directly before an optical receiver to improve its sensitivity. The requisite low level of ASE noise may be achieved through the use of narrow-band optical filters. In this case, automatic tuning of the centre wavelength of the pre-amplifier filter to the transmitter wavelength would be advantageous, since it would permit the relaxation of requirements on both the initial transmitter wavelength tolerance and its long-term stability. As noted previously, the use of PAs (usually in conjunction with BAs) is a straightforward means to realize significant increases in available power budget. The OAM function for PAs may or may not be shared with the optical receiver. In STM-64 or higher level systems, the use of a PA-only configuration can be useful (e.g. to avoid potential problems due to fibre non-linearities).

5.3 Line amplifier

The Line Amplifier (LA) is a low-noise OFA device to be used between passive fibre sections to increase the regeneration lengths or in correspondence of a multipoint connection to compensate for branching losses in the optical access network. As noted previously, line amplifiers might replace some or all conventional regenerators in long-haul fibre sections. It can be envisioned that more than one conventional regenerator can be replaced by a single LA, with the evident advantage of reduced equipment in transmission links. Furthermore, a situation can be envisaged where both line

Superseded by a more recent version

amplifiers for compensation of signal attenuation, and conventional regenerators for compensation of signal distortion, appear in long-distance networks.

A separate communication channel must exist in systems using LAs, which would allow alarming, supervision and control of the installed remote LAs. Such a supervisory channel should not place restrictions on the selection of pump laser wavelength or operating window. Because each LA must be able to insert its own status and alarm information, the supervisory channel must be recovered, regenerated (with new information inserted) and retransmitted at each LA.

Theoretically, ultra-long (thousands of kilometres) transmission distances can be realized by periodically inserting line amplifiers in the optical path. However, in the case where many OFAs are cascaded, deteriorated system performance can occur due to noise accumulation, spectral dependency of total gain, effects of polarization and chromatic dispersion and non-linear effects. Laboratory tests have shown that the overall system behaviour in the case of many cascaded line amplifiers is much more complex than that for the case of a few cascaded line amplifiers. In particular, the total gain of a chain of line amplifiers in series is generally peaked around a specific wavelength, depending on the specific amplifier configuration, giving considerable reduction of the usable OFA operating wavelength range. Therefore, design of this type of system will be very much different from the situation with only a few cascaded line amplifiers.

5.4 Optically amplified transmitter

The Optically Amplified Transmitter (OAT) is an OFA sub-system in which a power amplifier is integrated with the laser transmitter, resulting in a high-power transmitter. The connection between the transmitter and the OFA is proprietary and shall not be specified. The application considerations of OATs are generally the same as those for BAs (see 5.1).

5.5 Optically amplified receiver

The Optically Amplified Receiver (OAR) is an OFA sub-system in which a pre-amplifier is integrated with the optical receiver, resulting in a high sensitivity receiver. The connection between the receiver and the OFA is proprietary and shall not be specified. The application considerations of OARs are generally the same as those for PAs (see 5.2)

5.6 Single-channel applications

BAs, PAs, LAs, OATs and OARs may all find application in single-channel systems. In the case of single-channel transmission, noise accumulation can be reduced by using low noise OFAs in combination with adequate band pass optical filtering. The dispersion limitations can be normally minimized by operating close to the fibre zero dispersion wavelength or by using suitable Dispersion Accommodation (DA) techniques. Furthermore, care must be taken to keep non-linear effects, like stimulated Brillouin scattering (see II.3.1) and self phase modulation (see II.3.4), under control.

The main optical path interface parameter values for point-to-point, single-channel, long-haul Synchronous Digital Hierarchy (SDH) systems utilizing OFAs are described in G.690-Series Recommendations. The reference configurations and functional characteristics of these systems are described in Recommendation G.681.

5.7 Multi-channel applications

OFAs will also find application in multi-channel systems. In addition to the transmission impairments found in single-channel systems, multi-channel systems may also suffer degraded performance due to certain non-linear effects. These include Four-Wave Mixing (FWM), Cross Phase Modulation (XPM) and potentially Stimulated Raman Scattering (SRS). As a result, special

Superseded by a more recent version

precautions must be taken when designing multi-channel systems to avoid or alleviate these impairments. In multi-channel systems using a series of LAs to provide long unregenerated lengths, the effects of cascaded amplifiers, especially the reduction of the usable gain spectrum, must also be considered.

The optical interface parameter values for point-to-point, multi-channel, long-haul SDH systems utilizing OFAs are described in G.690-Series Recommendations. The reference configurations and functional characteristics of these systems are described in Recommendation G.681.

5.8 Point-to-point applications

Schemes of insertion of OFA devices and sub-systems in point-to-point applications are indicated in Recommendation G.662 (see in particular, Figures 1/G.662, 2/G.662 and 3/G.662).

5.9 Point-to-multipoint applications

OFAs can be used in Optically Amplified Networks (OANs) to increase the optical power budget or to allow for higher splitting ratios in point-to-multipoint networks. Therefore, generally speaking, both power and line amplifiers will be used in these types of networks. The use of OFAs in ring networks just before branching devices, in order to compensate for splitting/branching losses, is an example of a potential application.

NOTE – One of the first applications of the OFAs may be for the distribution of video signals. At the beginning, these systems will probably be analogue but they will gradually change into digital systems. In the case of analogue video systems, additional requirements compared to the ones of the OFAs for digital applications, are necessary in order to maintain adequate carrier-to-noise ratio and avoid signal distortion. If AM modulated lasers are used, for instance, the OFA gain must be very flat, in order to avoid frequency to intensity modulation conversions, leading to increased signal distortions. This effect can be minimized when using Continuous Wave (CW) operated lasers in combination with external modulators. In this way polarization effects could be minimized too. Also, special care must be taken to keep OFAs output power at acceptable levels in order to reduce non-linear effects like SBS.

6 Operation, administration and maintenance aspects

Certain considerations on Operation, Administration and Maintenance (OAM) aspects of OFAs are given in Appendix IV.

7 Parameter values and ranges for OFA devices

In this clause, parameter values of OFA devices (BA, PA, LA) are provided, according to the lists given in clauses 7/G.662, 8/G.662 and 9/G.662, with the aim of ensuring, as far as possible, optical transverse compatibility amongst OFA sub-systems and OFA devices in point-to-point system configurations.

7.1 Power (booster) amplifier

7.1.1 Point-to-point

The output parameters for power amplifiers are system-specific and are specified in the relevant system Recommendations (G.690-Series). Some example input parameter values for power amplifiers can be found in Appendix I. The output parameters for power amplifiers, as described by the interfaces in the relevant system Recommendations, are assumed to be applicable for PDH systems as well.

Superseded by a more recent version

7.1.1.1 Single-channel systems

Some example input parameter values for power amplifiers can be found in Appendix I. Output parameter values are specified in G.690-Series Recommendations.

7.1.1.2 Multi-channel systems

Input parameter values for power amplifiers to be used in digital multi-channel systems are for further study. Output parameter values are specified in G.690-Series Recommendations.

7.1.2 Point-to-multipoint

Because applications in point-to-multipoint architectures requiring power amplifiers are more likely to be analogue in nature, the associated parameter values are for further study.

7.2 Pre-amplifier

7.2.1 Point-to-point

The input parameters for pre-amplifiers are system-specific and are specified in the relevant system G.690-Series Recommendations. Some example output parameter values for pre-amplifiers can be found in Appendix I. The input parameters for pre-amplifiers, as described by the interfaces in the relevant system Recommendations, are assumed to be applicable for PDH systems as well.

7.2.1.1 Single-channel systems

Some example output parameter values for pre-amplifiers can be found in Appendix I. Input parameter values are specified in G.690-Series Recommendations.

7.2.1.2 Multi-channel systems

Output parameter values for pre-amplifiers to be used in digital multi-channel systems are for further study. Input parameter values are specified in G.690-Series Recommendations.

7.3 Line amplifier

7.3.1 Point-to-point

7.3.1.1 Single-channel systems

Specific parameter values for line amplifiers in point-to-point single-channel systems are specified in G.690-Series Recommendations.

7.3.1.2 Multi-channel systems

Specific parameter values for line amplifiers in point-to-point multi-channel systems are specified in G.690-Series Recommendations.

7.3.2 Point-to-multipoint

Because applications in point-to-multipoint architectures requiring line amplifiers are more likely to be analogue in nature, the associated parameter values are for further study.

Superseded by a more recent version

8 Parameter values and ranges for OFA related aspects of OFA sub-systems

8.1 Optically amplified transmitter

Parameter values for optically amplified transmitters for single-channel and multi-channel systems are specified in G.690-Series Recommendations.

8.2 Optically amplified receiver

Parameter values for optically amplified receivers for single-channel and multi-channel systems are specified in G.690-Series Recommendations.

9 Environmental conditions

Various classes of environmental conditions are specified in IEC 721-3-0 (1984) and Amendment 1 (1987). Further details can be found in IEC 721-3-1 (1987), Amendment 1 (1991) and Amendment 2 (1993) for storage; IEC 721-3-2 (1985), Amendment 1 (1991) and Amendment 2 (1993) for transportation; IEC 721-3-3 (1994) for stationary use, weather protected; and IEC 721-3-4 (1995) for stationary use, non-weather protected.

10 Optical safety aspects

Under certain condition (fibre break, open connectors), the optical output power of an OFA may become accessible and may be hazardous to the human eye. Under IEC 825-1, the inherently safe Class 1 power limits are 8.8 mW (+9.4 dBm) for the 1310 nm band and 10 mW (+10 dBm) for the 1550 nm band, while the limited safe Class 3 A levels (safe unless viewing aids are used) are 24 mW (+13.8 dBm) for the 1310 nm band and 50 mW (+17 dBm) for the 1550 nm band respectively. Special precautions and requirements for installation and use of optical systems (including amplifiers) and a description of viewing aids are given in IEC 825-2.

Due to the high level of optical power involved, mainly in booster amplifiers and OATs, optical safety and optical surge generation issues (i.e. protection of personnel and equipment) are of primary relevance in line systems using OFA devices and sub-systems.

An appropriate procedure for shut-down and restart of OFAs is given in Recommendation G.681.

APPENDIX I

Parameter values and ranges for OFA devices in single-channel point-to-point systems

In this appendix, example parameter values for OFA devices (BA and PA) are shown for single-channel point-to-point systems. These parameter values are according to the lists given in clauses 7/G.662, 8/G.662 and 9/G.662 and were developed to ensure as far as possible compatibility with parameter values specified in Recommendation G.957.

As indicated in clause 7, optical interface specifications for the main optical path are provided by G.690-Series Recommendations.

I.1 Power (booster) amplifier

The parameter values given in Table I.1 are examples of a minimum list of relevant input parameters (as given in Recommendation G.662) for power amplifiers in point-to-point single-channel systems.

Superseded by a more recent version

Only the input parameters have been included in the table, since the output parameters are system-specific and are specified in G.690-Series Recommendations.

Table I.1/G.663 – Input parameters for power amplifiers in single-channel systems

Parameter	Unit	Value
Input power range	dBm	-6/+3
Reverse ASE power level	dBm	≤ -20
Input Optical Return Loss (ORL)	dB	≥ 27
Pump leakage	dBm	≤ -15 ^{a)}
Maximum ORL tolerable at input	dB	27
Power wavelength band	nm	1530-1565
^{a)} The measured value of -15 dBm (max) takes into account all of the contributions coming from the power distribution around the peak value down to 30 dB below the peak value itself.		

I.2 Pre-amplifier

The parameter values given in Table I.2 are examples of a minimum list of relevant output parameters (as given in Recommendation G.662) for pre-amplifiers in point-to-point single-channel systems. Only the output parameters have been included in the table, since the input parameters are system-specific and are specified in G.690-Series Recommendations.

Table I.2/G.663 – Output parameters for pre-amplifier in single-channel systems

Parameter	Unit	Value
Output power range	dBm	-16/-9
Small signal gain	dB	≥ 20
Noise figure	dB	under study
Maximum ORL tolerable at output	dB	27
Maximum total output power ^{a)}	dBm	-9
Wavelength bandwidth	nm	1530-1565
^{a)} This parameter is evaluated in the available signal wavelength band, when an optical filter is used inside the OFA.		

APPENDIX II

Transmission-related aspects

II.1 Purpose

OFAs permit the consideration of new optical transmission system architectures by providing very high optical power levels and allowing much longer distances between regenerators. As a result, new transmission effects and limitations have emerged which must now be considered. These include optical non-linearities such as stimulated Brillouin scattering, four-wave mixing and self phase modulation and dispersion properties such as polarization mode dispersion. In addition,

Superseded by a more recent version

characteristics of the OFA can also contribute to system impairments. Many approaches for solving transmission-related problems have been investigated. However, the technologies differ in their performance and application.

In order to design economical and reliable OFA-supported systems following the ITU-T Recommendations on optical interface parameters, it is important that both operators and equipment vendors share a common understanding regarding OFA-related problems and their remedy. To that end, this subclause seeks to do the following:

- Describe the transmission effects induced by optical non-linearities, polarization and chromatic dispersion properties, and other OFA-related properties in OFA-supported transmission systems.
- Identify the limitations due to the mentioned effects in the various types of relevant transmission systems (e.g. digital/analogue, coherent, wavelength division multiplexing, etc.).
- Indicate possible remedies to these impairments, together with the corresponding field of effectiveness.

II.2 Factors influencing the OFA transmission applications

The factors influencing the OFA transmission applications can be divided into four general categories: optical non-linearities, polarization properties, dispersion properties, and other OFA-related properties. The factors dealt with in each category are given below and their effects are described in the following subclauses:

- a) *Optical non-linearities*
 - 1) stimulated Brillouin scattering;
 - 2) four-wave mixing;
 - 3) modulation instability;
 - 4) self phase modulation;
 - 5) soliton formation;
 - 6) cross phase modulation;
 - 7) stimulated Raman scattering.
- b) *Polarization properties*
 - 1) polarization mode dispersion;
 - 2) polarization dependent loss;
 - 3) polarization hole burning.
- c) *Dispersion properties*
 - chromatic dispersion.
- d) *Other OFA-related properties*
 - 1) noise accumulation;
 - 2) self filtering effect;
 - 3) optical surge generation.

II.3 Optical non-linearities

Non-linear interactions between the signal and the silica fibre transmission medium begin to appear as optical signal powers are increased to achieve longer span lengths at high bit rates. Consequently,

Superseded by a more recent version

non-linear fibre behaviour has emerged as an important consideration both in high capacity systems and in long unregenerated routes. These non-linearities can be generally categorized as either scattering effects (stimulated Brillouin scattering and stimulated Raman scattering) or effects related to the Kerr effect, that is, the intensity dependence of the refractive index (self phase modulation, cross phase modulation, modulation instability, soliton formation and four-wave mixing). A variety of parameters influence the severity of these non-linear effects, including fibre dispersion characteristics, the effective core area of the fibre, the number and spacing of channels in multiple channel systems, overall unregenerated system length, as well as signal intensity and source linewidth.

II.3.1 Stimulated Brillouin scattering

II.3.1.1 Description of the effects

In an intensity-modulated system using a source with a narrow linewidth, significant optical power is transferred from the forward-propagating signal to a backward-propagating signal when the Stimulated Brillouin Scattering (SBS) threshold is exceeded. In SBS, the forward-propagating light is scattered from acoustic phonons. However, only the backward-propagating scattered light is guided by the single-mode fibre. The scattered light is downshifted or Brillouin-shifted by approximately 11 GHz at 1550 nm.

Of the non-linear effects described here, SBS has the lowest threshold power. While studies have shown that the SBS threshold can vary between fibre types and even among individual fibres, it is typically on the order of 5 to 10 mW for externally modulated, narrow linewidth sources, but may be 20 to 30 mW for directly modulated lasers. The SBS threshold for a system deployed on Recommendation G.653 fibre is slightly lower than that for a system using Recommendation G.652 fibre, due to the smaller effective area of Recommendation G.653 fibre. This is generally true for all of the non-linear effects. The SBS threshold is sensitive to the source linewidth and power level. It is independent of the number of channels.

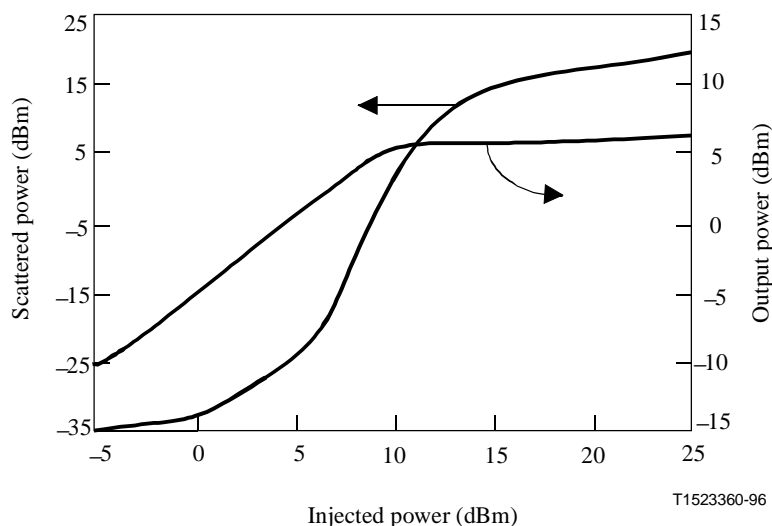

Figure II.3-1/G.663 – Stimulated Brillouin scattering threshold for narrow-band source

II.3.1.2 Induced transmission limitations

SBS effectively limits the amount of light that can be transmitted through a fibre path. Figure II.3-1 shows this effect for a narrow-band source, where all of the signal power falls within the Brillouin

Superseded by a more recent version

bandwidth (see Figure II.3-1). The transmitted power becomes saturated and the backscattered power rapidly increases. The input power level to the fibre at which this rapid increase occurs is defined as the SBS threshold. In the general case, the SBS threshold is expressed as:

$$P_{th} = 21 \frac{KA_{eff}}{gL_{eff}} \cdot \frac{\Delta\nu_p + \Delta\nu_B}{\Delta\nu_B}$$

where g denotes the Brillouin gain coefficient, and A_{eff} is the effective core area. K is a constant determined by the degree of freedom of the polarization state (in Recommendation G.652 fibres, $K=2$). $\Delta\nu_B$ and $\Delta\nu_p$ represent the Brillouin bandwidth and a linewidth of a pump light, respectively. L_{eff} denotes the effective length defined as:

$$L_{eff} = \frac{1 - \exp(-\alpha L)}{\alpha}$$

where α is the fibre attenuation coefficient and L is the fibre length.

The SBS threshold, P_{th} , depends on the linewidth of pump light, $\Delta\nu_p$. When the linewidth of the pump light is small compared to the Brillouin bandwidth, the SBS threshold power can be estimated using the following relation:

$$P_{th} = 21 \frac{KA_{eff}}{gL_{eff}}$$

II.3.1.3 Minimization of the induced limitations

Stimulated Brillouin scattering impairments will not arise in systems where the source linewidth significantly exceeds the Brillouin bandwidth or where the signal power is below the threshold power (calculated from expressions in II.3.1.2).

NOTE – Further information concerning SBS can be found in the Appendix III/G.650.

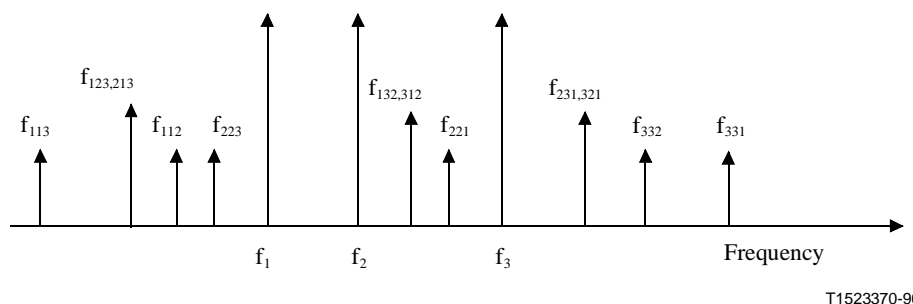

Figure II.3-2/G.663 – Mixing products generated due to four-wave-mixing of three signals

II.3.2 Four-wave mixing

II.3.2.1 Description of the effects

Four-Wave Mixing (FWM), also called four-photon mixing, occurs when the interaction of two or three optical waves at different wavelengths generates new optical waves, called mixing products or sidebands, at other wavelengths. This interaction can occur between signals in multiple-channel systems, between OFA ASE noise and a single channel, as well as between the main mode and side modes of a single channel. In the case of two signals, the intensity modulation at their beat frequency modulates the fibre refractive index and produces a phase modulation at a difference frequency. The

Superseded by a more recent version

phase modulation creates two sidebands at frequencies given by this difference. In the case of three signals, more and stronger mixing products are produced (see Figure II.3-2) which will fall directly on adjacent signal channels when the channel spacings are equal in frequency. Two optical waves propagating along a fibre produce FWM with high efficiency if the phase matching condition is achieved between sidebands and initial signals. For relatively low optical powers that means:

$$2\pi\Delta\nu^2 D\lambda_t^2 L / c \ll 1$$

where $\Delta\nu$ is the frequency spacing among the wavelengths, D is the chromatic dispersion of the fibre, λ_t is the central wavelength, L is the fibre length and c is the speed of light in vacuum (losses can be taken into account by slightly modifying the equation above). The efficiency of FWM is also sensitive to overall optical power in the fibre. Indeed, for two waves with optical power P_1 and P_2 , the maximum parametric gain coefficient for the sidebands, g_{\max} , can be estimated to be:

$$g_{\max} \approx 2g(P_1 + P_2)$$

where g is the non-linear Kerr coefficient.

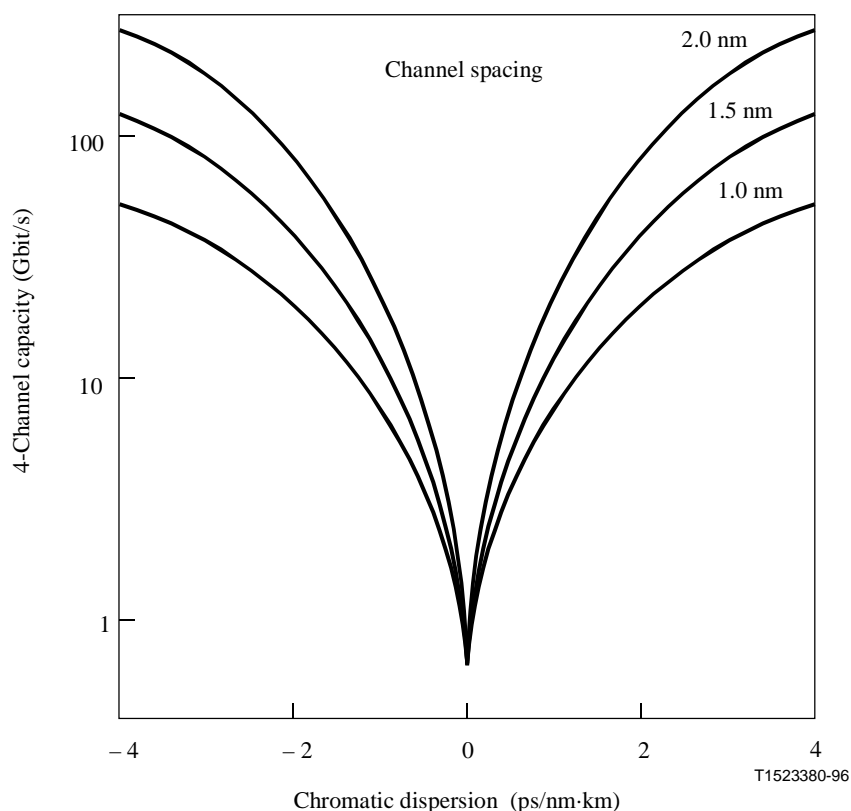

Figure II.3-3/G.663 –Impact of dispersion on system capacity

II.3.2.2 Induced transmission limitations

The generation of FWM sidebands can result in significant depletion of the signal power. Furthermore, when the mixing products fall directly on signal channels, they cause parametric interference which manifests as amplitude gain or loss in the signal pulse, depending on the phase interaction of the signal and sideband.

Parametric loss causes closure of the eye pattern at the receiver output, thereby degrading Bit-Error Rate (BER) performance. Frequency spacing and chromatic dispersion reduce the efficiency of the FWM process by destroying the phase matching between the interacting waves. Systems deployed

Superseded by a more recent version

over Recommendation G.652 fibre experience less FWM impairment compared to systems deployed over Recommendation G.653 fibre. Conversely, the placement of a signal channel directly at or near the dispersion zero can result in a very significant buildup of FWM products over a relatively short fibre length (i.e. 10s of km). FWM is also sensitive to channel separation.

Four-wave mixing can create a serious system impairment in multiple wavelength systems on Recommendation G.653 fibre, since the signal channels experience only a small value of chromatic dispersion. The impact of dispersion on achievable system capacity for a four-channel system over three amplifier spans is shown in Figure II.3-3. This illustrates what can happen at high power levels when conditions promote the generation of mixing products. The capacity limitation is based on a worst-case calculation of the mixing products generated by the FWM process with four 8 dBm signal channels centred around the dispersion value shown. This system develops intolerable levels of distortion due to FWM as the dispersion experienced by the signal channels approaches zero.

In single-channel systems, the FWM interaction can occur between OFA ASE noise and the transmission channel, as well as between the main mode and the side modes of the optical transmitter. Phase noise is added to the signal carrier due to the accumulated ASE via the fibre Kerr effect, thus broadening the signal spectral tails.

II.3.2.3 Minimization of the induced limitations

As previously noted, dispersion, such as that in Recommendation G.655 fibres, may be used to suppress the generation of the FWM sidebands. Uneven channel spacing may also be incorporated to mitigate the severity of the FWM impairment. Reduction of the input power levels in Recommendation G.653 fibre systems could permit multiple channel operation, but might compromise the economic advantages of optical amplification.

In order to adequately suppress the generation of mixing products, use of a fibre [covered by either existing or new Recommendations under study] with a minimum permitted (i.e. non-zero) dispersion within the region of the OFA amplification band has been proposed. Alternating spans of such non-zero dispersion fibre with opposite dispersion characteristics has also been considered as a potential option, since the resultant cable would maintain a net chromatic dispersion of approximately zero. However, this alternative may present difficulties in the areas of installation, operations and maintenance by introducing a second fibre type into the outside plant environment. Similar approaches using long spans of fibre with small finite dispersion and short lengths of opposite and higher dispersion fibre (to provide compensation) have also been demonstrated. In particular, in links with periodical amplification, a short piece of compensating fibre can be located inside the box in which the optical amplifier is located.

Uneven channel spacing and larger channel spacing have been proposed as means to mitigate the effects of non-linearities and allow deployment of dense WDM systems on Recommendation G.653 fibre. Uneven channel spacing ensures that mixing products generated by three or more channels do not fall directly on other channel wavelengths. However, the transfer of power from the signals into the mixing products (i.e. signal depletion) remains unaffected by making the channel spacing uneven and may still cause significant eye closure. Increased channel spacing also reduces the effects of four-wave mixing. Use of these mitigation techniques may be constrained by the effects of gain narrowing due to the concatenation of optical amplifiers, which reduces the width of the usable amplification spectrum.

Superseded by a more recent version

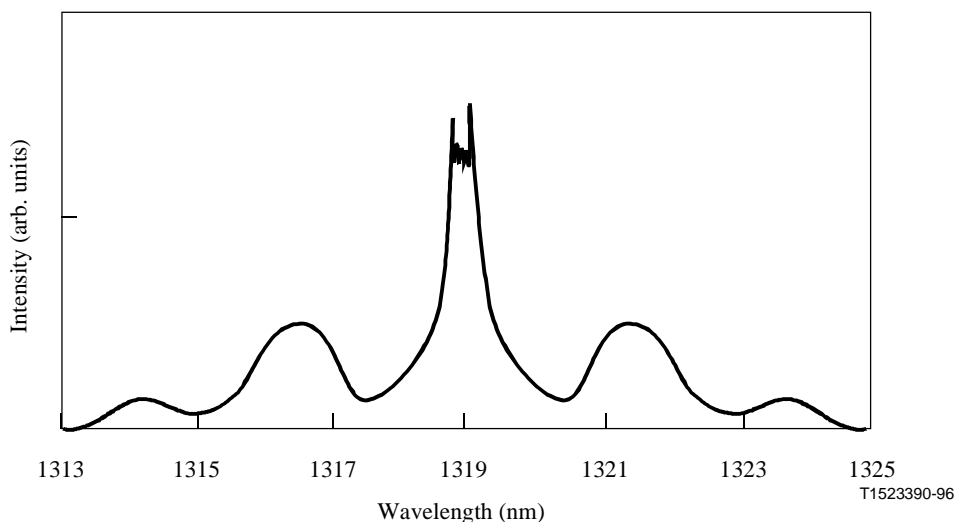

Figure II.3-4/G.663 – Power spectrum of a pulse after propagation in 1 km-long fibre (input pulse width: 100 ps, peak power: 7 W). Spectral side lobes appeared due MI

II.3.3 Modulation instability

II.3.3.1 Description of the effects

Modulation Instability (MI) breaks a CW signal or a pulse into a modulated structure. It can be observed in the anomalous dispersion regime (i.e. above the zero-dispersion wavelength), where a quasi-monochromatic signal spontaneously tends to generate two symmetric spectral sidebands, as shown in Figure II.3-4. Frequency separation and gain of the sidebands are determined by the intensity of the wave and by dispersion and non-linear coefficients of the fibre. The maximum conversion efficiency occurs at a frequency separation given by:

$$\Omega_{\max} = \pm \left[\frac{8\pi^2 c n_2 P_o}{\lambda^3 A_{\text{eff}} D(\lambda)} \right]^{1/2}$$

where n_2 is the silica non-linear coefficient, A_{eff} is the effective area of the fibre, P_o is the launched power, $D(\lambda)$ is the chromatic dispersion coefficient and λ is the operation wavelength; sidebands located at $\pm\Omega_{\max}$ from the carrier experience a gain per unit length: $g_{\max} = 4\pi P_o / (\lambda A_{\text{eff}})$. Fibre loss can be taken into account by slightly modifying the equations above. Dependence of MI gain on the frequency deviation with respect to the signal is given in Figure II.3-5 in presence of fibre loss and for various values of fibre dispersion.

The MI can be viewed as particular case of FWM where two photons of the intense incoming signal are converted into two photons at two different frequencies.

Superseded by a more recent version

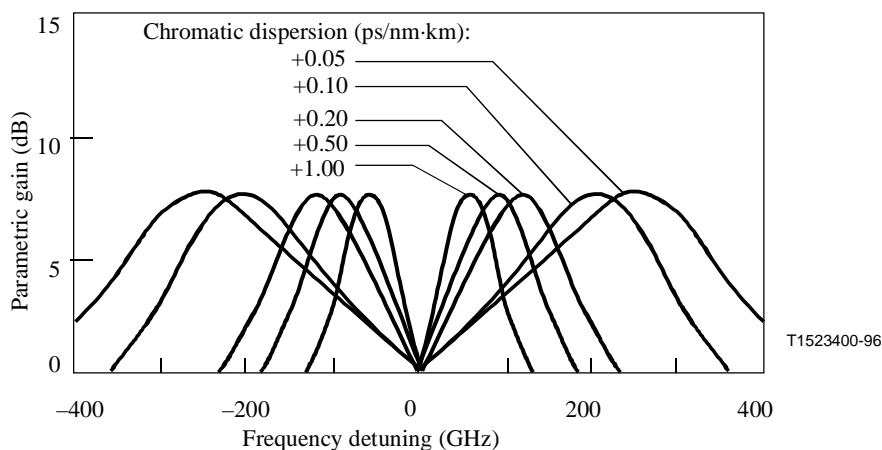

Figure II.3-5/G.663 – Calculated MI gain versus frequency detuning, from 30 km long fibres (0.24 dB/km loss) with five different dispersion coefficient values, for +16 dBm CW signal launched power

II.3.3.2 Induced transmission limitations

Modulation instability may decrease the Signal-to-Noise Ratio (SNR) due to generation of sidebands either spontaneously or seeded by the amplifier spontaneous emission. As the maximum degradation of the signal is expected for high values of g_{\max} and for Ω close to the bandwidth of the signal, MI may be critical when using very powerful boosters in dispersion-shifted fibre links with directly modulated lasers. On long-distance unrepeated systems, MI can be observed at lower power levels and may cause excess amplification of the spontaneous emission noise of the cascaded OFAs. This Kerr-effect-induced broadening at signal spectral tails can cause signal-carrier depletion and the tails may be attenuated by the narrow-band ASE filters or by the self-filtering effect in very long systems.

II.3.3.3 Methods to minimize the induced limitations

The effect of MI can be minimized either by decreasing the power level or by operating at wavelengths below the zero-dispersion wavelength of the link. Dispersion managing may also be useful to reduce MI sidebands formation. Otherwise, the received signal should be electrically filtered in order to lower the level of the spurious amplified noise. External modulation of the lasers, giving narrower spectra, may decrease considerably the impact of MI.

II.3.4 Self phase modulation

II.3.4.1 Description of the effects

Because of the Kerr effect, the temporal variation of the optical intensity of the signal induces a modulation of its own phase. This effect is called Self Phase Modulation (SPM). In single wavelength systems, Self Phase Modulation will gradually broaden the signal spectrum when changes in optical intensity result in changes in phase (see Figure II.3-6). Once spectral broadening is introduced by SPM, the signal experiences a greater temporal broadening as it propagates along the length of the fibre, due to the effects of chromatic dispersion, in the normal dispersion region of the fibre (i.e. below the zero-dispersion wavelength). Conversely, in the anomalous dispersion region, the chromatic dispersion and SPM can compensate each other, giving less temporal broadening. The soliton propagation is based on this phenomenon (see II.3.5).

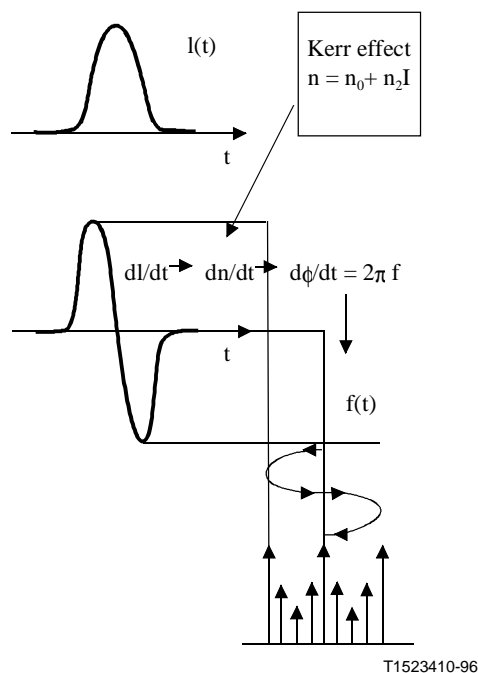

Figure II.3-6/G.663 – Spectral broadening mechanism due to self phase modulation

II.3.4.2 Induced transmission limitations

Generally, the effects of SPM are significant only in systems with high cumulative dispersion or very long systems. Systems which are dispersion-limited may not tolerate the effects due to SPM. In multiple-channel systems with very closely spaced channels, the spectral broadening induced by SPM may also create interference between adjacent channels.

SPM on low-chirp intensity-modulated signals leads to pulse compression on Recommendation G.652 fibres and on Recommendation G.655 fibres with anomalous dispersion as a function of transmitter power. The pulse compression counteracts the chromatic dispersion and offers some dispersion accommodation. However, limits of maximum dispersion and related transmission length exist.

II.3.4.3 Minimization of the induced limitations

The use of Recommendation G.653 fibre and the placement of the signal channel near the dispersion zero will reduce the impact of SPM. For systems less than approximately 1000 km, SPM may be controlled through the implementation of dispersion compensation at appropriate intervals along the length of a Recommendation G.652 fibre system. The effects of SPM may be mitigated by either minimizing the input optical power or operating at wavelengths above the zero-dispersion wavelength of Recommendation G.655 fibre.

II.3.5 Soliton formation

II.3.5.1 Description of the effects

In the anomalous dispersion region of the fibre (i.e. above the zero-dispersion wavelength), the interplay between Kerr non-linearity and chromatic dispersion may give origin to particular propagation regimes, called soliton pulses, which propagate for long distances periodically reproducing their time shape and frequency spectrum. Other kind of signals can spontaneously evolve into solitons. Although the fundamental soliton is very robust and can be used to achieve long-distance transmission, the higher order solitons undergo very complex evolution, involving

Superseded by a more recent version

pulse reshaping, spectral modifications, and also pulse breaking. These effects may be detrimental to system operation.

II.3.5.2 Induced transmission limitations

Effects due to soliton formation may be relevant both in Recommendations G.652, G.653 and G.655 fibre systems. While fundamental soliton formation can be useful, other solitons generally give rise to a strong degradation of the transmitted signal. Thus, higher order soliton formation sets a limit to the maximum power that can be launched into the fibre.

II.3.5.3 Methods to minimize the induced limitations

Soliton formation can be avoided by operating at wavelengths below the zero-dispersion wavelength of the link. However, in this regime, soliton transmission is not supported and both dispersion and non-linearity contribute to pulse broadening. Signal degradation can be minimized by proper management of the dispersion along the link.

II.3.6 Cross phase modulation

II.3.6.1 Description of the effects

In multiple wavelengths systems, Cross Phase Modulation (XPM) will gradually broaden the signal spectrum when changes in optical intensity result in changes in phase due to interactions between adjacent channels. The amount of spectral broadening introduced by XPM is related to the channel separation, since the dispersion-induced differential group velocities will cause the interacting pulses to separate as they propagate down the fibre. Once spectral broadening is introduced by XPM, the signal experiences a greater temporal broadening as it propagates along the length of the fibre due to the effects of chromatic dispersion.

II.3.6.2 Induced transmission limitations

Impairments from XPM are more significant in Recommendation G.652 fibre systems, relative to Recommendations G.653 and G.655 fibre systems. The broadening due to XPM may result in interference between adjacent channels in multiple-channel systems.

II.3.6.3 Minimization of the induced limitations

XPM can be controlled through appropriate selection of channel spacing. Studies have shown that only adjacent channels contribute significantly to XPM-induced signal distortion in multiple-channel systems. The Signal-to-Noise Ratio (SNR) of the centre channel of a three-channel system will approach that of a single-channel system as channel separation is increased. As a result, the effect of XPM can be rendered negligible with adequate spacing between the signal channels. Channel separations of 100 GHz were shown to be sufficient to reduce XPM effects in a simulation of a system with 5 mW of power/channel. Dispersion penalties due to XPM may also be controlled by the implementation of dispersion compensation at appropriate intervals along the length of the system.

II.3.7 Stimulated Raman scattering

II.3.7.1 Description of the effects

Stimulated Raman scattering is a broadband effect which involves the interaction of light and the vibrational modes of silica molecules. SRS causes a signal wavelength to behave as a Raman pump for longer wavelengths, either other signal channels or spontaneously scattered Raman-shifted light. In any case, the shorter wavelength signal is attenuated by this process, which amplifies the longer wavelength signal.

Superseded by a more recent version

II.3.7.2 Induced transmission limitations

Stimulated Raman Scattering (SRS) can occur in both single- and multiple-channel systems. Signal powers on the order of 1W or more are needed to experience impairment from this phenomenon with only a single channel without line amplifiers. However, shorter wavelength signals in multiple-channel systems with widely spaced channels can suffer degraded signal-to-noise performance when a portion of their power is transferred to longer wavelength channels through SRS. This results in total system capacity limitations based on the total number of channels, channel spacing, average input power and overall system length. In particular, the threshold for the observation of a 1 dB penalty in a multi-channel system due to Raman gain in dispersion-unshifted fibre can be estimated to be:

$$P_{tot} \cdot \Delta\lambda \cdot L_{eff} < 40mW \cdot nm \cdot Mm$$

where P_{tot} is the combined power of all of the channels, $\Delta\lambda$ is the optical spectrum over which the channels are distributed and L_{eff} is the effective length [in units of 10^6 metres (Mm)]. The SRS threshold for a system deployed on Recommendation G.653 fibre is slightly lower than that for a system using Recommendation G.652 fibre, due to the smaller effective area of Recommendation G.653 fibre. SRS does not practically degrade single-channel systems; conversely it may limit the capability of WDM systems.

II.3.7.3 Minimization of the induced limitations

In single-channel systems, filters can be used to remove the unwanted spectrum. However, no practical techniques to eliminate the effects of SRS in multiple-channel systems have been reported. The effects of SRS may also be mitigated by reducing the input optical power. However, SRS does not appear to present a practical limitation to the deployment of currently contemplated WDM systems.

II.3.8 Fibre non-linearity summary

A summary of the non-linear effects described in previous subclauses is given in Table II.1.

II.4 Polarization properties

II.4.1 Polarization mode dispersion

II.4.1.1 Description of the effects

It is well known that the fundamental mode of a circularly symmetric dielectric waveguide is doubly degenerate. In a real optical fibre this degeneracy is split by birefringence. The birefringence may be introduced deliberately, as in polarization-maintaining fibre for example, or it may be an unwanted by-product of fibre manufacture or cable manufacture. In this case the birefringence is introduced in a random way by, for example, geometrical or stress-induced perturbations.

The propagation constants, $\beta_i(\omega)$, of the two orthogonal modes can be expanded in a Taylor series around the centre frequency, ω_o ;

$$\beta_i(\omega_o) = \beta_i(\omega_o) + \left. \frac{\partial \beta_i}{\partial \omega} \right|_{\omega=\omega_o} (\omega - \omega_o) + \frac{1}{2} \left. \frac{\partial^2 \beta_i}{\partial \omega^2} \right|_{\omega=\omega_o} (\omega - \omega_o)^2 + \dots$$

where the $\beta_i(\omega_o)$ is the phase velocity v_p , $\left. \frac{\partial \beta_i}{\partial \omega} \right|_{\omega=\omega_o}$ is related to the group velocity v_g , and $\left. \frac{\partial^2 \beta_i}{\partial \omega^2} \right|_{\omega=\omega_o}$ is related to the dispersion of the group velocity (or chromatic dispersion, D) etc.

Superseded by a more recent version

With the development of dispersion-shifted fibres and the deployment of systems operating near the dispersion-zero wavelength, the contribution to the dispersion from the second order term, or chromatic dispersion, reduces and the first order term can now become significant. For the case of birefringent fibres, this first order term leads to a group delay called polarization dispersion. This polarization dispersion introduces a differential group delay between orthogonal states of polarization. Although the effect of Polarization Mode Dispersion (PMD) is to change randomly the polarization state of a pulse propagating in a fibre, it is possible to define a pair of orthogonal states, or principal states, which, when launched at the input to fibre, will emerge unchanged at the output. These states are, to first order, independent of wavelength. (In some situations, however, this approximation falls apart and the principal states can show a wavelength dependence, leading to a further system degradation through a coupling to chromatic dispersion.)

Table II.1/G.663 – Non-linear optical effects in glass fibres

Non-linear optical effect	Cause	Characteristics	Critical light power in SMF	Impact
Self Phase Modulation (SPM) and Cross Phase Modulation (XPM)	Optical Kerr effect: intensity-dependent refractive index	<ul style="list-style-type: none"> – Phase shift <ul style="list-style-type: none"> • self induced (SPM) • adjacent channel (XPM) • spectral frequency broadening 	$P_c > \sim 10 \text{ mW}$	<ul style="list-style-type: none"> – Spectral broadening increases effect of dispersion – Power/dispersion limited high bit-rate transmission – Pulse compression <ul style="list-style-type: none"> • positive dispersion – Pulse propagation (Solitons) – Limitations in PSK systems by AM/PM conversion
Stimulated Raman Scattering (SRS)	Interaction of photon-optical phonons	<ul style="list-style-type: none"> – Raman Lines f-n Δf (Stokes) <ul style="list-style-type: none"> $\Delta f = 12 \text{ THz}$ $\Delta \lambda = 70 \text{ nm}$ (1310 nm) $\Delta \lambda = 102 \text{ nm}$ (1550 nm) 	$P_c > \sim 1 \text{ W}$ (for single channel) $P_c > \sim 1 \text{ mW}$ for Raman amplification in a WDM system with critical channel spacing, $\Delta \lambda$	<ul style="list-style-type: none"> – Optical loss in fibre – Optical crosstalk in WDM system – Signal power depletion
Stimulated Brillouin Scattering (SBS)	Interaction: photon-acoustic phonons	<ul style="list-style-type: none"> – Brillouin lines in backward direction f\pm Δf <ul style="list-style-type: none"> $\Delta f = 13.2 \text{ GHz}$ (1310 nm) $\Delta f = 11.1 \text{ GHz}$ (1550 nm) 	$P_c > \sim 5 \text{ mW}$ (for narrow linewidth optical source) – P_c increases with signal line width	<ul style="list-style-type: none"> – Signal instability – Optical loss in fibre – Optical crosstalk in bidirectional coherent multi-channel systems
Four-photon mixing or Four-Wave Mixing (FWM)	Multi-photon interaction	<ul style="list-style-type: none"> – Mixing products generated <ul style="list-style-type: none"> $f_4 = f_1 \pm f_2 \pm f_3$ 	$P_c > \sim 10 \text{ mW}$ (for Recommendation G.653 fibres) – depends on specific parameters e.g. channel spacing and closeness to λ_0	<ul style="list-style-type: none"> – Optical crosstalk in WDM systems – Signal power depletion

Superseded by a more recent version

As alluded to in the first subclause above, the birefringence introduced to the fibre is caused by local random and asymmetric mechanisms such as stress, bending and twisting. These random birefringence mechanisms redefine the local birefringence axes along the length of the fibre, thus causing random coupling between the polarization modes along the length of the fibre. The cabling process also introduces a certain amount of random birefringence and random mode coupling. The fibre length between such changes is usually referred to as the coupling length, which for a fibre is usually quoted as the ensemble average of all of the local coupling lengths. (In a Hi-bi fibre the concept of the beat length could be loosely regarded as a similar concept to the coupling length of fibres.) Furthermore, changes in local environmental conditions, such as temperature for example, cause fluctuations in the local birefringence axes, thus causing random polarization coupling. As a result of the randomly changing polarization coupling, the magnitude of the differential group delay becomes a statistically varying function. It can be shown that distribution of differential group delays is described by a Maxwellian distribution function, defined by:

$$P(\Delta\tau) = \frac{32\Delta\tau^2}{\pi^2 \langle \Delta\tau \rangle^3} \exp\left[-\frac{4\Delta\tau^2}{\pi^2 \langle \Delta\tau \rangle^2}\right]$$

where $\Delta\tau$ is the differential group delay between the two principal states, and $\langle \Delta\tau \rangle$ is the mean differential group delay. As a consequence of the statistical nature of polarization mode dispersion, the magnitude of the dispersion increases with the square root of the fibre, or cable, length, for lengths much longer than the coupling length. Polarization mode dispersion is usually quoted in units of ps or ps/ $\sqrt{\text{km}}$. The unit of ps is usually reserved for single optical elements which have a fixed dispersion (e.g. a coupler or isolator) or short fibre sections which do not exhibit mode coupling.

II.4.1.2 Induced transmission limitations

In a digital transmission system, the principal effect of polarization mode dispersion is to cause intersymbol interference. As an approximate rule of thumb, a 1-dB penalty occurs for a total dispersion equal to $0.4 \cdot T$, where T is the bit period. This is the accepted value for the maximum tolerable system power penalty. Although still unresolved, current studies indicate that optical fibres and cables will be specified according to the mean level of polarization mode dispersion, a view reflected by studies of single- and multi-channel systems where the mean level will also be specified. This corresponds to a mean differential group delay equal to one-tenth of a bit period, $0.1 \cdot T$. Computer simulations have predicted that if the polarization mode dispersion has a Maxwellian distribution with a mean value not exceeding $0.1 \cdot T$, there is less than a 10^{-9} probability that the system power penalty will exceed 1 dB.

Furthermore, in long-haul amplifier systems employing polarization scramblers (devices which deliberately modulate the polarization state of a signal laser so that it appears to be unpolarized), the polarization mode dispersion causes an increase in the degree of polarization of the signal. This degrades system performance through interactions with polarization-dependent loss and polarization hole burning (see following subclauses). In an analogue system, the interaction of polarization mode dispersion with laser chirp leads to a second order distortion proportional to the modulation frequency. A further second order penalty, independent of modulation frequency, is incurred when additional polarization-dependent loss is present in the system.

It has also been shown, and mentioned briefly above, that a second order effect can cause a coupling between polarization mode dispersion and chromatic dispersion. This is caused by the wavelength dependence of the differential group delay. This leads to a statistical contribution to the chromatic dispersion. This is an area which is not well understood and is under study.

Superseded by a more recent version

II.4.1.3 Methods to minimize the induced limitation

Given that the problem arises from induced birefringence, much of the effort in reducing the effects of polarization mode dispersion have been concerned with minimizing the birefringence introduced by fibre or cable manufacture. Care is taken to optimize fibre production to ensure concentricity of the fibre core. Optical cables are manufactured using materials and processes which minimize the residual strain in the cable structure across the fibre core. Elaborate cable structures can also be used which introduce a circular component to the induced birefringence. By careful design, such an effect can counteract linear birefringence to produce a cable with a resultant zero polarization mode dispersion. Typically, the mean polarization mode dispersion of fibres and cables lie in the range:

$$0 < \langle \Delta\tau \rangle < 0.5 \text{ ps}/\sqrt{\text{km}}$$

Another method makes use of the concept of principal states which was introduced earlier. In this scheme, a polarization controller is inserted at the input and output ends of the system. A polarization beam splitter follows the output polarization controller and is used to generate an error signal. The output polarizer searches for the error signal and the input polarizer is adjusted to minimize this error signal. At the point of no error signal, the input polarization state is one of the principal states for the system. Using such a technique up to 1-bit period of delay has been compensated for in a 5 Gbit/s system. A similar technique has been applied to coherent Frequency-Division Multiplexing (FDM) systems.

II.4.2 Polarization dependent loss

II.4.2.1 Description of the effects

Polarization Dependent Loss (PDL) arises from dichroism of the passive optical components such as isolators, couplers etc. in the signal path. When the signal passes through the dichroic element, the component of its electric field parallel to the lossy axis is attenuated. As in the case of polarization mode dispersion, the axes which define the polarization dependent loss are oriented randomly with respect to each other.

II.4.2.2 Induced transmission limitations

To examine the effect of polarization dependent loss, let us examine a possible system configuration. In amplified systems, one mode of amplifier control is to operate at constant signal power. Both the signal and noise are affected by polarization dependent losses. However, because the noise is unpolarized, the signal and noise are affected differently. The noise can be resolved into a component parallel to the signal and a component orthogonal to the signal. It can be shown that the combined effect of PDL and optical amplification is always to increase the component of the noise orthogonal to the signal. Furthermore, the magnitude of the orthogonal noise component changes with time as the signal polarization changes due to polarization mode dispersion. This leads to a reduction in the signal-to-noise ratio and the Q-value at the receiver. Furthermore, the fluctuations time lead to fading of the signal-to-noise and Q-value at the receiver, both of which lead to an impairment in system performance.

In analogue systems, the polarization dependent loss can interact with laser chirp and polarization mode dispersion to reduce the system performance in terms of composite second order distortion. As expected, this impairment is time varying and leads to fluctuations in the system composite second order with time.

II.4.2.3 Methods to minimize the induced limitations

As for the case of polarization mode dispersion, it is important that the polarization dependent loss of the optical components are minimized. However, it should be noted that the impact of polarization dependent loss on the system performance increases as the number of amplifiers increases. In long-

Superseded by a more recent version

haul submarine systems, for example, the requirements are extremely tight, because the number of amplifiers can be several hundred. In a short-haul terrestrial system, where only a few amplifiers are concatenated, the impact of polarization dependent loss on system performance is still under study.

Polarization modulation, or scrambling, has been shown to improve system performance by reducing the fluctuations and improving the average Q . This technique is described more fully in II.4.3.3.

II.4.3 Polarization hole burning

II.4.3.1 Description of the effect

Polarization Hole Burning (PHB) results from an anisotropic saturation created by a polarized saturating signal launched into the erbium fibre. This results in a selective depopulation of excited states aligned with polarized field. Consequently, the available gain in the orthogonal direction is higher. Although the erbium ions are distributed randomly within the glass matrix, on a microscopic level the dipole associated with the erbium ion is anisotropic. The polarization hole burning effect is maximum where the linearly polarized saturating signal is aligned with the major axis of the dipole and is reduced where the polarization state of the saturating signal is elliptical or circular. Both the signal laser and the pump laser contribute to the total effect, the total differential gain being the vector sum of the two contributions. The degree of hole burning is proportional to the degree of polarization of the saturating signal. For an unpolarized saturating signal there is no hole burning. In principle, this is similar to the case of a circularly polarized signal.

II.4.3.2 Induced transmission limitations

The polarization hole burning impacts the system performance by causing the noise build-up along the amplifier chain to be greater than that which would be predicted from simple linear theory. That is, the signal-to-noise is reduced by polarization hole burning and, as for the cases of polarization mode dispersion and polarization dependent loss, the measured Q fluctuates in time. As there are two contributions to polarization hole burning, there are two ways in which the system performance is affected. The total effect is proportional to the gain saturation, increasing with an increased degree of saturation.

First of all, let us consider the effect of the polarized pump laser. It can be considered for the purposes of this discussion that the pump polarization is fixed and invariant. The pump causes a differential gain in the direction orthogonal to its polarization axis. Noise aligned orthogonally to the pump experiences a higher gain than noise aligned with the pump. However, the polarization axes of the pump lasers in each amplifier along a chain are uncorrelated with each other. Therefore, the cumulative effect is similar to a random walk, and the pump-induced polarization hole burning can be considered as a contribution to the polarization dependent loss of the amplifier. Thus, averaged over a number of amplifiers, the noise build-up should be linear as expected from simple theory.

The signal laser induced polarization hole burning is slightly different. As the signal laser propagates along the system, the noise polarized along parallel to the signal laser will see the same gain as the signal. However, noise polarized orthogonal to the signal laser will always experience a higher gain because it will always be orthogonal to the signal polarization axis. Therefore, the total noise will increase in a non-linear way along the chain of amplifiers.

The total differential gain due to polarization hole burning varies as the polarization state of the signal changes (due to polarization mode dispersion) along the amplifier chain. It varies because the signal hole burning effect is correlated with the pump effect. As the relative polarization states of the signal and pump lasers change, the magnitude of the differential gain changes. Therefore, although the total noise increases non-linearly along the chain, it does so in such a way that the total noise fluctuates in time. Consequently, as explained above, the signal-to-noise is reduced and fluctuates in time. The system Q is, therefore, reduced and fluctuates in time.

Superseded by a more recent version

II.4.3.3 Methods to reduce the induced transmission limitations

There exist several ways to reduce the effect of polarization hole burning. Operating the amplifiers in the small signal regime is one potential solution, but this is not always possible and, in many cases, not desirable. In practice, the simplest solution is to use a depolarized signal. A depolarized signal can be created in many ways, but is most commonly generated by polarization scrambling. Using a phase modulator, the polarization state is varied between two orthogonal states in time. The signal then appears to be depolarized.

It has been shown that it is optimal to impose the polarization modulation at twice the bit rate. This is because polarization dependent loss in the amplifier converts the polarization modulation to amplitude modulation. By polarization modulating at twice the bit rate, the amplitude fluctuations are at a rate higher than the detector bandwidth and so are not seen by the receiver. Using such techniques, the performance of very long haul systems have been improved to the point where the predicted performance is met with a high degree of confidence. Polarization modulation is now a standard implementation in transoceanic amplified systems.

However, in long amplified systems, polarization mode dispersion causes a re-polarization of the signal, thus allowing polarization hole burning to again degrade the system performance. Such an effect illustrates the complex nature of the interaction of polarization phenomena in amplified links.

II.5 Dispersion properties

II.5.1 Chromatic dispersion

II.5.1.1 Description of the effects

Chromatic dispersion is predominantly a transmission capacity limitation which results from the transmission source spectral characteristics and the chromatic dispersion of the optical fibre. Optical amplifiers inherently do not significantly change the chromatic dispersion, unless a form of dispersion compensation function is incorporated into an amplified sub-system.

Optical amplifiers produce light around the signal transmission wavelength, known as Amplified Spontaneous Emission (ASE). Usually the ASE component is not modulated and so it is not detected synchronously with the signal. In many optical amplifier implementations, the ASE is blocked by a filter within the amplifier, signal path or receiver. Unless the ASE is modulated along with the transmission signal, its presence results in optical noise as described more fully in II.6.1. The broader spectrum of the ASE does not alter the interaction of the signal spectral characteristics with the optical fibre chromatic dispersion.

Generally, optical amplifiers do not significantly alter the overall chromatic dispersion by their addition to a system. There is a small amount of chromatic dispersion added by the rare-Earth doped fibre used as the active gain medium in an OFA, but those fibre lengths are on the order of tens of metres to a few hundred metres. The chromatic dispersion of the rare-Earth doped fibres is not significantly different from that found in Recommendations G.652, G.653 and G.655 fibres. For systems which are tens to hundreds of kilometres in length, this dispersion contribution is considered negligible.

II.5.1.2 Induced transmission limitations

Generally, optical amplifiers do not alter transmission limitations due to chromatic dispersion. Certain non-linear effects may interact with the fibre chromatic dispersion due to the high output amplified power levels. These effects and methods to minimize induced limitations are described more fully in II.3.

Superseded by a more recent version

II.5.1.3 Minimization of the induced limitation

The presence of an optical amplifier does not effect the chromatic dispersion in a system and thus, no specific methods to minimize these effects are required. However, OFAs do enable consideration of long unregenerated systems, where system penalties due to chromatic dispersion may become significant.

In some optically amplified sub-systems, a passive dispersion compensation function may be combined with the optical amplifier to result in an amplified sub-system which adds a finite amount of chromatic dispersion to the system, with a sign opposite that of the system fibre. This results in lower overall system chromatic dispersion. This function may be co-located with an OFA in order to overcome the losses associated with the passive dispersion compensation function. The changes to the chromatic dispersion in the transmission system are due to the presence of the passive dispersion compensation function (more fully described in G.690-Series Recommendations), and not the optical amplifier.

NOTE – Additional techniques to minimize the limitations induced by chromatic dispersion are described in G.690-Series Recommendations.

II.6 Other OFA-related properties

II.6.1 Noise accumulation

II.6.1.1 Description of the effects

In transmission systems with cascaded OFAs, the ASE noise generated at an OFA repeats a cycle of attenuation and amplification in the same way as the signal light. Since the incoming ASE noise is amplified at each OFA and added to the ASE noise generated at that OFA, the total ASE noise power increases nearly proportionally with the number of OFAs, and the signal power accordingly decreases. The noise power can exceed the signal power.

The ASE noise spectral profile also evolves along the system length. When ASE noise from the first OFA is input to a second OFA, the gain profile of the second OFA changes due to the ASE noise power via the gain saturation effect. Similarly, the effective gain profile of the third OFA is then modified by the output-power spectrum of the second OFA. Such an effect is transmitted all the way down to the last OFA. The ASE noise accumulates even if narrow-band filters are used at each OFA because the noise exists over frequency ranges that include the signal frequency.

II.6.1.2 Induced transmission limitations

ASE noise accumulation affects the SNR of the system because the degradation in the received-signal SNR is due predominantly to ASE-related beat noise. Such beat noises increase linearly with the number of OFAs. Thus, the error rate worsens with increasing numbers of OFAs. In addition, noise accumulates exponentially with the magnitude of the amplifier gain.

As a result of the gain spectrum of the OFA, the ASE noise spectrum after many OFAs tends to have a peak at a wavelength due to the self-filtering effect, which will be described in II.6.2. In particular, if a closed all optical ring network architecture is considered, the ASE noise accumulates as if an infinite number of OFAs were cascaded. Although the accumulation of ASE noise in filtered systems is considerably reduced by the filters, in-band ASE still increases with the number of cascaded OFAs. Thus, the SNR degrades as the number of OFAs increases.

II.6.1.3 Minimization of the effect of noise accumulation

The ASE noise accumulation can be reduced by decreasing the OFA spacing (while maintaining the total gain equal to the total loss of the transmission path), since ASE noise accumulates

Superseded by a more recent version

exponentially with the magnitude of the amplifier gain. One of the following filtering techniques can further reduce the unwanted effect of ASE noise: use of ASE noise filters, or use of the self-filtering effect (self-filtering method).

The self-filtering method is applicable for systems with several tens of OFAs or more. In this method, the signal wavelength is aligned with the self-filtering wavelength so that the ASE noise received at the detector is reduced, just as if a narrow-band filter had been used. This is most effective when used with shortened OFA spans and low-gain OFAs to reduce the initial ASE noise.

The self-filtering method is not applicable if an all-optical WDM closed ring network is considered. In fact, the resulting peak in the OFAs overall gain spectrum may strongly affect the system performance. In this case, the accumulation of the ASE noise can be minimized with the ASE-filter method, which is obtained by filtering the WDM channels not dedicated to the network node before switching them out of the node.

For systems with fewer OFAs, the self-filtering method is less effective than the ASE-filter method. The ASE-filter method allows flexibility in the choice of the signal wavelength and provides other advantages (see II.6.2). Care must be taken in the selection of the filter characteristics, since the cascaded-filter passband is narrower than the passband of a single filter (unless it has a rectangular spectral passband). Conventional filters with a full width at half maximum (FWHM) on the order of 3 nm could be used in long-distance single-channel systems.

II.6.2 Self-filtering effect

II.6.2.1 Description of the effect

As a result of the ASE noise accumulation in non-filtered systems, the characteristic profile of the ASE spectrum (or the overall gain spectrum) tends to have a peak. The peak spectral linewidth narrows with increasing numbers of OFAs until it finally saturates after some number of OFAs. This may result in only 2~3 nm wide spectral linewidth after several tens of OFAs. This effect is called self-filtering.

The self-filtering effect is determined by the spectral shape of the emission and absorption cross-sections and by the degree of inversion of OFAs. The self-filtering wavelength may change with changes in the host glass composition, input optical power, or inter-amplifier loss and their dependence on wavelength, pump wavelength and the length of the doped fibre. The self-filtering effect can generally be considered desirable in single-channel systems (as noted in II.6.1.3), but undesirable in multi-channel systems.

II.6.2.2 Induced transmission limitations

For systems with a limited number of OFAs, the spectral width of the self-filtering gain peak remains broad and does not reduce ASE noise accumulation, even with the signal wavelength adjusted to the peak wavelength. In systems with many OFAs and a well-developed self-filtering gain peak, the SNR can be high but may degrade if the signal wavelength shifts from the self-filtering wavelength. This shift can occur after system reconfiguration or repair because of changes in inter-amplifier loss.

Multi-channel systems with cascaded OFAs can suffer from power variation among channels that exponentially increases with the number of OFAs (the number of OFAs is the exponent). For example, the power spread for a five-channel system of ~3 dB after the first erbium doped fibre amplifier (EDFA) increased to ~15 dB after the sixth EDFA. For multi-channel systems, changes in the total number of channels result in gain-spectral changes which perturb other channels. Saturation-induced spectrally-dependent gain also generates gain variation among the channels.

Superseded by a more recent version

Therefore, the loss-budget margin must be carefully designed to accommodate such EDFA-gain spectral changes both in filtered and non-filtered systems. The use of ASE filters eliminates the problem as described in II.6.2.3.

II.6.2.3 Method to deal with the self-filtering effect

This subclause discusses the use of both OFA self-filtering effects and ASE noise filters to improve system performance.

Using the self-filtering method to improve SNR is most effective when the optimum dispersion wavelength, self-filtering wavelength, and signal wavelength coincide. This method does not require the use of ASE noise filters, which can bring degradation associated with polarization-dependent losses in the filter. This is particularly true in transoceanic submarine systems. On the other hand, reliance on the self-filtering effect complicates system design, reconfiguration and repair because the signal wavelength must always meet the changeable self-filtering wavelength. The spectral characteristics of both OFA gains and inter-amplifier losses should be as uniform as possible. Otherwise, the self-filtering gain peak may not become sufficiently narrow, thus degrading the SNR improvement and making it more difficult to prevent ASE noise-induced saturation in long-haul systems.

To avoid such disadvantages, the ASE-filter method can be used to reduce ASE accumulation with the filter passband adjusted to the signal frequency. Narrow-band filters with FWHM < 1 nm are commercially available. The ASE noise accumulation is then minimized and the system can be freed from restrictions such as complexities of system design, reconfiguration and repair, and the requirements of short OFA span and uniform performance of each OFA.

In multi-channel systems, the inter-channel power spread due to the self-filtering effect can be avoided by amplifying each channel in a physically separated OFA. This method, however, demands a costly demultiplexer, separate OFAs and a multiplexer. An alternative is to provide optical channel power equalization at each network node, even if this method demands additional control electronics and a more critical power budget through the network. An additional method is to use a less saturated or less strongly inverted OFA, because this makes the attenuation less wavelength-dependent and accordingly, reduces inter-channel power spread. In a strongly inverted EDFA cascade, however, the ASE grows with the number of EDFAs at the first gain peak of ~ 1530 nm and needs to be eliminated with a short-wavelength-eliminating filter. In addition, the pre-emphasis method minimizes SNR differences for all channels by adjusting the transmitter optical powers for each channel based on the received signal information from the end terminal.

II.6.3 Optical surge generation

II.6.3.1 Description of the effects

When optical signal input power rapidly increases in sufficiently pumped EDFAs, optical surge occurs because of the slow gain dynamics of EDFAs. The optical surge is likely to occur particularly from output-power-controlled EDFAs. This is because the pump power for such EDFAs increases with decrease in the optical input power and optical surge tends to occur when the input power suddenly recovers. Figure II.6-1 illustrates optical surge generation.

When reconnecting a conventional connector, an optical-power rise time (10-90%) was ~ 0.3 ms, which is short enough to cause an optical surge. If the EDFA is already optically saturated, however, additional rapid increase in optical input power may not cause significant optical surges.

Superseded by a more recent version

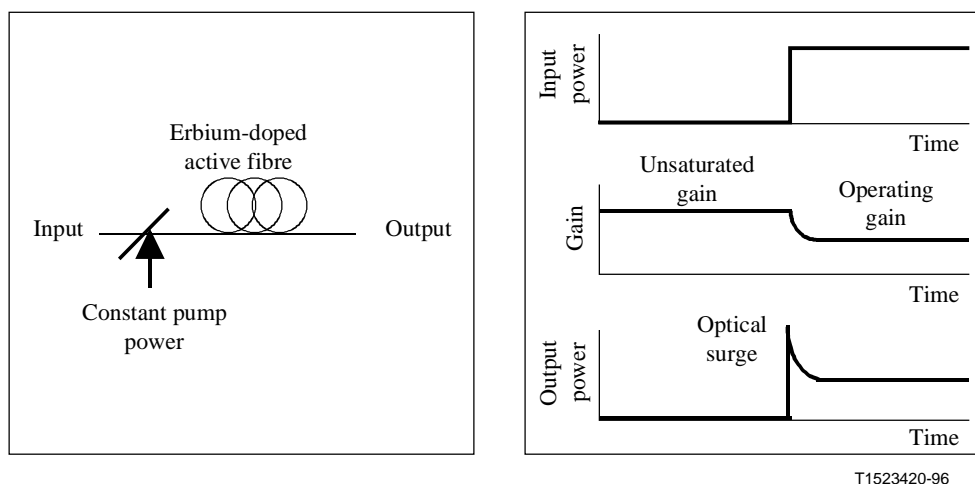

T1523420-96

Figure II.6-1/G.663 – An example of optical surge generation

II.6.3.2 Induced transmission limitations

In EDFA cascades, under particular conditions, the optical-surge peak power can range up to several watts, possibly damaging O/E converters and/or electrical pre-amps and, optical components including optical-connector end faces. Optical surge is also harmful to human eyes. The threshold for damage for a contaminated optical-connector end face has been observed to be at optical power levels of about 20 dBm.

II.6.3.3 Minimization of the effect of surge generation

The following functions can be considered for optical surge prevention:

- 1) to reduce or shut down the pump power to EDFAs when the loss of input signal is detected;
- 2) to recover the pump power level to EDFAs when the recovery of the input signal is detected. In this respect, the reactivation of the pump laser power level up to its nominal value should happen gradually and a related minimum reactivation time should be defined.

Figure II.6-2 shows an example of configuration that achieves surge prevention, where a loss-of-signal detection unit controls the pump laser on/off status. In case of a loss of signal just for a time sufficiently shorter than the gain dynamics of the EDFA, e.g. < 1 ms, the pump laser power needs to be kept unchanged.

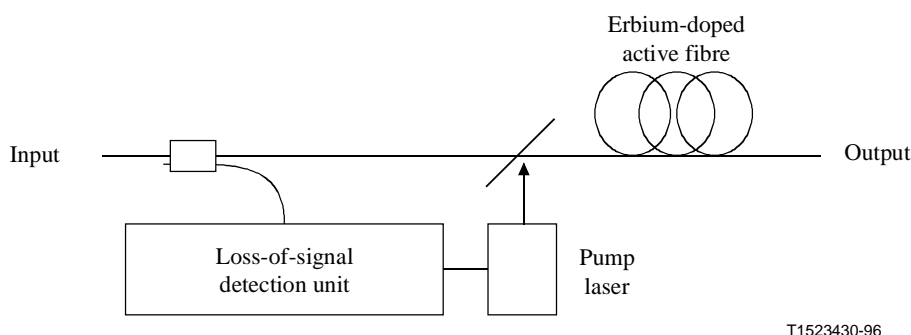

T1523430-96

Figure II.6-2/G.663 – An example of a surge-prevention system

Superseded by a more recent version

APPENDIX III

Pre-amplifier parameters

Definition of the relevant characteristic parameters of the pre-amplifier which allow, by standard formulae, to obtain the minimum input power which ensures a BER = 10^{-12} at the Terminal Receiver Equipment (TRE)

On the basis of theoretical considerations and experimental tests related to optical amplifier noise, the relevant PA characteristic parameters which allow to obtain the minimum input power which ensures a BER = 10^{-12} at the TRE are:

- max small signal gain "GMax" (Recommendation G.661);
- small signal gain "G" (Recommendation G.661);
- signal-spontaneous noise figure " NF_{s-sp} " (Recommendation G.661));
- noise figure "NF" (Recommendation G.661);
- equivalent spontaneous emission-spontaneous emission beat noise optical bandwidth (B_{sp-sp}) (Recommendation G.661).

The optimum amplifier (without internal reflection noise) noise is dominated by two principal components in addition to the contribution of the shot noise of the signal and spontaneous emission noise. These two principal components are the signal-spontaneous emission beat noise and the spontaneous emission-spontaneous emission beat noise.

NOTE – The output noise terms can be subdivided into five categories:

- a) Shot noise from the amplified input signal;
- b) Shot noise from the Amplified Spontaneous Emission (ASE);
- c) Signal-spontaneous emission beat noise from signal mixing with ASE;
- d) Spontaneous emission-spontaneous beat noise from ASE mixing with itself;
- e) Reflection noise.

Each of the noise contribution can be expressed in the form of a partial noise figure "F", where the total noise figure is the sum of all individual contributions. The total noise figure (in linear, not in logarithmic units) is:

$$F_{total} = F_{shot-sig} + F_{shot-ASE} + F_{sig-sp} + F_{sp-sp} + F_{refl}$$

This equation can be used both for evaluating the noise figure from optical measurements, as well as for estimating the influence of such parameters as gain, reflections, source line width and baseband frequency. It represents a complete noise figure model of an OFA.

In these conditions it is possible to obtain, by standard formulae, the following expression for total noise figure:

$$NF = NF_{s-sp} \left(1 + \frac{h\nu n_{sp} B_{sp-sp}}{2P_{in}} \frac{G-1}{G} \right)$$

where:

$$NF_{s-sp} = 2n_{sp} \left(\frac{G-1}{G} \right) \text{ and } n_{sp} = \frac{n_2}{n_2 - n_1}$$

$h\nu$ is the signal photon energy, P_{in} is the optical power at PA input, n_2 is the population density of the excited level, n_1 is the population density of the base level and G and B_{sp-sp} have been defined before. It is clear that NF reduces, by reducing the B_{sp-sp} value, but, for compatibility with existing

Superseded by a more recent version

Recommendation G.957, it has to be limited at values of the order of 1 nm (120 GHz). The SNR at the TRE is given by the following formula:

$$SNR = \frac{m^2 P_{in}}{h\nu \cdot B \cdot NF + \frac{N_{R_x}}{P_{in} G^2}}$$

where m is the modulation depth $\left(1 - \frac{1}{ExtRatio}\right)$, B is the receiver electrical bandwidth (proportional to the bit rate) and N_{R_x} is the TRE equivalent noise. From the previous two formulae it is possible to obtain the minimum input power of the PA for BER = 10^{-12} on the TRE. It is clear that the optimum PA must have a sufficiently high gain in order to make negligible the noise contribution of the TRE compared to the pre-amplifier one. The SNR value for BER better than 10^{-12} must be maintained in all the input power range. The PA will be characterized, from the noise point of view, by defining small signal gain (G), signal-spontaneous emission contribution to the noise figure (NF_{s-sp}) and spontaneous emission-spontaneous emission beat noise equivalent bandwidth (B_{s-sp}). It is important to verify the total noise figure of the PA in order to be sure that no contributions from internal reflection noise are affecting the PA.

Example

Calculation of the SNR ratio for a receiver equipped with a PA able to ensure a BER = 10^{-12} at 2.5 Gbit/s SDH-TRE

On the basis of the previous considerations and the previously defined parameters, the SNR at the output of the PA can be calculated from the following formula:

$$SNR_{(PA)} = \frac{m^2 P_{in}}{h\nu \cdot B \cdot NF}$$

In the above formula it has not considered the shot noise contribution because it is negligible compared to the beating noise components, having defined a small signal gain of 20 dB. This formula assumes the worst case approximation where the noise on the zeros is considered equal to that on the ones (zeros do not present a signal-spontaneous emission beat noise) and where the output noise is considered Gaussian.

From the above-mentioned formula, it is easy to obtain the sensitivity of the PA.

The overall sensitivity of the composite receiver (PA + TRE) is obtained adding to the divisor of the previous formula the term $\frac{N_{R_x}}{P_{in} G^2}$, in which N_{R_x} is the TRE equivalent noise.

$$SNR_{(PA+TRE)} = \frac{m^2 P_{in}}{h\nu \cdot B \cdot NF + \frac{N_{R_x}}{P_{in} G^2}}$$

It is, however, obvious that the term $\frac{N_{R_x}}{P_{in} G^2}$ is negligible for sufficiently high values of the gain G .

Superseded by a more recent version

Taking into account the compatibility in accordance with Recommendation G.957 for a 2.5 Gbit/s TRE with a minimum sensitivity of -26 dBm for $\text{BER} = 10^{-12}$ and the characteristic parameters of the PA previously considered:

– Maximum small signal gain	24 dB
– Small signal gain (G)	≥ 20 dB
– Signal-spontaneous emission noise figure (N_{s-sp})	≤ 5.5 dB
– Available signal wavelength band (B_{s-sp})	1 nm (0.8 – 1.2)
– Signal-to-noise ratio (SNR) for $\text{BER} = 10^{-12}$ on the TRE	3 dB
– Extinction ratio of the optical source	8.2 dB
– TRE pass bandwidth (the electrical bandwidth of the receiver, proportional to the bit rate value) $B = f_{\text{Nyquist}} (1 + \ell)$; where $f_{\text{Nyquist}} = (\text{bit rate})/2 = (2.5 \text{ Gbit/s})/2$ and ℓ is the roll-off coefficient of the Nyquist's channel, variable between 0 and 1	$\left\{ \begin{array}{l} \text{min. value} = \frac{2.5}{2} \text{ GHz} \\ \text{average value} = \frac{2.5}{2} \cdot 1.5 \text{ GHz} \\ \text{maximum value} = 2.5 \text{ GHz} \end{array} \right.$

It is easy to establish that for values of the receiver signal of -16 dBm the contribution of the TRE noise can be considered negligible. With the parameter values previously considered, a minimum input power of -36 dBm for $\text{BER} = 10^{-12}$ at the TRE is obtained. This value can be considered inclusive of the margin due to the worst case hypothesis introduced in the calculations. Consequently to the maximum gain value, the output signal from the PA will be -12 dBm, allowing the sensitivity of the PA to be considered as that of the composite receiver (PA + TRE). Considering for the PA the minimum gain operating conditions (small-signal gain, $G = 20$ dB), the average optical power at the output of the PA will be -16 dBm allowing again the sensitivity of the PA to be considered as that of the composite receiver (PA + TRE).

By using the previous values and formulae, it is also possible to compute that a pre-amplifier output SNR ratio better than 13 dB is achievable with a pre-amplifier input power level down to -43 dBm, when a configuration without line amplifiers is used.

APPENDIX IV

OAM aspects of OFAs

Possible generic OAM aspects for OFA sub-systems and devices are given below.

IV.1 OFA sub-systems

Because OATs and OARs from a maintenance perspective are not different from conventional transmitters and receivers, the associated Operation, Administration and Maintenance (OAM) aspects are identical to those of transmitters and receivers specified in Recommendation G.783.

IV.2 OFA devices

The following OAM conditions can be presented as information to the involved management system:

- OFA Loss of Signal (LOS), indicating possible loss of input signal (transmission defect);
- OFA failure, indicating that an optical amplifier can no longer perform its basic function of optical amplification (equipment defect);

Superseded by a more recent version

- OFA in shut-down conditions (output status).

This distinction is made to provide the user with information on the equipment and/or cable plant. Furthermore, OFAs can be provided with an "enable/disable output" control signal in order to be able to limit optical power levels possibly needed to satisfy optical safety requirements.

NOTE – The use of further sources of equipment failure like "OFA degradation" or "Loss of optical supervisory channel" (in case of the presence of line amplifiers) is for further study.

Superseded by a more recent version

ITU-T RECOMMENDATIONS SERIES

Series A	Organization of the work of the ITU-T
Series B	Means of expression: definitions, symbols, classification
Series C	General telecommunication statistics
Series D	General tariff principles
Series E	Overall network operation, telephone service, service operation and human factors
Series F	Non-telephone telecommunication services
Series G	Transmission systems and media, digital systems and networks
Series H	Audiovisual and multimedia systems
Series I	Integrated services digital network
Series J	Transmission of television, sound programme and other multimedia signals
Series K	Protection against interference
Series L	Construction, installation and protection of cables and other elements of outside plant
Series M	Maintenance: international transmission systems, telephone circuits, telegraphy, facsimile and leased circuits
Series N	Maintenance: international sound programme and television transmission circuits
Series O	Specifications of measuring equipment
Series P	Telephone transmission quality, telephone installations, local line networks
Series Q	Switching and signalling
Series R	Telegraph transmission
Series S	Telegraph services terminal equipment
Series T	Terminals for telematic services
Series U	Telegraph switching
Series V	Data communication over the telephone network
Series X	Data networks and open system communication
Series Z	Programming languages