



INTERNATIONAL TELECOMMUNICATION UNION

ITU-T

TELECOMMUNICATION
STANDARDIZATION SECTOR
OF ITU

X.224

(11/95)

SERIES X: DATA NETWORKS AND OPEN SYSTEM
COMMUNICATION

Open Systems Interconnection – Connection-mode
protocol specifications

**Information technology – Open Systems
Interconnection – Protocol for providing
the connection-mode transport service**

ITU-T Recommendation X.224

(Previously “CCITT Recommendation”)

ITU-T X-SERIES RECOMMENDATIONS
DATA NETWORKS AND OPEN SYSTEM COMMUNICATION

PUBLIC DATA NETWORKS	X.1-X.199
Services and facilities	X.1-X.19
Interfaces	X.20-X.49
Transmission, signalling and switching	X.50-X.89
Network aspects	X.90-X.149
Maintenance	X.150-X.179
Administrative arrangements	X.180-X.199
OPEN SYSTEM INTERCONNECTION	X.200-X.299
Model and notation	X.200-X.209
Service definitions	X.210-X.219
Connection-mode protocol specifications	X.220-X.229
Connectionless-mode protocol specification	X.230-X.239
PICS proformas	X.240-X.259
Protocol Identification	X.260-X.269
Security Protocols	X.270-X.279
Layer Managed Objects	X.280-X.289
Conformance testing	X.290-X.299
INTERWORKING BETWEEN NETWORKS	X.300-X.399
General	X.300-X.349
Satellite data transmission networks	X.350-X.399
MESSAGE HANDLING SYSTEMS	X.400-X.499
DIRECTORY	X.500-X.599
OSI NETWORKING AND SYSTEM ASPECTS	X.600-X.699
Networking	X.600-X.629
Efficiency	X.630-X.649
Naming, Addressing and Registration	X.650-X.679
Abstract Syntax Notation One (ASN.1)	X.680-X.699
OSI MANAGEMENT	X.700-X.799
Systems Management framework and architecture	X.700-X.709
Management Communication Service and Protocol	X.710-X.719
Structure of Management Information	X.720-X.729
Management functions	X.730-X.799
SECURITY	X.800-X.849
OSI APPLICATIONS	X.850-X.899
Commitment, Concurrency and Recovery	X.850-X.859
Transaction processing	X.860-X.879
Remote operations	X.880-X.899
OPEN DISTRIBUTED PROCESSING	X.900-X.999

For further details, please refer to ITU-T List of Recommendations.

FOREWORD

ITU (International Telecommunication Union) is the United Nations Specialized Agency in the field of telecommunications. The ITU Telecommunication Standardization Sector (ITU-T) is a permanent organ of the ITU. Some 179 member countries, 84 telecom operating entities, 145 scientific and industrial organizations and 38 international organizations participate in ITU-T which is the body which sets world telecommunications standards (Recommendations).

The approval of Recommendations by the Members of ITU-T is covered by the procedure laid down in WTSC Resolution No. 1 (Helsinki, 1993). In addition, the World Telecommunication Standardization Conference (WTSC), which meets every four years, approves Recommendations submitted to it and establishes the study programme for the following period.

In some areas of information technology which fall within ITU-T's purview, the necessary standards are prepared on a collaborative basis with ISO and IEC. The text of ITU-T Recommendation X.224 was approved on 21st of November 1995. The identical text is also published as ISO/IEC International Standard 8073.

NOTE

In this Recommendation, the expression "Administration" is used for conciseness to indicate both a telecommunication administration and a recognized operating agency.

© ITU 1997

All rights reserved. No part of this publication may be reproduced or utilized in any form or by any means, electronic or mechanical, including photocopying and microfilm, without permission in writing from the ITU, except as noted in footnote 1) in Annex C.

CONTENTS

	<i>Page</i>
1	Scope..... 1
2	References..... 1
2.1	Identical Recommendations International Standards..... 3
2.2	Paired Recommendations International Standards equivalent in technical content..... 3
3	Definitions..... 3
4	Abbreviations..... 5
4.1	Data units..... 5
4.2	Types of Transport Protocol data units..... 5
4.3	TPDU fields..... 5
4.4	Times and associated variables..... 5
4.5	Miscellaneous..... 6
5	Overview of the Transport Protocol..... 6
5.1	Service provided by the Transport Layer..... 6
5.2	Service assumed from the Network Layer..... 6
5.3	Functions of the Transport Layer..... 7
5.4	Classes and options when operating over CONS..... 9
5.5	Characteristics of class 4 transport protocol when operating over CLNS..... 11
5.6	Model of the Transport Layer..... 11
6	Elements of procedure..... 11
6.1	Use of the network service..... 12
6.2	Transport Protocol Data Unit (TPDU) transfer..... 13
6.3	Segmenting and reassembling..... 14
6.4	Concatenation and separation..... 14
6.5	Connection establishment..... 14
6.6	Connection refusal..... 22
6.7	Normal release..... 23
6.8	Error release when operating over CONS..... 25
6.9	Association of TPDU with transport connections..... 25
6.10	Data TPDU numbering..... 28
6.11	Expedited data transfer..... 29
6.12	Reassignment after failure when operating over CONS..... 30
6.13	Retention and acknowledgement of TPDU..... 31
6.14	Resynchronization..... 33
6.15	Multiplexing and demultiplexing when operating over CONS..... 35
6.16	Explicit flow control..... 35
6.17	Checksum..... 36
6.18	Frozen references..... 37
6.19	Retransmission on time-out..... 37
6.20	Resequencing..... 38
6.21	Inactivity control..... 38
6.22	Treatment of protocol errors..... 38
6.23	Splitting and recombining when operating over CONS..... 39
7	Protocol classes..... 40
8	Specification for class 0 – Simple class..... 40
8.1	Functions of class 0..... 40
8.2	Procedures for class 0..... 40

	<i>Page</i>
9	Specification for class 1 – Basic error recovery class 39
10	Specification for class 2 – Multiplexing class 40
11	Specification for class 3 – Error recovery and multiplexing class 42
12	Specification for class 4 – Error detection and recovery class 43
13	Structure and encoding of TPDU 55
	13.1 Validity 55
	13.2 Structure 55
	13.3 Connection Request (CR) TPDU 57
	13.4 Connection Confirm (CC) TPDU 62
	13.5 Disconnect Request (DR) TPDU 62
	13.6 Disconnect Confirm (DC) TPDU 63
	13.7 Data (DT) TPDU 64
	13.8 Expedited Data (ED) TPDU 65
	13.9 Data Acknowledgement (AK) TPDU 66
	13.10 Expedited Data Acknowledgement (EA) TPDU 68
	13.11 Reject (RJ) TPDU 68
	13.12 TPDU Error (ER) TPDU 69
14	Conformance 70
	14.5 Claims of conformance shall state 79
Annex A	– State tables 80
	A.1 General 80
	A.2 Conventions 80
	A.3 Tables 81
	A.4 State tables for classes 0 and 2 83
	A.5 State tables for classes 1 and 3 86
	A.6 State tables for class 4 over CONS 88
	A.7 State tables for class 4 over CLNS 97
Annex B	– Network connection management subprotocol 100
	B.1 Introduction 100
	B.2 Scope 100
	B.3 Definitions 100
	B.4 Abbreviations 101
	B.5 Overview of the protocol 101
	B.6 Elements of procedure 102
	B.7 Protocol operation 106
	B.8 Structure and encoding of TPDU 110
	B.9 Conformance 112
	B.10 State table 113
	B.11 Diagram for NCMS protocol operation 115
Annex C	– PICS Proforma 110
	C.1 General 110
	C.2 Identification 110
	C.3 Indices used in this Annex 111
	C.4 Based Recommendation International Standard conformance 113
	C.5 General statement of conformance 113
	C.6 Protocol implementation 113
	C.7 NCMS functions 113
	C.8 Initiator/responder capability for protocol classes 0 - 4 114
	C.9 Supported functions 114
	C.10 Supported TPDU 120
	C.11 Supported parameters of issued TPDU 121

	<i>Page</i>
C.12 Supported parameters for received TPDU's	128
C.13 User data in issued TPDU's	128
C.14 User data in received TPDU's.....	130
C.15 Negotiation.....	130
C.16 Error handling	134
C.17 Timers and protocol parameters.....	135
Annex D – Checksum Algorithms.....	137
D.1 Symbols.....	137
D.2 Arithmetic conventions.....	137
D.3 Algorithm for generating checksum parameters	137
D.4 Algorithm for checking checksum parameters.....	138
Annex E – State tables for operation of class 4 over connection-mode and connectionless-mode network services	139
E.1 General.....	139
E.2 Conventions	139
E.3 Tables.....	139
E.4 State tables for class 4.....	139
Appendix I – Differences between ITU-T Rec. X.224 (1993) and ISO/IEC 8073:1992	147
I.1 Assignment to network connections	147
I.2 Conformance.....	147
I.3 Class negotiation.....	147
I.4 Precedence	147
I.5 Difference between ITU-T Rec. X.224 and ISO/IEC 8073	147

Summary

This Recommendation | International Standard specifies a common encoding and a five classes of transport protocol procedures which provide connection-mode transport service over either connection-mode or connectionless-mode network service and to be used with different network qualities of service.

Introduction

This Recommendation | International Standard is one of a set of Recommendations | International Standards produced to facilitate the interconnection of information processing systems. This set of Recommendations | International Standards covers the services and protocols required to achieve such interconnection.

The Transport Protocol is positioned with respect to other related Recommendations | International Standards by the layers defined in the Reference Model for Open Systems Interconnection (see CCITT Rec. X.200 | ISO 7498). It is most closely related to, and lies within the field of application of the Transport Service (see ITU-T Rec. X.214 | ISO/IEC 8072). It also uses and makes reference to the Network Service Standard (see CCITT Rec. X.213 | ISO/IEC 8348), whose provisions it assumes in order to accomplish the transport protocol's aims. The interrelationship of these Recommendations | International Standards is illustrated in Figure Intro. 1.

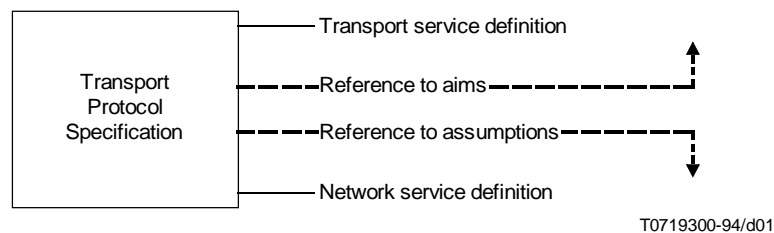

Figure Intro. 1 – Relationship between the Transport Protocol and adjacent services

This Recommendation | International Standard specifies a common encoding and a number of classes of transport protocol procedures to be used with different network qualities of service.

It is intended that the Transport Protocol should be simple but general enough to cater for the total range of Network Service qualities possible, without restricting future extensions.

The protocol is structured to give rise to classes of protocol which are designed to minimize possible incompatibilities and implementation costs.

The classes are selectable with respect to the Transport and Network Services in providing the required quality of service for the interconnection of two session entities (each class provides a different set of functions for enhancement of service qualities).

This Recommendation | International Standard defines mechanisms that can be used to optimize network tariffs and enhance the following qualities of service:

- a) different throughput;
- b) different error rates;
- c) integrity of data requirements;
- d) reliability requirements.

It does not require an implementation to use all of these mechanisms, nor does it define methods for measuring achieved quality of service or criteria for deciding when to release transport connections following quality of service degradation.

The primary aim of this Recommendation | International Standard is to provide a set of rules for communication expressed in terms of the procedures to be carried out by peer entities at the time of communication. These rules for communication are intended to provide a sound basis for development in order to serve a variety of purposes, i.e.:

- a) as a guide for implementors and designers;
- b) for use in the testing and procurement of equipment;
- c) as part of an agreement for the admittance of systems into the open systems environment;
- d) as a refinement of the understanding of OSI.

As it is expected that the initial users of this Recommendation | International Standard will be designers and implementors of equipment, this Recommendation | International Standard contains, in notes or in annexes, guidance on the implementation of the procedures defined herein.

It should be noted that, as the number of valid protocol sequences is very large, it is not possible with current technology to verify that an implementation will operate the protocol defined in this Recommendation | International Standard correctly under all circumstances. It is possible by means of testing to establish confidence that an implementation correctly operates the protocol in a representative sample of circumstances. It is, however, intended that this Recommendation | International Standard can be used in circumstances where two implementations fail to communicate in order to determine whether one or both have failed to operate the protocol correctly.

This Recommendation | International Standard contains a clause on conformance of equipment claiming to implement the procedures in this Recommendation | International Standard. To evaluate conformance of a particular implementation, it is necessary to have a statement of which capabilities and options have been implemented for a given OSI protocol. Such a statement is called a Protocol Implementation Conformance Statement (PICS). A PICS proforma is provided in Annex C. Attention is drawn to the fact that this Recommendation | International Standard does not contain any tests to demonstrate this conformance.

The variations and options available within this Recommendation | International Standard are essential as they enable a transport service to be provided for a wide variety of applications over a variety of network qualities. Thus, a minimally conforming implementation will not be suitable for use in all possible circumstances. It is important, therefore, to qualify all references to this Recommendation | International Standard with statements of the options provided or required or with statements of the intended purpose of provision or use.

INTERNATIONAL STANDARD

ITU-T RECOMMENDATION

INFORMATION TECHNOLOGY – OPEN SYSTEMS INTERCONNECTION – PROTOCOL FOR PROVIDING THE CONNECTION-MODE TRANSPORT SERVICE

(Malaga-Torremolinos, 1984; amended at Melbourne, 1988, and at Geneva, 1993; revised in 1996)

1 Scope

This Recommendation | International Standard specifies:

- a) five classes of procedures when operating over the connection-mode network service:
 - 1) class 0: simple class;
 - 2) class 1: basic error recovery class;
 - 3) class 2: multiplexing class;
 - 4) class 3: error recovery and multiplexing class;
 - 5) class 4: error detection and recovery class;
 for the connection-mode transfer of data and control information from one transport entity to a peer transport entity;
- b) one class (class 4) of procedure when operating over the connectionless-mode network service;
- c) the means of negotiating the class of procedures to be used by the transport entities;
- d) the structure and encoding of the transport protocol data units used for the transfer of data and control information.

The procedures are defined in terms of:

- i) the interactions between peer transport entities through the exchange of transport protocol data units;
- ii) the interactions between a transport entity and the transport service user in the same system through the exchange of transport service primitives;
- iii) the interactions between a transport entity and the network service provider through the exchange of network service primitives.

These procedures are defined in the main text of this Recommendation | International Standard supplemented by state tables in Annex A.

These procedures are applicable to instances of communication between systems which support the Transport Layer of the OSI Reference Model and which wish to interconnect in an open systems environment.

This Recommendation | International Standard specifies, in clause 14, conformance requirements for systems implementing these procedures and provides the PICS proforma in compliance with the relevant requirements, and in accordance with the relevant guidance, given in CCITT Rec. X.291 and ISO/IEC 9646-2. It does not contain tests which can be used to demonstrate this conformance.

2 References

The following Recommendations and International Standards contain provisions which, through references in this text, constitute provisions of this Recommendation | International Standard. At the time of publication, the editions indicated were valid. All Recommendations and Standards are subject to revision, and parties to agreements based on this Recommendation | International Standard are encouraged to investigate the possibility of applying the most recent edition of the Recommendations and Standards listed below. Members of IEC and ISO maintain registers of currently valid International Standards. The Telecommunication Standardization Bureau of the ITU maintains a list of currently valid ITU-T Recommendations.

2.1 Identical Recommendations | International Standards

- CCITT Recommendation X.213 (1992) | ISO/IEC 8348:1993, *Information technology – Open Systems Interconnection – Network service definition.*
- ITU-T Recommendation X.214 (1993 | ISO/IEC 8072:1994, *Information technology – Open Systems Interconnection Transport service definition.*

2.2 Paired Recommendations | International Standards equivalent in technical content

- CCITT Recommendation X.200 (1988), *Reference model of Open Systems Interconnection for CCITT applications.*
ISO 7498:1984, *Information processing systems – Open Systems Interconnection – Basic Reference Model.*
- ITU-T Recommendation X.264 (1993), *Transport protocol identification mechanism.*
ISO/IEC 11570:1992, *Information technology – Telecommunications and information exchange between systems – Open Systems Interconnection – Transport protocol identification mechanism.*
- CCITT Recommendation X.290 (1992), *OSI Conformance testing methodology and framework for protocol Recommendations for CCITT applications – General concepts.*
ISO/IEC 9646-1:1994, *Information technology – Open Systems Interconnection – Conformance testing methodology and framework – Part 1: General concepts.*
- CCITT Recommendation X.291 (1992), *OSI conformance testing methodology and framework for protocol Recommendations for CCITT applications – Abstract test suite specification.*
ISO/IEC 9646-2:1994, *Information technology – Open Systems Interconnection – Conformance testing methodology and framework – Part 2: Abstract Test Suite specification.*
- CCITT Recommendation X.650 (1992), *Open Systems Interconnections (OSI) – Reference Model for naming and addressing.*
ISO 7498-3:1989, *Information processing systems – Open Systems Interconnection – Basic Reference Model – Part 3: Naming and addressing.*

3 Definitions

NOTE – The definitions contained in this clause make use of abbreviations defined in clause 4.

3.1 This Recommendation | International Standard is based on the concepts developed in CCITT Rec. X.200 and ISO 7498 and CCITT Rec. X.650 and ISO/IEC 7498-3 and makes use of the following terms defined in them:

- concatenation and separation;
- segmenting and reassembling;
- multiplexing and demultiplexing;
- splitting and recombining;
- flow control;
- connectionless-mode transmission;
- transport selector;
- nil selector value.

3.2 For the purposes of this Recommendation, the following definitions apply:

3.2.1 equipment: Hardware or software or a combination of both; it need not be physically distinct within a computer system.

3.2.2 transport service user: An abstract representation of the totality of those entities within a single system that make use of the transport service.

3.2.3 network service provider: An abstract machine that models the totality of the entities providing the network service, as viewed by a transport entity.

3.2.4 local matter: A decision made by a system concerning its behaviour in the Transport Layer that is not subject to the requirements of this protocol.

3.2.5 initiator: A transport entity that initiates a CR-TPDU.

- 3.2.6 responder:** A transport entity with whom an initiator wishes to establish a transport connection.
NOTE – Initiator and responder are defined with respect to a single transport connection. A transport entity can be both an initiator and responder simultaneously.
- 3.2.7 sending transport entity:** A transport entity that sends a given TPDU.
- 3.2.8 receiving transport entity:** A transport entity that receives a given TPDU.
- 3.2.9 preferred class:** The protocol class that the initiator indicates in a CR-TPDU as its first choice for use over the transport connection.
- 3.2.10 alternative class:** A protocol class that the initiator indicates in a CR-TPDU as an alternative choice for use over the transport connection.
- 3.2.11 proposed class:** A preferred class or an alternative class.
- 3.2.12 selected class:** The protocol class that the responder indicates in a CC-TPDU that it has chosen for use over the transport connection.
- 3.2.13 proposed parameter:** The value for a parameter that the initiator indicates in a CR-TPDU that it wishes to use over the transport connection.
- 3.2.14 selected parameter:** The value for a parameter that the responder indicates in a CC-TPDU that it has chosen for use over the transport connection.
- 3.2.15 error indication:** An N-RESET indication, or an N-DISCONNECT indication with a reason code indicating an error, that a transport entity receives from the NS-provider.
- 3.2.16 invalid TPDU:** A TPDU that does not comply with the requirements of this Recommendation | International Standard for structure and encoding.
- 3.2.17 protocol error:** A TPDU whose use does not comply with the procedures for the class.
- 3.2.18 sequence number:**
- a) the number in the TPDU-NR field of a DT-TPDU that indicates the order in which the DT-TPDU was transmitted by a transport entity;
 - b) the number in the YR-TU-NR field of an AK or RJ-TPDU that indicates the sequence number of the next DT TPDU expected to be received by a transport entity.
- 3.2.19 transmit window:** The set of consecutive sequence numbers which a transport entity has been authorized by its peer entity to send at a given time on a given transport connection.
- 3.2.20 lower window edge:** The lowest sequence number in a transmit window.
- 3.2.21 upper window edge:** The sequence number which is one greater than the highest sequence number in the transmit window.
- 3.2.22 upper window edge allocated to the peer entity:** The value that a transport entity communicates to its peer entity to be interpreted as its new upper window edge.
- 3.2.23 closed window:** A transmit window that contains no sequence number.
- 3.2.24 window information:** Information contained in a TPDU relating to the upper and the lower window edges.
- 3.2.25 frozen reference:** A reference that is not available for assignment to a connection because of the requirements of 6.18.
- 3.2.26 unassigned reference:** A reference that is neither currently in use for identifying a transport connection nor which is in a frozen state.
- 3.2.27 transparent (data):** TS-user data that is transferred intact between transport entities and which is unavailable for use by the transport entities.
- 3.2.28 owner (of a network connection):** The transport entity that issued the N-CONNECT request leading to the creation of that network connection. Only applicable when operating over the connection-mode network service.
- 3.2.29 retained TPDU:** A TPDU that is subject to the retransmission procedure or retention and acknowledgement procedure and is available for possible retransmission.

ISO/IEC 8073 : 1997 (E)

3.3 This Recommendation | International Standard uses the following terms defined in CCITT Rec. X.213 | ISO/IEC 8348:

- a) connection-mode network service;
- b) connectionless-mode network service.

3.4 This Recommendation | International Standard uses the following terms defined in CCITT Rec. X.290 and ISO/IEC 9646-1:

- a) PICS proforma;
- b) Protocol Implementation Conformance Statement (PICS).

4 Abbreviations

4.1 Data units

TPDU Transport-protocol-data-unit
TSDU Transport-service-data-unit
NSDU Network-service-data-unit

4.2 Types of Transport Protocol data units

CR TPDU Connection Request TPDU
CC TPDU Connection Confirm TPDU
DR TPDU Disconnect Request TPDU
DC TPDU Disconnect Confirm TPDU
DT TPDU Data TPDU
ED TPDU Expedited Data TPDU
AK TPDU Data Acknowledge TPDU
EA TPDU Expedited Acknowledge TPDU
RJ TPDU Reject TPDU
ER TPDU Error TPDU

4.3 TPDU fields

LI Length Indicator (field)
CDT Credit (field)
T-selector Transport selector (field)
DST-REF Destination Reference (field)
SRC-REF Source Reference (field)
EOT End of TSDU Mark
DT-TPDU-NR DT-TPDU Number (field)
ED-TPDU-NR ED-TPDU Number (field)
YR-TU-NR Sequence Number Response (field)
YR-EDTU-NR ED-TPDU Number Response (field)
ROA Request of Acknowledgement Mark

4.4 Times and associated variables

T_I Local Retransmission Time
N The Maximum Number of Transmissions
L Time Bound on Reference and Sequence Number
I Inactivity Time

<i>W</i>	Window Time
<i>TTR</i>	Time to Try Reassignment/Resynchronization
<i>TWR</i>	Time to Wait for Reassignment/Resynchronization
<i>TS1</i>	Supervisory Timer 1
<i>TS2</i>	Supervisory Timer 2
<i>M_{LR}</i>	NSDU Lifetime Local-to-remote
<i>M_{RL}</i>	NSDU Lifetime Remote-to-local
<i>E_{LR}</i>	Expected Maximum Transit Delay Local-to-remote
<i>E_{RL}</i>	Expected Maximum Transit Delay Remote-to-local
<i>R</i>	Persistence Time
<i>A_L</i>	Local Acknowledgement Time
<i>A_R</i>	Remote Acknowledgement Time
<i>I_L</i>	Local Inactivity Time
<i>I_R</i>	Remote Inactivity Time

4.5 Miscellaneous

TS-user	Transport-service user
TSAP	Transport-service-access-point
NS-provider	Network Service Provider
NSAP	Network-service-access-point
QOS	Quality of Service
CLNS	Connectionless-mode network service
CONS	Connection-mode network service

5 Overview of the Transport Protocol

NOTE – This overview is not exhaustive and has been provided for guidance.

5.1 Service provided by the Transport Layer

The protocol specified in this Recommendation | International Standard supports the Transport Service defined in ITU-T Rec. X.214 | ISO/IEC 8072.

Information is transferred to and from the TS-user in the transport service primitives listed in Table 1.

5.2 Service assumed from the Network Layer

The protocol specified in this Recommendation | International Standard assumes the use of the Network Service defined in CCITT Rec. X.213 | ISO/IEC 8348.

When operating over CONS, information is transferred to and from the NS-provider in the network service primitives listed in Table 2a). When operating over CLNS, information is transferred to and from the NS-provider in the network service primitives listed in Table 2b).

NOTES

1 The parameters listed in Table 2a) are those in the current connection-mode network service (see CCITT Rec. X.213 | ISO/IEC 8348).

2 The parameters listed in Table 2b) are those in the current connectionless-mode network service (see CCITT Rec. X.213 | ISO/IEC 8348).

3 The way the parameters are exchanged between the transport entity and the NS-provider is a local matter.

Table 1 – Transport service primitives

Primitives		Parameters
T-CONNECT	request indication	Called address Calling address Expedited data option Quality of service TS-user data
T-CONNECT	response confirm	Responding address Quality of service Expedited data option TS-user-data
T-DATA	request indication	TS-user-data
T-EXPEDITED DATA	request indication	TS-user-data
T-DISCONNECT	request	TS-user-data
T-DISCONNECT	indication	Disconnect reason TS-user-data

5.3 Functions of the Transport Layer

5.3.1 Overview of functions

The functions in the Transport Layer are those necessary to bridge the gap between the services available from the Network Layer and those to be offered to the TS-users.

The functions in the Transport Layer are concerned with the enhancement of quality of service, including aspects of cost optimization.

These functions are grouped below into those used at all times during a transport connection and those concerned with connection establishment, data transfer and release.

NOTE – This Recommendation | International Standard does not include the following functions which are under consideration for inclusion in future editions of this Recommendation:

- a) encryption;
- b) accounting mechanisms;
- c) status exchanges and monitoring of QOS;
- d) blocking;
- e) temporary release of network connections;
- f) alternative checksum algorithm.

5.3.1.1 Functions used at all times

The following functions, depending upon the selected class and options, are used at all times during a transport connection:

- a) *Transmission of TPDU*s (see 6.2 and 6.9).
- b) *Multiplexing and demultiplexing* (see 6.15) – A function used only when operating over CONS to share a single network connection between two or more transport connections.
- c) *Error detections* (see 6.10, 6.13 and 6.17) – A function used to detect the loss, corruption, duplication, misordering, or misdelivery of TPDUs.
- d) *Error recovery* (see 6.12, 6.14, 6.18, 6.19, 6.20, 6.21, and 6.22) – A function used to recover from detected and signalled errors.

Table 2a) – Connection-mode network service primitives

Primitives		X/Y	Parameters	W/X/Y/Z
N-CONNECT	request	X	Called address Calling address	X X
	indication	X	Receipt confirmation selection Expedited data selection QOS parameter set NS-user-data	Y Y X Z
N-CONNECT	response	X	Responding address	X
	confirm	X	Receipt confirmation selection Expedited data selection QOS parameter set NS-user-data	Y Y X Z
N-DATA	request	X	N-user-data	X
	indication	X	Confirmation request	Y
N-DATA ACKNOWLEDGE				
	request	Y		
	indication	Y		
N-EXPEDITED DATA	request	Y	N-user-data	Y
	indication	Y		
N-RESET	request	X	Reason	W
	indication	X	Originator Reason	W W
N-RESET	response	X	–	
	confirm	X	–	
N-DISCONNECT	request	X	Reason NS-user-data Responding address	W Z Z
	indication	X	Originator Reason NS-user-data Responding address	W W Z Z
W	The usage of this parameter is a local matter, e.g. for diagnostic or to decide whether to attempt resynchronization.			
X	The Transport Protocol assumes that this facility is provided in all networks.			
Y	The Transport Protocol assumes that this facility is provided in some networks and a mechanism is provided to optionally use the facility.			
Z	The Transport Protocol does not use this parameter.			

Table 2b) – Connectionless-mode network service primitives

Primitives		X/Y	Parameters	W/X/Y/Z
N-UNIT-DATA	request	X	Source address Destination address Quality of service NS-user-data	X X X X
	indication	X	Source address Destination address Quality of service NS-user-data	X X X X
W	The usage of this parameter is a local matter, e.g. for diagnostic or to decide whether to attempt resynchronization.			
X	The Transport Protocol assumes that this facility is provided in all networks.			
Y	The Transport Protocol assumes that this facility is provided in some networks and a mechanism is provided to optionally use the facility.			
Z	The Transport Protocol does not use this parameter.			

5.3.1.2 Connection establishment

The purpose of connection establishment is to establish a transport connection between two TS-users. The following functions of the Transport Layer during this phase match the TS-users' requested quality of service with the services offered by the Network Layer:

- a) select the network service which best matches the requirement of the TS-user taking into account charges for various services (see 6.5);
- b) decide whether to multiplex multiple transport connections onto a single network connection only when operating over CONS (see 6.5);
- c) establish the optimum TPDU size (see 6.5);
- d) select the functions that will be operational upon entering the data transfer phase (see 6.5);
- e) map transport addresses onto network addresses;
- f) provide a means to distinguish between two different transport connections (see 6.5);
- g) transport of TS-user data (see 6.5);
- h) exchange values of Inactivity timers (see 6.5).

5.3.1.3 Data transfer

The purpose of data transfer is to permit duplex transmission of TSDUs between the two TS-users connected by the transport connection. This purpose is achieved by means of two-way simultaneous communication and by the following functions, some of which are used or not used in accordance with the result of the selection performed in connection establishment.

- a) *Concatenation and separation* (see 6.4) – A function used to collect several TPDU's into a single NSDU at the sending transport entity and to separate the TPDU's at the receiving transport entity.
- b) *Segmenting and reassembling* (see 6.3) – A function used to segment a single data TSDU into multiple TPDU's at the sending transport entity and to reassemble them into their original format at the receiving transport entity.
- c) *Splitting and recombining* (see 6.23) – A function allowing, only when operating over CONS, the simultaneous use of two or more network connections to support the same transport connection.
- d) *Flow control* (see 6.16) – A function used to regulate the flow of TPDU's between two transport entities on one transport connection.
- e) *Transport connection identification* – A means to uniquely identify a transport connection between the pair of transport entities supporting the connection during the lifetime of the transport connection.
- f) *Expedited data* (see 6.11) – A function used to bypass the flow control of normal data TPDU. Expedited data TPDU flow is controlled by separate flow control.
- g) *TSDU delimiting* (see 6.3) – A function used to determine the beginning and ending of a TSDU.

5.3.1.4 Release

The purpose of release (see 6.7 and 6.8) is to provide disconnection of the transport connection, regardless of the current activity.

5.4 Classes and options when operating over CONS

5.4.1 General

The functions of the Transport Layer have been organized into classes and options.

A class defines a set of functions. Options define those functions within a class which may or may not be used.

This Recommendation | International Standard defines five classes of protocol:

- a) class 0: simple class;
- b) class 1: basic error recovery class;
- c) class 2: multiplexing class;
- d) class 3: error recovery and multiplexing class;
- e) class 4: error detection and recovery class.

NOTES

- 1 Transport connections of classes 2, 3 and 4 may be multiplexed together onto the same network connection.
- 2 Classes 0 to 3 do not specify mechanisms to detect unsignalled network transmission failures.

5.4.2 Negotiation

The use of classes and options is negotiated during connection establishment. The choice made by the transport entities will depend upon:

- a) the TS-users' requirements expressed via T-CONNECT service primitives;
- b) the quality of the available network services;
- c) the user required service versus cost ratio acceptable to the TS-user.

5.4.3 Choice of network connection

The following list classifies network services in terms of quality with respect to error behaviour in relation to user requirements; its main purpose is to provide a basis for the decision regarding which class of transport protocol should be used in conjunction with given network connection:

- a) *Type A* – Network connection with acceptable residual error rate (for example, not signalled by disconnect or reset) and acceptable rate of signalled errors.
- b) *Type B* – Network connections with acceptable residual error rate (for example, not signalled by disconnect or reset) but unacceptable rate of signalled errors.
- c) *Type C* – Network connections with unacceptable residual error rate.

It is assumed that each transport entity is aware of the quality of service provided by particular network connections.

5.4.4 Characteristics of class 0

Class 0 provides the simplest type of transport connection and is fully compatible with the Recommendation T.70 for teletex terminals.

Class 0 has been designed to be used with type A network connections.

5.4.5 Characteristics of class 1

Class 1 provides a basic transport connection with minimal overheads.

The main purpose of the class is to recover from network disconnect or reset.

Selection of this class is usually based on reliability criteria. Class 1 has been designed to be used with type B network connections.

5.4.6 Characteristics of class 2**5.4.6.1 General**

Class 2 provides a way to multiplex several transport connections onto a single network connection. This class has been designed to be used with type A network connections.

5.4.6.2 Use of explicit flow control

The objective is to provide flow control to help avoid congestion at transport-connection-end-points and on the network connection. Typical use is when traffic is heavy and continuous, or when there is intensive multiplexing. Use of flow control can optimize response times and resource utilization.

5.4.6.3 Non-use of explicit flow control

The objective is to provide a basic transport connection with minimal overheads suitable when explicit disconnection of the transport connection is desirable. The option would typically be used for unsophisticated terminals, and when no multiplexing onto network connections is required. Expedited data is never available.

5.4.7 Characteristics of class 3

Class 3 provides the characteristics of class 2 plus the ability to recover from network disconnect or reset. Selection of this class is usually based upon reliability criteria. Class 3 has been designed to be used with type B network connections.

5.4.8 Characteristics of class 4

Class 4 provides the characteristics of class 3, plus the capability to detect and recover from errors which occur as a result of the low grade of service available from the NS-provider. The kind of errors to be detected include:

- TPDU loss;
- TPDU delivery out of sequence;
- TPDU duplication; and
- TPDU corruption.

These errors may affect control TPDU's as well as data TPDU's.

This class also provides for increased throughput capability and additional resilience against network failure.

Class 4 has been designed to be used with type C network connections.

5.5 Characteristics of class 4 transport protocol when operating over CLNS

In operation over a connectionless-mode network service the class 4 transport protocol provides flow control between communicating peer transport entities, the capability to detect and recover from errors which occur as a result of a low grade of service available from the NS-provider, and resilience from failure of the peer entity. The kind of errors to be detected include:

- TPDU loss;
- TPDU delivery out of sequence;
- TPDU duplication; and
- TPDU corruption.

These errors may affect control TPDU's as well as data TPDU's.

NOTE – The transport entity is incapable of distinguishing between failure of the network service and failure of the peer entity, except optionally, by some local means, in the case of the failure of the local interface to the network service (e.g. in the failure of the local transceiver on a local area network).

There is no indication given to the transport entity about the ability of the network entity to fulfill the service requirements given in the N-UNIT-DATA primitive. However, it can be a local matter to make transport entities aware of the availability and characteristics (QOS) of connectionless-mode network services, as the corresponding NSAP associations, exist logically by the nature of the connectionless-mode network service and may be recognized by network entities.

5.6 Model of the Transport Layer

A transport entity communicates with its TS-users through one or more TSAPs by means of the service primitives as defined by the transport service definition (see ITU-T Rec. X.214 | ISO/IEC 8072). Service primitives will cause or be the result of transport protocol data unit exchanges between the peer transport entities supporting a transport connection. These protocol exchanges are effected using the services of the Network Layer as defined by the network service definition (see CCITT Rec. X.213 | ISO/IEC 8348) through one or more NSAPs. (See Figure 2.)

Transport connection endpoints are identified in end systems by an internal, implementation dependent, mechanism so that the TS-user and the transport entity can refer to each transport connection.

6 Elements of procedure

This clause contains elements of procedure which are used in the specification of protocol classes in clauses 7 to 12. These elements are not meaningful on their own.

The procedures define the transfer of TPDU's whose structure and coding is specified in clause 13. Transport entities shall accept and respond to any TPDU received in a valid NSDU and may issue TPDU's initiating specific elements of procedure specified in this clause.

NOTE – Where network service primitives, TPDU's and parameters used are not significant for a particular element of procedure, they have not been included in the specification.

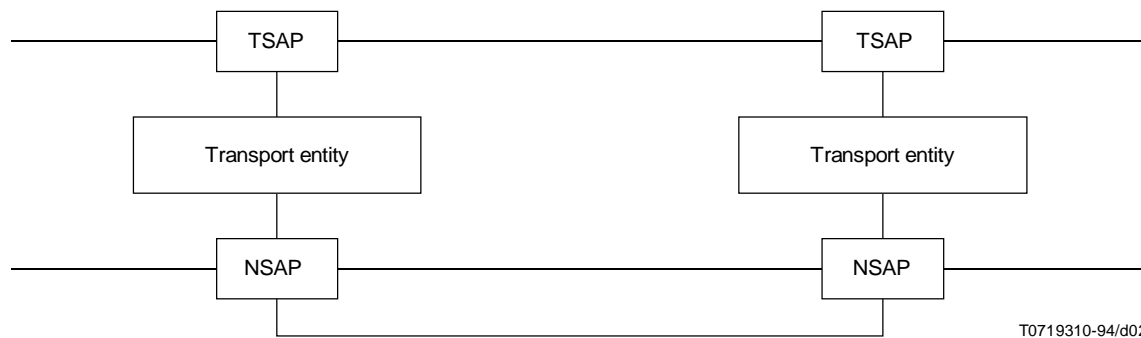

NOTE – For the purposes of illustration, this figure shows only one TSAP and one NSAP for each transport entity. In certain instances, more than one TSAP and/or more than one NSAP may be associated with a particular transport entity.

Figure 2 – Model of the Transport Layer

6.1 Use of the network service

6.1.1 Assignment to network connection when operating over CONS

This procedure is used only when operating over the connection-mode network service.

6.1.1.1 Purpose

The procedure is used in all classes to assign transport connections to network connections.

6.1.1.2 Network service primitives

The procedure uses the following network service primitives:

- a) N-CONNECT;
- b) N-DISCONNECT.

6.1.1.3 Procedure

Each transport connection shall be assigned to a network connection. The initiator may assign the transport connection to an existing network connection of which it is the owner or to a new network connection (see Note 1) which it creates for this purpose.

The initiator shall not assign or reassign the transport connection to an existing network connection if the protocol class(es) proposed for the class in use for the transport connection, (is) (are) incompatible with the current usage of the network connection with respect to multiplexing (see Note 2).

During the resynchronization (see 6.14) and reassignment after failure (see 6.12) procedures, the transport entity may reassign a transport connection to another network connection joining the same NSAPs, provided that it is the owner of the network connection and that the transport connection is assigned to only one network connection at any given time.

During the splitting procedure (see 6.23), a transport entity may assign a transport connection to any additional network connection joining the same NSAPs, provided that it is the owner of the network connection and that either the network connection does not have another transport connection assigned to it or multiplexing is possible on the network connection.

The responder becomes aware of the assignment when it receives:

- a) a CR-TPDU during the connection establishment procedure (see 6.5); or
- b) an RJ-TPDU or a retransmitted CR or DR TPDU during the resynchronization (see 6.14) and reassignment after failure (see 6.12) procedures; or
- c) any TPDU when splitting (see 6.23) is used.

NOTES

1 When a new network connection is created, the quality of service requested is a local matter, although it will normally be related to the requirements of transport connection(s) expected to be assigned to it.

2 An existing network connection may also not be suitable if, for example, the quality of service requested for the transport connection cannot be attained by using or enhancing the network connection.

3 A network connection with no transport connection(s) assigned to it, may be available after initial establishment, or because all of the transport connections previously assigned to it have been released. It is recommended that only the owner of such a network connection should release it. Furthermore, it is recommended that it not be released immediately after the transmission of the final TPDU of a transport connection, either a DR-TPDU in response to CR-TPDU or a DC-TPDU in response to DR-TPDU. An appropriate delay will allow the TPDU concerned to reach the other transport entity allowing the freeing of any resources associated with the transport connection concerned.

4 After the failure of a network connection, transport connections which were previously multiplexed together may be assigned to different network connections, and vice versa.

5 The transport protocol identification procedures specified in Recommendation X.264 may need to be considered in conjunction with this procedure.

6.1.2 Transmission over CLNS

This procedure is used only when operating over the connectionless-mode network service.

6.1.2.1 Purpose

The procedure is used to transmit TPDU's over the connectionless-mode network service.

6.1.2.2 Network service primitives

The procedure makes use of the following network service primitive:

- N-UNIT-DATA.

6.1.2.3 Procedure

Each TPDU shall be transmitted in a single invocation of the connectionless-mode network service, over a pre-existing association between a pair of NSAPs. The association is considered by transport entities as permanently established and available.

6.2 Transport Protocol Data Unit (TPDU) transfer

6.2.1 Purpose

The TPDU transfer procedure is used in all classes to convey transport protocol data units in user data fields of network service primitives.

6.2.2 Network service primitives

The procedure uses the following network service primitives when operating over CONS:

- a) N-DATA;
- b) N-EXPEDITED DATA.

The procedure uses the following network service primitive when operating over CLNS:

- N-UNIT-DATA.

6.2.3 Procedure

The Transport Protocol Data Units (TPDU's) defined for the protocol, are listed in 4.2.

When operating over CLNS, the transport entities shall transmit and receive all TPDU's as NS-user data parameters of N-UNIT-DATA primitives.

When operating over CONS and when the network expedited variant has been selected for class 1, the transport entities shall transmit and receive ED and EA-TPDU's as NS-user data parameters of N-EXPEDITED DATA primitives.

In all other cases, transport entities shall transmit and receive TPDU's as NS-user data parameters of N-DATA primitives.

When a TPDU is put into an NS-user data parameter, the significance of the bits within an octet and the order of octets within a TPDU shall be defined in 13.2.

NOTE – TPDU's may be concatenated (see 6.4).

6.3 Segmenting and reassembling

6.3.1 Purpose

The segmenting and reassembling procedure is used in all classes to map TSDUs onto TPDU.

6.3.2 TPDU and parameter used

The procedure makes use of the following TPDU and parameter:

- DT-TPDU:
 - end of TSDU.

6.3.3 Procedure

A transport entity shall map a TSDU onto an ordered sequence of one or more DT-TPDUs. This sequence shall not be interrupted by other DT-TPDUs on the same transport connection.

All DT-TPDUs except the last DT-TPDU in a sequence greater than one shall have a length of data greater than zero.

NOTES

- 1 The EOT parameter of a DT-TPDU indicates whether or not there are subsequent DT-TPDUs in the sequence.
- 2 There is no requirement that the DT-TPDUs shall be of the maximum length selected during connection establishment.

6.4 Concatenation and separation

6.4.1 Purpose

The procedure for concatenation and separation is used in classes 1, 2, 3 and 4 to convey multiple TPDU in one NSDU.

6.4.2 Procedure

A transport entity may concatenate TPDU from the same or different transport connections, while maintaining the order of TPDU for a given transport connection compatible with the protocol operation.

A valid set of concatenated TPDU may contain:

- a) any number of TPDU from the following list: AK, EA, RJ, ER, DC-TPDU, provided that these TPDU come from different transport connections;
- b) no more than one TPDU from the following list: CR, DR, CC, DT, ED TPDU; if this TPDU is present, it shall be placed last in the set of concatenated TPDU.

A transport entity shall accept a valid set of concatenated TPDU.

NOTES

- 1 The TPDU within a concatenated set may be distinguished by means of the length indicator parameter.
- 2 The end of a TPDU containing data is indicated by the termination of the NSDU.
- 3 When operating over CONS, the number of concatenated TPDU referred to in 6.4.2 a) is bounded by the maximum number of transport connections which are multiplexed together except during assignment or reassignment.

When operating over CLNS, the number of TPDU that may be concatenated is bounded by the number of transport connections established between two NSAPs and/or the maximum available NSDU size.

6.5 Connection establishment

6.5.1 Purpose

The procedure for connection establishment is used in all classes to create a new transport connection.

6.5.2 Network service primitives

When operating over CONS, the procedure uses the following network service primitive:

- N-DATA.

When optionally operating over CLNS, the procedure uses the following network service primitive:

- N-UNIT-DATA.

6.5.3 TPDU's and parameters used

The procedure uses the following TPDU's and parameters:

- a) CR-TPDU:
 - CDT;
 - DST-REF (set to zero);
 - SRC-REF;
 - CLASS and OPTIONS (i.e. preferred class, use of extended format, non-use of explicit flow control in class 2);
 - Calling Transport Selector;
 - Called Transport-Selector;
 - TPDU size (proposed);
 - preferred maximum TPDU size (proposed);
 - version number;
 - protection parameter;
 - checksum;
 - additional option selection (i.e. use of network expedited in class 1, use of receipt confirmation in class 1, non-use of checksum in class 4, use of transport expedited data transfer service, use of selective acknowledgement, use of request acknowledgement, use of non-blocking transport expedited data service);
 - alternative protocol class(es);
 - acknowledgement time;
 - inactivity time;
 - throughput (proposed);
 - residual error rate (proposed);
 - priority (proposed);
 - transit delay (proposed);
 - reassignment time;
 - user data.
- b) CC-TPDU:
 - CDT;
 - DST-REF;
 - SRC-REF;
 - CLASS and OPTIONS (selected);
 - Calling Transport Selector;
 - Responding Transport-Selector;
 - TPDU size (selected);
 - the preferred maximum TPDU size (selected);
 - protection parameter;
 - checksum;
 - additional option selection (selected);
 - acknowledgement time;
 - inactivity time;
 - throughput (selected);
 - residual error rate (selected);

- priority (selected);
- transit delay (selected);
- user data.

6.5.4 Procedure for operating over CONS

A transport connection is established by means of one transport entity (the initiator) transmitting a CR-TPDU to the other transport entity (the responder), which replies with a CC-TPDU.

Before sending the CR-TPDU, the initiator assigns the transport connection being created to one (or more if the splitting procedure is being used) network connection(s). It is this set of network connections over which the TPDU's are sent.

NOTE 1 – Even if the initiator assigns the transport connection to more than one network connection, all the CR-TPDU's (if repeated) or DR-TPDU's with DST-REF set to zero which are sent prior to the receipt of the CC-TPDU shall be sent on the same network connection, unless an N-DISCONNECT indication is received. (This is necessary because the remote entity may not support class 4 and therefore may not recognize splitting.) If the initiator has made other assignments, it will use them only after receipt of a class 4 CC-TPDU (see also the splitting procedure 6.23).

During this exchange, all information and parameters needed for the transport entities to operate shall be exchanged or negotiated.

NOTE 2 – Except in class 4, it is recommended that the initiator start an optional timer TS1 at the time the CR-TPDU is sent. This timer should be stopped when the connection is considered as accepted or refused or unsuccessful. If the timer expires, the initiator should reset or disconnect the network connection, and in classes 1 and 3, freeze the reference (see 6.18). For all other transport connection(s) multiplexed on the same network connection, the procedures for reset or disconnect as appropriate should be followed.

When an unexpected duplicated CR-TPDU is received (with class 4 as preferred class) it shall be ignored in classes 0, 1, 2, and 3 and a CC-TPDU shall be returned in class 4.

After receiving the CC-TPDU for a class which includes the procedure for retention until acknowledgement of TPDU's, the initiator shall acknowledge the CC-TPDU as defined in Table 5 (see 6.13).

When the network expedited variant of the expedited data transfer (see 6.11) has been agreed (possible in class 1 only), the responder shall not send an ED-TPDU before the CC-TPDU is acknowledged.

The following information is exchanged:

- a) *References* – Each transport entity chooses a reference to be used by the peer entity which is 16-bits long and which is arbitrary under the following restrictions:
 - 1) it shall not already be in use nor frozen (see 6.18);
 - 2) it shall not be zero.

This mechanism is symmetrical and provides identification of the transport connection independent of the network connection. The range of references used for transport connections, in a given transport entity, is a local matter.

- b) *Calling, Called and Responding Transport-Selectors (optional)* – When either network address unambiguously defines the transport address, this information may be omitted.
- c) *Initial credit* – Only relevant for classes which include the explicit flow control function.
- d) *User data* – Not available if class 0 is the preferred class (see Note 3). Up to 32 octets in other classes.

NOTE 3 – If class 0 is a valid response according to Table 3, inclusion of user data in the CR-TPDU may cause the responding entity to refuse the connection (for example, if it only supports class 0).
- e) *Acknowledgement time* – Only in class 4.
- f) *Checksum parameter* – Only in class 4.
- g) *Protection parameter* – This parameter and its semantics are user defined.
- h) *Inactivity time* – Only in class 4. The inactivity time parameter shall not be included in a CC-TPDU if it was not present in the corresponding CR-TPDU.

The following negotiations take place:

- i) *Protocol class* – The initiator shall propose a preferred class and may propose any number of alternative classes which permit a valid response as defined in Table 3. The initiator should assume when it sends the CR-TPDU that its preferred class will be agreed to, and commence the procedures associated with that class, except that if class 0 or class 1 is an alternative class, multiplexing shall not commence until a CC-TPDU selecting the use of classes 2, 3 or 4 has been received.

NOTE 4 – This means, for example, that when the preferred class includes resynchronization (see 6.14) the resynchronization will occur if a reset is signalled during connection establishment.

The responder shall select one class defined in Table 3 as a valid response corresponding to the preferred class and to the class(es), if any, contained in the alternative class parameter of the CR-TPDU. It shall indicate the selected class in the CC-TPDU and shall follow the procedures for the selected class.

If the preferred class is not selected, then on receipt of the CC-TPDU, the initiator shall adjust its operation according to the procedures of the selected class.

NOTE 5 – The valid responses indicated in Table 3 result from both explicit negotiation, whereby each of the classes proposed is a valid response, and implicit negotiation whereby:

- if class 3 or 4 is proposed, then class 2 is a valid response;
- if class 1 is proposed, then class 0 is a valid response.

NOTE 6 – Negotiation from class 2 to class 1 and from any class to an higher-numbered class is not valid.

NOTE 7 – Redundant combinations are not a protocol error.

- j) *TPDU size* – The initiator may propose a maximum size for TPDU's, and the responder may accept this value or respond with any value between 128 and the proposed value in the set of values available [see 13.3.4 b)].

NOTE 8 – The length of the CR-TPDU does not exceed 128 octets (see 13.3).

NOTE 9 – The transport entities may have knowledge, by some local means, of the maximum available NSDU size.

- k) *Preferred maximum TPDU size* – The value of this parameter, multiplied by 128, yields the proposed or accepted maximum TPDU size in octets. The initiator may propose a preferred maximum size for TPDU's and the responder may accept this value or respond with a smaller value.

NOTE 10 – If this parameter is used in a CR-TPDU without also including the TPDU size parameter, this will result in a maximum TPDU size of 128 octets being selected if the remote entity does not recognize the preferred TPDU size parameter. Therefore, it is recommended that both parameters be included in the CR-TPDU.

If the preferred maximum TPDU size parameter is present in a CR-TPDU the responder shall either:

- ignore the preferred maximum TPDU size parameter and follow TPDU size negotiation as defined in 6.5.4 j); or
- use the preferred maximum TPDU size parameter to determine the maximum TPDU size requested by the initiator and ignore the TPDU size parameter. In this case the responder shall use the preferred maximum TPDU size parameter in the CC-TPDU and shall not include the TPDU size parameter in the CC-TPDU.

If the preferred maximum TPDU size parameter is not present in the CR-TPDU it shall not be included in the corresponding CC-TPDU. In this case TPDU size negotiation is as defined in 6.5.4 j).

- l) *Normal or extended format* – Either normal or extended is available. When extended is used, this applies to CDT, TPDU-NR, ED-TPDU-NR, YR-TU-NR and YR-EDTU-NR parameters.
- m) *Checksum selection* – This defines whether or not TPDU's of the connection are to include a checksum.
- n) *Quality of service parameters* – This defines the throughput, transit delay, priority and residual error rate.
NOTE 11 – The transport service defines transit delay as requiring a previously stated average TSDU size as a basis for any specification. This protocol as specified in 13.3.4 m), uses a value at 128 octets. Conversion to and from specifications based upon some other value is a local matter.
- o) The non-use of explicit flow control in class 2.
- p) The use of network receipt confirmation and network expedited when class 1 is to be used.
- q) *Use of expedited data transfer service* – This allows both TS-users to negotiate the use or non-use of the expedited data transport service as defined in the transport service (see ITU-T Rec. X.214 | ISO/IEC 8072).
- r) *The use of selective acknowledgement* – This allows the transport entities to decide whether to use procedures that allow acknowledgement of DT-TPDU's that are received out-of-sequence (only in class 4).
- s) *The use of request acknowledgement* – This allows both transport entities to negotiate the use or non-use of the request acknowledgement facility specified in 6.13.4.2 (only in classes 1, 3, 4).
- t) *the use of non-blocking expedited data transfer service* – This allows both transport entities to negotiate the use or non-use of the non-blocking expedited data transfer service (only in class 4). This option will only be valid when the option of “use of expedited data transfer service” is negotiated.

The following information is sent only in the CR-TPDU:

- u) *Version number* – This defines the version of the transport protocol standard used for this connection.
- v) *Reassignment time parameter* – This indicates the time for which the initiator will persist in following the reassignment after failure procedure.

Table 3 – Valid responses corresponding to the preferred class and any alternative class proposed in the CR-TPDU

Preferred class	Alternative class					
	0	1	2	3	4	None
0	Not valid	Not valid	Not valid	Not valid	Not valid	Class 0
1	Class 1 or 0	Class 1 or 0	Not valid	Not valid	Not valid	Class 1 or 0
2	Class 2 or 0	Not valid	Class 2	Not valid	Not valid	Class 2
3	Class 3, 2 or 0	Class 3, 2, 1 or 0	Class 3 or 2	Class 3 or 2	Not valid	Class 3 or 2
4	Class 4, 2 or 0	Class 4, 2, 1 or 0	Class 4 or 2	Class 4, 3 or 2	Class 4 or 2	Class 4 or 2

The negotiation rules for the options are such that the initiator may propose either to use or not to use the option. The responder may either accept the proposed choice or select an alternative choice as defined in Table 4.

When a parameter [which is valid for the proposed class(es)] is absent and a default value is defined in this Recommendation | International Standard, this is equivalent to the presence of the parameter with the default value.

In class 2, whenever a transport entity requests or agrees to the transport expedited data transfer service or to the use of extended formats, it shall also request or agree (respectively) to the use of explicit flow control.

Table 4 – Negotiation of options during connection establishment

Option	Proposal made by the initiator	Valid selection by the responder
Transport expedited data transfer service (classes 1, 2, 3, 4 only)	Yes No	Yes or No No
Use of receipt confirmation (class 1 only)	Yes No	Yes or No No
Use of the network expedited variant (class 1 only)	Yes No	Yes or No No
Non-use of checksum (class 4 only)	Yes No	Yes or No No
Non-use of explicit flow control (class 2 only)	Yes No	Yes or No No
Use of extended format (classes 2, 3, 4 only)	Yes No	Yes or No No
Use of selective acknowledgement (class 4 only)	Yes No	Yes or No No
Use of request acknowledgement (classes 1, 3, 4 only)	Yes No	Yes or No No
Use of non-blocking expedited data transfer service (class 4 only)	Yes No	Yes or No No
NOTE – This table defines the procedures for negotiation of options. This negotiation has been designed such that if the initiator proposes the mandatory implementation option specified in clause 14, the responder has to accept use of this option over the transport connection except for the use of the transport expedited data transfer service which may be rejected by the TS-user. If the initiator proposes a non-mandatory implementation option, the responder is entitled to select use of the mandatory implementation option for use over the transport connection.		

6.5.5 Procedure for operating over CLNS

A transport connection is established by means of one transport entity (the initiator) transmitting a CR-TPDU to the other transport entity (the responder), which replies with a CC-TPDU. During this exchange, all information and parameters needed for the transport entities to operate shall be exchanged or negotiated. When an unexpected duplicated CR-TPDU is received (with class 4 as preferred class) a CC-TPDU shall be returned.

After receiving the CC-TPDU, the initiator shall acknowledge the CC-TPDU as defined in Table 5 (see 6.13).

NOTE 1 – If the initiator does not receive any response from the remote entity, it may choose to use the procedure for operating over CONS (see 6.5.4). This is a local matter.

The following information is exchanged:

- a) *References* – Each transport entity chooses a reference to be used by the peer entity which is 16-bits long and which is arbitrary under the following restrictions:
 - 1) it shall not already be in use nor frozen (see 6.18);
 - 2) it shall not be zero.

This mechanism is symmetrical and provides identification of the transport connection itself. The range of references used for transport connections, in a given transport entity, is a local matter.
- b) *Calling, Called and Responding Transport-Selectors* (optional) – Indicates the calling and called transport service access points. When either network address unambiguously defines the transport address, this information may be omitted.
- c) *Initial credit*.
- d) *User data* – Up to 32 octets.
- e) *Acknowledgment time*.
- f) *Checksum parameter*.
- g) *Protection parameter* – This parameter and its semantics are user defined.
- h) *Inactivity time* – The inactivity time parameter shall not be included in a CC-TPDU if it was not present in the corresponding CR-TPDU.
- i) *Protocol class* – Class 4 is the only valid value for the preferred protocol class proposed by the initiator, and for the class selected by the responder. An alternative class shall not be present.

The following negotiations take place:

- j) *TPDU size* – The initiator may propose a maximum size for TPDU in the set of values available [see 13.3.4 b)]. This value may be limited by the maximum available NSDU size if known, and cannot exceed the maximum NSDU size for connectionless-mode network service as defined in CCITT Rec. X.213 | ISO/IEC 8348. The responder may accept this value or respond with any value between 128 and the proposed value in the set of values available [see 13.3.4 b)].

NOTE 2 – The length of the CR-TPDU does not exceed 128 octets (see 13.3).

NOTE 3 – The transport entities may have knowledge, by some local means, of the maximum available NSDU size.

- k) *Preferred maximum TPDU size* – The value of this parameter, multiplied by 128, yields the proposed or accepted maximum TPDU size in octets. The initiator may propose a preferred maximum size for TPDU and the responder may accept this value or respond with a smaller value.

NOTE 4 – If this parameter is used in a CR-TPDU without also including the TPDU size parameter, this will result in a maximum TPDU size of 128 octets being selected if the remote entity does not recognize the preferred TPDU size parameter. Therefore, it is recommended that both parameters be included in the CR-TPDU.

If the preferred maximum TPDU size parameter is present in a CR-TPDU the responder shall either:

- ignore the preferred maximum TPDU size parameter and follow TPDU size negotiation as defined in 6.5.5 j); or
- use the preferred maximum TPDU size parameter to determine the maximum TPDU size requested by the initiator and ignore the TPDU size parameter. In this case the responder shall use the preferred maximum TPDU size parameter in the CC-TPDU and shall not include the TPDU size parameter in the CC-TPDU.

If the preferred maximum TPDU size parameter is not present in the CR-TPDU it shall not be included in the corresponding CC-TPDU. In this case TPDU size negotiation is as defined in 6.5.5 j).

- l) *Normal or extended format* – Either normal or extended is available. When extended is used, this applies to CDT, TPDU-NR, ED-TPDU-NR, YR-TU-NR and YR-EDTU-NR parameters.
- m) *Checksum selection* – This defines whether or not TPDU's of the connection are to include a checksum.
- n) *Quality of service parameters* – This defines the throughput, transit delay, priority and residual error rate.
NOTE 5 – The transport service defines transit delay as requiring a previously stated average TSDU size as a basis for any specification. This protocol as specified in 13.3.4 m), uses a value at 128 octets. Conversion to and from specifications based upon some other value is a local matter.
- o) *Use of expedited data transfer service* – This allows both TS-users to negotiate the use or non-use of the expedited data transport service as defined in the transport service (see ITU-T Rec. X.214 | ISO/IEC 8072).
- p) *The use of non-blocking expedited data transfer service* – This allows both transport entities to negotiate the use or non-use of the non-blocking expedited data transfer service (only in class 4). This option will only be valid when the option of “use of expedited data transfer service” is negotiated.
- q) *The use of selective acknowledgement* – This allows the transport entities to decide whether to use procedures that allow acknowledgement of DT-TPDU's that are received out-of-sequence.
- r) *The use of request acknowledgement* – This allows both transport entities to negotiate the use or non-use of the request acknowledgement facility specified in 6.13.4.3.

The following information is sent only in the CR-TPDU:

- s) *Version number* – This defines the version of the transport protocol standard used for this connection.

6.6 Connection refusal

6.6.1 Purpose

The connection refusal procedure is used in all classes when a transport entity refuses a transport connection in response to a CR-TPDU.

6.6.2 TPDU's and parameters used

The procedure uses the following TPDU's and parameters:

- a) DR-TPDU:
 - SRC-REF;
 - reason;
 - user data;
- b) ER-TPDU:
 - reject cause;
 - invalid TPDU.

6.6.3 Procedure

If a transport connection cannot be accepted, the responder shall respond to the CR-TPDU with a DR-TPDU. The reason shall indicate why the connection was not accepted. The source reference field in the DR-TPDU shall be set to zero to indicate an unassigned reference.

If a DR-TPDU is received, the initiator shall regard the connection as released.

The responder shall respond to an invalid CR-TPDU by sending an ER or DR-TPDU. If an ER-TPDU is received in response to a CR-TPDU, the initiator shall regard the connection as released.

NOTES

- 1 When the invalid CR-TPDU can be identified as having class 0 as the preferred class, it is recommended to respond with an ER-TPDU. For all other invalid CR-TPDU's either an ER-TPDU or DR-TPDU may be sent.
- 2 If the optional supervisory timer TS1 has been set for this connection, then the initiator should stop the timer on receipt of the DR or ER-TPDU.
- 3 It is a local matter whether the initiator releases the network connection if no transport connections are now assigned to it.

6.7 Normal release

6.7.1 Normal release when operating over CONS

6.7.1.1 Purpose

The release procedure is used by a transport entity in order to terminate a transport connection. The implicit variant is used only in class 0. The explicit variant is used in classes 1, 2, 3 and 4.

NOTES

1 When the implicit variant is used (i.e. in class 0), the lifetime of the transport connection is directly correlated with the lifetime of the network connection.

2 The use of the explicit variant of the release procedure enables the transport connection to be released independently of the underlying network connection.

6.7.1.2 Network service primitives

The procedure uses the following network service primitives:

- a) N-DISCONNECT;
- b) N-DATA.

6.7.1.3 TPDU and parameters used

The procedure uses the following TPDU and parameters:

- a) DR-TPDU:
 - reason;
 - user data;
 - SRC-REF;
 - DST-REF;
- b) DC-TPDU.

6.7.1.4 Procedure for implicit variant

In the implicit variant either transport entity disconnects a transport connection by disconnecting the network connection to which it is assigned. When a transport entity receives an N-DISCONNECT this should be considered as the release of the transport connection.

6.7.1.5 Procedure for explicit variant

When the release of a transport connection is to be initiated, a transport entity:

- a) If it has previously sent or received a CC-TPDU (see Note 3) shall:
 - 1) send a DR-TPDU;
 - 2) discard all subsequently received TPDU's other than a DR, DC or ER-TPDU;
 - 3) consider the transport connection released on receipt of a DR, DC or ER-TPDU.
- b) If a) is not applicable and if there is an outstanding CR-TPDU, it shall:
 - 1) For classes other than class 4 wait for the acknowledgement of the outstanding CR-TPDU; if it receives a CC-TPDU, it shall follow the procedures in 6.7.1.5 a).
 - 2) For class 4 either send a DR-TPDU with a zero value in the DST-REF field or follow the procedure in 6.7.1.5 b) 1). In the former case further receipt of a CC-TPDU specifying class 4 will be ignored. Receipt of CC-TPDU with another class will be processed as follows: if the class is 0, the network connection shall be disconnected, otherwise a DR-TPDU with the DST-REF field set to the value of the SRC-REF field of the received CC-TPDU shall be sent and the release procedure of the class is continued.

A transport entity that receives a DR-TPDU shall:

- c) If it has previously sent a DR-TPDU for the same transport connection, consider the transport connection released.
- d) If it has previously sent a CR-TPDU that has not been acknowledged by a CC-TPDU, consider the connection refused (see 6.6). If the SRC-REF is not zero a DC-TPDU shall be sent using the SRC-REF as the DST-REF.

NOTE 1 – In this case, the DR has been associated regardless of its SRC-REF field (see 6.9.1.4 and 6.9.2.4).

- e) If c) and d) are not applicable, send a DC-TPDU and consider the transport connection released. If the received DR has the DST-REF field set to zero, then a DC with SRC-REF set to zero shall be sent, regardless of the local reference.

NOTE 2 – If the entity receiving such a DR-TPDU has previously decided to negotiate down the class, this entity is always entitled to consider such a DR-TPDU as spurious. Since no association has been made the transport connection is not released at the responder side but the CC-TPDU, when sent, will be answered by a DR-TPDU (spurious CC-TPDU).

NOTE 3 – This requirement ensures that the transport entity is aware of the remote reference for the transport connection.

NOTE 4 – When the transport connection is considered as released, the local reference is either available for re-use or is frozen (see 6.18).

NOTE 5 – After the release of a transport connection, the network connection can be released or retained to enable its re-use for the assignment of other transport connections (see 6.1.1).

NOTE 6 – Except in class 4, it is recommended that, if a transport entity does not receive acknowledgement of a DR-TPDU within time TS2, it should either reset or disconnect the network connection, and freeze the reference when appropriate (see 6.18). For all other transport connection(s) multiplexed on this network connection, the procedures for reset or disconnect as appropriate should be followed.

NOTE 7 – When a transport entity is waiting for a CC-TPDU before sending a DR-TPDU and the network connection is reset or released, it should consider the transport connection released and, in classes other than classes 0 and 2, freeze the reference (see 6.18).

6.7.2 Normal release when operating over CLNS

6.7.2.1 Purpose

The release procedure is used by a transport entity in order to terminate a transport connection.

6.7.2.2 Network service primitives

The procedures makes use of the following network service primitive:

- N-UNIT-DATA.

6.7.2.3 TPDU and parameters used

The procedure uses the following TPDU and parameters:

- a) DR-TPDU:
 - reason;
 - user data;
 - SRC-REF;
 - DST-REF;
- b) DC-TPDU.

6.7.2.4 Procedure

When the release of a transport connection is to be initiated, a transport entity shall send a DR-TPDU and shall discard all subsequently received TPDU except for a DR or a DC-TPDU.

On the receipt of a DR or a DC-TPDU, it shall consider the transport connection to be released and the local reference shall be frozen (see 6.18). If a CC-TPDU has been previously sent or received by the transport connection, then the remote reference is known and shall be used for the DST-REF in the DR-TPDU to be sent. If the remote reference is not known, then the DST-REF in the DR-TPDU may be set to zero, or the entity may wait until a CC-TPDU is received before sending the DR-TPDU.

NOTE – In case that the entity decides to wait for the arrival of the CC-TPDU for the connection, deadlock could result from a CC-TPDU that never arrives. Such a deadlock is prevented by the expiration of the CR-TPDU retransmission counter, which forces the DR-TPDU to be sent.

ISO/IEC 8073 : 1997 (E)

A transport entity which receives a DR-TPDU shall:

- a) Consider the transport connection to be released if it has previously sent a DR-TPDU for that connection.
- b) Consider the transport connection to be refused (see 6.6) if it has previously sent a CR-TPDU for that connection and no CC-TPDU has been received in acknowledgment.
- c) Consider the transport connection to be released and send a DC-TPDU in all other cases. If the received DR-TPDU has the DST-REF field set to zero, then a DC-TPDU with SRC-REF set to zero shall be sent, regardless of the local reference.

6.8 Error release when operating over CONS

6.8.1 Purpose

This procedure is used only in classes 0 and 2 to release a transport connection on the receipt of an N-DISCONNECT or N-RESET indication.

6.8.2 Network service primitives

The procedure uses the following service primitives:

- a) N-DISCONNECT request;
- b) N-DISCONNECT indication;
- c) N-RESET indication;
- d) N-RESET response.

6.8.3 Procedure

When, on the network connection to which a transport connection is assigned, an N-DISCONNECT or N-RESET indication is received, both transport entities shall consider that the transport connection is released and so inform the TS-users.

On receipt of an N-RESET indication:

- In class 0, an N-DISCONNECT request shall be issued.
- In class 2, it is a local choice to issue an N-RESET response or an N-DISCONNECT request; one of these primitives shall be issued. However, if the Network Connection has other Transport Connections of a different class assigned to it, the error recovery procedure of that class shall be used to determine which primitive is issued.

6.9 Association of TPDU's with transport connections

6.9.1 Association of TPDU's with transport connections when operating over CONS

6.9.1.1 Purpose

This procedure is used in all classes to interpret a received NSDU as TPDU(s) and, if possible, to associate each such TPDU with a transport connection.

6.9.1.2 Network service primitives

The procedure uses the following network service primitives:

- a) N-DATA indication;
- b) N-EXPEDITED DATA indication;
- c) N-RESET request;
- d) N-DISCONNECT request.

6.9.1.3 TPDU's and parameters used

The procedure uses the following TPDU's and parameters:

- a) any TPDU except CR-TPDU, DT-TPDU in classes 0 or 1 and AK-TPDU in class 1:
 - DST-REF;

- b) CR, CC, DR and DC-TPDUs:
 - SRC-REF;
- c) DT-TPDU in classes 0 or 1 and AK-TPDU in class 1.

6.9.1.4 Procedures

6.9.1.4.1 Identification of TPDU

If the received NSDU or expedited NSDU cannot be decoded (i.e. does not contain one or more correct TPDU) or is corrupted (i.e. contains a TPDU with a wrong checksum), then the transport entity shall:

- a) if the network connection on which the error is detected has a class 0 or 1 transport connection assigned to it, treat as a protocol error (see 6.22) for that transport connection;
- b) otherwise:
 - 1) if the NSDU can be decoded but contains corrupted TPDU, discard the TPDU (class 4 only) and optionally apply 6.9.1.4.1 b) 2);
 - 2) if the NSDU cannot be decoded, issue an N-RESET or N-DISCONNECT request for the network connection and for all the transport connections assigned to this network connection (if any), apply the procedures defined for handling of network signalled reset or disconnect.

If the NSDU can be decoded and is not corrupted, the transport entity shall:

- a) if the network connection on which the NSDU was received has a class 0 transport connection assigned to it, consider the NSDU as forming one TPDU and associate the TPDU with the transport connection (see 6.9.1.4.2);
- b) otherwise, invoke the separation procedures and for each of the individual TPDU in the order in which they appear in the NSDU apply the procedure defined in 6.9.1.4.2.

6.9.1.4.2 Association of individual TPDU

If the received TPDU is a CR-TPDU, and if the SRC-REF parameter and the remote NSAP indicate an existing transport connection at that receiving entity, then the CR-TPDU is associated with that transport connection, otherwise it is processed as requesting the creation of a new transport connection. However, if the Network connection already has assigned a class 0 or class 1 Transport connection, then, if the second CR that is the retransmitted TPDU of class 4 has arrived, discard it and keep the first Transport connection, otherwise (i.e. arrived CR-TPDU is not a retransmitted TPDU of class 4) disconnect the Network connection.

If the received TPDU is a DT-TPDU and the network connection has no TC assigned to it, and the DT-TPDU is a class 0 or class 1 TPDU (as recognized by the absence of a DST-REF field), then the TPDU should be ignored.

If the received TPDU is a DT-TPDU and the network connection has a class 0 or 1 transport connection assigned to it, or an AK-TPDU where a class 1 transport connection is assigned, then the TPDU is associated with the transport connection.

Otherwise, the DST-REF parameter of the TPDU is used to identify the transport connection. The following cases are distinguished:

- a) If the DST-REF is not allocated to a transport connection, then no association with a transport connection is made and there are three cases:
 - 1) If the TPDU is a CC-TPDU the transport entity shall respond on the same network connection with a DR-TPDU. The SRC-REF of the DR-TPDU may be either 0 or the DST-REF from the received CC-TPDU.
 - 2) If the TPDU is a DR-TPDU, the transport entity shall respond on the same network connection with a DC-TPDU, except in the case that the DR is carrying an SRC-REF set to zero, then no DC-TPDU shall be sent, or in the case where the transport entity only supports class 0, then the network connection shall be disconnected.
 - 3) If the TPDU is neither a CC nor a DR it shall be discarded.
- b) If the DST-REF is allocated to a transport connection, but the TPDU is received on a network connection to which this connection has not been assigned, then there are four cases:
 - 1) If the transport connection is of class 4 and if the TPDU is received on a network connection with the same pair of NSAPs as that of the CR-TPDU, then the TPDU is associated with this transport connection and considered as performing assignment.

- 2) If the transport connection is not assigned to any network connection (waiting for reassignment after failure) and if the TPDU is received on a network connection with the same pair of NSAPs as that of the CR-TPDU, then the association with that transport connection is made, except in the case of DC, DR and CC-TPDUs which are respectively described in 6.9.1.4.2 c), d) and e).
 - 3) In classes 1 and 3, it is also possible to receive a TPDU performing reassignment prior to the notification of the disconnect of the current network connection (i.e. the transport connection is assigned to a network connection, but a TPDU containing the appropriate DST-REF is received on another network connection). In this case it is recommended that the transport entity:
 - issue an N-DISCONNECT request on the network connection to which the transport connection is currently assigned;
 - apply to all transport connections assigned to this network connection the procedure for processing a received N-DISCONNECT indication; and
 - then process the TPDU performing reassignment.
 - 4) Otherwise, the TPDU is considered as having a DST-REF not allocated to a transport connection [case a)].
- c) If the TPDU is a DC-TPDU, then it is associated with the transport connection to which the DST-REF is allocated, unless the SRC-REF is not the expected one, in which case the DC-TPDU is discarded.
- d) If the TPDU is a DR-TPDU, then there are four cases:
- 1) if the SRC-REF is not as expected, then a DC-TPDU with DST-REF equal to the SRC-REF of the received DR-TPDU is sent back and no association is made, except that in the case where the transport entity only supports class 0 and cannot transmit a DC-TPDU, it disconnects the network connection instead of transmitting a DC-TPDU;
 - 2) if a CR-TPDU is unacknowledged, then the DR-TPDU is associated with the transport connection, regardless of the value of its SRC-REF parameter;
 - 3) if the transport entity implements class 4 and if the DST-REF is zero and there is an unacknowledged CC-TPDU or T-CONNECT response is awaited, then the DR-TPDU shall be associated with the transport connection holding the SRC-REF as the remote reference;
 - 4) otherwise, the DR-TPDU is associated with the transport connection identified by the DST-REF parameter.
- e) If the TPDU is a CC-TPDU whose DST-REF parameter identifies an open connection (one for which a CC-TPDU has been previously received), and the SRC-REF in the CC-TPDU does not match the remote reference, then a DR-TPDU is sent back with DST-REF equal to the SRC-REF of the received CC-TPDU and no association is made.
- f) If none of the above cases apply, then the TPDU is associated with the transport connection identified by the DST-REF parameter.

6.9.2 Association of TPDUs with transport connections when operating over CLNS

6.9.2.1 Purpose

This procedure is used to interpret a received NSDU as TPDU(s) and, if possible, to associate each such TPDU with a transport connection.

6.9.2.2 Network service primitives

This procedure makes use of the following network service primitive:

- N-UNIT-DATA.

6.9.2.3 TPDUs and parameters used

This procedure makes use of the following TPDUs and parameters:

- a) all TPDUs except CR-TPDU:
 - DST-REF.
- b) CR, CC, DR and DC-TPDUs:
 - SRC-REF.

6.9.2.4 Procedures

6.9.2.4.1 Identification of TPDU

If the received NSDU cannot be decoded (i.e. does not contain one or more correct TPDU) or is corrupted (i.e. contains a TPDU with a wrong checksum), then the transport entity shall ignore (discard) the TPDU. If the NSDU can be decoded and is not corrupted, the transport entity shall invoke the separation procedures and for each of the individual TPDU in the order in which they appear in the NSDU, apply the procedure in 6.9.2.4.2.

6.9.2.4.2 Association of individual TPDU

Association of a received TPDU with a transport connection is generally performed by attempting to match the DST-REF in the received TPDU and the NSAP pair over which it was received with those of an existing transport connection. There are three exceptions to this general procedure: when the received TPDU is a CR-TPDU, the SRC-REF is used instead of the DST-REF; when the received TPDU is either a DR or a DC-TPDU, the SRC-REF is used in addition to the DST-REF and when the received TPDU is a CC-TPDU, whose DST-REF parameter identifies an open connection (one for which a CC-TPDU has been previously received), then the SRC-REF is used in addition to the DST-REF.

The following actions shall be taken in consequence to the inability to match the TPDU to an existing transport connection:

- a) for a CR-TPDU, a new transport connection shall be created;
- b) for a CC-TPDU, a DR-TPDU shall be sent using the SRC-REF and DST-REF from the received CC-TPDU as the DST-REF and SRC-REF, respectively, of the DR-TPDU;
- c) for a DR-TPDU, there are four cases:
 - 1) if a CR-TPDU is unacknowledged for the connection identified by the DST-REF in the DR-TPDU, then the DR-TPDU is associated with that connection regardless of the SRC-REF in the DR-TPDU;
 - 2) if the CR-TPDU for the connection identified by the DST-REF of the DR-TPDU has been acknowledged and the SRC-REF is not as expected, then a DC-TPDU using the SRC-REF of the DR-TPDU as DST-REF is sent and no association is made;
 - 3) if the DST-REF in the DR-TPDU is zero and there is an unacknowledged CC-TPDU or a T-CONNECT response is awaited for a transport connection holding remote reference equal to the SRC-REF of the DR-TPDU, then the DR-TPDU is associated with that transport connection;
 - 4) in all other situations, the DR-TPDU is associated with the transport connection identified by the DST-REF of the DR-TPDU;
- d) for all other TPDU types, the TPDU is discarded.

6.10 Data TPDU numbering

6.10.1 Purpose

Data TPDU numbering is used in classes 1, 2 (except when the non-use of explicit flow control option is selected), 3 and 4. Its purpose is to enable the use of recovery, flow control and resequencing functions.

6.10.2 TPDU and parameters used

The procedure uses the following TPDU and parameter:

- DT-TPDU:
 - TPDU-NR.

6.10.3 Procedure

A transport entity shall allocate the sequence number zero to the TPDU-NR of the first DT-TPDU which it transmits for a transport connection. For subsequent DT-TPDU sent on the same transport connection, the transport entity shall allocate a sequence number one greater than the previous one.

When a DT-TPDU is retransmitted, the TPDU-NR parameter shall have the same value as in the first transmission of that DT-TPDU.

ISO/IEC 8073 : 1997 (E)

Modulo 2^7 arithmetic shall be used when normal formats have been selected and modulo 2^{31} arithmetic shall be used when extended formats have been selected. In this Recommendation | International Standard the relationships “greater than” and “less than” apply to a set of contiguous TPDU numbers whose range is less than the modulus and whose starting and finishing numbers are known. The term “less than” means “occurring sooner in the window sequence” and the term “greater than” means “occurring later in the window sequence”.

6.11 Expedited data transfer

6.11.1 Expedited data transfer when operating over CONS

6.11.1.1 Purpose

Expedited data transfer procedures are selected during connection establishment. The network normal data variant may be used in classes 1, 2, 3 and 4. The network expedited variant is only used in class 1.

6.11.1.2 Network service primitives

The procedure uses the following network service primitives:

- a) N-DATA;
- b) N-EXPEDITED DATA.

6.11.1.3 TPDUs and parameters used

The procedure uses the following TPDUs and parameters:

- a) ED-TPDU:
 - ED-TPDU-NR;
- b) EA-TPDU:
 - YR-EDTU-NR.

6.11.1.4 Procedures

The TS-user data parameter of each T-EXPEDITED DATA request shall be conveyed as the data field of an Expedited Data (ED) TPDU.

Each ED-TPDU received shall be acknowledged by an Expedited Acknowledge (EA) TPDU.

No more than one ED-TPDU shall remain unacknowledged at any time for each direction of a transport connection.

An ED-TPDU with a zero length data field shall be treated as a protocol error.

NOTES

1 The network normal data variant is used, except when the network expedited variant (available in class 1 only), has been agreed, in which case ED and EA-TPDUs are conveyed in the data fields of N-EXPEDITED DATA primitives (see 6.2.3).

2 No TPDU can be transmitted using the network expedited variant until the CC-TPDU becomes acknowledged, to prevent the network expedited variant from overtaking the CC-TPDU.

6.11.2 Expedited data transfer when operating over CLNS

6.11.2.1 Purpose

Expedited data transfer procedures are selected during connection establishment.

6.11.2.2 Network service primitives

The procedure makes use of the following network service primitive:

- N-UNIT-DATA.

6.11.2.3 TPDUs and parameters used

The procedure makes use of the following TPDUs and parameters:

- a) ED-TPDU:
 - ED-TPDU-NR;

- b) EA-TPDU:
 - YR-EDTU-NR.

6.11.2.4 Procedures

The TS-user data parameter of each T-EXPEDITED DATA request shall be conveyed as the data field of an Expedited Data (ED) TPDU.

Each ED-TPDU received shall be acknowledged by an Expedited Acknowledge (EA) TPDU.

No more than one ED-TPDU shall remain unacknowledged at any time for each direction of a transport connection.

An ED-TPDU with a zero length data field shall be treated as a protocol error (see 6.22).

6.12 Reassignment after failure when operating over CONS

6.12.1 Purpose

The reassignment after failure procedure is used in classes 1 and 3 to commence recovery from an NS-provider signalled disconnect.

6.12.2 Network service primitives

The procedure uses the following network service primitive:

- N-DISCONNECT indication.

6.12.3 Procedure

When an N-DISCONNECT indication is received for the network connection to which a transport connection is assigned, the initiator shall apply one of the following alternatives:

- a) If the TTR timer has not already run out and no DR-TPDU is retained:
 - 1) assign the transport connection to a different network connection (see 6.1.1) and start its TTR timer if not already started;
 - 2) while waiting for the completion of assignment if:
 - an N-DISCONNECT indication is received, repeat the procedure from 6.12.3 a);
 - the TTR timer expires, begin procedure 6.12.3 b);
 - 3) when reassignment is complete perform active resynchronization by executing the procedure described in 6.14.4.1, and, if 6.14.4.1 b) has been performed, wait for the next event as follows:
 - if a valid TPDU is received as the result of the resynchronization, stop the TTR timer; or
 - if TTR runs out, wait for the next event; or
 - if an N-DISCONNECT indication is received, begin either procedure 6.12.3 a) or 6.12.3 b) depending on the TTR timer.

NOTE – After TTR expires and while waiting for the next event, it is recommended that the initiator set a timer with a value equal to TWR. If this timer expires before the next event, the initiator should begin the procedure in 6.12.3 b).
- b) If the TTR timer has run out, consider the transport connection as released and freeze the reference (see 6.18).
- c) If a DR-TPDU is retained and the TTR timer has not run out, then follow the actions in either 6.12.3 a) or 6.12.3 b).

The responder shall start its TWR timer if not already started. The arrival of the first TPDU related to the transport connection (because of resynchronization by the initiator) completes the reassignment after failure procedure. The TWR timer is stopped and the responder shall continue with resynchronization (see 6.14). If reassignment does not take place within this time, the transport connection is considered released and the reference is frozen (see 6.18).

6.12.4 Timers

The reassignment after failure procedure uses two timers:

- a) TTR, the time to try reassignment/resynchronization timer;
- b) TWR, the time to wait for reassignment/ resynchronization timer.

ISO/IEC 8073 : 1997 (E)

The TTR timer is used by the initiator. Its value shall not exceed 2 minutes minus the sum of the maximum disconnect propagation delay and the maximum transit delay of the network connections (see Note 1). The value for the TTR timer may be indicated in the CR-TPDU.

The TWR timer is used by the responder. If the reassignment time parameter is present in the CR-TPDU, the TWR timer value shall be greater than the sum of the TTR timer plus the maximum disconnect propagation delay plus the maximum transit delay of the network connections.

If the reassignment time parameter is not present in the CR-TPDU, a default value of 2 minutes shall be used for the TWR timer.

NOTES

- 1 Provided that the required quality of service is met, TTR may be set to zero (i.e. no reassignment). This may be done, for example, if the rate of NS-provider generated disconnects is very low.
- 2 Inclusion of the reassignment time parameter in the CR-TPDU allows the responder to use a TWR value of less than 2 minutes.
- 3 If the optional TS1 and TS2 timers are used, it is recommended:
 - a) to stop TS1 or TS2 if running when TTR or TWR is started;
 - b) to restart TS1 or TS2 if necessary when the corresponding TPDU (CR-TPDU or DR-TPDU respectively) is repeated;
 - c) to select for TS1 and TS2 values greater than TTR.

6.13 Retention and acknowledgement of TPDU's

6.13.1 Purpose

The retention and acknowledgement of TPDU's procedure is used in classes 1, 3 and 4 to enable and minimize retransmission after possible loss of TPDU's.

The confirmation of receipt variant is used only in class 1 when it has been agreed during connection establishment (see the Note).

The AK variant is used in classes 3 and 4 and also in class 1 when the confirmation of receipt variant has not been agreed during connection establishment. In addition, in class 4, the option of using selective acknowledgement may be agreed to during connection establishment.

The request acknowledgement procedure is selected during connection establishment and may be used in classes 3 and 4, and in class 1 when the confirmation of receipt variant has not been agreed during connection establishment. It allows a transport entity to request acknowledgement of retained DT-TPDU's by setting the ROA parameter in a transmitted DT-TPDU.

NOTE – Use of the confirmation of receipt variant depends on the availability of the network layer receipt confirmation service and the expected cost reduction.

6.13.2 Network service primitives

When operating over CONS, the procedure uses the following network service primitives:

- a) N-DATA;
- b) N-DATA ACKNOWLEDGE.

When operating over CLNS, the procedure uses the following network service primitive:

- N-UNIT-DATA.

6.13.3 TPDU's and parameters used

The procedure uses the following TPDU's and parameters:

- a) CR, CC, DR and DC-TPDU's;
- b) AK-TPDU:
 - YR-TU-NR;
 - selective acknowledgement parameters;
- c) RJ-TPDU:
 - YR-TU-NR;

- d) DT-TPDU:
 - TPDU-NR;
- e) ED-TPDU:
 - ED-TPDU-NR;
- f) EA-TPDU:
 - YR-EDTU-NR.

6.13.4 Procedures

6.13.4.1 Retention until acknowledgement of TPDU

Copies of the following TPDU shall be retained upon transmission to permit their later retransmission:

- CR, CC, DR, DT and ED-TPDUs,

except in the following case: if a DR-TPDU is sent in response to a CR-TPDU there is no need to retain a copy of the DR-TPDU.

A copy of each of these TPDU shall be retained until:

- a) it is acknowledged, as specified in Table 5; or
- b) the transport connection is released.

Table 5 – Acknowledgement of TPDU

Retained TPDU	Variant	Retained until acknowledged by:
CR	Both	CC, DR or ER-TPDU.
DR	Both	DC or DR (in case of collision) TPDU.
CC	Confirmation of receipt variant	N-DATA ACKNOWLEDGE indication, RJ, DT, EA or ED-TPDU.
CC	AK variant	RJ, DT, AK, ED or EA-TPDU.
DT	Confirmation of receipt variant	N-DATA ACKNOWLEDGE indication corresponding to an N-DATA request which conveyed, or came after, the DT-TPDU.
DT	AK variant	AK or RJ-TPDU for which the YR-TU-NR is greater than TPDU-NR in the DT-TPDU. In case of selective acknowledgement, if the selective acknowledgement parameters in the AK TPDU include the TPDU-NR of the DT-TPDU.
ED	Both	EA-TPDU for which the YR-EDTU-NR is equal to the ED-TPDU-NR in the ED-TPDU.

6.13.4.2 Confirmation of receipt variant

In the confirmation of receipt variant, applicable only in class 1, transport entities shall:

- a) set the confirmation request parameter only if the data parameter contains a CC or DT-TPDU (see Notes 1 and 2 in 6.13.4.4);
- b) issue an N-DATA ACKNOWLEDGE request when it receives an N-DATA indication with the confirmation request parameter set.

6.13.4.3 Request of acknowledgement option

If the request acknowledgement procedure has been negotiated, transport entities:

- a) may request acknowledgement of retained DT-TPDUs by setting the ROA parameter in a transmitted DT-TPDU. The decision as to when the sending transport entity should request acknowledgement is a local matter (see Note 4 in 6.13.4.4);
- b) on receipt of a DT-TPDU with the ROA parameter set shall transmit an AK-TPDU containing up-to-date window information.

6.13.4.4 Selective acknowledgement option

If the selective acknowledgement option has been negotiated, transport entities:

- a) May include selective acknowledgement parameters in a transmitted AK-TPDU. These selective acknowledgement parameters, if included, shall contain acknowledgement of blocks of TPDU's not acknowledged by the YR-TU-NR field of the AK-TPDU. This procedure allows transport entities to acknowledge DT-TPDU's that are within the window but that are not in sequence.
- b) On receipt of an AK-TPDU containing selective acknowledgement parameter(s) shall discard the DT-TPDU's specified.

NOTES (Notes 1 to 3 only apply when operating over CONS)

1 It is a local matter for each transport entity to decide which N-DATA requests should have the confirmation request parameter set. This decision will normally be related to the amount of storage available for retained copies of the DT-TPDU's.

2 Use of the confirmation request parameter may affect the quality of network service.

3 In class 3, and in class 1, when use of explicit AK variant is selected, if a transport entity does not send an AK-TPDU after reception of each DT-TPDU, it is recommended that:

- it start a timer after reception of DT-TPDU;
- it send an AK-TPDU with up-to-date window information at expiration of the timer if an AK-TPDU with the same window information has not been previously sent.

Selection of the value of this timer is a local matter but may affect performance.

4 It is recommended that, if the sending transport entity has a restriction in the number of DT-TPDU's that it can retain, then it set the ROA parameter to avoid a delay in transmitting DT-TPDU's due to the remote transport entity operating an AK withholding policy.

6.14 Resynchronization

6.14.1 Purpose

The resynchronization procedures are used in classes 1 and 3 to restore the transport connection to normal after a reset or during reassignment after failure according to 6.12.

6.14.2 Network service primitives

The procedure uses the following network service primitive:

- N-RESET indication.

6.14.3 TPDU's and parameters used

The procedure uses the following TPDU's and parameters:

- a) CR, DR, CC and DC-TPDU's;
- b) RJ-TPDU:
 - YR-TU-NR;
- c) DT-TPDU:
 - TPDU-NR;
- d) ED-TPDU:
 - ED-TPDU-NR;
- e) EA-TPDU:
 - YR-EDTU-NT.

6.14.4 Procedure

A transport entity which is notified of the occurrence of a N-RESET shall:

- a) if the transport entity is the responder, carry out the passive resynchronization procedure (see 6.14.4.2);
- b) if the transport entity has elected not to reassign, do nothing;

- c) otherwise, execute the active resynchronization procedure described in 6.14.4.1 and, if 6.14.4.1 b) has been performed, wait for the next event as follows:
 - if a valid TPDU is received as the result of the resynchronization, stop the TTR timer; or
 - if TTR runs out, wait for the next event; or
 - if an N-RESET indication is received, perform 6.14.4.

6.14.4.1 Active resynchronization procedures

The transport entity shall carry out one of the following actions:

- a) if the TTR timer has been previously started and has run out (i.e. no valid TPDU has been received), the procedures defined in 6.12.3 a) 3) shall apply;
- b) otherwise, the TTR timer shall be started (unless it is already running) and the first which become applicable of the following actions shall be taken:
 - 1) if a CR-TPDU is unacknowledged, then the transport entity shall retransmit it;
 - 2) if a DR-TPDU is unacknowledged, then the transport entity shall retransmit it;
 - 3) otherwise, the transport entity shall carry out the data resynchronization procedures (see 6.14.4.3).

6.14.4.2 Passive resynchronization procedures

The transport entity shall not send any TPDUs until a TPDU has been received. The transport entity shall start its TWR timer if it has not already been started (due to a previous N-DISCONNECT or N-RESET indication). If the timer runs out prior to the receipt of a valid TPDU which commences resynchronization (i.e. CR or DR or ED or RJ-TPDU), the transport connection is considered as released and the reference is frozen (see 6.18).

When a valid TPDU is received the transport entity shall stop its TWR timer and carry out one of the following appropriate actions, depending on the TPDU:

- a) If it is a DR-TPDU, then the transport entity shall send a DC-TPDU.
- b) If it is a repeated CR-TPDU (see Note 1) the transport entity shall carry out the appropriate action from the following:
 - 1) if a CC-TPDU has already been sent, and acknowledged: treat as a protocol error;
 - 2) if the responder wants to release the transport connection or refuse the CR-TPDU: (re)transmit the DR-TPDU, setting the source reference to zero;
 - 3) if the T-CONNECT response has not yet been received from the user: take no action;
 - 4) otherwise (re)transmit the CC-TPDU, followed by retransmission of any unacknowledged ED-TPDU (see Note 2) and retransmission of the unacknowledged DT-TPDUs, subject to any applicable flow control procedures.

NOTES

1 A repeated CR-TPDU can be identified by being on a network connection with the appropriate network addresses and having a correct source reference.

2 The transport entity should not use network expedited until the CC-TPDU is acknowledged (see 6.5). This rule prevents the network expedited from overtaking the CC-TPDU.

- c) If it is an RJ or ED-TPDU, then one of the following actions shall be taken:
 - 1) if a DR-TPDU is unacknowledged, then the transport entity shall retransmit it;
 - 2) if a CC-TPDU is unacknowledged, the RJ or ED-TPDU shall be considered as acknowledging the CC-TPDU, and the transport entity shall carry out the data resynchronization procedures (6.14.4.3);
 - 3) otherwise, the transport entity shall carry out the data resynchronization procedures (6.14.4.3).

6.14.4.3 Data resynchronization procedures

The transport entity shall carry out the following actions in the following order:

- a) (Re)transmit any ED-TPDU which is unacknowledged.
- b) Transmit an RJ-TPDU with YR-TU-NR field set to the TPDU-NR of the next expected DT-TPDU.

- c) Wait for the next TPDU from the other transport entity, unless an RJ or DR-TPDU has already been received; if a DR-TPDU is received the transport entity shall send a DC-TPDU, freeze the reference, inform the TS-user of the disconnection and take no further action [i.e. it shall not follow the procedures in 6.14.4.3 d)]. If an RJ-TPDU is received, the procedure of 6.14.4.3 d) shall be followed. If an ED-TPDU is received the procedures as described in 6.11 shall be followed. If it is a duplicated ED-TPDU the transport entity shall acknowledge it with an EA-TPDU, discard the duplicated ED-TPDU and wait again for the next TPDU.
- d) (Re)transmit any DT-TPDUs which are unacknowledged, subject to any applicable flow control procedures (see the Note).

NOTE – The RJ-TPDU may have reduced the credit.

6.15 Multiplexing and demultiplexing when operating over CONS

6.15.1 Purpose

The multiplexing and demultiplexing procedures are used in classes 2, 3 and 4 to allow several transport connections to share a network connection at the same time.

6.15.2 TPDUs and parameters used

The procedure uses the following TPDUs and parameters:

- CC, DR, DC, DT, AK, ED, EA, RJ, and ER-TPDUs:
 - DST-REF.

6.15.3 Procedure

The transport entities shall be able to send and receive on the same network connection TPDUs belonging to different transport connections.

NOTES

1 When performing demultiplexing, the transport connection to which the TPDUs apply is determined by the procedures defined in 6.9.

2 Multiplexing allows the concatenation of TPDUs belonging to different transport connections to be transferred in the same N-DATA primitive (see 6.4).

6.16 Explicit flow control

6.16.1 Purpose

The explicit flow control procedure is used in classes 2, 3 and 4 to regulate the flow of DT-TPDUs independently of the flow control in the other layers.

6.16.2 TPDUs and parameters used

The procedure uses the following TPDUs and parameters:

- a) CR, CC, AK and RJ-TPDUs:
 - CDT;
- b) DT-TPDU:
 - TPDU-NR;
 - ROA;
- c) AK-TPDU:
 - YR-TU-NR;
 - subsequence number;
 - flow control confirmation;
 - selective acknowledgement parameters;
- d) RJ-TPDU:
 - YR-TU-NR.

6.16.3 Procedure

The procedures differ in different classes. They are defined in the clauses specifying the separate classes.

6.17 Checksum

6.17.1 Purpose

The checksum procedure is used to detect corruption of TPDU's by the NS-provider.

NOTE – Although a checksum algorithm has to be adapted to the type of errors expected on the network connection, at present, only one algorithm is defined.

6.17.2 TPDU's and parameters used

The procedure uses the following TPDU's and parameters:

- All TPDU's:
 - checksum.

6.17.3 Procedure

The checksum shall be used only in class 4. It shall always be used for the CR-TPDU, and shall be used for all other TPDU's unless the non-use of the checksum was selected during connection establishment.

The sending transport entity shall transmit TPDU's with the checksum parameter set such that the following formulae are satisfied:

$$\sum_{i=1}^L a_i = 0 \text{ (modulo 255)} \quad (6-1)$$

$$\sum_{i=1}^L ia_i = 0 \text{ (modulo 255)} \quad (6-2)$$

where

- i is the number (i.e. position) of an octet within the TPDU (see 13.2);
- a_i is the value of octet in position i ;
- L is the length of TPDU in octets.

A transport entity which receives a TPDU for a transport connection for which the use of the checksum has been agreed and which does not satisfy the above formulae shall discard the TPDU (see also Note 2).

When a spurious TPDU is received and an answer has to be sent, the transport entity shall:

- a) if it supports the checksum algorithm and the received TPDU contains a checksum parameter, include a checksum parameter in the answering TPDU; or
- b) in all other cases, not include a checksum parameter in the answering TPDU.

An entity not supporting the checksum may always suppose that a CR-TPDU with class 4 proposed is correct and therefore negotiate down to a class lower than 4. If such an entity refuses the connection, then it sends a DR-TPDU without checksum.

NOTES

- 1 An efficient algorithm for determining the checksum parameters is given in Annex B.
- 2 If the checksum is incorrect, it is impossible to know with certainty to which transport connection the TPDU is related; further action may be required dependent on the type of network service in use (see 6.9.1 for CONS and 6.9.2 for CLNS).
- 3 The checksum proposed is easy to calculate and so will not impose a heavy burden on implementations. However, it will not detect insertion or loss of leading or trailing zeros and will not detect some octets misordering.
- 4 When CONS is used and a TPDU is received on a network connection, it is impossible to know with certainty that only class 4 transport connections use this network connection as it may be a TPDU performing reassignment.

Consequently, the only way to check the validity is as follows:

- a) if the network connection is used by a class 0 or class 1 transport connection, there is no checksum;
- b) examine the TPDU code;

ISO/IEC 8073 : 1997 (E)

- c) deduce the fixed part length;
- d) from LI, deduce the variable part;
- e) go through parameters and if the checksum parameter is found, then verify it;
- f) if it is incorrect, then assume that transport connection is class 4 and drop it;
- g) if it is correct, then associate the TPDU with a transport connection; if the transport connection uses the checksum, it is correct; otherwise, it shall be considered as a protocol error.

6.18 Frozen references

6.18.1 Purpose

This procedure shall be used in order to prevent re-use of a reference while TPDU's associated with the old use of the reference may still exist.

6.18.2 Procedure

When a transport entity determines that a particular connection is released it shall place the reference which it has allocated to the connection in a frozen state according to the procedures of the class. While frozen, the reference shall not be re-used.

NOTE – The frozen reference procedure is necessary because retransmission or misordering can cause TPDU's bearing a reference to arrive at an entity after it has released the connection for which it allocated the reference. Retransmission, for example, can arise when the class includes either resynchronization (see 6.14) or retransmission on time-out (see 6.19).

6.18.2.1 Procedure for classes 0 and 2

This Recommendation does not specify frozen reference procedures for classes 0 and 2.

NOTE – For consistency with other classes, references may be frozen as a local matter.

6.18.2.2 Procedure for classes 1 and 3

The frozen reference procedure is used except in the following cases (see Note 1):

- a) when the transport entity receives a DC-TPDU in response to a DR-TPDU which it has sent (see Note 2);
- b) when the transport entity sends a DR or ER-TPDU in response to a CR-TPDU which it has received (see Note 3);
- c) when the transport entity has considered the connection to be released after the expiration of the TWR timer (see Note 4);
- d) when the transport entity receives a DR or ER-TPDU in response to a CR-TPDU which it has sent;
- e) when the reference is zero.

The period of time for which the reference remains frozen shall be greater than the TWR time.

NOTES

- 1 However, even in these cases, for consistency freezing the reference may be done as a local decision.
- 2 When the DC-TPDU is received it is certain that the other transport entity considers the connection released.
- 3 When the DR or ER-TPDU is sent, the peer transport entity has not been informed of any reference assignment and thus cannot possibly make use of a reference (this includes the case where a CC-TPDU was sent, but was lost).
- 4 In c) the transport entity has already effectively frozen the reference for an adequate period.

6.18.2.3 Procedure for class 4

The frozen reference procedure shall be used in class 4. The period for which the reference remains frozen shall be greater than L (see 12.2.1.1.6).

6.19 Retransmission on time-out

6.19.1 Purpose

The procedure is used in class 4 to cope with unsignalled loss of TPDU's by the NS provider.

6.19.2 TPDU's used

The procedure uses the following TPDU's:

- CR, CC, DR, DT, ED, AK-TPDU's.

6.19.3 Procedure

The procedure is specified in the procedures for class 4 [see 12.2.1.2 i) and 12.2.1.3 g)].

6.20 Resequencing**6.20.1 Purpose**

The resequencing procedure is used in class 4 to cope with misordering of TPDU's by the network service provider.

6.20.2 TPDU's and parameters used

The procedure uses the following TPDU's and parameters:

- a) DT-TPDU:
 - TPDU-NR;
- b) ED-TPDU:
 - ED-TPDU-NR.

6.20.3 Procedure

The procedure is specified in the procedures for class 4 (see 12.2.3.5).

6.21 Inactivity control**6.21.1 Purpose**

The inactivity control procedure is used in class 4 to cope with unsignalled termination of a network connection when using CONS and the failure of a remote transport entity when using CONS or CLNS.

6.21.2 Procedure

The procedure is specified in the procedures for class 4 (see 12.2.3.3).

6.22 Treatment of protocol errors**6.22.1 Treatment of protocol errors when operating over CONS****6.22.1.1 Purpose**

The procedure for treatment of protocol errors is used in all classes to deal with invalid TPDU's.

6.22.1.2 TPDU's and parameters used

The procedure uses the following TPDU's and parameters:

- a) ER-TPDU:
 - reject cause;
 - invalid TPDU;
- b) DR-TPDU:
 - reason code.

6.22.1.3 Procedure

A transport entity that receives a TPDU that can be associated to a transport connection and is invalid or constitutes a protocol error (see 3.2.16 and 3.2.17) shall take one of the following actions so as not to jeopardize any other transport connections not assigned to that network connection:

- a) transmit an ER-TPDU;
- b) reset or close the network connection; or
- c) invoke the release procedures appropriate to the class.

Under certain circumstances, it is also possible to discard the TPDU.

ISO/IEC 8073 : 1997 (E)

If an ER-TPDU is sent in class 0 it shall contain the octets of the invalid TPDU up to and including the octet where the error was detected (see Notes 3, 4 and 5).

If the TPDU cannot be associated with a particular transport connection, the transport entity shall follow the procedures in 6.9.

NOTES

1 In general, no further action is specified for the receiver of the ER-TPDU but it is recommended that it initiates the release procedure appropriate to the class. If the ER-TPDU has been received as an answer to a CR-TPDU then the connection is regarded as released (see 6.6).

2 Care should be taken by a transport entity receiving several invalid TPDU's or ER-TPDU's to avoid looping if the error is generated repeatedly.

3 If the invalid received TPDU is greater than the selected maximum TPDU size-inclusion in the invalid TPDU parameter of the ER-TPDU may not be possible.

4 It is recommended that the sender of the ER-TPDU starts an optional timer TS2 to ensure the release of the connection. If the timer expires, the transport entity shall initiate the release procedures appropriate to the class. The timer should be stopped when a DR-TPDU or an N-DISCONNECT indication is received.

5 In classes other than 0, it is recommended that the invalid TPDU be also included in the ER-TPDU.

6.22.2 Treatment of protocol errors when operating over CLNS

6.22.2.1 Purpose

The procedure for treatment of protocol errors is used to deal with invalid TPDU's.

6.22.2.2 TPDU's and parameters used

The procedure uses the following TPDU's and parameters:

- a) ER-TPDU:
 - reject cause;
 - invalid TPDU;
- b) DR-TPDU:
 - reason.

6.22.2.3 Procedure

Invalid TPDU's and protocol errors shall be ignored (no action and TPDU discarded, or responded to with an ER-TPDU), except for the following case: a CC-TPDU is received in which the class field does not specify class 4 and a previously sent CR-TPDU has not yet been acknowledged. In this case, the transport connection shall be terminated (see 6.7).

NOTE – It is recommended that the sender of the ER-TPDU starts an optional timer TS2 to ensure the release of the connection. If the timer expires, the transport entity shall initiate the release procedure appropriate to class 4. The timer should be stopped when a DR-TPDU is received.

6.23 Splitting and recombining when operating over CONS

6.23.1 Purpose

This procedure is used only in class 4 to allow a transport connection to make use of multiple network connections to provide additional resilience against network failure, to increase throughput, or for other reasons.

6.23.2 Procedure

When this procedure is being used, a transport connection may be assigned (see 6.1) to multiple network connections (see Note 1). TPDU's for the connection may be sent over any such network connection.

If the use of class 4 is not accepted by the remote transport entity following the negotiation rules, then no network connection except that over which the CR-TPDU was sent may have the transport connection assigned to it.

NOTES

- 1 The resequencing function of class 4 (see 6.20) is used to ensure that TPDU's are processed in the correct sequence.

2 Either transport entity may assign the connection to further network connections of which it is the owner at any time during the life of the transport connection, provided the following constraints are respected:

- the initiator does not start splitting before having received the CC-TPDU;
- as soon as a new assignment is carried out it is recommended to send a TPDU on this network connection in order to make the remote entity aware of this assignment.

3 A transport entity performing splitting should ensure that TPDU's are sent at intervals on each supporting network connection, for example, by sending successive TPDU's on successive network connections, where the set of network connections is used cyclically.

When splitting is used the inactivity control procedure defined in 12.2.3.3 will not normally detect unsignalled network connection failure. Any method of monitoring network connections to detect such failure is a local matter.

7 Protocol classes

Table 6 gives an overview of which elements of procedure are included in each class. In certain cases, the elements of procedure within different classes are not identical and, for this reason, Table 6 cannot be considered as part of the definitive specification of the protocol.

8 Specification for class 0 – Simple class

8.1 Functions of class 0

Class 0 is designed to have minimum functionality. It provides only the functions needed for connection establishment with negotiation, data transfer with segmenting and protocol error reporting.

Class 0 provides transport connections with flow control based on the network service provided flow control, and disconnection based on the network service disconnection.

8.2 Procedures for class 0

8.2.1 Procedures applicable at all times

The transport entities shall use the following procedures:

- a) TPDU transfer (see 6.2);
- b) association of TPDU's with transport connections (see 6.9);
- c) treatment of protocol errors (see 6.22);
- d) error release (see 6.8).

8.2.2 Connection establishment

The transport entities shall use the following procedures:

- a) assignment to network connection (see 6.1.1); then
- b) connection establishment (see 6.5) and, if appropriate, connection refusal (see 6.6),

subject to the following constraints:

- 1) the CR and CC-TPDU's shall contain no parameter fields in the variable part of the header other than those for Transport-Selector, maximum TPDU size, and preferred maximum TPDU size;
- 2) the CR and CC-TPDU's shall not contain a data field.

8.2.3 Data transfer

The transport entities shall use the segmenting and reassembling procedure (see 6.3).

8.2.4 Release

The transport entities shall use the implicit variant of the normal release procedure (see 6.7.1.4).

NOTE – The lifetime of the transport connection is directly correlated with the lifetime of the network connection.

Table 6 – Allocation of elements of procedures within classes

Protocol mechanism	Cross-reference	Variant or Option	0	1	2	3	4 CONS	4 CLNS
Assignment to network connection	6.1.1		x	x	x	x	x	
TPDU transfer	6.2		x	x	x	x	x	x
Segmenting and reassembling	6.3		x	x	x	x	x	x
Concatenation and separation	6.4			x	x	x	x	x
Connection establishment	6.5		x	x	x	x	x	x
Connection refusal	6.6		x	x	x	x	x	x
Normal release	6.7	Implicit Explicit	x	x	x	x	x	x
Error release	6.8		x		x			
Association of TPDU's with transport connection	6.9		x	x	x	x	x	x
TPDU numbering	6.10	Normal Extended		x	m (Note 1) o (Note 1)	m o	m o	m o
Expedited data transfer	6.11	Network Normal Network Expedited		m ao	x (Note 1)	x	x	x
Reassignment after failure	6.12			x		x	(Note 3)	
Retention and acknowledgement of TPDU's	6.13	Confirmation of receipt AK Use of selective acknowledgement Use of request acknowledgement		ao m o (Note 4)		x o	x o o	x o o
Resynchronization	6.14			x		x	(Note 3)	
Multiplexing and demultiplexing	6.15				x (Note 2)	x	x	
Explicit flow control (with) Explicit flow control (without)	6.16		x	x	m o	x	x	x
Checksum (use of) Checksum (non-use of)	6.17		x	x	x	x	m o	m o
Frozen references	6.18			x		x	x	x
Retransmission on time-out	6.19						x	x
Resequencing	6.20						x	x
Inactivity control	6.21						x	x
Treatment of protocol errors	6.22		x	x	x	x	x	x
Splitting and recombining	6.23						x	
<p>x Procedure always included in class Not applicable</p> <p>m Negotiable procedure whose implementation in equipment is mandatory</p> <p>o Negotiable procedure whose implementation in equipment is optional</p> <p>ao Negotiable procedure whose implementation in equipment is optional and where use depends of availability within the network service</p> <p>NOTES</p> <p>1 Not applicable in class 2 when non-use of explicit flow control is selected.</p> <p>2 Multiplexing may lead to degradation of the quality of service if the non-use of explicit flow control has been selected.</p> <p>3 This function is provided in class 4 using procedures other than those used in the cross-reference.</p> <p>4 This option is not applicable in class 1, when the confirmation of receipt variant has been selected.</p>								

9 Specification for class 1 – Basic error recovery class

9.1 Functions of class 1

Class 1 provides transport connections with flow control based on the network service provided flow control, error recovery, expedited data transfer, disconnection, and also the ability to support consecutive transport connections on a network connection.

This class provides the functionality of class 0 plus the ability to recover after a failure signalled by the Network Service, without involving the TS-user.

9.2 Procedures for class 1

9.2.1 Procedures applicable at all times

The transport entities shall use the following procedures:

- a) TPDU transfer (see 6.2);
- b) association of TPDU with transport connections (see 6.9);
- c) treatment of protocol errors (see 6.22);
- d) reassignment after failure (see 6.12);
- e) resynchronization (see 6.14), or reassignment after failure (see 6.12) together with resynchronization (see 6.14);
- f) concatenation and separation (see 6.4);
- g) retention and acknowledgement of TPDU's (see 6.13); the variant used, AK or confirmation of receipt, shall be as selected during connection establishment (see Notes);
- h) frozen references (see 6.18).

NOTES

1 The negotiation of the variant of retention and acknowledgement of TPDU's procedure to be used over the transport connection has been designed such that if the initiator proposes the use of the AK variant (i.e. the mandatory implementation option), the responder has to accept use of this option and if the initiator proposes use of the confirmation of receipt variant the responder is entitled to select use of the AK variant.

2 The AK variant makes use of AK-TPDU's to release copies of retained DT-TPDU's. The CDT parameter of AK-TPDU's in class 1 is not significant, and is set to 1111.

3 The confirmation of receipt variant is restricted to this class and its use depends on the availability of the network layer receipt confirmation service, and the expected cost reduction.

9.2.2 Connection establishment

The transport entities shall use the following procedures:

- a) assignment to network connection (see 6.1.1); then
- b) connection establishment (see 6.5) and, if appropriate, connection refusal (see 6.6).

9.2.3 Data transfer

9.2.3.1 General

The sending transport entity shall use the following procedures:

- a) segmenting (see 6.3); then
- b) the normal format variant of DT-TPDU numbering (see 6.10).

The receiving transport entity shall use the following procedures:

- 1) the normal format variant of DT-TPDU numbering (see 6.10); then
- 2) reassembling (see 6.3).

NOTE – The decision to issue an N-RESET request in order to force the remote entity to carry out the resynchronization (see 6.14) may be made on a local basis.

9.2.3.2 Expedited data

The transport entities shall use either the network normal data or the network expedited variants of the expedited data transfer procedure (see 6.11) if their use has been selected during connection establishment (see Note 1).

The sending transport entity shall not allocate the same ED-TPDU-NR to successive ED-TPDUs (see Notes 2 and 3).

When acknowledging an ED-TPDU by sending an EA-TPDU, the transport entity shall put into the YR-EDTU-NR parameter of the EA-TPDU the value received in the ED-TPDU-NR parameter of the ED-TPDU.

NOTES

1 The negotiation of the variant of expedited data transfer procedure to be used over the transport connection has been designed such that if the initiator proposes the use of the network normal data variant (i.e. the mandatory implementation option), the responder has to accept use of this option and if the initiator proposes use of the network expedited variant, the responder is entitled to select use of the network normal data variant.

2 This numbering enables the receiving transport entity to discard repeated ED-TPDUs when resynchronization (see 6.14) has taken place.

3 No other significance is attached to the ED-TPDU-NR parameter. It is recommended, but not essential, that the values used be consecutive modulo 128.

4 The use of RJ-TPDUs during resynchronization (see 6.14) can lead to retransmission. Thus, the receipt of a duplicate ED-TPDU is possible. Such an ED-TPDU is discarded.

9.2.4 Release

The transport entities shall use the explicit variant of the release procedure (see 6.7.1.5).

10 Specification for class 2 – Multiplexing class

10.1 Functions of class 2

Class 2 provides transport connections with or without individual flow control; no error detection or error recovery is provided.

If the network connection resets or disconnects, the transport connection is terminated without the transport release procedure and the TS-user is informed.

When explicit flow control is used, a credit mechanism is defined allowing the receiver to inform the sender of the exact amount of data he is willing to receive and that the expedited data transfer is available.

10.2 Procedures for class 2

10.2.1 Procedures applicable at all times

The transport entities shall use the following procedures:

- a) association of TPDUs with transport connection (see 6.9);
- b) TPDU transfer (see 6.2);
- c) treatment of protocol errors (see 6.22.1);
- d) concatenation and separation (see 6.4);
- e) error release (see 6.8).

Additionally the transport entities may use the following procedures:

- f) multiplexing and demultiplexing (see 6.15).

10.2.2 Connection establishment

The transport entities may use the following procedures:

- a) assignment to network connection (see 6.1.1); then
- b) connection establishment (see 6.5) and, if applicable, connection refusal (see 6.6).

10.2.3 Data transfer when non-use of explicit flow control has been selected

If this option has been selected as a result of the connection establishment, the transport entities shall use the segmenting procedure (see 6.3).

The TPDU-NR field of DT-TPDUs is not significant and may take any value.

NOTE – Expedited data transfer is not applicable (see 6.5).

10.2.4 Data transfer when use of explicit flow control has been selected

10.2.4.1 General

The sending transport entity shall use the following procedures:

- a) segmenting (see 6.3); then
- b) DT-TPDU numbering (see 6.10).

The receiving transport entity shall use the following procedures:

- 1) DT-TPDU numbering (see 6.10); if a DT-TPDU is received which is out of sequence it shall be treated as a protocol error; then
- 2) reassembling (see 6.3).

The variant of the DT-TPDU numbering which is used by both transport entities shall be that which was agreed at connection establishment.

10.2.4.2 Flow control

The transport entities shall send an initial credit (which may be zero) in the CDT field of the CR or CC-TPDU. This credit represents the initial value of the upper window edge allocated to the peer entity.

The transport entity that receives the CR or the CC-TPDU shall consider its lower window edge as zero, and its upper window edge as the value of the CDT field in the received TPDU.

In order to authorize the transmission of DT-TPDUs, by its peer, a transport entity may transmit an AK-TPDU at any time, subject to the following constraints:

- a) the YR-TU-NR parameter shall be at most one greater than the TPDU-NR field of the last received DT-TPDU or shall be zero if no DT-TPDU has been received;
- b) if an AK-TPDU has previously been sent, the value of the YR-TU-NR parameter shall not be lower than that in the previously sent AK-TPDU;
- c) the sum of the YR-TU-NR and CDT fields shall not be less than the upper window edge allocated to the remote entity (see Note 1).

A transport entity which receives an AK-TPDU shall consider the YR-TU-NR field as its new lower window edge, and the sum of YR-TU-NR and CDT as its new upper window edge. If either of these have been reduced or if the lower window edge has become more than one greater than the TPDU-NR of the last transmitted DT-TPDU, this shall be treated as a protocol error (see 6.22.1).

A transport entity shall not send a DT-TPDU with a TPDU-NR outside of the transmit window (see Notes 2 and 3).

NOTES

- 1 This means that credit reduction is not applicable.
- 2 This means that a transport entity is required to stop sending if the TPDU-NR field of the next DT-TPDU which would be sent would be the upper window edge. Sending of DT-TPDU may be resumed if an AK-TPDU is received which increases the upper window edge.
- 3 The rate at which a transport entity progresses the upper window edge allocated to its peer entity constrains the throughput attainable on the transport connection.

10.2.4.3 Expedited data

The transport entities shall follow the network normal data variant of the expedited data transfer procedure in 6.11.1 if its use has been agreed during connection establishment. ED and EA-TPDUs are not subject to the flow control procedures in 10.2.4.2. The ED-TPDU-NR and YR-ETDU-NR fields of ED and EA-TPDUs respectively are not significant and may take any value.

10.2.5 Release

The transport entities shall use the explicit variant of the release procedure in 6.7.1.

11 Specification for class 3 – Error recovery and multiplexing class

11.1 Functions of class 3

Class 3 provides the functionality of class 2 (with use of explicit flow control) plus the ability to recover after a failure signalled by the Network Layer without involving the TS-user.

The mechanisms used to achieve this functionality also allow the implementation of more flexible flow control.

11.2 Procedures for class 3

11.2.1 Procedures applicable at all times

The transport entities shall use the following procedures:

- a) association of TPDU's with transport connections (see 6.9);
- b) TPDU transfer (see 6.2) and retention and acknowledgement of TPDU's (AK variant only) (see 6.13);
- c) treatment of protocol errors (see 6.22.1);
- d) concatenation and separation (see 6.4);
- e) reassignment after failure (see 6.12), together with resynchronization (see 6.14);
- f) frozen references (see 6.18).

Additionally, the transport entities may use the following procedure:

- g) multiplexing and demultiplexing (see 6.15).

11.2.2 Connection establishment

The transport entities shall use the following procedures:

- a) assignment to network connections (see 6.1.1); then
- b) connection establishment (see 6.5) and, if appropriate, connection refusal (see 6.6).

11.2.3 Data transfer

11.2.3.1 General

The sending transport entity shall use the following procedures:

- a) segmenting (see 6.3); then
- b) DT-TPDU numbering (see 6.10): after receipt of an RJ-TPDU (see 11.2.3.2) the next DT-TPDU to be sent may have a value which is not the previous value of TPDU-NR plus one.

The receiving transport entity shall use the following procedures:

- 1) DT-TPDU numbering (see 6.10): the TPDU-NR field of each received DT-TPDU shall be treated as a protocol error if it exceeds the greatest value received in a previous DT-TPDU by more than one (see the Note); then
- 2) reassembling (see 6.3): duplicated TPDU's shall be eliminated before reassembling is performed.

NOTE – The use of RJ-TPDU's (see 11.2.3.2) can lead to retransmission and reduction of credit. Thus the receipt of a DT-TPDU which is a duplicate, or which is greater than or equal to the upper window edge allocated to the peer entity, is possible and is therefore not treated as a protocol error.

11.2.3.2 Use of an RJ-TPDU

A transport entity may send an RJ-TPDU at any time in order to invite retransmission or to reduce the upper window edge allocated to the peer entity (see Note 1).

When an RJ-TPDU is sent, the following constraints shall be respected:

- a) the YR-TU-NR parameter shall be at most one greater than the greatest value received in a previous DT-TPDU, or shall be zero if no DT-TPDU has yet been received (see Note 2);
- b) if an AK or RJ-TPDU has been sent previously the YR-TU-NR parameter shall not be lower than that in the AK or RJ-TPDU sent previously.

When a transport entity receives an RJ-TPDU (see Note 3):

- c) the next DT-TPDU to be transmitted, or retransmitted, shall be that for which the value of the TPDU-NR parameter is equal to the value of the YR-TU-NR parameter of the RJ-TPDU;
- d) the sum of the values of the YR-TU-NR and CDT parameters of the RJ-TPDU becomes the new upper window edge (see Note 4).

NOTES

- 1 An RJ-TPDU can also be sent as part of the resynchronization (see 6.14) and reassignment after failure (see 6.12) procedures.
- 2 It is recommended that the YR-TU-NR parameter be equal to the TPDU-NR parameter of the next expected DT-TPDU.
- 3 These rules are a subset of those specified for the case when an RJ-TPDU is received during resynchronization (see 6.14) and reassignment after failure (see 6.12).
- 4 This means that an RJ-TPDU can be used to reduce the upper window edge allocated to the peer entity (credit reduction).

11.2.3.3 Flow control

The procedures shall be as defined in 10.2.4.2, except that:

- a) A credit reduction may lead to the reception of a DT-TPDU with a TPDU-NR parameter whose value is not, but would have been less than the upper window edge allocated to the remote entity prior to the credit reduction. This shall not be treated as a protocol error.
- b) Receipt of an AK-TPDU which sets the lower window edge more than one greater than the TPDU-NR of the last transmitted DT-TPDU shall not be treated as a protocol error, provided that all acknowledged DT-TPDUs have been previously transmitted (see Notes 1 and 2).

NOTES

- 1 This can only occur during retransmission following receipt of an RJ-TPDU.
- 2 The transport entity may either continue retransmission as before or retransmit only those DT-TPDUs, not acknowledged by the AK-TPDU. In either case, copies of the acknowledged DT-TPDUs need not be retained.

11.2.3.4 Expedited data

The transport entities shall follow the network normal data variant of the expedited data transfer procedure in 6.11.1 if its use has been agreed during connection establishment.

The sending transport entity shall not allocate the same ED-TPDU-NR to successive ED-TPDUs.

The receiving transport entity shall transmit an EA-TPDU with the same value in its YR-EDTU-NR parameter. If, and only if, this number is different from that of the ED-TPDU perceived previously, shall it generate a T-EXPEDITED DATA indication to convey the data to the TS-user (see Note 2).

NOTES

- 1 No other significance is attached to the ED-TPDU-NR parameter. It is recommended, but not essential, that the values be consecutive modulo 2^n , where n is the number of bits of the parameter.
- 2 This procedure ensures that the TS-user does not receive data corresponding to the same ED-TPDU more than once.

11.2.4 Release

The transport entities shall use the explicit variant of the release procedure in 6.7.1.

12 Specification for class 4 – Error detection and recovery class

12.1 Functions of class 4

12.1.1 Functions of class 4 when operating over CONS

Class 4 provides the functionality of class 3, plus the ability to detect and recover from lost, duplicated, or out of sequence TPDU's without involving the TS-user.

This detection of errors is made by extended use of the DT-TPDU numbering of classes 2 and 3, by time-out mechanisms, and by additional procedures.

Class 4 detects signalled and unsignalled network failures (i.e. resets or disconnects or inactivity) and recovers from these failures by using time-out mechanisms.

ISO/IEC 8073 : 1997 (E)

This class detects and recovers from damaged TPDU's by using a checksum mechanism. The checksum mechanism shall be available but its use or its non-use is subject to negotiation.

This class also provides additional resilience against network failure and increased throughput capability by allowing a transport connection to make use of multiple network connections.

12.1.2 Functions of class 4 when operating over CLNS

Class 4 provides flow control between peer transport entities, the capability to detect and recover from errors which occur as a result of a low grade service available from the network service provider and resilience from failure of the peer entity. The kind of errors to be detected include:

- TPDU loss;
- TPDU delivery out of sequence;
- TPDU duplication; and
- TPDU corruption.

These errors may affect control TPDU's as well as data TPDU's.

The detection of errors is made by use of TPDU numbering on DT, AK, ED and EA TPDU's, by time-out mechanisms and additional procedures such as the use of a checksum mechanism. The use of the checksum mechanism shall be available but its use or its non-use is subject to negotiation.

12.2 Procedures for class 4

12.2.1 Procedures available at all times

12.2.1.1 Timers used at all times

This subclause defines timers that apply at all times in class 4. These timers are listed in Table 7.

This Recommendation | International Standard does not define specific values for the timers, and the derivations described in this subclause are not mandatory. The values should be chosen so that the required quality of service can be provided, given the known characteristics of the network.

Timers that apply only to specific procedures are defined under the appropriate procedure.

12.2.1.1.1 NSDU lifetime (M_{LR} , M_{RL})

The Network Layer is assumed to provide, as an aspect of its grade of service, for a bound on the maximum lifetime of NSDU's in the network. This value may be different in each direction of transfer through a network between two transport entities. The values, for both directions of transfer, are assumed to be known by the transport entities. The maximum NSDU lifetime local-to-remote (M_{LR}) is the maximum time which may elapse between the transmission of an NSDU from the local transport entity to the network and receipt of any copy of the NSDU from the network at the remote transport entity. The maximum NSDU lifetime remote-to-local (M_{RL}) is the maximum time which may elapse between the transmission of an NSDU from the remote transport entity to the network and receipt of any copy of the NSDU from the network at the local transport entity.

12.2.1.1.2 Expected maximum transit delay (E_{LR} , E_{RL})

The Network Layer is assumed to provide, as an aspect of its grade of service, an expected maximum transit delay for NSDU's in the network. This value may be different in each direction of transfer through a network between two transport entities. The values, for both directions of transfer, are assumed to be known by the transport entities. The expected maximum transit delay local-to-remote (E_{LR}) is the maximum delay suffered by all but a small proportion of NSDU's transferred through the network from the local transport entity to the remote transport entity. The expected maximum transit delay remote-to-local (E_{RL}) is the maximum delay suffered by all but a small proportion of NSDU's transferred through the network from the remote transport entity to the local transport entity.

12.2.1.1.3 Acknowledgement time (A_R , A_L)

Any transport entity is assumed to provide a bound for the maximum time which can elapse between its receipt of a TPDU from the Network Layer and its transmission of the corresponding response. This value is referred to as A_L . The corresponding time given by the remote transport entity is referred to as A_R .

Table 7 – Time parameters related to the operation of class 4

Symbol	Name	Definition
M_{LR}	NSDU lifetime local-to-remote	A time bound for the maximum time which may elapse between the transmission of an NSDU by a local transport entity and the receipt of any copy of it by a remote peer entity.
M_{RL}	NSDU lifetime remote-to-local	A time bound for the maximum time which may elapse between the transmission of an NSDU from a remote transport entity and the receipt of any copy of it by the local peer entity.
E_{LR}	Expected maximum transit delay local-to-remote	A time bound for the maximum delay suffered by all but a small proportion of NSDUs transferred from the local transport entity to a remote peer entity.
E_{RL}	Expected maximum transit delay remote-to-local	A time bound for the maximum delay suffered by all but a small proportion of NSDUs transferred from a remote peer entity to the local transport entity.
A_L	Local acknowledgement time	A time bound for the maximum time which can elapse between the receipt of a TPDU by the local transport entity from the network layer and the transmission of the corresponding acknowledgement.
A_R	Remote acknowledgement time	As A_L , but for the remote entity.
TI	Local retransmission time	A time bound for the maximum time the local transport entity will wait for acknowledgement before retransmitting a TPDU.
R	Persistence time	A time bound for the maximum time the local transport entity will continue to transmit a TPDU that requires acknowledgement.
N	Maximum number of transmissions	A time bound for the maximum number of times which the local transport entity will continue to transmit a TPDU that requires acknowledgement.
L	Time bound on references and sequence numbers	A time bound for the maximum time between the transmission of a TPDU and the receipt of any acknowledgement relating to it.
I_L	Local inactivity time	A lower bound for the time after which the local transport entity will, if it does not receive a TPDU, initiate the release procedure to terminate the transport connection. (See Note.)
I_R	Remote inactivity time	A lower bound for the time after which the remote transport entity will, if it does not receive a TPDU, initiate the release procedure to terminate the transport connection. (See Note.)
W	Window time	A time bound for the maximum time a transport entity will wait before retransmitting up-to-date window information.

NOTE – This parameter is required for protection against unsignalled failures.

12.2.1.1.4 Local retransmission time (TI)

The local transport entity is assumed to maintain a bound on the time it will wait for an acknowledgement before retransmitting the TPDU. Its value is given by:

$$TI = E_{LR} + E_{RL} + A_R + x$$

where

E_{LR} is the expected maximum transit delay local-to-remote;

E_{RL} is the expected maximum transit delay remote-to-local;

A_R is the remote acknowledgement time;

x is the local processing time for a TPDU.

NOTE – During connection establishment the value of A_R is not known. In this case a suitable bound for TI may be established either by estimating (or having *a priori* knowledge of) A_R or by applying a suitable algorithm to the transport connection establishment delay QOS parameter.

12.2.1.1.5 Persistence time (R)

The local transport entity is assumed to provide a bound for the maximum time for which it may continue to retransmit a TPDU requiring positive acknowledgement and which is not outside the current transmit window, even after credit reduction. This value is referred to as R .

The value is clearly related to the time elapsed between retransmission, TI , and the maximum number of transmissions, N . It is not less than $TI \cdot (N - 1) + x$, where x is a small quantity to allow for additional internal delays, the granularity of the mechanism used to implement TI , etc. Because R is a bound, the exact value of x is unimportant as long as it is bounded and the value of a bound is known.

12.2.1.1.6 Time bound of references and sequence numbers (L)

A bound for the maximum time between the decision to transmit a TPDU and the receipt of any acknowledgement relating to it (L) is given by:

$$L = M_{LR} + M_{RL} + R + A_R$$

where

M_{LR} is the NSDU lifetime local-to-remote;

M_{RL} is the NSDU lifetime remote-to-local;

R is the persistence time;

A_R is the remote acknowledgement time.

It is necessary to wait for a period of time before reusing any reference or sequence number in order to avoid confusion when a TPDDU referring to it is duplicated or delayed.

The period of time during which the sequence numbers for DT-TPDUs should be frozen is the period L , starting from the time when the sequence number has fallen below the lower window edge.

NOTES

1 In practice, the value of L may be too large. It may also be only a statistical figure at a certain confidence level. A smaller value may therefore be used where this still allows the required quality of service to be provided.

2 The relationships between times discussed above are illustrated in Figures 3 and 4.

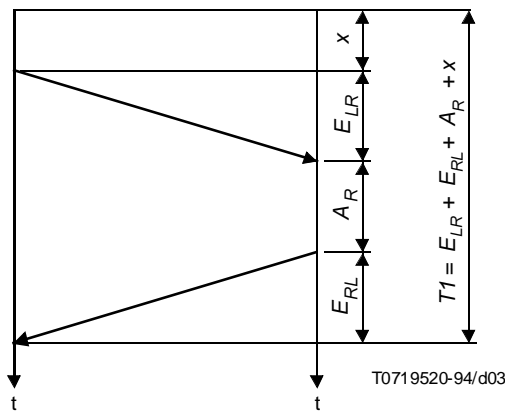

Figure 3 – Interrelationship of times for the average case in class 4

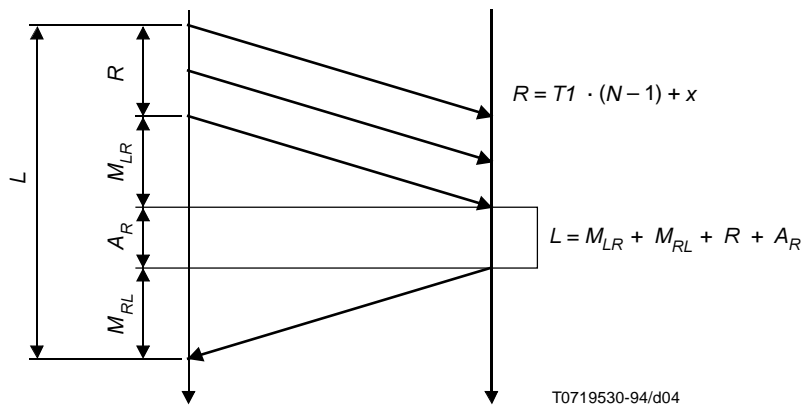

Figure 4 – Interrelationship of times for maximum delay in class 4

12.2.1.1.7 Inactivity timer (I_L, I_R)

Any transport entity is assumed to provide a lower bound for the time which can elapse without receipt of a TPDU before it will initiate the release procedure to terminate the transport connection. This value is referred to as I_L . The corresponding time given by the remote transport entity is referred to as I_R .

12.2.1.2 General procedures when operating over CONS

The transport entity shall use the following procedures:

- a) TPDU transfer (see 6.2).
- b) Association of PDUs with transport connections (see 6.9.1).
- c) Treatment of protocol errors (see 6.22.1).
- d) Checksum (see 6.17).
- e) Splitting and recombining (see 6.23).
- f) Multiplexing and demultiplexing (see 6.15).
- g) Retention and acknowledgement of PDUs (see 6.13).
- h) Frozen references (see 6.18).
- i) Retransmission procedures – When a transport entity has some outstanding PDUs that require acknowledgement, it will check that no TI interval elapses without the arrival of a PDU that acknowledges at least one of the outstanding PDUs. If the timer expires, the first PDU is retransmitted and the timer is restarted except if the PDU to be retransmitted is a DT-PDU and is outside the transmit window due to credit reduction. Retransmission of a PDU is subject to the availability of a network connection. If no network connection is available, and the retransmission timer runs out, then the retransmission counter may be incremented without sending the PDU subject to the retransmission procedure. After N transmissions (i.e. $N - 1$ retransmissions) it is assumed that useful two-way communication is no longer possible and the release procedure is used, and the TS-user is informed.

NOTES

- 1 This procedure may be implemented by different means. For example:
 - a) one interval is associated with each PDU: if the timer expires the associated PDU will be retransmitted and the timer TI will be restarted for all subsequent PDUs; or
 - b) one interval is associated with each transport connection:
 - 1) if the transport entity transmits a PDU requiring acknowledgement, it starts timer TI ;
 - 2) if the transport entity receives a PDU that acknowledges one of the PDUs to be acknowledged, it restarts timer TI unless the received PDU is an AK which explicitly closes the transmit window;
 - 3) if the transport entity receives a PDU that acknowledges the last PDU to be acknowledged, it stops timer TI .

For a decision whether the retransmission timer TI is maintained on a per PDU or on a per transport connection basis, throughput considerations have to be taken into account.
- 2 For DT-PDUs it is a local choice to retransmit either only the first DT-PDU or all PDUs waiting for an acknowledgement up to the upper window edge.
- 3 It is recommended that after N transmissions, the transport entity waits $TI + W + M_{RL}$ in order to provide a higher possibility of receiving an acknowledgement before entering the release phase. For other PDU types which may be retransmitted, it is recommended that after N transmissions the transport entity waits $TI + M_{RL}$ in order to provide a greater possibility of receiving the expected reply.
- 4 If use of selective acknowledgement has been negotiated, a selective acknowledgement implicitly identifies DT-PDUs not received. Since such a DT-PDU could be a lost DT-PDU, or simply a delayed DT-PDU, it is a local matter whether DT-PDUs not acknowledged in a selective acknowledgement should be retransmitted immediately.

- j) Concatenation and separation (see 6.4).

12.2.1.3 General procedures when operating over CLNS

The transport entity shall use the following procedures:

- a) TPDU transfer (see 6.2).
- b) Association of PDUs with transport connections (see 6.9.1).
- c) Treatment of protocol errors (see 6.22.2).
- d) Checksum (see 6.17).
- e) Retention and acknowledgement of PDUs (see 6.13).

- f) Frozen references (see 6.18).
- g) Retransmission procedures – When a transport entity has some outstanding TPDU's that require acknowledgment, it will check that no TI interval elapses without the arrival of a TPDU that acknowledges at least one of the outstanding TPDU's.

If the timer expires, except if the TPDU to be retransmitted is a DT-TPDU and it is outside the transmit window due to credit reduction, the first TPDU is retransmitted and the timer is restarted. After N transmissions (i.e. $N - 1$ retransmissions) it is assumed that useful two-way communication is no longer possible and the release procedure is used, and the TS-user is informed.

NOTES

- 1 This procedure may be implemented by different means. For example:
 - a) one interval is associated with each TPDU: if the timer expires the associated TPDU will be transmitted and the timer TI will be restarted for all subsequent TPDU's; or
 - b) one interval is associated with each transport connection:
 - 1) if the transport entity transmits a TPDU requiring acknowledgment, it starts timer TI ;
 - 2) if the transport entity receives a TPDU that acknowledges one of the TPDU's to be acknowledged, it restarts timer TI unless the received TPDU is an AK which explicitly closes the transmit window;
 - 3) if the transport entity receives a TPDU that acknowledges the last TPDU to be acknowledged, it stops timer TI .

For a decision whether the retransmission timer TI is maintained on a per TPDU or on a per transport connection basis, throughput considerations have to be taken into account.

- 2 For DT-TPDU's it is a local choice to retransmit either only the first DT-TPDU or all TPDU's waiting for an acknowledgment up to the upper window edge.
- 3 It is recommended that after N transmissions, the transport entity waits $TI + W + M_{RL}$ to provide a higher possibility for receiving an acknowledgment before entering the release phase. For other TPDU types which may be retransmitted, it is recommended that after N transmissions the transport entity waits $TI + M_{RL}$ to provide a higher possibility of receiving the expected reply.
- 4 If use of selective acknowledgement has been negotiated, a selective acknowledgement implicitly identifies DT-TPDU's not received. Since such a DT-TPDU could be a lost DT-TPDU, or simply a delayed DT-TPDU, it is a local matter whether DT-TPDU's not acknowledged in a selective acknowledgement should be retransmitted immediately.

- h) Concatenation and separation (see 6.4).

12.2.2 Procedures for connection establishment

12.2.2.1 Timers used in connection establishment

There are no timers specific to connection establishment.

12.2.2.2 General procedures when operating over CONS

The transport entities shall use the following procedures:

- a) Assignment to network connection (see 6.1.1).
 When a network connection to which the transport connection is assigned is released (NDISind received):
 - 1) If a CC-TPDU is awaited the initiator shall perform a new assignment according to QOS and the retransmission procedure (i.e. not sending the CR-TPDU for more than $N \cdot TI$).
 - 2) If there is at least one other network connection to which the transport connection is assigned both initiator and acceptor may either perform a new assignment or continue operation using one of the remaining network connections.
 - 3) If the transport connection becomes unassigned the acceptor may either perform a new assignment or wait (there is no risk of deadlock as either TI or I_L will be running). The initiator shall perform a new assignment (except in the closing state).
- b) Connection establishment (see 6.5) and if appropriate connection refusal (see 6.6) together with the additional procedures:
 - 1) A connection is not considered established until the successful completion of a 3-way TPDU exchange. The sender of a CR-TPDU shall respond to the corresponding CC-TPDU by immediately sending a DT, ED, DR, or AK-TPDU.
 - 2) As a result of duplication or transmission, a CR-TPDU may be received specifying a source reference which is already in use with the sending transport entity. If the receiving transport entity is in the data transfer phase, having completed the 3-way TPDU exchange procedure, or is waiting for the T-CONNECT response from the TS-user, the receiving transport entity shall discard such a TPDU. Otherwise a CC-TPDU shall be transmitted.

- 3) As a result of duplication or retransmission, a CC-TPDU may be received specifying a paired reference which is already in use. The receiving transport entity shall only acknowledge the duplicate CC-TPDU according to the procedure in 12.2.2.2 b)1).
- 4) A CC-TPDU may be received specifying a reference which is in the frozen state. The response to such a TPDU shall be a DR-TPDU.
- 5) The retransmission procedures (see 12.2.1.2) are used for both the CR-TPDU and CC-TPDU.

NOTE – After receiving a CR-TPDU, it is recommended that the transport entity enforce a time limit upon the transport service user so that late acceptance of the transport connection will not cause a delayed CC-TPDU to be sent.

12.2.2.3 General procedures when operating over CLNS

The transport entity shall use the procedure of connection establishment (see 6.5) and if appropriate connection refusal (see 6.6) together with the additional procedures:

- 1) A connection is not considered established until the successful completion of a three-way TPDU exchange. The sender of a CR-TPDU shall respond to the corresponding CC-TPDU by immediately sending a DT, ED, DR or AK-TPDU.
- 2) As a result of duplication or retransmission, a CR-TPDU may be received specifying a source reference which is already in use with the sending transport entity. If the receiving transport entity is in the data transfer phase, having completed the three-way TPDU exchange procedure, or is waiting for the T-CONNECT response from the TS-user, the receiving transport entity shall discard such a TPDU. Otherwise a CC-TPDU shall be transmitted.
- 3) As a result of duplication or retransmission, a CC-TPDU may be received specifying a paired reference which is already in use. The receiving transport entity shall only acknowledge the duplicate CC-TPDU according to the procedure in 12.2.2.3.1.
- 4) A CC-TPDU may be received specifying a reference which is in the frozen state. The response to such a TPDU shall be a DR-TPDU.
- 5) The retransmission procedures (see 12.2.1.3) are used for both the CR-TPDU and CC-TPDU.

NOTE – After receiving a CR-TPDU, it is recommended that the transport entity enforce a time limit upon the transport service user so that late acceptance of the transport connection will not cause a delayed CC-TPDU to be sent.

12.2.3 Procedures for data transfer

12.2.3.1 Timers used in data transfer

12.2.3.1.1 Timers used in data transfer when operating over CONS

The data transfer procedures use one additional timer:

- Window timer (W)

A transport entity maintains a timer interval to ensure that there is a bound on the maximum interval between window updates.

NOTE – A suitable upper bound value for W is such that $W < I_R - E_{LR}$. It is recommended that the value for W be sufficiently less than $(I_R - E_{LR})$ such that the inactivity control procedure in 12.2.3.3 can be operated having regard to the possibility of TPDU loss.

12.2.3.1.2 Timers used in data transfer when operating over CLNS

The data transfer procedures use one additional timer:

- Window timer (W)

A transport entity maintains a timer interval to ensure that there is a bound on the maximum interval between window updates.

NOTE – A suitable upper band value for W is such that $W < I_R - E_{LR}$. It is recommended that the value for W be sufficiently less than $(I_R - E_{LR})$ such that the inactivity control procedure in 12.2.3.3 can be operated having regard to the possibility of TPDU loss.

12.2.3.2 General procedures for data transfer

The transport entities shall use the following procedures:

- a) inactivity control (see 6.21);
- b) expedited data (see 6.11);
- c) explicit flow control (see 6.16).

ISO/IEC 8073 : 1997 (E)

The sending transport entity shall use the following procedures in the following order:

- 1) segmenting (see 6.3);
- 2) DT-TPDU numbering (see 6.10).

The receiving transport entity shall use the following procedures in the following order:

- DT-TPDU numbering (see 6.10);
- resequencing (see 6.20);
- reassembling (see 6.3).

12.2.3.3 Inactivity control

If the interval of the inactivity timer I expires without receipt of some TPDU, the transport entity shall initiate the release procedures. To prevent expiration of the remote transport entity's inactivity timer when no data is being sent, the local transport entity must send AK-TPDUs at suitable intervals in the absence of data, having regard to the probability of TPDU loss. The window synchronization procedures (see 12.2.3.8) ensure that this requirement is met.

NOTE – It is likely that the release procedure initiated due to the expiration of the inactivity timer will fail, as such expiration indicates probable failure of the supporting network connection or of the remote transport entity.

12.2.3.4 Expedited data

12.2.3.4.1 Expedited data when operating over CONS

The transport entities shall follow the network normal data variant of the expedited data transfer procedures (see 6.11.1), if the use of the transport expedited service option has been agreed during connection establishment.

The ED-TPDU shall have a TPDU-NR which is allocated from a separate sequence space from that of the DT-TPDUs.

A transport entity shall allocate the sequence number zero to the ED-TPDU-NR of the first ED-TPDU which it transmits for a transport connection. For subsequent ED-TPDUs sent on the same transport connection, the transport entity shall allocate a sequence number one greater than the previous one.

Modulo 2^7 arithmetic shall be used when normal formats have been selected and modulo 2^{31} arithmetic shall be used when extended formats have been selected.

When a transport entity receives an ED-TPDU:

- a) if the ED-TPDU is the first ED-TPDU received and has sequence number set to zero, or if the ED-TPDU has sequence number one greater than in the last received in-sequence ED-TPDU, the receiving transport entity shall transmit an EA-TPDU with the received sequence number in its YR-EDTU-NR field and shall transfer the data in the ED-TPDU to the TS-user;
- b) if the sequence number of the received ED-TPDU is equal to the sequence number in the most recently sent EA-TPDU, the transport entity shall only transmit an EA-TPDU, with the same sequence number in its YR-EDTU-NR field;
- c) if the received ED-TPDU is the first ED-TPDU received and its sequence number is not zero, the receiving transport entity shall treat this as a protocol error;
- d) otherwise, the receiving transport entity shall discard the received ED-TPDU.

The sending transport entity shall discard a received EA-TPDU when its sequence number is not equal to the unacknowledged ED-TPDU or the entity is not waiting for an EA-TPDU. But if the entity has never sent an ED-TPDU, the entity shall treat this as a protocol error.

If a transport entity does not receive an EA-TPDU in acknowledgement to an ED-TPDU it shall follow the retransmission procedures (see Note and 12.2.1.2).

If non-use of the non-blocking expedited data transfer service is negotiated, the sender of an ED-TPDU shall not send any new DT-TPDU created from a T-DATA request subsequent to the T-EXPEDITED DATA request, until it receives the EA-TPDU.

If use of the non-blocking expedited data transfer service is negotiated, the sender of an ED-TPDU shall insert the ED-TPDU-NR into the first DT-TPDU created from a T-DATA request subsequent to the T-EXPEDITED DATA request, and the transmission of the DT-TPDUs will not be interrupted. If a received DT-TPDU contains an additional ED-TPDU-NR parameter, the data of this DT-TPDU shall not be delivered to the TS-user prior to the expedited data of the ED-TPDU that has this sequence number.

NOTE – This procedure ensures that ED-TPDUs are delivered to the TS-user in sequence and that the TS-user does not receive data corresponding to the same ED-TPDU more than once. Also it guarantees the arrival of the ED-TPDU before any data subsequently sent by the TS-user.

12.2.3.4.2 Expedited data when operating over CLNS

The transport entities shall follow the expedited data transfer procedures in 6.11.2, if the use of the transport expedited data service option has been agreed during connection establishment.

The ED-TPDU shall have a TPDU-NR which is allocated from a separate sequence space from that of the DT-TPDUs.

A transport entity shall allocate the sequence number zero to the ED-TPDU-NR of the first ED-TPDU which it transmits for a transport connection. For subsequent ED-TPDUs sent on the same transport connection, the transport entity shall allocate a sequence number one greater than the previous one.

Modulo 2^7 arithmetic shall be used when normal formats have been selected and modulo 2^{31} arithmetic shall be used when extended formats have been selected.

When a transport entity receives an ED-TPDU:

- a) if the ED-TPDU is the first ED-TPDU received and has sequence number set to zero, or if the ED-TPDU has sequence number one greater than in the last received in-sequence ED-TPDU, the receiving transport entity shall transmit an EA-TPDU with the received sequence number in its YR-EDTU-NR field, and shall transfer the data in the ED-TPDU to the TS-user;
- b) if the sequence number of the received ED-TPDU is equal to the sequence number in the most recently sent EA-TPDU, the transport entity shall only transmit an EA-TPDU, with the same sequence number in its YR-EDTU-NR field;
- c) if the received ED-TPDU is the first ED-TPDU received and its sequence number is not zero, the receiving transport entity shall treat this as a protocol error;
- d) otherwise, the receiving transport entity shall discard the received ED-TPDU.

The sending transport entity shall discard a received EA-TPDU when its sequence number is not equal to the unacknowledged ED-TPDU or the entity is not waiting for an EA-TPDU. But if the entity has never sent an ED-TPDU, the entity shall treat this as a protocol error.

If a transport entity does not receive an EA-TPDU in acknowledgment to an ED-TPDU, it shall follow the retransmission procedures (see Note and 12.2.1.3).

If non-use of the non-blocking expedited data transfer service is negotiated, the sender of an ED-TPDU shall not send any new DT-TPDU created from a T-DATA request subsequent to the T-EXPEDITED DATA request, until it receives the EA-TPDU.

If use of the non-blocking expedited data transfer service is negotiated, the sender of an ED-TPDU shall insert the ED-TPDU-NR into the first DT-TPDU created from a T-DATA request subsequent to the T-EXPEDITED DATA request, and the transmission of the DT-TPDUs will not be interrupted. If a received DT-TPDU contains an additional ED-TPDU-NR parameter, the data of this DT-TPDU shall not be delivered to the TS-user prior to the expedited data of the ED-TPDU that has this sequence number.

NOTE – This procedure ensures that ED-TPDUs are delivered to the TS-user in sequence and that the TS-user does not receive data corresponding to the same ED-TPDU more than once. Also it guarantees the arrival of the ED-TPDU before any data subsequently sent by the TS user.

12.2.3.5 Resequencing

The receiving transport entity shall deliver all in sequence and within the transmit window DT-TPDUs to the TS-user in the order specified by the sequence number field.

DT-TPDUs received out-of-sequence but within the transmit window shall not be delivered to the TS-user until all in-sequence TPDU's have been received. DT-TPDUs received outside the transmit window shall be discarded but may result in transmission of an AK-TPDU with up-to-date window information (see 12.2.3.8). If the selective acknowledgement option has been agreed to at connection establishment, DT-TPDUs that have been selectively acknowledged shall be retained by the receiving transport entity until delivered to the TS-user. They shall be retained even if the selectively acknowledged DT-TPDUs later fall outside the transmit window due to a subsequent credit reduction.

NOTE – It is recommended that the transport entity sending the AK-TPDU maintain a bound on the number of times a DT-TPDU is selectively acknowledged in order to reduce the processing at the transport entity receiving the AK-TPDU.

ISO/IEC 8073 : 1997 (E)

Duplicate TPDU's can be detected because the sequence number matches that of previously received-TPDU's. Sequence numbers shall not be reused for the period L after their previous use. Otherwise, a new, valid TPDU could be confused with a duplicated TPDU which had previously been received and acknowledged.

Duplicated DT-TPDU's shall be acknowledged, since the duplicated TPDU may be the result of a retransmission resulting from the loss of an AK-TPDU.

The data contained in a duplicated DT-TPDU shall be discarded.

12.2.3.6 Explicit flow control

The transport entities shall send an initial credit (which may take the value 0) in the CDT field of the CR-TPDU or CC-TPDU. This credit represents the initial value of the upper window edge of the peer entity.

The transport entity receives the CR-TPDU or CC-TPDU shall consider its lower window edge as zero and its upper window edge as the value in the CDT field in the received TPDU; and the entity shall behave as if it had previously sent/received an AK-TPDU with the YR-TU-NR and subsequence number parameter value set to zero.

In order to authorize the transmission of DT-TPDU's by its peer, a transport entity may transmit an AK-TPDU at any time.

The sequence number of AK-TPDU shall not exceed the sequence number of the next expected DT-TPDU, i.e. it shall not be greater than the highest sequence number of a received DT-TPDU, plus one.

A transport entity may send a duplicate AK-TPDU containing the same sequence number, CDT, and subsequence number field at any time.

A transport entity may increase or decrease the upper window edge at any time.

A transport entity which receives an AK-TPDU shall consider the value of the YR-TU-NR field as its new lower window edge if it is greater than any previously received in a YR-TU-NR field, and the sum of YR-TU-NR and CDT as its new upper window edge subject to the procedures for sequencing AK-TPDU's (see 12.2.3.8). A transport entity shall not transmit or retransmit a DT-TPDU with a sequence number outside the transmit window.

12.2.3.7 Sequencing of received AK-TPDU's

To allow a receiving transport entity to properly sequence a series of AK-TPDU's that all contain the same sequence number and thereby use the correct CDT value, AK-TPDU's may contain a subsequence parameter. For the purpose of determining the correct sequence of AK-TPDU's, the absence of the subsequence parameter shall be equivalent to the value of the parameter set to zero.

An AK-TPDU is defined to be in sequence if:

- a) the sequence number is greater than any previously received AK-TPDU; or
- b) the sequence number is equal to the highest in any previously received AK-TPDU, and the subsequence parameter is greater than in any previously received AK-TPDU having the same value for YR-TU-NR field; or
- c) the sequence number and subsequence parameter are both equal to the highest in any previously received AK-TPDU and the credit field is greater than or equal to that in any previously received AK-TPDU having the same YR-TU-NR field.

When the receiving transport entity recognizes an out-of-sequence AK-TPDU it shall discard it.

12.2.3.8 Procedures for transmission of AK-TPDU's

12.2.3.8.1 Transmission of AK-TPDU's

An in-sequence and within the window DT-TPDU shall be acknowledged within time A_L , by the transmission of an AK-TPDU whose YR-TU-NR parameter is set to at least the sequence number of the received DT-TPDU plus one. If the selective acknowledgement option has been agreed to at connection establishment, out of sequence DT-TPDU's may also be acknowledged within time A_L . The YR-TU-NR parameter shall be set to one greater than the highest sequence number of an in-sequence DT-TPDU and the selective acknowledgement parameter will be appropriately set.

An AK-TPDU shall be transmitted, within time A_L , containing up-to-date window information if:

- a) a DT-TPDU is received whose sequence number is lower than the lower window edge, but greater than or equal to the lower window edge minus the maximum credit value ever given for this transport connection;
or

- b) a DT-TPDU is received whose sequence number is above the current upper window edge, but following credit reduction is within the upper window edge which has been granted and then withdrawn.

NOTE 1 – A simpler implementation may send an AK-TPDU upon reception of any DT-TPDU outside the transmit window.

NOTE 2 – The procedure a) is required so that loss of an AK-TPDU is correctly recovered, i.e. when the sender of the DT-TPDU retransmits it following non-receipt of an acknowledgement.

NOTE 3 – The procedure b) is required due to the possibility of loss of the AK-TPDU indicating the upper window edge reduction, which could otherwise cause incorrect termination of the transport connection.

NOTE 4 – Wherever procedures a) and b) are invoked and selective acknowledgement option is being used, the selective acknowledgement parameters, if required, of the AK-TPDU will be appropriately set.

A transport entity shall not allow an interval W to pass without the transmission of an AK-TPDU. If the transport entity is not using the procedure following setting CDT to zero (see 12.2.3.8.3) or reduction of the upper window edge (see 12.2.3.8.4), and does not have to acknowledge receipt of any DT-TPDU, then it shall achieve this by retransmission of the most recent AK-TPDU, with up-to-date window information.

NOTE 5 – The use of the procedures defined in 12.2.3.8.3 and 12.2.3.8.4 is optional for any transport entity. The protocol operates correctly either with or without these procedures which are defined to enhance the efficiency of its operation.

12.2.3.8.2 Sequence control for transmission of AK-TPDUs

To allow the receiving transport entity to process AK-TPDUs in the correct sequence, as described in 12.2.3.7, the subsequence parameter shall be included following reduction of CDT. If the value of the subsequence number to be transmitted is zero, then the parameter should be omitted.

The value of the subsequence parameter, if used, shall be zero (either explicitly or by absence of the parameter) if the sequence number is greater than the parameter in previous AK-TPDUs, sent by the transport entity.

If the sequence number is the same as the previous AK-TPDU sent and the CDT field is equal to or greater than the CDT field in the previous AK-TPDU sent, then the subsequence parameter, if used, shall be equal to that in the previously sent AK-TPDU.

If the sequence number is the same as the previous AK-TPDU sent and the CDT field is less than the value of the CDT field in the previous AK-TPDU sent, then the subsequence parameter, if used, shall be one greater than the value in the previous AK-TPDU.

NOTE – If a transport entity never reduces credit, then it does not need to use the subsequence number.

12.2.3.8.3 Retransmission of AK-TPDUs after CDT set to zero

Due to the possibility of loss of AK-TPDUs, the upper window edge as perceived by the transport entity transmitting an AK-TPDU may differ from that perceived by the intended recipient. To avoid the possibility of extra delay, the retransmission procedure (see 12.2.1.2 and 12.2.1.3) can be followed for an AK-TPDU, if it opens the transmit window which has previously been closed by sending an AK-TPDU with CDT field set to zero.

The retransmission procedure, if used, terminates and the procedure in 12.2.3.8.1 is used when:

- a) an AK-TPDU is received containing the flow control confirmation parameter, whose lower window edge and your subsequence fields are equal to the sequence number and subsequence number in the retained AK-TPDU and whose credit field is not zero;
- b) an AK-TPDU is transmitted with a sequence number higher than that in the retained AK-TPDU, due to reception of a DT-TPDU whose sequence number is equal to the lower window edge;
- c) N transmissions of the retained AK-TPDU have taken place. In this case the transport entity shall continue to transmit the AK-TPDU at an interval of W .

An AK-TPDU which is subject to the retransmission procedure shall not contain the flow control confirmation parameter. If it is required to transmit this parameter concurrently, an additional AK-TPDU shall be transmitted having the same values in the sequence, subsequence (if applicable) and credit fields.

12.2.3.8.4 Retransmission procedures following reduction of the upper window edge

This subclause specifies the procedure for retransmission of AK-TPDUs after a transport entity has reduced the upper window edge (see 12.2.3.6). This procedure is used until the lower window edge exceeds the highest value of the upper window edge ever transmitted (i.e. the value existing at the time of credit reduction, unless a higher value is retained from a previous credit reduction).

ISO/IEC 8073 : 1997 (E)

The retransmission procedure should be followed for any AK-TPDU which increases the upper window edge, unless it is known that the remote transport entity has an open window. This is known if:

- a Flow Control Confirmation (FCC) parameter has been received corresponding to an AK-TPDU transmitted following the most recent credit reduction; and
- this FCC parameter conveys an upper window edge value (i.e. the sum of the lower window edge and credit fields) which is greater than the lower window edge of the transmitted AK-TPDU.

This retransmission procedure for any particular AK-TPDU shall terminate when:

- a) an AK-TPDU is received containing the flow control confirmation parameter, whose lower window edge and your subsequence fields are equal to the lower window edge and subsequence number in the retained AK-TPDU; or
- b) *N* transmissions of the retained AK-TPDU have taken place. In this case the transport entity shall continue to transmit the AK-TPDU at an interval of *W*.

An AK-TPDU which is subject to the retransmission procedure shall not contain the flow control confirmation parameter. If it is required to transmit this parameter concurrently, an additional AK-TPDU shall be transmitted having the same values in the sequence, subsequence (if applicable) and credit fields.

NOTE – Retransmission of AK-TPDUs is normally not necessary, except following explicit closing of the window (i.e. transmission of an AK-TPDU with CDT field set to zero). If data are available for transmission, the retransmission procedure for DT-TPDUs will ensure that an AK-TPDU is received granting further credit where this is available; following credit reduction, this may no longer be so, because retransmission may be inhibited by the credit reduction. The rules described in this subclause avoid extra delay.

The rules for determining whether to apply the retransmission procedure to an AK-TPDU may be expressed alternatively as follows. Let

LWE be the lower window edge,

UWE be the upper window edge,

KUWE be the lower bound on upper window edge held by remote transport entity.

The retransmission procedure is to be applied whenever:

$$(UWE > LWE) \text{ and } (KUWE = LWE)$$

i.e. when the window is opened and it is not known definitely that the remote transport entity is aware of this.

KUWE is maintained as follows:

When credit is reduced, KUWE is set to LWE. Subsequently, it is increased only upon receipt of a valid flow control confirmation (i.e. one which matches the retained lower window edge and subsequence). In this case KUWE is set to the implied upper window edge of the flow control confirmation, i.e. the sum of its lower window edge and your credit fields. By using this method, it can be ensured that KUWE is always less than or equal to the actual upper window edge used by the transmitter of DT-TPDUs.

12.2.3.9 Use of flow control confirmation parameter

An AK-TPDU containing a flow control confirmation parameter may be transmitted at any time. The lower window edge, your subsequence and your credit fields shall be set to the same values as the corresponding fields in the most recently received in-sequence AK-TPDU.

An AK-TPDU containing a flow control confirmation parameter should be transmitted whenever

- a) a duplicate AK-TPDU is received, with the value of YR-TU-NR, CDT, and subsequence fields equal to the most recently received in sequence AK-TPDU, but not itself containing the flow control confirmation parameter;
- b) an AK-TPDU is received which increases the upper window edge but not the lower window edge, and the upper window edge was formerly equal to the lower window edge; or
- c) an AK-TPDU is received which increases the upper window edge but not the lower window edge, and the lower window edge is lower than the highest value of the upper window edge received and subsequently reduced (i.e. following credit reduction).

12.2.4 Procedures for release

12.2.4.1 Timers used for release

There are no timers used only for release.

12.2.4.2 General procedures for release

The transport entity shall use the explicit variant of normal release (see 6.7).

Although the retransmission procedure also apply to the DR-TPDU in the release phase, the transport entity may however consider that the transport connection has been released if it would be necessary to open a new network connection in order to retransmit the DR-TPDU.

13 Structure and encoding of TPDU

13.1 Validity

Table 8 specifies those TPDU which are valid for each class and the code for each TPDU.

Table 8 – TPDU codes

	Validity within classes					See sub-clause	Code
	0	1	2	3	4		
CR Connection request	x	x	x	x	x	13.3	1110 xxxx
CC Connection confirm	x	x	x	x	x	13.4	1101 xxxx
DR Disconnect request	x	x	x	x	x	13.5	1000 0000
DC Disconnect confirm		x	x	x	x	13.6	1100 0000
DT Data	x	x	x	x	x	13.7	1111 000y
ED Expedited data		x	NF	x	x	13.8	0001 0000
AK Data acknowledgement		NRC	NF	x	x	13.9	0110 zzzz
EA Expedited data acknowledgement		x	NF	x	x	13.10	0010 0000
RJ Reject		x		x		13.11	0101 zzzz
ER TPDU error	x	x	x	x	x	13.12	0111 0000
Not available (see Note)						--	0000 0000
						--	0011 0000
						--	1001 xxxx
						--	1010 xxxx
xxxx (bits 4 to 1) Used to signal the CDT (set to 0000 in classes 0 to 1) zzzz (bits 4 to 1) Used to signal CDT in classes 2, 3, 4 set to 1111 in class 1 y (bit 1) Used to signal ROA if the request acknowledgement procedure has been agreed at connection establishment (classes 1, 3, 4 only). This bit shall be set to 0 if the request acknowledgement procedure has not been agreed. NF Not available when the non-explicit flow control option is selected NRC Not available when the receipt confirmation option is selected NOTE – These codes are already in use in related protocols defined by standards organizations other than ITU-T and ISO/IEC.							

13.2 Structure

All the Transport Protocol Data Units (TPDUs) shall contain an integral number of octets. The octets in a TPDU are numbered starting from 1 and increasing in the order they are put into an NDSU. The bits in an octet are numbered from 1 to 8, where bit 1 is the lowest order bit.

ISO/IEC 8073 : 1997 (E)

When consecutive octets are used to represent a binary number, the lower octet number has the most significant value.

NOTES

- 1 The numbering of bits within an octet is a convention local to this Recommendation | International Standard.
- 2 The use of the terms “high order” and “low order” is common to this Recommendation | International Standard and to adjacent layer Standards.
- 3 The use of the above conventions does not affect the order of bit transmission on a serial communications link.
- 4 As described in 6.2.3, both transport entities respect these bit and octet ordering conventions, thus allowing communication to take place.
- 5 In this clause the encoding of TPDU's is represented in the following form:
 - a) octets are shown with the lowest numbered octet to the left; higher numbered octets being further to the right;
 - b) within an octet, bits are shown with bit 8 to the left and bit 1 to the right.

TPDU's shall contain, in the following order:

- a) the header, comprising:
 - 1) the Length Indicator (LI) field;
 - 2) the fixed part;
 - 3) the variable part, if present;
- b) the data field, if present.

The structure is illustrated below:

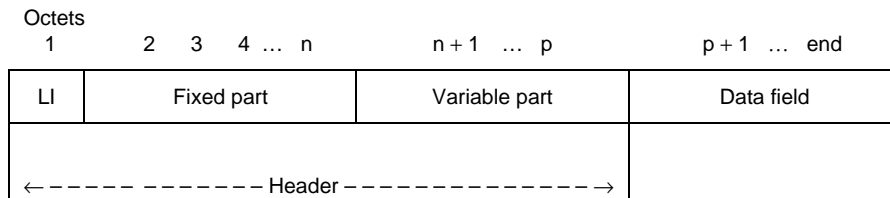

13.2.1 Length indicator field

The field is contained in the first octet of the TPDU's. The length is indicated by a binary number, with a maximum value of 254 (1111 1110). The length indicated shall be the header length in octets including parameters, but excluding the length indicator field and user data, if any. The value 255 (1111 1111) is reserved for possible extensions.

If the length indicated exceeds or is equal to the size of the NS-user data which is present, this is a protocol error.

13.2.2 Fixed part

13.2.2.1 General

The fixed part contains frequently occurring parameters including the code of the TPDU. The length and the structure of the fixed part are defined by the TPDU code and in certain cases by the protocol class and the formats in use (normal or extended). If any of the parameters of the fixed part have an invalid value, or if the fixed part cannot be contained within the header (as defined by LI), this is a protocol error.

NOTE – In general, the TPDU code defines the fixed part unambiguously. However, different variants may exist for the same TPDU code (see normal and extended formats).

13.2.2.2 TPDU code

This field contains the TPDU code and is contained in octet 2 of the header. It is used to define the structure of the remaining header. This field is a full octet except in the following cases:

- 1110 xxxx Connection request
- 1101 xxxx Connection confirm
- 1111 000y Data
- 0101 xxxx Reject
- 0110 xxxx Data acknowledgement

where

xxxx (bits 4 to 1) is used to signal the CDT.

y (bit 1) is used to signal ROA if the request acknowledgement has been agreed at connection establishment (class 1, 3, 4 only). This bit shall be set to 0 if the request acknowledgement procedure has not been agreed.

Only those codes defined in 13.1 are valid.

13.2.3 Variable part

The variable part is used to define less frequently used parameters. If the variable part is present, it shall contain one or more parameters.

NOTE 1 – The number of parameters that may be contained in the variable part is indicated by the length of the variable part which is LI minus the length of the fixed part.

Each parameter contained within the variable part is structured as follows:

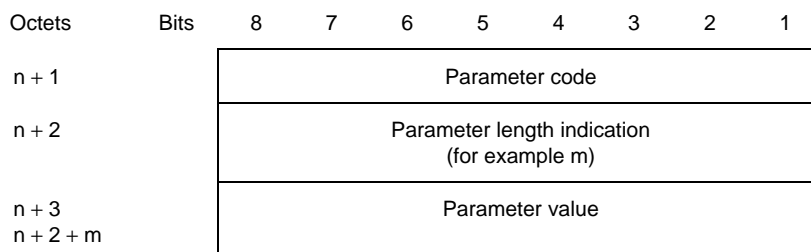

The parameter code field is coded in binary.

NOTE 2 – Without extensions, it provides a maximum number of 255 different parameters. However, as noted below, bits 8 and 7 cannot take every possible value, so the practical maximum number of different parameters is less. Parameter code 1111 1111 is reserved for possible extensions of the parameter code.

The parameter length indication indicates the length, in octets, of the parameter value field.

NOTE 3 – The length is indicated by a binary number, m, with a theoretical maximum value of 255. The practical maximum value of m is lower. For example, in the case of a single parameter contained within the variable part, two octets are required for the parameter code and the parameter length indication itself. Thus, the value of m is limited to 248. For larger fixed parts of the header and for each succeeding parameter, the maximum value of m decreases.

The parameter value field contains the value of the parameter identified in the parameter code field.

No parameter code uses bits 8 and 7 with the value 00.

The parameters defined in the variable part may be in any order. If any parameter is duplicated, then the last value shall be used. A parameter not defined in this Recommendation | International Standard shall be treated as a protocol error in any received TPDU except a CR-TPDU; in a CR-TPDU it shall be ignored. A responding Transport-Selector parameter in a CC-TPDU with a length indicator set to zero shall be treated as having the “nil selector value” (see 9.5.2 of CCITT Rec. X.650 and ISO/IEC 7498-3). If the responding transport entity selects a class for which a parameter of the CR-TPDU is not defined, it may ignore this parameter, except if it is the class and option parameter, or the alternative protocol class parameter which shall always be interpreted. A parameter defined in this Recommendation | International Standard but having an invalid value shall be treated as a protocol error in any received TPDU except a CR-TPDU. In a CR-TPDU it shall be treated as a protocol error if it is either the class and option parameter or the alternative class parameter; bits 8 to 7 and bits 6 to 1, if not meaningful for the class proposed, of the additional options parameter, shall be ignored; otherwise it shall be either ignored or treated as a protocol error.

13.2.3.1 Checksum parameter (class 4 only)

All TPDU types may contain a 16-bit checksum parameter in their variable part. This parameter shall be present in a CR-TPDU and shall be present in all other TPDUs except when the non-use of checksum option is selected.

Parameter code:	1100 0011
Parameter length:	2
Parameter value:	Result of checksum algorithm; this algorithm is specified in 6.17.

13.2.4 Data field

This field contains transparent user data. Restrictions on its size are noted for each TPDU.

13.3 Connection Request (CR) TPDU

The length of the CR-TPDU shall not exceed 128 octets.

13.3.1 Structure

The structure of the CR-TPDU shall be as follows:

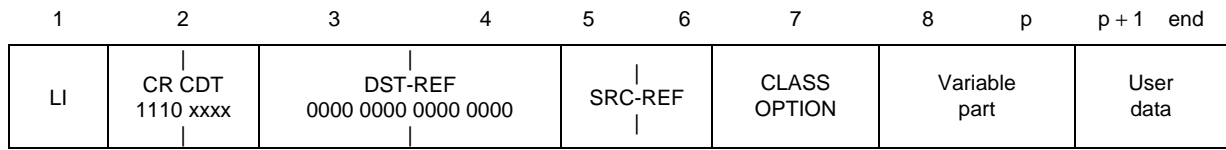

13.3.2 LI

See 13.2.1.

13.3.3 Fixed part (octets 2 to 7)

The structure of this part shall contain:

- a) CR – Connection request code: 1110. Bits 8 to 5 of octet 2.
- b) CDT – Initial credit allocation (set to 0000 in classes 0 and 1 when specified as preferred class). Bits 4 to 1 of octet 2.
- c) DST-REF – Set to zero.
- d) SRC-REF – Reference selected by the transport entity initiating the CR-TPDU to identify the requested transport connection.
- e) CLASS OPTION – Bits 8 to 5 of octet 7 define the preferred transport protocol class to be operated over the requested transport connection. When operating over CONS, this field shall take one of the following values:
 - 0000 Class 0;
 - 0001 Class 1;
 - 0010 Class 2;
 - 0011 Class 3;
 - 0100 Class 4.

When operating over CLNS, this field shall take the value 0100 to indicate class 4.

The CR-TPDU contains the first choice of class in the fixed part. Second and subsequent choices are listed in the variable part if required.

Bits 4 to 1 of octet 7 define options to be used on the requested transport connection as follows:

Bit	Option
4	= 0 Always
3	= 0 Always
2	= 0 Use of normal formats in all classes = 1 Use of extended formats in classes 2, 3, and 4
1	= 0 Use of explicit flow control in class 2 = 1 No use of explicit flow control in class 2

Bits related to options particular to a class are not meaningful if that class is not proposed and may therefore take any value.

NOTES

- 1 The connection establishment procedure (see 6.5) does not permit a given CR-TPDU to request use of transport expedited data transfer service (additional option parameter) and not use of explicit flow control in class 2 (bit 1 = 1).
- 2 Bits 4 to 1 are always zero in class 0 and have no meaning.

13.3.4 Variable part (octets 8 to p)

The following parameters are permitted in the variable part:

a) *Transport-Selector (T-selector)*

Parameter code: 1100 0001 for the identifier of the calling Transport-Selector
 1100 0010 for the identifier of the called Transport-Selector in the context of CR-TPDU or for identifier of the responding Transport-Selector in the context of CC-TPDU.

Parameter length: Not defined in this Recommendation | International Standard

Parameter value: Identifier of the Transport-Selector

If a Transport-Selector is given in the request it may be returned in the confirmation.

b) *TPDU size*

This parameter defines the proposed maximum TPDU size (in octets including the header) to be used over the requested transport connection. The coding of this parameter is:

Parameter code: 1100 0000

Parameter length: 1 octet

Parameter value: 0000 1101 8192 octets (not allowed in class 0)

0000 1100 4096 octets (not allowed in class 0)

0000 1011 2048 octets

0000 1010 1024 octets

0000 1001 512 octets

0000 1000 256 octets

0000 0111 128 octets

Default value: 0000 0111 (128 octets).

c) *Preferred maximum TPDU size*

This parameter defines the proposed maximum TPDU size (in octets including the header) to be used over the requested transport connection.

The coding of this parameter is:

Parameter Code: 1111 0000

Parameter length: up to 4

Parameter value: A binary value. The binary value indicates the maximum TPDU size, expressed as a multiple of 128 octets [see 6.5.4 k) and 6.5.5 k)]. This binary value shall be greater than or equal to 1.

d) *Version number* (not used if class 0 is the preferred class)

Parameter code: 1100 0100

Parameter length: 1 octet

Parameter value field: 0000 0001

Default value: 0000 0001 (not used in class 0).

e) *Protection parameters* (not used if class 0 is the preferred class)

This parameter is user defined.

Parameter code: 1100 0101

Parameter length: User defined

Parameter value: User defined.

f) *Checksum* (used only if class 4 is the preferred class) (see 13.2.3.1)

This parameter shall always be present in a CR-TPDU requesting class 4, even if the checksum selection parameter is used to request non-use of the checksum facility.

g) *Additional option selection* (not used if class 0 is the preferred class)

This parameter defines the selection to be made as to whether or not additional options are to be used.

Parameter code: 1100 0110

Parameter length: 1

Parameter value:

Bit	Option
7	= 1 Use of non-blocking expedited data in class 4 = 0 Non-use of non-blocking expedited data in class 4
6	= 1 Use of request acknowledgement in class 1, 3, 4 = 0 Non-use of request acknowledgement in classes 1, 3, 4
5	= 1 Use of selective acknowledgement in class 4 = 0 Non-use of selective acknowledgement in class 4
4	= 1 Use of network expedited in class 1 = 0 Non-use of network expedited in class 1
3	= 1 Use of receipt confirmation in class 1 = 0 Use of explicit AK variant in class 1
2	= 0 16-bit checksum defined in 6.17 shall be used in class 4 = 1 16-bit checksum defined in 6.17 shall not be used in class 4
1	= 1 Use of transport expedited data transfer service = 0 Non-use of transport expedited data transfer service

Default value: 0000 0001.

Bits 8 and 7 shall be set to zero when sending the TPDU and ignored upon receipt.

Bits related to options particular to a class are not meaningful if that class is not proposed and may therefore take any value.

h) *Alternative protocol class(es)* (not used if class 0 is the preferred class or when operating over CLNS)

Parameter code: 1100 0111

Parameter length: *n*

Parameter value: Encoded as a sequence of single octets; each encoded as for octet 7 but with bits 4 to 1 set to zero (i.e. no alternative option selections permitted).

i) *Acknowledgement time* (used only if class 4 is the preferred class)

This parameter conveys the maximum acknowledgement time A_L to the remote transport entity. It is an indication only, and is not subject to negotiation (see 12.2.1.1.3).

Parameter code: 1000 0101

Parameter length: 2

Parameter value: *n*, a binary number where *n* is the maximum acknowledgement time, expressed in milliseconds.

j) *Throughput* (not used if class 0 is the preferred class)

Parameter code: 1000 1001

Parameter length: 12 or 24

Parameter value:

1st 12 octets: maximum throughput, as follows:

- first 3 octets: target value, calling-called user direction;
- second 3 octets: minimum acceptable, calling-called user direction;
- third 3 octets: target value, called-calling user direction;
- fourth 3 octets: minimum acceptable, called-calling user direction.

2nd 12 octets (optional): average throughput, as follows:

- fifth 3 octets: target value, calling-called user direction;
- sixth 3 octets: minimum acceptable, calling-called user direction;
- seventh 3 octets: target value, called-calling user direction;
- eighth 3 octets: minimum acceptable, called-calling user direction.

Where average throughput is omitted, it is considered to have the same value as the maximum throughput. Values are expressed in octets per second.

k) *Residual error rate* (not used if class 0 is the preferred class)

Parameter code: 1000 0110

Parameter length: 3

Parameter value:

- 1st octet: target value, power of 10;
- 2nd octet: minimum acceptable, power of 10;
- 3rd octet: TSDU size of interest, expressed as a power of 2.

l) *Priority* (not used if class 0 is the preferred class)

Parameter code: 1000 0111

Parameter length: 2

Parameter value: Integer (0 is the highest priority)

m) *Transit delay* (not used if class 0 is the preferred class)

Parameter code: 1000 1000

Parameter length: 8

Parameter value:

- first 2 octets: target value, calling-called user direction;
- second 2 octets: maximum acceptable, calling-called user direction;
- third 2 octets: target value, called-calling user direction;
- fourth 2 octets: maximum acceptable, called-calling user direction.

Values are expressed in milliseconds, and are based upon a TSDU size of 128 octets.

n) *Reassignment time* (not used if class 0 or 2 is the preferred class; if class 4 is preferred and class 3 is an alternate, it may be used)

This parameter conveys the Time to Try Reassignment (TTR) which shall be used when following the procedure for reassignment after failure (see 6.12).

Parameter code: 1000 1011

Parameter length: 2

Parameter value: n , a binary number where n is the TTR value expressed in seconds.

o) *Inactivity timer* (used only if class 4 is the preferred or selected class)

This parameter conveys the inactivity timer I_L to the remote transport entity. It is an indication only, and is not subject to negotiation (see 12.2.1.1.7).

Parameter code: 1111 0010

Parameter length: 4

Parameter value: A binary value. This binary value indicates the inactivity time expressed in milliseconds.

13.3.5 User data (octets $p + 1$ to the end)

No user data are permitted in class 0, and are optional in other classes. Where permitted, they shall not exceed 32 octets.

13.4 Connection Confirm (CC) TPDU

13.4.1 Structure

The structure of the CC-TPDU shall be as follows:

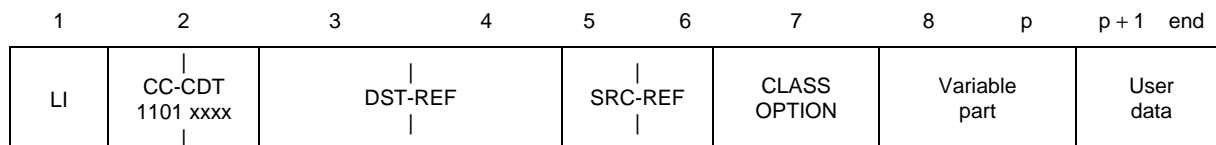

13.4.2 LI

See 13.2.1.

13.4.3 Fixed part (octets 2 to 7)

The fixed part shall contain:

- a) CC – Connection confirm code: 1101. Bits 8 to 5 of octet 2.
- b) CDT – Initial credit allocation (set to 0000 in classes 0 and 1). Bits 4 to 1 of octet 2.
- c) DST-REF – Reference identifying the requested transport connection at the remote transport entity.
- d) SRC-REF – Reference selected by the transport entity initiating the CC-TPDU to identify the confirmed transport connection.
- e) CLASS OPTION – Defines the selected transport protocol class and option to be operated over the accepted transport connection according to the negotiation rules specified in 6.5.

13.4.4 Variable part (octets 8 to p)

The parameters are defined in 13.3.4 and are subject to the constraints stated in 6.5 (connection establishment). Parameters ruled out by operation over CLNS or by selection of an alternative class and option shall not be present.

13.4.5 User data (octets p + 1 to the end)

No user data are permitted in class 0, and are optional in the other classes. Where permitted, they shall not exceed 32 octets. The user data are subject to the constraints of the negotiation rules (see 6.5).

13.5 Disconnect Request (DR) TPDU

13.5.1 Structure

The structure of the DR-TPDU shall be as follows:

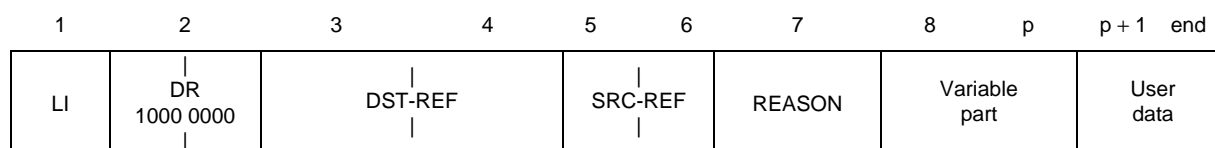

13.5.2 LI

See 13.2.1.

13.5.3 Fixed part (octets 2 to 7)

The fixed part shall contain:

- a) DR – Disconnect request code: 1000 0000.
- b) DST-REF – Reference identifying the transport connection at the remote transport entity.
- c) SRC-REF – Reference identifying the transport connection at the transport entity initiating the TPDU. Value zero when reference is unassigned.

- d) REASON – Defines the reason for disconnecting the transport connection. This field shall take one of the following values.

The following values may be used for classes 1 to 4:

- 1) 128 + 0 Normal disconnect initiated by session entity.
- 2) 128 + 1 Remote transport entity congestion at connect request time.
- 3) *128 + 2 Connection negotiation failed [i.e. proposed class(es) not supported].
- 4) 128 + 3 Duplicate source reference detected for the same pair of NSAPs.
- 5) 128 + 4 Mismatched references.
- 6) 128 + 5 Protocol error.
- 7) 128 + 6 Not used.
- 8) 128 + 7 Reference overflow.
- 9) 128 + 8 Connection request refused on this network connection.
- 10) 128 + 9 Not used.
- 11) 128 + 10 Header or parameter length invalid.

The following values can be used for all classes:

- 12) 0 Reason not specified.
- 13) 1 Congestion at TSAP.
- 14) *2 Session entity not attached to TSAP.
- 15) *3 Address unknown.

NOTE – Reasons marked with an asterisk (*) may be reported to the TS-user as persistent, other reasons as transient.

13.5.4 Variable part (octets 8 to p)

The variable may contain:

- a) A parameter allowing additional information related to the clearing of the connection:
 - Parameter code: 1110 0000
 - Parameter length: Any value provided that the length of the DR-TPDU does not exceed the maximum agreed TPDU size or 128 when the DR-TPDU is used during the connection refusal procedure.
 - Parameter value: Additional information. The content of this field is user defined.
- b) Checksum (see 13.2.3.1).

13.5.5 User data (octets p + 1 to the end)

This field shall not exceed 64 octets and is used to carry TS-user data. The successful transfer of this data is not guaranteed by the transport protocol. When a DR-TPDU is used in class 0 it shall not contain this field.

13.6 Disconnect Confirm (DC) TPDU

This TPDU shall not be used in class 0.

13.6.1 Structure

The structure of the DC-TPDU shall be as follows:

1	2	3	4	5	6	7	p
LI	DC 1100 0000	DST-REF	SRC-REF	Variable part			

ISO/IEC 8073 : 1997 (E)

13.6.2 LI

See 13.2.1.

13.6.3 Fixed part (octets 2 to 6)

The fixed part shall contain:

- a) DC – Disconnect confirm code: 1100 0000.
- b) DST-REF – See 13.4.3.
- c) SRC-REF – See 13.4.3.

13.6.4 Variable part

The variable part shall contain the checksum parameter if the condition defined in 13.2.3.1 applies.

13.7 Data (DT) TPDU

13.7.1 Structure

Depending on the class and the option the DT-TPDU shall have one of the following structures:

- a) *Normal format for classes 0 and 1:*

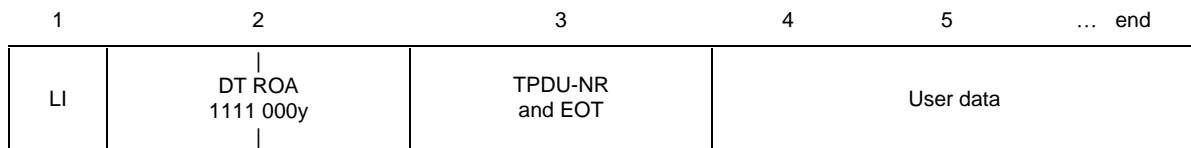

- b) *Normal format for classes 2, 3 and 4:*

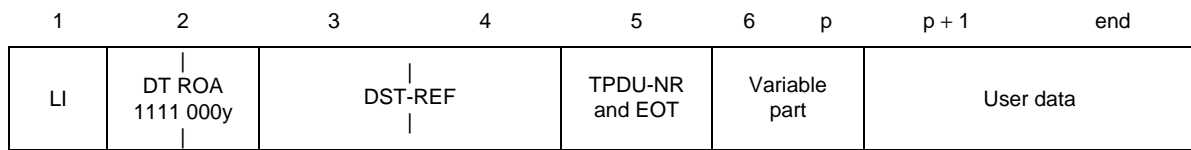

- c) *Extended format for use in classes 2, 3 and 4 when selected during connection establishment:*

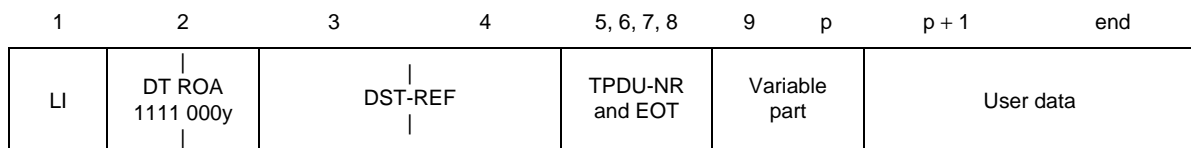

13.7.2 LI

See 13.2.1.

13.7.3 Fixed part

The fixed part shall contain:

- a) DT – Data transfer code: bits 8 to 5 shall be set to 1111. Bits 4 to 2 shall be set to zero.
- b) ROA – Request of acknowledgement mark: If the request acknowledgement procedures has not been agreed during connection establishment, bit 1 shall be set to 0 in all DT-TPDUs.

When the request acknowledgement procedure has been agreed during connection establishment, bit 1 (ROA) is used to request acknowledgement in classes 1, 3, and 4. When set to one, ROA indicates that the sending transport entity requests an acknowledgement from the receiving transport entity. Otherwise ROA is set to zero.

- c) DST-REF – See 13.4.3.
- d) EOT – When set to ONE, it indicates that the current DT-TPDU is the last data unit of a complete DT-TPDU sequence (end of TSDU). EOT is bit 8 of octet 3 in class 0 and 1 and bit 8 of octet 5 for classes 2, 3 and 4.
- e) TPDU-NR – TPDU send sequence number (zero in class 0). May take any value in class 2 without explicit flow control. TPDU-NR is bits 7 to 1 of octet 3 for classes 0 and 1, bits 7 to 1 of octet 5 for normal formats in classes 2, 3 and 4 and bits 7 to 1 of octet 5 together with octets 6, 7 and 8 for extended format.

NOTE – Depending on the class, the fixed part of the DT-TPDU uses the following octets:

- classes 0 and 1: octets 2 to 3;
- classes 2, 3, 4 (normal format): octets 2 to 5;
- classes 2, 3, 4 (extended format): octets 2 to 8.

13.7.4 Variable part

The variable part shall contain the checksum parameter if the condition defined in 13.2.3.1 applies.

If the use of non-blocking expedited data transfer service is negotiated (class 4 only), the variable part shall contain the ED-TPDU-NR for the first DT-TPDU created from a T-DATA request subsequent to the T-EXPEDITED DATA request.

- Parameter code: 1001 0000
- Parameter length: 2 (normal format)
4 (extended format)
- Parameter value: The ED-TPDU-NR of the ED-TPDU created from the T-EXPEDITED DATA request immediately before the T-DATA request that this DT-TPDU is created from.

NOTE – In the case of the normal format, a length of two octets is necessary (when one octet would suffice to express a modulo 2**7 arithmetic number) to ensure that the implicit rule that an even (resp. odd) LI always corresponds to the normal (resp. extended) format is not broken.

13.7.5 User data field

This field contains data of the TSDU being transmitted.

NOTE – The length of this field is limited to the negotiated TPDU size for this transport connection minus 3 octets in classes 0 and 1, and minus 5 octets (normal header format) or 8 octets (extended header format) in the other classes. The variable part, if present, may further reduce the size of the user data field.

13.8 Expedited Data (ED) TPDU

This ED-TPDU shall not be used in class 0 or in class 2 when the no explicit flow control option is selected or when the expedited data transfer service has not been selected for the connection.

13.8.1 Structure

Depending on the format negotiated at connection establishment the ED-TPDU shall have one of the following structures:

- a) *Normal format (classes 1, 2, 3, 4):*

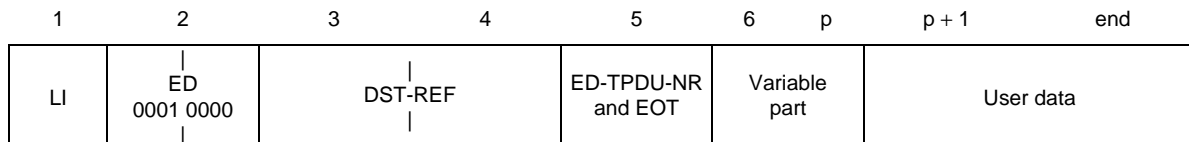

ISO/IEC 8073 : 1997 (E)

b) *Extended format (for use in classes 2, 3 and 4 when selected during connection establishment):*

1	2	3	4	5, 6, 7, 8	9	p	p + 1	end
LI	ED 0001 0000	DST-REF		ED-TPDU-NR and EOT	Variable part	User data		

13.8.2 LI

See 13.2.1.

13.8.3 Fixed part

The fixed part shall contain:

- a) ED – Expedited data code: 0001 0000.
- b) DST-REF – See 13.4.3.
- c) ED-TPDU-NR – Expedited TPDU identification number. ED-TPDU-NR is used in classes 1, 3 and 4 and may take any value in class 2. For normal formats, bits 7 to 1 of octet 5 and for extended formats, bits 7 to 1 of octet 5 together with octets 6, 7 and 8.
- d) EOT – End of TSDU always set to 1 (bit 8 of octet 5).

NOTE – Depending on the format, the fixed part shall be either octets 2 to 5 or 2 to 8.

13.8.4 Variable part

The variable part shall contain the checksum parameter if the condition defined in 13.2.3.1 applies.

13.8.5 User data field

This field contains an expedited TSDU (1 to 16 octets).

13.9 Data Acknowledgement (AK) TPDU

This TPDU shall not be used in class 0 or in class 2 when the no explicit flow control option is selected, nor for class 1 when the network receipt confirmation option is selected.

13.9.1 Structure

Depending on the class and option agreed, the AK-TPDU shall have one of the following structures:

a) *Normal format (classes 1, 2, 3, 4):*

1	2	3	4	5	6	p
LI	AK-CDT 0110 zzzz	DST-REF		YR-TU-NR	Variable part	

b) *Extended format (for use in classes 2, 3 and 4 when selected during connection establishment):*

1	2	3	4	5, 6, 7, 8	9	10	11	...	p
LI	AK 0110 0000	DST-REF		YR-TU-NR	CDT	Variable part			

13.9.2 LI

See 13.2.1.

13.9.3 Fixed part

The fixed part shall contain (in octets 2 to 5 when normal format is used or in octets 2 to 10) the following parameters:

- a) AK – Acknowledgement code: 0110.
- b) CDT – Credit value (set to 1111 in class 1). CDT is bits 4 to 1 of octet 2 for normal formats and octets 9 and 10 for extended formats.
- c) DST-REF – See 13.4.3.
- d) YR-TU-NR – Sequence number indicating the next expected DT-TPDU number. For normal formats, bits 7 to 1 of octet 5; bit 8 of octet 5 is not significant and shall take the value 0. For extended formats, bits 7 to 1 of octet 5 together with octets 6, 7 and 8; bit 8 of octet 5 is not significant and shall take the value 0.

13.9.4 Variable part

The variable part contains the following parameters:

- a) Checksum if the condition in 13.2.3.1 applies.
- b) Subsequence number when optionally used under the conditions defined in class 4. This parameter is used to ensure that AK-TPDUs are processed in the correct sequence. If it is absent, this is equivalent to transmitting the parameter with a value of zero.

Parameter code: 1000 1010

Parameter length: 2

Parameter value: 16-bit subsequence number.

- c) Flow control confirmation when optionally used under the conditions defined in class 4. This parameter contains a copy of the information received in an AK-TPDU, to allow the transmitter of the AK-TPDU to be certain of the state of the receiving transport entity (see 12.2.3.9).

Parameter code: 1000 1100

Parameter length: 8

Parameter value: Defined as follows:

- 1) Lower window edge (32 bits) – Bit 8 of octet 1 of the parameter value field is set to zero, the remainder contains the YR-TU-NR value of the received AK-TPDU. When normal format has been selected, only the least significant seven bits (bits 1 to 7 of octet 4 of the parameter value field) of this field are significant.
- 2) Your subsequence (16 bits) – Contains the value of the subsequence parameter of the received AK-TPDU, or zero if this parameter was not present.
- 3) Your credit (16 bits) – Contains the value of the CDT field of the received AK-TPDU. When normal format has been selected, only the least significant four bits (bits 1 to 4 of octet 2 of the your Credit field) of this field are significant.
- d) Selective acknowledgement parameters when optionally used, under conditions defined in class 4, to acknowledge out of sequence DT-TPDUs received by the entity transmitting the AK-TPDU. All consecutive DT-TPDUs received shall be acknowledged by a single block. Different groups of DT-TPDUs that are consecutive within group but not across groups, shall be acknowledged using separate blocks [e.g. if DT-TPDU numbers 3, 4, 5, 7, 8, 12, 13, 14, 15 and 17 are received with 3 the first out-of-sequence DT-TPDU, then 3, 4, 5 form one group, 7, 8 another and 12, 13, 14, 15 a third, and 17 a fourth. The corresponding blocks would be (3, 5), (7, 8), (12, 15) and (17, 17)].

Parameter code: 1000 1111

Parameter length: $2n$ (normal format) or $8n$ (extended format) octets where n is the number of distinct blocks being selectively acknowledged. This length is constrained by the maximum header size of 254 octets.

Parameter value: In the normal format, the first octet of a pair of two octets shall represent the lower edge and the second octet the upper edge of each block. Bit 8 of each octet is set to zero, the remainder represents the sequence number of the edge.

In the extended format, the first four octets of a set of eight octets represent the lower edge and the subsequent four octets represent the upper edge. For each edge of four octets, bit 8 of the first octet is not significant and is set to 0; bits 7 to 1 of the first octet together with the second, third and fourth octets represent the sequence number.

Whether normal or extended formats are used, each set of two or eight octets may be repeated as many times as there are blocks to be acknowledged.

13.10 Expedited Data Acknowledgement (EA) TPDU

The EA-TPDU shall not be used for class 0, or for class 2 when the “no explicit flow control” option is selected, or when the expedited data transfer service has not been selected for the connection.

13.10.1 Structure

Depending on the option (normal or extended format) the TPDU structure shall be:

a) *Normal format (classes 1, 2, 3, 4):*

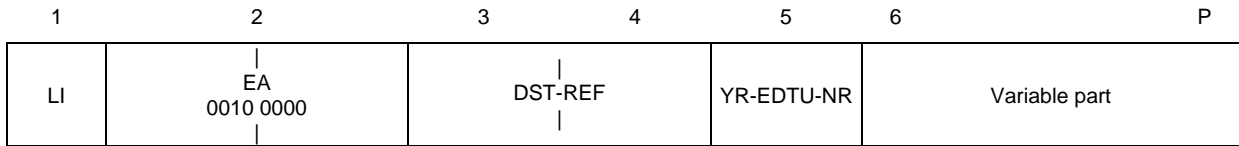

b) *Extended format (for use in classes 2, 3 and 4 if selected during connection establishment):*

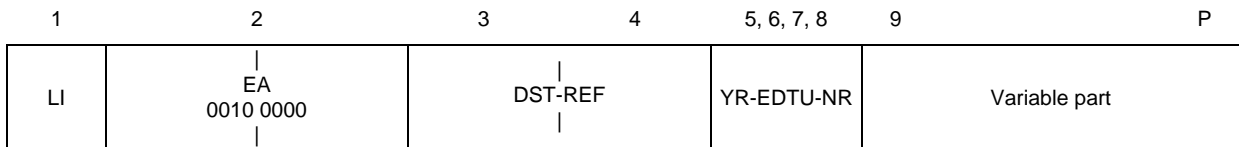

13.10.2 LI

See 13.2.1.

13.10.3 Fixed part

The fixed part shall contain (in octets 2 to 5 when normal format is used or in octets 2 to 8) the following parameters:

- a) EA – Expedited acknowledgement code: 0010 0000.
- b) DST-REF – See 13.4.3.
- c) YR-EDTU-NR – Identification of the ED-TPDU being acknowledged. May take any value in class 2. For normal formats bits 7 to 1 of octet 5; bit 8 of octet 5 is not significant and shall take the value 0. For extended formats, bits 7 to 1 of octet 5 together with octets 6, 7 and 8; bit 8 of octet 5 is not significant and shall take the value 0.

13.10.4 Variable part

The variable part may contain the checksum parameter (see 13.2.3.1).

13.11 Reject (RJ) TPDU

The RJ-TPDU shall not be used in classes 0, 2, and 4.

13.11.1 Structure

The RJ-TPDU shall have one of the following formats:

a) *Normal format (classes 1 and 3):*

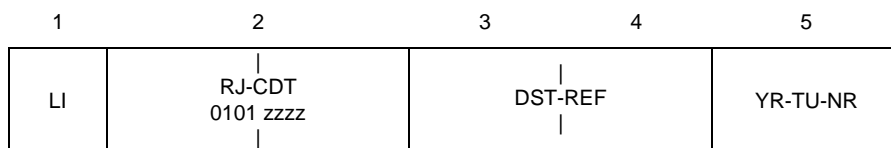

b) *Extended format (for use in class 3 if selected during connection establishment):*

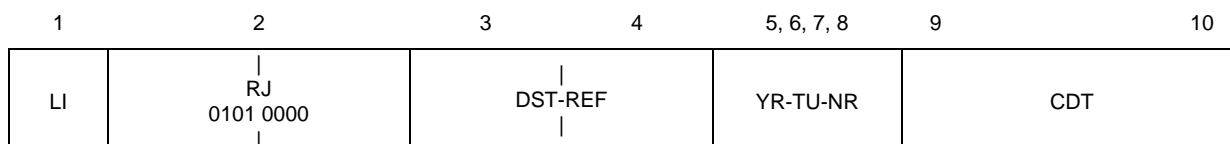

13.11.2 LI

See 13.2.1.

13.11.3 Fixed part

The fixed part shall contain (in octets 2 to 5 when normal format is used or in octets 2 to 10) the following parameters:

- a) RJ – Reject code: 0101. Bits 8 to 5 of octet 2.
- b) CDT – Credit value (set to 1111 in class 1). For normal formats bits 4 to 1 of octet 2 and for extended formats octets 9 and 10.
- c) DST-REF – See 13.4.3.
- d) YR-TU-NR – Sequence number indicating the next expected TPDU from which retransmission should occur. For normal formats, bits 7 to 1 of octet 5, bit 8 of octet 5 is not significant and shall take the value 0. For extended formats, bits 7 to 1 of octet 5 together with octets 6, 7 and 8; bit 8 of octet 5 is not significant and shall take the value 0.

13.11.4 Variable part

There is no variable part for this TPDU type.

13.12 TPDU Error (ER) TPDU

13.12.1 Structure

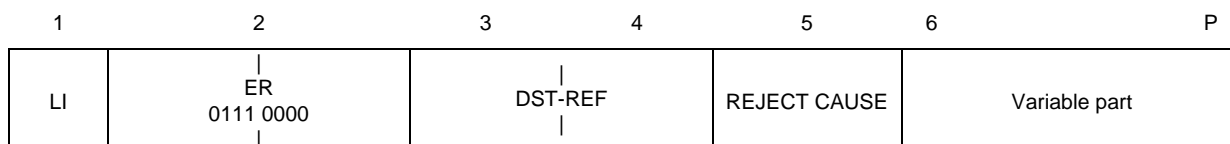

13.12.2 LI

See 13.2.1.

13.12.3 Fixed part

The fixed part shall contain the following parameters:

- a) ER – TPDU Error code: 0111 0000.
- b) DST-REF – See 13.4.3.
- c) REJECT CAUSE:
 - 0000 0000 Reason not specified
 - 0000 0001 Invalid parameter code
 - 0000 0010 Invalid TPDU type
 - 0000 0011 Invalid parameter value

13.12.4 Variable part

The variable part may contain the following parameters:

- a) *Invalid TPDU*
 - Parameter code: 1100 0001
 - Parameter length: Number of octets of the value field

Parameter value: Contains the bit pattern of the rejected TPDU header up to and including the octet which caused the rejection. This parameter is mandatory in class 0 .

b) *Checksum*

This parameter shall be present if the condition in 13.2.3.1 applies.

14 Conformance

14.1 A system claiming to implement the procedures specified in this Recommendation | International Standard shall comply with the requirements in 14.2-14.4.

14.2 The system shall implement class 0. This implies operation over CONS.

14.3 If the system implements class 3 or class 4, it shall also implement class 2.

14.4 For each class which the system claims to implement, the system shall be capable of:

- a) Initiating CR-TPDUs or responding to CR-TPDUs with CC-TPDUs or both. Where a CR-TPDU proposing class 2, 3 or 4 is initiated, class 0 shall be explicitly indicated as an alternative class except if there is already one (or several) transport connection(s) assigned to the network connection (multiplexing being possible).
- b) Responding to any other TPDU and operating network service in accordance with the procedures for the class.
- c) Operating all the procedures for the class listed as mandatory in Table 9.
- d) Operating those procedures for the class listed as optional in Table 9 for which conformance is claimed.
- e) Handling all TPDUs of lengths up to the lesser value of:
 - 1) the maximum length for the class if the preferred maximum TPDU size parameter is not implemented [see 13.3.4 b)];
 - 2) the maximum for which conformance is claimed (see Note 2);

NOTES

- 1 The procedures for classes 0 to 4 are specified in clauses 8 to 12 respectively. The procedures refer to the elements of procedures specified in clause 6.
- 2 The requirement in 14.4 e) indicates that TPDU size of 128 octets is always implemented.

Table 9 – Provision of options

Procedures	Class 0	Class 1	Class 2	Class 3	Class 4
TPDU with checksum TPDU without checksum	Not applicable Mandatory	Not applicable Mandatory	Not applicable Mandatory	Not applicable Mandatory	Mandatory Optional
Expedited data transfer No expedited data transfer	Not applicable Mandatory	Mandatory Mandatory	Mandatory Mandatory	Mandatory Mandatory	Mandatory Mandatory
Flow control in class 2 No flow control in class 2	Not applicable Not applicable	Not applicable Not applicable	Mandatory Optional	Not applicable Not applicable	Not applicable Not applicable
Normal formats Extended formats	Mandatory Not applicable	Mandatory Not applicable	Mandatory Optional	Mandatory Optional	Mandatory Optional
Use of receipt confirmation in class 1 No use of receipt confirmation in class 1	Not applicable Not applicable	Optional Mandatory	Not applicable Not applicable	Not applicable Not applicable	Not applicable Not applicable
Use of network expedited in class 1 No use of network expedited in class 1	Not applicable Not applicable	Optional Mandatory	Not applicable Not applicable	Not applicable Not applicable	Not applicable Not applicable
Use of selective acknowledgement in class 4	Not applicable	Not applicable	Not applicable	Not applicable	Optional
Use of request of acknowledgement in classes 1, 3, 4	Not applicable	Optional	Not applicable	Optional	Optional

14.5 Claims of conformance shall state:

- a) Which class or classes of protocol are implemented.
- b) Whether class 4 can be operated over the connectionless-mode network service.
- c) Whether the system is capable of initiating or responding to CR-TPDUs or both.
- d) Which of the procedures listed as optional in Table 9 are implemented.
- e) For each class, the maximum size of TPDU implemented [see 13.3.4 b) and 13.3.4 c)]. If the preferred maximum TPDU size parameter is not implemented, the value shall be chosen from the following list and all values in the list which are less than this maximum shall be implemented:

128, 256, 512, 1024, 2048, 4096 or 8192 octets.

If the preferred maximum TPDU size parameter is implemented, any maximum size of TPDU that is a multiple of 128 octets is allowed. All values, except 0, that are a multiple of 128 octets, less than the maximum claimed shall be implemented.

14.6 The supplier of a protocol implementation which is claimed to conform to this Recommendation | International Standard shall complete a copy of the PICS proforma provided in Annex D and shall provide the information necessary to identify both the supplier and the implementation.

Annex A

State tables

(This annex forms an integral part of this Recommendation | International Standard)

A.1 General

This annex provides a more precise description of the protocol.

The state tables also define the mapping between service and protocol events that TS-users can expect.

This annex describes the transport protocol in terms of state tables. The state tables show the state of a transport connection, the events that occur in the protocol, the actions taken and the resultant state.

The state tables describe only the operation of a single transport connection. They do not necessarily describe all possible combinations of sequences of events at transport and network service boundary, nor do they describe the exact mapping between TPDU and NSDUs.

A.2 Conventions

A.2.1 Incoming events are represented in the state tables by their abbreviated name, as defined in Table A.1.

A.2.2 States are represented in the tables by their abbreviated name, as defined in Table A.2.

A.2.3 The intersection of each state and event which is invalid is left blank. The action to be taken in this case shall be one of the following:

- a) for an event related to the transport service (i.e. coming from the TS-user), take no action;
- b) for an event related to a received TPDU, follow the procedure for treatment of protocol errors (see 6.22) if the state of the supporting network connection makes it possible;
- c) for an event falling into neither of the above categories (including those which are impossible by the definition of the behaviour of the transport entity or NS-provider), take no action.

A.2.4 At each intersection of state and event which is valid, the state tables specify an action which may include one of the following:

- a) One action constituted of a list of any number of outgoing events (none, one, or more) given by their abbreviated name defined in Table A.3 followed by the abbreviated name of the resultant state (see Table A.2).
- b) Conditional actions separated by a semi-colon (;). Each conditional action contains a predicate followed by a colon (:) and by an action as defined in a). The predicates are boolean expressions given by their abbreviated name and defined in the clauses related to the state tables of each class. Only the action corresponding to the predicate which is true shall be taken.

A.2.5 The state tables also include:

- a) informal comments giving explanatory materials;
- b) references to notes using the following notation: (note number);
- c) references to other actions defined in separate tables using the following notation: [action number].

A.3 Tables

Table A.1 specifies names and abbreviated names of the incoming events, classified as TS-user events, NS-provider events or TPDU events.

Table A.1 – Incoming events

Abbreviated name	Category	Name
TCONreq	TS-user	T-CONNECT request primitive
TCONresp	TS-user	T-CONNECT response primitive
TDTreq	TS-user	T-DATA request primitive
TEXreq	TS-user	T-EXPEDITED DATA request primitive
TDISreq	TS-user	T-DISCONNECT request primitive
NDISind	NS-provider	N-DISCONNECT indication primitive
NCONconf	NS-provider	N-CONNECT confirm primitive
NRSTind	NS-provider	N-RESET indication primitive
CR	TPDU	Connection request TPDU
CC	TPDU	Connection confirm TPDU
DR	TPDU	Disconnect request TPDU
DC	TPDU	Disconnect confirm TPDU
AK	TPDU	Data acknowledgement TPDU
EA	TPDU	Expedited data acknowledgement TPDU
DT	TPDU	Data TPDU
ED	TPDU	Expedited data TPDU
ER	TPDU	TPDU error TPDU
RJ	TPDU	Reject TPDU

Table A.2 specifies the names and abbreviated names of the states.

Table A.2 – States

Abbreviated name	Name
WFNC	Wait for network connection
WFCC	Wait for the CC-TPDU
WBCL	Wait before releasing (wait for CC-TPDU before sending the TPDU-DR)
OPEN	Transport connection is open
CLOSING	Release in progress
WFTRESP	Wait for T-CONNECT response
CLOSED	Transport connection is closed
WFNC-R	Wait for network connection and reassignment in progress
WFCC-R	Wait for CC-TPDU and reassignment in progress
WBCL-R	Wait before releasing and reassignment in progress
OPEN-R	Open and reassignment in progress
OPEN-WR	Open and wait for reassignment
CLOSING-R	Release in progress and reassignment in progress
CLOSING-WR	Release in progress and wait for reassignment
WFTRESP-WR	Wait for T-CONNECT response and wait for reassignment
WBCL-WR	Wait before releasing and wait for reassignment
WBOC	Wait before open complete (CC is unacknowledged)
WBOC-WR	Wait before open complete and wait for reassignment
CLOSING BOC	Wait before open complete and release in progress
CLOSING BOC-WR	Idem and wait for reassignment
AKWAIT	Waiting for acknowledgement of CC-TPDU
REFWAIT	Waiting for frozen reference time

Table A.3 specifies the names and abbreviated names of the outgoing events classified as TS-provider events, NS-user events or TPDU events.

Table A.3 – Outgoing event

Abbreviated name	Category	Name
TCONind	TS-provider	T-CONNECT indication primitive
TCONconf	TS-provider	T-CONNECT confirm primitive
TDTind	TS-provider	T-DATA indication primitive
TEXind	TS-provider	T-EXPEDITED DATA indication primitive
TDISind	TS-provider	T-DISCONNECT indication primitive
NDISreq	NS-user	N-DISCONNECT request primitive
NRSTresp	NS-user	N-RESET response primitive
NCONreq	NS-user	N-CONNECT request primitive
CR	TPDU	Connection request TPDU
CC	TPDU	Connection confirm TPDU
DR	TPDU	Disconnect request TPDU
DC	TPDU	Disconnect confirm TPDU
AK	TPDU	Data acknowledgement TPDU
EA	TPDU	Expedited data acknowledgement TPDU
DT	TPDU	Data TPDU
ED	TPDU	Expedited data TPDU
ER	TPDU	TPDU error TPDU
RJ	TPDU	Reject TPDU

A.4 State tables for classes 0 and 2

This subclause provides a more precise description of a transport entity for a transport connection of class 0 or class 2.

The description uses predicates defined in Table A.4, and specific actions defined in Table A.5.

The description does not include a complete specification of the data transfer procedures but makes reference to the specification of the classes (see clauses 8 and 10). Table A.6 gives the state automata for classes 0 and 2.

The following variables are used:

- SRC-REF – Designates the corresponding field of the received TPDU.
- DST-REF – Designates the corresponding field of the received TPDU.
- src-ref, dst-ref – Designates the corresponding field of the sent TPDU.

Table A.4 – Predicates for classes 0 and 2

Name	Description
P0	T-CONNECT request unacceptable
P1	Unacceptable CR-TPDU
P2	No network connection available
P3	Network connection available and open
P4	Network connection available and open in progress
P5	Class in class 0 (class selected in CC)
P6	Unacceptable CC
P7	Class is class 2
P8	Acceptable CC
P9	Class 4 CR
P10	Local choice

Table A.5 – Specific actions for classes 0 and 2

Name	Description
[1]	If the network connection is not used by another transport connection assigned to it, it may be disconnected. (See 6.1.1.3, Note 3).
[2]	See 6.22 (receipt of an ER-TPDU).
[3]	See data transfer procedures of the class.
[4]	See expedited data transfer procedure of the class.
[5]	An N-RESET response has to be issued once for the network connection if the network connection has not been released. In class 0, an N-DISCONNECT request has to be issued.
[6]	The DC-TPDU contains a src-ref field set to zero and a dst-ref field set to the SRC-REF of the DR-TPDU received.

Table A.6 – State table for classes 0 and 2

State Event	WFNC	WFCC	WBCL (Class 2 only)	OPEN	CLOSING (Class 2 only)	WFTRESP	CLOSED
TCONreq							P0: TDISind CLOSED; P2: NCONreq WFNC; P3: CR WFCC; P4: WFNC
TCONresp						CC OPEN	
TDTreq				[3] OPEN			
TEXreq	DOES NOT EXIST IN CLASS 0						
				[4] OPEN			
TDISreq	[1] CLOSED	Not P7: NDISreq CLOSED; P7: WBCL		P5: NDISreq CLOSED; P7: DR CLOSING		DR CLOSED	
NCONconf	CR-WFCC						
NRSTind		TDISind [1] [5] CLOSED	[1] [5] CLOSED	TDISind [1] [5] CLOSED	[1] [5] CLOSED	TDISind [1] [5] CLOSED	
NDISind	TDISind CLOSED	TDISind CLOSED	CLOSED	TDISind CLOSED	CLOSED	TDISind CLOSED	
CR				P9: OPEN	P9: CLOSING	P9: WFTRESP	P1: DR (1) CLOSED; not P1: TCONind WFTRESP
DR		TDISind		P5: (2)		P10: DC [6] (5)	CLOSED (4)
		[1] CLOSED	[1] CLOSED	P7: DC TDISind CLOSED	[1] CLOSED	TDISind CLOSED	DC CLOSED
DC	DOES NOT EXIST IN CLASS 0 (2)						
					P7: [1] CLOSED		
CC		P8: TCONconf OPEN; P6 and P5: TDISind NDISreq CLOSED; P6 and P7: TDISind DR CLOSING	P5: (3) NDISreq CLOSED; P7: DR CLOSING		CLOSING		DR CLOSED
AK	DOES NOT EXIST IN CLASS 0 (2)						
				[3] OPEN	CLOSING		
EA	DOES NOT EXIST IN CLASS 0 (2)						
				[4] OPEN	CLOSING		
ED	DOES NOT EXIST IN CLASS 0 (2)						
				[4] OPEN	CLOSING		
DT				[3] OPEN	CLOSING		CLOSED
ER		TDISind [1] CLOSED	[1] CLOSED	(2)	(2)		CLOSED

- (1) An ER-TPDU should be sent in certain cases (see 6.6).
- (2) If received, it should be processed as a protocol error (see 6.22).
- (3) A CR with class 2 has been sent and a CC class 0 is received.
- (4) If DC is not available (i.e. class 0 only implemented) or SRC-REF is zero.
- (5) This happens only when the preferred class of the CR-TPDU received is class 4.

A.5 State tables for classes 1 and 3

This subclause provides a more precise description of a transport entity for a transport connection of class 1 or 3.

The description uses the predicates defined in Table A.7.

Specific actions are defined in Table A.8 and specific additional notes are given in Table A.9.

The description does not include a complete specification of the data transfer but makes reference to the specification of the classes (see clauses 9 and 11). Table A.10 gives the state automata for classes 1 and 3.

The following variables are used:

- SRC-REF – Designates the corresponding field of the received TPDU.
- DST-REF – Designates the corresponding field of the received TPDU.
- src-ref, dst-ref – Designates the corresponding field of the sent TPDU.

Table A.7 – Predicates for classes 1 and 3

Name	Description
P0	T-CONNECT Request unacceptable
P1	No available network connection can be used for assignment or reassignment
P2	A network connection can be used for assignment or reassignment; the network connection opening is in progress.
P3	A network connection can be used for assignment or reassignment; the network connection is open.
P4	TTR timer has previously run out
P5	Local choice
P6	Initiator of the transport connection
P7	Unacceptable CR-TPDU
P8	TWR is running
P9	Class 4 CR
P10	Class selected in CC is class 0 or 2

Table A.8 – Specific actions for classes 1 and 3

Name	Description
[1]	The network connection can be disconnected if not used by any transport connection assigned to it.
[2]	Retransmit expedited data which are unacknowledged or which have been stored when waiting for reassignment (if any). If an RJ-TPDU has been received, enable also data TPDU transmission (if any). If an ED was received, handle according to procedures for class if not a duplicate.
[3]	Network connection can be disconnected if not used by any transport connection and was locally opened.
[4]	Start TWR timer if not already running. Disable sending DT-TPDUs until an RJ-TPDU is received (see Note 3).
[5]	Stop TWR timer.
[6]	Issue an N-RESET response if not already done.
[7]	See data transfer procedure for the class.
[8]	Start TTR timer if not already running. The sending credit is also set to zero in order not to send DT-TPDUs until an RJ-TPDU is received.
[9]	Stop TTR timer if running or remove information that TTR timer has run out (see Notes 1 and 2).
[10]	Store information that TTR timer has run out (see Note 1).
[11]	Store request.
[12]	See state table appropriate to the class selected in the CC-TPDU.
[13]	Close the network connection to which the transport connection is currently assigned, apply to all transport connections assigned to this network connection the procedure for processing NDISind and then process the TPDU reassignment.
[14]	The DC-TPDU contains a src-ref field set to zero and a dst-ref field set to the SRC-REF of the DR-TPDU received.
<p>NOTES</p> <p>1 This information is used by predicate P4.</p> <p>2 This action is not performed if the transport entity is the responder or if neither reassignment nor resynchronization is in progress.</p> <p>3 The method of disabling transmission of DT-TPDUs is a local matter. In class 3 for example, it may be effected by setting credit to zero. In class 1, this may be effected by setting of a boolean indicator.</p>	

Table A.9 – Specific notes for classes 1 and 3

Name	Description
(1)	Any TPDU except DR and CC having an unknown destination reference.
(2)	CC-TPDU having an unknown destination reference or a mismatched source reference.
(3)	CR-TPDU which is not duplicated but rejected. If the CR-TPDU is duplicated, ignore it.
(4)	Or send any DT or ED-TPDU waiting for transmission or use N-DATA ACKNOWLEDGE request if available and selected (class 1 only).
(5)	Same as for (9) and issue a T-DISCONNECT indication.
(6)	If the resultant state is CLOSED, the reference should be frozen except in the cases described in 6.18.
(7)	An ER-TPDU should be sent in the cases defined in 6.6.
(8)	Receipt of a DC-TPDU is a protocol error since DC cannot be used for reassignment. It is recommended to stop the TWR timer ([5]) and to consider the transport connection as released (CLOSED STATE).
(9)	Receipt of one of these TPDUs in this state is a protocol error. It is recommended to stop the TWR timer ([5]), and send a DR-TPDU and enter the closing state.
(10)	Or a DR with mismatched source reference has been received.
(11)	Receipt of CR in this state is only valid if the TPDU is received on a network connection to which the transport connection is not assigned. It is recommended to apply action [13].
(12)	Receipt of this TPDU in this state is possible either on the network connection to which the transport connection is currently assigned or on another network connection (for the responder only). In the former case the action is as stated in the state table. In the latter case it is recommended to apply action [13].
(13)	This happens only when the preferred class of the CR-TPDU received is class 4.

A.6 State tables for class 4 over CONS

This subclause provides a more precise description of a class 4 Transport Connection.

Tables A.11, A.12 and A.13 give the predicates, actions and notes for class 4 respectively.

Table A.14 is the state table for a class 4 transport connection.

**Table A.10 – State table for classes 1 and 3
(First part: Connection – responder side)**

State Event	CLOSED	WFTRESP	WFTRESP- WR	WBCL-WR	WBOC	WBOC-WR	CLOSING BOC	CLOSING BOC-WR
TDISreq		DR CLOSED (6)	WBCL-WR		DR CLOSING BOC	CLOSING BOC-WR		
TCONresp		P10: (12); not P10: CC WBOC	WBOC-WR					
NRSTind		[4] [6] WFTRESP- WR	[6] WFTRESP- WR	[6] WBCL-WR	[4] [6] WBOC-WR	[6] WBOC-WR	[4] [6] CLOSING BOC-WR	[6] CLOSING BOC-WR
NDISind		[4] WFTRESP- WR	WFTRESP- WR	WBCL-WR	[4] WBOC-WR	WBOC-WR	[4] CLOSING BOC-WR	CLOSING BOC-WR
CR	P7: DR (3 and 7) CLOSED (6); not P7: TCONind; WFTRESP	P9: WFTRESP; not P9: (11)	[5] WFTRESP	[5] DR CLOSED (6)	P9: WBOC; not P9: (11)	[5] CC WBOC	P9: CLOSING BOC; not P9: (11)	DR [5] CLOSED (6)
DR	DC CLOSED	P5: DC [14] (13) TDISind CLOSED			TDISind DC CLOSED (6) (12)	DC (5) TDISind CLOSED	CLOSED (6) (12)	[5] DC CLOSED (6)
RJ or ED	CLOSED				OPEN [7] (12)	[5] [2] RJ OPEN	CLOSING (12)	[5] DR CLOSING
DC	CLOSED						CLOSED	(8)
First TPDU other than CR, DR, DC, ED, ER or RJ	CLOSED				OPEN [7]		CLOSING	(9)
TWR time-out			TDISind CLOSED (6)	CLOSED (6)		TDISind CLOSED (6)		CLOSED (6)
TDTreq					[7] WBOC	[11] WBOC-WR		
TEXreq					[7] WBOC	[11] WBOC-WR		
ER					TDISind DC CLOSING BOC		CLOSED (6)	

**Table A.10 (continued) – State table for classes 1 and 3
(Second part: Connection initiator side)**

State Event	CLOSED	WFNC	WFNC-R	WFCC	WFCC-R	WBCL	WBCL-R
TCONreq	P0: TDISind CLOSED; not (P0 and P1): NCONreq WFNC; not (P0 and P2): WFNC; not (P0 and P3): CR-WFCC						
NCONconf		CR-WFCC	CR-WFCC		CR-WFCC		CR-WBCL
NRSTind				P4: TDISind [6] (6) [1] CLOSED; not P4: CR [6] [8] WFCC		P4: [6] CLOSED [1]; not P4: CR [6] [8] WBCL	
NDISind		P1: NCONreq WFNC-R [8]; P2: [8] WFNC-R; P3: CR [8] WFCC	P1: NCONreq WFNC-R; P2: WFNC-R; P3: CR-WFCC	P4: TDISind CLOSED (6); (not P4) and P1: [8] NCONreq WFCC-R; (not P4) and P2: [8] WFCC-R; (not P4) and P3: [8] CR-WFCC	P1: NCONreq WFCC-R; P2: WFCC-R; P3: CR-WFCC	P4 or P5: [1 and 9] (6) CLOSED; [not (P4 or P5)] and P1: [8] NCONreq WBCL-R; [not (P4 or P5)] and P2: [8] WBCL-R; [not (P4 or P5)] and P3: [8] CR-WBCL	P5: CLOSED (6) [9]; (not P5) and P1: NCONreq WBCL-R; (not P5) and P2: WBCL-R; (not P5) and P3: CR-WBCL
TDISreq		[1] CLOSED (6)	[1] CLOSED (6) [9]	WBCL	P5: CLOSED (6) [1 and 9]; not P5: WBCL-R		
DR	(10) DC CLOSED (12)			TDISind [1] [9] CLOSED (6)		[1] [9] CLOSED (6)	
CC	DR CLOSED			P10: [12]; not P10: TCONconf AK (4) OPEN [9]		P10: [12]; not P10: DR [9] CLOSING	
(1)	CLOSED						
(2)	DR CLOSED						
TTR time-out			TDISind [1] CLOSED (6)	[10]	TDISind [1] CLOSED (6)	[10]	[1] CLOSED (6)
ER				TDISind [1] [9] CLOSED (6)		[1] [9] CLOSED (6)	

**Table A.10 (concluded) – State table for classes 1 and 3
(Third part: OPEN and CLOSING states)**

State Event	OPEN	OPEN-R	OPEN-WR	CLOSING	CLOSING-R	CLOSING-WR
NCONconf		RJ [2] OPEN			DR-CLOSING	
TDISreq	P8: CLOSING; not P8: DR-CLOSING	CLOSING-R	CLOSING-WR			
NRSTind	P6 and P4: (6) [6] [3] TDisind CLOSED; (P6 and not P4): [6] [2] [8] RJ-OPEN; not P6: [4 and 6] OPEN			P6 and P4: (6) [6] [3] CLOSED; P6 and not P4: [6] [8] DR-CLOSING; not P6: [4, 6] CLOSING		
NDISind	P6 and P4: TDisind CLOSED (6); (P6 and not P4) and P1: [8] NCONreq OPEN-R; (P6 and not P4) and P2: [8] OPEN-R; (P6 and not P4) and P3: [8] [2] RJ-OPEN; not P6: [4] OPEN-WR	P1: NCONreq OPEN-R; P2: OPEN-R; P3: [2] RJ-OPEN		P6 and (P5 or P4): CLOSED (6); P6 and not (P4 or P5) and P1: [8] NCONreq CLOSING-R; P6 and not (P4 or P5) and P2: [8] CLOSING-R; P6 and not (P4 or P5) and P3: [8] DR-CLOSING; not P6: [4] CLOSING-WR	P5: CLOSED (6); (not P5 and P1): NCONreq CLOSING-R; (not P5) and P2: CLOSING-R; (not P5) and P3: DR-CLOSING	
RJ or ED	P8: [5] [2] RJ-OPEN; not P8: [7] [9] OPEN (12)		RJ [5 and 2] OPEN	P8: [5] DR-CLOSING; not P8: [9] CLOSING (12)		DR [5] CLOSING
TWR time-out	TDisind (6) CLOSED		TDisind (6) CLOSED	CLOSED (6)		CLOSED (6)
DR	P8: TDisind DC (6) [5] CLOSED; not P8: TDisind DC (6) [9] CLOSED (12)		TDisind DC [5] CLOSED (6)	P8: [5] DC (6) CLOSED; not P8: [3] [9] (6) CLOSED (12)		[5] CLOSED (6) DC
DC				P8: (8); not P8: [3] [9] CLOSED (6)		(8)
DT, AK, or EA TPDU	[7] OPEN		(5)	CLOSING		(9)
TTR time-out	[10]	TDisind CLOSED [1] (6)		[10]	CLOSED [1] (6)	
TDTreq	P8: [11] OPEN; not P8: [7] OPEN	[11] OPEN-R	[11] OPEN-WR			
TEXreq	P8: [11] OPEN; not P8: [7] OPEN	[11] OPEN-R	[11] OPEN-WR			
ER	TDisind DR-CLOSING		TDisind DR-CLOSING	CLOSED (6)		CLOSED (6)

The following assumptions and notations are used:

- a) The state of every network connection is known as being open or opening (i.e. a NCONreq has been issued and the NCONconf is awaited).
- b) For each transport connection the transport entity maintains the set of network connections to which the transport is assigned. A network connection in this set is either in open or opening state.
- c) When an N-CONNECT confirmation, N-RESET indication or N-DISCONNECT indication is received, this event is associated with the transport connection if the network connection belongs to the set.
- d) When an N-DISCONNECT is received, the network connection becomes unexisting and is therefore withdrawn from the set. When a NCONconf is received, the state of the nc becomes “open”.
NOTE – This is not shown by an explicit action in the state table. Conversely adding a network connection to a set and setting its state to “opening” is shown by an explicit action.
- e) When the state goes back to CLOSED or REFWAIT state, it is assumed that all timers are stopped (if running), the count is set to zero and the set becomes empty.
- f) When a TPDU is received, the network connection on which it has been received is assumed to be known.
- g) The variable “current-nc” is used to designate either the network connection on which a TPDU has been received or the network connection which has been chosen for a new assignment (either an existing one or a new one which is created).
- h) The following variables are also used:
 - local-ref – The reference (local) of the TC is chosen when sending the CR or when accepting a CR.
 - remote-ref – The reference of remote entity is initially set to zero and initialized when processing the CC except if the CC is ignored.
 - SRC-REF – Designates the corresponding field of the received TPDU.
 - DST-REF – Designates the corresponding field of the received TPDU.
 - src-ref, dst-ref – Designates the corresponding field of the sent TPDU.
 - count – Designates the number of times a TPDU has been sent (retransmissions).
- i) The data transfer phase is not completely described in the state table but refers to the main text.
- j) A spontaneous event called “new network connection assignment” has been introduced. It may occur at any time provided P1 or P2 are true (see Table A.11) and the remote-ref is not zero (i.e. a CR-TPDU has been received or a CC-TPDU has been received and processed).
- k) When an N-RESET indication is received, an N-RESET response is issued.

Table A.11 – Predicates for class 4 over CONS

Name	Description
P0	T-CONNECT Request is acceptable.
P1	An assignment can be done to a suitable network connection (either open or opening).
P2	It is possible to open a new network connection.
P3	Local choice.
P4	A CR-TPDU has never been sent.
P5	The transport entity is the initiator and the set of network connections is now empty (i.e. a new assignment shall be done) or a new assignment is decided as a local choice.
P6	Local choice not to perform a new assignment if the set of network connections is empty (for CLOSING state only).
P7	Count = maximum.
P8	Acceptable CR-TPDU.
P9	Acceptable class 4 CC-TPDU.
P10	Unacceptable class 4 CC-TPDU.
P11	CC-TPDU not specifying class 4.

Table A.12 – Specific actions for class 4 over CONS

Name	Description
[0]	Set reference timer.
[1]	Count = count + 1.
[2]	Count = 0.
[3]	Set retransmission timer.
[4]	Stop retransmission timer if running.
[5]	Set window timer.
[6]	Stop window timer if running.
[7]	Set inactivity timer.
[8]	Stop inactivity timer.
[9]	Set initial credit for sending according to the received CR/CC-TPDU.
[10]	Set initial credit for controlling reception according to the sent CR/CC-TPDU.
[11]	Send the CR-TPDU if there is a network connection in the open state in the set.
[12]	Add the current network connection to the set, if not already included.
[13]	The current network connection is now in opening state.
[14]	Send the CC-TPDU if a network connection in the open state is in the set.
[15]	Send the DR-TPDU if a network connection in the open state is in the set. This DR-TPDU is sent with src-ref = local-ref and dst-ref = remote-ref (may be zero).
[16]	Send the DR-TPDU if a network connection in the open state is in the set. The DR-TPDU is sent with src-ref = 0 and dst-ref = remote-ref.
[17]	Send a TPDU according to data transfer procedure.
[18]	See state table of the class specified in the CC-TPDU (refer to data transfer).
[19]	See state table of the class (refer to release procedure): send a DR-TPDU if the class is not 0, otherwise issue an N-DISCONNECT request.
[20]	Store request and exercise flow control to the user.
[21]	Send a DR-TPDU with src-ref field set to zero.
[22]	Send a DC-TPDU except if the SRC-REF field of the received DR-TPDU is equal to zero.

Table A.13 – Specific notes for class 4 over CONS

Name	Description
(1)	Not possible as no set of Network Connections is associated with this transport connection.
(2)	It is also possible to remain in the same state (T1 is still running) until: – a CC-TPDU is received which performs a new assignment; – a new assignment is tried (spontaneous event); – T1 runs out and the count is equal to the maximal value.
(3)	No new assignment was possible: if the set is empty, the transport entity waits until a new assignment is received, or can be locally performed (spontaneous event).
(4)	It is also possible to perform a new assignment. (This may be done in triggering the event “new network connection assignment”).
(5)	Not a duplicated CR-TPDU. If the CR-TPDU is duplicated, ignore it.
(6)	Since a new network connection is now assigned, it is recommended that the appropriate TPDU be sent on this network connection (if open) in order to make the remote entity aware of this assignment. It is also possible to allow the normal retransmission procedures to cause the TPDU to be sent; however, the first TPDU available for sending should be sent on the new network connection.
(7)	As a local choice it is also possible to apply the following: [0], TDISind, REFWAIT.
(8)	Association to this transport connection is carried out regardless of the SRC-REF field. If the SRC-REF is not zero, a DC-TPDU is sent back.
(9)	At least an AK-TPDU shall be sent if the transport entity is in the initiator in order to ensure that the responder will complete its three-way handshake.
(10)	If association has been made, and DST-REF is zero, then the DC-TPDU contains a SRC-REF field set to zero.
(11)	If the CLOSING state has been entered, coming from WFCC state, the remote-ref is zero. The SRC-REF field of the CC-TPDU is ignored (i.e. if the DR-TPDU is retransmitted, it will be with dst-ref field set to zero).
(12)	If the CLOSING state has been entered, coming from WFCC state, the remote-ref (which is zero) shall be set with SRC-REF in order to comply with the release procedure of the negotiated class.
(13)	The DR-TPDU may be either repeated immediately or when T1 will run out.
(14)	If the set is empty, this event may be used as a criteria for triggering the event “new network connection assignment”.
(15)	Previously stored T-DATA or T-EXPEDITED DATA requests are ready for processing according to data transfer procedures.
(16)	See data transfer procedures.
(17)	When an N-RESET indication is received, an N-RESET response has to be issued once independent of the state automata.

Table A.14 – Class 4 connection/disconnection over CONS

State Event	REFWAIT	CLOSED	WFCC	WBCL	OPEN	WFTRESP	AKWAIT	CLOSING
TCONreq		Not P0: TDisind CLOSED; P0 and P1: [12, 1, 3, 10 and 11] WFCC; P0 and not P1 and P2: [13, 12, 1, 3 and 10] NCONreq WFCC; P0 and not P2: TDisind CLOSED						
TCONresp						[3, 2, 1, 10 and 14] AKWAIT		
TDisreq			P4: CLOSED; (not P4) and P3: WBCL; (not P4) and (not P3): [4, 3, 2, 1 and 15] CLOSING		[6, 8, 4, 3, 2, 1 and 15] CLOSING	[16] CLOSED	[4, 3, 2, 1 and 15] CLOSING	
NDISind	(1)	(1)	P1: [12] WFCC; (not P1) and P2: [13 and 12] NCONreq WFCC; (not P1) and (not P2): [0] [2] TDisind REFWAIT	P3: [0] REFWAIT; (not P3) and P1: [12 and 11] WBCL; (not P3) and (not P1) and P2: [13 and 12] NCONreq WBCL; (not P3) and (not P1) and (not P2): [0] REFWAIT	P5 and P1: [12 and 17] (6) OPEN; P5 and (not P1) and P2: [13 and 12] NCONreq OPEN; P5 and (not P1) and (not P2): OPEN (3); not P5: OPEN	WFTRESP (4)	P5 and P1: [12 and 14] (6) AKWAIT; P5 and (not P1) and P2: [13 and 12] NCONreq AKWAIT; P5 and (not P1) and (not P2): AKWAIT (3); not P5: AKWAIT	P6: [0] REFWAIT; (not P6) and P5 and (not P1) and P1: [12 and 15] CLOSING (6); (not P6) and P5 and (not P1) and P2: [13 and 12] NCONreq CLOSING; (not P6) and P5 and (not P1) and (not P2): CLOSING (3); (not P6) and (not P5): CLOSING
NRSTind			(17)	(17)	(17)	(17)	(17)	(17)
TDTrreq TEXreq					(16) OPEN		[20] AKWAIT	
NCONconf	(1)	(1)	CR-WFCC (6)	CR-WBCL (6)	[17] OPEN (6)	WFTRESP	CC-AKWAIT (6)	[15] CLOSING (6)
New network connection assignment					P1: [12 and 17] OPEN (6); (not P1) and P2: [13 and 12] NCONreq OPEN	P1: [12] WFTRESP (6); (not P1) and P2: [13 and 12] NCONreq WFTRESP	P1: [12 and 14] (6) AKWAIT; (not P1) and P2: [13 and 12] NCONreq AKWAIT	P1: [12 and 15] (6) CLOSING; (not P1) and P2: [13 and 12] NCONreq CLOSING

Table A.14 (concluded) – Class 4 connection/disconnection over CONS

State Event	REFWAIT	CLOSED	WFCC	WBCL	OPEN	WFTRESP	AKWAIT	CLOSING
Retrans-timer			P7 and P3: [0] TDISind REFWAIT; P7 and (not P3): [3, 2, 1 and 15] TDISind CLOSING (14); not P7: [1, 3 and 11] WFCC	P7 and P3: [0] REFWAIT; P7 and (not P3): [3, 2, 1 and 15] CLOSING (14); not P7: [1, 3 and 11] WBCL	P7: [6, 8, 3, 2, 1 and 15] TDISind CLOSING (14); not P7: (16) (14) OPEN		P7: [3, 2, 1 and 15] TDISind (14) CLOSING; not P7: [1, 3 and 14] (14) AKWAIT	P7: [0] REFWAIT; not P7: [1, 3 and 15] (14) CLOSING
Inactivity-timer					[6, 4, 3, 2, 1 and 15] TDISind CLOSING (7)			
Reference timer	CLOSED							
CR		Not P8: [21] CLOSED (5); P8: [9 and 12] TCONind WFTRESP (5)			[12, 8 and 7] OPEN	[12] WFTRESP	[12 and 14] AKWAIT	[12] CLOSING (13)
CC	DR REFWAIT	DR CLOSED	P9: [12, 9, 2, 4, 5, 7 and 17] TCONconf (9) OPEN; P10: [12, 4, 3, 2, 1 and 15] TDISind CLOSING; P11: [18]	P11: [19]; not P11: [12, 2, 4, 3, 1 and 15] CLOSING	[12, 17, 8 and 7] (9) OPEN			P11: [19] (12); not P11: [12] CLOSING (11)
ER	REFWAIT	CLOSED	[0] TDISind REFWAIT	[0] REFWAIT	[12, 6, 8, 4, 3, 2, 1 and 15] TDISind CLOSING		[12, 4, 3, 2, 1 and 15] TDISind CLOSING	[0] REFWAIT
DR	[22] REFWAIT	[22] CLOSED	(8) TDISind [0] REFWAIT	(8) [0] REFWAIT	DC (10) [0] TDISind REFWAIT	DC (10) TDISind CLOSED	DC (10) [0] TDISind REFWAIT	[0] REFWAIT
DC	REFWAIT	CLOSED						[0] REFWAIT
EA	REFWAIT	CLOSED			[12, 8 and 7] OPEN (16)			[12] CLOSING (13)
DT/AK/ED	REFWAIT	CLOSED			[12, 8 and 7] OPEN (16)		[12 and 7] OPEN (15) (16)	[12] CLOSING (13)

A.7 State tables for class 4 over CLNS

This subclause provides a more precise description of a class 4 transport connection when operating over CLNS.

Tables A.15, A.16 and A.17 give the predicates, actions and notes for class 4 respectively.

Table A.18 is the state table for a class 4 transport connection when operating over CLNS.

The following assumption and notations are used:

- a) local-ref – The reference (local) of the TC is chosen when sending the CR or when accepting a CR:
 - remote-ref – The reference of the remote entity is initially set to zero and initialized when processing the CC except if the CC is ignored.
 - SRC-REF – Designates the corresponding field of the received TPDU.
 - DST-REF – Designates the corresponding field of the received TPDU.
 - src-ref, dst-ref – Designates the corresponding fields of the sent TPDU.
 - count – Designates the number of times a TPDU has been sent (retransmissions).
- b) The data transfer phase is not completely described in the state table but refers to the main text.
- c) It is assumed that the network service is continuously available.

The operations resulting from signalled inaccessibility of the network service are a local matter.

Table A.15 – Predicates for class 4 over CLNS

Name	Description
P0	T-CONNECT request is acceptable
P3	Local choice
P7	Count = maximum
P8	Acceptable CR-TPDU
P9	Acceptable class 4 CC-TPDU

Table A.16 – Specific actions for class 4 over CLNS

Name	Description
[0]	Set reference timer
[1]	Count = count + 1
[2]	Count = 0
[3]	Set retransmission timer
[4]	Stop retransmission timer if running
[5]	Set window timer
[6]	Stop window timer if running
[7]	Set inactivity timer
[8]	Stop inactivity timer if running
[9]	Set initial credit for sending according to the received CR/CC-TPDU
[10]	Set initial credit for controlling reception according to the sent CR/CC-TPDU
[15]	Send the DR-TPDU. This DR-TPDU is sent with src-ref = local-ref and dst-ref = remote-ref (may be zero)
[16]	Send the DR-TPDU. The DR-TPDU is sent with src-ref = 0 and dst-ref = remote-ref
[17]	Send a TPDU according to data transfer procedure
[20]	Store request and exercise flow control to the user
[21]	Send a DC-TPDU with src-ref equal to zero
[22]	Send a DC-TPDU except if the SRC-REF field of the received DR-TPDU is equal to zero
[23]	Send a DR-TPDU with src-ref = local-ref and dst-ref = SRC-REF in CC-TPDU

Table A.17 – Specific notes for class 4 over CLNS

Name	Description
(5)	Not a duplicated CR-TPDU. If the CR-TPDU is duplicated, ignore it.
(7)	As a local choice it is also possible to apply the following [0], TDISind, REFWAIT.
(8)	Association to this Transport connection is done regardless of the SRC-REF field. If SRC-REF is not zero, a DC-TPDU is set back.
(9)	At least an AK-TPDU shall be sent if the transport entity is the initiator in order to ensure that the responder will complete its three-way handshake.
(10)	If association has been made, and DST-REF is zero, then the DC-TPDU contains a src-ref field set to zero.
(11)	If the CLOSING state has been entered, coming from WFCC state, the remote-ref is zero. The SRC-REF field of the CC-TPDU is ignored (i.e. if the DR-TPDU is retransmitted, it will be with the dst-ref field set to zero).
(13)	The DR-TPDU may be either repeated immediately or when T1 will run out.
(15)	Previously stored T-DATA or T-EXPEDITED-DATA requests are ready for processing according to data transfer procedures.
(16)	See data transfer procedures.

Table A.18 – Class 4 connection/disconnection over CLNS

State Event	REFWAIT	CLOSED	WFCC	WBCL	OPEN	WFTRESP	AKWAIT	CLOSING
TCONreq		Not P0: TDisind CLOSED; P0: [1,3,10] CR-WFCC						
TCONresp						[3,2,1,10] CC- AKWAIT		
TDisreq			P3: WBCL; not P3: [4,3,2,1,15] CLOSING		[6,8,4,3, 2,1,15] CLOSING	[16] CLOSED	[4,3,2,1,15] CLOSING	
TDTreq TEXreq					(16) OPEN		[20] AKWAIT	
Retrans- timer			P7 and P3: [0] TDisind REFWAIT; P7 and (not P3): [3,2,1,15] TDisind CLOSING; not P7: [1,3], CR-WFCC	P7 and P3: [0] REFWAIT; P7 and (not P3): [3,2,1,15] CLOSING; not P7: [1,3], CR WBCL	P7: [6,8,3,2,1,15] TDisind CLOSING; not P7: (16) OPEN		P7: [3,2,1,15] TDisind CLOSING; not P7: [1,3], CC AKWAIT	P7: [0] REFWAIT; not P7: [1,3,15] CLOSING
Inactivity- Timer					[6,4,3,2,1,15] TDisind CLOSING (7)			
Reference- timer	CLOSED							
CR		Not P8: [21] CLOSED; P8: [1,9,3] TCONind WFTRESP (5)			[8,7] OPEN	WFTRESP	CC- AKWAIT	CLOSING (13)
CC	DR- REFWAIT	DR- CLOSED	P9: [9,2,4,5,7,17] TCONconf (9) OPEN; not P9: [4,3,2,1,23] TDisind CLOSING	P9: [2,4,3,1,15] CLOSING	[17,8,7] (9) OPEN			P9: (11) CLOSING
ER	REFWAIT	CLOSED	[0] TDisind REFWAIT	[0] REFWAIT	[6,8,4,3,2, 1,15] TDisind CLOSING		[4,3,2,1,15] TDisind CLOSING	[0] REFWAIT
DR	[22] REFWAIT	[22] CLOSED	(8) [0] TDisind REFWAIT	(8) [0] REFWAIT	DC (10) [0] TDisind REFWAIT	DC (10) TDisind CLOSED	DC (10) [0] TDisind REFWAIT	[0] REFWAIT
DC	REFWAIT	CLOSED						[0] REFWAIT
EA	REFWAIT	CLOSED			[8,7] OPEN (16)			CLOSING (13)
DT/AK/ED	REFWAIT	CLOSED			[8,7] OPEN (16)		[7] OPEN (15) (16)	CLOSING (13)

Annex B

Network connection management subprotocol

(This annex forms an integral part of this Recommendation | International Standard)

B.1 Introduction

The objectives of this annex are:

- a) To provide for more flexibility in the use of the network connections established between two cooperating transport entities, thus enlarging the field of application of the transport protocol as presently defined in the main body of this Recommendation | International Standard. In particular it allows for an optimization of the use of the network connections by allowing both transport entities at each end of a network connection to assign and reassign transport connections to a network connection.
- b) To allow more information to be sent explaining why a network connection is released in order to be able to optimize recovery.

The protocol described in this annex is called the Network Connection Management Subprotocol (NCMS).

The procedures defined in this annex are optional extensions to the main body of this Recommendation | International Standard.

B.2 Scope

The procedures specified in this annex are an extension of the basic procedure defined in the main body of this Recommendation | International Standard and therefore do not prevent communication between transport entities conforming to this Recommendation | International Standard with this annex and those conforming to this Recommendation | International Standard without this annex.

The basic network connection management that is specified in the main body of this Recommendation | International Standard allows for assignment or reassignment of transport connections on an existing network connection by its owner, who is currently restricted to be the transport entity that initiated this network connection. This annex describes the procedures necessary to extend this basic management to permit the peer transport entity (i.e. the acceptor of a network connection) to become also the owner of the network connection and consequently to be able to assign or reassign transport connections to it.

When performing multiplexing of transport connection, this feature allows a network connection to be fully shared, thus increasing the scope of the multiplexing classes of the transport protocol (i.e. classes 2, 3 and 4).

In order to control the number of shared network connections that peer entities are willing to use simultaneously (one or more), a mechanism is provided to resolve collisions when simultaneous network connection establishments occur, especially in the case of recovery after network failure.

B.3 Definitions

For the purposes of this annex, the following definitions apply.

NOTE – The definitions contained in this subclause make use of abbreviations defined in B.4.

B.3.1 owner (of a network connection): The transport entity that issued the N-CONNECT request leading to the creation of the network connection if the NCM-TPDU is not used or the transport entity (possibly both) which is designated to have the right of performing assignment in accordance with the NC-RIGHT field of the NCM-TPDU when the NCM-TPDU is used (see B.6.2.2).

NOTE – This definition extends the definition of the owner of the network connection given in 3.2.28.

B.3.2 network connection reference (or nc-reference): An identifier which is associated with a network connection and used to resolve collisions when network connections are reopened.

B.4 Abbreviations

B.4.1 Types of transport-protocol-data-units

NCM-TPDU	Network Connection Management TPDU
DIAG-TPDU	Diagnostic TPDU
NCMC-TPDU	Network Connection Management Confirmation TPDU

The following TPDU is used by this annex and is defined by ITU-T Rec. X.264 and ISO/IEC 11570, Transport protocol identification mechanism:

UN-TPDU	Use of Network connection TPDU
---------	--------------------------------

B.4.2 TPDU fields

NC-REF	Network Connection Reference (field)
NC-TYPE	Network Connection Type (field)
NC-RIGHT	Network Right (field)
LI	Length Indicator (field)
NC-PREF	Network Connection Preference (field)
NC-COL	Network Connection Collision Indicator
NC-REC	Network Connection Recovery Indicator

The following fields of the UN TPDU are used by this annex and are defined by ITU-T Rec. X.264 and ISO/IEC 11570:

SHARE	Sharing option (field)
PRT-ID	Protocol Identifier (field)

B.4.3 Timers

TTR-NC	Time to try to reopen a network connection using a given NC-REF
TPD-NC	Time to consider a given NC-REF as pending
TFR-NC	Time to consider a given NC-REF as frozen

B.4.4 Miscellaneous

NCMS	Network Connection Management Subprotocol
NSAP	Network-service-access-point
AA	Assignment right to all
SA	Sender has assignment right
RA	Receiver has assignment right
AFI	Authority and Format Identifier (of the NSAP address)
IDI	Initial Domain Identifier (of the NSAP address)
DSP	Domain Specific Part (of the NSAP address)

B.5 Overview of the protocol

NCMS allows for:

- a) Identification of the protocol to be used on top of a given network connection.
NOTE – The use of NSAP addresses as it is defined in CCITT Rec. X.650 and ISO/IEC 7498-3 provides greater flexibility in distinguishing between OSI and non-OSI users of the network service. If, however, the use of NSAPs incurs unacceptable penalties, for example where each NSAP is charged for by the network provider, then the protocol identification mechanism (see ITU-T Rec. X.264 and ISO/IEC 11570) is available.
- b) Explicit designation of the transport entity (or entities) which has the right to assign transport connection(s) to a specific network connection and is therefore considered as the (co-)owner of the network connection.
- c) Resolution of connection establishment collisions when a network connection is first established or recovered after failure.

NCMS assumes the use of the network service defined in CCITT Rec. X.213 | ISO/IEC 8348.

When operating NCMS the transport entities use only the network service primitives listed in Table B.1 (the other network service primitives are used as defined in 5.2).

Table B.1 – Network service primitives used for NCMS operation

Primitives		Parameters	A/B/C
N-CONNECT	request	Called address	A
	indication	Calling address	A
	response	NS user-data	B
	confirm	QOS parameter set	A
		Responding address	A
		Receipt confirmation selection	A
N-DISCONNECT	request	NS user-data	C
	indication	Originator	C
		Reason	A
<p>A This parameter is used in accordance with the procedures specified in the main body of this Recommendation International Standard.</p> <p>B When operating NCMS, this parameter is used in request and indication and in response and confirmation if the NCMC-TPDU is used.</p> <p>C This parameter may be optionally used when operating NCMS.</p>			

B.6 Elements of procedure

B.6.1 TPDU transfer

The transport-protocol-data-units (TPDUs) defined for this annex are listed in B.4.1.

The transport entities shall transmit and receive the UN (see ITU-T Rec. X.264 and ISO/IEC 11570) and NCM-TPDU in the NS-user data parameter of the N-CONNECT request and indication primitive only.

The sending transport entity shall:

- a) either not transmit any TPDU in the NS-user data parameter of the N-CONNECT request primitive; or
- b) transmit the UN-TPDU (see ITU-T Rec. X.264 and ISO/IEC 11570) followed by the NCM-TPDU in the NS-user data parameter of the N-CONNECT request primitive.

When used the DIAG-TPDU is transmitted in the NS-user data parameter of N-DISCONNECT primitive.

When used the NCMC-TPDU is transmitted in the NS-user data parameter of N-CONNECT response and confirmation primitive.

B.6.2 Network connection management

B.6.2.1 General

When the procedure described in B.6.1 b) is used:

- a) the sending transport entity shall use the procedure described below together with the procedure defined in the main body of this Recommendation | International Standard;
- b) the receiving transport entity shall:
 - 1) either ignore the NCM-TPDU and operate the procedure described in the main body of this Recommendation | International Standard; or
 - 2) recognize and process the NCM-TPDU and therefore operate the procedure described below together with those defined in the main body of this Recommendation | International Standard.

When a transport entity has processed an NCM-TPDU received from a given NSAP [see B.6.2.1 b) 2)] it shall process further NCM-TPDUs received from the same NSAP.

B.6.2.2 Assignment right

When an N-CONNECT request primitive is issued by a transport entity to request the opening of a new network connection, the transport entity may choose whether or not to include the NCM-TPDU in the NS-user data parameter of the primitive. The recipient may choose not to process the NCM-TPDU and to operate the procedures defined in the main body of this Recommendation | International Standard instead.

The owner(s) may use the network connection for assigning or reassigning transport connections with the following restrictions:

- a) a transport entity which is the owner of the network connection shall not assign a transport connection with a preferred class 0 or 1 if its peer is also the owner of the network connection (see Note 2);
- b) a transport entity which is the owner of the network connection can assign a transport connection with an alternative class 0 or 1, but shall not, when receiving a CR-TPDU proposing 0 or 1 as an alternative class, select one of these classes (see Note 3).

A transport entity shall be designated the “owner” of a network connection according to Table B.2.

Table B.2 – Determination of assignment rights

Event	Entity	Network connection initiator	Network connection responder
No NCM sent		Y	N
NCM sent but not processed Right = SA or AA		Y	N
NCM sent but not processed Right = RA		N (Note 4)	N (Note 4)
NCM sent and processed Right = SA		Y	N
NCM sent and processed Right = RA		N	Y
NCM sent and processed Right = AA		Y	Y
Y	Owner		
N	Not owner		

NOTE 1 – The use of a network connection by a called transport entity to initiate new transport connections should only be made when the called transport entity is adequately assured of the true identity of the calling transport entity (i.e. there is trust in the calling NSAP identification provided by the Network Layer) or the data to be transferred is not sensitive.

NOTE 2 – This gives the guarantee that transport connections of classes 0 or 1 cannot be opened simultaneously at both ends of a network connection.

NOTE 3 – This allows a transport entity which has sent the NCM-TPDU to still propose classes 0 or 1 as an alternative class. If the peer transport entity has not processed the NCM-TPDU it may still select class 0 or class 1.

NOTE 4 – Use of NC-RIGHT with the NCM-TPDU allows explicit control of assignment rights whilst also permitting both entities to be able to recover a failed network connection. This is not possible when the NCM is used.

Provided that the restriction stated in B.6.2.2 a) and B.6.2.2 b) are respected, both transport entities at each end of the network connection shall follow the procedures defined in the main body of this Recommendation | International Standard, except that the owner of the network connection is defined as in B.6.2.2.

NOTE 5 – The transport protocol defined in the main body of this Recommendation | International Standard makes use of the definition of owner of a network connection for defining the entity which can perform assignment and reassignment.

B.6.2.3 Network connection reference (nc-reference) management

When a transport entity elects to use the NCM-TPDU it shall keep track of the nc-references used in the NCM-TPDUs sent or received in the NS-user data parameter of the N-CONNECT request or indication primitives.

An nc-reference is associated with:

- a) The pair of NSAPs addresses involved in the network connection on which the NCM-TPDU has been transferred.
- b) The source of the allocation – The nc-reference has been remotely or locally allocated.

The nc-reference is exchanged as the NC-REF parameter of the NCM-TPDU. The NC-TYPE parameter of the NCM-TPDU indicates the source of allocation:

- 1) NC-TYPE set to NEW indicates a new nc-reference allocated by the sender of the NCM-TPDU;
- 2) NC-TYPE set to MY indicates a recovery using an nc-reference previously allocated by the sender of the NCM-TPDU;
- 3) NC-TYPE set to YOURS indicates a recovery using an nc-reference previously allocated by the receiver of the NCM-TPDU.

NOTE 1 – Use of the NC-TYPE MY permits the explicit distinction between the two cases where the NC initiator either has or has not received the N-CONNECT confirm.

- c) The state of the nc-reference which can be:
 - 1) OPEN – There is one network connection associated with the nc-reference and for which an N-CONNECT confirm has been received or an N-CONNECT response sent, and no subsequent N-DISCONNECT primitive exchanged.
 - 2) OPENING – There is one network connection for which an N-CONNECT confirm is awaited and the nc-reference has never been previously in the OPEN state.
 - 3) RECOVER – There is one network connection associated with the nc-reference for which an N-CONNECT confirm is awaited and the nc-reference has previously been in the OPEN state.
 - 4) PENDING – There is no network connection associated with the nc-reference.
- d) The assignment right allocated for the use of the network connection associated with the nc-reference. It can be:
 - 1) my-side – The local transport entity is the only owner of the network connection.
 - 2) remote-side – The remote transport entity is the only owner of the network connection.
 - 3) both-sides – Both the local and the remote transport entities are the owners of the network connection.

NOTE 2 – Due to the collision and recovery mechanisms, it is possible that different network connections – initiated either by the local or the remote transport entity – be consecutively associated to the same nc-reference. The assignment rights are attached with the nc-reference and remain unchanged independent of whichever transport entity is the initiator of the network connection currently used.

- e) The preference to be used in the collision resolution mechanism (see B.6.2.5) – This value is equal to the value of the field of the last NCM TPDU sent and is only significant when an N-CONNECT confirm is awaited (i.e. the nc-reference is either in the OPENING or in the RECOVERY state).

When an nc-reference which has been locally allocated is no longer needed, the nc-reference shall not be reused before a TFR-NC period of time. No information is associated with this frozen reference other than the TRF-NC timer and will be considered unknown if received in an NCM-TPDU.

NOTE 3 – In order to prevent that, in collision cases, two nc-references have the same value, it is required to allocate values at random, for example based on the time of their allocation.

B.6.2.4 Timers

The network connection management procedure makes use of the following timers:

- a) The TTR-NC timer defines the period of time that shall not be exceeded when reopening a network connection associated with a given nc-reference after the receipt of an N-DISCONNECT indication in OPENING or RECOVERY state. TTR-NC shall be less than TPD-NC by at least the sum of the maximum disconnection and maximum connection propagation delays of the network service.
- b) The TPD-NC timer defines the minimum time a transport entity shall maintain an nc-reference in the PENDING state. A value of 2 minutes is used for TPD-NC.
- c) The TFR-NC timer defines the minimum time that shall elapse before an entity may reuse a locally allocated nc-reference. A value of 2 minutes is used for TFR-NC.

B.6.2.5 Association of a received NCM-TPDU with a known nc-reference

When an NCM-TPDU is received according to B.6.1 c) and B.6.2 and processed (a transport entity may always elect to process or ignore an NCM-TPDU), the NCM-TPDU is associated with an existing nc-reference if one of the following holds:

- a) either of the three following conditions are met:
 - 1) the reference number received in the NC-REF parameter is the same as the one stored; and
 - 2) the pair of NSAPs addresses in the N-CONNECT indication in which the NCM-TPDU was received is the same as those stored with the reference; and
 - 3) the parameter received in the NCM-TPDU indicates the same source of allocation as that stored with the nc-reference, as indicated in Table B.3;
- b) or there is no nc-reference known by the transport entity corresponding to B.6.2.5 a)1) above and the following three conditions hold:
 - 1) the NC-TYPE parameter has the value NEW;
 - 2) there is an nc-reference, locally allocated, joining the same pair of NSAPs addresses, in OPENING state and having the assignment right defined as follows:
 - assignment right is “my-side” and the RIGHT field of the received NCM-TPDU holds the value RA (receiver has assignment right); or
 - assignment right is “remote-sides” and the RIGHT field of the received NCM-TPDU holds the value SA (sender has assignment right); or
 - assignment right is “both-sides” and the RIGHT field of the received NCM-TPDU holds the value AA (assignment right to all);
 - 3) acceptance of both network connections would result in the establishment of more connections than the transport entity is prepared to support.

An NCM-TPDU which is not associated but carries a value different from NEW in the TYPE parameter has to be considered an error.

Table B.3 – Matching source of nc-reference allocation

Stored Source NC-TYPE	Remote	Local
NEW	S	D
YOUR	D	S
MY	S	D
S Same allocation source D Different allocation source		

B.6.2.6 Collision**B.6.2.6.1 Collision cases**

A collision is detected when:

- a) an NCM-TPDU is associated with a known nc-reference (see B.6.2.5); and
- b) there is an N-CONNECT confirm pending for the network connection used for the nc-reference.
NOTE – In other words a collision is an association with an nc-reference either in OPENING or RECOVERY state.

B.6.2.6.2 Collision resolution mechanism**B.6.2.6.2.1 Collision winner**

When a collision occurs, one of the two network connections (i.e. the one which is currently used for the nc-reference and the one carrying the NCM-TPDU which is associated with the nc-reference) has to be disconnected.

ISO/IEC 8073 : 1997 (E)

In general the state of the nc-reference determines which network connection shall be disconnected.

However, in the following two cases:

- a) The NCM has been associated with an nc-reference in RECOVERY state according to B.6.2.5 a) and the TYPE parameter has a value different from NEW.
NOTE 1 – In this case both ends are in RECOVERY state.
- b) Or the NCM has been associated according to B.6.2.5 b).
NOTE 2 – In this case both ends are in OPENING state.

The following procedure shall be used to determine if the local transport entity is the collision winner or the collision loser. The local entity is the winner if:

- a) The state of the nc-reference is OPENING and the local allocated nc-reference has a lower value (nc-reference to be treated as a 16-bit integer) than the nc-reference of the received NCM-TPDU. In the case when both references are equal, both network connections are disconnected, i.e. refused, and both transport entities choose another nc-reference and try (eventually) again.
- b) The state of the nc-reference is RECOVERY and the preference attached to nc-reference is higher than the one contained in the NC-PREF field of the received NCM-TPDU.
- c) The state of the nc-reference is RECOVERY and the preference attached to nc-reference is equal to the one contained in the NC-PREF field of the received NCM-TPDU and either:
 - 1) the source of allocation of the nc-reference is local and the value of the NC-REC field of the first sent NCM-TPDU (i.e. which had NC-TYPE = NEW) was “please do not recover”; or
 - 2) the source of allocation of the nc-reference is remote and the value of the NC-REC field of the first sent NCM-TPDU (i.e. which had NC-TYPE = NEW) is “please recover”.

B.6.3 NCM confirmation

When an NCM-TPDU has been sent with RIGHT set to RA the transport entity which receives and processes the NCM-TPDU shall, if accepting the incoming network connection, transmit an NCMC-TPDU in the NS-user data parameter of the N-CONNECT response.

NOTE 1 – The NCMC TPDU is sent only if:

- a) the incoming network connection is accepted; and
- b) the received NCM-TPDU has the TYPE field set to NEW; and
- c) the received NCM-TPDU has the RIGHT field set to RA.

NOTE 2 – This mechanism avoids possible useless freezing of resources (network connection) when the peer-entity ignores an NCM-TPDU which gives exclusive assignment.

If an N-CONNECT confirmation is received after having an NCM-TPDU with RIGHT set to RA, which does not carry an NCMC-TPDU, the initiator shall disconnect the network connection.

NOTE 3 – The absence of NCMC-TPDU indicates that the peer-entity did not process the NCM-TPDU.

B.7 Protocol operation

B.7.1 Receipt of an N-CONNECT indication

The recipient of an N-CONNECT indication which either does not contain an NCM-TPDU or contains an NCM-TPDU which it chooses to ignore, shall follow the procedures described in the main body of this Recommendation | International Standard. If the NCM-TPDU is to be processed, then the transport entity shall apply the procedure for association of NCM-TPDU to a known nc-reference (see B.6.2.5). If the NCM-TPDU is associated, then the transport entity shall apply either the procedure described in B.7.3 a) or B.7.3 b) or B.7.4.2 b) or B.7.4.3 c) or B.7.4.2 or B.7.5, depending upon the state of the nc-reference. Otherwise the procedure in B.7.2 applies.

B.7.2 Passive network connection establishment with NCM-TPDU

The transport entity may either decide to refuse the incoming network connection (i.e. issue an N-DISCONNECT request) or accept the network connection.

If the transport entity elects to accept the network connection it shall:

- a) issue an N-CONNECT response; if the RIGHT field of the received NCM-TPDU contains the value RA, the NCMC-TPDU shall be transmitted in the NS-user data parameter of the N-CONNECT response;
- b) note the nc-reference and the pair of NSAPs;
- c) note that the nc-reference has been remotely allocated;
- d) note the assignment rights as my-side if RA has been received in the RIGHT field of the NCM-TPDU, as remote-side if SA has been received or both-sides if AA has been received;
- e) put the nc-reference into the OPEN state and use it for assignment or reassignment if it is (one of) the owner(s).

B.7.3 Active network connection establishment with NCM-TPDU

The transport entity, which elects to use the NCMS procedure when opening a network connection shall send an N-CONNECT request with the UN-TPDU (see ITU-T Rec. X.264 and ISO/IEC 11570) and NCM-TPDU contained in the NS-user data parameter. The NCM-TPDU parameters are set as follows:

- NC-REF contains the selected reference which shall neither be used for any other network connection between the same pair of NSAPs nor frozen;
- NC-TYPE is set to NEW;
- NC-RIGHT is set to SA, RA or AA;
- NC-PREF is set to low, medium or high according to the preference of the initiator to keep this connection in case of collision.

NOTE – The selection of this value can be based on the knowledge of the correspondence between the expected QOS, the cost when reverse charging is used and other optimization considerations.

The initiator shall store the nc-reference together with the pair of NSAPs to be joined by the network connection being established, the value of the NC-PREF parameter sent, the ownership of the network connection and the source of the nc-reference (locally allocated in this case).

The state of the nc-reference shall be set to OPENING.

The initiator shall wait for an N-CONNECT confirm to complete the establishment. If the assignment rights are “remote side” (i.e. an NCM-TPDU with the RIGHT parameter having the value RA was sent) the received N-CONNECT confirm shall contain an NCMC-TPDU in its user data parameter, otherwise the transport entity shall disconnect the network connection. If one of the following cases occurs, the initiator shall perform the action specified:

- a) If an NCM-TPDU is received and associated according to B.6.2.5 b) (TYPE = NEW) the transport entity shall apply one of the following:
 - 1) If the local transport entity is the winner (see B.6.2.6.2) the incoming network connection is disconnected (i.e. an N-DISCONNECT request is sent in response to the incoming N-CONNECT indication) and the nc-reference remains in the OPENING state.
 - 2) If the local entity is the loser (see B.6.2.6.2) the network connection which was local opened is disconnected and the incoming network connection is accepted (i.e. an N-CONNECT response is issued). If the received NCM-TPDU contains the value RA in its RIGHT field the NCMC-TPDU shall be transmitted in the NS-user data parameter of the N-CONNECT response. The nc-reference which has been locally allocated is frozen for a TFR-NC period of time (and then released) and the transport entity keeps track of the nc-reference contained in the NC-REF parameter of the incoming NCM-TPDU as remotely allocated and in OPEN state. The network connection is considered as open and ready for use as described in the main body of this Recommendation | International Standard, according to the assignment rights.
Any transport connections assigned to the disconnected connection shall be reassigned:
- b) If an NCM-TPDU is received with a TYPE parameter different from NEW and is associated, the transport entity shall:
 - 1) issue an N-DISCONNECT request for the network connection for which the N-CONNECT confirm is awaited;
 - 2) respond to the incoming N-CONNECT indication by an N-CONNECT response;
 - 3) place the nc-reference in the OPEN state and consider the network connection as ready for assignment or reassignment according to the assignment rights.

- c) If an N-DISCONNECT indication is received, the transport entity may decide either to give up or try to reopen a network connection by issuing an N-CONNECT request containing an NCM-TPDU (see B.6.1.2 and B.6.2) which is a copy of the previously sent NCM-TPDU, except that the NC-PREF parameter may be different. The decision whether a new network connection has to be opened or not is a local matter subject to the following constraints:
- 1) When the first N-DISCONNECT indication is received, the entity shall start its TTR-NC timer and stop it when receiving the corresponding N-CONNECT confirm or N-CONNECT indication carrying an NCM-TPDU which is associated and processed as described above. When the timer runs out, the transport entity shall not try to open a network connection again if a new N-DISCONNECT indication is received.
 - 2) If the network connection is intended to be used for transport connections allowing recovery, the network connection has to be reopened in accordance with the agreed upon quality of service of the supported transport connection(s).

When recovery is not performed or has stopped (i.e. a new N-DISCONNECT is received and TTR-NC has run out) the nc-reference of the network connection is placed in a PENDING state for a TPD-NC period of time. During this period the transport entity may receive an incoming NCM-TPDU having this nc-reference (see B.7.4.3).

B.7.4 Network connection recovery

B.7.4.1 Receipt of an N-DISCONNECT indication

When a network connection which was established using NCMS is disconnected (i.e. an N-DISCONNECT is received) the transport entity shall either:

- a) elect not to reopen the network connection, place the nc-reference in the PENDING state for a TPD-NC period of time, and apply the procedure described in B.7.4.3; or
- b) attempt to reopen the network connection by following the procedure described in B.7.4.2.

Alternative b) is subject to the same constraints as described in B.7.3 c).

In all cases the transport entity shall apply the procedure corresponding to the receipt of an N-DISCONNECT indication to all transport connections assigned to the network connection.

B.7.4.2 Active recovery procedure

The transport entity shall open a network connection by putting the nc-reference into the RECOVERY state and sending an NCM TPDU in the NS-user data parameter of the N-CONNECT request according to B.6.1 c) and B.6.2 with the following parameters:

- a) NC-REF is set to the value of the nc-reference associated with the network connection.
- b) NC-TYPE is set to MY if the nc-reference was locally allocated, to YOURS if the nc-reference was remotely allocated.
- c) NC-PREF is set to the desired value (see B.7.3).
- d) NC-RIGHT may take any value.
NOTE – NC-RIGHT is not significant in an NCM-TPDU performing recovery.
- e) NC-REC is set to the desired value.

The transport entity shall then apply one of the following:

- a) if an N-DISCONNECT is received apply B.7.4.1;
- b) if an NCM-TPDU with type NEW is received and associated, the incoming network connection is rejected;
- c) if an NCM with type different from NEW is received, the collision winner is determined according to B.6.2.6.2 and:
 - 1) if the transport entity is the winner, the incoming network connection is rejected; or
 - 2) if the transport entity is the loser the incoming network connection is accepted (i.e. send an N-CONNECT response), the nc-reference is placed in the OPEN state and is ready for use according to the assignment rights. The network connection for which an N-CONNECT confirm was awaited is disconnected by issuing an N-DISCONNECT request.

B.7.4.3 Passive recovery procedure

If an N-CONNECT indication is received which carries an NCM-TPDU, which is associated to the nc-reference, the transport entity shall send an N-CONNECT response (with an NCMC-TPDU in the NS-user data parameter if the received NCM-TPDU is of type NEW and has the RIGHT field set to the value RA) and put the nc-reference into the OPEN state and consider it as ready for assignment according to the assignment rights.

If the TPD-NC timer expires and if the nc-reference was remotely allocated, then the transport entity does not keep track of it any longer; if the nc-reference was locally allocated, then the transport entity shall not reuse the reference until a TFR-NC period of time has elapsed.

B.7.5 Remotely initiated recovery

When a transport entity receives an NCM-TPDU which is associated with an nc-reference in OPEN state it shall:

- a) accept the incoming network connection and issue an N-CONNECT response; if the received NCM-TPDU is of type NEW and has the RIGHT field set to RA, the NCMC-TPDU shall be transmitted in the NS-user data parameter of the N-CONNECT response;
- b) issue an N-DISCONNECT request for the network connection which was associated with the nc-reference;
- c) apply to all transport connections assigned to this network connection the procedure defined in the main body of this Recommendation | International Standard for processing an N-DISCONNECT indication.

B.7.6 Optimization principles**B.7.6.1 Use of the NC-REC indicator**

Although the recovery protocol is symmetrical, it should be noted that a transport entity is always allowed not to initiate recovery by putting the nc-reference into the PENDING state.

NOTE 1 – Not initiating recovery is equivalent to having a value of zero for the TTR-NC timer.

In order to avoid unnecessary recovery being performed or recovery being delayed the NC-REC field of the NCM-TPDU should be set as follows:

- a) 0 (please do not recover) – Indicates that the sender does not rely on recovery being performed by the receiver, and intends to recover even if not required for its own need.
- b) 1 (please recover) – Indicates that the sender expects a recovery to be done by the receiver, and does not intend to recover if it does not need it.

When the nc-reference is in the OPEN state, the NC-REC field of the associated NCM-TPDU gives both entities a view of the recovery intention of the partner.

When a transport entity has to initiate recovery, i.e. an N-DISCONNECT indication has been received in OPENING or RECOVERY state and TTR-NC has not run out, it is recommended that:

- a) if the entity has received an NCM-TPDU with the NC-REC field set to “please recover”, it should try to recover even when this is not necessary for its own assignment needs;
- b) if the entity has received an NCM-TPDU with the NC-REC field set to “please don’t recover”, it should not initiate recovery if this is not required for its own assignment needs;
- c) if the entity has sent an NCM-TPDU with the NC-REC field set to “please don’t recover”, it should initiate recovery even if not required for its own assignment needs;
- d) if the entity has sent an NCM-TPDU with the NC-REC field set to “please recover”, it should not initiate recovery if not required for its own assignment needs.

NOTE 2 – As a local choice, it is possible to implement a symmetrical recovery mechanism by setting the NC-REC field to the value “please recover” and initiating recovery even though not required for the local assignment needs.

B.7.6.2 Use of NS-user data parameter in N-DISCONNECT primitive

The reason code in the N-DISCONNECT primitive does not adequately specify enough information to completely optimize the connection recovery mechanisms since the values defined in the network service (see CCITT Rec. X.213 | ISO/IEC 8348) do not distinguish between the cases where recovery is desirable immediately or not and do not provide adequate diagnostic information. Thus the NS-user data parameter of the N-DISCONNECT request may be used and may contain a DIAG-TPDU.

When a network connection is no longer needed, it is recommended that only the owner(s) disconnect it, and put a DIAG-TPDU with code 1 into the NS-user data parameter of the N-DISCONNECT request primitive.

B.7.7 Releasing a network connection

Either entity may release a network connection at any time by issuing an N-DISCONNECT request. It is recommended to use the DIAG-TPDU in order to optimize this procedure as described in B.7.6.2.

If the remote transport entity has assignment rights the nc-reference shall be placed in the PENDING state after the network connection has been released.

If the remote transport entity does not have assignment rights the nc-reference may, as a matter of local choice:

- a) be put in the PENDING state; or
- b) if locally allocated be frozen; or
- c) if remotely allocated be made unknown.

B.8 Structure and encoding of TPDU

B.8.1 Validity

Table B.4 specifies the TPDU valid for this annex.

Table B.4 – TPDU codes

Name	Code
NCM, Network Connection Management	0000 0010
DIAG, Diagnostic	0000 0011
NCMC, Network Connection Management Confirmation	0000 0100

B.8.2 Structure

The structure is defined in 13.2.

B.8.3 Network Connection Management (NCM) TPDU

B.8.3.1 Structure

1	2	3	4	5	6
LI	NCM 0000 0010	NC-REF	NC-TYPE NC-PREF	NC-COL NC-REC NC-RIGHT	

B.8.3.2 LI

See 13.2.1.

B.8.3.3 Fixed part

The fixed part shall contain:

- a) NCM – NCM-TPDU code: 0000 0010.
- b) NC-REF – The nc-reference.
- c) NC-TYPE – Indicates the type of the nc-reference which is sent. NC-TYPE consists of bits 8 and 7 of octet 5 and may have the value 00 (NEW), 01 (MY) or 10 (YOURS), value 11 is reserved.
- d) NC-PREF – Indicates the preference the initiator has to keep the network connection in case of collision. NC-REF is bits 6-1 of octet 5:
 - 000000 Highest preference
 - 000001 Medium
 - 000011 Lowest preference
- e) NC-COL – Indicates the collision algorithm to be used. NC-COL is bit 8 of octet 6. Only one value is defined (0): resolution of collision when N-CONNECT indication is received.
- f) NC-REC – Indicates the recovery optimization option. NC-REC is bit 7 of octet 6:
 - 0 Please do not recover
 - 1 Please recover
- g) NC-RIGHT – Indicates the kind of right of use given by the entity to its peer. NC-RIGHT is bits 6-1 of octet 6:
 - 000001 SA
 - 000010 RA
 - 000011 AA

B.8.3.4 Variable part

There is no variable part.

B.8.4 Diagnostic (DIAG) TPDU

This TPDU is only transferred in the NS-user data parameter of an N-DISCONNECT. It provides diagnostic information. Sending and/or processing this TPDU is optional.

B.8.4.1 Structure

1	2	3
LI	DIAG 0000 0011	CODE

B.8.4.2 LI

See 13.2.1.

ISO/IEC 8073 : 1997 (E)

B.8.4.3 Fixed part

The fixed part shall contain:

- a) DIAG – DIAG-TPDU code 0000 0011.
- b) CODE – Indicates the reason for disconnecting the network connection. The following values shall be used:
 - 0 Collision detection resolution
 - 1 Network connection no longer needed
 - 2 Unrecognized NC-REF (do not try to recover with this NC-REF)
 - 3 Network connection cannot be accepted (temporary congestion)
 - 4 A new network connection cannot be accepted again (long-term congestion or shutdown in progress)

B.8.4.4 Variable part

There is no variable part.

B.8.5 Network Connection Management Confirm (NCMC) TPDU

B.8.5.1 Structure

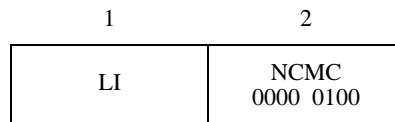

B.8.5.2 LI

See 13.2.1.

B.8.5.3 Fixed part

The fixed part shall contain the NCMC-TPDU code: 0000 0100.

B.8.5.4 Variable part

There is no variable part.

B.9 Conformance

B.9.1 When initiating a network connection a transport entity shall either:

- a) not use the NS-user data parameter of N-CONNECT request primitive and operate using the protocol of the main body of this Recommendation | International Standard on this network connection; or
- b) include in the NS-user data parameter of the N-CONNECT request a UN-TPDU (see ITU-T Rec. X.264 and ISO/IEC 11570) with the PRT-ID field set to the value 01 followed by an NCM-TPDU and operate the NCMS procedure together with those specified in the main body of this Recommendation | International Standard.

B.9.2 When processing an N-CONNECT indication, a transport entity shall either:

- a) operate using the protocol of the main body of this Recommendation | International Standard if no user data is present or if it is not claimed that the implementation supports the NCMS procedure; or
- b) operate using the protocol of the main body of this Recommendation | International Standard together with the network connection management procedure if the UN [with the PRT-ID field set to the value 01 (see ITU-T Rec. X.264 and ISO/IEC 11570)] and NCM-TPDUs are present; or
- c) operate using the protocol of the main body of this Recommendation | International Standard but ignore the NCM-TPDU if the UN [with the PRT-ID field set to the value 01 (see ITU-T Rec. X.264 and ISO/IEC 11570)] and NCM TPDUs are present.

B.10 State table

The state Tables B.5, B.6, B.7, B.8, B.9 and B.10 define the states of a network connection reference as maintained by a single transport entity obeying the procedure of this annex. Due to failures and recoveries of network connections this reference may over a period of time be associated with many network connections, one at a time. When an NCM-TPDU is received, the association procedure (see B.6.2.5) is applied first.

Table B.5 – Events

Event	Description
NCMNEWrec	An N-CONNECT indication containing an NCM-TPDU with NC-TYPE = NEW is received.
NCMNOTNEWrec	An N-CONNECT indication containing an NCM-TPDU with NC-TYPE not NEW is received.
NDISind	An N-DISCONNECT indication.
Collision	A collision in the OPENING state as a result of association as described in 6.3.5 b).
TPD-NCexp	The timer TPD-NC expires.
TTR-NRexp	The timer TTR-NC expires.
Local decision	The transport entity may choose to initiate this transition.
Any TPDU	Receipt of any TPDU on the network connection.
NCONconf	A C-CONNECT confirmation.

Table B.6 – Actions

Action	Description
NCONreq	Issue an N-CONNECT request to the network service.
NCMNEW	Send an NCM-TPDU with the NCONreq with NC-TYPE = NEW and locally allocated nc-reference.
NCMNOTNEW	Send an NCM-TPDU with the NCONreq with NC-TYPE set to show the original source of allocation of the reference.
NDISreq	Issue an N-DISCONNECT request to the network service.
NCONresp	Issue an N-DISCONNECT response to the network service.
[1]	Start TPD-NC timer.
[2]	Start TTR-NC timer if not already running.
[3]	Freeze the nc-reference for TFR-NC if locally allocated.
[4]	The remotely initiated connection has been the winner. Re-assign any TCs from the loser and process the incoming NCM-TPDU as an NCMNEW in the CLOSED state for the winning reference.
[5]	Stop TTR-NC if running, otherwise remove information that it has expired.
[6]	Stop TPD-NC.
[7]	Record with the nc-reference that a TPDU has been received.
[8]	Store information that TTR-NC has expired.
[9]	If the received NCM-TPDU has the RIGHT field set to the value RA, a NCMC-TPDU is transmitted in the NS-user data parameter of N-CONNECT response.

Table B.7 – Predicates

Predicate	Description
P1	Incoming network connection unacceptable or the local entity is the winner of a collision.
P2	Remote transport entity is not an owner of the network connection and local choice.
P3	Local choice not to recover or TTR-NC has previously expired.
P4	Local choice not to recover.
P5	The remotely initiated network connection is the winner of collision resolution.
P6	A TPDU has been received on a network connection associated with this nc-reference [see (7)].
P7	Assignment rights are “remote side” and N-CONNECT confirmation does not carry an NCMC-TPDU.

Table B.8 – Notes

Note	Description
(1)	DIAG-TPDU with CODE = 0 may be sent.
(2)	The new connection is retained and the old connection disconnected.
(3)	Repeat the previous NCM except that NC-PREF may be different.
(4)	This is a protocol error.
(5)	Discard the “loser” after collision resolution.
(6)	The incoming network connection is disconnected and the old one retained.

Table B.9 – States

Note	Description
CLOSED	Network connection is closed.
OPENING	Network connection requested but not yet confirmed.
OPEN	Network connection is open.
RECOVERY	Attempting recovery of a failed network connection.
PENDING	A non-owner of the network connection is waiting for recovery by the owner.

Table B.10 – State Table

State	CLOSED	OPENING	OPEN	RECOVERY	PENDING
Event					
NCMNEWrec	P1: NDISreq CLOSED; not P1: [9] NCONresp OPEN		P6: (4) NDISreq OPEN; not P6: [9] NCONresp NDISreq (2) OPEN	NDISreq (6) RECOVERY	P6: (4) NDISreq PENDING; not P6: [9] NCONresp [6] OPEN
NCMNOTNEWrec	(4) NDISreq	NCONresp (2) NDISreq OPEN	NCONresp (2) NDISreq OPEN	P1: NDISreq (1) RECOVERY; not P1: NCONresp NDISreq (2) (5) OPEN	NCONresp [6] OPEN
Local decision	NCMNEW OPENING				
NDISind		Not P3: [2] NCMNEW (3) OPENING; P2 and P3: [3] CLOSED; (not P2) and P3: [1, 5] PENDING	Not P4: NCMNOTNEW [2] RECOVERY; P2 and P4: [3] CLOSED; P4 and not P2: [1] PENDING	Not P3: NCMNOTNEW RECOVERY; P3: [1, 5] PENDING	
Collision		P1: NDISreq (1) OPENING; not P1: NDISreq (2) [4, 3] CLOSED			
TPD-NCexp					[3] CLOSED
Any TPDU			[7] OPEN		
TTR-NCexp		[8] OPENING		[8] RECOVERY	
NCONconf		P7: [3] CLOSED; not P7: [5] OPEN		[5] OPEN	

B.11 Diagram for NCMS protocol operation

This subclause provides some tutorial information by giving examples of collision cases (see B.11.1) and remotely initiated recovery (see B.11.2). This subclause is informative.

B.11.1 Collision case

B.11.1.1 Both ends detect a collision on OPENING state with TYPE = NEW

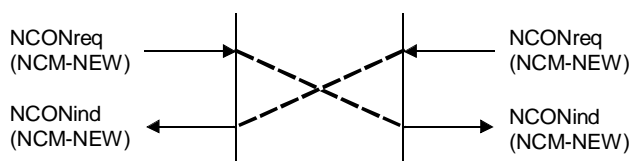

T0719320-94/d05

The references are different but both ends have decided to associate the received NCM-TPDU according to B.6.2.5 b).

B.11.1.2 Both ends detect a collision in RECOVERY state

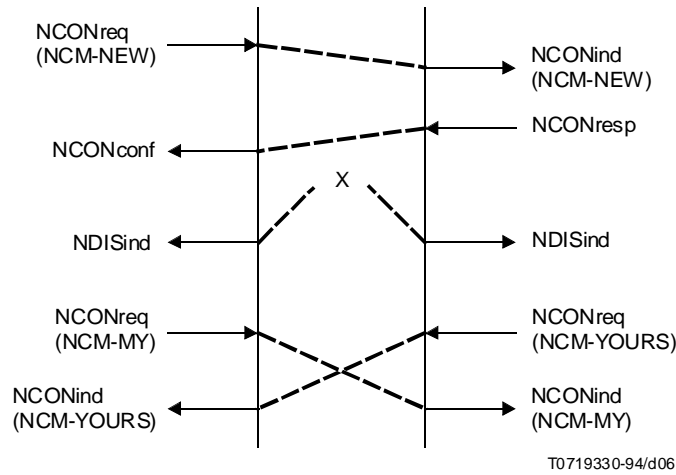

Both entities will use the collision resolution algorithm and one of the two network connections will be disconnected.

B.11.1.3 The initiator detects a collision in OPENING state with TYPE different from NEW

B.11.1.3.1 The other end is in RECOVERY state

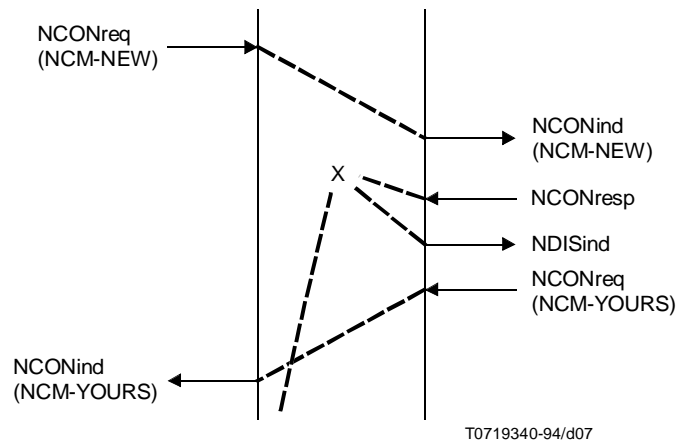

The entity in OPENING state (left side) accepts the incoming network connection and disconnects the PENDING one.

B.11.1.3.2 The other end detects a collision in RECOVERY state

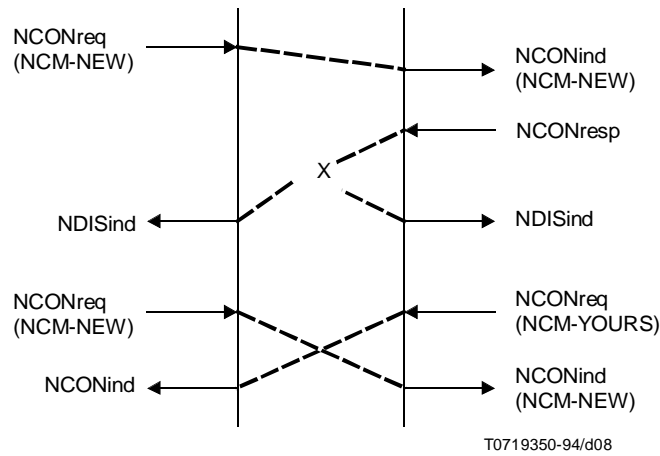

Both entities disconnect the network connection initiated by the entity on the left.

B.11.2 Remotely initiated recovery

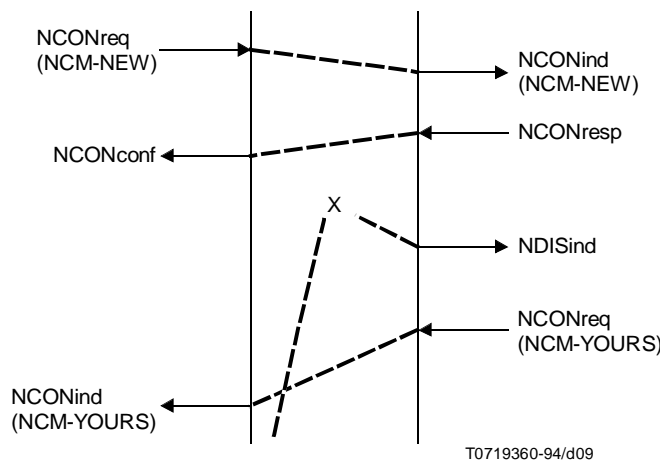

The entity on the left detects an incoming network connection in OPEN state and disconnects the old connection.

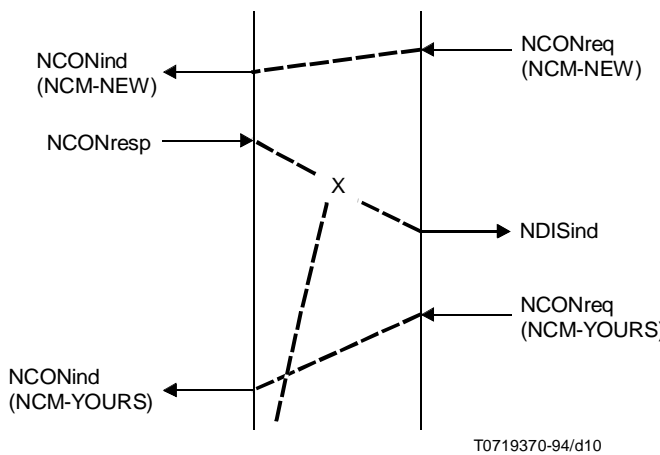

The entity on the left detects an incoming network connection in OPEN state and disconnects the old connection.

Annex C¹⁾

PICS Proforma

(This annex forms an integral part of this Recommendation | International Standard)

C.1 General

C.1.1 Symbols used

Status symbols:

- M Mandatory
- O Optional to implement. If implemented the feature may or may not be used.
- O.<n> Optional but support of at least one of the group of options labelled by the same numeral <n> in this PICS proforma is required.
- <index>: This predicate symbol means that the status following it applies only when the PICS states that the feature identified by the index is supported. In the simplest case, <index> is the identifying tag of a single PICS item. <index> may also be a Boolean expression composed of several indices.
- <index>::When this group predicate is true the associated clause should be completed.

Support symbols:

- Yes Supported
- No Not supported
- N/A Not applicable

C.1.2 Instructions for completing the PICS proforma

The main part of the PICS proforma is a fixed-format questionnaire divided into a number of clauses. Answers to the questionnaire are to be provided in the rightmost column either by simply marking an answer to indicate a restricted choice (such as Yes or No) or by entering a value of a range of values or entering what action is taken.

C.2 Identification

C.2.1 Implementation identification

Supplier	
Contact point for queries about the PICS	
Implementation Names(s) and Version(s)	
Other information necessary for full identification – e.g. name(s) and version(s) of machines and/or operating systems; System Name(s)	
<p>NOTES</p> <p>1 Only the first three items are required for all implementations; other information may be completed as appropriate in meeting the requirement for full identification.</p> <p>2 The terms Name and Version should be interpreted appropriately to correspond with a supplier’s terminology (e.g. Type, Series, Model).</p>	

¹⁾ **Copyright release for PICS proforma**

Users of this Recommendation | International Standard may freely reproduce the PICS proforma in this annex so that it can be used for its intended purpose and may further publish the completed PICS.

C.2.2 Protocol summary

Identification of protocol specification	ISO/IEC 8073:1992 ITU-T Rec. X.224 Reference Number: X.224 (1993)
Identification of Amendments and Corrigenda to this PICS proforma which have been completed as part of this PICS	ITU-T Rec. X.224 (1993) ISO/IEC 8073:1992
Protocol Version(s) supported	Version 1
Have any Exception items been required?	No [] Yes []
(The answer Yes means that the implementation does not conform to ITU-T Rec. X.224 (1993) ISO/IEC 8073:1992)	

Date of statement	
-------------------	--

C.3 Indices used in this annex

A	C.6.1
C	C.6.2
C4L	C.6.2
CCT	C.5
DRCC	C.14
DRCR	C.14
DRDR	C.14
D1ICC	C.13.1
D1ICR	C.13.1
D1IDR	C.13.1
D2ICC	C.13.2
D2ICR	C.13.2
D2IDR	C.13.2
D3ICC	C.13.3
D3ICR	C.13.3
D3IDR	C.13.3
D4ICC	C.13.4
D4ICR	C.13.4
D4IDR	C.13.4
IC	C.11.1.2
ICR	C.11.2
IR	C.8
I0CC	C.11.3
I0CR	C.11.3
I0DR	C.11.3
I1CC	C.11.4
I1CR	C.11.4
I1DR	C.11.4
I1DT	C.11.4
I1ER	C.11.4
I2CC	C.11.5
I2CR	C.11.5
I2DR	C.11.5
I2ER	C.11.5
I3CC	C.11.6

ISO/IEC 8073 : 1997 (E)

I3CR	C.11.6
I3DR	C.11.6
I3DT	C.11.6
I3ER	C.11.6
I4AK	C.11.7
I4CC	C.11.7
I4CR	C.11.7
I4DR	C.11.7
I4DT	C.11.7
I4ER	C.11.7
ISO	C.5
N	C.7
NAC	C.15.1
NEF	C.15.5
NC	C.15.1
NUC	C.15.7
NUF	C.15.8
OT	C.17
PE	C.16.1
PE4L	C.16.1
RC	C.15.3
RC4a	C.15.3
RN	C.12.1.2
ROA	C.15.12
RR	C.16.2
R4AKch	C.12.2
R4CCch	C.12.2
R4DCch	C.12.2
R4DRch	C.12.2
R4DTch	C.12.2
R4EAch	C.12.2
R4EDch	C.12.2
R4ERch	C.12.2
SER	C.10
SER4L	C.10
SN	C.10
ST	C.10
TA	C.17
TED	C.15.6
TS	C.15.4
T0F	C.9.1
T0S	C.15.4
T1F	C.9.2
T1S	C.15.4
T2F	C.9.3
T2S	C.15.4
T3F	C.9.4
T3S	C.15.4
T4F	C.9.5
T4S	C.15.4
UL	C.16.3
UNED	C.15.10
UNRC	C.15.9
USA	C.15.11

C.4 Based Recommendation | International Standard conformance

Does the implementation claim conformance to ISO/IEC 8073?	Yes	No
Does the implementation claim conformance to ITU-T Rec. X.224?	Yes	No

C.5 General statement of conformance

ISO	Are all mandatory features of ISO/IEC 8073 implemented?	Yes	No
CCT	Are all mandatory features of ITU-T Rec. X.224 implemented?	Yes	No
NOTE – Answering “No” to this question indicates non-conformance to the Recommendation International Standard			

C.6 Protocol implementation**C.6.1 Annex B – NCMS**

Index		References	Status	Support
A1	Network connection management procedures	Annex B	O	Yes No

C.6.2 Classes implemented

Index	Class	References	Status	Support
C0	Class 0	14	ISO:O.1 CCT:M	Yes No
C1	Class 1	14	C0:O	Yes No
C2	Class 2	14	ISO:O.1 CCT:O	Yes No
C3	Class 3	14	C2:O	Yes No
C4	Class 4 operation over CONS	14	C2:O	Yes No
C4L	Class 4 operation over CLNS	14	ISO:C2:O CCT:N/A	Yes No

C.7 NCMS functions

Index	Item	References	Status	Support
N2	Network connection management	B.6.2.1	O	Yes No
N3	Diagnostic	B.7.6.2, B.7.7	O	Yes No
N4	Active network connection recovery	B.7.4.2	O	Yes No

ISO/IEC 8073 : 1997 (E)

The following is mandatory if the predicate is true.

Index	Item	References	Status	Support
N5	Passive network connection recovery	B.7.4.3	N2 OR N4: M	Yes No
N6	Is an NCM-TPDU with assignment right set to RA always rejected with N-DISCONNECT request?	B.6.3	O	Yes No

C.8 Initiator/responder capability for protocol classes 0 - 4

Index		References	Status	Support
IR1	Initiating CR-TPDU	14.4 a)	O.2	Yes No
IR2	Responding to CR-TPDU	14.4 a)	O.2	Yes No

C.9 Supported functions**C.9.1 Supported functions for class 0 (C0::)**

The following functions are mandatory if class 0 is supported.

Index	Function	References	Status	Support
T0F1	Assignment to network connection when operating over CONS	6.1.1	M	Yes
T0F2	TPDU transfer	6.2	M	Yes
T0F3	Segmenting	6.3	M	Yes
T0F4	Reassembling	6.3	M	Yes
T0F5	Connection establishment	6.5	M	Yes
T0F6	Connection refusal	6.6	M	Yes
T0F7	Normal release when operating over CONS (implicit)	6.7.1	M	Yes
T0F8	Error release when operating over CONS	6.8	M	Yes
T0F9	Association of TPDU's with Transport connection when operating over CONS	6.9.1	M	Yes
T0F10	Treatment of protocol errors when operating over CONS	6.22.1	M	Yes

C.9.2 Supported functions for class 1 (C1::)

The following functions are mandatory if class 1 is supported.

Index	Function	References	Status	Support
T1F1	Assignment to network connection when operating over CONS	6.1.1	M	Yes
T1F2	TPDU transfer	6.2	M	Yes
T1F3	Segmenting	6.3	M	Yes
T1F4	Reassembling	6.3	M	Yes
T1F5	Separation	6.4	M	Yes
T1F6	Connection establishment	6.5	M	Yes
T1F7	Connection refusal	6.6	M	Yes
T1F8	Normal release when operating over CONS (explicit)	6.7.1	M	Yes
T1F9	Association of TPDU's with Transport connections when operating over CONS	6.9.1	M	Yes
T1F10	Data TPDU numbering (normal)	6.10	M	Yes
T1F11	Expedited data transfer when operating over CONS (Network normal)	6.11.1	M	Yes
T1F12	Reassignment after failure when operating over CONS	6.12	M	Yes
T1F13	Retention and acknowledgement of TPDU's Retention until acknowledgement of TPDU's (AK)	6.13.4.1	M	Yes
T1F14	Resynchronization	6.14	M	Yes
T1F15	Frozen references	6.18	M	Yes
T1F16	Treatment of protocol errors when operating over CONS	6.22.1	M	Yes

The following functions are optional if class 1 is supported.

Index	Function	References	Status	Support
T1F17	Concatenation	6.4	O	Yes No
T1F18	Expedited data transfer when operating over CONS (Network expedited)	6.11.1	O	Yes No
T1F19	Retention and acknowledgement of TPDU's Confirmation of Receipt	6.13.4.2	Not T1F20: O	Yes No
T1F20	Retention and acknowledgement of TPDU's Use of request acknowledgement	6.13.4.3	Not T1F19: O	Yes No

C.9.3 Supported functions for class 2 (C2::)

The following functions are mandatory if class 2 is supported.

Index	Function	References	Status	Support
T2F1	Assignment to network connection when operating over CONS	6.1.1	M	Yes
T2F2	TPDU transfer	6.2	M	Yes
T2F3	Segmenting	6.3	M	Yes
T2F4	Reassembling	6.3	M	Yes
T2F5	Separation	6.4	M	Yes
T2F6	Connection establishment	6.5	M	Yes
T2F7	Connection refusal	6.6	M	Yes
T2F8	Normal release when operating over CONS (explicit)	6.7.1	M	Yes
T2F9	Error release when operating over CONS	6.8	M	Yes
T2F10	Association of TPDU with Transport connections when operating over CONS	6.9.1	M	Yes
T2F11	Data TPDU numbering (normal)	6.10	M	Yes
T2F12	Expedited data transfer when operating over CONS (Network normal)	6.11.1	M	Yes
T2F13	Demultiplexing when operating over CONS	6.15	M	Yes
T2F14	Explicit flow control (with)	6.16	M	Yes
T2F15	Treatment of protocol errors when operating over CONS	6.22.1	M	Yes
T2F16	Multiplexing when operating over CONS	6.15	M	Yes

The following functions or elements of procedure are optional if class 2 is supported.

Index	Function	References	Status	Support
T2F17	Concatenation	6.4	O	Yes No
T2F18	Data TPDU numbering (extended)	6.10	O	Yes No
T2F19	Explicit flow control (without)	6.16	O	Yes No

C.9.4 Supported functions for class 3 (C3::)

The following functions are mandatory if class 3 is supported.

Index	Function	References	Status	Support
T3F1	Assignment to network connection when operating over CONS	6.1.1	M	Yes
T3F2	TPDU transfer	6.2	M	Yes
T3F3	Segmenting	6.3	M	Yes
T3F4	Reassembling	6.3	M	Yes
T3F5	Separation	6.4	M	Yes
T3F6	Connection establishment	6.5	M	Yes
T3F7	Connection refusal	6.6	M	Yes
T3F8	Normal release when operating over CONS (explicit)	6.7.1	M	Yes
T3F9	Association of TPDU with Transport connections when operating over CONS	6.9.1	M	Yes
T3F10	Data TPDU numbering (normal)	6.10	M	Yes
T3F11	Expedited data transfer when operating over CONS (Network normal)	6.11.1	M	Yes
T3F12	Reassignment after failure when operating over CONS	6.12	M	Yes
T3F13	Retention and acknowledgement of TPDU Retention until acknowledgement of TPDU (AK)	6.13.4.1	M	Yes
T3F14	Resynchronization	6.14	M	Yes
T3F15	Demultiplexing when operating over CONS	6.15	M	Yes
T3F16	Explicit flow control	6.16	M	Yes
T3F17	Frozen references	6.18	M	Yes
T3F18	Treatment of protocol errors when operating over CONS	6.22.1	M	Yes
T3F19	Multiplexing when operating over CONS	6.15	M	Yes

The following functions are optional if class 3 is supported.

Index	Function	References	Status	Support
T3F20	Concatenation	6.4	O	Yes No
T3F21	Data TPDU numbering (extended)	6.10	O	Yes No
T3F22	Retention and acknowledgement of TPDU Use of request acknowledgement	6.13.4.3	O	Yes No

C.9.5 Supported functions for class 4 (C4 or C4L::)

The following functions are mandatory.

Index	Function	References	Status	Support
T4F1	TPDU transfer	6.2	M	Yes
T4F2	Segmenting	6.3	M	Yes
T4F3	Reassembling	6.3	M	Yes
T4F4	Separation	6.4	M	Yes
T4F5	Connection establishment	6.5	M	Yes
T4F6	Connection refusal	6.6	M	Yes
T4F7	Data TPDU numbering (normal)	6.10	M	Yes
T4F8	Retention and acknowledgement of TPDU's Retention until acknowledgement of TPDU's (AK)	6.13.4.1	M	Yes
T4F9	Explicit flow control	6.16	M	Yes
T4F10	Checksum	6.17	M	Yes
T4F11	Frozen references	6.18	M	Yes
T4F12	Retransmission on time-out	6.19	M	Yes
T4F13	Resequencing	6.20	M	Yes
T4F14	Inactivity control	6.21	M	Yes

The following functions are mandatory if class 4 is operated over CONS.

Index	Function	References	Status	Support
T4F15	Assignment to network connection when operating over CONS	6.1.1	M	Yes
T4F16	Normal release when operating over CONS (explicit)	6.7.1	M	Yes
T4F17	Association of TPDU's with Transport connections when operating over CONS	6.9.1	M	Yes
T4F18	Expedited data transfer when operating over CONS (Network normal)	6.11.1	M	Yes
T4F19	Multiplexing when operating over CONS	6.15	M	Yes
T4F20	Demultiplexing when operating over CONS	6.15	M	Yes
T4F21	Treatment of protocol errors when operating over CONS	6.22.1	M	Yes
T4F22	Recombining when operating over CONS	6.23	M	Yes

The following functions are mandatory if class 4 is operated over CLNS.

Index	Function	References	Status	Support
T4F23	Transmission over CLNS	6.1.2	M	Yes
T4F24	Normal release when operating over CLNS (explicit)	6.7.2	M	Yes
T4F25	Association of TPDU's with Transport connection when operating over CLNS	6.9.2	M	Yes
T4F26	Expedited data transfer when operating over CLNS (Network normal)	6.11.2	M	Yes
T4F27	Treatment of protocol errors when operating over CLNS	6.22.2	M	Yes

The following functions are optional.

Index	Function	References	Status	Support
T4F28	Data TPDU numbering (extended)	6.10	O	Yes No
T4F29	Non-use of checksum	6.17	O	Yes No
T4F30	Concatenation	6.4	O	Yes No
T4F31	Retention and acknowledgement of TPDU's Use of selective acknowledgement	6.13.4.4	O	Yes No
T4F32	Retention and acknowledgement of TPDU's Use of request acknowledgement	6.13.4.3	O	Yes No

The following functions are optional if class 4 is operated over CONS.

Index	Function	References	Status	Support
T4F33	Splitting when operating over CONS	6.23	O	Yes No

C.10 Supported TPDU

The following TPDU and the parameters which constitute their fixed parts are mandatory if a corresponding predicate in the status column is true.

Index	TPDUs		References	Status	Support
ST1	CR	Supported on transmission	13.1	IR1:M	Yes No
ST2	CR	Supported on receipt	13.1	IR2:M	Yes No
ST3	CC	Supported on transmission	13.1	IR2:M	Yes No
ST4	CC	Supported on receipt	13.1	IR1:M	Yes No
ST5	DR	Supported on transmission	13.1	IR2:M	Yes No
ST6	DR	Supported on receipt	13.1	IR1:M	Yes No
ST7	DC	Supported on transmission	13.1	C1 OR C2 OR C3 OR C4 OR C4L:M	Yes No
ST8	DC	Supported on receipt	13.1	C1 OR C2 OR C3 OR C4 OR C4L:M	Yes No
ST9	DT	Supported on transmission	13.1	M	Yes
ST10	DT	Supported on receipt	13.1	M	Yes
ST11	ED	Supported on transmission	13.1	C1 OR C2 OR C3 OR C4 OR C4L:M	Yes No
ST12	ED	Supported on receipt	13.1	C1 OR C2 OR C3 OR C4 OR C4L:M	Yes No
ST13	AK	Supported on transmission	13.1	C1 OR C2 OR C3 OR C4 OR C4L:M	Yes No
ST14	AK	Supported on receipt	13.1	C1 OR C2 OR C3 OR C4 OR C4L:M	Yes No
ST15	EA	Supported on transmission	13.1	C1 OR C2 OR C3 OR C4 OR C4L:M	Yes No
ST16	EA	Supported on receipt	13.1	C1 OR C2 OR C3 OR C4 OR C4L:M	Yes No
ST17	RJ	Supported on transmission	13.1	C1 OR C3:M	Yes No
ST18	RJ	Supported on receipt	13.1	C1 OR C3:M	Yes No
ST19	ER	Supported on receipt	13.1	M	Yes

State for which classes, if any, ER is supported on transmission.

Index	Class	References	Status	Support
SER0	Class 0	6.22.1	O	Yes No
SER1	Class 1	6.22.1	O	Yes No
SER2	Class 2	6.22.1	O	Yes No
SER3	Class 3	6.22.1	O	Yes No
SER4	Class 4 over CONS	6.22.1	O	Yes No
SER4L	Class 4 over CLNS	6.22.2	O	Yes No

The following TPDU's are mandatory if a corresponding predicate in the status column is true.

Index	TPDU's		References	Status	Support
SN3	NCM	Supported on transmission	B.8.1	N2:M	Yes No
SN4	NCM	Supported on receipt	B.8.1	N2:M	Yes No
SN5	DIAG	Supported on transmission	B.8.1	N3:M	Yes No
SN6	DIAG	Supported on receipt	B.8.1	N3:M	Yes No
SN7	NCMC	Supported on transmission	B.8.1	SN4 AND NOT N6:M	Yes No
SN8	NCMC	Supported on receipt	B.8.1	P1:M	Yes No
P1: SN3 and the only supported value in IC5 is "receiver".					

C.11 Supported parameters of issued TPDU's

C.11.1 Supported parameters for NCMS (A1::)

C.11.1.1 NCM-TPDU (SN3::)

What are the allowed values of the following parameters for an NCM-TPDU?

Index	Supported parameters	References	Allowed values	Supported values
IC1	NC-type	B.8.3.3 c)	New, My, Yours	
IC2	NC-preference	B.8.3.3 d)	Highest, Medium, Lowest	
IC3	NC-collision	B.8.3.3 e)	Resolution	
IC4	NC-recovery	B.8.3.3 f)	Do not, Do	
IC5	NC-assignment right	B.8.3.3 g)	Receiver, Sender, All	

C.11.2 Parameter values for CR-TPDU (C1:: OR C2:: OR C3:: OR C4:: or C4L::)

If the additional options selection parameter is issued in a CR-TPDU it is mandatory that:

Index		References
ICR1	Bits 8 and 7 shall be set to zero	13.3.4 g)

If the preferred class in the CR is 2, 3 or 4.

Index		References	Status	Support
ICR2	Is class 0 always offered as an alternative class?	14.4	O CCT:M	Yes No Yes No

C.11.3 Supported parameters for class 0 TPDU's (C0::)

The following parameters are optional if a CR-TPDU is issued with preferred class 0.

Index	Supported parameters	References	Status	Support
I0CR6	Called Transport-Selector	13.3.4 a)	O	Yes No
I0CR7	Calling Transport-Selector	13.3.4 a)	O	Yes No
I0CR8	TPDU size	13.3.4 b)	O	Yes No
I0CR9	Preferred maximum TPDU size	13.3.4 c)	O	Yes No

The following parameters are optional if a CC-TPDU is issued in class 0.

Index	Supported parameters	References	Status	Support
I0CC6	Responding Transport-Selector	13.4.4	O	Yes No
I0CC7	Calling Transport-Selector	13.4.4	O	Yes No
I0CC8	TPDU size	13.4.4	O	Yes No
I0CC9	Preferred maximum TPDU size	13.4.4	O	Yes No

The following parameter is optional if a DR-TPDU is issued in class 0.

Index	Supported parameters	References	Status	Support
I0DR4	Additional information	13.5.4 a)	O	Yes No

C.11.4 Supported parameters for class 1 TPDU's (C1::)

The following parameters are optional if a CR-TPDU is issued with preferred class 1.

Index	Supported parameters	References	Status	Support
I1CR6	Called Transport-Selector	13.3.4 a)	O	Yes No
I1CR7	Calling Transport-Selector	13.3.4 a)	O	Yes No
I1CR8	TPDU size	13.3.4 b)	O	Yes No
I1CR9	Version number	13.3.4 d)	O	Yes No
I1CR10	Protection parameters	13.3.4 e)	O	Yes No
I1CR11	Additional option selection	13.3.4 g)	O	Yes No
I1CR12	Alternative protocol class	13.3.4 h)	O	Yes No
I1CR13	Throughput	13.3.4 j)	O	Yes No
I1CR14	Residual error rate	13.3.4 k)	O	Yes No
I1CR15	Priority	13.3.4 l)	O	Yes No
I1CR16	Transit delay	13.3.4 m)	O	Yes No
I1CR17	Reassignment time	13.3.4 n)	O	Yes No
I1CR18	Preferred maximum TPDU size	13.3.4 c)	O	Yes No

The following parameters are optional if a CC-TPDU is issued in class 1.

Index	Supported parameters	References	Status	Support
I1CC6	Responding Transport-Selector	13.4.4	O	Yes No
I1CC7	Calling Transport-Selector	13.4.4	O	Yes No
I1CC8	TPDU size	13.4.4	O	Yes No
I1CC9	Protection parameters	13.4.4	O	Yes No
I1CC10	Additional option selection	13.4.4	O	Yes No
I1CC11	Throughput	13.4.4	O	Yes No
I1CC12	Residual error rate	13.4.4	O	Yes No
I1CC13	Priority	13.4.4	O	Yes No
I1CC14	Transit delay	13.4.4	O	Yes No
I1CC15	Preferred maximum TPDU size	13.4.4	O	Yes No

The following parameter is optional if a DR-TPDU is issued in class 1.

Index	Supported parameters	References	Status	Support
I1DR4	Additional information	13.5.4 a)	O	Yes No

The following parameter is optional if an ER-TPDU is issued in class 1.

Index	Supported parameters	References	Status	Support
I1ER3	Invalid TPDU	13.12.4 a)	O	Yes No

The following parameter is mandatory in a DT-TPDU if request of acknowledgement has been selected.

Index	Supported parameters	References	Status	Support
I1DT4	ROA	13.7.3 a)	M	Yes No

C.11.5 Supported parameters for class 2 TPDU (C2::)

The following parameters are optional if a CR-TPDU is issued with preferred class 2.

Index	Supported parameters	References	Status	Support
I2CR6	Called Transport-Selector	13.3.4 a)	O	Yes No
I2CR7	Calling Transport-Selector	13.3.4 a)	O	Yes No
I2CR8	TPDU size	13.3.4 b)	O	Yes No
I2CR9	Version number	13.3.4 d)	O	Yes No
I2CR10	Protection parameters	13.3.4 e)	O	Yes No
I2CR11	Additional option selection	13.3.4 g)	O	Yes No
I2CR12	Alternative protocol class	13.3.4 h)	O	Yes No
I2CR13	Throughput	13.3.4 j)	O	Yes No
I2CR14	Residual error rate	13.3.4 k)	O	Yes No
I2CR15	Priority	13.3.4 l)	O	Yes No
I2CR16	Transit delay	13.3.4 m)	O	Yes No
I2CR17	Preferred maximum TPDU size	13.3.4 c)	O	Yes No

The following parameters are optional if a CC-TPDU is issued in class 2.

Index	Supported parameters	References	Status	Support
I2CC6	Responding Transport-Selector	13.4.4	O	Yes No
I2CC7	Calling Transport-Selector	13.4.4	O	Yes No
I2CC8	TPDU size	13.4.4	O	Yes No
I2CC9	Protection parameters	13.4.4	O	Yes No
I2CC10	Additional option selection	13.4.4	O	Yes No
I2CC11	Throughput	13.4.4	O	Yes No
I2CC12	Residual error rate	13.4.4	O	Yes No
I2CC13	Priority	13.4.4	O	Yes No
I2CC14	Transit delay	13.4.4	O	Yes No
I2CC15	Preferred maximum TPDU size	13.4.4	O	Yes No

The following parameter is optional if a DR-TPDU is issued in class 2.

Index	Supported parameters	References	Status	Support
I2DR4	Additional information	13.5.4 a)	O	Yes No

The following parameter is optional if an ER-TPDU is issued in class 2.

Index	Supported parameters	References	Status	Support
I2ER3	Invalid TPDU	13.12.4 a)	O	Yes No

C.11.6 Supported parameters for class 3 TPDU's (C3:)

The following parameters are optional if a CR-TPDU is issued with preferred class 3.

Index	Supported parameters	References	Status	Support
I3CR6	Called Transport-Selector	13.3.4 a)	O	Yes No
I3CR7	Calling Transport-Selector	13.3.4 a)	O	Yes No
I3CR8	TPDU size	13.3.4 b)	O	Yes No
I3CR9	Version number	13.3.4 d)	O	Yes No
I3CR10	Protection parameters	13.3.4 e)	O	Yes No
I3CR11	Additional option selection	13.3.4 g)	O	Yes No
I3CR12	Alternative protocol class	13.3.4 h)	O	Yes No
I3CR13	Throughput	13.3.4 j)	O	Yes No
I3CR14	Residual error rate	13.3.4 k)	O	Yes No
I3CR15	Priority	13.3.4 l)	O	Yes No
I3CR16	Transit delay	13.3.4 m)	O	Yes No
I3CR17	Reassignment time	13.3.4 n)	O	Yes No
I3CR18	Preferred maximum TPDU size	13.3.4 c)	O	Yes No

The following parameters are optional if a CC-TPDU is issued in class 3.

Index	Supported parameters	References	Status	Support
I3CC6	Responding Transport-Selector	13.4.4	O	Yes No
I3CC7	Calling Transport-Selector	13.4.4	O	Yes No
I3CC8	TPDU size	13.4.4	O	Yes No
I3CC9	Protection parameters	13.4.4	O	Yes No
I3CC10	Additional option selection	13.4.4	O	Yes No
I3CC11	Throughput	13.4.4	O	Yes No
I3CC12	Residual error rate	13.4.4	O	Yes No
I3CC13	Priority	13.4.4	O	Yes No
I3CC14	Transit delay	13.4.4	O	Yes No
I3CC15	Preferred maximum TPDU size	13.4.4	O	Yes No

ISO/IEC 8073 : 1997 (E)

The following parameter is optional if a DR-TPDU is issued in class 3.

Index	Supported parameters	References	Status	Support
I3DR4	Additional information	13.5.4 a)	O	Yes No

The following parameter is optional if an ER-TPDU is issued in class 3.

Index	Supported parameters	References	Status	Support
I3ER3	Invalid TPDU	13.12.4 a)	O	Yes No

The following parameter is mandatory in a DT-TPDU if request of acknowledgement has been selected.

Index	Supported parameter	References	Status	Support
I3DT4	ROA	13.7.3 a)	M	Yes No

C.11.7 Supported parameters for class 4 TPDU (C4 OR C4L::)

The following parameters are optional if a CR-TPDU is issued with preferred class 4.

Index	Supported parameters	References	Status	Support
I4CR7	Called Transport-Selector	13.3.4 a)	O	Yes No
I4CR8	Calling Transport-Selector	13.3.4 a)	O	Yes No
I4CR9	TPDU size	13.3.4 b)	O	Yes No
I4CR10	Version number	13.3.4 d)	O	Yes No
I4CR11	Protection parameters	13.3.4 e)	O	Yes No
I4CR12	Additional option selection	13.3.4 g)	O	Yes No
I4CR13	Throughput	13.3.4 j)	O	Yes No
I4CR14	Residual error rate	13.3.4 k)	O	Yes No
I4CR15	Priority	13.3.4 l)	O	Yes No
I4CR16	Transit delay	13.3.4 m)	O	Yes No
I4CR17	Acknowledge time	13.3.4 i)	O	Yes No
I4CR18	Preferred maximum TPDU size	13.3.4 c)	O	Yes No
I4CR19	Inactivity time	13.3.4 o)	O	Yes No

The following parameters are optional if a CR-TPDU is issued with preferred class 4 over CONS.

Index	Supported parameters	References	Status	Support
I4CR20	Alternative protocol class	13.3.4 h)	O	Yes No

The following parameters are optional if a CC-TPDU is issued in class 4.

Index	Supported parameters	References	Status	Support
I4CC6	Called Transport-Selector	13.4.4	O	Yes No
I4CC7	Responding Transport-Selector	13.4.4	O	Yes No
I4CC8	TPDU size	13.4.4	O	Yes No
I4CC9	Protection parameters	13.4.4	O	Yes No
I4CC10	Additional option selection	13.4.4	O	Yes No
I4CC11	Acknowledge time	13.4.4	O	Yes No
I4CC12	Throughput	13.4.4	O	Yes No
I4CC13	Residual error rate	13.4.4	O	Yes No
I4CC14	Priority	13.4.4	O	Yes No
I4CC15	Transit delay	13.4.4	O	Yes No
I4CC16	Preferred maximum TPDU size	13.4.4	O	Yes No
I4CC17	Inactivity time	13.4.4	O	Yes No

The following parameter is optional if a DR-TPDU is issued in class 4.

Index	Supported parameters	References	Status	Support
I4DR4	Additional information	13.5.4 a)	O	Yes No

The following parameter is mandatory in a DT-TPDU if request of acknowledgement has been selected.

Index	Supported parameters	References	Status	Support
I4DT4	ROA	13.7.3 a)	M	Yes No

The following parameter is mandatory in an AK-TPDU if issued in class 4.

Index	Supported parameters	References	Status	Support
I4AK4	Flow control confirmation	13.9.4 c)	O	Yes No

If the implementation can reduce credit and does so in the manner outlined in 12.2.3.8.2, then subsequence number in AK-TPDUs is mandatory. Otherwise complete item I4AK5.

Index	Supported parameters	References	Status	Support
I4AK5	Subsequence number	13.9.4 b)	O	Yes No
I4AK6	Selective acknowledgement parameters	13.9.4 d)	O	Yes No

ISO/IEC 8073 : 1997 (E)

The following parameter is optional if an ER-TPDU is issued in class 4.

Index	Supported parameters	References	Status	Support
I4ER3	Invalid TPDU	13.12.4 a)	O	Yes No

C.12 Supported parameters for received TPDU

Implementors should be aware that implementations shall be capable of receiving and processing all possible parameters for all possible TPDU, dependent upon the class and optional functions implemented.

C.12.1 Supported parameters for NCMS (A1::)

C.12.1.2 NCM-TPDU (SN4::)

What are the allowed receive values of the following parameters for an NCM-TPDU?

Index	Supported parameters	References	Allowed values	Supported values
RN1	NC-type	B.8.3.3 c)	New, My, Yours	
RN2	NC-preference	B.8.3.3 d)	Highest, Medium, Lowest	
RN3	NC-collision	B.8.3.3 e)	Resolution	
RN4	NC-recovery	B.8.3.3 f)	Do not, Do	
RN5	NC-assignment right	B.8.3.3 g)	Receiver, Sender, All	

C.12.2 TPDU in class 4 (C4 OR C4L::)

If use of checksum has been selected, then it is mandatory to process a checksum parameter in the following TPDU.

Index	TPDU	References	Status	Support
R4CCch	CC-TPDU	13.4.4	M	Yes
R4DRch	DR-TPDU	13.5.4 b)	M	Yes
R4DCch	DC-TPDU	13.6.4	M	Yes
R4DTch	DT-TPDU	13.7.4	M	Yes
R4EDch	ED-TPDU	13.8.4	M	Yes
R4Akch	AK-TPDU	13.9.4 a)	M	Yes
R4EAch	EA-TPDU	13.10.4	M	Yes
R4ERch	ER-TPDU	13.12.4 b)	M	Yes

C.13 User data in issued TPDU

A TS-user may issue data with a T-CONNECT request, T-CONNECT response or T-DISCONNECT request. Then it shall be possible to send user data as follows.

C.13.1 Class 1 (C1::)

Index	User data	References	Status	Support
D1ICR	User data of up to 32 octets in a CR with preferred class 1	13.3.5	M	Yes
D1ICC	User data of up to 32 octets in a CC	13.4.5	M	Yes
D1IDR	User data of up to 64 octets in a DR	13.5.5	M	Yes

C.13.2 Class 2 (C2::)

Index	User data	References	Status	Support
D2ICR	User data of up to 32 octets in a CR with preferred class 2	13.3.5	M	Yes
D2ICC	User data of up to 32 octets in a CC	13.4.5	M	Yes
D2IDR	User data of up to 64 octets in a DR	13.5.5	M	Yes

C.13.3 Class 3 (C3::)

Index	User data	References	Status	Support
D3ICR	User data of up to 32 octets in a CR with preferred class 3	13.3.5	M	Yes
D3ICC	User data of up to 32 octets in a CC	13.4.5	M	Yes
D3IDR	User data of up to 64 octets in a DR	13.5.5	M	Yes

C.13.4 Class 4 (C4 or C4L::)

Index	User data	References	Status	Support
D4ICR	User data of up to 32 octets in a CR with preferred class 4	13.3.5	M	Yes
D4ICC	User data of up to 32 octets in a CC	13.4.5	M	Yes
D4IDR	User data of up to 64 octets in a DR	13.5.5	M	Yes

C.14 User data in received TPDUs

For classes 1 to 4, if it is possible to initiate a CR-TPDU, then it shall be possible to receive the following:

Index	User data	References
DRCC	32 octets of user data in a CC-TPDU	13.4.5
DRDR	64 octets of user data in a DR-TPDU	13.5.5

For classes 1 to 4, if it is possible to respond to a CR-TPDU, then it shall be possible to receive the following:

Index	User data	References
DRCR	32 octets of user data in a CR-TPDU	13.3.5

C.15 Negotiation

C.15.1 Class negotiation – Initiator (C4::)

If it is possible to initiate a CR-TPDU in a particular class, then the following holds.

Index		References
NC	The preferred class in the CR-TPDU may contain any of the classes supported by the implementation	6.5.4 h)

What class(es) is (are) contained in the alternative class parameter if the preferred class is:

Index	Preferred class	References	Allowed values	Supported values
NAC1	Class 1	6.5.4 j)	None, 0, 1	
NAC2	Class 2	6.5.4 j)	None, 0, 2	
NAC3	Class 3	6.5.4 j)	None, 0, 1, 2, 3	
NAC4	Class 4	6.5.4 j)	None, 0, 1, 2, 3, 4	

C.15.2 Class negotiation – Initiator (C4L::)

If it is possible to initiate a CR-TPDU, then the following holds.

Index	Preferred class	References	Allowed values	Supported values
NAC5	The preferred class is 4 and an alternative class shall not be present	6.5.5 j)	None	

C.15.3 Class negotiation – Responder (C4::)

Index	Preferred class	References	Allowed response	Supported response
RC0	What classes can you respond with if CR proposes only class 0?	6.5.4 h) Table 3	0 or connection refused depending on classes supported	
RC1	What classes can you respond with if CR proposes only class 1?	6.5.4 h) Table 3	0, 1 or connection refused depending on classes supported	
RC1a	What classes can you respond with if CR proposes class 1 as preferred class and the alternative class parameter is present?	6.5.4 h) Table 3	0, 1 or connection refused depending on classes supported	
RC2	What classes can you respond with if CR proposes only class 2?	6.5.4 h) Table 3	2 or connection refused depending on classes supported	
RC2a	What classes can you respond with if CR proposes class 2 as preferred class and the alternative class parameter is present?	6.5.4 h) Table 3	0, 2 or connection refused depending on classes supported and coding of alternative class	
RC3	What classes can you respond with if CR proposes only class 3?	6.5.4 h) Table 3	2, 3 or connection refused depending on classes supported	
RC3a	What classes can you respond with if CR proposes class 3 as preferred class and the alternative class parameter is present?	6.5.4 h) Table 3	0, 1, 2, 3 or connection refused depending on classes supported and coding of alternative class	
RC4	What classes can you respond with if CR proposes only class 4?	6.5.4 h) Table 3	2, 4 or connection refused depending on classes supported	
RC4a	What classes can you respond with if CR proposes class 4 as preferred class and the alternative class parameter is present?	6.5.4 h) Table 3	0, 1, 2, 3, 4 or connection refused depending on classes supported and coding of alternative class	

C.15.4 TPDU size negotiation

Index		References	Status	Support
TS1	If maximum TPDU size is proposed in a CR-TPDU, then the initiator shall support all TPDU sizes from 128 octets to the maximum proposed.	14.5	M	Yes
TS2	If the preferred maximum TPDU size parameter is used in a CR-TPDU, then the initiator shall support all TPDU sizes, except 0, that are multiples of 128 octets up to the preferred maximum proposed.	14.5 e)	I4CR18:M	Yes No

Index	TPDU size	References	Allowed values	Supported values
T0S1	What is the largest value of the maximum TPDU size parameter in a CR-TPDU with preferred class 0?	14.5 e)	NOT I0CR9: One of 128, 256, 512, 1024, 2048 I0CR9: One of $n \times 28$ with $n = 1, 2, 3, \dots$	
T0S2	What is the largest value of the maximum TPDU size parameter which may be sent in a CC-TPDU when class 0 is selected?	14.5 e)	NOT I0CC9: One of 128, 256, 512, 1024, 2048 I0CC9: One of $n \times 128$ with $n = 1, 2, 3, \dots$	
T1S1	What is the largest value of the maximum TPDU size parameter in a CR-TPDU with preferred class 1?	14.5 e)	NOT I1CR18: One of 128, 256, 512, 1024, 2048, 4096, 8192 I1CR18: One of $n \times 128$ with $n = 1, 2, 3, \dots$	

Index	TPDU size	References	Allowed values	Supported values
T1S2	What is the largest value of the maximum TPDU size parameter which may be sent in a CC-TPDU when class 1 is selected?	14.5 e)	NOT I1CC15: One of 128, 256, 512, 1024, 2048, 4096, 8192 I1CC15: One of $n \times 128$ with $n = 1, 2, 3, \dots$	
T2S1	What is the largest value of the maximum TPDU size parameter in a CR-TPDU with preferred class 2?	14.5 e)	NOT I2CR17: One of 128, 256, 512, 1024, 2048, 4096, 8192 I2CR17: One of $n \times 128$ with $n = 1, 2, 3, \dots$	
T2S2	What is the largest value of the maximum TPDU size parameter which may be sent in a CC-TPDU when class 2 is selected?	14.5 e)	NOT I2CC15: One of 128, 256, 512, 1024, 2048, 4096, 8192 I2CC15: One of $n \times 128$ with $n = 1, 2, 3, \dots$	
T3S1	What is the largest value of the maximum TPDU size parameter in a CR-TPDU with preferred class 3?	14.5 e)	NOT I3CR18: One of 128, 256, 512, 1024, 2048, 4096, 8192 I3CR18: One of $n \times 128$ with $n = 1, 2, 3, \dots$	
T3S2	What is the largest value of the maximum TPDU size parameter which may be sent in a CC-TPDU when class 3 is selected?	14.5 e)	NOT I3CC15: One of 128, 256, 512, 1024, 2048, 4096, 8192 I3CC15: One of $n \times 128$ with $n = 1, 2, 3, \dots$	

Index	TPDU size	References	Allowed values	Supported values
T4S1	What is the largest value of the maximum TPDU size parameter in a CR-TPDU with preferred class 4?	14.5 e)	NOT I4CR18: One of 128, 256, 512, 1024, 2048, 4096, 8192 I4CR18: One of $n \times 128$ with $n = 1, 2, 3, \dots$	
T4S2	What is the largest value of the maximum TPDU size parameter which may be sent in a CC-TPDU when class 4 is selected?	14.5 e)	NOT I4CC16: One of 128, 256, 512, 1024, 2048, 4096, 8192 I4CC16: One of $n \times 128$ with $n = 1, 2, 3, \dots$	

C.15.5 Use of extended format

Index	Extended format	References	Allowed values	Supported values
NEF1	What formats can you propose in the CR-TPDU in class 2?	6.5.4 l)	normal, extended	
NEF2	What formats can you propose in the CR-TPDU in class 3?	6.5.4 l)	normal, extended	
NEF3	What formats can you propose in the CR-TPDU in class 4?	6.5.4 l) 6.5.5 l)	normal, extended	
NEF4	What formats can you select in CC when extended has been proposed in CR in class 2?	6.5.4 l)	normal, extended	
NEF5	What formats can you select in CC when extended has been proposed in CR in class 3?	6.5.4 l)	normal, extended	
NEF6	What formats can you select in CC when extended has been proposed in CR in class 4?	6.5.4 l) 6.5.5 l)	normal, extended	

C.15.6 Expedited data transport service

Index		References	Status	Support
TED1	Expedited data indication in CR and CC-TPDU	6.5.4 g) 6.5.5 o)	M	Yes

C.15.7 Non-use of checksum ((C4 OR C4L) AND T4F29::)

Index	Non-use of checksum	References	Allowed values	Supported values
NUC1	What proposals can you make in the CR?	6.5.4 m) 6.5.5 m)	non-use, use	
NUC2	What proposals can you make in CC when non-use of checksum has been proposed in CR?	6.5.4 m) 6.5.5 m)	non-use, use	

C.15.8 Explicit flow control (C2 and T2F19::)

Index	Explicit flow control	References	Allowed values	Supported values
NUF1	What proposals can you make in CR?	6.5.4 o)	non-use, use	
NUF2	What proposals can you make in CC when non-use of explicit flow control has been proposed in CR?	6.5.4 o)	non-use, use	

C.15.9 Use of network receipt confirmation (C1 and T1F21::)

Index	Network receipt confirmation	References	Allowed values	Supported values
UNRC1	What proposals can you make in CR?	6.5.4 p)	non-use, use	
UNRC2	What proposals can you make in CC when use of network receipt confirmation has been proposed in CR?	6.5.4 p)	non-use, use	

C.15.10 Use of network expedited data (C1 and T1F20::)

Index	Network expedited data	References	Allowed values	Supported values
UNED1	What proposals can you make in CR?	6.5.4 p)	non-use, use	
UNED2	What proposals can you make in CC when use of network expedited data has been proposed in CR?	6.5.4 p)	non-use, use	

C.15.11 Use of selective acknowledgement

Index	Selective acknowledgement	References	Allowed values	Supported values
USA1	Is use of selective acknowledgement proposed in CR-TPDUs?	6.5.4 r) 6.5.5 q)	Yes, No	
USA2	Is use of selective acknowledgement selected in a CC when it has been proposed in a CR?	6.5.4 r) 6.5.5 q)	Yes, No	

C.15.12 Use of request of acknowledgement

Index	Request of acknowledgement	References	Allowed values	Supported values
ROA1	Is use of request of acknowledgement proposed in CR-TPDUs?	6.5.4 s) 6.5.5 g)	Yes, No	
ROA2	Is use of request of acknowledgement selected in a CC when it has been proposed in a CR?	6.5.4 s) 6.5.5 g)	Yes, No	

C.15.13 Use of Non-Blocking Expedited Data Service

Index	Non-blocking expedited data	References	Allowed values	Supported values
NBE1	Is use of non-blocking expedited data proposed in CR-TPDUs?	6.5.4 t) 6.5.5 p)	Yes, No	
NBE2	Is use of non-blocking expedited data selected in a CC when it has been proposed in a CR?	6.5.4 t) 6.5.5 p)	Yes, No	

C.16 Error handling

C.16.1 Action on receipt of a protocol error

Index	Items	References	Allowed values	Supported values
PE0	Class 0	6.22.1.3	C0: ER, NDISreq, NRSTreq, Discard	
PE1	Class 1	6.22.1.3	C1: ER, DR, NDISreq, NRSTreq, Discard	
PE2	Class 2	6.22.1.3	C2: ER, DR, NDISreq, NRSTreq, Discard	
PE3	Class 3	6.22.1.3	C3: ER, DR, NDISreq, NRSTreq, Discard	
PE4	Class 4 over CONS	6.22.1.3	C4: ER, DR, NDISreq, NRSTreq, Discard	
PE4L	Class 4 over CLNS	6.22.2.3	C4L: ER, DR, Discard	

C.16.2 Actions on receipt of an invalid or undefined parameter in a CR-TPDU

Index	Events	References	Status	Support
RR1	A parameter not defined in ITU-T Rec. X.224 ISO/IEC 8073 shall be ignored.	13.2.3	M	Yes
RR2	An invalid value in the alternative protocol class parameter shall be treated as a protocol error.	13.2.3	C4:M	Yes
RR3	An invalid value in the class and option parameter shall be treated as a protocol error.	13.2.3	M	Yes
RR4	On receipt of the additional option selection parameter bits 8 to 5, and bits 4 to 1 if not meaningful for the proposed class shall be ignored.	13.3.4	M	Yes
RR5	If non-use of explicit flow control is proposed and bit 1 of the additional option selection parameter equals 1, it shall be treated as a protocol error.	13.2.3	M	Yes
RR6	On receipt of the class and option parameter bits 4 to 1 if not meaningful for the proposed class shall be ignored.	13.3.3	M	Yes

What action is supported on receipt of the following?

Index	Events	References	Allowed actions	Supported actions
RR7	A parameter defined in ITU-T Rec. X.224 ISO/IEC 8073 (other than those covered above) and have an invalid value	13.2.3	Ignore, protocol error	
RR8	The alternative class parameter is present	6.5.5	C4L: Ignore, Protocol error	

C.16.3 Actions on receipt of an invalid or undefined parameter in a TPDU other than a CR-TPDU

The following actions are mandatory.

Index	Events	References	Status	Support
UI1	A parameter not defined in ITU-T Rec. X.224 ISO/IEC 8073 shall be treated as a protocol error.	13.2.3	M	Yes
UI2	A parameter which has an invalid value as defined in ITU-T Rec. X.224 ISO/IEC 8073 shall be treated as a protocol error.	13.2.3	M	Yes
UI3 (class 4 only)	A TPDU received with a checksum which does not satisfy the defined formula shall be discarded.	6.17.3	M	Yes

C.17 Timers and protocol parameters

The following are mandatory if class 4 is supported.

Index		References	Status	Support
TA1	<i>TI</i>	12.2.1	M	Yes
TA2	<i>N</i>	12.2.1	M	Yes
TA3	<i>I_L</i>	12.2.1	M	Yes
TA4	<i>W</i>	12.2.1	M	Yes
TA5	<i>L</i>	12.2.1	M	Yes

Index		References	Status	Support
OT1	Does IUT support optional timer <i>TS1</i> when operating in class 0?	6.5.4	O	Yes No
OT2	Does IUT support optional timer <i>TS1</i> when operating in class 1?	6.5.4	O	Yes No
OT3	Does IUT support optional timer <i>TS1</i> when operating in class 2?	6.5.4	O	Yes No
OT4	Does IUT support optional timer <i>TS1</i> when operating in class 3?	6.5.4	O	Yes No
OT5	Does IUT support optional timer <i>TS2</i> when operating in class 0?	6.7.1.5	O	Yes No
OT6	Does IUT support optional timer <i>TS2</i> when operating in class 1?	6.7.1.5	O	Yes No
OT7	Does IUT support optional timer <i>TS2</i> when operating in class 2?	6.7.1.5	O	Yes No
OT8	Does IUT support optional timer <i>TS2</i> when operating in class 3?	6.7.1.5	O	Yes No
OT9	Does IUT support optional timer <i>TS2</i> when operating in class 4?	6.22.1.3 6.22.2.3	O	Yes No

The following are mandatory if class 1 or 3 is supported.

Index		References	Status	Support
TA6	<i>TTR</i>	6.12.3 6.12.4	M	Yes
TA7	<i>TWR</i>	6.12.3 6.12.4	M	Yes

Annex D

Checksum Algorithms

(This annex forms an integral part of this Recommendation | International Standard)

D.1 Symbols

The following symbols are used:

$C0, C1$	Variables used in the algorithms
i	is the number (i.e. position) of an octet within the TPDU (see 12.1);
n	is the number (i.e. position) of the first octet of the checksum parameter;
L	is the length of the complete TPDU;
X	is the value of the first octet of the checksum parameter;
Y	is the value of the second octet of the checksum parameter.

D.2 Arithmetic conventions

Addition is performed in one of the two following modes:

- modulo 255 arithmetic;
- one complement arithmetic in which if any of the variables has the value minus zero (i.e. 255), it shall be regarded as though it was plus zero (i.e. 0).

D.3 Algorithm for generating checksum parameters

D.3.1 Set up the complete TPDU with the value of the checksum parameter field set to zero.

D.3.2 Initialize $C0$ and $C1$ to zero.

D.3.3 Process each octet sequentially from $i = 1$ to L by:

- adding the value of the octet to $C0$; then
- adding the value of $C0$ to $C1$.

D.3.4 Calculate X and Y such that:

$$X = -C1 + (L - n) C0$$

$$Y = C1 - (L - n + 1) C0$$

D.3.5 Place the values X and Y in octets n and $(n + 1)$ respectively.

NOTE –This algorithm calculates:

$$C1 = \sum_{i=1}^L (L - i + 1) a_i$$

which is equal to zero, if the formulae in 6.17.3 are followed, since:

$$C1 = \sum_{i=1}^L (L - i + 1) a_i = (L + 1) \sum_{i=1}^L a_i - \sum_{i=1}^L i a_i = 0$$

D.4 Algorithm for checking checksum parameters

D.4.1 Initialize *CO* and *CI* to zero.

D.4.2 Process each octet of the TPDU sequentially from $i = 1$ to L by:

- a) adding the value of the octet to *CO*; then
- b) adding the value of *CO* to *CI*.

D.4.3 If, when all the octets have been processed, one or both of the parameters *CO* and *CI* do not have the value zero, the checksum formulae in 6.17 have not been satisfied.

NOTE – The nature of the algorithm is such that it is not necessary to compare explicitly the stored checksum bytes.

Annex E

State tables for operation of class 4 over connection-mode and connectionless-mode network services

(This annex forms an integral part of this Recommendation | International Standard)

E.1 General

This annex has been included as a guide for implementations which have been designed for operation over both the connection-mode network service and the connectionless-mode network service.

The introductory comments given in Annex A apply in this annex as well.

E.2 Conventions

Subclause A.2 applies in this annex, except for item b) of A.2.3 in which the term "network connection" is to be extended to apply as well to the corresponding instance of communication over a connectionless-mode network service.

E.3 Tables

Subclause A.3, including Tables A.1, A.2, A.3, apply in this annex.

E.4 State tables for class 4

This subclause incorporates all of A.6 with extensions to cover operation over connectionless-mode network services.

This subclause provides a more precise description of a class 4 transport connection.

Tables E.1, E.2, E.3 give the predicates, actions and notes for class 4 respectively.

Table E.4 is the state table for a class 4 transport connection.

The following assumption and notations are used:

- * Appropriate only for operation over connection-mode network service
- ** Appropriate only for operation over connectionless-mode network service:
 - a)* The state of every network connection is known as being open or opening (i.e. an NCONreq has been issued and the NCONconf is awaited).
 - b)* For each transport connection the transport entity maintains the set of network connections to which the transport connection is assigned. A network connection in this set is either in the OPEN or OPENING states.
 - c)* When an N-CONNECT confirmation, N-RESET indication or N-DISCONNECT indication is received, this event is associated with the transport connection if the network connection belongs to the set.
 - d)* When an N-DISCONNECT is received, the network connection ceases to exist and is therefore withdrawn from the set. When an NCONconf is received the state of the NC becomes "OPEN".
NOTE – This is not shown by an explicit action in the state table. Conversely adding a network connection to a set and setting its state to "OPENING" is shown by an explicit action.
 - e)* When the state goes back to CLOSED or REFWAIT state, it is assumed that all timers are stopped (if running), the count is set to zero and the set becomes empty.
 - f)* When a PDU is received, the network connection on which it has been received is assumed to be known.
 - g)* The variable "current-NC" is used to designate either the network connection on which a TPDU has been received or the network connection which has been chosen for a new assignment (either an existing one or a new one which is created).

- h) We also assume the following variables:
 - local-ref – The reference (local) of the TC is chosen when sending the CR or when accepting a CR.
 - remote-ref – The reference of the remote entity is initially set to zero and initialised when processing the CC except if the CC is ignored.
 - SRC-REF – Designates the corresponding field of the received TPDU.
 - DST-REF – Designates the corresponding field of the received TPDU.
 - src-ref, dst-ref – Designates the corresponding fields of the sent TPDU.
 - count – Designates the numbers of times a TPDU has been sent (retransmissions).
- i) The data transfer phase is not completely described in the state table but refers to the main text.
- j)* A spontaneous event called “new network connection assignment” has been introduced. It may occur at any time provided P1 or P2 are true (see predicate Table E.1) and the remote-ref is not zero (i.e. a CR-TPDU has been received or a CC-TPDU has been received and processed);
- k)* When an N-RESET indication is received, an N-RESET response is issued.
- l)** It is assumed that the connectionless-mode network service when being used is continuously available. The operations resulting from signalled inaccessibility of the network are a local matter.

Table E.1 – Predicates for class 4

Name	Description
P0	T-CONNECT request is acceptable
P1	An assignment can be done to a suitable network connection (either open or opening)
P2	It is possible to open a new network connection
P3	Local choice
P4	A CR-TPDU has never been sent
P5	The transport entity is the initiator and the set of network connections is now empty (i.e. a new assignment shall be done) or a new assignment is decided as a local choice
P6	Local choice not to perform a new assignment if the set of network connections is empty (for CLOSING state only)
P7	Count = maximum
P8	Acceptable CR-TPDU
P9	Acceptable class 4 CC-TPDU
P10	Unacceptable class 4 CC-TPDU
P11	CC-TPDU not specifying class 4
P99	Connection-mode network service being used
NOTE – It is assumed that P99 = false implies only that the connectionless-mode network service is being used.	

Table E.2 – Specific actions for class 4

Name	Description
[0]	Set reference timer
[1]	Count = count + 1
[2]	Count = 0
[3]	Set retransmission timer
[4]	Stop retransmission timer if running
[5]	Set window timer
[6]	Stop window timer if running
[7]	Set inactivity timer
[8]	Stop inactivity timer if running
[9]	Set initial credit for sending according to the received CR/CC-TPDU
[10]	Set initial credit for controlling reception according to the sent CR/CC-TPDU
[11]	P99: Send the CR-TPDU if there is a network connection in the OPEN state in the set; not P99: send a CR-TPDU
[12]	P99: Add the current network connection to the set, if not already included; not P99: no action
[13]	P99: The current network connection is now in the OPENING state; not P99: no action
[14]	P99: Send the CC-TPDU if a network connection in the OPEN state is in the set; not P99: send CC-TPDU
[15]	P99: Send the DR-TPDU if a network connection in the OPEN state is in the set; not P99: send DR-TPDU. In both cases, this DR-TPDU is sent with src-ref = local-ref and dst-ref = remote-ref (may be zero)
[16]	P99: Send the DR-TPDU if a network connection in the OPEN state is in the set; not P99: send the DR-TPDU. In both cases, the DR-TPDU is sent with src-ref = 0 and dst-ref = remote-ref
[17]	Send a TPDU according to data transfer procedure
[18]	See state table of the class specified in the CC-TPDU (refer to data transfer)
[19]	P99: See state table of the class (refer to release procedure), send a DR-TPDU if the class is not 0, otherwise issue a N-DISCONNECT request; not P99: send a DR-TPDU
[20]	Store request and exercise flow control to the user
[21]	Send a DR-TPDU with src-ref field set to zero
[22]	Send a DC-TPDU except if the SRC-REF field of the received DR-TPDU is equal to zero
[23]	P99: Send a DR-TPDU with src-ref = local-ref and dst-ref = remote-ref (may be zero) if a network connection in the OPEN state is in the set; not P99: send a DR-TPDU with src-ref = local-ref and dst-ref = SRC-REF in CC-TPDU

Table E.3 – Specific notes for class 4

Name	Description
(1)*	Not possible as no set of network connections is associated with this transport connection
(2)*	It is also possible to remain in the same state (T1 is still running) until: <ul style="list-style-type: none"> • a CC-TPDU is received which performs a new assignment; • a new assignment is tried (spontaneous event); • T1 runs out and the count is equal to the maximal value
(3)*	No new assignment was possible: if the set is empty, the transport entity waits until a new assignment is received, or can be locally performed (spontaneous event)
(4)*	It is also possible to perform a new assignment. (This may be done in triggering the event “new network connection assignment”)
(5)	Not a duplicated CR-TPDU
(6)*	Since a new network connection is now assigned, it is recommended that the appropriate TPDU be sent on this network connection (if open) in order to make the remote entity aware of this assignment. It is also possible to allow the normal retransmission procedures to cause the TPDU to be sent; however the first TPDU available for sending should be sent on the new network connection
(7)	As a local choice it is also possible to apply the following: [0], TDISind, REFWAIT
(8)	Association to this transport connection is done regardless of the SRC-REF field. If SRC-REF is not zero, a DC-TPDU is set back
(9)	At least an AK-TPDU shall be sent if the transport entity is the initiator in order to ensure that the responder will complete its three-way handshake
(10)	If association has been made, and DST-REF is zero, then the DC-TPDU contains a src-ref field set to zero
(11)	If the CLOSING state has been entered, coming from WFCC state, the remote-ref is zero. The SRC-REF field of the CC-TPDU is ignored (i.e. if the DR-TPDU is retransmitted, it will be with the dst-ref field set to zero)
(12)*	If the CLOSING state has been entered, coming from WFCC state, the remote-ref (which is zero) shall be set with SRC-REF in order to comply with the release procedure of the negotiated class
(13)	The DR-TPDU may be either repeated immediately or when T1 will run out
(14)*	If the set is empty, this event may be used as a criteria for triggering the event “new network connection assignment”
(15)	Previously stored T-DATA or T-EXPEDITED-DATA requests are ready for processing according to data transfer procedures
(16)	See data transfer procedures
(17)*	When an N-RESET indication is received, an N-RESET response has to be issued at once independent of the state automata
* Appropriate only when operating over connection-mode network service.	

Table E.4 – Class 4 connection/disconnection

State								
EVENT	REFWAIT	CLOSED	WFCC	WBCL	OPEN	WFTRESP	AKWAIT	CLOSING
TCONreq		Not P0: TDisind CLOSED; P0 and [(P1 and P99) or not P99]: [12,1,3,10,11] WFCC; P99 and P0 and not P1 and P2: [3,12,1,3,10] NCONreq WFCC; P99 and P0 and (not P1) and not P2: TDisind CLOSED						
TCONresp						[3,2,1,10,14] AKWAIT		
TDisreq			P4: CLOSED; (not P4) and P3: WBCL; (not P4) and (not P3): [4,3,2,1,15] CLOSING		[6,8,4,3,2,1,15] CLOSING	[16] CLOSED	[4,3,2,1,15] CLOSING	

Table E.4 (continued) – Class 4 connection/disconnection

State								
EVENT	REFWAIT	CLOSED	WFCC	WBCL	OPEN	WFTRESP	AKWAIT	CLOSING
NDISind	(1)	(1)	P99 and P1: [12] WFCC; P99 and (not P1) and P2: [13,12] NCONreq WFCC; P99 and (not P1) and (not P2): [0] [2] TDISind REFWAIT	P99 and P3: [0] REFWAIT; P99 and (not P3) and P1: [12,11] WBCL; P99 and (not P3) and (not P1) and P2: [13,12] NCONreq WBCL; P99 and (not P3) and (not P1) and (not P2): [0] REFWAIT	P99 and P5 and P1: [12,17] (6) OPEN; P99 and (not P1) and P5 and P2: [13,12] NCONreq OPEN; P99 and (not P1) and P5 and (not P2): OPEN (3); P99 and (not P5): OPEN	P99: WFTRESP (4)	P99 and P5 and P1: [12,14] (6) AKWAIT; P99 and (not P1) and P5 and P2: [13,12] NCONreq AKWAIT; P99 and (not P1) and P5 and (not P2): AKWAIT (3) P99 and (not P5): AKWAIT	P99 and P6: [0] REFWEAIT; P99 and (not P6) and P5 and P1: [12,15] CLOSING (6) P99 and (not P6) and P5 and (not P1) and P2: [13,12] NCONreq CLOSING; P99 and (not P6) and P5 and (not P1) and (not P2): CLOSING (3); P99 and (not P6) and (not P5): CLOSING
NRSTind			(17)	(17)	(17)	(17)	(17)	(17)
TDTreq TEXreq					(16) OPEN		[20] AKWAIT	
NCONconf	(1)	(1)	P99: CR WFCC (6)	P99: CR WBCL (6)	P99: [17] OPEN (6)	P99: WFTRESP	P99: CC AKWAIT (6)	P99: [15] CLOSING (6)
New Network Connection Assignment					P99 and P1: [12,17] OPEN (6); P99 and P2 and (not P1): [13,12] NCONreq OPEN	P99 and P1: [12] WFTRESP; P99 and P2 and (not P1): [13, 12] NCONreq WFTRESP	P99 and P1: [12,14] (6) AKWAIT; P99 and P2 and (not P1): [13,12] NCONreq AKWAIT	P99 and P1: [12,15] (6) CLOSING; P99 and P2 and (not P1): [13,12] NCONreq CLOSING

Table E.4 (continued) – Class 4 connection/disconnection

State								
EVENT	REFWAIT	CLOSED	WFCC	WBCL	OPEN	WFTRESP	AKWAIT	CLOSING
Retrans-timer			P7 and P3: [0] TDISind REFWAIT; P7 and (not P3): [3,2,1,15] TDisind CLOSING (14); not P7: [1,3,11] WFCC	P7 and P3: [0] REFWAIT; P7 and (not P3): [3,2,1,15] CLOSING (14); not P7: [1,3,11] WBCL	P7: [6,8,3,2,1,15] TDisind CLOSING (14); not P7: (16) (14) OPEN		P7: [3,2,1,15] TDisind (14) CLOSING; not P7: [1,3,14] (14) AKWAIT	P7: [0] REFWAIT; not P7: [1,3,15] (14) CLOSING
Inactivity-Timer					[6,4,3,2,1,15] TDisind CLOSING (7)			
Reference-Time	CLOSED							
CR		Not P8: [21] CLOSED (5); P8: [9,12] TCONind WFTRESP (5)			[12,8,7] OPEN	[12] WFTRESP	[12,14] AKWAIT	[12] CLOSING (13)
CC	DR-REFWAIT	DR-CLOSED	P9: [12,9,2,4,5, 7,17] TCONconf (9) OPEN; (not P9 and not P99) or (P99 and P10): [12,4,3,2,1,23] TDisind CLOSING; P99 and P11: [18]	P99 and P11: [19]; (not P99 and P9) or (P99 and not P11): [12,2,4,3, 1,15] CLOSING	[12,17,8,7] (9) OPEN			(P99 and P11): [19] (12); (not P99 and P9) or (P99 and not P11): [12] CLOSING (11)
ER	REFWAIT	CLOSED	[0] TDisind REFWAIT	[0] REFWAIT	[12,6,8,4,3,2,1,15] TDisind CLOSING		[12,4,3,2,1, 15] TDisind CLOSING	[0] REFWAIT

Table E.4 (end) – Class 4 connection/disconnection

State								
EVENT	REFWAIT	CLOSED	WFCC	WBCL	OPEN	WFTRESP	AKWAIT	CLOSING
DR	[22] REFWAIT	[22] CLOSED	(8) TDISind [0] REFWAIT	(8) [0] REFWAIT	DC (10) [0] TDISind REFWAIT	DC (10) TDISind CLOSED	DC (10) [0] TDISind REFWAIT	[0] REFWAIT
DC	REFWAIT	CLOSED						[0] REFWAIT
EA	REFWAIT	CLOSED			[12,8,7] OPEN (16)			[12] CLOSING (13)
DT/AK/ED	REFWAIT	CLOSED			[12,8,7] OPEN (16)		[12,7] OPEN (15) (16)	[12] CLOSING (13)

Appendix I

Differences between ITU-T Rec. X.224 (1993) and ISO/IEC 8073:1992

ITU-T Rec. X.224 (1993) and ISO/IEC 8073:1992 are technically aligned except for the differences listed below.

I.1 Assignment to network connections

In 6.1.1.3 of Recommendation X.224, it is stated that the responder to the transport connection request becomes aware of the assignment when it receives particular TPDU. In subclause 6.1.1.3 of ISO/IEC 8073, it is the non-owner of the network connection that becomes aware of the assignment upon receipt of these same TPDU.

I.2 Conformance

Recommendation X.224, in clause 14, requires all systems to implement class 0. ISO/IEC 8073, in clause 14, requires all systems to implement either class 0 or class 2.

I.3 Class negotiation

An additional restriction regarding the classes of transport protocol that are proposed in a CR-TPDU is defined in item a) in 14.4 of Recommendation X.224. No such restriction is contained in 14.5 of ISO/IEC 8073.

I.4 Precedence

ISO/IEC 8073, in its Annex A (State table), includes the statement: "In the event of a discrepancy between the description in these tables and that contained in the text, the text takes precedence." Recommendation X.224 does not contain this statement.

I.5 Difference between ITU-T Rec. X.224 and ISO/IEC 8073

The material in this appendix is not present in ISO/IEC 8073.

ITU-T RECOMMENDATIONS SERIES

- Series A Organization of the work of the ITU-T
- Series B Means of expression
- Series C General telecommunication statistics
- Series D General tariff principles
- Series E Telephone network and ISDN
- Series F Non-telephone telecommunication services
- Series G Transmission systems and media
- Series H Transmission of non-telephone signals
- Series I Integrated services digital network
- Series J Transmission of sound-programme and television signals
- Series K Protection against interference
- Series L Construction, installation and protection of cables and other elements of outside plant
- Series M Maintenance: international transmission systems, telephone circuits, telegraphy, facsimile and leased circuits
- Series N Maintenance: international sound-programme and television transmission circuits
- Series O Specifications of measuring equipment
- Series P Telephone transmission quality
- Series Q Switching and signalling
- Series R Telegraph transmission
- Series S Telegraph services terminal equipment
- Series T Terminal equipments and protocols for telematic services
- Series U Telegraph switching
- Series V Data communication over the telephone network
- Series X Data networks and open system communication**
- Series Z Programming languages