

International Telecommunication Union

ITU-T

TELECOMMUNICATION
STANDARDIZATION SECTOR
OF ITU

Series Q
Supplement 60
(01/2010)

SERIES Q: SWITCHING AND SIGNALLING

**Supplement to Recommendations ITU-T Q.3610
and ITU-T Q.3611 – Service flows for customized
multimedia ring-back tone (CRBT) and
customized multimedia ringing tone (CRT)
services**

ITU-T Q-series Recommendations – Supplement 60



ITU-T Q-SERIES RECOMMENDATIONS

SWITCHING AND SIGNALLING

SIGNALLING IN THE INTERNATIONAL MANUAL SERVICE	Q.1–Q.3
INTERNATIONAL AUTOMATIC AND SEMI-AUTOMATIC WORKING	Q.4–Q.59
FUNCTIONS AND INFORMATION FLOWS FOR SERVICES IN THE ISDN	Q.60–Q.99
CLAUSES APPLICABLE TO ITU-T STANDARD SYSTEMS	Q.100–Q.119
SPECIFICATIONS OF SIGNALLING SYSTEMS No. 4, 5, 6, R1 AND R2	Q.120–Q.499
DIGITAL EXCHANGES	Q.500–Q.599
INTERWORKING OF SIGNALLING SYSTEMS	Q.600–Q.699
SPECIFICATIONS OF SIGNALLING SYSTEM No. 7	Q.700–Q.799
Q3 INTERFACE	Q.800–Q.849
DIGITAL SUBSCRIBER SIGNALLING SYSTEM No. 1	Q.850–Q.999
PUBLIC LAND MOBILE NETWORK	Q.1000–Q.1099
INTERWORKING WITH SATELLITE MOBILE SYSTEMS	Q.1100–Q.1199
INTELLIGENT NETWORK	Q.1200–Q.1699
SIGNALLING REQUIREMENTS AND PROTOCOLS FOR IMT-2000	Q.1700–Q.1799
SPECIFICATIONS OF SIGNALLING RELATED TO BEARER INDEPENDENT CALL CONTROL (BICC)	Q.1900–Q.1999
BROADBAND ISDN	Q.2000–Q.2999
SIGNALLING REQUIREMENTS AND PROTOCOLS FOR THE NGN	Q.3000–Q.3999

For further details, please refer to the list of ITU-T Recommendations.

Supplement 60 to ITU-T Q-series Recommendations

Supplement to Recommendations ITU-T Q.3610 and ITU-T Q.3611 – Service flows for customized multimedia ring-back tone (CRBT) and customized multimedia ringing tone (CRT) services

Summary

Supplement 60 to ITU-T Q-series Recommendations provides the service flows for customized multimedia ring-back tone (CRBT) and customized multimedia ringing tone (CRT) services in next generation networks (NGNs).

History

Edition	Recommendation	Approval	Study Group
1.0	ITU-T Q Suppl. 60	2010-01-28	11

Keywords

CRBT, CRT, IMS, NGN, SDP, SIP.

FOREWORD

The International Telecommunication Union (ITU) is the United Nations specialized agency in the field of telecommunications, information and communication technologies (ICTs). The ITU Telecommunication Standardization Sector (ITU-T) is a permanent organ of ITU. ITU-T is responsible for studying technical, operating and tariff questions and issuing Recommendations on them with a view to standardizing telecommunications on a worldwide basis.

The World Telecommunication Standardization Assembly (WTSA), which meets every four years, establishes the topics for study by the ITU-T study groups which, in turn, produce Recommendations on these topics.

The approval of ITU-T Recommendations is covered by the procedure laid down in WTSA Resolution 1.

In some areas of information technology which fall within ITU-T's purview, the necessary standards are prepared on a collaborative basis with ISO and IEC.

NOTE

In this publication, the expression "Administration" is used for conciseness to indicate both a telecommunication administration and a recognized operating agency.

Compliance with this publication is voluntary. However, the publication may contain certain mandatory provisions (to ensure e.g. interoperability or applicability) and compliance with the publication is achieved when all of these mandatory provisions are met. The words "shall" or some other obligatory language such as "must" and the negative equivalents are used to express requirements. The use of such words does not suggest that compliance with the publication is required of any party.

INTELLECTUAL PROPERTY RIGHTS

ITU draws attention to the possibility that the practice or implementation of this publication may involve the use of a claimed Intellectual Property Right. ITU takes no position concerning the evidence, validity or applicability of claimed Intellectual Property Rights, whether asserted by ITU members or others outside of the publication development process.

As of the date of approval of this publication, ITU had not received notice of intellectual property, protected by patents, which may be required to implement this publication. However, implementers are cautioned that this may not represent the latest information and are therefore strongly urged to consult the TSB patent database at <http://www.itu.int/ITU-T/ipr/>.

© ITU 2010

All rights reserved. No part of this publication may be reproduced, by any means whatsoever, without the prior written permission of ITU.

CONTENTS

	Page
1 Scope	1
2 References.....	1
3 Definitions and acronyms	1
4 Abbreviations.....	1
5 Service flows for CRBT service	2
5.1 Gateway model.....	2
5.2 Application Server model.....	11
5.3 CRBT service by HTTP model	15
5.4 Call Server model.....	16
5.5 CRBT service priority	18
5.6 Interoperation from Application Server model to Gateway model.....	20
6 Service flows for CRT service.....	21
6.1 Gateway model.....	21
6.2 CRT service by Application Server model.....	26
6.3 CRT service by HTTP model.....	27
6.4 CRT service priority	28
7 Interaction of CRBT and CRT services.....	30
7.1 Interaction between originating CRBT/CRT and terminating CRBT/CRT ...	30
7.2 Interaction between terminating CRBT and originating CRT by AS model	31

Supplement 60 to ITU-T Q-series Recommendations

Supplement to Recommendations ITU-T Q.3610 and ITU-T Q.3611 – Service flows for customized multimedia ring-back tone (CRBT) and customized multimedia ringing tone (CRT) services

1 Scope

This supplement provides the service flows for customized multimedia ring-back tone (CRBT) and customized multimedia ringing tone (CRT) services in next generation networks (NGNs). These service flows include different service models: gateway model, application server model and HTTP model which are defined in [ITU-T Q.3610] and [ITU-T Q.3611], and additional service flows for interoperation and service priority.

2 References

- [ITU-T Q.3610] Recommendation ITU-T Q.3610 (2009), *Signalling requirements and protocol profiles for customized ring-back tone service.*
- [ITU-T Q.3611] Recommendation ITU-T Q.3611 (2009), *Signalling requirements and protocol profiles for NGN customized ringing tone service.*

3 Definitions and acronyms

This supplement uses the definitions from [ITU-T Q.3610] and [ITU-T Q.3611].

4 Abbreviations

This supplement uses the following abbreviations:

AS	Application Server
AS-FE	Application Support Functional Entity
CRBT	Customized Ring-Back Tone
CRBT-O	Customized Ring-Back Tone by Originating network
CRBT-T	Customized Ring-Back Tone by Terminating network
CRT	Customized Ringing Tone
CRT-O	Customized Ringing Tone by Originating network
CRT-T	Customized Ringing Tone by Terminating network
HTTP	Hypertext Transfer Protocol
IBC-FE	Interconnection Border Gateway Control Functional Entity
I-CSC-FE	Interrogating Call Session Control Functional Entity
IMS	IP Multimedia Subsystem
MGC-FE	Media Gateway Control Functional Entity
MRC-FE	Media Resource Control Functional Entity
MRP-FE	Media Resource Processing Functional Entity
P-CSC-FE	Proxy Call Session Control Functional Entity
S-CSC-FE	Serving Call Session Control Functional Entity

SDP	Session Description Protocol
SG-FE	Signalling Gateway Functional Entity
UE	User Equipment
UE-A	User Equipment for user A
UE-B	User Equipment for user B

5 Service flows for CRBT service

5.1 Gateway model

5.1.1 IMS-based CRBT service by Gateway model with PRACK and UPDATE

An IMS-based Gateway model with UPDATE method for CRBT service without preconditions is illustrated in Figure 5-1.

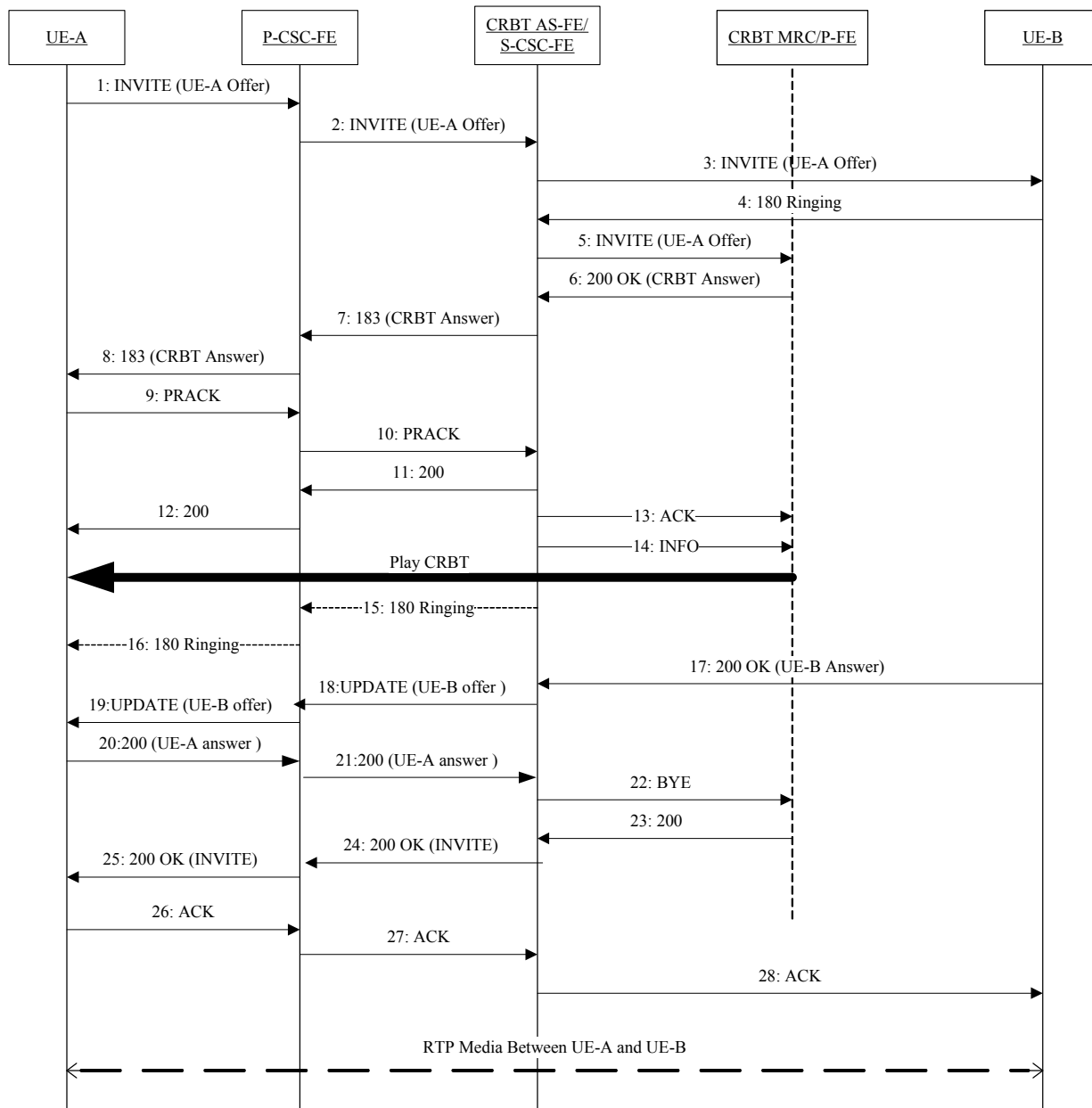

Figure 5-1 – IMS-based CRBT service flow by Gateway model with PRACK and UPDATE

The details of the service flow in Figure 5-1 are described as follows:

- (1)(2) UE-A sends "INVITE (UE-A Offer)" to UE-B through P-CSC-FE. The "INVITE" is routed through the CRBT AS-FE due to initial filter triggers on the S-CSC-FE.
- (3) The CRBT AS-FE forwards the initial "INVITE" request to UE-B.
- (4) UE-B rings and generates a "180 (Ringing)" response to UE-A. The "180 (Ringing)" first arrives at CRBT AS-FE.
- (5) Terminating CRBT AS-FE determines UE-B or originating CRBT AS-FE determines that UE-A has subscribed to CRBT service, CRBT AS-FE sends the initial INVITE request to CRBT MRC/P-FE. This step can take place directly after step (2).
- (6) CRBT MRC/P-FE sends "200 OK (CRBT Answer)" to CRBT AS-FE.

- (7-8) CRBT AS-FE sends a reliable "183 (CRBT Answer)" response to UE-A through P-CSC-FE.
- (9-10) UE-A acknowledges the reliable provisional response with "PRACK". The message first arrives at CRBT AS-FE.
- (11-12) CRBT AS-FE sends "200 OK" response to the "PRACK" to UE-A.
- (13) CRBT AS-FE sends "ACK" request to CRBT MRC-FE. This step can take place directly after step (10).
- (14) CRBT AS-FE sends INFO request to CRBT MRC/P-FE to indicate to it to start playing CRBT to UE-A.
- (15-16) CRBT AS-FE may forward the "180 Ringing" response from UE-B to UE-A through P-CSC-FE.
- (17) UE-B answers the call, and sends "200 OK (UE-B Answer)" towards UE-A. The message first arrives at CRBT AS-FE.
- (18) CRBT AS-FE sends "UPDATE (UE-B Offer)" request towards UE-A. The message first arrives at P-CSC-FE.
- (19) P-CSC-FE forwards the "UPDATE (UE-B Offer)" request towards UE-A.
- (20) UE-A sends "200 OK (UE-A Answer)" response towards CRBT AS-FE. The message first arrives at P-CSC-FE.

NOTE – In each valid Media type (video, audio, etc.), UE-A must keep the same RTP port as it is indicated for the first time.

- (21) P-CSC-FE forwards the "200 OK (UE-A Answer)" response towards CRBT AS-FE.
- (22) CRBT AS-FE decides to stop playing CRBT, then sends "BYE" request to CRBT MRC/P-FE.
- (23) CRBT MRC/P-FE stops playing CRBT and sends "200 OK" response to CRBT AS-FE.
- (24) Confirming that the UE-A has finished the offer/Answer negotiation with UE-B, CRBT-AS sends "200 OK (INVITE)" response to the initial INVITE request towards UE-A. The message first arrives at P-CSC-FE.
- (25) P-CSC-FE forwards the "200 OK (INVITE)" response towards UE-A.
- (26) UE-A sends an "ACK" request towards UE-B. This message first arrives at P-CSC-FE, and then arrives at CRBT AS-FE.
- (27) P-CSC-FE forwards the "ACK" request towards CRBT AS-FE.
- (28) CRBT AS-FE forwards the "ACK" request towards UE-B.

5.1.2 IMS-based CRBT service by Gateway model with re-INVITE

An IMS-based Gateway model with re-INVITE method for CRBT service without preconditions is illustrated in Figure 5-2.

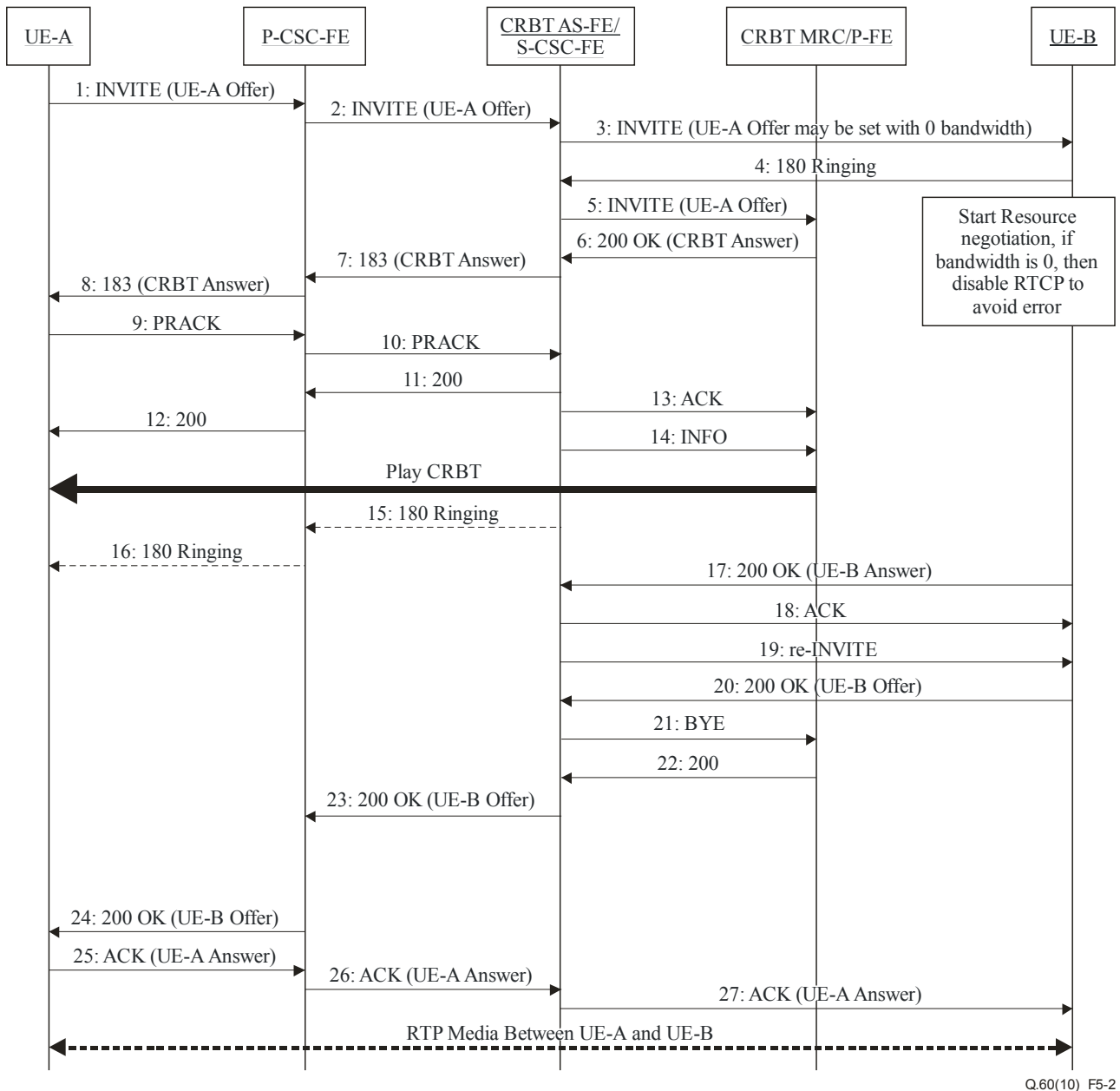

Q.60(10)_F5-2

Figure 5-2 – IMS-based CRBT service flow by Gateway model with re-INVITE

The details of the service flow in Figure 5-2 are described as follows:

- (1)(2) UE-A sends "INVITE (UE-A Offer)" to UE-B through P-CSC-FE. The "INVITE" is routed through the CRBT AS-FE due to initial filter triggers on the S-CSC-FE.
- (3) The CRBT AS-FE forwards the initial "INVITE" request to UE-B. In order not to make an RTCP error at UE-B, AS-FE may set all media types bandwidth to 0.
- (4) UE-B rings and generates a "180 (Ringing)" response to UE-A. The "180 (Ringing)" first arrives at CRBT AS-FE. UE-B starts resource negotiation, and if bandwidth of the offered media is 0, UE-B shall disable RTCP to avoid error. This step may take place after step 13.
- (5-17) Procedures are the same as service flows in Figure 5-1.

- (18) CRBT AS-FE sends "ACK" request towards UE-B.
- (19) CRBT AS-FE sends "re-INVITE" request without SDP towards UE-B.
- (20) UE-B sends "200 OK (UE-B Offer)" response towards UE-A. This message first arrives at CRBT AS-FE.
- (21) CRBT AS-FE decides to stop playing CRBT, then sends "BYE" request to CRBT MRC/P-FE. This step can take place directly after step 16.
- (22) CRBT MRC/P-FE stops playing CRBT and sends "200 OK" response to CRBT AS-FE.
- (23) CRBT AS-FE sends "200 OK (UE-B Offer)" response to the initial INVITE request towards UE-A. The message first arrives at P-CSC-FE. P-CSC-FE may start the charging function.
- (24) P-CSC-FE forwards the "200 OK (UE-B Offer)" response towards UE-A.
- (25-26) UE-A sends an "ACK (UE-A Answer)" request towards UE-B. This message arrives at CRBT AS-FE.
- (27) CRBT AS-FE forwards the "ACK (UE-A Answer)" request towards UE-B.

5.1.3 IMS-based Gateway model with preconditions

A Gateway model for CRBT service with preconditions is illustrated in Figure 5-3.

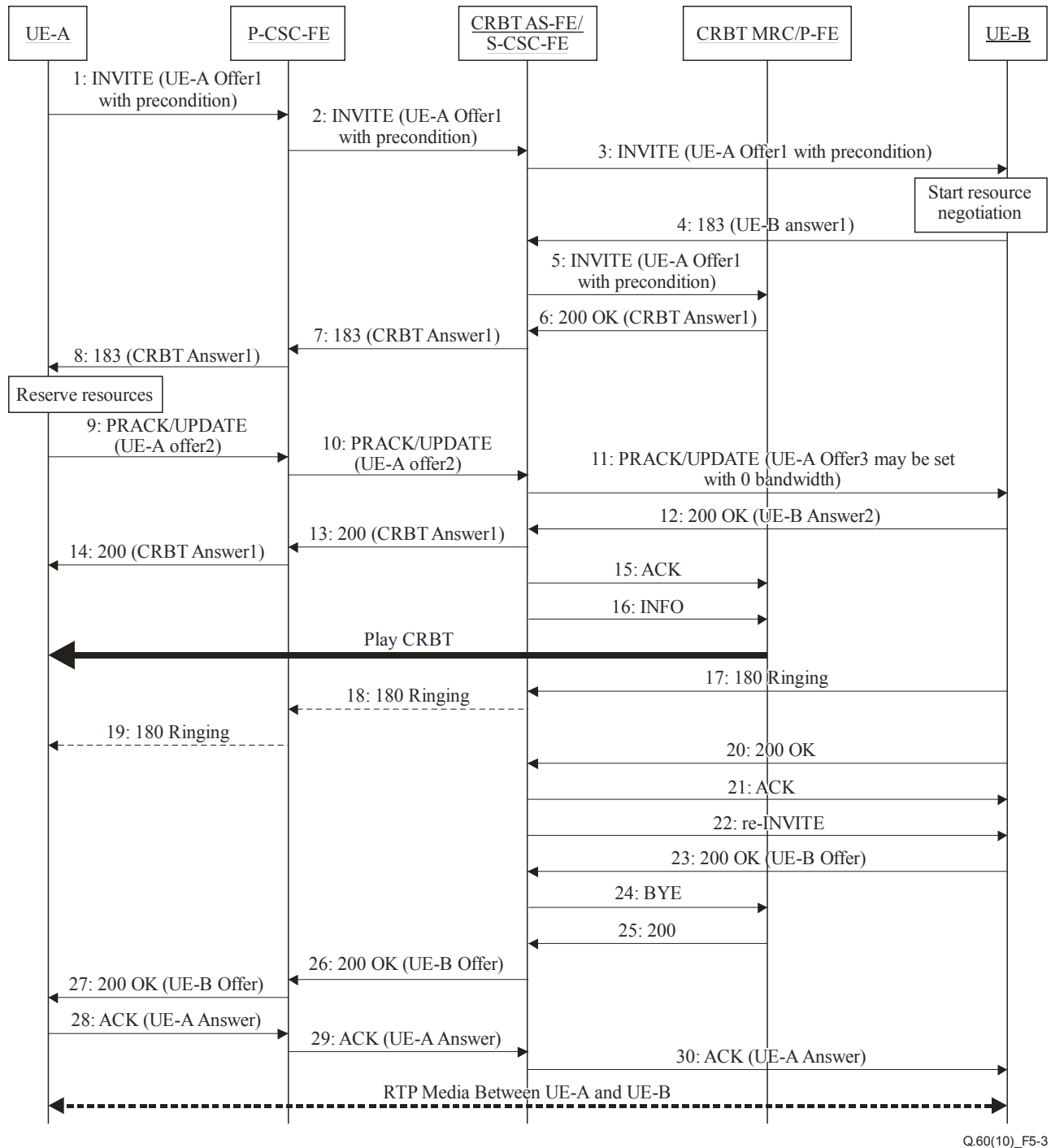

Figure 5-3 – CRBT service flow in IMS with preconditions

The details of the service flow in Figure 5-3 are described as follows:

- (1)(2) UE-A sends "INVITE (UE-A Offer1)" to UE-B through P-CSC-FE. The "INVITE" is routed through the CRBT AS-FE due to initial filter triggers on the S-CSC-FE. The UE-A needs resource reservation (e.g., mobile phone), so UE-A Offer1 SDP carries this with precondition.
- (3) The CRBT AS-FE forwards the initial "INVITE" request to UE-B. UE-B starts resource negotiation and resource reservation.

- (4) UE-B sends a reliable "183 (UE-B Answer1)" response towards UE-A. The "183 (UE-B Answer1)" first arrives at CRBT AS-FE.
- (5) CRBT AS-FE determines whether UE-B or UE-A has subscribed to the CRBT service, CRBT AS-FE sends the initial "INVITE" request to CRBT MRC/P-FE.
- (6) CRBT MRC/P-FE sends "200 OK (CRBT Answer1)" to CRBT AS-FE.
- (7)(8) CRBT AS-FE sends a reliable "183 (CRBT Answer1)" response to UE-A through P-CSC-FE. The CRBT AS-FE changes all media types "a" line to "sendonly" or add P-Early-Media header field with a value of "sendonly" to the response.
- (9)(10) UE-A reserves resources according to SDP of CRBT Answer1 SDP, and sends out a new SDP offer as UE-A Offer2 towards UE-B via "PRACK" or "UPDATE" request. The message arrives at CRBT AS-FE.
- (11) CRBT AS-FE forwards the "PRACK" or "UPDATE" request to UE-B. The UE-A Offer3 is generated based on UE-A Offer2 SDP and UE-B Answer1 SDP. The UE-A Offer3 SDP may contain all available media types in UE-B Answer1 SDP, so that the regular media can contain all media types expected by the user. In order not to make an RTCP error at UE-B, CRBT AS-FE may set all media types bandwidth to 0. If media types "a" line in CRBT Answer1 has a value of "sendonly", CRBT AS-FE shall change the corresponding media types "a" line in UE-A Offer3 from "recvonly" to "sendrecv", in order to establish bidirectional communication after the call is answered.
- (12) UE-B sends "200 OK (UE-B Answer2)" towards UE-A. This message first arrives at CRBT AS-FE.
- (13)(14) CRBT AS-FE sends "200 OK (CRBT Answer1)" response towards UE-A through P-CSC-FE.
- (15) CRBT AS-FE sends "ACK" request to CRBT MRC/P-FE. This step can take place directly after step 10.
- (16) CRBT AS-FE sends INFO request to CRBT MRC/P-FE to indicate to it to start playing CRBT to UE-A.
- (17) UE-B rings and generates a "180 (Ringing)" response to UE-A. The "180 (Ringing)" first arrives at CRBT AS-FE.
- (18)(19) CRBT AS-FE may forward the "180 (Ringing)" response towards UE-A through P-CSC-FE.
- (20) UE-B answers the call, and sends "200 OK" towards UE-A. The message first arrives at CRBT AS-FE.
- (21) CRBT AS-FE sends "ACK" request towards UE-B.
- (22) CRBT AS-FE sends "re-INVITE" request without SDP towards UE-B.
- (23) UE-B sends "200 OK (UE-B Offer)" response towards UE-A. This message first arrives at CRBT AS-FE.
- (24) CRBT AS-FE decides to stop playing CRBT, then sends "BYE" request to CRBT MRC/P-FE. This step can happen directly after step 16.
- (25) CRBT MRC/P-FE stops playing CRBT and sends "200 OK" response to CRBT AS-FE.
- (26) CRBT-AS sends "200 OK (UE-B Offer)" response to the initial INVITE request towards UE-A. The message first arrives at P-CSC-FE. P-CSC-FE may start the charging function.
- (27) P-CSC-FE forwards the "200 OK (UE-B Offer)" response towards UE-A.
- (28)(29) UE-A sends an "ACK (UE-A Answer)" request towards UE-B. This message arrives at CRBT AS-FE.

(30) CRBT AS-FE forwards the "ACK (UE-A Answer)" request towards UE-B.

5.1.4 Gateway model for CRBT service with multimedia

The Gateway model for CRBT service with multimedia early session is illustrated in Figure 5-4. In this scenario, audio is used for conversation, and audio and video are used for CRBT early session.

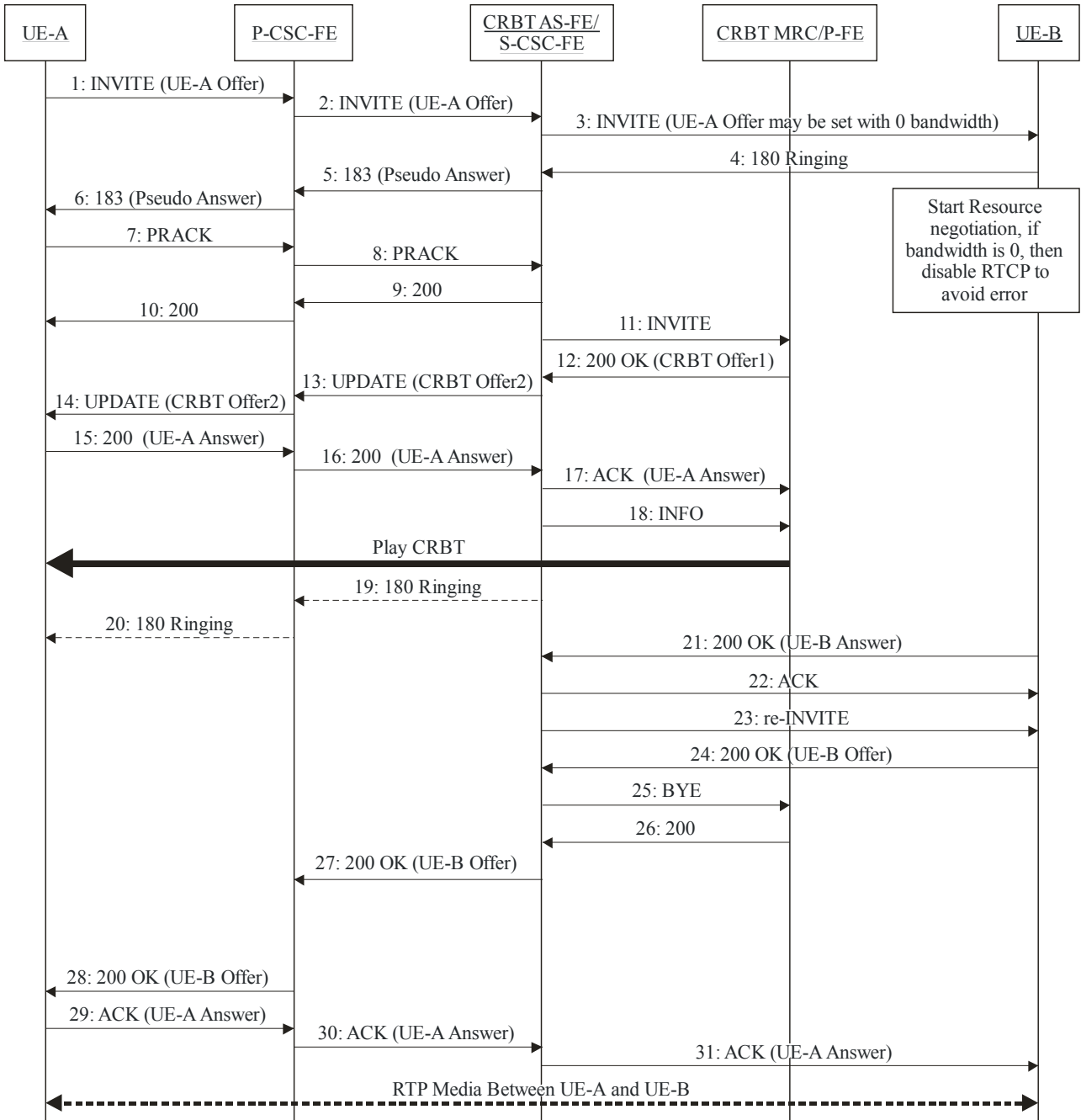

Figure 5-4 – CRBT service flow in IMS with multimedia

The details of the service flow in Figure 5-4 are described as follows:

- (1)(2) UE-A sends "INVITE (UE-A Offer)" with audio to UE-B through P-CSC-FE. The INVITE is routed through the CRBT AS-FE due to initial filter triggers on the S-CSC-FE.

- (3) The CRBT AS-FE forwards the initial INVITE request to UE-B. In order not to make an RTCP error at UE-B, AS-FE may set all media types bandwidth to 0 to turn off RTCP transmission.
- (4) UE-B rings and generates a "180 (Ringing)" response to UE-A. The "180 (Ringing)" first arrives at CRBT AS-FE. UE-B starts resource negotiation, and if bandwidth of the offered media is 0, UE-B shall disable RTCP to avoid error. This step may take place after step 13.
- (5)(6) CRBT AS-FE determines whether UE-B or UE-A has subscribed to a CRBT service, CRBT AS-FE sends pseudo SDP answer via "183 Session Progress" response towards UE-A. The pseudo SDP answer can be easily generated by setting port of all media types to 0. Step 5 can happen directly after step 2.
- (7)(8) UE-A acknowledges the reliable provisional response with "PRACK". The message first arrives at CRBT AS-FE.
- (9)(10) CRBT AS-FE sends "200 OK" response to the "PRACK" to UE-A.
- (11) CRBT AS-FE sends an initial INVITE request without SDP to CRBT MRC/P-FE. This step can happen directly after step 2.
- (12) CRBT MRC/P-FE sends "200 OK (CRBT Offer1)" audio and video description to CRBT AS-FE.
- (13)(14) CRBT AS-FE sends an "UPDATE (CRBT Offer2)" request with audio and video description towards UE-A. CRBT Offer2 SDP is then generated based on CRBT Offer1 SDP.
- (15)(16) UE-A sends a "200 OK (UE-A Answer)" response with audio and video description towards UE-B. This message first arrives at CRBT AS-FE.
- (17) CRBT AS-FE sends "ACK (UE-A Answer)" acknowledgement audio and video description to CRBT MRC/P-FE.
- (18) CRBT AS-FE sends INFO request to CRBT MRC/P-FE to indicate to it to start playing CRBT to UE-A.
- (19)(20) CRBT AS-FE may forward the "180 Ringing" response from UE-B to UE-A through P-CSC-FE.
- (21) UE-B answers the call, and sends "200 OK (UE-B Answer)" with audio description towards UE-A. The message first arrives at CRBT AS-FE.
- (22) CRBT AS-FE sends "ACK" request towards UE-B.
- (23) CRBT AS-FE sends "re-INVITE" request without SDP towards UE-B.
- (24) UE-B sends "200 OK (UE-B Offer)" response with audio towards UE-A. This message first arrives at CRBT AS-FE.
- (25) CRBT AS-FE decides to stop playing CRBT, then sends "BYE" request to CRBT MRC/P-FE. This step can take place directly after step 16.
- (26) CRBT MRC/P-FE stops playing CRBT and sends "200 OK" response to CRBT AS-FE.
- (27) CRBT-AS sends "200 OK (UE-B Offer)" response with audio to the initial INVITE request towards UE-A. The message first arrives at P-CSC-FE. P-CSC-FE may start the charging function.
- (28) P-CSC-FE forwards the "200 OK (UE-B Offer)" response with audio towards UE-A.
- (29)(30) UE-A sends an "ACK (UE-A Answer)" request with audio towards UE-B. This message arrives at CRBT AS-FE.
- (31) CRBT AS-FE forwards the "ACK (UE-A Answer)" request with audio towards UE-B.

5.2 Application Server model

5.2.1 CRBT service by Application Server model

When the originating side (calling party) initiates a session, it will send INVITE to the network side. If the called party is subscribed to the CRBT service and the calling party supports early media call, the network side holds a CRBT early session negotiation with the calling party and then plays CRBT to the calling party.

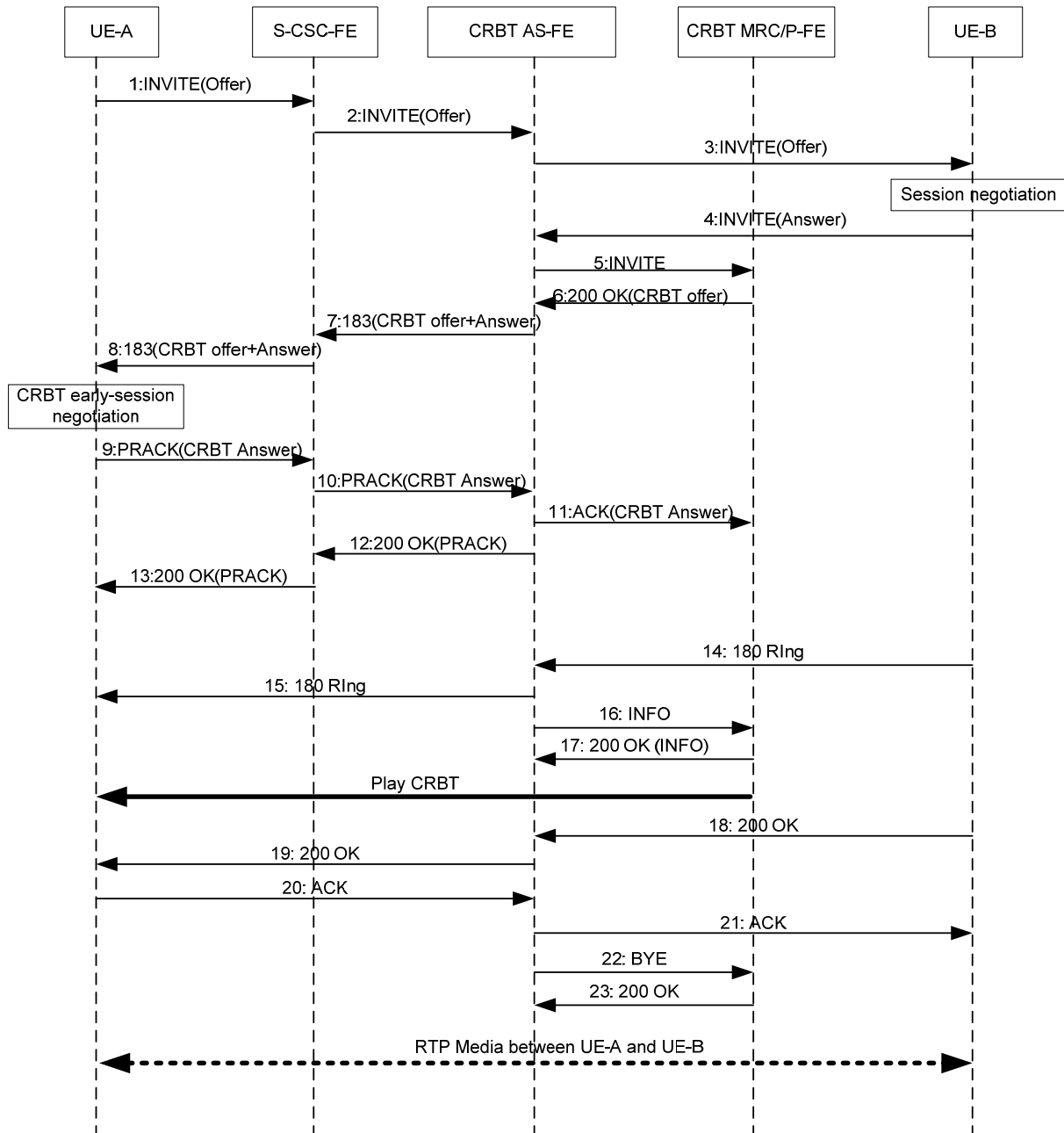

Figure 5-5 – CRBT service flow by Application Server model

The details of the service flow in Figure 5-5 are described as follows.

- (1-2) UE-A sends "INVITE (offer)" to establish a call with UE-B. The "INVITE" is routed to CRBT AS-FE due to initial filter criteria on the S-CSC-FE. The "INVITE" includes early-session option tag and 100rel option tag in its supported header field.
- (3) The AS-FE sends "INVITE" with offer to UE-B.

- (4) UE-B generates a reliable "183 (answer)" response to UE-A. The "183 (answer)" first arrives at CRBT AS-FE.
- (5) CRBT AS-FE determines that UE-A supports early session and UE-B has subscribed to a CRBT service. CRBT AS-FE sends "INVITE" to CRBT MRC/P-FE.
- (6) CRBT MRC/P-FE sends "200 OK(CRBT offer)" to CRBT AS-FE.
- (7-8) CRBT AS-FE determines that UE-A supports early session according to "INVITE" and sends "183 (answer, CRBT offer)" response to UE-A.
- (9-10) UE-A acknowledges the reliable provisional response "PRACK (CRBT answer)". The message first arrives at CRBT AS-FE.
- (11) CRBT AS-FE forwards "PRACK (CRBT answer)" to CRBT MRC/P-FE.
- (12-13) CRBT AS-FE sends "200 OK" to acknowledge PRACK from UE-A.
- (14-15) UE-B sends "180 ringing" to UE-A. The response first reaches the CRBT AS-FE.
- (16) CRBT AS-FE sends "INFO" to CRBT MRC/P-FE.
- (17) CRBT MRC/P-FE sends response "200 OK (INFO)". Then MRC/P-FE plays CRBT to UE-A.
- (18-19) UE-B sends "200 OK" to UE-A. The response first reaches the CRBT AS-FE.
- (20-21) UE-A sends "ACK" to UE-B. The message first arrives at CRBT AS-FE.
- (22) CRBT AS-FE sends the SIP message "BYE" to CRBT MRC/P-FE.
- (23) CRBT MRC/P-FE sends "200 OK" to answer the "BYE" message and then stops playing CRBT to UE-A.

5.2.2 Providing PSTN CRBT to the originating UE in IMS domain

When the calling party in IMS domain initiates a session with the called party in PSTN, the call request from the calling party arrives at MGC-FE first. MGC-FE is responsible for communicating with the called party in PSTN and holds an early media session negotiation with the calling party. If negotiation is successful, PSTN plays CRBT to the calling party. When the called party answers the call, PSTN stops playing CRBT and MGC-FE connects to the calling party.

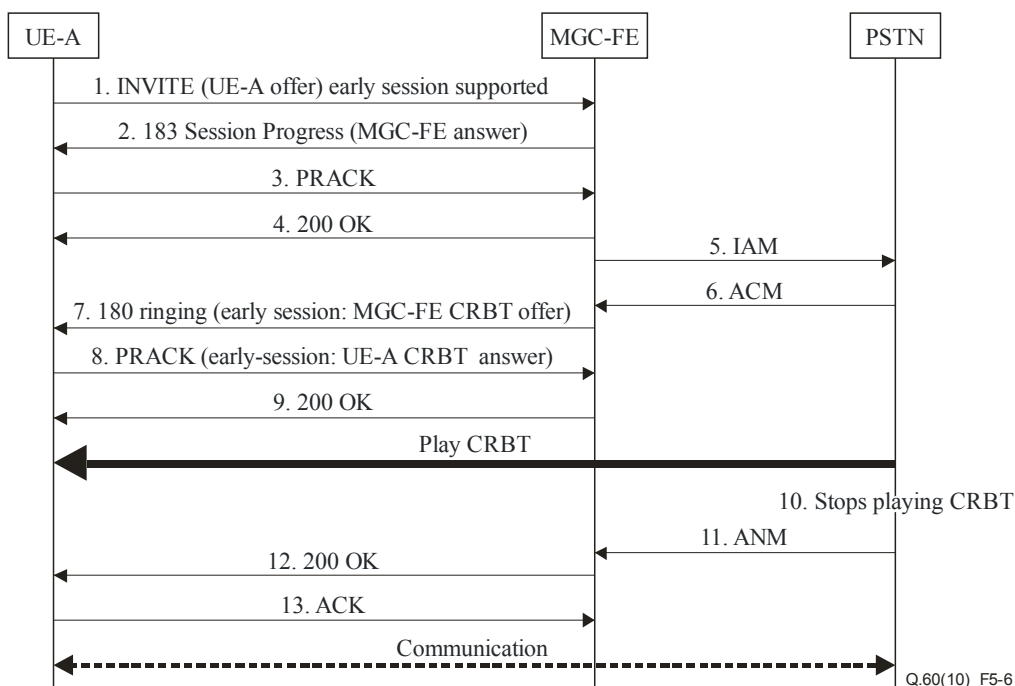

Figure 5-6 – Service flow for providing the PSTN CRBT to the originating UE in IMS

The details of the service flow in Figure 5-6 are described as follows:

- (1) UE-A sends "INVITE" to the MGC-FE. The "INVITE" includes the UE-A's SDP offer and early session supported indication.
- (2) MGC-FE sends "183 session progress" to UE-A with MGC-FE SDP answer.
- (3) UE-A sends "PRACK" to MGC-FE
- (4) MGC-FE sends "200 OK" to UE-A.
- (5) The MGC-FE sends "IAM" to the PSTN.
- (6) PSTN sends "ACM" to MGC-FE. ACM includes "In-band information available" indication.
- (7) MGC-FE checks that UE-A supports early session, and sends "180 Ringing" to UE-A, which includes the MGC-FE CRBT early session offer.
- (8) UE-A sends "PRACK" to MGC-FE with UE-A CRBT early session answer.
- (9) MGC-FE sends "200 OK" to UE-A.
- (10-11) When the called party answers, PSTN stops playing CRBT. PSTN sends "ANM" to the MGC-FE.
- (12) MGC-FE sends "200 OK" to UE-A.
- (13) UE-A sends "ACK" to acknowledge the response.

5.2.3 CRBT service by Gateway model (Originating PSTN/IDSN interworking case)

When the calling party in the CS domain initiates a session with the called party in the IMS domain, the call request from the calling party arrives at MGC-FE. MGC-FE triggers a CRBT service and is responsible for communicating with CRBT AS-FE. If CRBT AS-FE decides to play CRBT to the calling party, MGC-FE asks the MSC to connect to the calling party according to the message from CRBT AS-FE and holds an early media session negotiation with the calling party. If negotiation is successful, MRC/P-FE plays CRBT to the calling party. When the called party answers the call, MRC/P-FE stops playing CRBT.

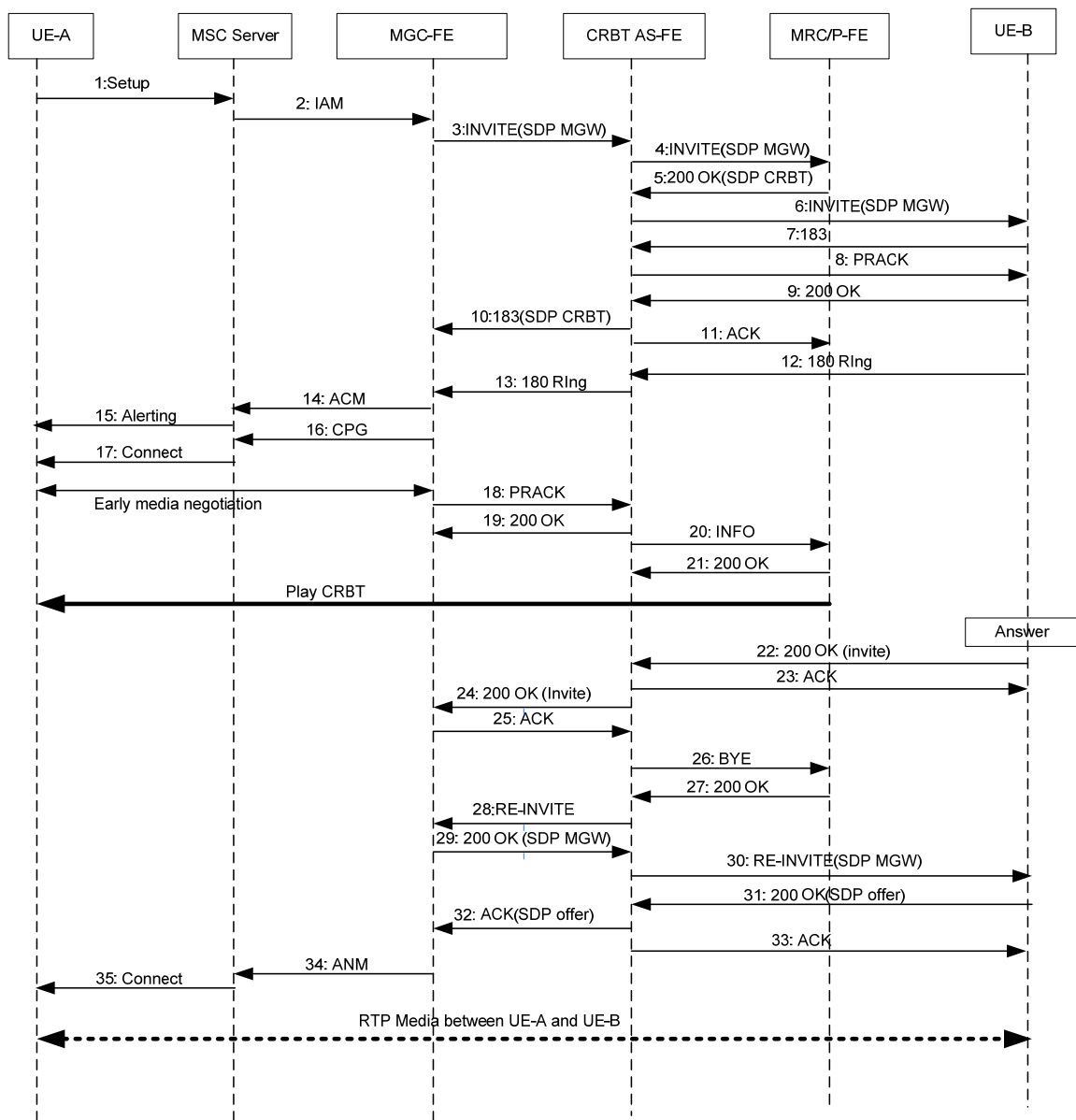

Figure 5-7 – CRBT service flow by Gateway model (originating PSTN/IDSN interworking case)

The details of Figure 5-7 are described as follows:

- (1) UE-A sends call request "Setup" to MSC Server/MGW, UE-A indicates in the Setup message if it supports the capability to set up an early media session (e.g., capability of CRBT service) prior to the call towards the called party.
- (2) MSC Server/MGW sends "IAM" to MGC-FE.
- (3) MGC-FE sends "INVITE" to the CRBT AS-FE. The "INVITE" includes the MGW SDP offer and early session supported indication.
- (4) CRBT AS-FE forwards "INVITE" to MRC/P-FE.
- (5) MRC/P-FE sends "200 OK" with SDP CRBT offer to CRBT AS-FE to reply to the "INVITE".
- (6) CRBT AS-FE forwards "INVITE" to UE-B.
- (7) UE-B sends "183 session progress" to CRBT AS-FE.
- (8) CRBT AS-FE sends "PRACK" to UE-B.

- (9) UE-B sends "200 OK" to CRBT AS-FE.
- (10) CRBT AS-FE forwards "183 session progress" to MGC-FE with SDP CRBT offer.
- (11) CRBT AS-FE sends "ACK" to MRC/P-FE.
- (12)(13) UE-B sends "180 ringing" to MGC-FE.
- (14) MGC-FE sends "ACM" to MSC Server/MGW.
- (15) MSC Server/MGW sends "Alerting" to UE-A.
- (16) MGC-FE checks whether the CRBT contains video, if it does, then MGC-FE sends "CPG" to MSC Server instructing MSC Server to connect to the UE-A.
- (17) MSC Server/MGW sends "Connect" to UE-A.

NOTE – UE-A will hold an early media session negotiation with MGC-FE.

- (18) MGC-FE sends "PRACK" to CRBT AS-FE.
- (19) CRBT AS-FE sends "200 OK" response to MGC-FE.
- (20) CRBT AS-FE sends "INFO" to MRC/P-FE.
- (21) MRC/P-FE sends "200 OK" to CRBT AS-FE and plays CRBT to UE-A.
- (22) When the called party answers, UE-B sends "200 OK" to CRBT AS-FE to reply to the "INVITE".
- (23) CRBT AS-FE sends "ACK" to UE-B.
- (24) CRBT AS-FE sends "200 OK" to MGC-FE.
- (25) MGC-FE sends "ACK" to CRBT AS-FE
- (26-27) CRBT AS-FE sends "BYE" to CRBT MRC/P-FE to stop playing CRBT. CRBT MRC/P-FE replies "200 OK" to CRBT AS-FE.
- (28) CRBT AS-FE sends "RE-INVITE" without SDP to MGC-FE.
- (29) MGC-FE sends "200 OK" with MGW SDP to CRBT AS-FE.
- (30) CRBT AS-FE forwards "RE-INVITE" with MGW SDP to UE-B.
- (31) UE-B sends "200 OK" with SDP offer to CRBT AS-FE.
- (32) CRBT AS-FE sends "ACK" with SDP offer by UE-B to MGC-FE.
- (33) CRBT AS-FE sends "ACK" to UE-B.
- (34) MGC-FE sends "ANM" to MSC Server/MGW.
- (35) MSC Server/MGW sends "Connect" to UE-A. UE-A has a communication with UE-B.

5.3 CRBT service by HTTP model

When the calling party initiates a session, the information about the web URL of the called party for CRBT contents is sent to the calling party. Then, the calling party downloads the CRBT contents using the URL provided by the called party.

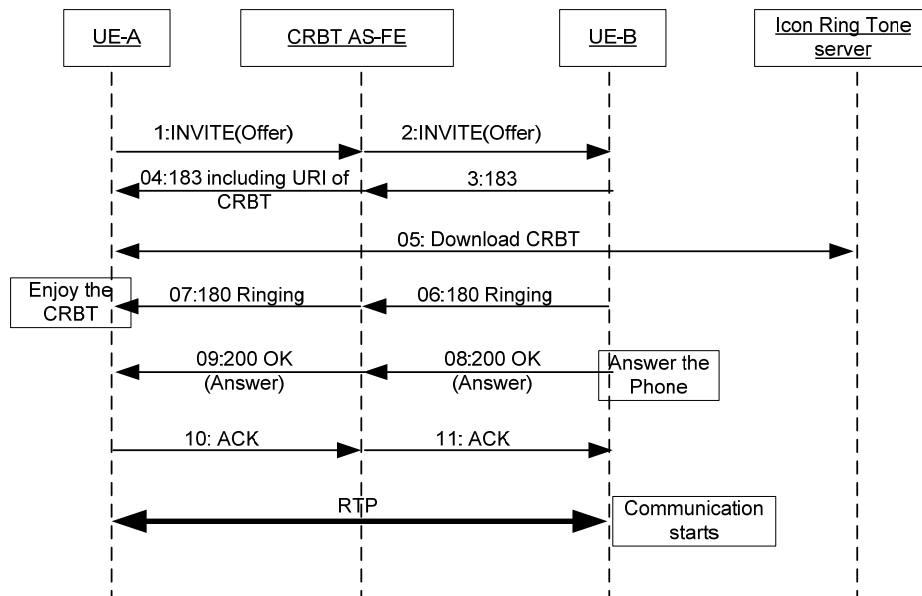

Figure 5-8 – CRBT service flow by HTTP model

NOTE – For the HTTP connection, security issues are out of scope of this service flow.

- (1)(2) UE-A sends "INVITE (offer)" to UE-B. The message is delivered through CRBT AS-FE and the CRBT AS-FE determines the CRBT contents of the URL.
- (3)(4) When a provisional response (183) arrives, the CRBT AS-FE adds the information about the URL address of the CRBT which was subscribed and configured by the UE-B to "183 Progress" and forwards it to UE-A.
- (5) UE-A downloads the CRBT contents from the CRBT contents server, according to the provided URL address in (4).
- (6-7) UE-B sends "180 ringing" to UE-A. Then UE-A terminal plays the CRBT ring-back tone downloaded from the CRBT contents server.
- (8-9) UE-B answers the call from UE-A and sends the "200 OK" to UE-A.
- (10-11) UE-A returns the ACK response, and then UE-A stops playing CRBT ring-back contents. A normal session is established between UE-A and UE-B, and conversation starts.

According to the service policy, UE-A can keep playing the CRBT contents while conversing with UE-B.

5.4 Call Server model

CRBT service flow in Call Server model includes Call server, CRBT AS-FE, SUP-FE, Caller (UE-A), Callee (UE-B) and MRC/P-FE. The Call Server receives the call request from the caller and decides whether the user is subscribed to the CRBT service or not. If the user is subscribed to the CRBT service, the Call Server will inform the CRBT AS-FE to trigger the CRBT service. The CRBT AS-FE decides the CRBT resource subscribed to by the callee, and then informs the CRBT MRC/P-FE. CRBT MRC/P-FE will have an early media session negotiation with the caller and then play CRBT to the caller. After the callee answers the call, CRBT AS-FE requests the CRBT MRC/P-FE to stop playing CRBT.

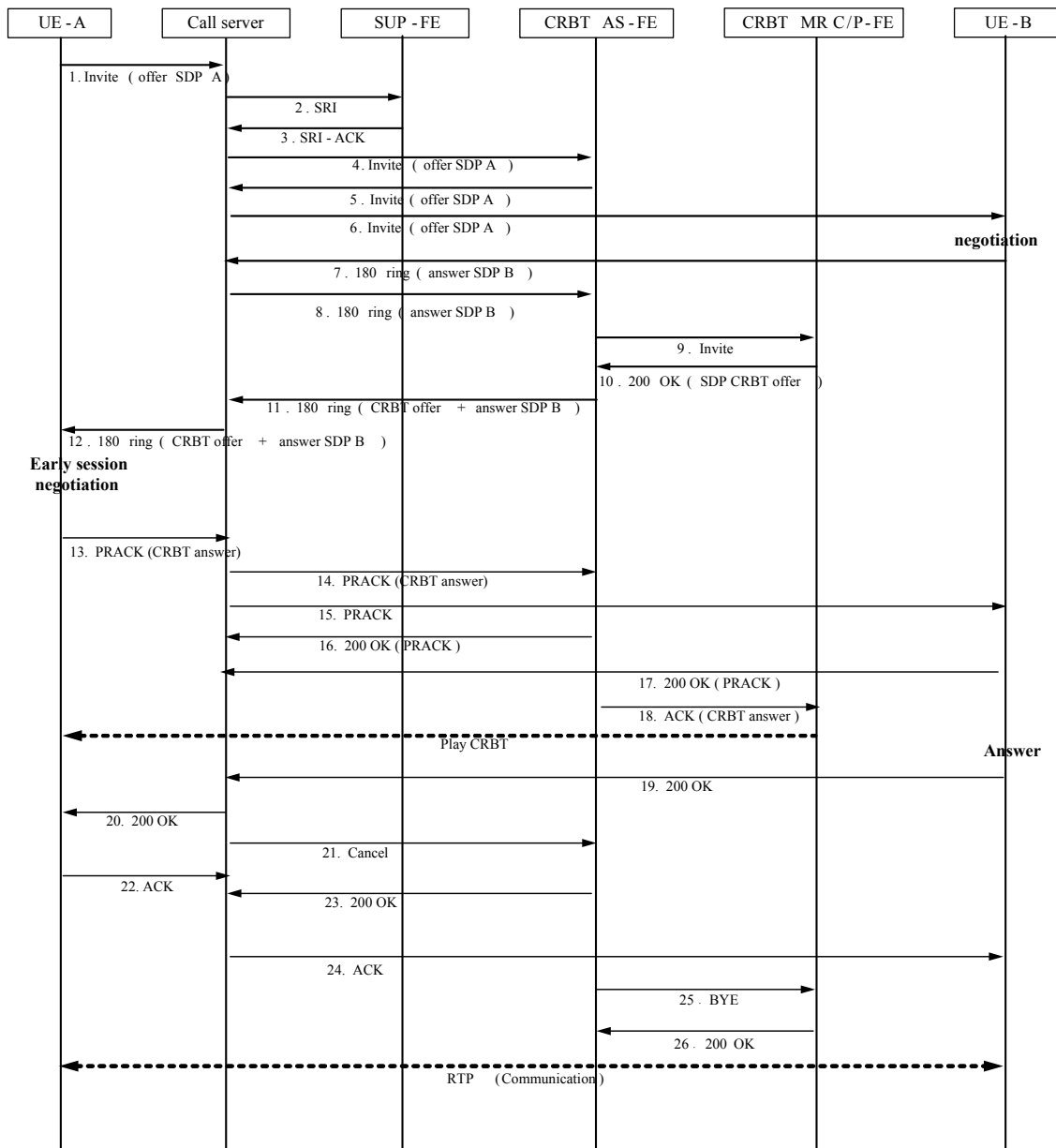

Figure 5-9 – CRBT service flow in Call Server model

The details of Figure 5-9 are described as follows:

- (1) UE-A sends a call request "INVITE" including SDP A to the Call server.
- (2) The Call server sends "SRI" to SUP-FE to decide whether the callee is subscribed to CRBT or not.
- (3) SUP-FE replies to the Call server including subscriber indication. In this case, it is assumed that the callee is the CRBT user.
- (4) The Call server sends "INVITE" to CRBT AS-FE to trigger the CRBT service including the subscriber indication.
- (5) CRBT AS-FE gets the subscribed CRBT information from CRBT resource database and then replies with "INVITE" including subscriber indication.
- (6) The Call server sends "INVITE" to UE-B to have a regular media session negotiation.
- (7) UE-B responds with "180 ring" to the Call server, which means that UE-B is idle.
- (8) The Call server forwards the "180 ring" to CRBT AS-FE.

- (9) CRBT AS-FE sends "INVITE" to CRBT MRC/P-FE including the subscribed CRBT information.
- (10) CRBT MRC/P-FE replies "200 OK" including the SDP CRBT offer.
- (11) CRBT AS-FE sends "180 ring" to the call server including the CRBT offer and answer B.
- (12) The Call Server forwards the "180 ring" to UE-A to have an early media session negotiation.
- (13) UE-A sends "PRACK" to answer the CRBT offer.
- (14) The Call server sends the "PRACK" including CRBT answer to CRBT AS-FE.
- (15) The Call server sends the "PRACK" to UE-B.
- (16) CRBT AS-FE sends "200 OK" to reply to the "PRACK".
- (17) UE-B sends "200 OK" to reply to the "PRACK".
- (18) CRBT AS-FE sends "ACK" to CRBT MRC/P-FE and then plays CRBT to the caller UE-A.
- (19) UE-B answers the call sending "200 OK".
- (20) The Call server sends "200 OK" to the UE-A.
- (21) The Call server sends "Cancel" to CRBT AS-FE to stop playing CRBT.
- (22) UE-A sends "ACK" to UE-B. The "200 OK" is sent to the Call server.
- (23) CRBT AS-FE sends "200 OK" to the Call server to reply to the "Cancel".
- (24) The Call server forwards the "ACK" from the UE-A to the UE-B.
- (25) CRBT AS-FE sends "BYE" to CRBT MRC/P-FE to stop playing CRBT.
- (26) CRBT MRC/P-FE replies "200 OK" to CRBT AS-FE and stops CRBT.

Finally, UE-A has a communication with UE-B.

5.5 CRBT service priority

When both the calling party and the called party have configured CRBT, then a priority mechanism is needed to determine which one will be invoked first. CRBT priority can be configured by subscriber setting, default operator setting in CRBT AS-FE, or it can be configured in the calling party's terminal.

As an example, Figure 5-10 shows the case where CRBT priority is configured in the calling party's CRBT AS-FE. The calling party's CRBT AS-FE will check the CRBT priority setting and decide which CRBT (the one set by the called or the calling CRBT service subscriber) should be played to the calling party when the initial INVITE is forwarded to it.

Figure 5-10 shows the service flow for priority service provided by the originating CRBT of the Application Server model.

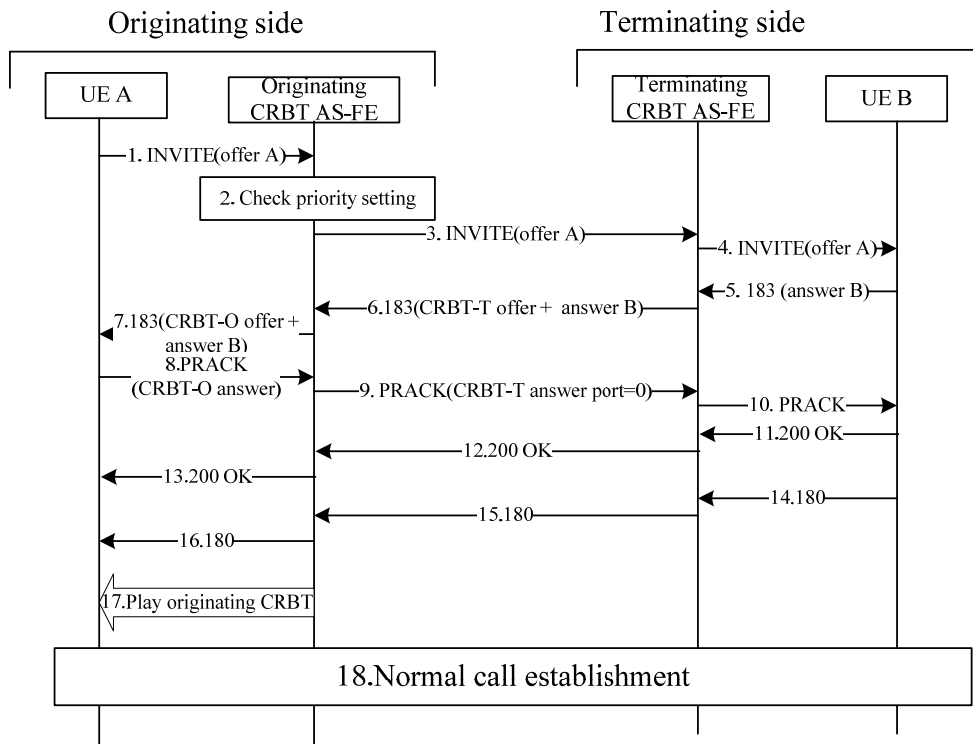

Figure 5-10 – Service flow for priority service provided by the originating CRBT

The details of Figure 5-10 are described as follows:

- (1) The UE-A sends "INVITE" to the originating CRBT AS-FE.
- (2-3) The originating CRBT AS-FE checks the CRBT priority setting and forwards the "INVITE" to the terminating CRBT AS-FE.
- (4-5) The terminating CRBT forwards the "INVITE" to UE-B and UE-B responds with "183 response".
- (6) The terminating CRBT AS-FE adds CRBT-T offer SDP to 183 and forwards the "183 response" to the originating CRBT AS-FE.
- (7) Because the originating CRBT has the priority, the originating CRBT AS-FE adds "CRBT-O offer SDP" instead of "CRBT-T offer" in "183 response" and forwards "183" to UE-A.
- (8) UE-A completes the originating CRBT media negotiation and sends "PRACK" with "CRBT-O answer SDP" to the originating CRBT AS-FE.
- (9) The originating CRBT AS-FE sends "PRACK" to the terminating CRBT AS-FE, which contains "CRBT-T answer SDP" setting port to 0 to refuse the terminating CRBT media negotiation.
- (10) The terminating CRBT AS-FE is aware of not providing terminating CRBT to UE-A and sends "PRACK" to UE-B.
- (11-13) UE-B sends "200 OK" to UE-A.
- (14-17) UE-B sends "180 Ringing" to UE-A and the originating CRBT AS-FE plays the originating CRBT to UE-A.
- (18) Finally, the call is established.

5.6 Interoperation from Application Server model to Gateway model

Figure 5-11 considers that the calling party and the called party only support the Gateway model. In case the calling CRT service and the called CRBT service need to be provided to the users, both services cannot be provided in parallel.

Therefore, the interoperation function from the Application Server model to the Gateway model in CRBT AS-FE is required.

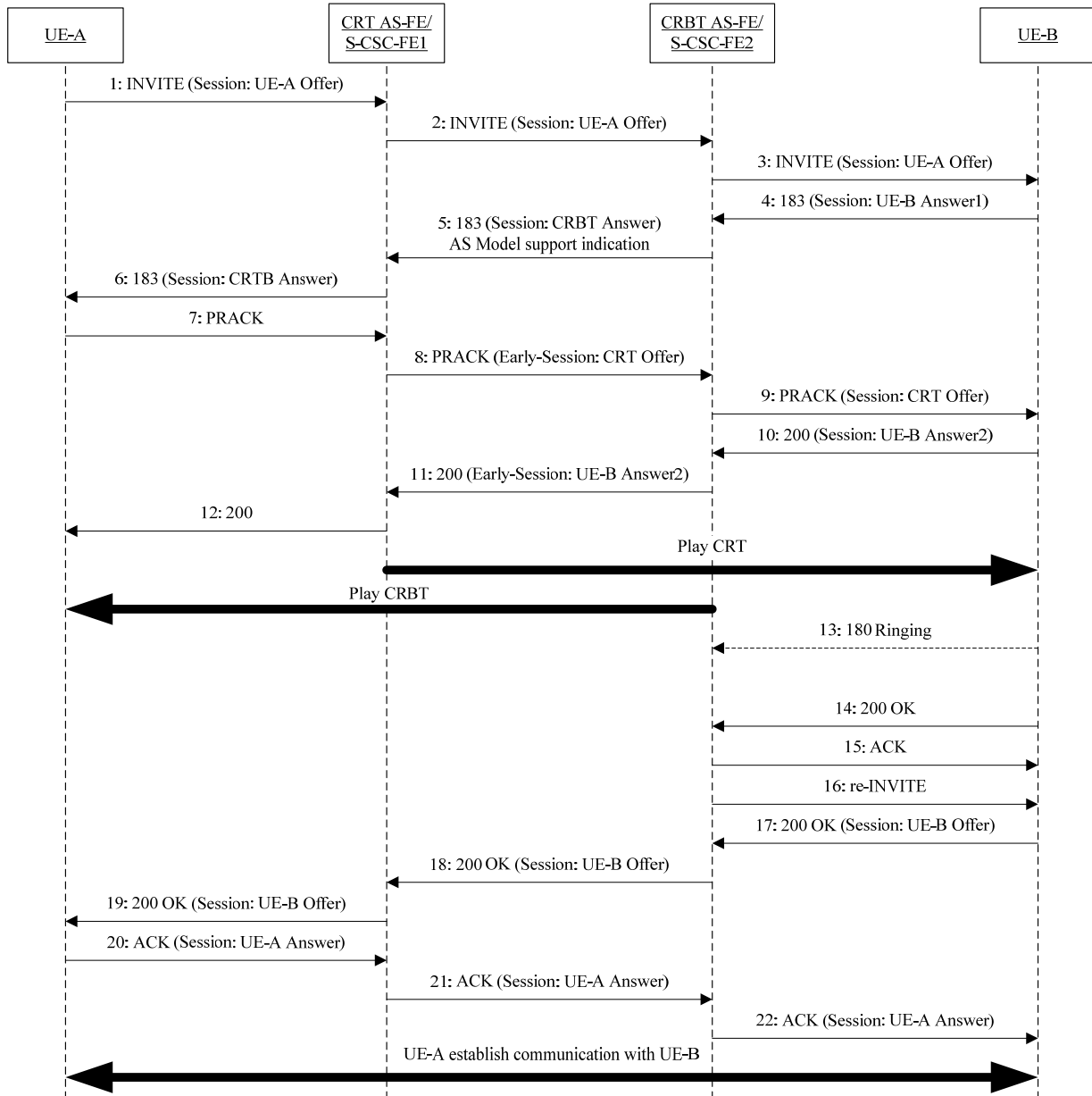

Figure 5-11 – Service flow for Interoperation from AS to Gateway model

The details of the service flow in Figure 5-11 are described as follows:

- (1-3) UE-A sends "INVITE (Session: UE-A Offer)" to establish a call with UE-B. "INVITE" is routed to CRT AS-FE due to the initial filter criteria on the S-CSC-FE1 and is routed to CRBT AS-FE due to the initial filter criteria on the S-CSC-FE2.

- (4) UE-B generates a reliable "183 (Session: UE-B Answer1)" response to UE-A. The "183 response" first arrives at CRBT AS-FE.
- (5) CRBT AS-FE notices that both UE-A and UE-B do not support early session, and that UE-B has subscribed to the CRBT service; CRBT AS-FE adds Application Server model support indication in the "183 response", e.g., add early-session option tag in the Supported header field, and sends the "183 response" towards the UE-A.
- (6) The "183 response" arrives at CRT AS-FE, CRT AS-FE removes the Application Server model support indication and forwards the "183 response" towards the UE-A.
- (7) UE-A acknowledges the 183 reliable provisional response by sending PRACK request. The "PRACK" request first arrives at CRT AS-FE.
- (8) CRT AS-FE adds early-session SDP for CRT service in the PRACK request, and forwards it to the UE-B.
- (9) "PRACK" request arrives at CRBT AS-FE, CRBT AS-FE adds session SDP Offer for CRT service, which is generated based on the early-session SDP CRT Offer, and removes early-session SDP CRT Offer from the "PRACK" request, and then forwards the "PRACK" request to UE-B. CRBT AS-FE may add more media type information from session SDP UE-A Offer/UE-B Answer1 into the session SDP Offer for CRT service to make sure the final communication contains all media types in the original session SDP Offer/Answer.
- (10) UE-A send "200 (Session: UE-B Answer2)" towards UE-A. The message first arrives at CRBT AS-FE.
- (11) CRBT AS-FE adds early-session SDP Answer for CRT service in the 200 response, that is generated based on the session SDP UE-B Answer2, and removes session SDP UE-B Answer2 from the 200 response, and then forwards the 200 response to UE-A.
- (12) The 200 response arrives at CRT AS-FE, CRT AS-FE removes the early-session SDP and forwards the 200 response towards UE-A.
- (13) UE-B optionally sends "180 Ringing" response towards UE-A. CRBT AS-FE may not forward it to UE-A.
- (14) UE-B answers the call, and sends "200 OK" response towards UE-A. The response first arrives at CRBT AS-FE.
- (15) CRBT AS-FE acknowledges the "200 OK" response by sending "ACK" request towards UE-B.
- (16) CRBT AS-FE meanwhile sends re-INVITE request without SDP towards UE-B.
- (17) UE-B sends "200 OK (Session: UE-B Offer)" towards UE-A. The response first arrives at CRBT AS-FE.
- (18-19) CRBT AS-FE and CRT AS-FE forward the "200 OK" response towards UE-A.
- (20) The UE-A sends "ACK (Session: UE-A Answer)" request towards UE-B.
- (21-22) The CRT AS-FE and CRBT AS-FE forward the "ACK" request towards UE-B.

6 Service flows for CRT service

6.1 Gateway model

6.1.1 CRT service by Gateway model

The Gateway model for CRT service without preconditions is illustrated in Figure 6-1.

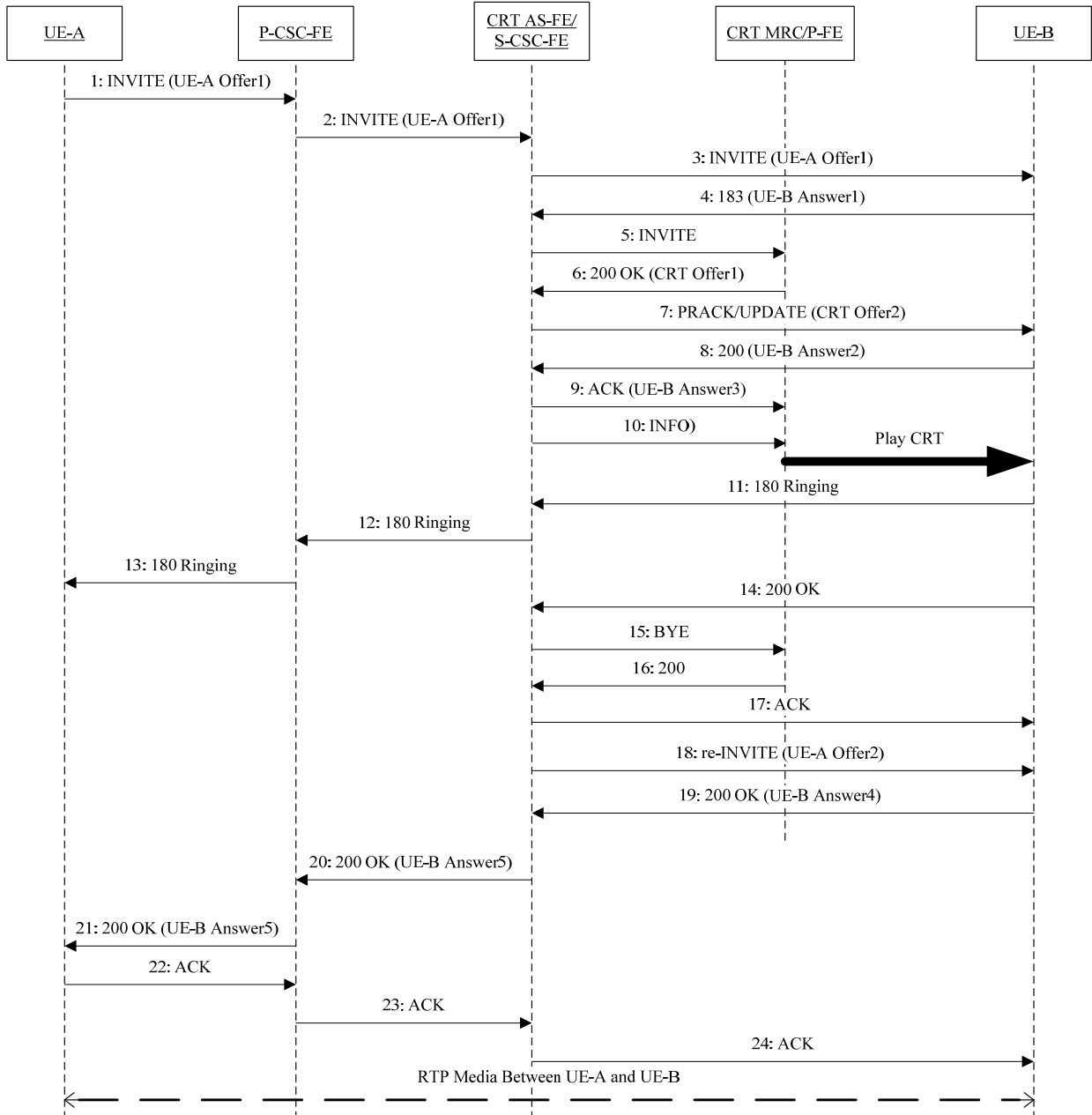

Figure 6-1 – CRT service flow using Gateway model

The details of the service flow in Figure 6-1 are described as follows:

- (1-2) UE-A sends "INVITE (UE-A Offer1)" to UE-B through P-CSC-FE. The "INVITE" is routed through the CRT AS-FE due to initial filter triggers on the S-CSC-FE.
- (3) The CRT AS-FE forwards the initial "INVITE" request to UE-B, to test whether the terminating UE can send out the SDP answer via an 18x response.
- (4) UE-B sends a "183 (UE-B Answer1)" reliable response towards UE-A. This message first arrives at CRT AS-FE.
- (5) The originating or terminating CRT AS-FE determines if the UE-A or the UE-B has subscribed to the CRT service, CRT AS-FE sends an "INVITE" request without SDP to CRT MRC/P-FE in order to fetch SDP offer from it.

- (6) The CRT MRC/P-FE sends a "200 OK (CRT Offer1)" response to CRT AS-FE.
- (7) The CRT AS-FE sends out CRT Offer2 SDP via "PRACK" or "UPDATE" request towards UE-B. The CRT Offer2 SDP is generated based on CRT Offer1 SDP.
- (8) UE-B sends a "200 (UE-B Answer2)" response towards UE-A. The message first arrives at CRT AS-FE.
- (9) The CRT AS-FE sends an "ACK" request with UE-B Answer3 SDP to CRT MRC/P-FE. The UE-B Answer3 SDP is generated based on UE-B Answer2 SDP.
- (10) The CRT AS-FE sends "INFO" request to CRT MRC/P-FE to indicate to it to start playing CRT media to UE-B.
- (11) UE-B rings and generates a "180 (Ringing)" response towards UE-A. The response first arrives at CRT AS-FE.
- (12)(13) CRT AS-FE forwards the "180 (Ringing)" response towards UE-A through P-CSC-FE. Step 11 can take place directly after step 2 or 4.
- (14) UE-B answers the call, and sends "200 OK" towards UE-A. The message first arrives at CRT AS-FE.
- (15) CRT AS-FE decides to stop playing CRT, then sends "BYE" request to CRT MRC/P-FE. This step can take place directly after step 16.
- (16) CRT MRC/P-FE stops playing CRT and sends "200 OK" response to CRT AS-FE.
- (17) CRT AS-FE sends "ACK" request towards UE-B.
- (18) CRT AS-FE sends "re-INVITE (UE-A Offer2)" request towards UE-B. The UE-A Offer2 SDP is generated based on UE-A Offer1 SDP.
- (19) UE-B sends "200 OK (UE-B Answer4)" response towards UE-A. This message first arrives at CRT AS-FE.
- (20) CRT AS-FE sends "200 OK (UE-B Answer5)" response to the initial "INVITE" request towards UE-A. The message first arrives at P-CSC-FE. P-CSC-FE may start the charging function. The UE-B Answer5 SDP is generated based on UE-B Answer4 SDP.
- (21) P-CSC-FE forwards the "200 OK (UE-B Answer5)" response towards UE-A.
- (22)(23) UE-A sends "ACK" request towards UE-B. This message arrives at CRT AS-FE.
- (24) CRT AS-FE forwards the "ACK" request towards UE-B. This step can take place directly after step 18.

6.1.2 CRT with preconditions

The Gateway model for CRT service with preconditions is illustrated in Figure 6-2.

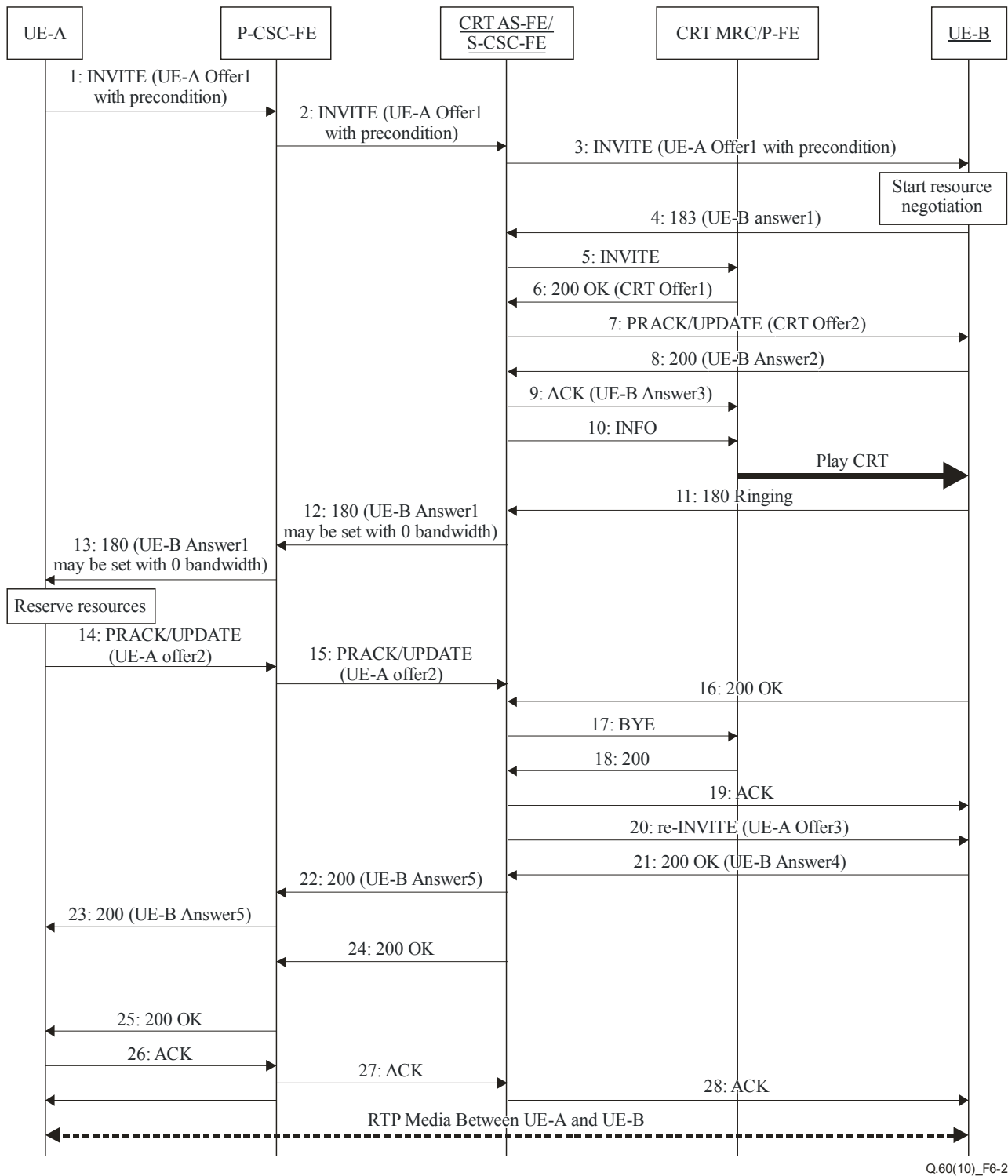

Figure 6-2 – CRT service flow by Gateway model in IMS with preconditions

The details of the service flow in Figure 6-2 are described as follows:

- (1)(2) UE-A sends "INVITE (UE-A Offer1)" towards UE-B through P-CSC-FE. The "INVITE" is routed through the CRT AS-FE due to initial filter triggers on the S-CSC-FE. The UE-A needs resource reservation (e.g., mobile phone), so the UE-A Offer1 SDP carries this with precondition.
- (3) The CRT AS-FE forwards the initial "INVITE" request towards UE-B. UE-B starts resource negotiation and resource reservation.

- (4) UE-B sends a reliable "183 (UE-B Answer1)" response towards UE-A. The "183 (UE-B Answer1)" first arrives at CRT AS-FE.
- (5) CRT AS-FE determines whether UE-B or UE-A has subscribed to the CRT service, then CRT AS-FE sends an "INVITE" request without SDP to CRT MRC/P-FE. This step can take place directly after step 14.
- (6) CRT MRC/P-FE sends "200 OK (CRT Offer1)" to CRT AS-FE.
- (7) CRT AS-FE sends out the CRT Offer2 SDP via a "PRACK" or "UPDATE" request towards the terminating side. The CRT Offer2 SDP is generated based on CRT Offer1 SDP.
- (8) UE-B sends a "200 OK (UE-B Answer2)" response towards UE-A. This message first arrives at CRT AS-FE.
- (9) The CRT AS-FE sends an "ACK (UE-B Answer3)" request to CRT MRC/P-FE. The UE-B Answer3 SDP is generated based on UE-B Answer2 SDP.
- (10) The CRT AS-FE sends "INFO" request to CRT MRC/P-FE to indicate to it to start playing CRT.
- (11) UE-B rings and sends a "180 (Ringing)" response towards UE-A. This response first arrives at CRT AS-FE.
- (12)(13) The CRT AS-FE sends a "180 (UE-B Answer1)" response towards UE-A, so that UE-A can determine how many resources are needed for regular media. In order not to make an RTCP error at the UE-A, CRT AS-FE may set all media types bandwidth to 0. Step 11 can happen directly after step 4.
- (14)(15) UE-A reserves resources according to SDP of UE-B Answer1 SDP, and sends out a new SDP offer as UE-A Offer2 towards UE-B via "PRACK" or "UPDATE" request. The message arrives at CRT AS-FE, and CRT AS-FE does not forward the "PRACK" or "UPDATE" request to UE-B.
- (16) UE-B answers the call, and sends "200 OK" towards UE-A. This message first arrives at CRT AS-FE. Before this step, there maybe some other messages sent by UE-B, e.g., "UPDATE", but all these messages are for resource negotiation between the UE-B and the CRT platform, so CRT AS-FE shall do nothing to the originating side.
- (17) CRT AS-FE decides to stop playing CRT, then sends "BYE" request to CRT MRC/P-FE. This step can take place directly after step 18.
- (18) CRT MRC/P-FE stops playing CRT and sends "200 OK" response to CRT AS-FE.
- (19) CRT AS-FE sends an "ACK" request towards UE-B.
- (20) Meanwhile, CRT AS-FE sends a "re-INVITE (UE-A Offer3)" request towards UE-B. The UE-A Offer3 SDP is generated based on UE-A Offer2 SDP.
- (21) UE-B sends a "200 OK (UE-B Answer4)" response towards UE-A. This message first arrives at CRT AS-FE.
- (22)(23) CRT AS-FE sends "200 OK (UE-B Answer5)" response to the "PRACK" or "UPDATE" request towards UE-A. The UE-B Answer5 SDP is generated based on UE-B Answer4 SDP.
- (24) CRT AS-FE sends "200 OK" response to the initial "INVITE" request towards UE-A. The message first arrives at P-CSC-FE. P-CSC-FE may start the charging function.
- (25) P-CSC-FE forwards the "200 OK" response towards UE-A.
- (26)(27) UE-A sends an "ACK" request towards UE-B. This message arrives at CRT AS-FE.
- (28) CRT AS-FE forwards the "ACK" request towards UE-B. This step can take place directly after step 20.

6.2 CRT service by Application Server model

When the originating side (calling party) initiates a session, it sends the "INVITE" to the network side. If the calling party has subscribed to the CRT service and the called party supports early media, the network side holds a CRT early session negotiation with the called party and then plays CRT to the called party.

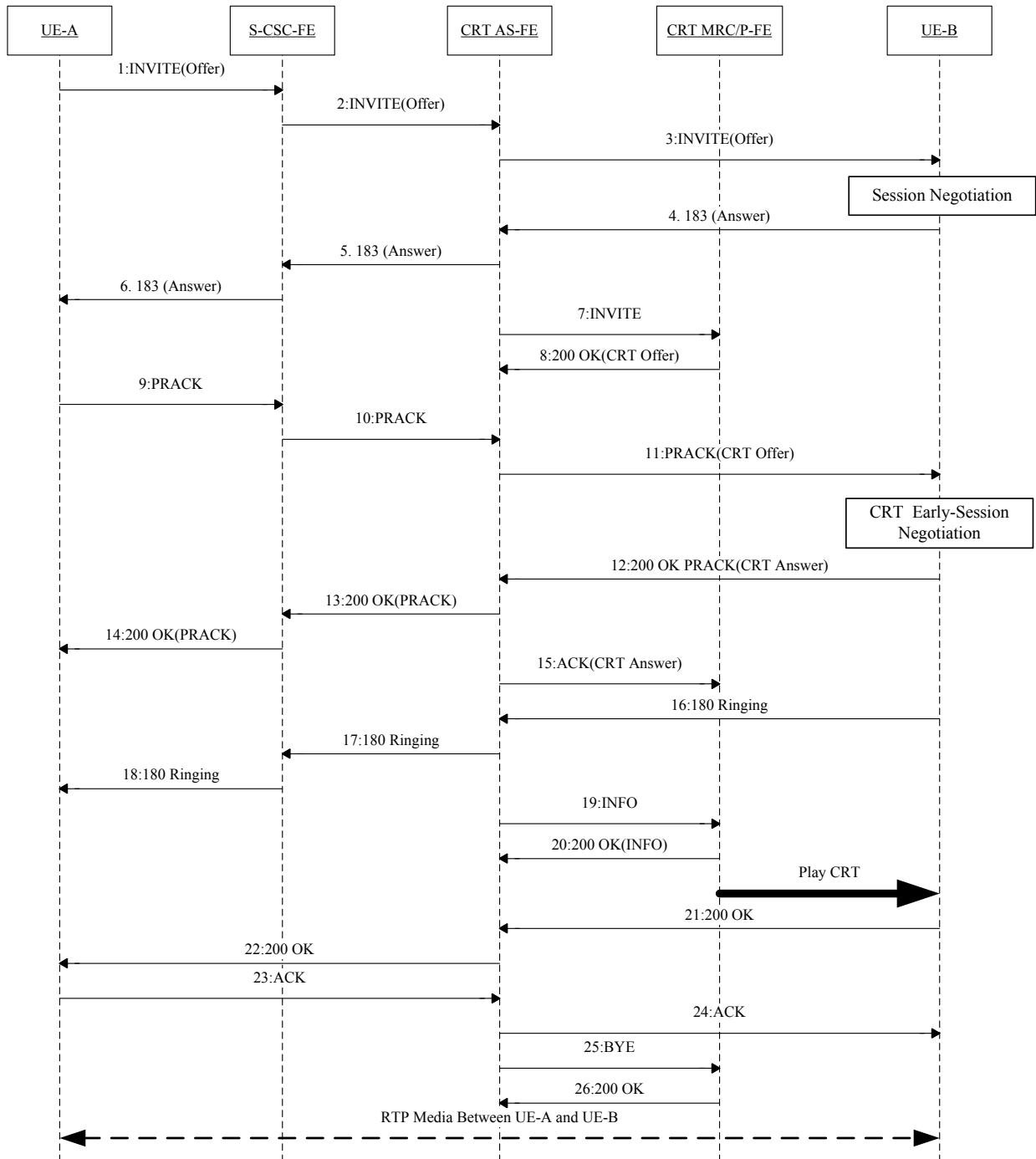

Figure 6-3 – CRT service flow using Application Server model

The details of the service flow in Figure 6-3 are described as follows:

- (1-2) UE-A sends "INVITE (offer)" to establish a call with UE-B. The "INVITE" is routed to CRT AS-FE due to initial filter criteria on the S-CSC-FE.
- (3) The CRT AS-FE sends "INVITE" to UE-B. The "INVITE" includes early-session option tag in its required header field.
- (4-6) UE-B generates a reliable "183 (answer)" response to UE-A.
- (7) The originating or terminating CRT AS-FE determines if the UE-A or UE-B has subscribed to the CRT service, respectively, and if UE-B supports early session. If it is the case, CRT AS-FE sends "INVITE" to CRT MRC/P-FE.
- (8) CRT MRC/P-FE sends "200 OK (CRT offer)" to CRT AS-FE in order to hold an early session negotiation with UE-B.
- (9-11) UE-A acknowledges the reliable provisional response.
- (12-14) UE-B sends "200 OK" to acknowledge PRACK from UE-A.
- (15) CRT AS-FE answers the "INVITE (CRT answer)".
- (16-18) UE-B sends "180 Ringing". The response first reaches the CRT AS-FE.
- (19) CRT AS-FE sends "INFO" to CRT MRC/P-FE.
- (20) CRT MRC/P-FE sends "200 OK" response to CRT AS-FE and then plays CRT to UE-B.
- (21-22) UE-B sends an "200 OK" answer to UE-A. The response first arrives at CRT AS-FE.
- (23-24) UE-A sends an "ACK" towards UE-B.
- (25) CRT AS-FE sends the SIP message "BYE" to CRT MRC/P-FE in order to tell CRT MRC/P-FE to stop playing CRT.
- (26) CRT MRC/P-FE sends "200 OK" to answer "BYE". The channel of RTP media between UE-A and UE-B is established.

6.3 CRT service by HTTP model

This service allows the user to allocate and send distinctive caller information to a called party. The distinctive caller information which is subscribed to by the calling party is stored and managed in the CRT service system. When the calling party initiates a session, CRT AS-FE sends the address (e.g., URL address) of the pre-selected CRT resource contents which are subscribed to by the calling party and stored in the CRT service system. The called party terminal downloads the related CRT contents from the CRT service system and then plays the CRT, until the called party answers.

As shown in Figure 6-4, the CRT system consists of UE-A (calling party terminal), CRT AS-FE, UE-B (called party terminal) and the CRT service system.

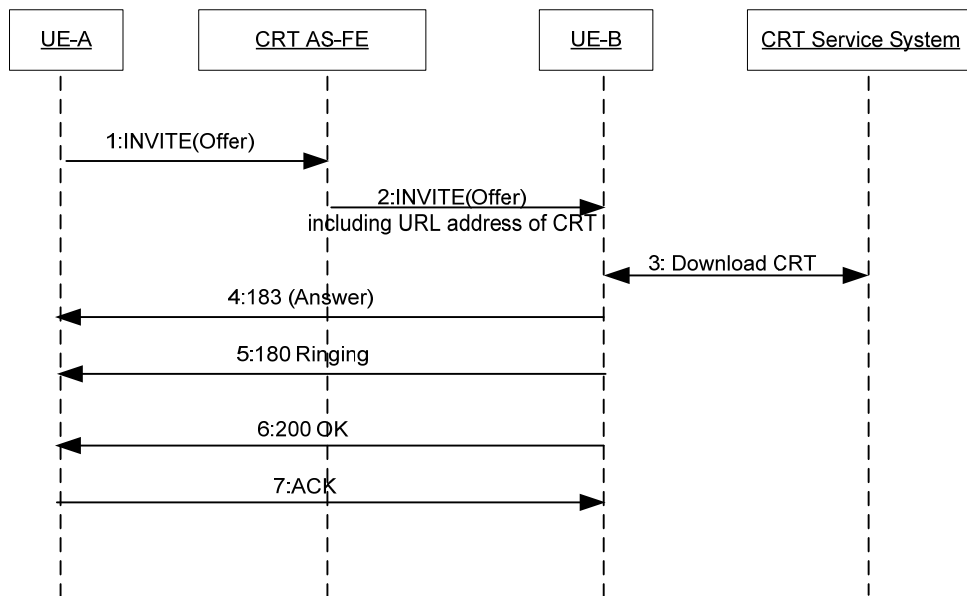

Figure 6-4 – CRT service flow using HTTP model

The details of CRT service flow in Figure 6-4 are described as follows:

- (1) UE-A sends "INVITE(offer)" to UE-B. The message first arrives at CRT AS-FE.
- (2) CRT AS-FE adds the information about URL address selected by the UE-A and/or the UE-B to "INVITE" and forwards the new "INVITE" to UE-B.
- (3) UE-B downloads the CRT from the CRT service system, according to the URL address of CRT resource.
- (4) UE-B sends "183 (answer)" to UE-A. CRT AS-FE forwards the message.
- (5) UE-B sends "180 ringing" to UE-A. Then UE-B terminal plays the CRT ringing downloaded from the CRT service system.
- (6) UE-B answers the call from UE-A and sends the "200 OK" to UE-A.
- (7) UE-A returns the response and then UE-B stops playing CRT ringing.

A normal session is established between UE-A and UE-B.

6.4 CRT service priority

When both the calling and called parties have configured CRT, the terminating AS-FE should have some priority mechanisms to determine which one will be invoked first. CRT priority can be configured by subscribers or operators.

As an example, Figure 6-5 shows the case where CRT priority is configured in the called party's CRT AS-FE. The called party's CRT AS-FE will check the CRT priority setting and decide which CRT should be played to the called party.

Following is an example service flow for CRT priority in the Application Server model where the terminating side has higher priority.

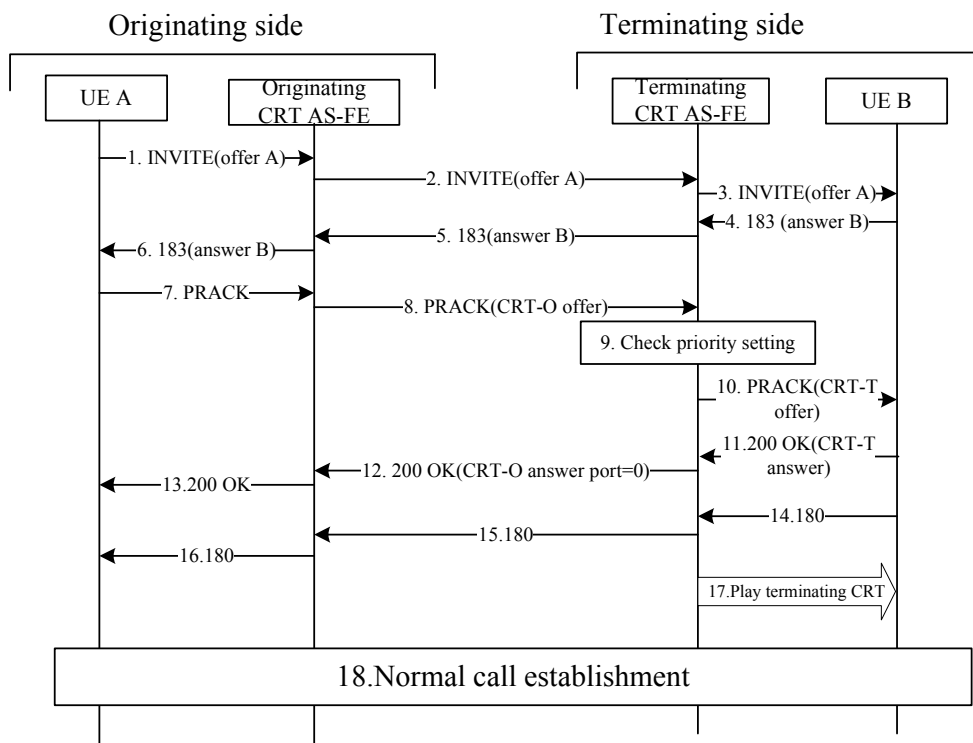

Figure 6-5 – Service flow for AS model with service priority

The details of the CRT service flow in Figure 6-5 are described as follows:

- (1-3) The UE-A sends "INVITE" to the terminating UE-B.
- (4-6) The UE-B replies with "183 (answer B) reliable response" towards the UE-A.
- (7) The UE-A sends "PRACK" request towards UE-B. The message first arrives at the originating CRT AS-FE.
- (8) The originating CRT AS-FE adds "CRT-O offer SDP" to "PRACK" and forwards the PRACK to the terminating CRT AS-FE.
- (9) The message arrives at the terminating CRT AS-FE, and the terminating CRT AS-FE checks the CRT priority setting.
- (10) Because the terminating CRT has higher priority, the terminating CRT AS-FE adds "CRT-T offer SDP" instead of "CRT-O offer" in "PRACK" and forwards "PRACK" to UE B.
- (11) UE-B completes the terminating CRT media negotiation and sends "200 OK" with "CRT-T answer SDP" towards UE-A.
- (12) The terminating CRT AS-FE sends "200 OK" towards the UE-A, which contains "CRT-O answer SDP" setting port to 0 to refuse the originating CRT media negotiation.
- (13) The originating CRT AS-FE receives the "200 OK", and it is aware of not providing the originating CRT to UE-B, and sends "200 OK" without "CRT-O answer SDP" to the UE-A.
- (14-17) UE-B sends "180 Ringing" to UE-A and the terminating CRT AS-FE plays the terminating CRT to the UE-B.
- (18) Finally, a normal call is established.

7 Interaction of CRBT and CRT services

7.1 Interaction between originating CRBT/CRT and terminating CRBT/CRT

When the calling and called parties register to both the CRBT and CRT services, the originating and terminating AS-FEs should have some priority mechanisms to determine which service will be invoked first. The service flows for CRBT and CRT service priority are described in clauses 5.5 and 6.4, respectively.

As shown in Figure 7-1, the CRT/CRBT application servers in the originating side are interacting with the CRT/CRBT application servers in the terminating side.

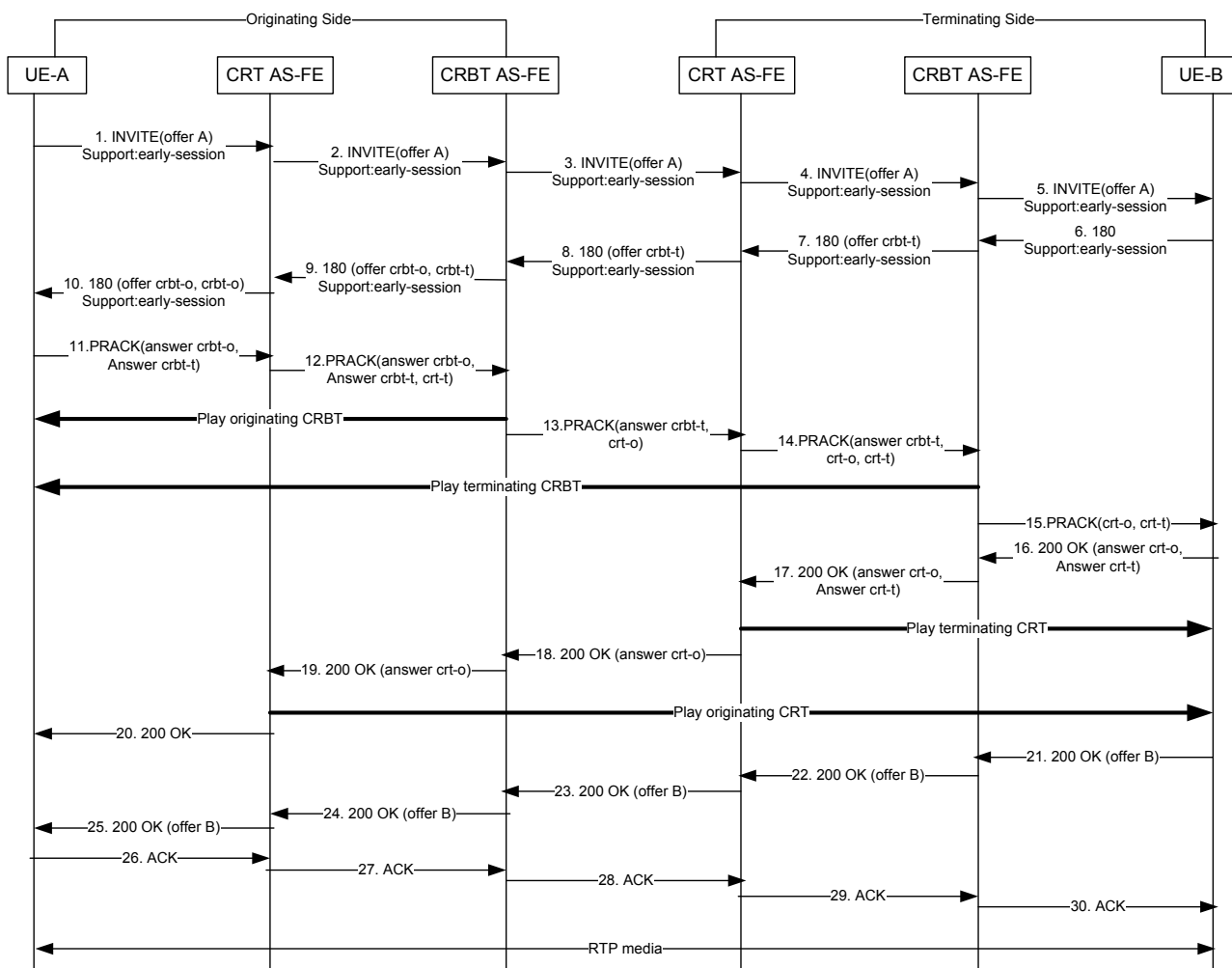

Figure 7-1 – Interaction between originating CRBT/CRT and terminating CRBT/CRT in AS model

The details of the service flow in Figure 7-1 are described as follows. The service flows between the CRBT/CRT servers and MRC-FE/P/I/S-CSCF-FE are omitted in this example.

- (1-5) UE-A sends "INVITE (offer)" to UE-B through CRT AS-FE/CRBT AS-FE in the originating side, and CRT AS-FE/CRBT AS-FE in the terminating side to establish a call with UE-B. The "INVITE" includes early-session option tag and 100rel option tag in its supported header field.
- (6) UE-B generates a "180 response" and sends it to CRBT AS-FE in the terminating side.
- (7-8) The terminating CRBT AS-FE adds its SDP(offer crbt-t) to the received "180 response" message and sends it to the originating side.

- (9-10) The originating CRBT AS-FE adds its SDP(offer crbt-o) to the received "180 response" message and sends it to UE-A.
- (11-13) UE-A sends "PRACK" (answer crbt-o, answer crbt-t) to CRT AS-FE/CRBT AS-FE in the originating side. After playing the originating CRBT, the originating CRBT AS-FE sends this "PRACK" message deleting SDP(answer crbt-o) to the terminating side.
- (14) The terminating CRT AS-FE adds SDP(crt-t) to "PRACK", and sends it to CRBT AS-FE.
- (15) After playing the terminating CRBT, CRBT AS-FE deletes SDP(answer crbt-t) and sends "PRACK" to UE-B.
- (16-17) UE-B sends "200 OK" to acknowledge that "PRACK" is received from UE-A.
- (18-19) After playing the terminating CRT, the terminating CRT AS-FE sends "200 OK" with SDP(answer crt-o) to the originating side.
- (20) After playing the originating CRT, CRT AS-FE sends "200 OK" to UE-A.
- (21-25) UE-B sends "200 OK" corresponding to initial "INVITE" with SDP(offer B) to UE-A.
- (26-30) UE-A sends "ACK" to UE-B and then RTP media can be exchanged between UE-A and UE-B.

7.2 Interaction between terminating CRBT and originating CRT by AS model

When the calling party initiates a session, it sends "INVITE" to the network side. If the called party has subscribed to the CRBT service and the calling party has subscribed to the CRT service, the network side holds a CRBT/CRT early session negotiation with the calling/called party and then plays CRBT to the calling party, and plays CRT to the called party.

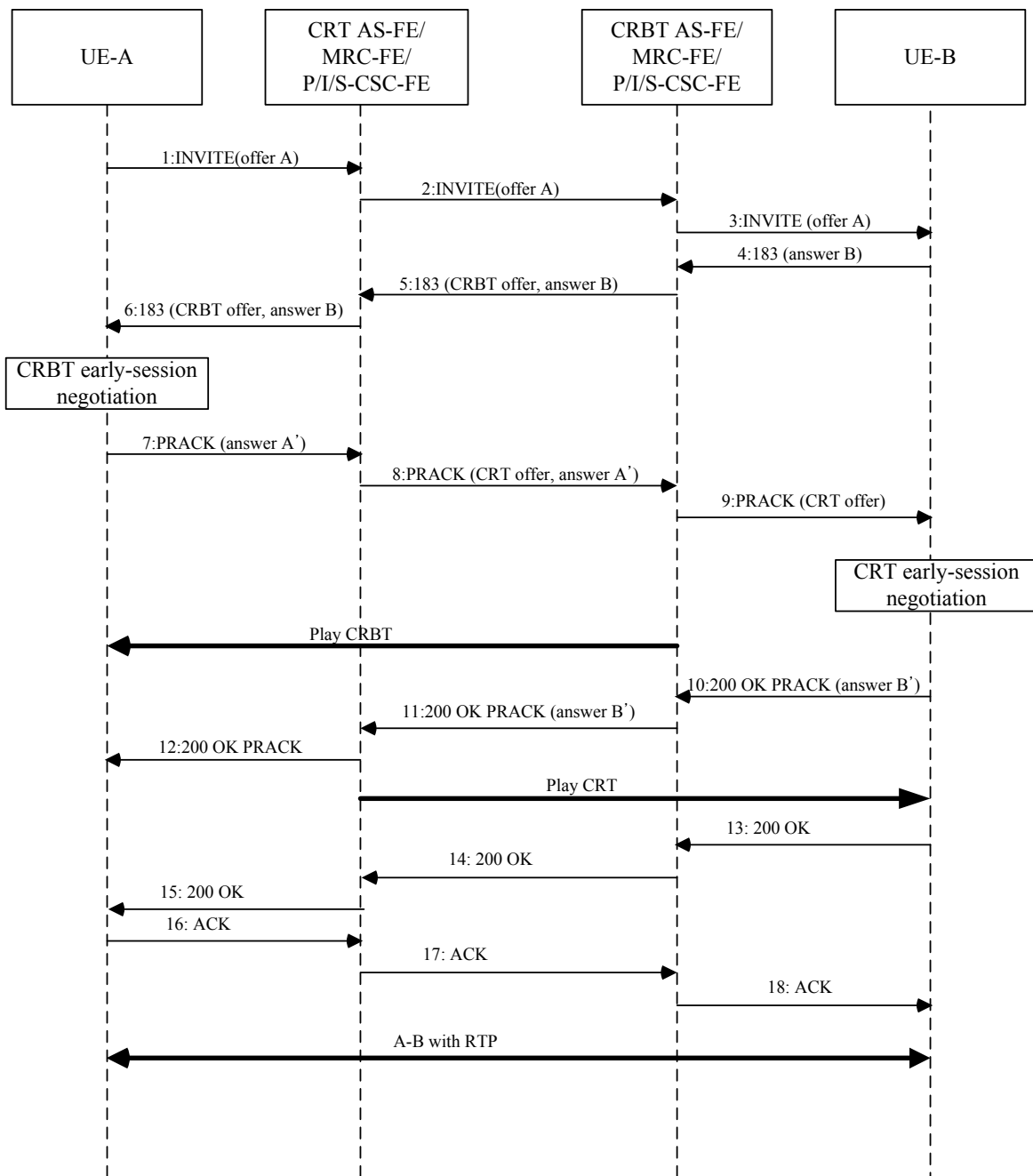

Figure 7-2 – Interaction between terminating CRBT and originating CRT in AS model

The details of the service flow in Figure 7-2 are described as follows:

- (1-3) UE-A sends "INVITE (offer A)" to UE-B through CRT AS-FE and CRBT AS-FE to establish a call with UE-B. The "INVITE" includes early-session option tag and 100rel option tag in its supported header field.
- (4) UE-B generates a reliable "183 (answer B)" response to UE-A. The "183 (answer B)" first arrives at CRBT AS-FE/MRC-FE/P/I/S-CSC-FE.
- (5) CRBT AS-FE determines that UE-A supports early session according to the "INVITE" and sends "183 (CRBT offer, answer B)" response to CRT AS-FE/MRC-FE/P/I/S-CSC-FE.
- (6) CRT AS-FE/MRC-FE/P/I/S-CSC-FE forwards "183 (CRBT offer, answer B)" to UE-A.
- (7-9) UE-A sends "PRACK (answer A)" to UE-B through the network.

- (10-12) UE-B sends "200 OK" to acknowledge "PRACK" from UE-A.
- (13-18) UE-B sends "200 OK" response to UE-A for the connection. UE-A sends "ACK" to UE-B and then RTP media between UE-A and UE-B is established.

SERIES OF ITU-T RECOMMENDATIONS

Series A	Organization of the work of ITU-T
Series D	General tariff principles
Series E	Overall network operation, telephone service, service operation and human factors
Series F	Non-telephone telecommunication services
Series G	Transmission systems and media, digital systems and networks
Series H	Audiovisual and multimedia systems
Series I	Integrated services digital network
Series J	Cable networks and transmission of television, sound programme and other multimedia signals
Series K	Protection against interference
Series L	Construction, installation and protection of cables and other elements of outside plant
Series M	Telecommunication management, including TMN and network maintenance
Series N	Maintenance: international sound programme and television transmission circuits
Series O	Specifications of measuring equipment
Series P	Terminals and subjective and objective assessment methods
Series Q	Switching and signalling
Series R	Telegraph transmission
Series S	Telegraph services terminal equipment
Series T	Terminals for telematic services
Series U	Telegraph switching
Series V	Data communication over the telephone network
Series X	Data networks, open system communications and security
Series Y	Global information infrastructure, Internet protocol aspects and next-generation networks
Series Z	Languages and general software aspects for telecommunication systems