



INTERNATIONAL TELECOMMUNICATION UNION

**ITU-T**

TELECOMMUNICATION  
STANDARDIZATION SECTOR  
OF ITU

**Series Q**  
**Supplement 35**  
(12/2000)

SERIES Q: SWITCHING AND SIGNALLING

---

**Technical report TRQ.2500: Signalling  
requirements for the support of the call bearer  
control interface (CS-1)**

ITU-T Q-series Recommendations – Supplement 35

(Formerly CCITT Recommendations)

---

ITU-T Q-SERIES RECOMMENDATIONS  
**SWITCHING AND SIGNALLING**

SIGNALLING IN THE INTERNATIONAL MANUAL SERVICE	Q.1–Q.3
INTERNATIONAL AUTOMATIC AND SEMI-AUTOMATIC WORKING	Q.4–Q.59
FUNCTIONS AND INFORMATION FLOWS FOR SERVICES IN THE ISDN	Q.60–Q.99
CLAUSES APPLICABLE TO ITU-T STANDARD SYSTEMS	Q.100–Q.119
SPECIFICATIONS OF SIGNALLING SYSTEMS No. 4 AND No. 5	Q.120–Q.249
SPECIFICATIONS OF SIGNALLING SYSTEM No. 6	Q.250–Q.309
SPECIFICATIONS OF SIGNALLING SYSTEM R1	Q.310–Q.399
SPECIFICATIONS OF SIGNALLING SYSTEM R2	Q.400–Q.499
DIGITAL EXCHANGES	Q.500–Q.599
INTERWORKING OF SIGNALLING SYSTEMS	Q.600–Q.699
SPECIFICATIONS OF SIGNALLING SYSTEM No. 7	Q.700–Q.799
Q3 INTERFACE	Q.800–Q.849
DIGITAL SUBSCRIBER SIGNALLING SYSTEM No. 1	Q.850–Q.999
PUBLIC LAND MOBILE NETWORK	Q.1000–Q.1099
INTERWORKING WITH SATELLITE MOBILE SYSTEMS	Q.1100–Q.1199
INTELLIGENT NETWORK	Q.1200–Q.1699
SIGNALLING REQUIREMENTS AND PROTOCOLS FOR IMT-2000	Q.1700–Q.1799
BROADBAND ISDN	Q.2000–Q.2999

*For further details, please refer to the list of ITU-T Recommendations.*

## **Supplement 35 to ITU-T Q-series Recommendations**

### **Technical report TRQ.2500: Signalling requirements for the support of the call bearer control interface (CS-1)**

#### **Summary**

This Supplement specifies the signalling requirements for the support of the BICC Call Bearer Control Interface (CS-1).

#### **Source**

Supplement 35 to ITU-T Q-series Recommendations was prepared by ITU-T Study Group 11 (2001-2004) and approved under the WTSA Resolution 5 procedure on 6 December 2000.

## FOREWORD

The International Telecommunication Union (ITU) is the United Nations specialized agency in the field of telecommunications. The ITU Telecommunication Standardization Sector (ITU-T) is a permanent organ of ITU. ITU-T is responsible for studying technical, operating and tariff questions and issuing Recommendations on them with a view to standardizing telecommunications on a worldwide basis.

The World Telecommunication Standardization Assembly (WTSA), which meets every four years, establishes the topics for study by the ITU-T study groups which, in turn, produce Recommendations on these topics.

The approval of ITU-T Recommendations is covered by the procedure laid down in WTSA Resolution 1.

In some areas of information technology which fall within ITU-T's purview, the necessary standards are prepared on a collaborative basis with ISO and IEC.

## NOTE

In this publication, the expression "Administration" is used for conciseness to indicate both a telecommunication administration and a recognized operating agency.

## INTELLECTUAL PROPERTY RIGHTS

ITU draws attention to the possibility that the practice or implementation of this publication may involve the use of a claimed Intellectual Property Right. ITU takes no position concerning the evidence, validity or applicability of claimed Intellectual Property Rights, whether asserted by ITU members or others outside of the publication development process.

As of the date of approval of this publication, ITU had not received notice of intellectual property, protected by patents, which may be required to implement this publication. However, implementors are cautioned that this may not represent the latest information and are therefore strongly urged to consult the TSB patent database.

© ITU 2001

All rights reserved. No part of this publication may be reproduced or utilized in any form or by any means, electronic or mechanical, including photocopying and microfilm, without permission in writing from ITU.

## CONTENTS

	<b>Page</b>
1 Scope .....	1
2 References.....	1
3 Bibliography.....	2
4 Abbreviations .....	2
5 Guidelines for protocol development .....	3
6 Object Reference Model .....	3
7 Definitions.....	4
7.1 Object and Call Model Definitions .....	4
7.2 Call Model .....	5
7.3 Requests and Responses .....	7
7.3.1 Definition of Requests and Responses.....	8
7.4 Definition of Signalling Flow Objects.....	10
7.4.1 Nomenclature .....	10
7.4.2 Signalling Request and Response Primitives .....	10
7.4.3 Signalling Objects.....	12
8 Signalling Procedures between the CSF and the BIWF (CBC interface) .....	16
8.1 Successful Establishment.....	17
8.1.1 Prepare_BNC_Notify.....	17
8.1.2 Establish_BNC_Notify .....	20
8.1.3 Reserve_BNC.....	23
8.1.4 Cut_Through .....	24
8.1.5 Modification of Bearer Characteristics .....	28
8.1.6 Tunnel .....	34
8.2 Reuse of idle Bearers .....	36
8.2.1 Establish BNC .....	36
8.2.2 Reuse_IDLE .....	37
8.3 Bearer Topology.....	38
8.3.1 Isolate.....	38
8.3.2 Join.....	39
8.3.3 Change Connection Topology.....	40
8.4 Echo Cancellor Control.....	42
8.4.1 Echo Cancellor .....	42
8.5 Unsuccessful BNC Establishment.....	43
8.5.1 Unsuccessful BNC Establishment with notification on BNC establishment	43
8.6 Bearer Initiated Release .....	45

	<b>Page</b>
8.7	Media Content Insertion ..... 47
8.7.1	Insert Tone ..... 47
8.7.2	Insert Digit ..... 49
8.7.3	Insert Announcement..... 51
8.8	Media Content Detection ..... 54
8.8.1	Detect Digit ..... 54
8.9	Cut BNC ..... 55
8.9.1	Release ..... 56
8.10	General Procedures..... 57
8.10.1	BIWF Service Changes..... 57
8.10.2	CCU Service Change ..... 66
8.10.3	BIWF/Termination Unavailable ..... 70
8.10.4	Audit of BIWF Service Capabilities..... 71
9	Outage and Recovery..... 75
9.1	CCU Initiated ..... 75
9.1.1	CCU outage ..... 75
9.1.2	CCU Recovery ..... 75
9.2	BIWF Initiated ..... 75
9.2.1	BIWF outage ..... 75
9.2.2	BIWF RECOVERY..... 75

# Supplement 35 to ITU-T Q-series Recommendations

## Technical report TRQ.2500: Signalling requirements for the support of the call bearer control interface (CS-1)

### 1 Scope

This Supplement provides requirements for the support of the Call Bearer Control Interface. Its scope is limited to the interface between the CSF and the BIWF and the requirements to ensure that the associated protocols at the call control and bearer control levels can provide functionality across an ATM or IP networks for BICC Capability Set 2 (CS-2).

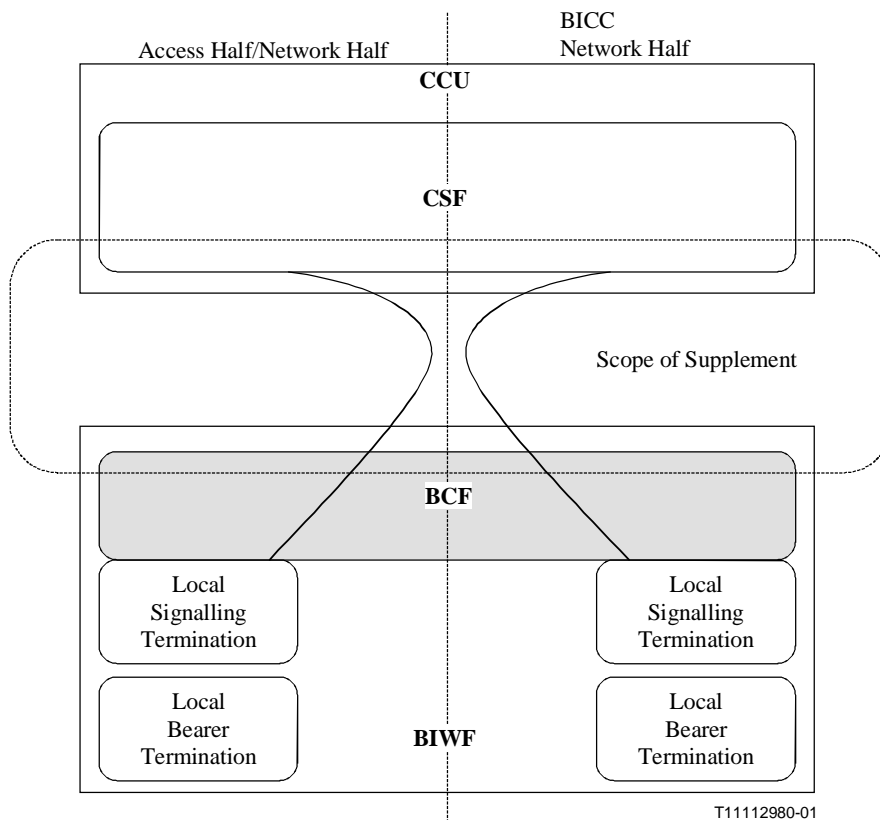

**Figure 1 – Scope of Supplement**

The main body of the recommendation details the requirements for the BICC Network Half of the CBC interface. Requirements for the Access Half and Non-BICC Network Half of the interface are contained in associated annexes.

### 2 References

- [1] ITU-T H.248 (2000), *Gateway control protocol*.

### 3 Bibliography

- [2] ITU-T Q-series Supplement 32 (2000), *Technical report TRQ.2141.1: Signalling requirements for the support of narrowband services via Broadband Transport Technologies, CS-2 – Signalling Flows.*
- [3] ITU-T Q-series Supplement 7 (1999), *Technical report TRQ.2001: General aspects for the development of unified signalling requirements.*

### 4 Abbreviations

This Supplement uses the following abbreviations:

AAL	ATM Adaptation Layer
ATM	Asynchronous Transfer Mode
BCF	Bearer Control Function
BCS	Bearer Control Segment
BIT	Bearer Information Transport
BIWF	Bearer Interworking Function
BNC	Backbone Network Connection
BNCL	Backbone Network Connection Link
CBC	Call and Bearer Control
CCA-ID	Call Control Association Identifier
CCU	Call Control Unit
CMN	Call Mediation Node
CS	Capability Set
CSF	Call Service Function
CSM	Call State Machine (O – Originating / T – Terminating)
DTMF	Dual Tone Multi Frequency
GSN	Gateway Serving Node
IP	Internet Protocol
ISN	Interface Serving Node
LP	Logical Port
MOD	Modify
MOV	Move
NOT	Notify
QoS	Quality of Service
SN	Serving Node
SUB	Subtract
TDM	Time Division Multiplex
TMR	Transmission Medium Requirement
TSN	Transit Serving Node



### 5 Guidelines for protocol development

Even though this Supplement's scope is signalling requirements, this clause is provided as guidance as to how these Requirements may be realised in protocol development.

- The H.248 core protocol has been chosen as the basis for the Call Bearer Control Protocol.
- A Message can contain several H.248 Transactions that may contain several Commands. Several instructions/descriptors in the one command should relate to one termination.
- NotificationRequested should relate to an eventDescriptor/eventBufferDescriptor in ITU-T H.248.
- NotificationRequested could be provisioned on terminations so that any bearer event is notified: i.e. An event called "BNC" with parameters "established, rejected, modified, released".
- The interaction between an event and a tone/announcement should be considered. This detection of an event may result in the immediate stopping of a signal.

### 6 Object Reference Model

Figure 2 shows the composition of the object reference model. Refer to 7.1 for the definition of each of the functional entities.

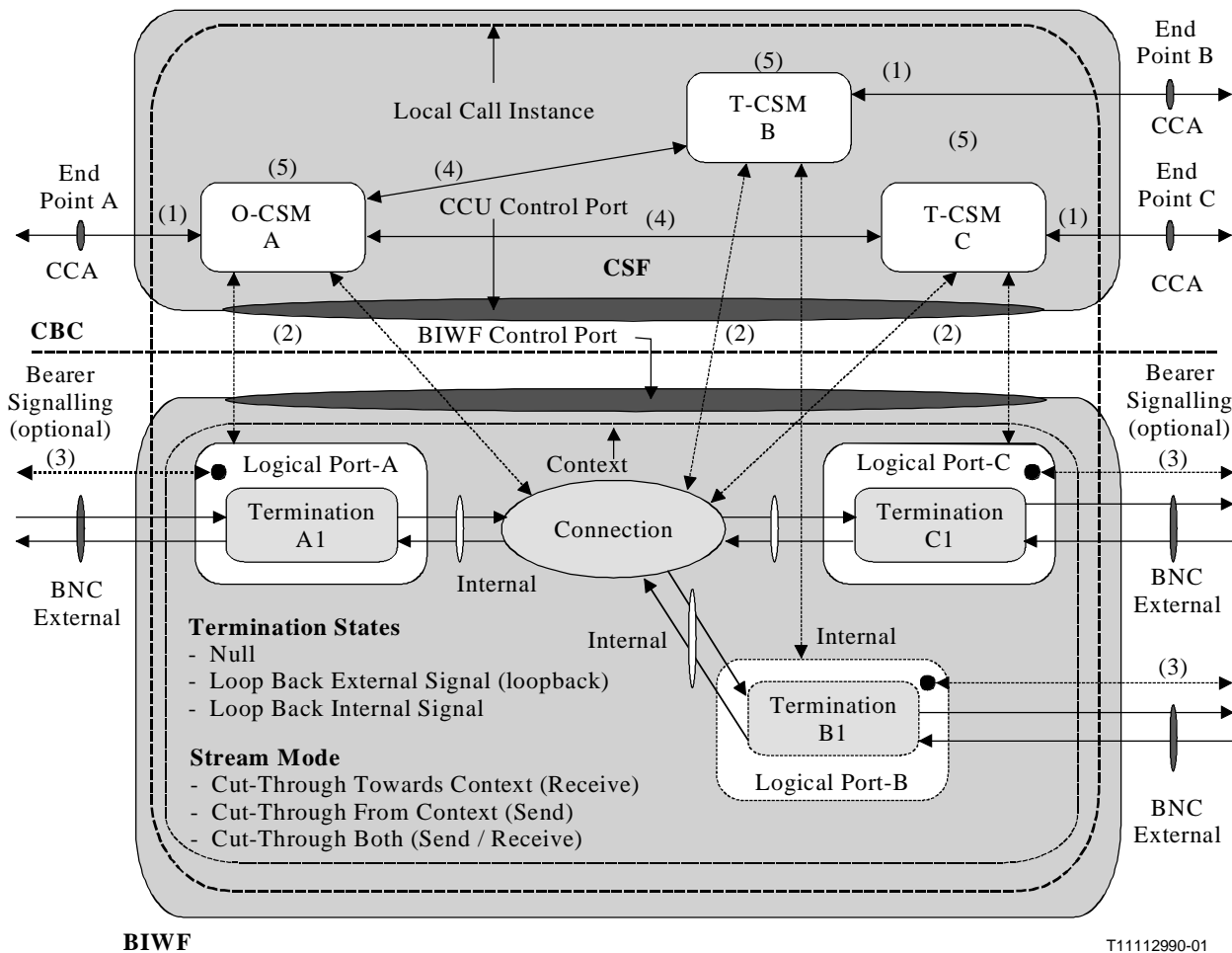

Figure 2 – CBC Object Reference Model

## 7 Definitions

### 7.1 Object and Call Model Definitions

**7.1.1 Call Bearer Control (CBC):** Is the interface between the Call Serving Function and the Bearer Control Function.

**7.1.2 connection:** The connection is a logical entity representing the connection topology within a single context in the BIWF. The topology of a connection can be implied by assigning streams between terminations and/or through manipulation of the context topology.

**7.1.3 context:** The context is the association between one or more terminations. The BIWF creates a context and assigns a unique context identity (contextID) to it. A context cannot exist without at least one termination. When a context contains a single termination, this context may or may not contain a connection. Contexts containing a connection always will be associated with a local call instance, while a context containing no connection will not be associated with a Local Call Instance. See 6.1/H.248 [1].

**7.1.4 end point:** An end point defines the remote call or call & bearer signalling entity communicating with the CSF. This entity may be requesting actions associated with a line, trunk, or special resource function. In the object model it defines the point terminating the Call Signalling.

**7.1.5 stream:** A Stream specifies the parameters of a single bi-directional media stream/user data flow and is represented by a CSM assigned StreamID. See 7.1.6/H.248 [1].

**7.1.6 stream mode:** In the object model it describes the mode of the termination ie. Send, receive, send and receive. See 7.1.7/H.248 [1].

**7.1.7 termination:** A Termination is a logical entity in a BIWF that sources and/or sinks media and/or control streams. In BICC a termination sources and/or sinks a single media and/or control streams. A Termination is described by a number of characterizing Properties. Terminations have unique identities (TerminationIDs). These objects can be created "On Demand" or may be provisioned.

**7.1.8 termination state:** Defines the Service state of the termination, e.g. In-service, Out-of-service. In the object model it describes the mode of the termination, i.e. Null, Loop Back External Signal, Loop Back Internal Signal. See Termination State 7.1.5/H.248 [1] for the service state. For the mode of a stream, i.e. loopback, see 7.1.7/H.248 [1].

**7.1.9 logical port:** Defines a logical grouping of one or more media terminations and one or more signalling termination. A Logical Port may be associated with a bearer control signalling end point (indicated by reference [3]).

**7.1.10 Call State Machine (CSM):** Defines a CSF control entity that terminates call or call & bearer peer to peer signalling. The prefix "O" or "T" represents the interrelationship of CSMs within the Local Call Instance. The "O" represents the control entity receiving an external service request, while the "T" is the control entity forwarding the request to another CSF.

**7.1.11 local call instance:** Defines the call control scope within a Serving Node. A Local Call Instance may have ZERO or more Contexts within its scope. The CSF creates and deletes local call instances. When a Local Call Instance is destroyed, each BIWF will place the termination within the Local Call Instance scope, into a NULL context or delete the termination.

**7.1.12 CCU control port:** Defines the signalling port associated with the CSF which is used to interact with the BIWF over the CBC Interface. This object has a unique address within the network service supplier domain.

**7.1.13 BIWF control port:** Defines the signalling port associated with the BIWF which is used to interact with the CCU over the CBC interface. This object has a unique address within the network service supplier domain.

**7.1.14 Call Control Association (CCA):** Defines the peer to peer signalling association between Call, and Call & Bearer state machines located in different physical entities.

**7.1.15 Backbone Network Connection (BNC):** Represents the edge to edge transport connection within the backbone network, consisting of one or more Backbone Network Connection Links (BNCL). The Backbone Network Connection represents a segment of the end to end Network Bearer Connection (NBC).

## 7.2 Call Model

The Call model for use in describing the signalling requirements describes the logical entities, or objects, within the BIWF that can be controlled by the CSF. The main abstractions used in the call model are local call instances, contexts, terminations and streams. Figure 3 shows the Multiple BIWF Call Model. A Local Call instance can span several BIWFs. Each BIWF may have multiple contexts associated with the same Local Call Instance.

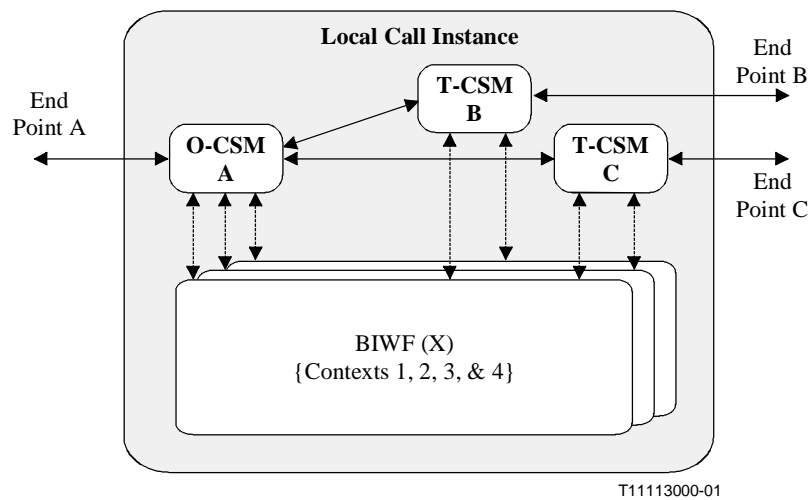

**Figure 3 – Multiple BIWF Call Model**

Figure 4 illustrates the call model from the perspective of a single BIWF in order to further define the interrelationships of the Local Call Reference and the Contexts within its scope.

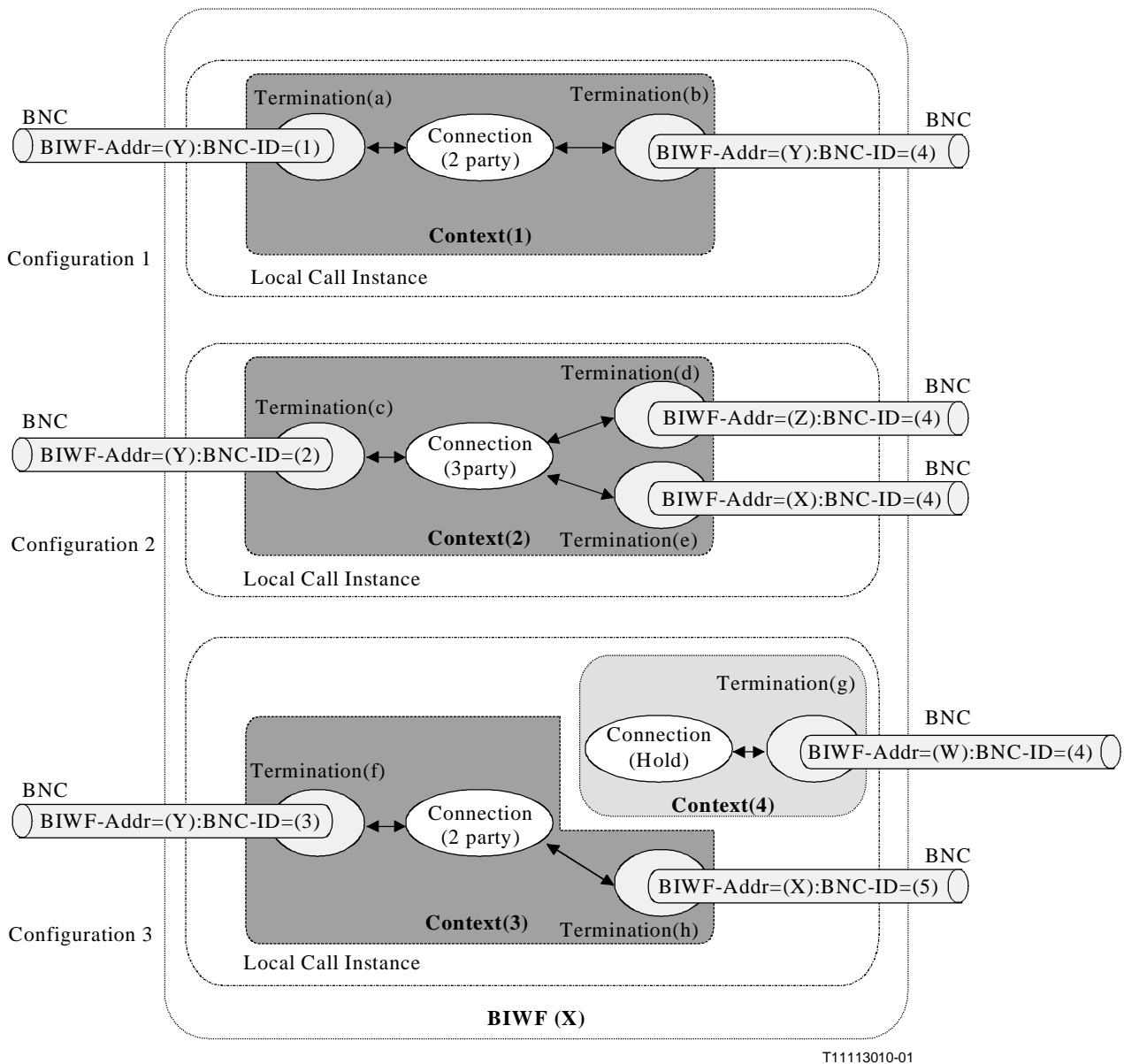

**Figure 4 – Call Model**

Figure 4 represents the CBC interface Call Model for a single BIWF configuration. It is based on the Connection Model in clause 6/H.248 [1] and depicts 3 connection configurations contained in the BIWF at one particular instant.

Terminations in each of the configurations have different Termination (Identities) as a termination can only reside in one context at any particular point in time but may be moved to another context and therefore must retain its BIWF unique identity. Streams can have the same identity across several contexts as the Context Identifier makes it globally unique. BNCs have a unique identity within the scope of the BIWF.

The stream represents the internal connection in the BIWF, whereas the BNC represents connections external to the BIWF. To maintain uniqueness a combination of the BIWF-Addr and the BNC-ID is used to identify the bearer connection.

The definition of the Connection Configuration/Topology Types is defined in Annex A of ITU-T Q-series Supplement 32 [2].

**Configuration 1** depicts a basic 2-party connection configuration. *Termination(a)* representing the A endpoint and *Termination(b)* representing the B endpoint. The *Context(1)* provides the association between the terminations (a) and (b). The *connection(2 party)* is a logical entity which represents the connection configuration. The assignment of *Stream(1)* on Termination(a)&(b) defines the connection as 2 party. The actual connection configuration communication is established by a direct interaction with the CSF who is the Local Call Instance Owner. The connection topology may be either a Type 1 Uni-Directional or a Type 1 Bi-Directional connection.

**Configuration 2** depicts a 3-party connection configuration. *Termination(c)* representing the A endpoint, *Termination(d)* representing the B endpoint and *Termination(e)* representing the C endpoint. The *Context(2)* provides the association between the terminations (c), (d) and (e). The *connection(3 party)* is a logical entity which represents the connection configuration. The assignment of *Stream(1)* on Termination(c),(d)&(e) defines the connection as a 3 party. The actual connection configuration is established by a direct interaction with the CSF who is the Local Call Instance Owner. The connection topology may be a Type 2, Type 3, Type 4, Type 5, or a three party bridge connection.

**Configuration 3** depicts a held-call scenario. *Termination(f)* representing the A endpoint, *Termination(g)* representing the B endpoint and *Termination(h)* representing the C endpoint. The *Context(3)* provides the association between the terminations (f) and (h). The *Context(4)* provides the association between the connection which is in the hold communication state and the termination which is on hold (*Termination(g)*). The *connection(2 party)* is a logical entity which represents the connection configuration. The assignment of *Stream(1)* on Termination(f)&(h) means the connection is 2 party. Note that context 3 and 4 must be in the scope of the same Local Call Instance and within the same BIWF. This implies that the end point and possibly its associated termination must be moved to the Local Call Instance containing Context 4.

The Call Model defines the topology of connections and defines the capabilities that are defined on terminations. The functions to be performed by BIWF are implicitly given by these capabilities on the termination. The CSM indicates that a connection oriented transport service or a connectionless transport service is to be used. It also indicates the Bearer Service Characteristics that are to be supported by the termination. The BIWF determines the BNC Characteristics associated with *Termination (a)* and the BNC Characteristics of *Termination (b)* and if needed establishes the transcoding option needed to allow interworking of the incoming – outgoing stream information. Figure 5 gives an example of this concept.

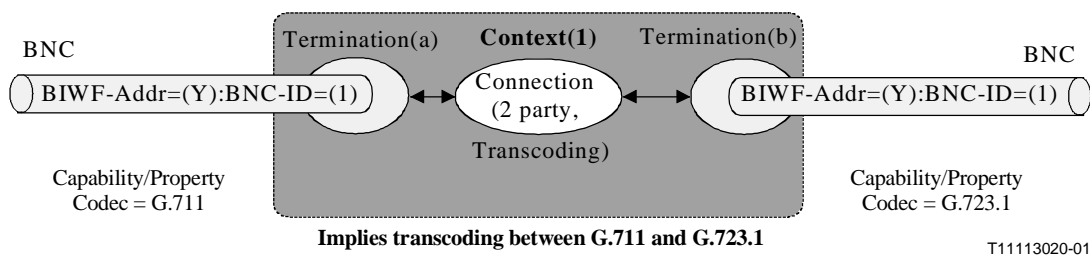

**Figure 5 – Call Model Definition of functions**

### 7.3 Requests and Responses

The information flow requests and responses shown in Table 1 – **CBC commands** below are used to manipulate the logical entities within the call model.

A list of Requests and responses are contained in the following table. The direction specifies from which entity (CSF/BIWF) the information flow is initiated. These Requests and responses are based on those contained in ITU-T H.248.

**Table 1 – CBC commands**

Requests and Responses	Direction	
	CSM to BIWF	BIWF to CSM
ADD.req	✓	
ADD.resp		✓
MOD.req	✓	
MOD.resp		✓
MOV.req	✓	
MOV.resp		✓
SUB.req	✓	
SUB.resp		✓
NOTIFY.ind		✓
NOTIFY.resp	✓	
AUD_VAL.req	✓	
AUD_VAL.resp		✓
AUD_CAP.req	✓	
AUD_CAP.resp		✓
SERVICECHANGE.req	✓	✓
SERVICECHANGE.resp	✓	✓

### 7.3.1 Definition of Requests and Responses

This clause gives a brief outline of the requests and responses associated with of the CBC interface and how they are used in BICC network signalling applications. See clause 7/H.248 [1] for a complete description of the behavior of these requests and responses. Requests and responses may be sent at the same time. For example: an ADD.resp and a NOTIFY.ind.

#### 7.3.1.1 ADD.req

The ADD command is used to add a Termination/s to a Context. It may also be used to modify default properties/capabilities or initiate new properties on the termination/s being added. See 7.2.1/H.248 [1].

#### 7.3.1.2 ADD.resp

The ADD response is used to indicate successful or unsuccessful completion of the addition of a Termination to a Context.

#### 7.3.1.3 MOD.req

The MODify command is used to modify the properties of an existing Termination. See 7.2.2/H.248 [1].

#### 7.3.1.4 MOD.resp

The MODify response is used to indicate successful or unsuccessful completion of the modification of an existing termination.

### **7.3.1.5 MOV.req**

The MOVE request is used to move a termination/s from one Context to another Context. This has the effect of breaking the association between the termination and the connection in the original context and establishing a new association between the termination and the connection in the new context. It may also be used to modify properties/capabilities of a termination whilst moving the termination. See 7.2.4/H.248 [1].

### **7.3.1.6 MOV.resp**

The MOVE response is used to indicate successful or unsuccessful completion of the move of an existing termination to another context.

### **7.3.1.7 SUB.req**

The SUBtract is used to remove a termination from a Context. This action places the termination into a null context if the termination is provisioned otherwise the termination is deleted. See 7.2.3/H.248 [1].

### **7.3.1.8 SUB.resp**

The SUBtract response is used to indicate successful or unsuccessful completion of the subtraction of a termination from a context.

### **7.3.1.9 NOTIFY.ind**

The NOTify request is used to indicate when an external action associated with the specified termination has been detected by the BIWF. See 7.2.7/H.248 [1].

### **7.3.1.10 NOTIFY.resp**

The NOTify response is used by the CSF to acknowledge the receipt of the detected action request from the BIWF.

### **7.3.1.11 AUDITVALUE.req**

The AUDITVALUE request is used to find the current value of properties associated with a termination or group of terminations. See 7.2.5/H.248 [1].

### **7.3.1.12 AUDITVALUE.resp**

The AUDITVALUE response is used to deliver the current value of properties associated with a termination or a group of terminations.

### **7.3.1.13 AUDITCAPABILITY.req**

The AUDITCAPABILITY request is used to determine the values of properties (which represent a capability) associated with a termination or group of terminations. See 7.2.6/H.248 [1].

### **7.3.1.14 AUDITCAPABILITY.resp**

The AUDITCAPABILITY response is used to deliver the current capabilities associated with a termination or a group of terminations.

### **7.3.1.15 SERVICECHANGE.req**

The SERVICECHANGE.req is used to indicate when a termination or a group of terminations and/or resources associated with the termination have changed state. For example when a termination, Logical port, group of logical ports or BWIF goes out of service. See 7.2.8/H.248 [1].

### 7.3.1.16 SERVICECHANGE.resp

The SERVICECHANGE.resp is used to acknowledge that a termination or group of terminations, have changed state. See 7.2.8/H.248 [1].

## 7.4 Definition of Signalling Flow Objects

### 7.4.1 Nomenclature

- The CSM uses  $X="?"$  to indicate that the CSM requests the BIWF to provide an appropriate value for signalling object (X).
- The  $X=Y$  is used to indicate that the CSM/BIWF should set the signalling object(X) to value (Y).
- Notification Requested "zzz" is used to request the BIWF to notify the CSM when event "zzz" has been detected.
- Signal Requested "www" is used to request the BIWF to send a signal "www" on the specified termination.
- Event = "vvv" is used by the BIWF to indicate that a particular event "vvv" has been detected on a termination.
- (... , Primitive) is used to indicate that this primitive can be sent in conjunction with another primitive.
- $X = Y / Z$ , is used to indicate a choice for X: Y or (exclusive) Z.
- $X = Y + Z$ , is used to indicate a choice for X: Y and/or (inclusive) Z.
- $X = Y \& Z$ , is used to indicate: Y and Z.
- Brackets () are used to indicate boolean priority e.g.  $X = (Y/Z) + (M/N)$
- Some signalling objects are optional to carry in a transaction, this "optionality" is indicated by an underlined text statement before the object in the tables

### 7.4.2 Signalling Request and Response Primitives

The term primitive is used here to indicate that a certain "procedure" or "transaction" is carried out. The term primitive is not used in its strict sense of giving an indication to drive nonstandard procedures. In the information flow, the primitive carried in the request and responses is indicated as XXX.req (Primitive). Multiple primitives may be used together, this is indicated by XXX.req(...,Primitive).

#### 7.4.2.1 CSF Originated Primitives

The following primitives are the primitives used to indicate that a procedure is to be initiated in the BIWF. These primitives are be used in the set of information flows contained in this Supplement.

**Table 2 – Primitives on the CBC interface – CSF Originated**

Primitive	Description
Audit_Values	This primitive is used by the CCU to audit the Packages, the Events, the Signals and the current Property Values realised by Termination(s) or the BIWF.
Audit_Capabilities	This primitive is used by the CSM to audit the Events, the Signals and the possible Property Values realised by Termination(s) or the BIWF.
CCU Ordered BIWF Re-Registration	This primitive is used by the CSM to order that the BIWF re-register itself with the CSM or to register itself with another CSM.



**Table 2 – Primitives on the CBC interface – CSF Originated (concluded)**

<b>Primitive</b>	<b>Description</b>
CCU Initiated Service Restoration	This primitive is used by the CSM to indicate that it has been restored to Service.
CCU Initiated Service Cancellation	This primitive is used by the CSM to indicate that it will be removed from Service.
Change_Topology	This primitive is used to change the connection topology within the BIWF. It describes the flow of user data internally to the BIWF. It may be used in cases where a monitoring is required.
Confirm_char	This is used to indicate that to the BIWF that it should now use the indicated bearer characteristics.
Cut_BNC	This is used to indicate to the BIWF that it should initiate a bearer release.
Cut_Through	This is used to indicate to the BIWF that cut-through of the bearer should occur.
Detect_Digit	This primitive is used to indicate to the BIWF that it should prepare the necessary resources to detect a DTMF digit and report the occurrence of the digit to the CSM.
Echo Canceller	This primitive is used to indicate the BIWF that it should associate echo canceller resources with the BNC.
Establish_BNC_notify	This is used to indicate to the BIWF that it should initiate a bearer setup.
Insert_Announcement	This is used to insert an announcement on a particular termination/s in the BIWF.
Insert_Digit	This is used to insert DTMF digit/s on a particular termination/s in the BIWF.
Insert_Tone	This is used to insert a tone on a particular termination/s in the BIWF.
Isolate	This primitive is used to isolate one termination from other terminations effectively stopping media flow between the isolated termination and existing terminations. This may be used in situations where services like Call Hold are needed.
Join	This primitive is used to join one or more terminations establishing media flow between the terminations. This may be used in situations where services like Conferencing or 3 party are required.
Modify_Char	This is used to indicate to the BIWF that it should initiate a change in the BNC characteristics. Ie. Change of codec, Bearer Service. It may have the effect that the bearer is modified.
Prepare_BNC_notify	This is used to indicate to the BIWF that it must be prepared to receive a bearer setup request.
Release_BNC	This is used to indicate to the BIWF that it should initiate a bearer release.
Reserve_BNC	This is used to indicate to the BIWF that it should reserve some resources, i.e. Termination for later BNC operations.
Reserve_Char	This is used to indicate to the BIWF that it should reserve the necessary bearer resources for a particular codec or bearer service characteristic.
Reuse_Idle	This is used to indicate that reuse of an idle bearer should be attempted.
Tunnel	The tunnel primitive allows the: CSM to indicate to the BIWF that Bearer Control Tunnelling is available. BIWF to indicate to the CSM direction that Bearer Control Tunnelling shall be used for a particular termination Passing from BIWF to CSM a Bearer Control Protocol data unit relating to a particular termination for transport to the peer termination.

### 7.4.2.2 BIWF Originated Primitives

The following primitives are the primitives used to indicate that a procedure is to be initiated in the CSF. These primitives are be used in the set of information flows contained in this Supplement.

**Table 3 – Primitives on the CBC interface – BIWF Originated**

Primitive	Description
BIWF_Capability_Change	This primitive is used by the BIWF to indicate to the CSM that the capabilities of Termination(s) or the BIWF are changed.
BIWF_Lost_Communication	This primitive is used by the BIWF to indicate to the CSM that the BIWF has lost but subsequently restored the communication with the CSM, but there is a risk that this has caused a possible information mismatch between the BIWF and the CSM.
BIWF_Registration	This primitive is used by the BIWF to register with a CSM.
BIWF_Re-Registration	This primitive is used by the BIWF to re-register with a CSM after the CSM has ordered re-registration or handoff.
BIWF_Service_Cancellation_Indication	This primitive is used by the BIWF to indicate to the CSM that Termination(s) on the BIWF or the BIWF are to be taken out of service.
BIWF_Service_Restoration_Indication	This primitive is used by the BIWF to indicate to the CSM that Termination(s) on the BIWF or the BIWF are to be taken into service.
Tunnel	The tunnel primitive allows the: BIWF to indicate to the CSM direction that Bearer Control Tunnelling shall be used for a particular termination Passing from BIWF to CSM a Bearer Control Protocol data unit relating to a particular termination for transport to the peer termination.

### 7.4.3 Signalling Objects

The following objects are the signalling objects to be carried in the information flow procedure definitions. These objects will be used in the set of information flows contained in this Supplement.

- 1) **A-BNC Characteristics:** Are the BNC Characteristics of the BNC in the opposite half call to the current BNC.
- 2) **Announcement:** Identifies that a Announcement of a certain identity be applied to a termination.
- 3) **Audit Token:** Specifies whether Packages and/or which type of Descriptor that are to be audited. In this Supplement the following values are used:
  - Digit Map
  - Empty (i.e. no **AuditToken**)
  - Events
  - Media
  - Modem
  - Mux
  - Packages
  - Signals
- 4) **Bearer Information Transport:** Carries the tunnelled Bearer Control information.
- 5) **Bearer Service Characteristics:** Identifies the user requested bearer service to be provided by the network. It is used by the BIWF to condition the bearer termination.

- 6) **BIWF Address (T-BIWF-Addr):** The address on which the BNC is terminated. Passed from the terminating BIWF to the CSF and through the BICC horizontal.
- 7) **BIWF Control Address:** Defines the signalling address associated with the BIWF that is used to interact with the CCU over the CBC interface. This object has a unique address within the network service supplier domain.
- 8) **BNC Characteristic:** Identifies the type of transport to be established across the backbone network. It is carried between call control instances via BICC signalling.
- 9) **BNC Connected:** Indicates that a termination in the BIWF has received sufficient information to determine that a bearer connection has been established via the tunnelling procedures.
- 10) **BNC Cut Through:** Indicates when through connection of BNC has occurred.
- 11) **BNC Established:** Indication that a BNC has been established on a particular termination in the BIWF.
- 12) **BNC-ID:** Identifies the logical connection between a local and remote termination.
- 13) **BNC Modified:** Indicates when the characteristics (i.e. Codec, Bearer Service Characteristics) has been modified.
- 14) **BNC Release:** An indication with a general reason for the release of a BNC (e.g. Normal Release, Interworking unspecified, ...)
- 15) **Cancel Echo:** indicates if the echo canceller should be on or off.
- 16) **CCU Control Address:** Defines the signalling address associated with the CSF which is used to interact with the BIWF over the CBC Interface. This object has a unique address within the network service supplier domain.
- 17) **Codec:** Contains the coding information (i.e. selected CODEC) to be used by the BIWF.
- 18) **Connection\_Topology / Connection Configuration:** Specifies the type and configuration of the connection type to be established (e.g. Type1, Type2, ... Type 6). To specify the connection topology the connections between the terminations in a context is specified (e.g. Type-x/One-way or Both Way).
- 19) **Context ID:** Identifies the context entity. Generated by the BIWF upon creation of the context. In this Supplement the following values are used:– ALL, when referencing all contexts in use, – Context ID, when referencing a specific context in use. Null Context, which indicates a context where terminations that have resources associated with them and are not part of a Local Call Instance reside.
- 20) **Cut Through Direction:** Indicates in which direction the BNC should be cut through. For example, Forwards, backwards, both ways.
- 21) **Cut Through Indication:** Indicates when through connection of the BNC has occurred.
- 22) **Detect\_Digit(x):** Indicates that a digit stimulus is detected on a termination in an BIWF. The digit/s is indicated in "x".
- 23) **Digit:** Identifies that a DTMF digit/s of a certain value (ie. 0 – 9, #, \*, ABCD) is applied to a termination.
- 24) **Digit Map Descriptor:** Holds Digit Map data such as Digit Map Name and Value.
- 25) **Event:** Is an indication that there has been an occurrence of the stimulus contained in a NotificationRequested request. It indicates that the stimulus has been observed on a termination in a BIWF. It may contain parameters detailing the specifics of the stimulus.
- 26) **Events Descriptor:** Holds Event data such as Package and Event Names and Event Parameter Names and possible Values.
- 27) **Event ID:** Provides the correlation between a request to detect an event and the notification that the event has been detected.

- 28) **Local Control Descriptor:** Holds Local Control data such as Package and Property Names and current and possible Property Values.
- 29) **Local Descriptor:** Holds Local data such as Package and Property Names and current and possible Property Values.
- 30) **Logical Port ID:** Identifies the Logical Port entity. Provisioned value in BIWF. The type of logical port is provisioned and known in the BIWF.
- 31) **Media Descriptor:** Holds Media data such as Package and Property Names and current and possible Property Values.
- 32) **Modem Descriptor:** Holds Modem data such as Package and Property Names and current and possible Property Values.
- 33) **Mux Descriptor:** Holds Mux data such as Mux Type and muxed Termination IDs.
- 34) **Non Standard Data:** Can specify the BIWF Type, e.g. as Brand, Version and Issue.
- 35) **Notification\_Requested "x":** Identifies to the BIWF that it must monitor a termination for the stimulus "x" to occur. Once the stimulus "x" is detected, an event is sent from the BIWF to the CSM.
- 36) **Packages Descriptor:** Holds data about Packages such as Package Names and Versions.
- 37) **Remote Descriptor:** Holds Remote data such as Package and Property Names and current and possible Property Values.
- 38) **Service Change Address:** Indicates New own CCU/BIWF Control Address to be used.
- 39) **Service Change Delay:** Specifies the delay in seconds before the service change is activated.
- 40) **Service Change Method:** Specifies the type of service change.

In this Supplement the following values are used:

- Disconnected
- Forced
- Graceful
- Restart
- Handoff

- 41) **Service Change MGCID:** Indicates own CCU Control Address to be used.
- 42) **Service Change Reason:** Specifies the reason for the service change.

In this Supplement the following values are used:

- Cold Boot
- Events Capability Failure
- Loss of lower layer connectivity
- Media Capability Failure
- MGC Directed Change
- Modem Capability Failure
- Mux Capability Failure
- Service Restored
- Signals Capability Failure
- Termination Taken Out Of Service
- Transmission Failure
- Warm Boot

- 43) **Service Change Version:** Indicates supported Protocol Version.
- 44) **Service State:** Specifies the overall (not stream-specific) state of a Termination/BIWF.  
In this Supplement the following values are used:
- In Service
  - Out Of Service
  - Test
- 45) **Signal:** Indicates that the stimulus specified in it is to be applied to a termination.
- 46) **Signal Completion(x):** Indicates that the stimulus applied to a termination has finished. "x" identifies the stimulus.
- 47) **Signal Descriptor:** Holds Signal data such as Package and Signal Names and Signal Parameter Names and possible Values.
- 48) **Signal Direction:** Indicates the directionality of a stimulus applied to a termination. The stimulus can be placed on a termination so that none of the other terminations in the context "hear" it (external) or so that other terminations in the context "hear" it also (internal). The direction may be set to (both way) indicating that all the terminations in the context "hear" it as well as it being sent external to the BIWF.
- 49) **Signal Timing:** Specifies the duration, number of cycles and stop/start of a signal to be played.
- 50) **Stream Mode:** Specifies the type and configuration of the termination to be established.. The termination can be placed in one of several connection states: Cut-through in the forward direction, backward direction, both directions, loopback towards remote termination, or idle.
- 51) **Termination ID:** Identifies the Termination entity. Generated by the BIWF when a termination is created. In this Supplement the following values are used: – ALL, when referencing groups or Ephemeral Terminations not in use. – Root, when referencing the BIWF level – Termination(s), when in use or in a Null Context.
- 52) **Termination State Descriptor:** Holds Termination State data such as Package and Property Names and current and possible Property Values. Includes also the Service State.
- 53) **Time Stamp:** Gives the BIWF local time at sending of command.
- 54) **Tone:** Identifies that a tone of a certain type (ie. Alerting tone, call waiting tone) is applied to a termination.
- 55) **Transaction ID:** Requests/Responses between the BWIF and the CCU are grouped into Transactions, each of which is identified by a TransactionID. Transactions consist of one or more Actions. An Action consists of a series of requests and responses that are limited to operating within a single Context. Refer to 7.8/H.248 for more details.
- 56) **Tunnel Indication:** Identifies to the BIWF that the Bearer Information Transport mechanism can be used. The CSF may request that the BIWF provide the BIT information in a Notify.ind at the same time as the response to the Tunnel Indication request. The CSF may also indicate the BIT information may be provided in a Notify.ind at a time later than the Tunnel Indication request.

The Table below details information elements from the BICC Call Control Level that may be transparently passed to/from the BICC message to signalling objects across the CBC interface.

**Table 4 – BICC to CBC signalling object mapping**

<b>Information Flow Signalling Object</b>	<b>Carried across CBC Interface</b>
Bearer Information Transport (BIT)	✓
BIWF-Address	✓
BNC Characteristics	✓
BNC ID	✓
Bearer Service Characteristics <ul style="list-style-type: none"><li>• Codec</li><li>• TMR</li><li>• USI</li></ul>	✓

## **8 Signalling Procedures between the CSF and the BIWF (CBC interface)**

NOTE 1 – Transaction Identities do not align with those with the Call Flows in ITU-T Q-Series Supplement 32 [2] "*Technical report TRQ.2141.1: Signalling requirements for the support of narrowband services via Broadband Transport Technologies, CS-2 Signalling Flows*". The values are for illustrative purposes only.

NOTE 2 – The signalling address of the CSF and BIWF is implicit and not shown in these flows.

NOTE 3 – Notifications may be provisioned on a termination or may be requested at the time of adding a termination to a context and at any time whilst the termination is in a context. In the flows below a generic notification (NotificationRequested "BNC") is assumed to be present when the termination is added to a context. This would result in a Notify.ind being sent indicating a particular change to the BNC. Eg. "BNC established", "BNC released(cause)" or "BNC modified". The CSF may remove a Notification Request from the BIWF at any time.

## 8.1 Successful Establishment

### 8.1.1 Prepare\_BNC\_Notify

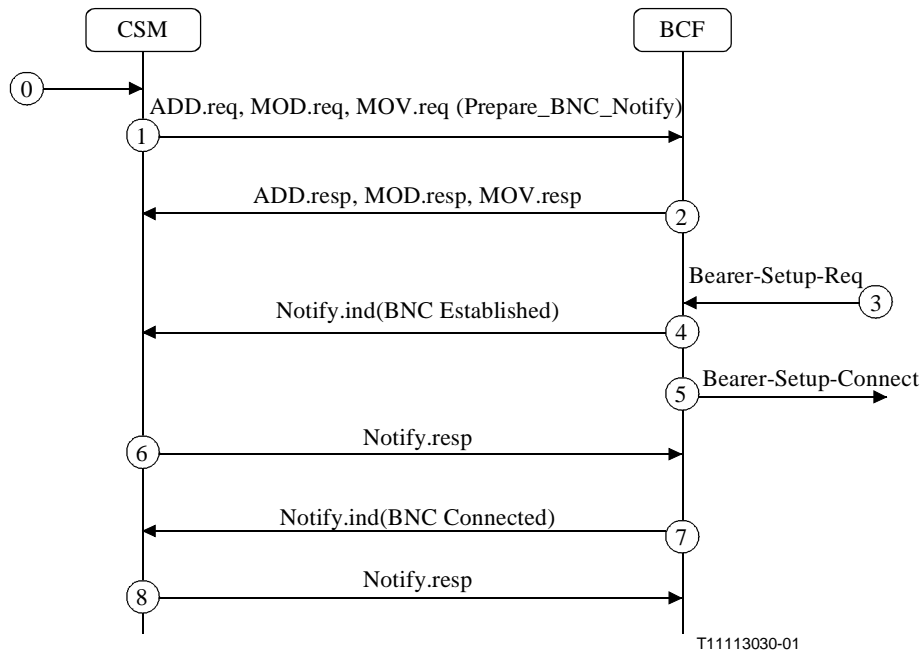

NOTE – Flow 7 may be sent before Flows 5, 7 and 8 are optional.

**Figure 6 – Prepare BNC with notification**

The following numbered items describe the numbered flows shown above.

---

#### 0 Stimulus

##### Address Information

See relevant flow in Signalling Flows for the support of BICC Capability Set 2 [1]

##### Control information

##### Bearer information

**Initiation of information flow:** See Signalling Flows for the support of BICC Capability Set 2 [1] for flows which lead to the initiation of Call Bearer Control signalling.

**Processing upon receipt:** When the CSM receives one of these information flows it prepares the BIWF to accept a subsequent BNC establishment, however it is not concerned with when the BNC is established. It selects the appropriate BIWF and issues Flow 1 with the following considerations.

The CSM will:

- initiate a transaction and select transactionID = 1000 for this purpose.
- request the T-BWIF-address and a BNC-id to be used by the peer ISN for the BNC.
- request a TerminationID from the BIWF to be used locally in the ISN.
- send the BNC characteristics for input to the termination selection
- request that it be notified of Bearer Establishment.

If the context is NOT available the CSM will:

- Request the BIWF to provide a Context as at this stage there are no terminations selected and context instantiated in the ISN for this call.

If the context is available the CSM will:

- Provide the context to be used to the BIWF as a termination and context has already been instantiated in the ISN for this call.

The CSM in Case of Non-Codec Negotiation will:

- Send the Bearer Service Characteristics to define the characteristics of the terminations and associated BNC.

The CSM in Case of Codec Negotiation will:

- Send the Codec to be used. The BIWF can then deduce the characteristics of the termination and associated BNC.

The CSM in the Case of tunnelling will:

- Request to be notified when a BNC has been connected.

NOTE – In the case of backwards bearer establishment the value of the "Selected Codec" may not be known. The CSM may choose a codec to be used. If codec negotiation results in another codec being selected then the codec will be modified.

---

**1      ADD.req, MOD.req, MOV.req (prepare BNC with notification)      CSM to BIWF**

**Address Information**  
T-BIWF-Address = ?

**Control information**  
Transaction ID = 1000  
Termination ID = ?  
Logical Port ID = y

Context Requested:  
Context ID = ?  
Context Provided:  
Context ID = c1

Forward Establishment:  
BNC-cut-through-capability = ?

If tunnelling is used:  
BNC Connected = ?

**Bearer information**  
If CSF chosen:  
BNC characteristics = chosen characteristics

If BIWF chosen:  
BNC characteristics = ?  
A-BNC Characteristics  
BNC-id = ?

No Codec Negotiation  
Bearer Service Characteristics

Codec Negotiation  
Codec

If Forward Establishment & Tunnelling = option 1:  
BIWF-Addr = x  
BNC-ID = x1

**Initiation of information flow: Flow 0.**

**Processing upon receipt:**

When the BIWF receives Information Flow 1 it validates the request. From the primitive "Prepare\_BNC\_Notify" it understands that it has to prepare for a terminating bearer establishment, so it selects the bearer technology based upon the preferred BNC characteristics (if provided) and the preferred A-BNC characteristics, and optionally upon the Bearer Service Characteristics or Codec. The BIWF then selects the termination id to be "bearer1" and the BNC-ID to be x1 and the T-BIWF-address to be X. If the BIWF was requested, it shall select a Context ID. Once selected these are returned to the CSM in Information Flow 2.

In the case of Forwards establishment the CSM will also request the BNC-cut-through-capability.

In the case that this is the second termination in the context, the BIWF performs an analysis of the two terminations and determines whether a transcoder is required between the logical ports represented (or to be represented) by the termination Ids. If a transcoder is required, it is reserved for this purpose.

As the primitive "Prepare\_BNC\_Notify" has been requested the BIWF waits for the incoming Bearer-Setup-Req in Information Flow 3 and will inform the CSM of this in Information Flow 4.



**Address Information**

T-BIWF-Address = X

**Control information**Transaction ID = 1000  
Termination ID = bearer1  
Context ID = c1**Forwards Establishment**

BNC-cut-through-capability = early / late

**Bearer information**

BNC-ID= x1

**If BIWF chosen:**BNC Characteristics = chosen  
characteristics**Initiation of information flow:** Receipt of Information Flow 1.**Processing upon receipt:** When the CSM receives the ADD.resp it continues the call processing, which should eventually result in a Bearer-Setup-Req being returned the BIWF as per Information Flow 3.**Address Information**

T-BIWF-Addr = X

**Control information**

BCS-id = 65

**Bearer information**BNC-ID = x1  
BNCL-ID = 1000  
BNCL characteristics**Initiation of information flow:** Bearer-Setup-Request at Peer ISN**Processing upon receipt:** When the BIWF receives the Bearer-Set-Request, it validates that the T-BIWF Addr is its own address, and that the BNC-ID has been previously allocated by the BIWF. If this is the case, then the Logical Port indicated is associated with the termination appointed by the BNC-ID. If the termination is in context containing other terminations, then the BIWF will connect the logical ports together as per the stream modes of the related terminations, and the context topology. The transcoding equipment, if required, is inserted. To inform the CSM that the BNC has been established (as requested), the Information Flow 4 is initiated. Transaction-ID of 1002 is selected for this purpose. Cut through occurs and the BIWF initiates the Bearer-Setup-Connect in Information Flow 5.**Address Information****Control information**Transaction ID = 1002  
Termination ID = bearer 1  
Context ID = c1**Bearer information****Initiation of information flow:** Information Flow 3**Processing upon receipt:** When the CSM receives the Notify information flow, it continues call processing and initiates the Notify Response Information Flow 6.**Address Information****Control information**

BCS-id=65

**Bearer information**

BNCL-ID = 1000

**Initiation of information flow:** Reception of Information Flow 4.**Processing upon receipt:** –

6 Notify.resp CSM to BIWF

Address Information

Control information

Transaction ID = 1002  
Context ID = c1

Bearer information

**Initiation of information flow:** Receipt of Information Flow 4.

**Processing upon receipt:** –

7 Notify.ind (BNC Connected) BIWF to CSM

Address Information

Control information

Transaction ID = 1003  
Termination ID = bearer 1  
Context ID = c1

Bearer information

**Initiation of information flow:** The BIWF has received sufficient information to determine that a bearer connection has been established via the tunnelling procedures.

**Processing upon receipt:** When the CSM receives the Notify information flow, it continues call processing and initiates the Notify Response Information Flow 8.

8 Notify.resp CSM to BIWF

Address Information

Control information

Transaction ID = 1003  
Context ID = c1

Bearer information

**Initiation of information flow:** Receipt of Information Flow 7.

**Processing upon receipt:** –

8.1.2 Establish\_BNC\_Notify

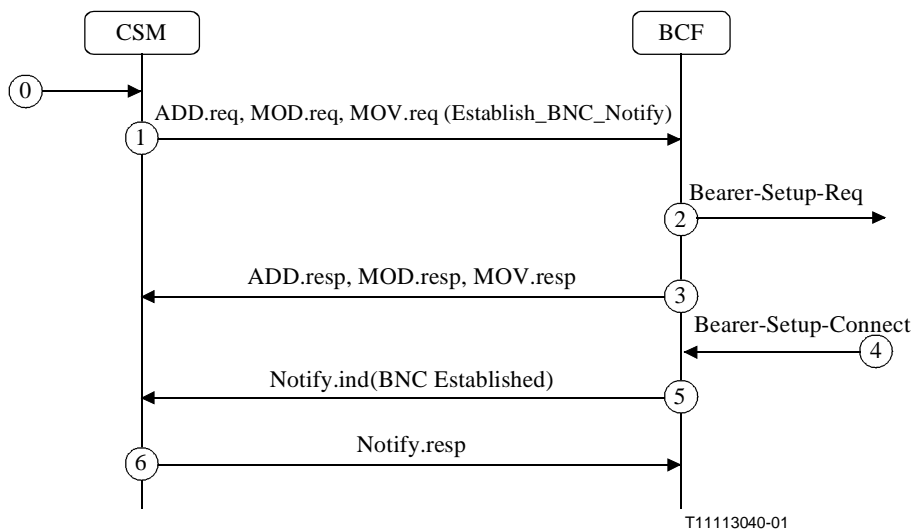

Figure 7 – Establish BNC with Notification

The following numbered items describe the numbered flows shown above.

---

**0 Stimulus**

**Address Information**

**Control information**

**Bearer information**

See relevant flow in Signalling Flows for the support of BICC Capability Set 2 [1]

**Initiation of information flow:** See "Signalling Flows for the support of BICC Capability Set 2" [Ref. 1)] for flows which lead to the initiation of Call Bearer Control signalling.

**Processing upon receipt:** The CSF will select the appropriate BIWF. When the CSM receives one of these information flows and from the previously received Action-ID it will request the BIWF to establish a BNC. The CSM issues Flow 1 with the following considerations.

The CSM will:

- initiate a transaction and select transactionID = 1001 for this purpose.
- send the T-BWIF-address and a BNC-id to be used by Bearer Control protocol for the BNC establishment.
- request that it be notified of Bearer Establishment.

If no termination has been previously selected the CSM will:

- Send the BNC characteristics for input to the termination selection
- Request a TerminationID from the BIWF to be used locally in the ISN.

If a termination has previously been reserved, the CSM will provide the Termination on which the BNC establishment is to occur.

Depending on BIWF selection, the Context may not be available and it will be requested. If available the context will be provided.

The CSM in Case of Non-Codec Negotiation will:

- Send the Bearer Service Characteristics to define the characteristics of the terminations and associated BNC.

The CSM in Case of Codec Negotiation will:

- Send the Codec to be used. The BIWF will then deduce the characteristics of the termination and associated BNC.

In the case tunnelling can be used the CSM will indicate this in Flow 1.

---

**1 ADD.req/MOD.req/MOV.req (Establish BNC Notify) CSM to BIWF**

**Address Information**

T-BIWF-Address = X

**Control information**

Transaction ID = 1001

If the context is provided:  
Context ID = c1

If the context is NOT provided:  
Context ID = ?

Termination Requested:  
Termination ID = ?  
Logical Port ID = y

Termination Provided:  
Termination ID = bearer1

If Tunnelling can be used:  
Tunnel Indication = ? / no / 1 / 2

**Bearer information**

BNC-id = x1

Termination Requested:  
BNC Characteristics  
A-BNC Characteristics

No Codec Negotiation:  
Bearer Service Characteristics

Codec Negotiation:  
Codec

**Initiation of information flow:** Information flow 0.

**Processing upon receipt:** When the BIWF receives Information Flow 1 it validates the request. From the primitive the BIWF knows to initiate the BNC establishment.

The BIWF selects the bearer technology based upon the preferred BNC characteristics (if provided), and optionally upon the Bearer Service Characteristics or Codec. If requested the BIWF then selects the Termination id to be "bearer1" or uses the one provided by the CSM. This is returned to the CSM in Information Flow 3. The BNC-ID of x1, and the T-BIWF-address is included in the Bearer-Setup-Req of Information Flow 2.

In the case that this is the second termination in the context, the BIWF performs an analysis of the two terminations and determines whether a transcoder is required between the logical ports represented (or to be represented) by the termination Ids. If a transcoder is required, it is reserved for this purpose.

The BIWF will initiate a BNC (Flow 2) according to the bearer characteristics. The BIWF will then return Information Flow 3. As the primitive "Establish\_BNC\_Notify" has been used the BIWF awaits the incoming Bearer-Setup-Connect in Information Flow 4 and will inform the CSM of this in Information Flow 5.

---

<b>2</b>	<b>Bearer-Setup-Req</b>	<b>BIWF to BIWF-x</b>
	<u>Address Information</u> T-BWIF Addr = X	<u>Control information</u> BCS-id = 66
		<u>Bearer information</u> BNC-ID=x1 BNCL-ID=999 BNCL characteristics

**Initiation of information flow:** Receipt of Information Flow 1.

**Processing upon receipt:** –

---

<b>3</b>	<b>ADD.resp, MOD.resp, MOV.resp</b>	<b>BIWF to CSM</b>
	<u>Address Information</u>	<u>Control information</u> Transaction ID = 1001 Context ID = c1
		<u>Termination Requested:</u> Termination ID = bearer1
		<u>Bearer information</u>

**Initiation of information flow:** Receipt of Information Flow 1.

**Processing upon receipt:** When the CSM receives the Add.resp, it continues the call processing. Information Flow 2 would be contained in this case.

---

<b>4</b>	<b>Bearer-Setup-Connect</b>	<b>BIWF-x to BIWF</b>
	<u>Address Information</u>	<u>Control information</u> BCS-id=66
		<u>Bearer information</u> BNCL-ID=999

**Initiation of information flow:** BIWF-x initiating Bearer-Setup-Connect

**Processing upon receipt:** Upon reception the BIWF shall initiate the Notify Information Flow 5.

---

5 Notify.ind (BNC Established)

BIWF to CSM

Address Information

Control information

Bearer information

Transaction ID = 1002  
Termination ID = bearer1

Context ID = c1

**Initiation of information flow:** Information Flow 4.

**Processing upon receipt:** When the CSM receives the Notify information flow, it continues call processing and initiates the Notify Response Information Flow 6.

---

6 Notify.resp

CSM to BIWF

Address Information

Control information

Bearer information

Transaction ID = 1002  
Context ID = c1

**Initiation of information flow:** Receipt of Information Flow 5.

**Processing upon receipt:** –

---

### 8.1.3 Reserve\_BNC

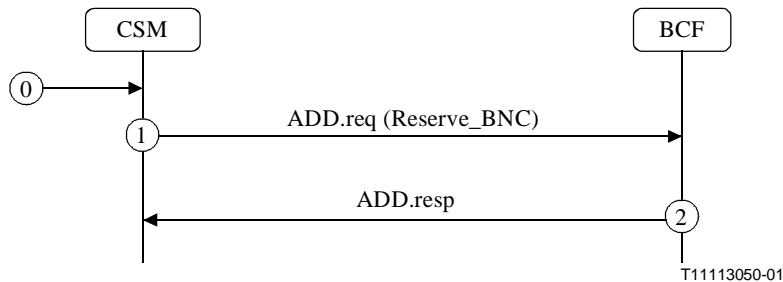

**Figure 8 – Reserve BNC**

The following numbered items describe the numbered flows shown above.

---

0 Stimulus

Address Information

Control information

Bearer information

See relevant flow in Signalling Flows for the support of BICC Capability Set 2 [1]

**Initiation of information flow:** See "Signalling Flows for the support of BICC Capability Set 2" [1] for flows which lead to the initiation of Call Bearer Control signalling.

**Processing upon receipt:** When the CSM receives the relevant flow it reserves resources in the BIWF for later bearer establishment, however it is not concerned with when the BNC is established. It selects the appropriate BIWF and issues Flow 1 with the following considerations.

The CSM will:

- initiate a transaction and select transactionID = 1000 for this purpose.

- request the O-BWIF-address to be used by the peer ISN for the BNC for selecting the BIWF.
- request a TerminationID from the BIWF to be used locally in the ISN.
- send the BNC characteristics for input to the termination selection

Depending on BIWF selection, the Context may not be available and it will be requested. If available the context will be provided.

---

**1      ADD.req (Reserve\_BNC)**

**CSM to BIWF**

**Address Information**

O-BIWF-Address = ?

**Control information**

Transaction ID = 1000  
Termination ID = ?

**Bearer information**

BNC characteristics

If the context is provided:

Context ID = c1

If the context is NOT provided:

Context ID = ?

**Initiation of information flow: New Call**

**Processing upon receipt:** When the BIWF receives Information Flow 1 it validates the request. From the request for a terminationID it understands that it has to reserve a termination. The BIWF selects the termination based upon the preferred BNC characteristics (if provided). The BIWF then selects the O-BIWF-address to be X. If the BIWF was requested, it shall select a Context ID. These are returned to the CSM in Information Flow 2.

---

**2      ADD.resp**

**BIWF to CSM**

**Address Information**

O-BIWF-Address = X

**Control information**

Transaction ID = 1000  
Termination ID = bearer1  
Context ID = c1

**Bearer information**

**Initiation of information flow: Receipt of Information Flow 1.**

**Processing upon receipt:** When the CSM receives the ADD.resp, it continues the call processing.

**8.1.4 Cut\_Through**

The cut through primitive is used to through connect or break the user plane on the terminations. The Cut Through primitive can be used for this purpose in two ways. The implicit cut through is used when the termination is instantiated to allow the BIWF to control when the cut through of the media occurs. The explicit cut through is used when the CSM wants to control when the cut through of the media on the terminations occurs. To break the user plane the explicit cut through is used. The cut through transactions should be applied to the terminations in the context that need to be cut through.

### 8.1.4.1 BIWF Controlled (Implicit)

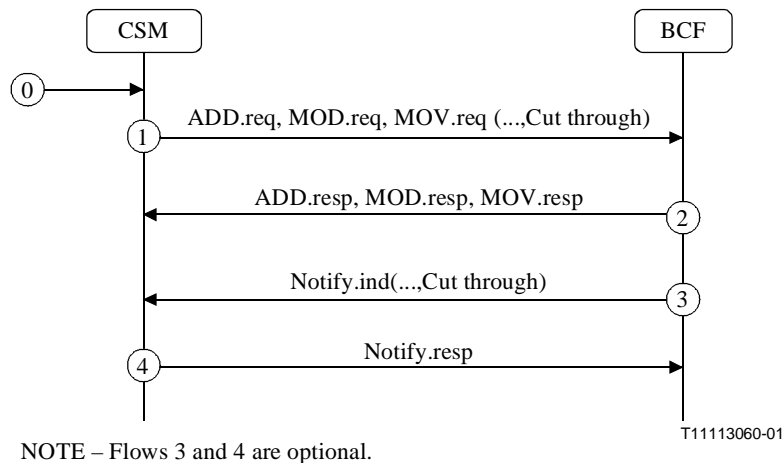

**Figure 9 – Perform Cut Through**

The following numbered items describe the numbered flows shown above.

**0 Stimulus**

Address Information

Control information

Bearer information

**Initiation of information flow:** –

**Processing upon receipt:** When the CSM wants to implicitly perform cut-through it requests the BIWF to perform a cut-through of the logical port represented by termination "bearer1". This is used when the CSM requires that the BIWF perform cut-through at an appropriate time. The CSM shall include the request to cut-through a bearer on a termination with Prepare\_BNC\_Notify and Establish\_BNC\_Notify indications.

**1 ADD.req / MOD.req / MOV.req (... Cut Through) CSM to BIWF**

Address Information

Control information

Bearer information

As per Flow 1  
 8.1.1 Prepare\_BNC\_Notify or  
 8.1.2 Establish\_BNC\_Notify

With the following addition:  
 Cut Through Direction = forward,  
 backward, both, inactive

If Notification of cut through is required:  
 Cut Through Indication

**Initiation of information flow:** Call Stimulus.

**Processing upon receipt:** When the BIWF receives the request for the termination "bearer1" with the Cut Through Direction set to indicate through connection (forward/backward/both/Inactive), the BIWF will wait until a Bearer-Setup-Req is sent or received. It will through connect the logical port represented by termination "bearer1". It will indicate the successful completion of the task to the

CSM with Information Flow 3. The BIWF sends the indication of cut-through when the criteria for sending the Notify.ind for 8.1.1 Prepare\_BNC\_Notify and 8.1.2 Establish\_BNC\_Notify is satisfied.

2          **ADD.resp / MOD.resp / MOV.resp**    **BIWF to CSM**

**Address Information**

**Control information**

**Bearer information**

As per Flow 2  
8.1.1 Prepare\_BNC\_Notify or  
8.1.2 Establish\_BNC\_Notify

**Initiation of information flow:** Information Flow 1

**Processing upon receipt:** –

3          **Notify.ind**    **BIWF to CSM**

**Address Information**

**Control information**

**Bearer information**

As per Flow 4  
8.1.1 Prepare\_BNC\_Notify  
or  
As per Flow 5  
8.1.2 Establish\_BNC\_Notify

With the following addition:  
BNC Cut Through Indication

**Initiation of information flow:** Cut-through of the bearer.

**Processing upon receipt:** Indicates that cut-through has occurred.

4          **Notify.resp**    **CSM to BIWF**

**Address Information**

**Control information**

**Bearer information**

As per Flow 6  
8.1.1 Prepare\_BNC\_Notify

**Initiation of information flow:** Information Flow 1

**Processing upon receipt:** –

**8.1.4.2 CSM Controlled (Explicit)**

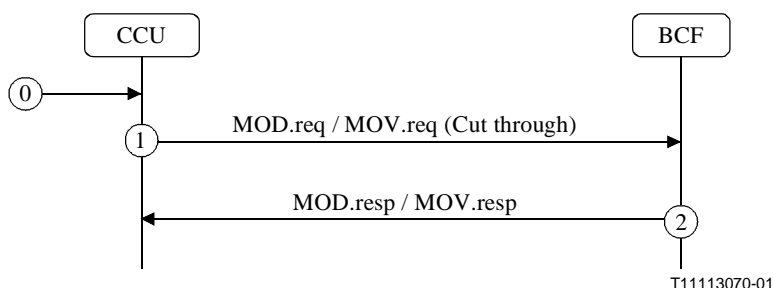

**Figure 10 – Perform Cut Through**



The following numbered items describe the numbered flows shown above.

---

**0 Stimulus**

Address Information

Control information

Bearer information

**Initiation of information flow:** Notification of Successful Bearer Establishment.

**Processing upon receipt:** When the CSM wants to explicitly perform cut-through it requests the BIWF to perform a cut-through of the logical port represented by termination "bearer1" to the logical port represented by "bearer2". Transaction Id 1002 is selected for this.

---

**1 MOD.req / MOV.req (Cut Through)**

**CSM to BIWF**

Address Information

Control information

Bearer information

Termination = bearer1  
Context ID = c1

Cut Through Direction = forward,  
backward, both, inactive  
Transaction ID = 1002

**Initiation of information flow:** Stimulus.

**Processing upon receipt:** When the BIWF receives the request with the primitive "Cut Through" for termination "bearer1" and the Cut Through Direction indicated, the BIWF will through connect the logical port represented by termination "bearer1". More than one termination may be included in the same transaction to through connect several terminations simultaneously. It will indicate the successful completion of the task to the CSM with Information Flow 2.

---

**2 MOD.resp / MOV.resp**

**BIWF to CSM**

Address Information

Control information

Bearer information

Transaction ID = 1002  
Context ID = c1

**Initiation of information flow:** Information Flow 1.

**Processing upon receipt:** When the CSM receives the -response, it continues call processing.

## 8.1.5 Modification of Bearer Characteristics

### 8.1.5.1 Reserve\_Char\_Notify

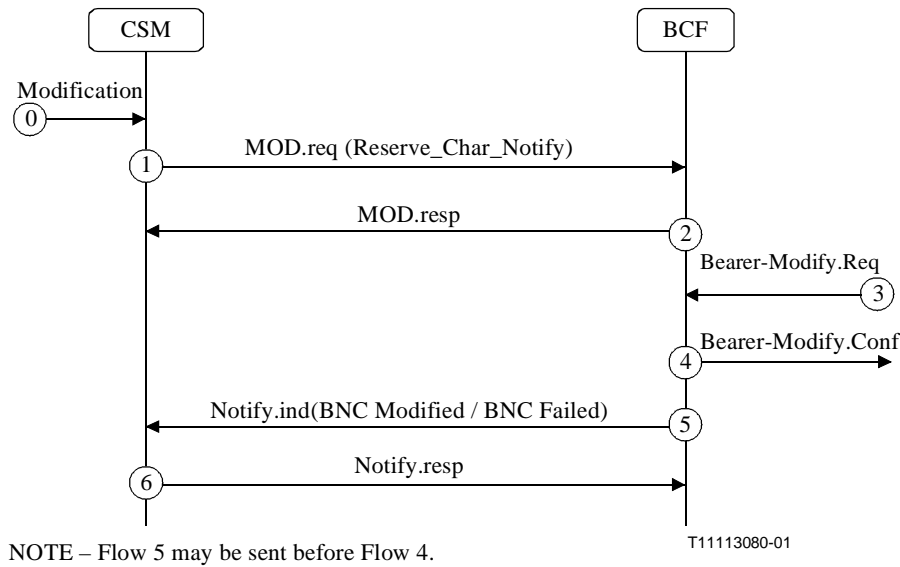

**Figure 11 – Reserve Characteristics**

The following numbered items describe the numbered flows shown above.

---

#### 0 Modification

##### Address Information

##### Control information

##### Bearer information

See relevant flow in Signalling Flows for the support of BICC Capability Set 2 [2]

**Initiation of information flow:** See "Signalling Flows for the support of BICC Capability Set 2" [2] for flows which lead to the initiation of Call Bearer Control signalling.

**Processing upon receipt:** When the CSM receives this information flow, it checks that the received "Available Codecs" list is either the same or a subset of the current "Available Codecs" list for the call. It also ensures that the Selected Codec is listed in the received "Available Codecs" list. If any of the aforementioned conditions fails, the modification is rejected. Otherwise, the CSM issues Flow 1 towards the BIWF.

---

#### 1 MOD.req (Reserve\_Char\_Notify)

CSM to BIWF

##### Address Information

##### Control information

##### Bearer information

Transaction ID = 1000

Termination ID = bearer1

Context ID = c1

NotificationRequested (Event ID = x, "BNC modified / BNC Mod Failed")

Signal = BNC Modify

Reserve\_Value

Non Codec Negotiation

Bearer Service Characteristics

Codec Negotiation

Codec/s – New and Old

**Initiation of information flow:** Information Flow 0.

**Processing upon receipt:**

- When the BIWF receives the request to modify the Bearer Characteristics for the termination it shall reserve resources for the characteristics of the bearer associated with the termination. The BIWF shall analyse whether new transcoding equipment is required between the termination "bearer1" and any other terminations in the context. The BIWF will analyse the bandwidth needs of the provided codec/s or bearer service characteristics and initiate a Bearer-Modify-Req information flow only if the value to be reserved requires a greater bandwidth information with Information Flows 3 and 4.
- The BIWF shall also modify the codec profile being used on the connection using Information Flows 3 and 4.
- As the Reserve\_Value indication is sent, the BIWF should reserve the resources required to support multiple values of bearer information. For example is 2 codecs are sent then the resources to support both are reserved.
- The BIWF shall send Information Flow 2.

---

2	MOD.resp	BIWF to CSM	
	<u>Address Information</u>	<u>Control information</u> Transaction ID = 1000 Termination ID = bearer1 Context ID = c1	<u>Bearer information</u>

**Initiation of information flow:** Information Flow 1

**Processing upon receipt:** The CCU will continue with codec modification procedures.

---

3	Bearer-Modify.Req	BIWF to BIWF-X	
	<u>Address Information</u> T-BIWF Addr = X	<u>Control information</u> BCS-ID = "20"	<u>Bearer information</u> BNCL-ID = 1000 BNCL Characteristics

**Initiation of information flow:** Processing of Information Flow 1.

**Processing upon receipt:** The BIWF-X validates the request, reserves the resources required by the modified connection. It then sends Information Flow 4.

---

4	Bearer-Modify.Ack	BIWF-X to BIWF	
	<u>Address Information</u>	<u>Control information</u> BCS-ID = "20"	<u>Bearer information</u> BNCL-ID = 1000

**Initiation of information flow:** processing of Information Flow 3.

**Processing upon receipt:** BIWF allocates the resources to the connection and notifies the CSM, via Information Flow 5, that the BNC has been prepared.

---

5	NOTIFY.ind	BIWF to CSM	
	<u>Address Information</u>	<u>Control information</u> Transaction ID = 3010 Context ID = c1 Termination ID = bearer1 Event = BNC Modified / BNC Mod Fail	<u>Bearer information</u>

**Initiation of information flow:** Processing of Information Flow 4.

**Processing upon receipt:** CSM-O records the successful outcome of the modification and returns Flow 6 to BIWF to acknowledge the notification

---

6 NOTIFY.resp CSM to BIWF

Address Information

Control information  
Transaction ID = 3010

Bearer information

**Initiation of information flow:** processing of Information Flow 5.

**Processing upon receipt:** –

8.1.5.2 Confirm\_Char

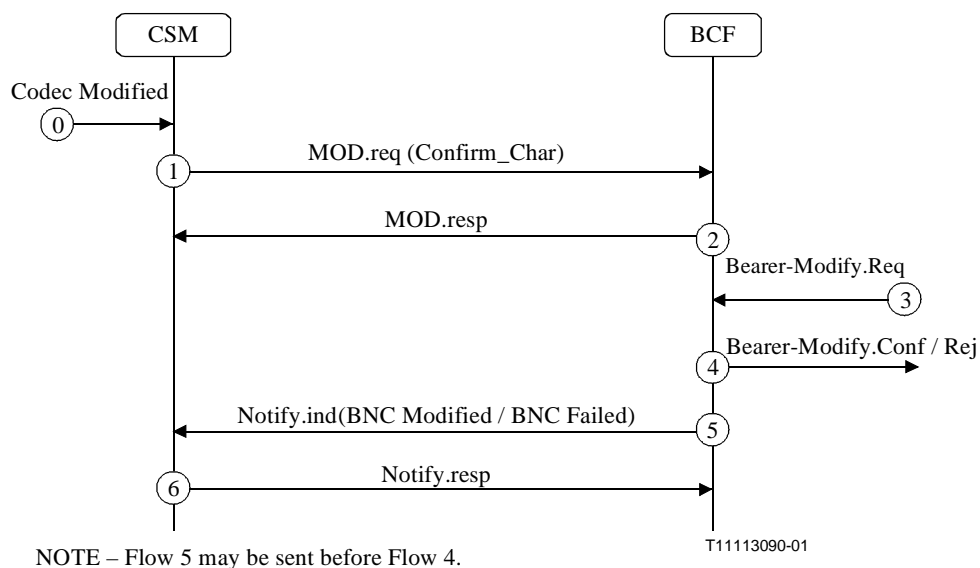

**Figure 12 – Confirm Characteristics**

The following numbered items describe the numbered flows shown above.

---

0 Codec Modified

Address Information

See relevant flow in Signalling Flows for the support of BICC Capability Set 2 [2]

Control information

Bearer information

**Initiation of information flow:** See "Signalling Flows for the support of BICC Capability Set 2" [2] for flows which lead to the initiation of Call Bearer Control signalling.

**Processing upon receipt:** CSM sends Flow 1 to BIWF to confirm the modification of the bearer resources.

---

1 MOD.req (Confirm\_Char) CSM to BIWF

Address Information

Control information

Transaction ID = 2000  
Termination ID = bearer1  
Context ID = c1  
Signal = BNC Modify  
  
If reverting to the original codec:  
NotificationRequested (Event ID = x,  
"BNC modified / BNC Mod Failed")

Bearer information

Non Codec Negotiation  
Bearer Service Characteristics  
  
Codec Negotiation  
Codec

**Initiation of information flow:**

**Processing upon receipt:**

- When the BIWF receives the request to modify the Bearer Characteristics for the termination it shall modify the characteristics of the bearer associated with the termination according to the provided Codec or Bearer Service Characteristic. When the u-plane no longer needs the bandwidth the BIWF may initiate the Bearer-Modify-Req Information Flow 3 to reduce the bandwidth if the previously reserved bandwidth is greater than what is required.
- Send Information Flow 2.

---

2	MOD.resp	BIWF to CSM	
	<u>Address Information</u>	<u>Control information</u> Transaction ID = 2000 Termination ID = bearer1 Context ID = c1	<u>Bearer information</u>

**Initiation of information flow:** Information Flow 1.

**Processing upon receipt:** –

---

3	Bearer-Modify.Req	BIWF to BIWF-X	
	<u>Address Information</u> T-BIWF Addr = X	<u>Control information</u> BCS-ID = "20"	<u>Bearer information</u> BNCL-ID = 1000 BNCL Characteristics

**Initiation of information flow:** Flow 1.

**Processing upon receipt:** BIWF validates the request, reduces the bandwidth allocated to the connection and sends Information Flow 4 to BIWF.

---

4	Bearer-Modify.Ack	BIWF-X to BIWF-Y	
	<u>Address Information</u>	<u>Control information</u> BCS-ID = "20"	<u>Bearer information</u> BNCL-ID = 1000

**Initiation of information flow:** processing of Information Flow 3.

**Processing upon receipt:** The BIWF reduces the bandwidth allocated to the connection.

---

5	NOTIFY.ind	BIWF to CSM	
	<u>Address Information</u>	<u>Control information</u> Transaction ID = 3010 Context ID = c1 Termination ID = bearer1 Event = BNC Modified / BNC Mod Fail	<u>Bearer information</u>

**Initiation of information flow:** Processing of Information Flow 4.

**Processing upon receipt:** CSM records the outcome of the modification and returns Flow 6 to BIWF to acknowledge the notification

Address InformationControl information  
Transaction ID = 3010Bearer information

**Initiation of information flow:** processing of Information Flow 5.

**Processing upon receipt:** –

### 8.1.5.3 Modify\_Char

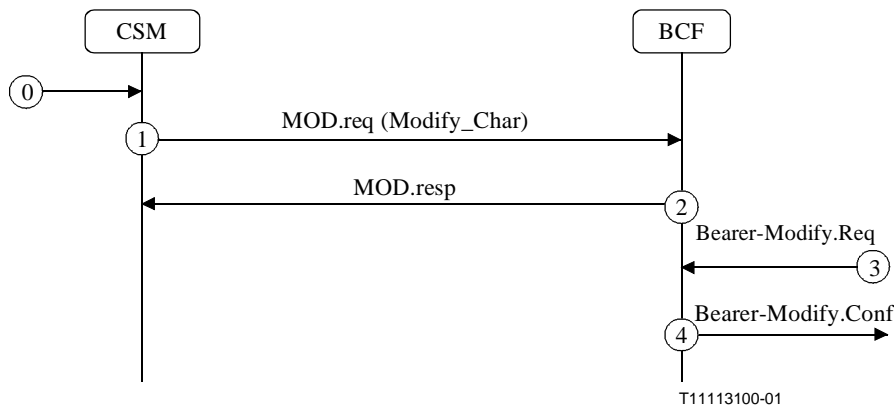

**Figure 13 – Modify Characteristics**

The following numbered items describe the numbered flows shown above.

#### 0 Stimulus

Address Information

See relevant flow in Signalling Flows for the support of BICC Capability Set 2 [1]

Control informationBearer information

**Initiation of information flow:** See "Signalling Flows for the support of BICC Capability Set 2" [1] for flows which lead to the initiation of Call Bearer Control signalling.

**Processing upon receipt:** When the CSM detects that there is a change in bearer related Characteristics (eg. Codec, Bearer Service Characteristics) it will request the BIWF to modify the bearer information on the termination relevant to that half call by initiating Information Flow 1. Information Flow 1 is initiated for the BIWF that terminates the Bearer Control Modification. Transaction ID 1000 is used for this purpose.

#### 1 MOD.req (Bearer Characteristics)

CSM to BIWF

Address InformationControl information

Transaction ID = 1000  
Termination ID = bearer1  
Context ID = c1

Bearer information

Non Codec Negotiation  
Bearer Service Characteristics

Codec Negotiation

Codec/s

If multiple values of Bearer Information are required:  
Reserve Value

**Initiation of information flow:** Information Flow 0.

**Processing upon receipt:** When the BIWF receives the request to modify the Bearer Characteristic information for the termination it shall modify the characteristics of the bearer associated with the termination. The BIWF shall analyse whether new transcoding equipment is required between the logical ports indicated by the termination "bearer1" and any other terminations in the context. The BIWF will inform the CSM that the task is completed with Information Flow 2. If the Reserve\_Value indication is sent, the BIWF should reserve the resources required to support multiple values of bearer information. For example, if 2 codecs are sent then the resources to support both are reserved. The BIWF should take relevant actions to ensure smooth transition to the new encoding. The BIWF shall wait for an incoming bearer modification in Information Flow 3.

---

2	<b>MOD.resp</b>	<b>BIWF to CSM</b>
	<p><u>Address Information</u></p>	<p><u>Control information</u>  Transaction ID = 1000  Termination ID1 = bearer1  Context ID = c1</p>
		<p><u>Bearer information</u></p>

**Initiation of information flow:** Receipt of Information Flow 1.

**Processing upon receipt:** The CSF continues call processing.

---

3	<b>Bearer-Modify-Req</b>	<b>BIWF to BIWF-x</b>
	<p><u>Address Information</u></p>	<p><u>Control information</u>  BCS-id=66</p>
		<p><u>Bearer information</u>  BNCL characteristics  BNCL-ID = 999</p>

**Initiation of information flow:** Confirmation of Bearer Modification by a BIWF in a peer node.

**Processing upon receipt:** When the BIWF receives the request to modify the BNC for the termination it shall modify the characteristics of the bearer associated with the termination. The BIWF shall analyse whether new transcoding equipment is required between the logical ports indicated by the termination "bearer1" and any other terminations in a context. As the "BNC modification" event has been subscribed to (See Note 3 in clause 8), the BIWF shall notify the CSM that there has been a change of bearer related characteristics in Information Flow 3. It will confirm the change of bearer related characteristics to the peer BIWF in Information Flow 4.

---

4	<b>Bearer-Modify-Conf</b>	<b>BIWF-x to BIWF</b>
	<p><u>Address Information</u></p>	<p><u>Control information</u>  BCS-id=66</p>
		<p><u>Bearer information</u></p>

**Initiation of information flow:** Information Flow 2.

**Processing upon receipt:** –

### 8.1.6 Tunnel

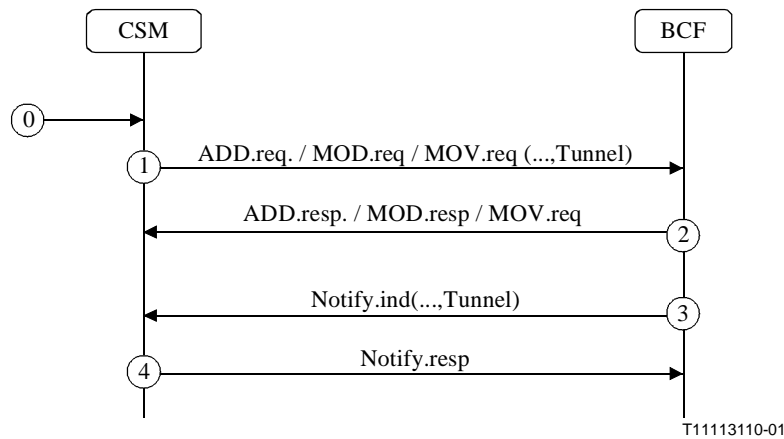

NOTE – Flows 2 and 3 may be returned at the same time.

**Figure 14 – Tunnel**

The following numbered items describe the numbered flows shown above. The Tunnel procedure is used to carry the "Bearer Information Transport information" from the CSF to the BIWF. It is also used to indicate to the BIWF that a Bearer Information Transport tunnel can be used. The "Bearer Information Transport" tunnel information can be used as a stand alone procedure primitive or may be used in conjunction with another procedure primitives, for example "Establish\_BNC\_Notify". Likewise the response to a procedure primitive may be associated with another procedure primitive.

**0a Stimulus**

**Address Information**

See relevant flow in Signalling Flows for the support of BICC Capability Set 2 [1]

**Control information**

**Bearer information**

**Initiation of information flow:** See "Signalling Flows for the support of BICC Capability Set 2" [1] for flows which lead to the initiation of Call Bearer Control signalling. The tunnel primitive may be used in conjunction with the other primitives in clause 8.

**Processing upon receipt:** If the CSM determines that the tunnelling mechanism is used it initiates Flow 1. It gives a Tunnel Indication and specifies when the BIT is to be returned to the CSF.

**OR**

**0b APM("Tunnel")**

**CSM to CSM**

**Address Information**

**Control information**

Bearer Information Transport

**Bearer information**

**Initiation of information flow:** Actions at peer CSM

**Processing upon receipt:** If the CSM determines that the tunnelling mechanism is used it initiates Flow 1. It places the Bearer Information Transport information in the Tunnel primitive.



---

<b>1</b>	<b>ADD.req/MOD.req/MOV.req (...Tunnel)</b>	<b>CSM to BIWF</b>
----------	--	--------------------

**Address Information**

**Control information**

**Bearer information**

If flow 0a is received:

As per the primitive that this is combined with.

If flow 0b is received:

Transaction ID = 1000  
Context ID = c1  
Termination ID = bearer1  
Tunnel Indication  
Bearer Information Transport

In either case above:

Tunnel Indication = ? / no / 1 / 2

**Initiation of information flow:** The CSM deciding to use the tunnelling mechanism.

**Processing upon receipt:** When the BIWF receives Information Flow 1 it validates the request and understands that the tunnelling mechanism must be used.

When Bearer Information Transport information is received the BIWF shall act according to the information contained in the object. Ie. Process a bearer-setup-req.

If only a Tunnel indication is received the BIWF shall return the Bearer Information Transport in a Notify.ind according to what type of response was requested.

---

<b>2</b>	<b>ADD.resp, MOD.resp, MOV.resp</b>	<b>BIWF to CSM</b>
----------	-------------------------------------	--------------------

**Address Information**

**Control information**

**Bearer information**

If flow 0a is received:

As per ("Establish\_BNC\_Notify")

If flow 0b is received:

Transaction ID = 1000  
Context ID = c1

If requested:

Tunnel Option = no / 1 / 2

**Initiation of information flow:** Receipt of Information Flow 1

**Processing upon receipt:** When the CSM receives the response it continues the call processing.

---

<b>3</b>	<b>Notify.ind</b>	<b>BIWF to CSM</b>
----------	-------------------	--------------------

**Address Information**

**Control information**

**Bearer information**

Transaction ID = 100y  
Termination ID = bearer1  
Context ID = c1

Bearer Information Transport

**Initiation of information flow:** Bearer Control signalling in the BIWF using a tunnel.

**Processing upon receipt:** The CSM shall take the Bearer Information Transport information and send it to a peer node.

---

<b>4</b>	<b>Notify.resp</b>	<b>CSM to BIWF</b>
----------	--------------------	--------------------

**Address Information**

**Control information**

**Bearer information**

Transaction ID = 100y  
Termination ID = bearer1,  
Context ID = c1

**Initiation of information flow:** Receipt of Flow 3.

**Processing upon receipt:** –

## 8.2 Reuse of idle Bearers

### 8.2.1 Establish BNC

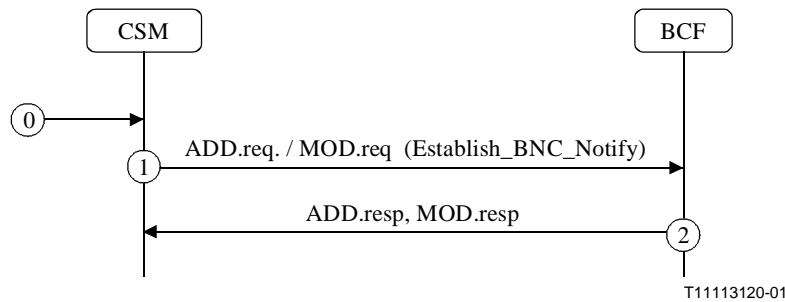

**Figure 15 – Indication to reuse an Idle Bearer on BNC Establishment**

The following numbered items describe the numbered flows shown above.

---

#### 0 Stimulus

**Address Information**

See relevant flow in Signalling Flows for the support of BICC Capability Set 2 [1]

**Control information**

**Bearer information**

**Initiation of information flow:** See "Signalling Flows for the support of BICC Capability Set 2" [1] for flows which lead to the initiation of Call Bearer Control signalling.

**Processing upon receipt:** As per clause 8.1.2 Information Flow 0.

---

#### 1 ADD.req/MOD.req (Establish BNC Notify) CSM to BIWF

**Address Information**

T-BWIF-Address = X

**Control information**

Transaction ID = 1001  
Context ID = c1

**Termination Requested:**

Termination ID = ?

**Termination Provided:**

Termination ID = bearer1

**Bearer information**

BNC-id = x1

**Termination Requested:**

BNC Characteristics

**No Codec Negotiation:**

Bearer Service Characteristics

**Codec Negotiation:**

Codec

**Initiation of information flow:** Information Flow 0.

**Processing upon receipt:** As per clause 8.1.2 Information Flow 1 with the following additions.

If the BIWF determines that an idle bearer is to be used it will send an indication "re-use\_idle" and the BNC-ID of the idle bearer. If the CSF had requested the BIWF to choose a termination ID, the BIWF shall return the termination ID of the termination that relates to the idle bearer. If a termination is provided in Information Flow 2 the CSM will initiate the procedures of clause 8.2.2.

**Address Information****Control information**

Transaction ID = 1001  
Context ID = c1  
Reuse-Idle\_indication

**Bearer information**

BNC-id = Reuse\_IDLE

**Termination Requested:**

Termination ID = idle\_bearer

**Initiation of information flow:** Receipt of Information Flow 1.

**Processing upon receipt:** When the CSM receives the response, it continues the call processing.

### 8.2.2 Reuse\_IDLE

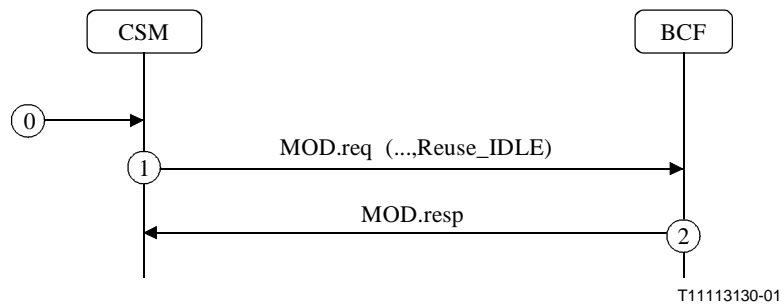

**Figure 16 – Indication to reuse an Idle Bearer**

The following numbered items describe the numbered flows shown above.

#### 0 Stimulus

**Address Information**

See relevant flow in Signalling Flows for the support of BICC Capability Set 2 [1]

**Control information****Bearer information**

**Initiation of information flow:** See "Signalling Flows for the support of BICC Capability Set 2" [1] for flows which lead to the initiation of Call Bearer Control signalling.

**Processing upon receipt:**

#### 1 MOD.req (...;Reuse\_IDLE)

CSM to BIWF

**Address Information**

T-BWIF-Address = X

**Control information**

Transaction ID = 1001  
Context ID = c1  
Termination ID = bearer1

**Bearer information**

BNC-id = Reuse\_IDLE

**Initiation of information flow:** Information Flow 0.

**Processing upon receipt:** Associate the Bearer Represented by the BNC-id = Reuse\_IDLE. This termination will relate to the idle bearer.

#### 2 MOD.resp

BIWF to CSM

**Address Information****Control information**

Transaction ID = 1001  
Context ID = c1  
Termination ID = bearer1

**Bearer information**

**Initiation of information flow:** Selection of the IDLE bearer.

**Processing upon receipt:** The CSM continues call processing.

### 8.3 Bearer Topology

In accordance with ITU-T H.248, when a termination is added to a context, the default connection between terminations is "both way" unless indicated otherwise by a Topology change.

#### 8.3.1 Isolate

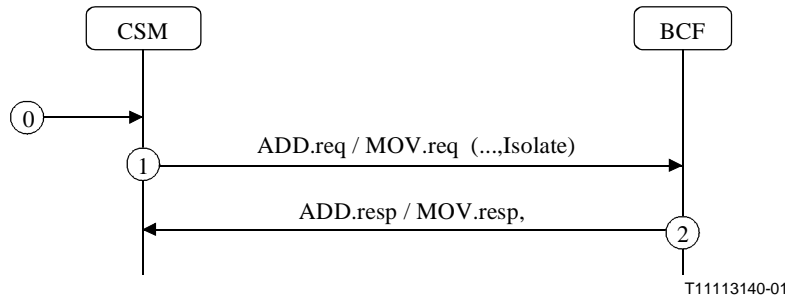

**Figure 17 –Isolate Termination**

The following numbered items describe the numbered flows shown above.

---

**0 Stimulus**

Address Information

Control information

Bearer information

See relevant flow in Signalling Flows for the support of BICC Capability Set 2 [1]

**Initiation of information flow:** See Signalling Flows for the support of BICC Capability Set 2 [1] for flows which lead to the initiation of Call Bearer Control signalling.

**Processing upon receipt:** The CSM will:

- In the case of a termination already in a context association, will order the BIWF to move (using MOV.req) the existing termination to a new context where it will be effectively isolated. The connection of the termination to other terminations in the existing context will be removed.
- In the case that the termination is to be created the CSM will include (using ADD.req) only the specified termination in a context where it will be effectively isolated.

The Context provided indicates the destination context of the isolated Termination and NOT the current context the termination is associated with.

---

**1 MOV.req / ADD.req (... isolate)**

**CSM to BIWF**

Address Information

Control information

Bearer information

Transaction ID = 1000

In the case of MOV:

Termination ID = Bearer1

If context is NOT provided:

Context ID = ?

If the context is provided:

Context ID = c1

In the case of ADD:

Termination ID = ?

Context ID = ?

**Initiation of information flow:** Flow 0.

**Processing upon receipt:** When the BIWF receives the move request it will move the termination from the context association where it is currently residing and move it to a new context association. When the termination is moved the BIWF will break any media connections in the existing context and when placed in the new context shall be isolated. Once the termination is moved the BIWF shall send Flow 2.

When the BIWF receives an add request it will isolate the termination with it's own context association. As the termination is added to a context it has no previously established connections and will be isolate.

---

2	<b>MOV.resp / ADD.resp</b>	<b>BIWF to CSM</b>	
	<p><u>Address Information</u></p>	<p><u>Control information</u>          Transaction ID = 1000          Termination ID = bearer1          Context ID = c1</p>	<p><u>Bearer information</u></p>

**Initiation of information flow:** The placement a termination in a context.

**Processing upon receipt:** The CSM shall continue call processing.

### 8.3.2 Join

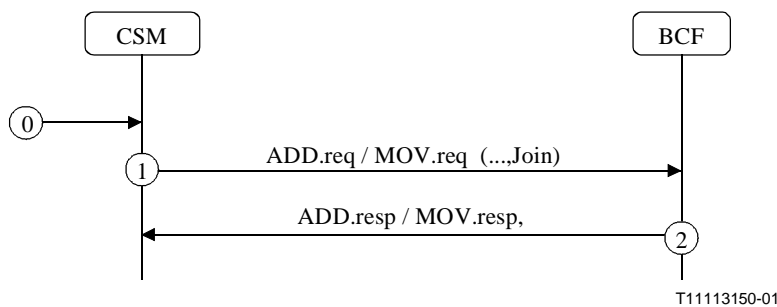

**Figure 18 – Join Termination**

The following numbered items describe the numbered flows shown above.

---

0	<b>Stimulus</b>		
	<p><u>Address Information</u></p>	<p><u>Control information</u></p>	<p><u>Bearer information</u></p>
	See relevant flow in Signalling Flows for the support of BICC Capability Set 2 [1]		

**Initiation of information flow:** See Signalling Flows for the support of BICC Capability Set 2 [1] for flows which lead to the initiation of Call Bearer Control signalling.

**Processing upon receipt:** The CSM will:

- In the case of a termination already in a context association, will order the BIWF to move (using MOV.req) the existing termination to a new context. The connection of the termination to other terminations in the existing context will be removed and when the termination is placed in the new context association it will be connected to the other terminations in the new context.

- In the case that the termination is to be created, the CSM will specify (using ADD.req) the context association that the termination will be added to. Once added the termination shall be connected to other terminations.

The Context provided indicates the destination context of the joined Termination and NOT the current context the termination is associated with.

1	MOV.req / ADD.req (... , Join)	CSM to BIWF
	<u>Address Information</u>	<u>Control information</u> Transaction ID = 1000 Context ID = c1  <u>In the case of MOV:</u> Termination ID = Bearer1  <u>In the case of ADD:</u> Termination ID = ?
		<u>Bearer information</u>

**Initiation of information flow:** Flow 0.

**Processing upon receipt:** When the BIWF receives a move request, it will move the termination from the context association where it is currently residing and move it to a new context association. When the termination is moved the BIWF will break any media connections in the existing context and when placed in the new context it shall establishment connections to the other terminations in the context association.

When the BIWF receives an add request, it will add the termination to an existing context association. When placed in the context it shall establishment connections to the other terminations in the context association.

Once the termination is moved or added the BIWF shall send Flow 2.

2	MOV.resp / ADD.resp	BIWF to CSM
	<u>Address Information</u>	<u>Control information</u> Transaction ID = 1000 Termination ID = bearer1 Context ID = c1
		<u>Bearer information</u>

**Initiation of information flow:** The placement a termination in a context.

**Processing upon receipt:** The CSM shall continue call processing.

### 8.3.3 Change Connection Topology

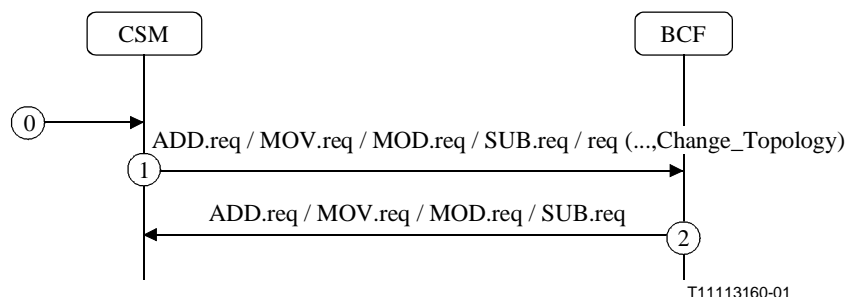

**Figure 19 – Change Connection Topology**

NOTE – The Change Topology primitive does not have to be associated with a XXX.req request as the primitive operates on the context, not on a termination.

The following numbered items describe the numbered flows shown above.

---

**0 Stimulus**

**Address Information**

**Control information**

**Bearer information**

See relevant flow in Signalling Flows for the support of BICC Capability Set 2 [1]

**Initiation of information flow:** See Signalling Flows for the support of BICC Capability Set 2 [1] for flows which lead to the initiation of Call Bearer Control signalling.

**Processing upon receipt:** The CSM will order the BIWF to change the topology of the connections between the terminations in the specified context association by changing the Connection Topology

---

**1 MOV.req / ADD.req / MOD.req /. req (... , Change\_Topology)**

**CSM to BIWF**

**Address Information**

**Control information**

**Bearer information**

Transaction ID = 1000  
Context ID = c1

(TerminationID= x1,  
TerminationID=x2, ...)

Connection Configuration = Type x

**Initiation of information flow:** Flow 0.

**Processing upon receipt:** When the BIWF receives a topology change request, it will change the state of the established connections in the context association. The streams association with the terminations shall remain the same however how they are connected internally in the BIWF shall change. The BIWF shall change the connection according to TerminationID pairs provided in the request according to one of the connection configuration states. The change of topology on one termination shall not be visible on other terminations.

Once the BIWF has changed to the desired topology it will reply with Flow 2.

---

**2 MOV.resp / ADD.resp / MOD.resp /. resp**

**BIWF to CSM**

**Address Information**

**Control information**

**Bearer information**

Transaction ID = 1000  
Context ID = c1

**Initiation of information flow:** A change in topology.

**Processing upon receipt:** The CSM shall continue call processing.

## 8.4 Echo Celler Control

### 8.4.1 Echo Celler

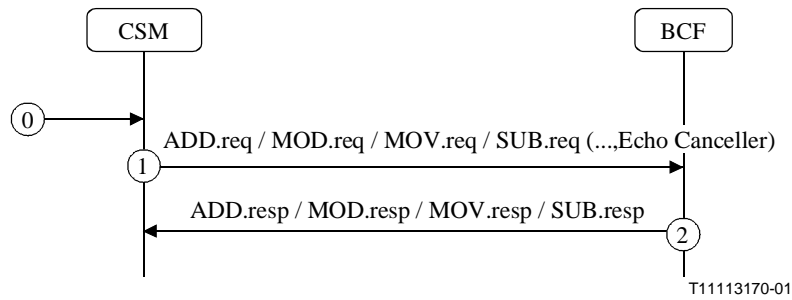

**Figure 20 – Echo Celler**

The following numbered items describe the numbered flows shown above.

**0 Stimulus**

Address Information

Control information

Bearer information

**Initiation of information flow:** Determination that an echo canceller needs to be inserted.

**Processing upon receipt:** The initiation of Flow 1.

**1 ADD.req/MOD.req / MOV.req (Echo Celler) CSM to BIWF**

Address Information

Control information

Bearer information

Transaction ID = 1000  
Context ID = c1  
Termination ID = x  
Cancel Echo = on / off

**Initiation of information flow:** Information Flow 0.

**Processing upon receipt:** The BIWF will associate the relevant echo canceller resources with the specified termination.

**2 ADD.resp / MOD.resp / MOV.resp CSM to BIWF**

Address Information

Control information

Bearer information

Transaction ID = 1000  
Context ID = c1

**Initiation of information flow:** Receipt of Information Flow 1.

**Processing upon receipt:** –



## 8.5 Unsuccessful BNC Establishment

### 8.5.1 Unsuccessful BNC Establishment with notification on BNC establishment

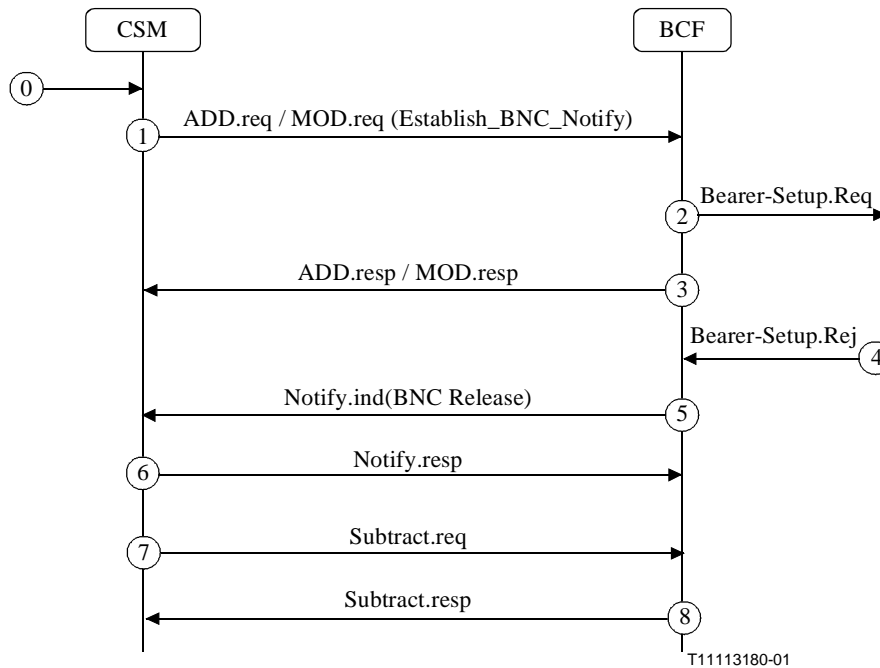

Figure 21 – Unsuccessful BNC establishment with notification

The following numbered items describe the numbered flows shown above.

#### 0 Stimulus

##### Address Information

See relevant flow in Signalling Flows for the support of BICC Capability Set 2 [1]

##### Control information

##### Bearer information

**Initiation of information flow:** See "Signalling Flows for the support of BICC Capability Set 2" [1] for flows which lead to the initiation of Call Bearer Control signalling.

**Processing upon receipt:** As per 8.1.2 Information Flow 0.

#### 1 ADD.req/MOD.req (Establish BNC Notify)

CSM to BIWF

##### Address Information

T-BWIF-Address = X

##### Control information

As per 8.1.2 Information Flow 0 with the following addition:  
NotificationRequested (Event ID = x, "BNC Release")

##### Bearer information

**Initiation of information flow:** Information Flow 0.

**Processing upon receipt:** As per 8.1.2 Information Flow 0. NotificationRequested "BNC Release" is an explicit indication that notification of "BNC Release" is required, see clause 8, Note 3.

#### 2 Bearer-Setup.Req

BIWF to BIWF-x

##### Address Information

T-BWIF Addr = x1

##### Control information

BCS-id = 66

##### Bearer information

BNC-ID=x1  
BNCL-ID=999  
BNCL characteristics

**Initiation of information flow:** Receipt of Information Flow 1.

**Processing upon receipt:** –

---

3	ADD.resp/MOD.resp	<b>BIWF to CSM</b>	
	<u>Address Information</u>	<u>Control information</u> As per 8.1.2 Information Flow 3.	<u>Bearer information</u>

**Initiation of information flow:** Receipt of Information Flow 1.

**Processing upon receipt:** When the CSM receives the response, it continues the call processing.

---

4	Bearer-Setup.Rej	<b>BIWF-x to BIWF</b>	
	<u>Address Information</u>	<u>Control information</u> BCS-id = 66	<u>Bearer information</u> Release Cause

**Initiation of information flow:** BIWF-X initiating Bearer-Setup.Rej information flow.

**Processing upon receipt:** When the BIWF receives the information flow Bearer-Setup.Rej, it shall inform the CSM with Information Flow 5. The release cause is included in Flow 5. Transaction ID 1002 is selected for this purpose.

---

5	Notify.ind (BNC Release)	<b>BIWF to CSM</b>	
	<u>Address Information</u>	<u>Control information</u> Transaction ID = 1002 Termination ID = bearer1 Event (Event ID = x, "BNC Release(Release Cause)") Context ID = c1	<u>Bearer information</u>

**Initiation of information flow:** Receipt of Information Flow 4.

**Processing upon receipt:** The CSM will reply to the Notify with Information Flow 6. The CSM will request the BIWF to release termination ID "bearer1" with Information Flow 7. Transaction ID 1005 is used for this purpose.

---

6	Notify.resp	<b>CSM to BIWF</b>	
	<u>Address Information</u>	<u>Control information</u> Transaction ID = 1002 Context ID = c1	<u>Bearer information</u>

**Initiation of information flow:** Receipt of Information Flow 5.

**Processing upon receipt:** –

---

7	SUB.req	<b>CSM to BIWF</b>	
	<u>Address Information</u>	<u>Control information</u> Transaction ID = 1003 Termination ID = bearer1 Context ID = c1	<u>Bearer information</u>

**Initiation of information flow:** Receipt of Information Flow 5.

**Processing upon receipt:** The BIWF will free the resources associated with termination ID "bearer1" and inform the CSM that this is complete with Information Flow 8.

---

<b>8</b>	<b>SUB.resp</b>	<b>BIWF to CSM</b>	
	<p><u>Address Information</u></p>	<p><u>Control information</u>            Transaction ID = 1003            Termination ID = bearer1            Context ID = c1</p>	<p><u>Bearer information</u></p>

**Initiation of information flow:** Receipt of Information Flow 7.

**Processing upon receipt:** The CSM will release its resources associated with termination ID "bearer1" and continue call processing.

### 8.6 Bearer Initiated Release

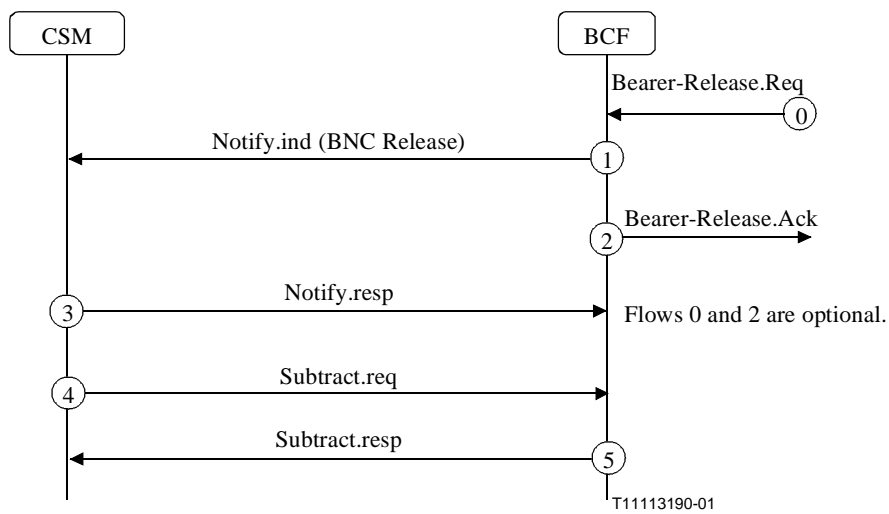

NOTE – Flow 1 may be sent after Flows 2.

**Figure 22 – Bearer Release**

The following numbered items describe the numbered flows shown above.

---

<b>0</b>	<b>Bearer-Release.Reg</b>	<b>BIWF-x to BIWF</b>	
	<p><u>Address Information</u></p>	<p><u>Control information</u>            BCS-id = 66</p>	<p><u>Bearer information</u>            Cause</p>

**Initiation of information flow:** –

**Processing upon receipt:** When the BIWF receives the information flow Bearer-Release.Reg, it will reply with Information Flow 1, and it will inform the CSM with Information Flow 1. The cause is included in Flow 1. Transaction ID 1000 is selected for this purpose.

---

<b>1</b>	<b>Notify.ind (BNC Release)</b>	<b>BIWF to CSM</b>	
	<p><u>Address Information</u></p>	<p><u>Control information</u>            Transaction ID = 1000            Termination ID = bearer1            Event (Event ID = x,"BNC Release(Cause)")            Context ID = c1</p>	<p><u>Bearer information</u></p>

**Initiation of information flow:** Receipt of Information Flow 0 alternatively the BIWF may detect a BNC failure which would generate a notification. The Notification Request for "BNC Release" has been already connected, see clause 7, Note 3.

**Processing upon receipt:** The CSM will reply to the Notify with Information Flow 3. The CSM will request the BIWF to release termination ID "bearer 1" with Information Flow 4. Transaction ID 1001 is used for this purpose.

---

2	<b>Bearer-Release.Ack</b>	<b>BIWF to BIWF-x</b>
	<u>Address Information</u>	<u>Control information</u> BCS-id = 66
		<u>Bearer information</u>

**Initiation of information flow:** Receipt of Information Flow 0.

**Processing upon receipt:** –

---

3	Notify.resp	CSM to BIWF
	<u>Address Information</u>	<u>Control information</u> Transaction ID = 1000 Context ID = c1
		<u>Bearer information</u>

**Initiation of information flow:** Receipt of Information Flow 1.

**Processing upon receipt:** Upon receipt of Information Flow 3 the CSM will initiate Information Flow 4.

---

4	SUB.req	CSM to BIWF
	<u>Address Information</u>	<u>Control information</u> Transaction ID = 1001 Termination ID = bearer1 Context ID = c1
		<u>Bearer information</u>

**Initiation of information flow:** Receipt of Information Flow 2.

**Processing upon receipt:** The BIWF will free the resources associated with termination ID "bearer1" and inform the CSM that this is complete with Information Flow 5.

---

5	SUB.resp	BIWF to CSM
	<u>Address Information</u>	<u>Control information</u> Transaction ID = 1001 Termination ID = bearer1 Context ID = c1
		<u>Bearer information</u>

**Initiation of information flow:** Receipt of Information Flow 4.

**Processing upon receipt:** The CSM will release its resources associated with termination ID "bearer1" and continue call processing.

## 8.7 Media Content Insertion

### 8.7.1 Insert Tone

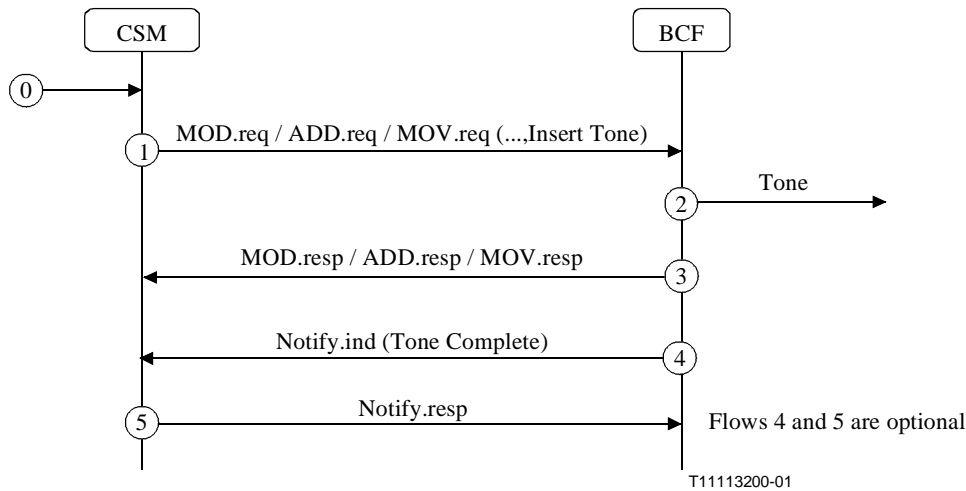

**Figure 23 – Insert Tone**

The following numbered items describe the numbered flows shown above.

---

**0 Stimulus**

Address Information

Control information

Bearer information

**Initiation of information flow: –**

**Processing upon receipt:** When the CSM wishes to send a tone, the CSM selects the tone ID to be inserted into the media stream/user data flow and it sends it Information Flow 1 indicating the tone to be inserted into the media stream. The CSM selects transaction ID of 1000 to be used. If a termination exists for the stream the CSM shall send a MOD.req otherwise the CSM shall send an ADD.req.

---

**1 MOD.req / ADD.req / MOV.req (Insert Tone)**

**CSM to BIWF**

Address Information

Control information

Bearer information

Transaction ID = 1000  
 Context ID = c1  
 Signal Direction  
 Signal Timing  
 Signal = Tone.ID

If Termination is exists:  
 Termination ID = bearer1

If Termination does NOT exists:  
 Termination ID = ?

If notification of tone completed is required:  
 Notification required = (Event ID = x,  
 "Signal.completion(Tone)")

**Initiation of information flow: Stimulus.**

**Processing upon receipt:** When the BIWF receives the Modify request, it inserts the requested tone according to the SignalDirection and Signal Timing in Information Flow 2 into the media stream associated with termination ID "bearer1", and returns the response Information Flow 3. If Tone (Signal.completion) is requested when the tone finishes playing the BIWF shall return an indication in Flow 4.

---

<b>2</b>	<b>Tone</b>	<b>BIWF to BIWF-x</b>
	<u>Address Information</u>	<u>Control information</u>
		<u>Bearer information</u>

**Initiation of information flow:** Information Flow 1.

---

<b>3</b>	MOD.resp /ADD.resp / MOV.resp	<b>BIWF to CSM</b>
	<u>Address Information</u>	<u>Control information</u>
		<u>Bearer information</u>
		Transaction-id = 1000 Termination ID = bearer1 Context ID = c1

**Initiation of information flow:** Initiation of Information Flow 2.

**Processing upon receipt:** When the CSM receives the response, it continues call processing as per the tone being sent unless it requested notification of tone completion, Flow 4.

---

<b>4</b>	Notify.ind (Signal.completion)	<b>BIWF to CSM</b>
	<u>Address Information</u>	<u>Control information</u>
		<u>Bearer information</u>
		Transaction ID = 1000 Termination ID = bearer1 Event =(Event ID = x, "Signal.Completion(ToneID)") Context ID = c1

**Initiation of information flow:** The completion of playing the Tone from Information Flow 2 and a request to send a notification of completion in Information Flow 1.

**Processing upon receipt:** When the CSM receives the response, it continues call processing as per the tone being sent.

---

<b>5</b>	Notify.resp	<b>CSM to BIWF</b>
	<u>Address Information</u>	<u>Control information</u>
		<u>Bearer information</u>
		Transaction ID = 1000 Context ID = c1 Termination ID = bearer1

**Initiation of information flow:** Receipt of Information Flow 4.

**Processing upon receipt:** –

## 8.7.2 Insert Digit

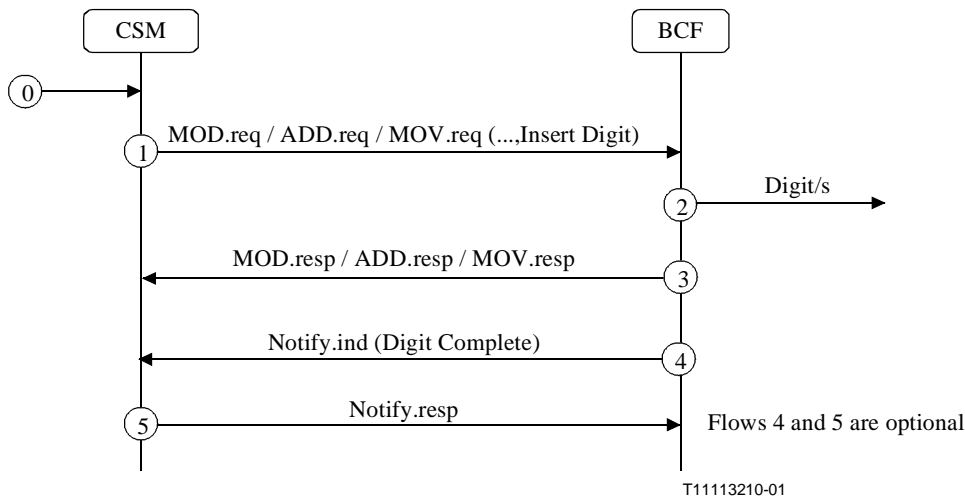

**Figure 24 – Insert Digit**

The following numbered items describe the numbered flows shown above.

**0 Stimulus**

Address Information

Control information

Bearer information

**Initiation of information flow: –**

**Processing upon receipt:** When the CSM wishes to send a digit/s, the CSM selects the digit/s to be inserted into the media stream/user data flow and it sends it Information Flow 1 indicating the digit/s to be inserted into the media stream. The CSM selects transaction ID of 1000 to be used. If a termination exists for the stream the CSM shall send a MOD.req otherwise the CSM shall send an ADD.req.

**1 MOD.req / ADD.req / MOV.req (Insert Digit)**

**CSM to BIWF**

Address Information

Control information

Bearer information

Transaction ID = 1000  
Context ID = c1  
Signal Timing  
Signal = Digit/s

If Termination is exists:  
Termination ID = bearer1

If Termination does NOT exists:  
Termination ID = ?

If notification of digits completed is required:  
Notification required (Event ID = x, "Signal.Completion(Digit)")

**Initiation of information flow: Stimulus.**

**Processing upon receipt:** When the BIWF receives the Modify request, it inserts the requested digits in Information Flow 2 according to the Signal Timing into the media stream associated with

termination ID "bearer1", and returns the response Information Flow 3. If Tone (Signal.completion) is requested when the digit finishes playing the BIWF shall return an indication in Flow 4.

---

<b>2</b>	<b>Digit/s</b>	<b>BIWF to BIWF-x</b>
	<b><u>Address Information</u></b>	<b><u>Control information</u></b>
		<b><u>Bearer information</u></b>

**Initiation of information flow:** Information Flow 1.

---

<b>3</b>	<b>MOD.resp /ADD.resp / MOV.resp</b>	<b>BIWF to CSM</b>
	<b><u>Address Information</u></b>	<b><u>Control information</u></b>
		<b><u>Bearer information</u></b>
		Transaction ID = 1000 Termination ID = bearer1 Context ID = c1

**Initiation of information flow:** Initiation of Information Flow 2.

**Processing upon receipt:** When the CSM receives the response, it continues call processing as per the tone being sent unless it requested notification of tone completion, Flow 4.

---

<b>4</b>	<b>Notify.ind (Signal.Completion)</b>	<b>BIWF to CSM</b>
	<b><u>Address Information</u></b>	<b><u>Control information</u></b>
		<b><u>Bearer information</u></b>
		Transaction ID = 1000 Termination ID = bearer1 Event (Event ID = x, "Signal.Completion(Digit/s)") Context ID = c1

**Initiation of information flow:** The completion of playing the Tone from Information Flow 2 and a request to send a notification of completion in Information Flow 1.

**Processing upon receipt:** When the CSM receives the response, it continues call processing as per the tone being sent.

---

<b>5</b>	<b>Notify.resp</b>	<b>CSM to BIWF</b>
	<b><u>Address Information</u></b>	<b><u>Control information</u></b>
		<b><u>Bearer information</u></b>
		Transaction ID = 1000 Context ID = c1 Termination ID = bearer1

**Initiation of information flow:** Receipt of Information Flow 4.

**Processing upon receipt:** –



### 8.7.3 Insert Announcement

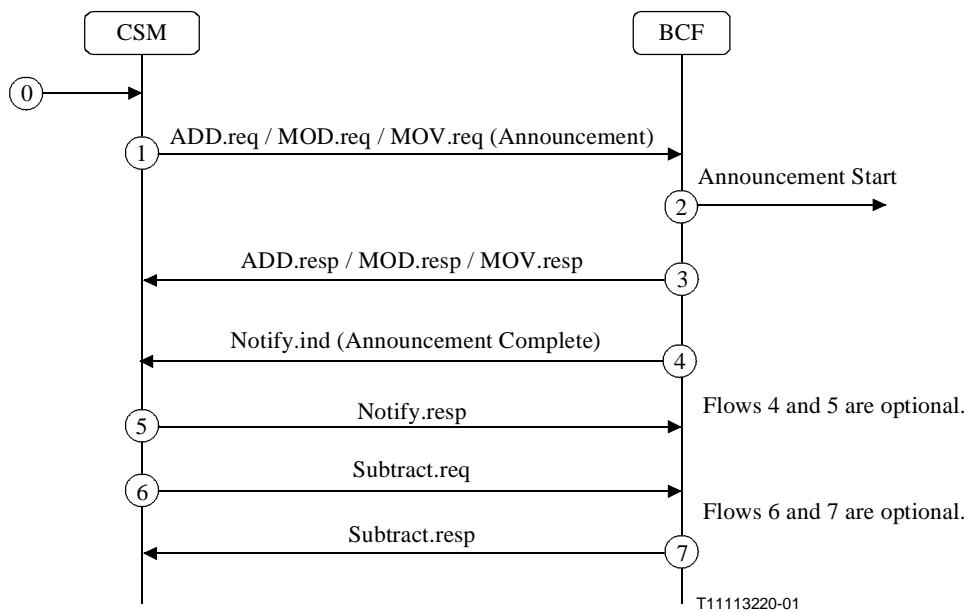

**Figure 25 – Insert Announcement**

NOTE – The announcement primitive in this Supplement is only for simple announcements and not meant to represent all the functionality associated with announcement services, ie. variable announcements.

The following numbered items describe the numbered flows shown above.

**0 Stimulus**

Address Information

Control information

Bearer information

**Initiation of information flow: –**

**Processing upon receipt:** When the CSM wishes to send an announcement, it selects the announcement to be inserted into the media stream on a particular termination with Signal = "announcement". The CSM selects transaction ID 1000 to be used.

In the case that the CSM wants to play an announcement on a single termination associated with a particular context it shall:

- Provide the Termination ID on and to which the announcement is to be played

In the case that the CSM wants to play an announcement to one or more termination associated with a context it shall:

- Request a termination ID which represents the announcement with an ADD.req if the termination is not known.
- Provide a termination ID which represents the announcement with an MOD.req if the termination is known.
- Set the direction of the announcement to play to all the terminations
- Set the mode of the termination to send only.
- A MOV.req may be required before the issuing of the ADD.req (Announcement) to remove terminations from the current context association so that the announcement is not received

on the removed termination. Alternatively, terminations may be isolated by changing the Connection Topology.

- When the announcement is complete a later SUB.req may be sent if no other announcements will be played in the context.

---

**1        ADD.req / MOD.req / MOV.req (Announcement)        CSM to BIWF**

**Address Information**

**Control information**

**Bearer information**

Transaction ID = 1000  
Context ID = c1  
Signal = announcement.ID  
Signal Direction  
Signal Timing

Single Termination:  
Termination ID = bearer1

Multiple Termination:  
Termination ID = ?  
Streammode = send only

If notification of Announcement completion is required:  
Notification required (Event ID = x,  
"Signal.completion(Announcement)")

**Initiation of information flow: Stimulus**

**Processing upon receipt:** Upon receipt of the MOD.req / MOV.req to insert an announcement on an existing termination, the BIWF plays the specified announcement on that termination.

Upon receipt of the ADD.req to insert an announcement, the BIWF creates the announcement termination (Termination ID = ?), and connects it to the existing terminations associated with the context. The BIWF then inserts the requested announcement into the media stream.

The announcement is played according to the signal direction and timing.

If notification is requested, then after the completion of the announcement, the Notification will be sent in Flow 4.

---

**2        Announcement Start        BIWF to BIWF-x**

**Address Information**

**Control information**

**Bearer information**

**Initiation of information flow: Information Flow 1.**

---

**3        ADD.resp / MOD.resp / MOV.resp        BIWF to CSM**

**Address Information**

**Control information**

**Bearer information**

Transaction ID = 1000  
Context ID = c1  
If the termination ID was given:  
Termination ID = bearer1

If the termination ID was requested:  
Termination ID = announ1

**Initiation of information flow: Initiation of announcement, Flow 2.**

**Processing upon receipt:** The CSM performs the actions it is required to execute after the announcement is initiated.

In the event that Notification is not required, then the CSM may remove the announcement termination after waiting an appropriate time for announcement completion with Information Flow 6, otherwise Information Flow 6 is initiated after the receipt of the Notify Information Flow 4. When the Information Flow 6 is issued, the MGC selects transaction ID 1001. When the BIWF sends the Notify, it chooses transaction ID of 0500.

---

<b>4</b>	<b>Notify.ind (Announcement Complete)</b>	<b>BIWF to CSM</b>
	<b><u>Address Information</u></b>	<b><u>Control information</u></b> Transaction ID = 0500 Termination ID = bearer1 Context ID = c1 Event (Event ID = x, "Signal.Completion(Announcement ID)")
		<b><u>Bearer information</u></b>

**Initiation of information flow:** The completion of the announcement specified, Flow 2.

**Processing upon receipt:** When the CSM initiates the call control actions required at the completion of the announcement. The CSM also initiates Notify-resp Information Flow 5. The removal of the announcement termination is initiated with Information Flow 6.

---

<b>5</b>	<b>Notify.resp</b>	<b>CSM to BIWF</b>
	<b><u>Address Information</u></b>	<b><u>Control information</u></b> Transaction ID = 0500 Context ID = c1 Termination ID = bearer1
		<b><u>Bearer information</u></b>

**Initiation of information flow:** Receipt of Information Flow 4.

**Processing upon receipt:** -

---

<b>6</b>	<b>SUB.req</b>	<b>CSM to BIWF</b>
	<b><u>Address Information</u></b>	<b><u>Control information</u></b> Transaction ID = 1001 Context ID = c1 Termination ID = announ1
		<b><u>Bearer information</u></b>

**Initiation of information flow:** Information Flow 3 or 4.

**Processing upon receipt:** The BIWF releases the announcement termination. The BIWF replies to the CSM with the Subtract-resp Information Flow 7.

---

<b>7</b>	<b>SUB.resp</b>	<b>BIWF to CSM</b>
	<b><u>Address Information</u></b>	<b><u>Control information</u></b> Context ID = c1 Transaction ID = 1001 Termination ID = announ1
		<b><u>Bearer information</u></b>

**Initiation of information flow:** Receipt of Information Flow 6.

**Processing upon receipt:** The CSM initiates the call control actions required at the release of the announcement resources. The CSM may move the terminations back to the their original context associations or Connection Topology before the announcement was ordered.

## 8.8 Media Content Detection

### 8.8.1 Detect Digit

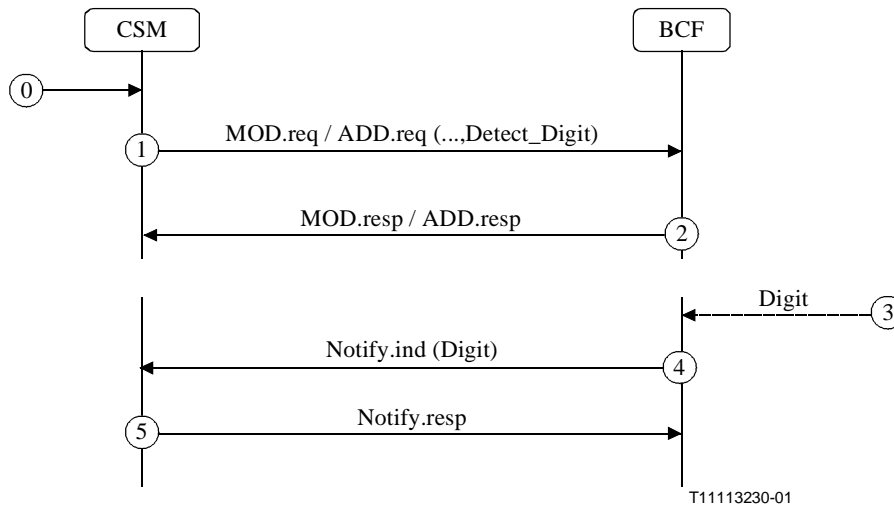

**Figure 26 – Detect Digit**

The following numbered items describe the numbered flows shown above.

**0 Stimulus**

Address Information

Control information

Bearer information

**Initiation of information flow: –**

**Processing upon receipt:** When the CSM wishes to detect a digit, the CSM specifies that it be notified of the occurrence of the DTMF digit by requesting notification of the digit event. It may also request the timing and direction that the digits are received. The CSM selects transaction ID of 1000 to be used. The Detect\_Digit primitive may be used in conjunction with other primitives.

**1 MOD.req / ADD.req (Detect\_Digit)**

**CSM to BIWF**

Address Information

Control information

Bearer information

Transaction ID = 1000  
 Termination ID = bearer1  
 Context ID = c1  
 NotificationRequested (Event ID = x,  
 "Detect\_Digit(Digit,Timing)")

**Initiation of information flow: Stimulus.**

**Processing upon receipt:** When the BIWF receives the request to detect a digit it shall send Flow 2 as an acknowledgement to the request. It shall reserve resources associated with the detection of the DTMF digits and when the digit is detected the BIWF shall send Information Flow 4.

**2 MOD.resp /ADD.resp**

**BIWF to CSM**

Address Information

Control information

Bearer information

Transaction-id = 1000  
 Termination ID = bearer1  
 Context ID = c1

**Initiation of information flow:** Receipt of Information Flow 1.

**Processing upon receipt:** When the CSM receives the response, it continues call processing and awaits the detection of the specified digit/s.

---

3      Digit      BIWF to BIWF-x

Address Information

Control information

Bearer information  
DTMF Digit/s

**Initiation of information flow:** External Stimulus

**Processing upon receipt:** When the BIWF detects the digit/s an event is triggered and Information Flow 4 is initiated.

---

4      Notify.ind (Detect\_Digit)      BIWF to CSM

Address Information

Control information  
Transaction ID = 1000  
Termination ID = bearer1  
Context ID = c1  
Event (Event ID = x,  
"Detect\_Digit(Digit, Timing)")

Bearer information

**Initiation of information flow:** The detection of the specified digit, Information Flow 3.

**Processing upon receipt:** When the CSM receives the response, it continues call processing with the information that the digit has been detected.

---

5      Notify.resp      CSM to BIWF

Address Information

Control information  
Transaction ID = 1000  
Context ID = c1  
Termination ID = bearer1

Bearer information

**Initiation of information flow:** Receipt of Information Flow 4.

**Processing upon receipt:** –

## 8.9 Cut BNC

The primitives below show Release where the BIWF combines multiple actions (ie. bearer release signalling, breaks the connection and removes the termination) in one transaction. These actions may be achieved individually in their own primitive for:

- Bearer Release Signalling, by sending a MOD.req and MOD.reply with a signal "BNC Release"
- Breaking the Connection, by sending a MOD.req and MOD.reply indicating that the cut through direction is send / receive / inactive.
- Removing the termination, by sending a SUB.req and SUB.resp.

### 8.9.1 Release

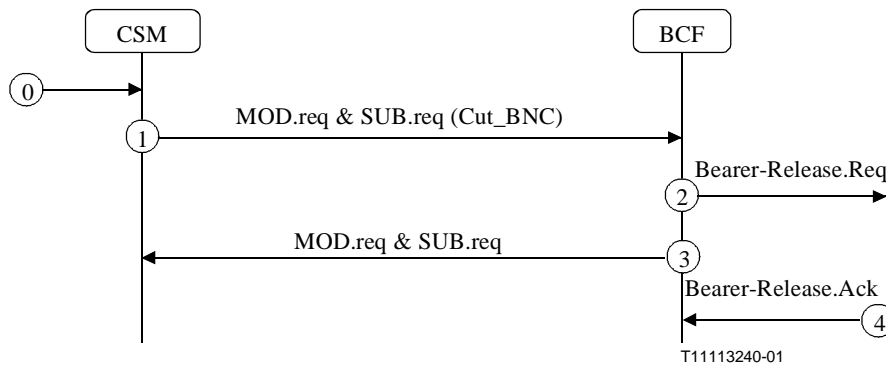

NOTE – Flows 2 and 4 are optional.

**Figure 27 – Cut BNC**

The following numbered items describe the numbered flows shown above.

<b>0</b>	<b>Stimulus</b>	<b>CSM to CSM</b>
	<p><u>Address Information</u> See relevant flow in Signalling Flows for the support of BICC Capability Set 2 [1]</p>	<p><u>Control information</u> <u>Bearer information</u></p>
	<p><b>Initiation of information flow:</b> See "Signalling Flows for the support of BICC Capability Set 2" [1] for flows which lead to the initiation of Call Bearer Control signalling.</p> <p><b>Processing upon receipt:</b> When the originating side of a CSM receives the information flow ordering a release it requests the BIWF to release the bearer connection with Information Flow 1. Transaction ID 1000 is selected for this purpose.</p>	
<b>1</b>	<b>MOD.req &amp; SUB.req</b>	<b>CSM to BIWF</b>
	<p><u>Address Information</u></p>	<p><u>Control information</u> Transaction ID = 1000 Context ID = c1 Termination ID = bearer1 Cause Information = Cause Reset = yes / no CutThrough = Send / Receive / Inactive <u>In the MOD.req only:</u> Signal = BNC Release</p>
	<p><b>Initiation of information flow:</b> Receipt of Information Flow 0.</p> <p><b>Processing upon receipt:</b> When the BIWF receives Information Flow 1, it breaks the connection path and acknowledges the request to release the termination with Information Flow 3. Because there was a request to release the BNC, and if the BIWF originated the bearer connection, it initiates the release of the bearer connection with Information Flow 2. The resources associated with the termination (e.g. BNC-ID) are not deleted until the Flow 4 is received. If the CSF orders reset, the BIWF shall clear all resources associated with the BNC. The BIWF shall not reuse the BNC for any other calls.</p>	
<b>2</b>	<b>Bearer-Release.Reg</b>	<b>CSM to CSM</b>
	<p><u>Address Information</u></p>	<p><u>Control information</u> BCS-ID = "15" Cause Information = "normal"</p>

**Initiation of information flow:** Receipt of Information Flow 1.

**Processing upon receipt:** The incoming bearer connection is released and Information Flow 3 is returned to BIWF to indicate successful release of the connection.

---

<b>3</b>	<b>MOD.resp &amp; SUB.req</b>	<b>BIWF to CSM</b>			
	<table border="0" style="width: 100%;"> <tr> <td style="width: 33%;"><u>Address Information</u></td> <td style="width: 33%;"><u>Control information</u> Transaction ID = 1000 Context = cl</td> <td style="width: 33%;"><u>Bearer information</u></td> </tr> </table>	<u>Address Information</u>	<u>Control information</u> Transaction ID = 1000 Context = cl	<u>Bearer information</u>	
<u>Address Information</u>	<u>Control information</u> Transaction ID = 1000 Context = cl	<u>Bearer information</u>			

**Initiation of information flow:** Receipt of Information Flow 1.

**Processing upon receipt:** The CIC and all other resources in CSM are released.

---

<b>4</b>	<b>Bearer-Release-Resp</b>	<b>BIWF-x to BIWF</b>			
	<table border="0" style="width: 100%;"> <tr> <td style="width: 33%;"><u>Address Information</u></td> <td style="width: 33%;"><u>Control information</u> BCS-id=15</td> <td style="width: 33%;"><u>Bearer information</u></td> </tr> </table>	<u>Address Information</u>	<u>Control information</u> BCS-id=15	<u>Bearer information</u>	
<u>Address Information</u>	<u>Control information</u> BCS-id=15	<u>Bearer information</u>			

**Initiation of information flow:** The receipt of Information Flow 3.

**Processing upon receipt:** When the BIWF receives the bearer-release-req, the BIWF will free resources associated with the bearer associated with termination ID "bearer1".

## 8.10 General Procedures

### 8.10.1 BIWF Service Changes

#### 8.10.1.1 BIWF Registration

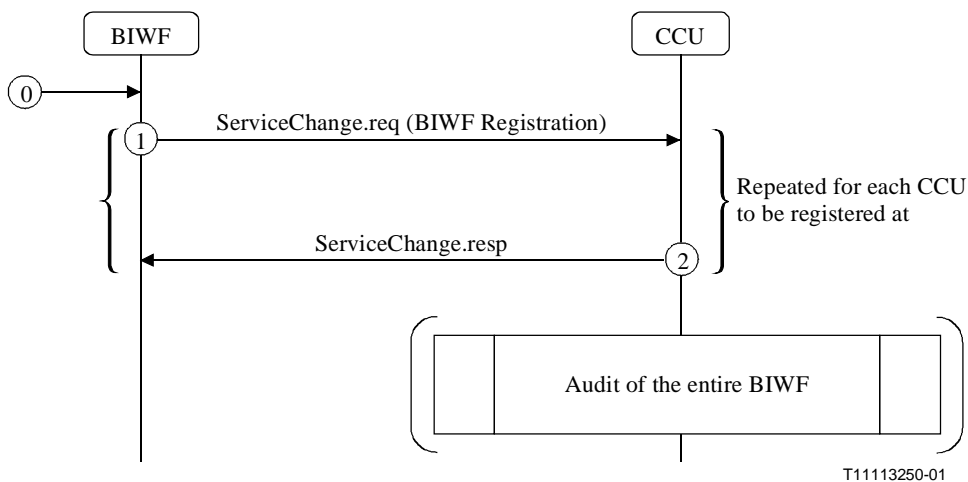

**Figure 28 – BIWF Registration**

The following numbered items describe the numbered flows shown above.

---

<b>0</b>	<b>Operator Stimulus</b>	<b>Operator to BIWF</b>			
	<table border="0" style="width: 100%;"> <tr> <td style="width: 33%;"><u>Address Information</u> (CCU Control Address(es)) (New B-IWF Control Address(es))</td> <td style="width: 33%;"><u>Control information</u></td> <td style="width: 33%;"><u>Bearer information</u></td> </tr> </table>	<u>Address Information</u> (CCU Control Address(es)) (New B-IWF Control Address(es))	<u>Control information</u>	<u>Bearer information</u>	
<u>Address Information</u> (CCU Control Address(es)) (New B-IWF Control Address(es))	<u>Control information</u>	<u>Bearer information</u>			

**Initiation of information flow:** The BIWF operator has initialized the B-IWF, supplied Control Address(es) for new User/Master CCU(s) to be registered at and/or optionally new BIWF Control Address(es) to be used by these CCU(s) for the further BIWF communication.

**Processing upon receipt:** When the BIWF receives this stimulus, it stores any given CCU Control Address(es) and sends a ServiceChange.req Flow 1 with Root as Termination ID and ALL as Context ID to each of these User/Master CCU(s) indicating Restart as Method and Cold/Warm Boot as Reason. The current time in the BIWF when sending the flow is also included as well as the Protocol Version supported by the BIWF. Optionally, a new BIWF Control Address, to be used by the CCU for the further communication with the BIWF, are also included. Also optionally, Non Standard Data associated with the BIWF is also included. The BIWF selects e.g. the Transaction ID of 2000 to be used.

---

<b>1</b>	<b>ServiceChange.req (BIWF Registration)</b>	<b>BIWF to CCU</b>						
	<table border="0" style="width: 100%;"> <tr> <td style="width: 33%;"><u><b>Address Information</b></u> New BIWF Control Address</td> <td style="width: 33%;"><u><b>Control information</b></u> Transaction ID = 2000 Context ID = ALL Termination ID = Root Service Change Reason =     Cold Boot / Warm Boot Service Change Method = Restart Time Stamp = BIWF Time at sending Service Change Version =     Protocol Version</td> <td style="width: 33%;"><u><b>Bearer information</b></u></td> </tr> <tr> <td></td> <td style="text-align: center;">(Non Standard Data = Code)</td> <td></td> </tr> </table>	<u><b>Address Information</b></u> New BIWF Control Address	<u><b>Control information</b></u> Transaction ID = 2000 Context ID = ALL Termination ID = Root Service Change Reason = Cold Boot / Warm Boot Service Change Method = Restart Time Stamp = BIWF Time at sending Service Change Version = Protocol Version	<u><b>Bearer information</b></u>		(Non Standard Data = Code)		
<u><b>Address Information</b></u> New BIWF Control Address	<u><b>Control information</b></u> Transaction ID = 2000 Context ID = ALL Termination ID = Root Service Change Reason = Cold Boot / Warm Boot Service Change Method = Restart Time Stamp = BIWF Time at sending Service Change Version = Protocol Version	<u><b>Bearer information</b></u>						
	(Non Standard Data = Code)							

**Initiation of information flow:** Information Flow 0.

**Processing upon receipt:** When the CCU receives the ServiceChange.req, it records the current CCU time and stores this together with the received Time Stamp from the BIWF. If Non Standard Data is received, this is also stored and any provisioned default data for this type of BIWF is retrieved and stored for this BIWF. If a New BIWF Control Address is received, this is replacing the stored one after the subsequent response and is used for later communication with the BIWF. A ServiceChange.resp Information Flow 2 is then returned with either the own CCU Control Address or a New Own CCU Control Address to be used by the BIWF for the further communication with the CCU, if previously supplied by the CCU operator. If the Service Change Reason is Cold boot the CCU clear all remaining calls in accordance with the release procedure in the call protocol. If a Protocol Version was received, the same or a lower Protocol Version is returned dependent on whether the CCU supports the received Protocol Version or only a lower Protocol Version. Optionally, the CCU may then initiate an "Audit of the BIWF" as shown in 8.10.4.1 below.

The CCU can then regard the BIWF as Registered and the Service State of the BIWF as In Service.

---

<b>2</b>	<b>ServiceChange.resp</b>	<b>CCU to BIWF</b>			
	<table border="0" style="width: 100%;"> <tr> <td style="width: 33%;"><u><b>Address Information</b></u> Use current CCU Control Address:      CCU Control Address  Use New CCU Control Address:      New CCU Control Address</td> <td style="width: 33%;"><u><b>Control information</b></u> (Service Change Version = (Lower)     Protocol Version)</td> <td style="width: 33%;"><u><b>Bearer information</b></u></td> </tr> </table>	<u><b>Address Information</b></u> Use current CCU Control Address:  CCU Control Address  Use New CCU Control Address:  New CCU Control Address	<u><b>Control information</b></u> (Service Change Version = (Lower) Protocol Version)	<u><b>Bearer information</b></u>	
<u><b>Address Information</b></u> Use current CCU Control Address:  CCU Control Address  Use New CCU Control Address:  New CCU Control Address	<u><b>Control information</b></u> (Service Change Version = (Lower) Protocol Version)	<u><b>Bearer information</b></u>			

**Initiation of information flow:** Information Flow 1.



**Processing upon receipt:** When the BIWF receives the ServiceChange.resp, it stores the New CCU Control Address to be used by the BIWF for the further communication with the CCU, if received. The Protocol Version to use are also stored, if received. The BIWF can then regard the CCU as Registered and the Service State of the BIWF as In Service.

### 8.10.1.2 BIWF Re-Registration

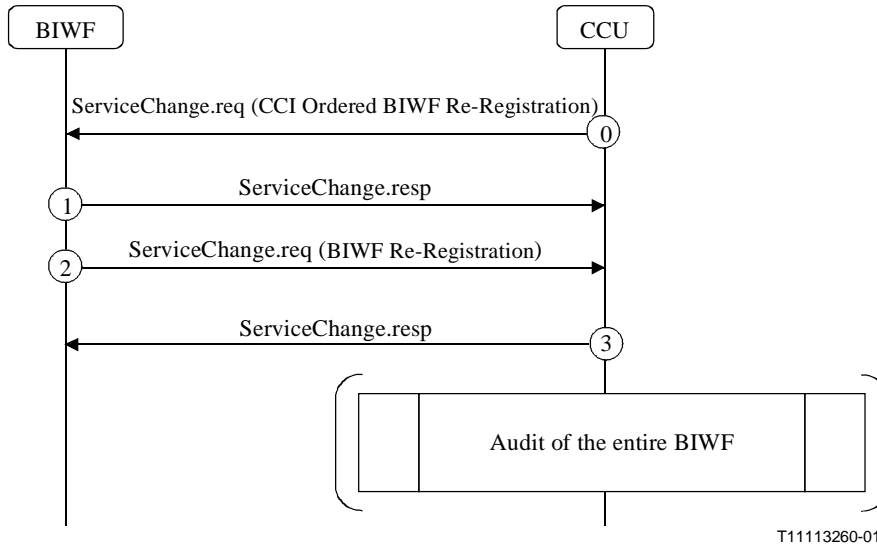

**Figure 29 – BIWF Re-Registration**

The following numbered items describe the numbered flows shown above.

<b>0</b>	<b>Service Change.req (CCU Ordered BIWF Re-Registration)</b>	<b>CCU to BIWF</b>
	<u>Address Information</u> See 8.10.2.1	<u>Control information</u> See 8.10.2.1
		<u>Bearer information</u>

**Initiation of information flow:** See 8.10.2.1

**Processing upon receipt:** When the BIWF receives this stimulus, it stores any given CCU Control Address(es) and sends a ServiceChange.req Flow 2 with Root as Termination ID and ALL as Context ID to each of these User/Master CCU(s) indicating Handoff as Method and MGC Directed Change as Reason. The current time in the BIWF when sending the flow is also included as well as the Protocol Version supported by the BIWF. Optionally, a new BIWF Control Address, to be used by the CCU for the further communication with the BIWF, is also included. Also optionally, Non Standard Data associated with the BIWF is also included. The BIWF selects e.g. the Transaction ID of 2000 to be used.

<b>1</b>	<b>ServiceChange.resp</b>	<b>CCU to BIWF</b>
	<u>Address Information</u> See 8.10.2.1	<u>Control information</u> See 8.10.2.1
		<u>Bearer information</u>

**Initiation of information flow:** Information Flow 0.

**Processing upon receipt:** See 8.10.2.1

**Address Information**

Own or New BIWF Control Address

**Control information**

Transaction ID = 2000  
 Context ID = ALL  
 Termination ID = Root  
 Service Change Reason =  
   MGC Directed Change  
 Service Change Method = Handoff  
 Time Stamp = BIWF Time at sending  
 Service Change Version =  
   Protocol Version  
 (Non Standard Data = Code)

**Bearer information**

**Initiation of information flow:** Information Flow 0.

**Processing upon receipt:** When the CCU receives the ServiceChange.req, it records the current CCU time and stores this together with the received Time Stamp from the BIWF. If Non Standard Data is received, this is also stored and any provisioned default data for this type of BIWF is retrieved and stored for this BIWF. If a New BIWF Control Address is received, this is replacing the stored one after the subsequent response and is used for later communication with the BIWF. A ServiceChange.resp Information Flow 3 is then returned with either the own CCU Control Address or a New Own CCU Control Address to be used by the BIWF for the further communication with the CCU, if previously supplied by the CCU operator. If a Protocol Version was received, the same or a lower Protocol Version is returned dependent on whether the CCU supports the received Protocol Version or only a lower Protocol Version. Optionally, the CCU may then initiate an "Audit of the entire BIWF" as shown in 8.10.4.1 below.

The CCU can then regard the BIWF as Registered and the Service State of the BIWF as In Service.

**Address Information**Use current CCU Control Address:

CCU Control Address

Use New CCU Control Address:

New CCU Control Address

**Control information**

Transaction ID = 2000-11-14  
 Context ID = ALL  
 Termination ID = Root  
 Service Change Version = (Lower)  
 Protocol Version

**Bearer information**

**Initiation of information flow:** Information Flow 1.

**Processing upon receipt:** When the BIWF receives the ServiceChange.resp, it stores the New CCU Control Address to be used by the BIWF for the further communication with the CCU, if received. The Protocol Version to use are also stored, if received. The BIWF can then regard the CCU as Registered and the Service State of the BIWF as In Service.

### 8.10.1.3 BIWF Lost Communication

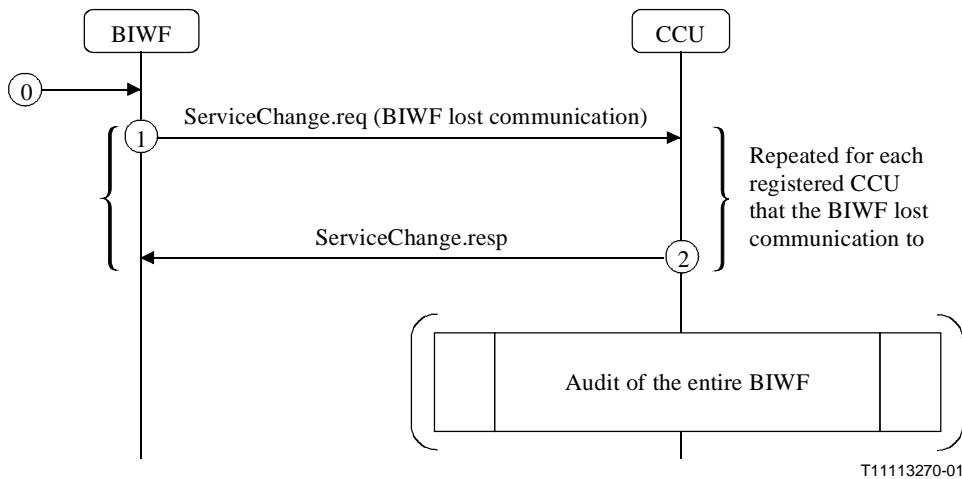

**Figure 30 – BIWF Lost Communication**

The following numbered items describe the numbered flows shown above.

---

**0**      **BIWF Internal Stimulus**      **BIWF to Itself**

Address Information

Control information

Bearer information

**Initiation of information flow:** The BIWF has lost but subsequently restored the communication with the registered User CCU(s) but there is a risk that this has caused a possible information mismatch between the BIWF and the CCU(s).

**Processing upon receipt:** When the BIWF has experienced a communication error that possibly has caused an information mismatch between the BIWF and the registered User CCU(s), it sends a ServiceChange.req Flow 1 to each of the registered CCU(s) when the event has ceased. The ServiceChange.req is sent with Root as Termination ID and ALL as Context ID indicating Service Restored as Reason. Optionally, the current time in the BIWF when sending the flow is also included. The BIWF selects e.g. the Transaction ID of 2000 to be used.

---

**1**      **ServiceChange.req (BIWF Lost Communication)**      **BIWF to CCU**

Address Information

Control information

Bearer information

Transaction ID = 2000  
 Context ID = ALL  
 Termination ID = Root  
 Service Change Reason = Service Restored  
 Service Change Method = Disconnected  
 (Time Stamp = BIWF Time at sending)

**Initiation of information flow:** Information Flow 0.

**Processing upon receipt:** When the CCU receives the ServiceChange.req with a Time Stamp, it records the current CCU time and stores this together with the Time Stamp from the BIWF. A ServiceChange.resp Information Flow 2 is then returned using the stored BIWF Control Address. Optionally, the CCU may then initiate an "Audit of the entire BIWF" as shown in 8.10.4.1 below.

Address InformationControl informationBearer information

**Initiation of information flow:** Information Flow 1.

**Processing upon receipt:** –

#### 8.10.1.4 BIWF Service Restoration

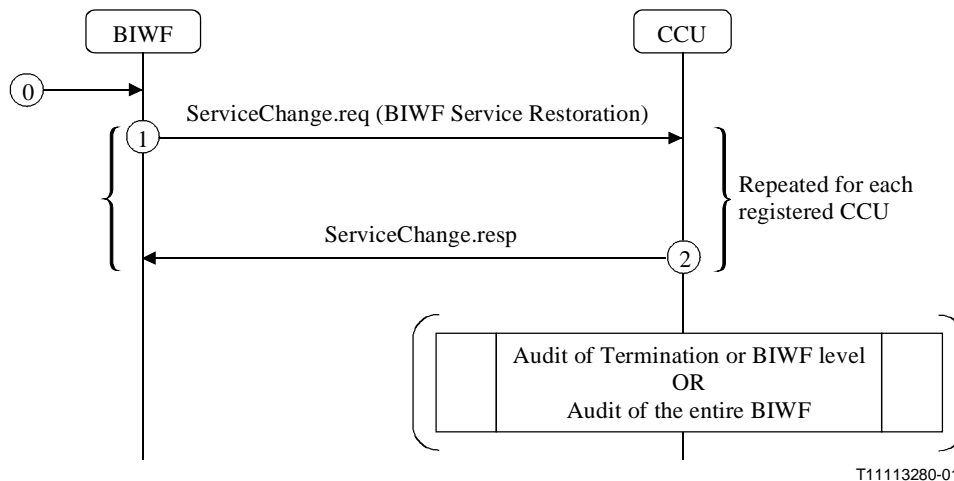

**Figure 31 – BIWF Service Restoration**

The following numbered items describe the numbered flows shown above.

**0 BIWF Internal Stimulus**

**BIWF to Itself**

Address InformationControl informationBearer information

Termination ID =  
Termination(s) / Root / ALL  
(Service Change Delay = Delay)

**Initiation of information flow:** The BIWF has detected an event, e.g. ceasing of HW malfunction, removal of severe stream disturbances, BIWF restart, or a BIWF operator or a CCU initiated one, that enables Termination(s) or the whole BIWF to be taken into service. Dependent on the type of Termination or BIWF and type of event, the Termination(s) or the BIWF are to be taken into service with or without a Delay.

**Processing upon receipt:** When the BIWF receives this stimulus and Ephemeral Termination(s) not in use or the BIWF are concerned, it sends ServiceChange.req Flow(s) 1 with ALL or the Root as Termination ID to all registered User CCU(s). When Ephemeral Termination(s) in use or Physical Terminations are concerned, it sends the ServiceChange.req flow(s) (1) with the Termination(s) as Termination ID to the User CCU only. All cases indicate Restart as Method, Service Restored as Reason and a Delay as an option. A specific or null Context ID is indicated dependent on whether the Termination(s) are within a Context or not. ALL as Context ID is indicated for Ephemeral Termination(s) not in use or if the whole BIWF is to be taken into service. Several Information Flows 1 might be required for all this. The BIWF selects e.g. the Transaction ID of 2000 to be used. After the Delay, the BIWF sets the Service State of the Termination(s) or the BIWF to In Service.

**Address Information**

**Control information**

**Bearer information**

Transaction ID = 2000  
 Context ID = Null / Context ID / ALL  
 Termination ID =  
     Termination(s) / Root / ALL  
 Service Change Reason =  
     Service Restored  
 Service Change Method = Restart  
 (Service Change Delay = Delay)

**Initiation of information flow:** Information Flow 0.

**Processing upon receipt:** When the CCU receives the ServiceChange.req, it returns ServiceChange.resp Information Flow 2. The CCU may then optionally perform an "Audit of Termination or BIWF level" as shown in 8.10.4.2 or an "Audit of the entire BIWF" as shown in 8.10.4.1 below. After the Delay, the CCU can regard the Service State of the Termination(s) or the BIWF as In Service.

**Address Information**

**Control information**

**Bearer information**

**Initiation of information flow:** Information Flow 1.

**Processing upon receipt:** –

**8.10.1.5 BIWF Service Cancellation**

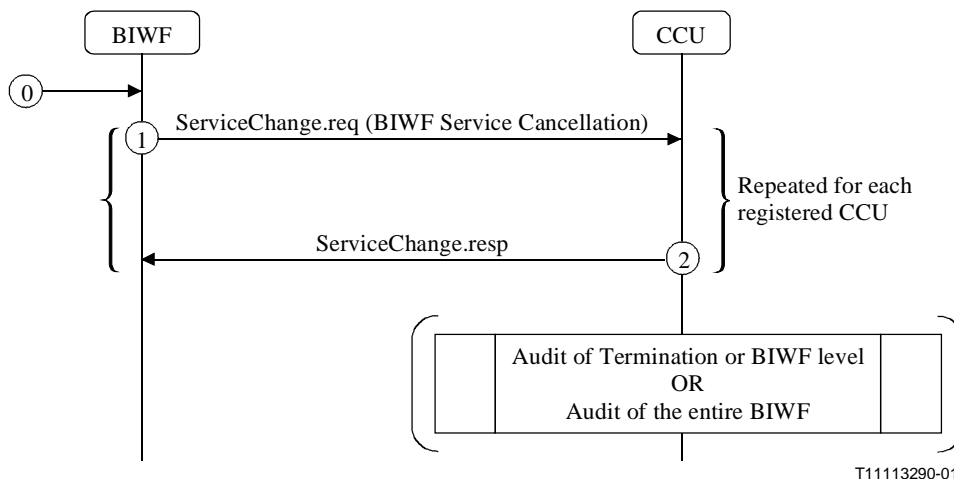

**Figure 32 – BIWF Service Cancellation**

The following numbered items describe the numbered flows shown above.

**Address Information**

**Control information**

**Bearer information**

Termination ID =  
     Termination(s) / Root / ALL  
 Service Change Method =  
     Graceful / Force  
 (Service Change Delay = Delay)

**Initiation of information flow:** The BIWF has detected an event, e.g. HW malfunction, severe stream disturbances, MG failure, or a BIWF operator or a CCU initiated one, which forces Termination(s) or the whole BIWF to be taken out of service. Dependent on the type of Termination or BIWF and type of event, the Termination(s) or the BIWF is either to be taken out of service gracefully or by force, with or without a Delay.

**Processing upon receipt:** When the BIWF receives this stimulus and Ephemeral Termination(s) not in use or the BIWF are concerned, it sends ServiceChange.req Flow(s) 1 with ALL or the Root as Termination ID to all registered User CCU(s). When Ephemeral Termination(s) in use or Physical Terminations are concerned, it sends the ServiceChange.req Flow(s) 1 with the Termination(s) as Termination ID to the User CCU only. All cases indicate Graceful or Forced as Method, Termination Taken Out Of Service / Termination Failure / Termination Malfunction / Loss of Lower Layer Connectivity as a Reason and a Delay as an option. In the case of an entire BIWF, MG Impending Failure is the reason. A specific or null Context ID is indicated dependent on whether the Termination(s) are within a Context or not. ALL as Context ID is indicated for Ephemeral Termination(s) not in use or if the whole BIWF is to be taken out of service. Several Information Flows 1 might be required for this. The BIWF selects e.g. the Transaction ID of 2000 to be used.

---

<b>1</b>	<b>ServiceChange.req (BIWF Service Cancellation)</b>	<b>BIWF to CCU</b>	
	<p><b><u>Address Information</u></b></p>	<p><b><u>Control information</u></b>            Transaction ID = 2000            Context ID = Null / Context ID / ALL            Termination ID =                Termination(s) / Root / ALL            Service Change Reason =  <u>For Terminations:</u>                Termination Taken Out Of Service /                Termination Failure /                Termination Malfunction /                Loss of Lower Layer Connectivity            For BIWF:                MG Impending Failure            Service Change Method =                Graceful / Forced            (Service Change Delay = Delay)</p>	<p><b><u>Bearer information</u></b></p>

**Initiation of information flow:** Information Flow 0.

**Processing upon receipt:** When the CCU receives the ServiceChange.req, it refrains from establishing new connections to the Termination(s) or the BIWF and starts to tear down existing connections from the Termination(s) or the BIWF gracefully or by force, with or without a Delay, as requested. When no Delay is indicated for a graceful tear down, the BIWF is to wait for the natural removal of the existing connections. A ServiceChange.resp Information Flow 2 is then returned to the BIWF. The CCU may then optionally perform an "Audit of Termination or BIWF level" as shown in 8.10.4.1 or an "Audit of the entire BIWF" as shown in 8.10.4.2 below. After the Delay, the CCU can regard the Service State of the Termination(s) or the whole BIWF as Out Of Service.

---

<b>2</b>	<b>ServiceChange.resp</b>	<b>CCU to BIWF</b>
	<b><u>Address Information</u></b>	<b><u>Control information</u></b>
		<b><u>Bearer information</u></b>

**Initiation of information flow:** Information Flow 1.

**Processing upon receipt:** When the BIWF has received the last ServiceChange.resp and after the Delay, it sets the Service State of the Termination(s) or the whole BIWF to Out Of Service.

### 8.10.1.6 BIWF Capability Change

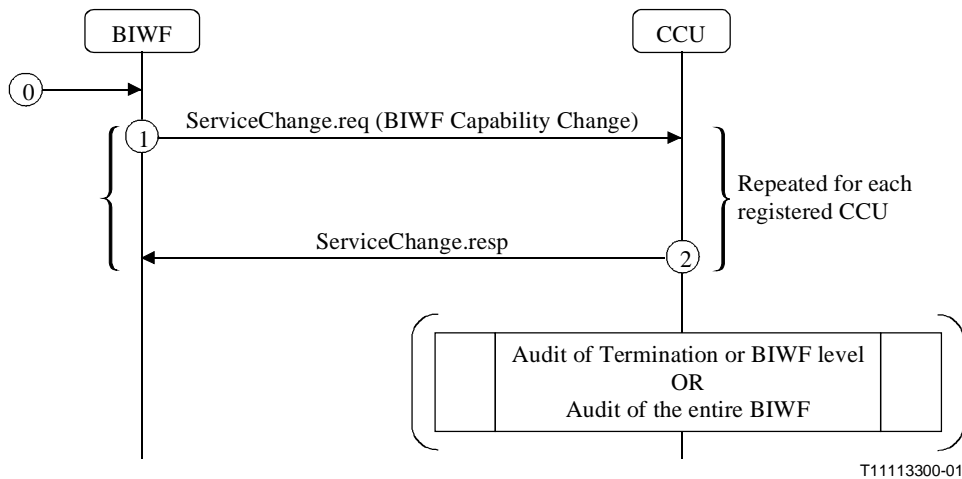

**Figure 33 – BIWF Capability Change**

The following numbered items describe the numbered flows shown above.

---

**0 Internal Stimulus BIWF to Itself**

**Address Information**

**Control information**

**Bearer information**

Termination ID =  
Termination(s) / Root / ALL

**Initiation of information flow:** The capabilities of Termination(s) or the whole BIWF is changed either by the operator or due to a BIWF internal event. Dependent on the type of Termination or BIWF and type of capability change, the change may affect the state of the Termination(s) or BIWF.

**Processing upon receipt:** When the BIWF receives this stimulus and Ephemeral Termination(s) not in use or returned to use or the BIWF are concerned, it sends ServiceChange.req Flow(s) 1 with ALL or the Root as Termination ID to all registered User CCU(s). When Ephemeral Termination(s) in use or Physical Terminations are concerned, it sends the ServiceChange.req Flow(s) 1 with the Termination(s) as Termination ID to the User CCU only If Service Change Method Disconnected is sent it indicates that resources are going out of service as a result of a capability change. If Restart is indicated, resources associated with the capability change are coming back into service. The BIWF can indicate Capability Failure for Mux, Modem, Events, Signals or Media as Reason.

A specific or null Context ID is indicated dependent on whether the Termination(s) are within a Context or not. ALL as Context ID is indicated for Ephemeral Termination(s) not in use or if the capabilities of the whole BIWF is changed. Several Information Flows 1 might be required for this. The BIWF selects e.g. the Transaction ID of 2000 to be used.

---

**1 ServiceChange.req (BIWF Capability Change) BIWF to CCU**

**Address Information**

**Control information**

**Bearer information**

Transaction ID = 2000  
Context ID = Null / Context ID / ALL  
Termination ID =  
Termination(s) / Root / ALL  
Service Change Method = Disconnected / Restart  
Service Change Reason =  
Modem / Mux / Media /  
Event / Signal Capability Failure

**Initiation of information flow:** Information Flow 0.

**Processing upon receipt:** When the CCU receives the ServiceChange.req, it returns a ServiceChange.resp Information Flow 2 to the BIWF.

The CCU should initiate an "Audit of Termination or BIWF level" as shown in 8.10.4.2 or an "Audit of the entire BIWF" as shown in 8.10.4.1 below.

When the ServiceChange.req indicated Capability Failure as Reason for Packages or a Descriptor that may include Packages (Modem / Events / Signals / Mux / Media / TerminationState / LocalControl / Local / Remote), an audit with respect to the current Packages need to be performed.

When the ServiceChange.req indicated Capability Failure as Reason for a Descriptor that may include Properties (Modem/Mux/Media/TerminationState/LocalControl/Local/Remote), an audit with respect to the current Packages and Properties (with Values) need to be performed.

When the ServiceChange.req indicated Event Capability Failure as Reason, the Event Descriptor need to be audited with respect to the current Events.

When the ServiceChange.req indicated Signal Capability Failure as Reason, the Signal Descriptor need to be audited with respect to the current Signals.

In all cases, the Digit Map Descriptor needs to be audited with respect to the current Digit Map (Values).

---

2	ServiceChange.resp	CCU to BIWF
	<p><u>Address Information</u></p> <p><u>Control information</u></p> <p><u>Bearer information</u></p>	

**Initiation of information flow:** Information Flow 1.

**Processing upon receipt:** –

## 8.10.2 CCU Service Change

### 8.10.2.1 CCU Ordered BIWF Re-Registration

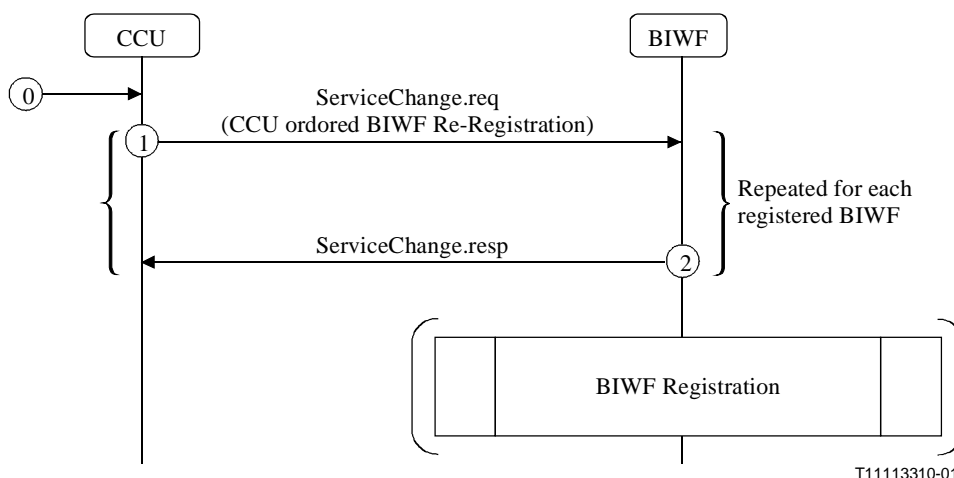

T11113310-01

**Figure 34 – CCU ordered BIWF Re-Registration**



The following numbered items describe the numbered flows shown above.

---

<b>0</b>	<b>Operator Stimulus</b>	<b>CCU to Itself</b>
	<b><u>Address Information</u></b> (CCU Control Address(es)) (New B-IWF Control Address(es))	<b><u>Control information</u></b>
		<b><u>Bearer information</u></b>

**Initiation of information flow:** The CCU has experienced a major disruption, such as rollback of data, where it no longer is certain that the CCU has an accurate picture on which BIWFs it uses, what protocol versions these use etc.

**Processing upon receipt:** When the CCU receives this stimulus, it sends a ServiceChange.req Flow 1 with Root as Termination ID and ALL as Context ID to each BIWF it has registered indicating Restart as Method and MGC Directed Change as Reason.

The CCU selects e.g. the Transaction ID of 2000 to be used.

---

<b>1</b>	<b>ServiceChange.req (CCU Ordered BIWF Re-registration)</b>	<b>CCU to BIWF</b>
	<b><u>Address Information</u></b> (Service Change MGC ID = CCU Control Address)	<b><u>Control information</u></b> Transaction ID = 2000 Context ID = ALL Termination ID = Root Service Change Reason = MGC Directed Change Service Change Method = Handoff
		<b><u>Bearer information</u></b>

**Initiation of information flow:** Information Flow 0.

**Processing upon receipt:** When the BIWF receives the ServiceChange.req, it returns a ServiceChange.resp Information Flow 2.

The BIWF will then re-register itself as shown in 8.10.2.1 "BIWF Re-Registration".

---

<b>2</b>	<b>ServiceChange.resp</b>	<b>BIWF to CCU</b>
	<b><u>Address Information</u></b>	<b><u>Control information</u></b>
		<b><u>Bearer information</u></b>

**Initiation of information flow:** Information Flow 1.

**Processing upon receipt:** When the CCU receives the ServiceChange.resp, it waits for the BIWF Registration procedure to be initiated, as shown in 8.10.1.1 "BIWF Registration".

### 8.10.2.2 CCU Initiated Service Restoration

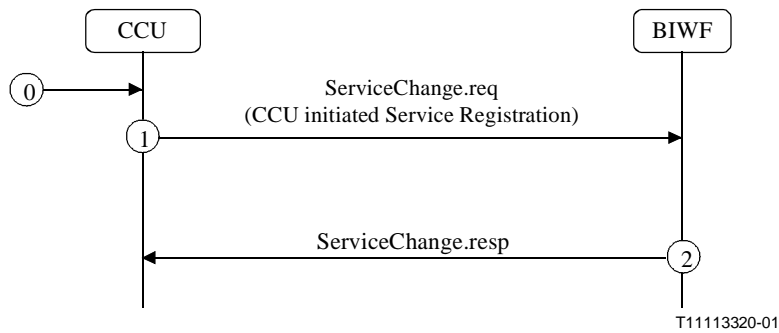

**Figure 35 – CCU Initiated Service Restoration**

The following numbered items describe the numbered flows shown above.

<b>0</b>	<b>Operator Stimulus</b>	<b>CCU to Itself</b>
	<p><b><u>Address Information</u></b> (CCU Control Address(es)) (New B-IWF Control Address(es))</p>	<p><b><u>Control information</u></b></p> <p><b><u>Bearer information</u></b></p>
<b>1</b>	<b>ServiceChange.req (CCU Initiated Service Restoration)</b>	<b>CCU to BIWF</b>
	<p><b><u>Address Information</u></b></p>	<p><b><u>Control information</u></b> Transaction ID = 2000 Context ID = Null / Context ID / ALL Termination ID = Termination(s) / Root / ALL Service Change Reason = Cold Boot / Warm Boot Service Change Method = Restart</p> <p><b><u>Delay:</u></b> Service Change Delay = Delay</p>

**Initiation of information flow:** Information Flow 0.

**Processing upon receipt:** Upon reception of the command in the BIWF:

- If the Service Change Reason is Cold boot the BIWF moves all physical terminations to null context and remove all ephemeral terminations. NotifyRequest(s) are stopped and physical terminations withdrawn from traffic are reported in ServiceChange request(s).
- A command response (2) is sent.

After the Delay, the BWIF can regard the Service State of the Termination(s) or the CCU as In Service.

---

<b>2</b>	<b>ServiceChange.resp</b>	<b>BWIF to CCU</b>	
	<p><u>Address Information</u></p>	<p><u>Control information</u>            Transaction ID = 2000            Context ID = Null / Context ID / ALL            Termination ID =            Termination(s) / Root / ALL</p>	<p><u>Bearer information</u></p>

**Initiation of information flow:** Information Flow 1.

**Processing upon receipt:** –

### 8.10.2.3 CCU Initiated Service Cancellation

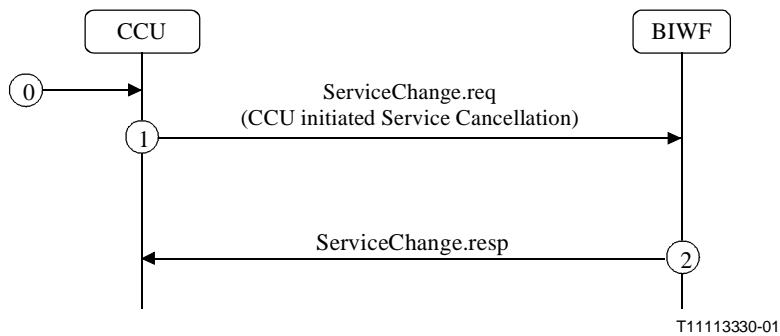

**Figure 36 – CCU Initiated Service Cancellation**

The following numbered items describe the numbered flows shown above.

---

<b>0</b>	<b>CCU Internal Stimulus</b>	<b>CCU to Itself</b>	
	<p><u>Address Information</u></p>	<p><u>Control information</u>            Termination ID =            Termination(s) / Root / ALL            Service Change Method =            Graceful / Force            (Service Change Delay = Delay)</p>	<p><u>Bearer information</u></p>

**Initiation of information flow:** The CCU has detected an event which forces Termination(s) or the whole CCU to be taken out of service. Dependent on the type of Termination or BIWF and type of event, the Termination(s) or the CCU is either to be taken out of service gracefully or by force, with or without a Delay.

**Processing upon receipt:** When the CCU receives this stimulus and Ephemeral Termination(s) not in use or the BIWF are concerned, it sends ServiceChange.req Flow(s) 1 with ALL or the Root as Termination ID to the appropriate BIWF(s). When Ephemeral Termination(s) in use or Physical Terminations are concerned, it sends the ServiceChange.req Flow(s) 1 with the Termination(s) as

Termination ID to the User BIWF only. All cases indicate Graceful or Forced as Method, Termination Taken Out Of Service (if terminations are involved) or MGC Impending Failure (if the CCU as a whole is concerned) as Reason and a Delay as an option. A specific or null Context ID is indicated dependent on whether the Termination(s) are within a Context or not. ALL as Context ID is indicated for Ephemeral Termination(s) not in use or if the whole CCU is to be taken out of service. Several Information Flows 1 might be required for this. The BIWF selects e.g. the Transaction ID of 2000 to be used. A ServiceChange.req command is sent to all registered BIWFs with the following information.

1	<b>ServiceChange.req (CCU Initiated Service Cancellation)</b>	<b>CCU to BIWF</b>
	<u>Address Information</u>	<u>Bearer information</u>
	<u>Control information</u>	
	Transaction ID = z	
	Context ID = Null / Context ID / ALL	
	Termination ID =	
	Termination(s) / Root / ALL	
	Service Change Reason =	
	<u>For Terminations:</u>	
	Termination Taken Out Of Service	
	For a CCU:	
	MGC Impending Failure	
	Service Change Method =	
	Graceful / Forced	
	<u>Delay:</u>	
	Service Change Delay = Delay	

**Initiation of information flow:** Information Flow 0.

**Processing upon receipt:** When the BIWF receives the ServiceChange.req, it starts to tear down existing connections from the Termination(s) or the BIWF gracefully or by force, with or without a Delay, as requested. When no Delay is indicated for a graceful tear down, the BIWF is to wait for the natural removal of the existing connections. A ServiceChange.resp Information Flow 2 is then returned to the CCU. After the Delay, the CCU can regard the Service State of the Termination(s) or the whole BIWF as Out Of Service.

2	<b>ServiceChange.resp</b>	<b>BIWF to CCU</b>
	<u>Address Information</u>	<u>Bearer information</u>
	<u>Control information</u>	
	Transaction ID = z	
	Context ID = Null / Context ID / ALL	
	Termination ID =	
	Termination(s) / Root / ALL	

**Initiation of information flow:** Information Flow 1.

**Processing upon receipt:** –

### 8.10.3 BIWF/Termination Unavailable

The CCU should set a BIWF/Termination in Service State 'Unavailable' when the CCU discovers that the BIWF/Termination is unavailable, e.g. due to:

- Signalling transport restrictions
- After this, the CCU should refrain from establishing any new connections to the BIWF/Termination until the CCU discovers that the BIWF/Termination is available again, e.g. due to the fact that:
- 1) The signalling transport restrictions are removed (MGW communication lost is received);
  - 2) The BIWF/Termination reports a **ServiceChange** for the BIWF/Termination indicating that service has been restored;

3) An audit of the BIWF/Termination results in a response

The CCU should then set the BIWF/Termination in Service State 'Available' and send unblocking indications (with the appropriate protocol) for the terminations. The CCU may then optionally perform an "Audit of Termination or BIWF level" as shown in 8.10.4.2 or an "Audit of the entire BIWF" as shown in 8.10.4.1 below.

## 8.10.4 Audit of BIWF Service Capabilities

### 8.10.4.1 Audit of BIWF

When auditing an entire BIWF it should be noted that four (4) types of audits are required:

- 1) Audit of BIWF level;
- 2) Audit of default characteristics of Terminations;
- 3) Audit of all Physical Termination(s) in Null Context;
- 4) Audit of all Ephemeral/Physical Termination(s) in Context.

An audit of the BIWF level 1) is performed by indication ALL as Context ID and Root as Termination ID. Such an audit will return Packages and Properties realized on BIWF level as well as a list of all Context IDs.

If the requesting audit command **AuditValue/AuditCapabilities** includes an Empty AuditDescriptor when Terminations are audited [2)-4)], a list of Terminations is returned. This may be useful when using wildcards (ALL) for Terminations.

Terminations not in use 2) are audited by means of indication ALL as Context ID and ALL as Termination ID.

Physical Terminations in Null Context 3) is performed by indicating Null as Context ID and the Termination or a wildcard (ALL) as Termination ID.

Physical/Ephemeral Terminations in Context are audited by indicating the Context as Context ID and the Termination or a wildcard (ALL) as Termination ID.

For details regarding these audits [1)-4)], please refer to "Audit of Termination or BIWF level" as shown in 8.10.4.2 below.

### 8.10.4.2 Audit of Termination or BIWF level

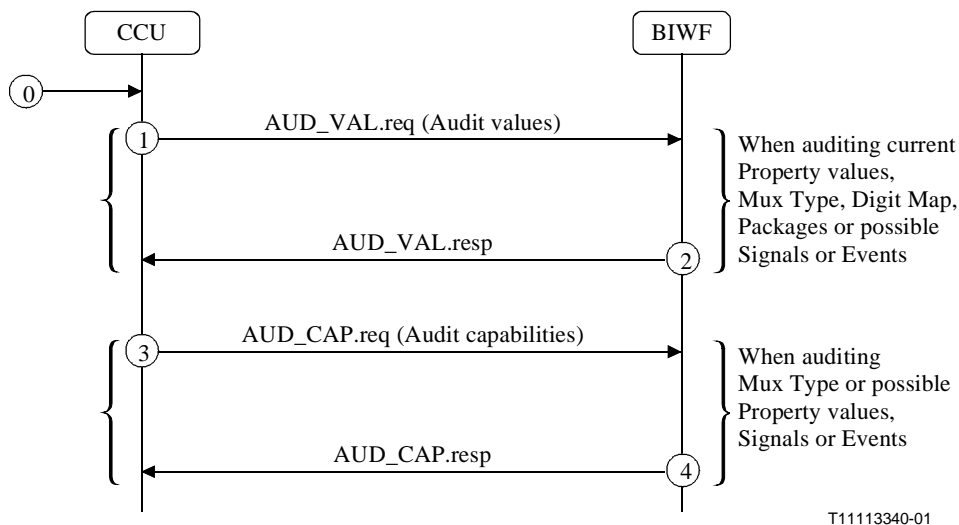

**Figure 37 – Audit of Termination or BIWF level**

The following numbered items describe the numbered flows shown above.

---

<b>0</b>	<b>CCU Internal Stimulus</b>	<b>CCU to Itself</b>
	<u><b>Address Information</b></u> BIWF Control Address	<u><b>Control information</b></u> Termination ID = Termination(s) / Root / ALL
		<u><b>Bearer information</b></u>

**Initiation of information flow:** The User CCU has detected an event, e.g. a BIWF initiated BIWF capability change, which requires an audit of Termination(s) or the BIWF level in a registered BIWF.

**Processing upon receipt:** When the CCU receives this stimulus, and auditing of current property values, Mux Types, Packages, Digit maps or possible Signals or Events is required, it sends AUD\_VAL.req Flow(s) 1 to the registered BIWF. The CCU then includes the Termination(s) or the Root as Termination ID. ALL as Termination ID is indicated for Ephemeral Termination(s) not in use. The CCU may indicate auditing of Digit Map and/or all Packages. Instead of Packages, the Descriptors for Mux and/or Modem and/or Events and/or Signals and/or Media can be indicated.

A specific or null Context ID is indicated dependent on whether the Termination(s) are within a Context or not. ALL as Context ID is indicated for Ephemeral Termination(s) not in use or if the BIWF level is to be audited. Several Information Flows 1 might be required for all this. The CCU selects e.g. the Transaction ID of 2001 to be used.

---

<b>1</b>	<b>AUD_VAL.req (Audit Values)</b>	<b>CCU to BIWF</b>
	<u><b>Address Information</b></u>	<u><b>Control information</b></u> Transaction ID = 2001 Context ID = Null / Context ID / ALL Termination ID = Termination(s) / Root / ALL Audit Descriptor = Empty / (Audit Token = (Digit Map) + (Packages / ((Mux) + (Modem) + (Events) + (Signals) + (Media))))
		<u><b>Bearer information</b></u>

**Initiation of information flow:** Information Flow 0.

**Processing upon receipt:** When the BIWF receives the AUD\_VAL.req, it returns AUD\_VAL.resp Information Flow 2 listing the Digit Map/Package/Property Names and Values realized by the Termination(s) or the BIWF level.

When Packages are requested, the Package Names and Versions are returned, while the Mux Type and the multiplexed Termination IDs are returned for the Mux Descriptor.

The Descriptors for Modem/Media/Termination State/Local Control/Local/Remote returns the current Property Value while the Descriptors for Signals/Events returns all possible/allowed Signal/Event Parameter Names and Values. The Service State returns the current Service State. Several Information Flows 2 might be required for this.

Address InformationControl informationBearer information

Termination ID =  
Termination(s) / Root / ALL

Empty Audit Descriptor:

-

AuditToken = Digit Map:

Digit Map Descriptor =  
Digit Map Name + Value

AuditToken = Packages:

Packages Descriptor =  
Package Names + Versions

AuditToken = Mux:

Mux Descriptor = Mux Type +  
All: Mux'ed Termination IDs

AuditToken = Modem:

Modem Descriptor =  
Modem Types +  
Package & Property Names +  
Current Property Value

AuditToken = Events:

Event Descriptor =  
Package & Event Names +  
Possible Event Parameter:  
Names + Values

AuditToken = Signals:

Signal Descriptor =  
Package & Signal Names +  
Possible Signal Parameter:  
Names + Values

AuditToken = Media:

Service State = Current Service State  
Termination State Descriptor =  
Package & Property Names +  
Current Property Value  
Local Control Descriptor =  
Package & Property Names +  
Current Property Value  
Local Descriptor =  
Package & Property Names +  
Current Property Value  
Remote Descriptor =  
Package & Property Names +  
Current Property Value

**Initiation of information flow:** Information Flow 1.

**Processing upon receipt:** When the CCU receives the AUD\_VAL.resp, and auditing of Mux Types, possible Property values, Signals or Events is required, it sends AUD\_CAP.req Flow(s) 3 to the registered BIWF. The CCU then includes the Termination(s) or the Root as Termination ID. ALL as Termination ID is indicated for Ephemeral Termination(s) not in use. The CCU may indicate auditing of the Descriptors for Mux and/or Modem and/or Events and/or Signals and/or Media.

A specific or null Context ID is indicated dependent on whether the Termination(s) are within a Context or not. ALL as Context ID is indicated for Ephemeral Termination(s) not in use or if the BIWF level is to be audited. Several Information Flows 3 might be required for all this. The CCU selects e.g. the Transaction ID of 2002 to be used.

**Address Information****Control information****Bearer information**

Transaction ID = 2002  
 Context ID = Null / Context ID / ALL  
 Termination ID =  
     Termination(s) / Root / ALL  
 Audit Descriptor =  
     Empty /  
     (Audit Token =  
       (Mux) + (Modem) + (Events) +  
       (Signals) + (Media))

**Initiation of information flow:** Information Flow 2.

**Processing upon receipt:** When the BIWF receives the AUD\_CAP.req, it returns AUD\_CAP.resp Information Flow 4 listing the Property Names and Values realized by the Termination(s) or the BIWF level. The Descriptors for Modem/Media/Termination State/Local Control/Local/Remote/Signal/Event returns all possible/allowed Names and Values for the Property/Signal Parameter/Event Parameter, while the Mux Type and the multiplexed Termination IDs are returned for the Mux Descriptor. The Service State returns the possible Service States. Several Information Flows 4 might be required for this.

**Address Information****Control information****Bearer information**

Termination ID =  
     Termination(s) / Root / ALL

Empty Audit Descriptor:

-

AuditToken = Mux:  
 Mux Descriptor = Mux Type +  
     All: Mux'ed Termination Ids

AuditToken = Modem:  
 Modem Descriptor =  
     Modem Types +  
     Requested: Package & Property Names  
     + Possible Property Values

AuditToken = Events:  
 Event Descriptor =  
     Package & Event Names +  
     Possible Event Parameter:  
     Names + Values

AuditToken = Signals:  
 Signal Descriptor =  
     Package & Signal Names +  
     Possible Signal Parameter:  
     Names + Values

AuditToken = Media:  
 Service State = Possible Service States  
 Termination State Descriptor =  
     Package & Property Names +  
     Possible Property Values  
 Local Control Descriptor =  
     Package & Property Names +  
     Possible Property Values  
 Local Descriptor =  
     Package & Property Names +  
     Possible Property Values  
 Remote Descriptor =  
     Package & Property Names +  
     Possible Property Values



**Initiation of information flow:** Information Flow 3.

**Processing upon receipt:** –

## **9 Outage and Recovery**

### **9.1 CCU Initiated**

#### **9.1.1 CCU outage**

The CCU outages show itself as a signalling failure or a CCU ordered service cancellation.

##### **9.1.1.1 CCU initiated service cancellation**

If the CCU goes out of service it starts the CCU initiated service cancellation procedure. See 8.10.2.3

##### **9.1.1.2 Signalling failure**

As a result of the recovery action the CCU may lose contact with the BIWF

### **9.1.2 CCU Recovery**

#### **9.1.2.1 CCU Initiated Service Restoration**

After the recovery action is complete and the signalling is working to the BIWF the CCU starts a timer  $T_w$ . If no recovery indications (BIWF communication-up, BIWF restoration or BIWF registration) are received from the BIWF during  $T_w$  the CCU service restoration is sent. If a recovery indication is received, this is acknowledged by the (G)MSC. After that, the (G)MSC restoration is sent.

## **9.2 BIWF Initiated**

This clause describes how a BIWF outage can take place and how the recovery from the outage situation is carried out.

### **9.2.1 BIWF outage**

The BIWF outage shows itself as a signalling failure or as a BIWF Service cancellation indication.

#### **9.2.1.1 The BIWF indicates Service cancellation**

The failure indication indicates that the BIWF will go out of service and that no new connections should be established using this BIWF. In the forced method, all connections are cleared immediately.

#### **9.2.1.2 A signalling outage**

No communication with the CCU is possible.

### **9.2.2 BIWF RECOVERY**

Depending on the severity of the outage of the BIWF, two possible procedures are possible.

#### **9.2.2.1 BIWF service restoration**

The BIWF indicates to all connected (G)MSCs that normal operation has resumed.

### **9.2.2.2 BIWF Registration**

The procedure is used at start-up or a severe recovery action when e.g. the protocol version and transport addresses need to be exchanged. The BIWF registers to its known (G)MSCs using the BIWF Registration procedure.



## SERIES OF ITU-T RECOMMENDATIONS

Series A	Organization of the work of ITU-T
Series B	Means of expression: definitions, symbols, classification
Series C	General telecommunication statistics
Series D	General tariff principles
Series E	Overall network operation, telephone service, service operation and human factors
Series F	Non-telephone telecommunication services
Series G	Transmission systems and media, digital systems and networks
Series H	Audiovisual and multimedia systems
Series I	Integrated services digital network
Series J	Cable networks and transmission of television, sound programme and other multimedia signals
Series K	Protection against interference
Series L	Construction, installation and protection of cables and other elements of outside plant
Series M	TMN and network maintenance: international transmission systems, telephone circuits, telegraphy, facsimile and leased circuits
Series N	Maintenance: international sound programme and television transmission circuits
Series O	Specifications of measuring equipment
Series P	Telephone transmission quality, telephone installations, local line networks
<b>Series Q</b>	<b>Switching and signalling</b>
Series R	Telegraph transmission
Series S	Telegraph services terminal equipment
Series T	Terminals for telematic services
Series U	Telegraph switching
Series V	Data communication over the telephone network
Series X	Data networks and open system communications
Series Y	Global information infrastructure and Internet protocol aspects
Series Z	Languages and general software aspects for telecommunication systems