



INTERNATIONAL TELECOMMUNICATION UNION

ITU-T

Q.954

TELECOMMUNICATION
STANDARDIZATION SECTOR
OF ITU

(10/95)

DIGITAL SUBSCRIBER SIGNALLING SYSTEM No. 1

**INTEGRATED SERVICES DIGITAL
NETWORK (ISDN) – STAGE 3 DESCRIPTION
FOR MULTIPARTY SUPPLEMENTARY
SERVICES USING DSS 1**

CLAUSE 2 – THREE PARTY (3PTY)

ITU-T Recommendation Q.954

(Previously “CCITT Recommendation”)

FOREWORD

The ITU-T (Telecommunication Standardization Sector) is a permanent organ of the International Telecommunication Union (ITU). The ITU-T is responsible for studying technical, operating and tariff questions and issuing Recommendations on them with a view to standardizing telecommunications on a worldwide basis.

The World Telecommunication Standardization Conference (WTSC), which meets every four years, establishes the topics for study by the ITU-T Study Groups which, in their turn, produce Recommendations on these topics.

The approval of Recommendations by the Members of the ITU-T is covered by the procedure laid down in WTSC Resolution No. 1 (Helsinki, March 1-12, 1993).

ITU-T Recommendation Q.954, clause 2, was revised by ITU-T Study Group 11 (1993-1996) and was approved under the WTSC Resolution No. 1 procedure on the 17th of October 1995.

NOTE

In this Recommendation, the expression "Administration" is used for conciseness to indicate both a telecommunication administration and a recognized operating agency.

© ITU 1996

All rights reserved. No part of this publication may be reproduced or utilized in any form or by any means, electronic or mechanical, including photocopying and microfilm, without permission in writing from the ITU.

CONTENTS

	<i>Page</i>
2 Three-party (3PTY).....	1
2.1 Scope	1
2.2 References.....	1
2.3 Definitions	2
2.4 Abbreviations.....	3
2.5 Description.....	3
2.6 Operational requirements.....	4
2.7 Coding requirements.....	4
2.8 State definitions	4
2.9 Signalling requirements	5
2.10 Procedures for interworking with private ISDN's.....	11
2.11 Interactions with other networks.....	11
2.12 Interactions with other supplementary services	12
2.13 Parameter values (timers)	15
2.14 Dynamic description (SDLs)	15
Appendix I – Signalling flows.....	27
I.1 Request for a three-way conversation.....	28
I.2 Disconnection of one remote user, and retention of the other	28
I.3 Disconnection of both remote users and terminating the call.....	30
I.4 Creation of a private communication with a remote user	32
I.5 Remote user terminates the call	33

SUMMARY

This Recommendation defines the operation of the Digital Subscriber Signalling System No. 1 (DSS 1) for the support of the Three-Party (3PTY) supplementary service at the T or the coincident S and T reference point of the Integrated Services Digital Network (ISDN).

The Three-Party supplementary service allows the user to establish, participate in, and control a three-way conversation, i.e. simultaneous communication involving the served user and two remote users.

**INTEGRATED SERVICES DIGITAL NETWORK (ISDN) –
STAGE 3 DESCRIPTION FOR MULTIPARTY
SUPPLEMENTARY SERVICES USING DSS 1**

(revised in 1995)

2 Three-party (3PTY)

2.1 Scope

This Recommendation specifies stage three of the Three-Party (3PTY) supplementary service for the Integrated Services Digital Network (ISDN) at the T reference point or coincident S and T reference point (as defined in Recommendation I.411 [1]) by means of the Digital Subscriber Signalling System No. 1 (DSS 1) protocol. Stage three identifies the protocol procedures and switching functions needed to support a telecommunications service (see Recommendation I.130 [2]).

In addition, this Recommendation specifies the protocol requirements at the T reference point where the service is provided to the user via an intermediate private ISDN.

This Recommendation does not specify the additional protocol requirements where the service is provided to the user via a telecommunications network that is not an ISDN.

The 3PTY supplementary service enables a user to establish, participate in and control, a three-way conversation, i.e. a simultaneous communication involving the served user and two remote users.

The 3PTY supplementary service is applicable to all circuit-switched telecommunication services carrying speech.

This Recommendation is applicable to equipment, supporting the 3PTY supplementary service, to be attached at either side of a T reference point or coincident S and T reference point when used as an access to the public ISDN.

2.2 References

The following Recommendations and other references contain provisions which, through reference in this text, constitute provisions of this Recommendation. At the time of publication, the editions indicated were valid. All Recommendations and other references are subject to revision; all users of this Recommendation are therefore encouraged to investigate the possibility of applying the most recent edition of the Recommendations and other references listed below. A list of the currently valid ITU-T Recommendations is regularly published.

- [1] ITU-T Recommendation I.411 (1993), *ISDN user-network interfaces – Reference configurations*.
- [2] CCITT Recommendation I.130 (1988), *Method for the characterization of telecommunication services supported by an ISDN and network capabilities of an ISDN*.
- [3] ITU-T Recommendation Q.931 (1993), *Digital Subscriber Signalling System No. 1 (DSS 1) – ISDN user-network interface layer 3 specification for basic call control*.
- [4] CCITT Recommendation Q.9 (1988), *Vocabulary of switching and signalling terms*.
- [5] ITU-T Recommendation Q.920 (1993), *Digital Subscriber Signalling System No. 1 (DSS 1) – ISDN user-network interface data link layer – General aspects*.
- [6] ITU-T Recommendation I.112 (1993), *Vocabulary of terms for ISDNs*.
- [7] ITU-T Recommendation Q.932 (1993), *Digital Subscriber Signalling System No. 1 (DSS 1) – Generic procedures for the control of ISDN supplementary services*.

- [8] ITU-T Recommendation Q.952¹⁾, *Stage 3 description for call offering supplementary services using DSS 1. Clause 7 – Explicit Call Transfer (ECT)*.
- [9] CCITT Recommendation X.219 (1988), *Remote operations: Model, notation and service definition*.
- [10] ITU-T Recommendation I.210 (1993), *Principles of telecommunication services supported by an ISDN and the means to describe them*.
- [11] CCITT Recommendation X.208 (1988), *Specification of Abstract Syntax Notation One (ASN.1)*.
- [12] ITU-T Recommendation Z.100 (1993), *CCITT Specification and Description Language (SDL)*.
- [13] ITU-T Recommendation Q.953 (1993), *ISDN Stage 3 description for call completion supplementary services using DSS 1. Clause 2 – Call Hold*.
- [14] ITU-T Recommendation Q.956 (1995), *Integrated Services Digital Network (ISDN) – Stage 3 description for charging supplementary services using DSS 1. Clause 2 – Advice of Charge (AOC)*.
- [15] ITU-T Recommendation Q.955 (1993), *Stage 3 description for community of interest supplementary services using (DSS 1). Clause 3 – Multilevel precedence and preemption (MLPP)*.

2.3 Definitions

For the purposes of this Recommendation, the following definitions apply:

- 2.3.1 active-held connection:** A connection between two users where at the served user, the call state is Active, and the auxiliary state is Call Held.
- 2.3.2 active-idle connection:** A connection between two users where at the served user, the call state is Active, and the auxiliary state is Idle.
- 2.3.3 call state:** A state as defined in 2.1/Q.931 [3] for either the user side or the network side as appropriate. A call state may exist for each Call Reference (CR) value [and for each additional responding Connection Endpoint Identifier (CEI) in the incoming call state].
- 2.3.4 call:** See 2.2/Q.9 [4], definition 2201.
- 2.3.5 connection endpoint identifier (CEI):** The identifier that identifies the data link connection which is used to transfer the signalling information (for the complete definition see 3.4.1/Q.920 [5]).
- 2.3.6 connection:** See clause 0/Q.9 [4], definition 0011.
- 2.3.7 integrated services digital network (ISDN):** See 2.3/I.112 [6], definition 308.
- 2.3.8 invoke component:** See 6.3/Q.932 [7] for the application of this component as defined in Recommendation X.219 [9]. Where reference is made to “xxxx” invoke component, an invoke component is meant with its operation value set to the value of the operation “xxxx”.
- 2.3.9 local interaction:** An interaction of the protocol for two or more supplementary services where the served user (of all supplementary services) is on the same access.
- 2.3.10 local interaction for the call:** The local interaction exists on a single call, i.e. both supplementary services are invoked for the same call.
- 2.3.11 network:** The DSS 1 protocol entity at the network side of the user-network interface.
- 2.3.12 no impact:** The interaction between the two identified supplementary services contains no requirements for the protocol over and above the requirements of the Recommendation for each individual supplementary service.
NOTE – Other aspects of interactions that do not affect the DSS 1 protocol are covered in the service description for the relevant supplementary services.
- 2.3.13 not applicable:** The interaction between the two identified supplementary services is outside the scope of this Recommendation, e.g. the interaction is between the supplementary service and itself, and is therefore covered in the Recommendation for the individual supplementary service.

¹⁾ Presently at the stage of draft.

2.3.14 private communication: Communication between the served user and one remote user. This excludes communication with the other remote user.

2.3.15 reject component: See 6.3/Q.932 [7] for the application of this component as defined in Recommendation X.219 [9].

2.3.16 remote interaction: An interaction of the protocol for two or more supplementary services where one user is the served user for one supplementary service and (for the same call) the remote user for another supplementary service. The interaction for the served user's supplementary service exists at the remote user.

2.3.17 remote user: The two other users to the served user which are involved in the two calls that are joined together in a three-way conversation. The remote users are distinguished as user B and user C.

2.3.18 return error component See 6.3/Q.932 [7] for the application of this component as defined in Recommendation X.219 [9]. Where reference is made to "xxxx" return error component, a return error component is meant which is related to an "xxxx" invoke component.

2.3.19 return result component: See 6.3/Q.932 [7] for the application of this component as defined in Recommendation X.219 [9]. Where reference is made to "xxxx" return result component, a return result component is meant which is related to an "xxxx" invoke component.

2.3.20 served user: The user (DSS 1 protocol entity) which invokes this supplementary service; this user is also referred to as user A.

2.3.21 service; telecommunications service: See 2.2/I.112 [6], definition 201.

2.3.22 supplementary service: See 2.4/I.210 [10].

2.3.23 three-way conversation: Communication between all three users, i.e. the served user and both remote users.

2.3.24 three-way bridge: The network equipment which performs connections between three users to allow three-way conversation.

2.3.25 user: The DSS 1 protocol entity at the user side of the user-network interface.

2.4 Abbreviations

For the purposes of this Recommendation, the following abbreviations are used:

3PTY	Three-Party
ASN.1	Abstract Syntax Notation one
CEI	Connection Endpoint Identifier
CR	Call Reference
DSS 1	Digital Subscriber Signalling System No. 1
ISDN	Integrated Services Digital Network
PSTN	Public Switched Telephone Network
SDL	Specification and Description Language

2.5 Description

The served user, which has only one Active-Idle connection, and at least one Active-Held connection can join the Active-Idle connection with one of the Active-Held connections, to form a three-way conversation.

NOTES

1 Each call, to be involved in the 3PTY supplementary service, could have been originated by either the served user, or by the appropriate remote user.

During the three-way conversation the served user can request that the network:

- explicitly disconnects one of the remote users, and the connection to that remote user;
- terminates the three-way conversation; or
- creates a private communication with one of the remote users.

Either of the remote users (user B or user C) can request that the network disconnects the connection.

Remote users are notified of these actions.

2 During an interim period of time, some networks may not support the transfer of the notification to the remote users.

3 The protocol for implementation of the 3PTY supplementary service is restricted to implementations where only one call within an Active-Idle connection exists for that CEI value. User implementations, e.g. multifunctional terminals, that in a normal operation support more than one call with an Active-Idle connection on the same CEI value, cannot make effective use of this protocol.

2.6 Operational requirements

2.6.1 Provision and withdrawal

The 3PTY supplementary service shall be provided by prior arrangement with the service provider.

The 3PTY supplementary service shall be withdrawn by the service provider upon request of the subscriber or for service provider reasons.

2.6.2 Requirements on the originating network side

The requirements of 5.1/Q.931 [3] shall apply.

2.6.3 Requirements on the destination network side

The requirements of 5.2/Q.931 [3] shall apply.

2.7 Coding requirements

2.7.1 Coding of the Facility information element components

Table 2-1 shows the definition of the operations and types required for the 3PTY supplementary service using ASN.1 as defined in Recommendation X.208 [11] and using the OPERATION macro as defined in Figure 4/X.219 [9].

The formal definition of the component types to encode these operations and types is provided in Table 8-6/Q.932 [7].

The inclusion of components in Facility information elements is defined in 8.2.2/Q.932 [7].

All components (invoke, return result, return error and reject) shall be included within a Facility information element. The Facility information element shall be included in the message as specified in 2.9.

2.7.2 Coding of the Notification indicator information element

The notification description is contained in octet 3 of the Notification indicator information element and shall be coded as shown in Table 2-2.

NOTE – The following guidance is given for the interpretation of the notification descriptions at a remote user. A notification description of “Remote hold” indicates a loss of communication path in the B-channel. When three-way conversation exists, this may be due to termination of the three-way conversation, which will be indicated by a subsequent notification description of “Conference disconnected”, or due to operation of some supplementary services, e.g. the call hold supplementary service. When the notification description of “Conference disconnected” is received, a communication path exists in the B-channel, unless the notification description is accompanied by, or immediately followed by, a notification description of “Remote hold”, which indicates a loss of communication path in the B-channel.

2.8 State definitions

The call states as specified in 2.1/Q.931 [3] shall apply.

The auxiliary states as specified in 6.2.1.1/Q.932 [7] shall apply.

The following states are defined for the network:

- 3PTY Idle: an occurrence of the 3PTY supplementary service has not been requested;
- 3PTY Active: an occurrence of the 3PTY supplementary service exists;
- 3PTY Await Retrieve: a Retrieve function should be initiated by the user prior to ending of the 3PTY supplementary service;

- 3PTY Await Hold And Retrieve: a Hold function and a Retrieve function should be initiated by the user prior to ending of the 3PTY supplementary service;
- 3PTY Await Hold: a Hold function should be initiated by the user prior to ending of the 3PTY supplementary service;

The following states are defined for the user:

- 3PTY Idle: an occurrence of the 3PTY supplementary service has not been requested;
- 3PTY Active: an occurrence of the 3PTY supplementary service exists;
- Begin3PTY Request: the 3PTY supplementary service has been requested by the served user;
- End3PTY Request: the served user wants to have a private conversation with one of the remote users.

TABLE 2-1/Q.954

Definition of operations for the 3PTY supplementary service

Three-Party-Operations {itu recommendation q 954 three-party (2) operations-and-errors (1)}		
DEFINITIONS EXPLICIT TAGS ::=		
BEGIN		
EXPORTS	Begin3PTY, End3PTY;	
IMPORTS	OPERATION	
	FROM Remote-Operation-Notation	
	{joint-iso-ccitt remote-operations (4) notation (0)}	
	userNotSubscribed, notAvailable, invalidCallState,	
	resourceUnavailable,	
	supplementaryServiceInteractionNotAllowed	
	FROM General-Errors	
	{ccitt recommendation q 950 general-error-list (1)};	
Begin3PTY ::= OPERATION		
	RESULT	
	ERRORS	{userNotSubscribed, notAvailable, invalidCallState,
		resourceUnavailable,
		supplementaryServiceInteractionNotAllowed}
<i>-- This Recommendation does not provide procedures for the generation of the error "notAvailable"</i>		
End3PTY ::= OPERATION		
	RESULT	
	ERRORS	{invalidCallState}
begin3PTY	Begin3PTY	::= localValue 4
end3PTY	End3PTY	::= localValue 5
END		

2.9 Signalling requirements

2.9.1 Activation, deactivation and registration

Not applicable, i.e. no signalling procedures are required for the activation, deactivation and registration of the 3PTY supplementary service.

TABLE 2-2/Q.954

Codepoints in the Notification indicator information element

Bits	
8 7 6 5 4 3 2 1	
1 1 0 0 0 0 1 0	Conference established (Note 1)
1 1 0 0 0 0 1 1	Conference disconnected (Note 2)
1 1 1 1 0 0 1	Remote hold
NOTES	
1	The user takes part in a multiparty call.
2	The user takes part in a normal two-party call.

2.9.2 Invocation and operation**2.9.2.1 Request for a three-way conversation****2.9.2.1.1 Normal operation**

In order to request the 3PTY supplementary service, the served user requires two calls each related to the same CEI value, one with each of the remote users. One call shall have an Active-Idle connection. The other call shall have an Active-Held connection. The served user shall have no other calls with Active-Idle connections related to the same CEI value. Other calls with Active-Held connections may exist.

To request the 3PTY supplementary service, the served user shall send to the network a Begin3PTY invoke component according to the procedures of 6.3.1/Q.932 [7], within a FACILITY message, and using the CR of the appropriate Active-Held connection.

NOTE – The other CR is implicitly identified by the constraint that it is the only Active-Idle connection.

On receiving this request, the network shall check whether:

- the 3PTY supplementary service is allowed to this user;
- that the received request relates to an Active-Held connection;
- that for the CEI value on which the request is received, a single Active-Idle connection exists;
- that a three-way bridge is available for use;
- that no three-way bridge that is controlled by the served user is already included in the Active-Idle connection or in the Active-Held connection; and
- that the requirements of 2.12 are met for the other supplementary service interactions.

If these requirements are met, the network shall:

- a) allocate a three-way bridge;
- b) attach the identified connections to this three-way bridge using the B-channel of the Active-Idle connection to support user information transfer with the served user;
- c) return to the served user a Begin3PTY return result component according to the procedures of 6.3.1/Q.932 [7], within a FACILITY message, and using the CR of the appropriate Active-Held connection; and
- d) send a NOTIFY message to the remote users containing a Notification indicator information element with a notification description of “Conference established”.

When the served user receives a correctly encoded Begin3PTY return result component, within a FACILITY message, the user shall accept the provided information and shall not respond to the network.

As a result of the procedures of this subclause, the call states and the auxiliary states of the two connections, at both the network and the user, are unchanged.

2.9.2.1.2 Exceptional procedures

On receiving a Begin3PTY invoke component, within a FACILITY message, according to the procedures of 6.3.1/Q.932 [7], but three-way conversation is not allowed, the network shall return to the served user a Begin3PTY return error component, according to the procedures of 6.3.1/Q.932 [7], within a FACILITY message, or in any other appropriate call control message, and using the CR of the connection on which the message has been received, and take no action on any connections for that user.

The error included in the Begin3PTY return error component shall be one of the following:

- “userNotSubscribed”, if the 3PTY service has not been subscribed;
- “invalidCallState”, if the received request does not relate to an Active-Held connection, or no Active-Idle connection exists for that CEI value, or more than one Active-Idle connection exists for that CEI value;
- “resourceUnavailable”, if a three-way bridge is not available for use;
- “supplementaryServiceInteractionNotAllowed”, if a three-way bridge already exists in one or both of the identified connections, and the three-way bridge relates to the same served user, or if the provision of the service is precluded by a procedure within 2.12.

The served user, on receiving a Begin3PTY return error component, shall take no action, and remain in the state that existed before the Begin3PTY invoke component was sent.

If the network receives a Begin3PTY invoke component in a message other than a FACILITY message, then the network shall return a Begin3PTY return error component according to the procedures of 6.3.1/Q.932 [7]. The error included in the Begin3PTY return error component shall be “invalidCallState”. The Begin3PTY return error component shall be returned to the served user by the appropriate call control message or call hold and retrieve family of messages as specified in 6.2/Q.932 [7], or a FACILITY message.

The served user, on receiving a reject component, shall take no action, and remain in the state that existed before the Begin3PTY invoke component was sent.

The network, on receiving a reject component, shall take no action, and remain in the state that existed before the reject component was received.

Once the network decides that the 3PTY supplementary service has been successfully invoked, up until the time that the network decides that the three-way conversation is ended, the following procedures apply. If the network receives a RETRIEVE message for the Active-Held connection, then the Retrieve function shall be rejected according to the procedures of Recommendation Q.932 [7] with cause #29 “Facility rejected”.

2.9.2.2 Disconnection of one remote user, and retention of the other

2.9.2.2.1 Normal operation

The remote user to be disconnected is identified at the served user by the CR relating to either the Active-Held connection, or to the Active-Idle connection. Depending on which applies, one of the two following procedures shall be followed:

- a) If the remote user to be disconnected is identified at the served user by a CR relating to the Active-Idle connection, the served user shall send a DISCONNECT message with that CR, in accordance with the procedures of 5.3/Q.931 [3].

On receiving such a DISCONNECT message, the network shall:

- i) clear the connection to the appropriate remote user;
NOTE 1 – The receipt of clearing information at this remote user indicates the end of three-way conversation.
- ii) continue clearing the identified CR to the served user in accordance with the procedures of 5.3/Q.931 [3]. The network shall provide any appropriate reservation function as defined in 6.4/Q.932 [7], in association with this clearing;
- iii) remove the three-way bridge from the Active-Held connection to the other remote user;
- iv) release the three-way bridge; and
- v) send a NOTIFY message to the remaining remote user containing a Notification indicator information element with a notification description of “Remote hold”.

On receiving the RELEASE message, as provided by the procedures of 5.3/Q.931 [3], the served user shall:

- i) continue to clear the CR on which clearing was initiated in accordance with the procedures of 5.3/Q.931 [3]; and
- ii) using the CR relating to the Active-Held connection, perform the Retrieve function in accordance with the procedures of 6.2.3/Q.932 [7].

NOTE 2 – The served user may need to allow for completion of clearing of the CR on which clearing was initiated before performing the Retrieve function in order to ensure success of channel selection during the Retrieve function.

On receiving a RETRIEVE message indicating a request for the Retrieve function, the network shall:

- i) complete the Retrieve function (according to the procedures of 6.2.3/Q.932 [7]), using any appropriate reservation (according to the procedures of 6.4/Q.932 [7]);

NOTE 3 – A Notification indicator information element with a notification description of “Remote retrieval” is not sent to the remote user under these circumstances.

- ii) send a NOTIFY message to the remaining remote user containing a Notification indicator information element with a notification description of “Conference disconnected”.

As a result of the procedures of this item of this subclause, the call state of the remaining connection, at both the network and the served user, is unchanged. The auxiliary state is Idle.

- b) If the remote user to be disconnected is identified at the served user by a CR relating to the Active-Held connection, the served user shall send a DISCONNECT message with that CR, in accordance with the procedures of 5.3/Q.931 [3].

On receiving such a DISCONNECT message, the network shall:

- i) clear the connection to the appropriate remote user;

NOTE 4 – The receipt of clearing information at this remote user indicates the end of three-way conversation.

- ii) continue clearing the identified CR to the served user in accordance with the procedures of 5.3/Q.931 [3];
- iii) remove the three-way bridge from the Active-Idle connection to the other remote user;
- iv) release the three-way bridge; and
- v) send a NOTIFY message to the remaining remote user containing a Notification indicator information element with a notification description of “Conference disconnected”.

As a result of the procedures of this item of this subclause, the call state and the auxiliary state of the remaining connection, at both the network and the served user, are unchanged.

2.9.2.2.2 Exceptional procedures

All exceptional conditions shall be treated according to the procedures of 5.8/Q.931 [3].

2.9.2.3 Disconnection of both remote users, and terminating the call

2.9.2.3.1 Normal operation

The served user shall send a DISCONNECT message on both:

- the CR relating to the Active-Held connection. Subsequent procedures shall be according to 2.9.2.2.1 b);
- the CR relating to the Active-Idle connection. Subsequent procedures shall be according to 2.9.2.2.1 a) except that the served user shall not perform the Retrieve function.

The network shall create the notification towards the remaining remote user only on disconnection of the first remote user.

NOTE – Any notification description received at a remote user immediately prior to a clearing indication is cancelled by that clearing indicator and can be ignored.

2.9.2.3.2 Exceptional procedures

All exceptional conditions shall be treated according to the procedures of 5.8/Q.931 [3].

2.9.2.4 Creation of a private communication with a remote user

2.9.2.4.1 Normal operation

The remote user, for which a private communication is required, is identified at the served user by a CR relating to either the Active-Held connection, or to the Active-Idle connection. Depending on which applies, one of the two following procedures shall be followed:

- a) If the remote user, for which a private communication is required, is identified at the served user by a CR relating to the Active-Held connection, the served user shall send an End3PTY invoke component to the network in a FACILITY message with that CR, in accordance with the procedures of 6.3.1/Q.932 [7].

On receiving such an invoke component in a FACILITY message, the network shall:

- i) remove the three-way bridge from both the Active-Idle connection and the Active-Held connection;
- ii) release the three-way bridge;
- iii) return to the served user an End3PTY return result component, within a FACILITY message, according to the procedures of 6.3.1/Q.932 [7], and using the CR of the Active-Held connection;
- iv) send a NOTIFY message to the remote user with which private communication is required containing a Notification indicator information element with a notification description of "Remote hold"; and
- v) send a NOTIFY message to the other remote user containing a Notification indicator information element with a notification description of "Conference disconnected".

When the served user receives a correctly encoded End3PTY return result component, within a FACILITY message, the user shall accept the provided information and shall:

- i) using the CR relating to the Active-Idle connection, perform the Hold function in accordance with the procedures of 6.2.2/Q.932 [7];
- ii) using the CR relating to the Active-Held connection, perform the Retrieve function in accordance with the procedures of 6.2.3/Q.932 [7].

NOTE 1 – If the network processes the RETRIEVE message before the HOLD message (e.g. the user sends a RETRIEVE message before the Hold function is completed, or due to internal message handling in the network), the successful outcome of the Retrieve function will depend on the availability of a free B-channel. In case a free B-channel is not available, the network cannot successfully complete the Retrieve function. In order to ensure success of channel selection during the Retrieve function, unless the user knows that a free B-channel is available, the user should wait for completion of the Hold function before performing the Retrieve function.

The network shall complete the Hold and Retrieve functions (according to the procedures of 6.2.2/Q.932 and 6.2.3/Q.932 [7]), creating and using any appropriate reservation (according to the procedures of 6.4/Q.932 [7]). On successful completion of the Hold function (i.e. the HOLD ACKNOWLEDGE message is sent) the network shall send a NOTIFY message, to the remote user that is not to be included in the private communication, containing a Notification indicator information element with a notification description of "Remote hold". On successful completion of the Retrieve function (i.e. RETRIEVE ACKNOWLEDGE message is sent) the network shall send a NOTIFY message, to the remote user for whom private communication is desired, containing a Notification indicator information element with a notification description of "Conference disconnected".

NOTE 2 – A Notification indicator information element with a notification description of "Remote retrieval" is not sent to the remote user under these circumstances.

As a result of the procedures of this item of this subclause, the call state of the connections, at both the network and the served user, is unchanged. The auxiliary state of the connection of the private communication changes from Call Held to Idle. The auxiliary state of the other connection changes from Idle to Call Held.

- b) If the remote user, for which a private communication is required, is identified at the served user by the CR relating to the Active-Idle connection, the served user shall send an End3PTY invoke component to the network in a FACILITY message with that CR, in accordance with the procedures of 6.3.1/Q.932 [7].

On receiving such an invoke component in a FACILITY message, the network shall:

- i) remove the three-way bridge from both the Active-Idle connection and the Active-Held connection;
- ii) release the three-way bridge;
- iii) return to the served user an End3PTY return result component, within a FACILITY message, according to the procedures of 6.3.1/Q.932 [7], and using the CR of the Active-Idle connection;
- iv) send a NOTIFY message to both remote users containing a Notification indicator information element with a notification description of “Conference disconnected”; and
- v) send to the remote user for which private communication is not required, either in the same NOTIFY message as iv), or in a subsequent NOTIFY message, a Notification indicator information element with a notification description of “Remote hold”.

NOTE 3 – If any intervening protocol between the network of the served user and the network of the remote user does not support transmission of two notification descriptions in the same message, then this should be mapped at that point to a message containing a single notification description of “Conference disconnected”, and a subsequent message containing a notification description of “Remote hold”.

When the served user receives a correctly encoded End3PTY return result component, within a FACILITY message, the user shall accept the provided information and take no further action.

As a result of the procedures of this item of this subclause, the call state and the auxiliary state of the connections, at both the network and the served user, are unchanged.

2.9.2.4.2 Exceptional procedures

On receiving an End3PTY invoke component, within a FACILITY message, according to the procedures of 6.3.1/Q.932 [7], but no three-way conversation exists, the network shall return to the served user an End3PTY return error component, according to the procedures of 6.3.1/Q.932 [7], in any appropriate message and using the CR on which the message has been received.

On receiving an End3PTY invoke component, within a message other than a FACILITY message, according to the procedures of 6.3.1/Q.932 [7], but no three-way conversation exists, the network shall return to the served user an End3PTY return error component, according to the procedures of 6.3.1/Q.932 [7], in any appropriate message and using the CR on which the message has been received.

On receiving an End3PTY invoke component, within a message other than a FACILITY message, according to the procedures of 6.3.1/Q.932 [7], and a three-way conversation exists, the network shall return to the served user an End3PTY return error component, according to the procedures of 6.3.1/Q.932 [7], in any appropriate message and using the CR on which the message has been received.

The error included in the End3PTY return error component shall be “invalidCallState”.

The served user, on receiving an End3PTY return error component, shall take no action, and remain in the state that existed before the End3PTY invoke component was sent.

The served user, on receiving a reject component, shall take no action, and remain in the state that existed before the End3PTY invoke component was sent.

The network, on receiving a reject component, shall take no action, and remain in the state that existed before the reject component was received.

2.9.2.5 Remote user terminates the call

2.9.2.5.1 Normal operation

The remote user to be disconnected is identified at the served user by a CR relating to either an Active-Held connection, or to an Active-Idle connection. Depending on which applies, one of the two following procedures shall be followed:

- a) If a remote user (or remote network), identified at the served user by a CR relating to the Active-Idle connection, clears the connection according to the procedures of 5.3/Q.931 [3], then the network shall:
 - i) send a DISCONNECT message with that CR to the served user, in accordance with the procedures of 5.3/Q.931 [3];

- ii) remove the three-way bridge from the Active-Held connection to the other remote user;
- iii) release the three-way bridge; and
- iv) send a NOTIFY message to the remaining remote user containing a Notification indicator information element with a notification description of "Remote hold".

On receiving the DISCONNECT message, as provided by the procedures of 5.3/Q.931 [3], the served user shall:

- i) continue to clear the CR on which clearing was initiated in accordance with the procedures of 5.3/Q.931 [3]; and
- ii) using the CR relating to the Active-Held connection, perform the Retrieve function in accordance with the procedures of 6.2.3/Q.932 [7].

NOTE 1 – The served user may need to allow for completion of clearing of the CR on which clearing was initiated before performing the Retrieve function in order to ensure success of channel selection during the Retrieve function.

On receiving a RETRIEVE message indicating a request for the RETRIEVE function, the network shall:

- i) complete the Retrieve function (according to the procedures of 6.2.3/Q.932 [7], using any appropriate reservation (according to the procedures of 6.4/Q.932 [7]);

NOTE 2 – A Notification indicator information element with a notification description of "Remote retrieval" is not sent to the remote user under these circumstances.

- ii) send a NOTIFY message to the remaining remote user containing a Notification indicator information element with a notification element description of "Conference disconnected".

As a result of the procedures of this item of this subclause, the call state of the remaining connection, at both the network and the served user, is unchanged. The auxiliary state is Idle.

- b) If a remote user (or remote network), identified at the served user by a CR relating to an Active-Held connection, clears the connection according to the procedures of 5.3/Q.931 [3], then the network shall:
 - i) send a DISCONNECT message with that CR to the served user, in accordance with the procedures of 5.3/Q.931 [3];
 - ii) remove the three-way bridge from the Active-Idle connection to the other remote user;
 - iii) release the three-way bridge; and
 - iv) send a NOTIFY message to the remaining remote user containing a Notification indicator information element with a notification description of "Conference disconnected".

As a result of the procedures of this item of this subclause, the call state and the auxiliary state of the remaining connection, at both the network and the served user, are unchanged.

2.9.2.5.2 Exceptional procedures

All exceptional conditions shall be treated according to the procedures of 5.8/Q.931 [3].

2.10 Procedures for interworking with private ISDN's

Notifications from a private ISDN shall be transferred through the public ISDN, if the service provider resides in a private ISDN.

If the remote user resides in a private ISDN, then the public network shall send the notifications according to the procedures of 2.9.2.

Other procedures for the coincident S and T reference point do not apply at the T reference point, i.e. procedures for the control of a three-way bridge in the network (DSS 1 protocol entity) of a public ISDN when the served user (DSS 1 protocol entity) is a private ISDN are outside the scope of this Recommendation.

2.11 Interactions with other networks

Remote users in a Public Switched Telephone Network (PSTN) need not receive notifications.

2.12 Interactions with other supplementary services

2.12.1 Call Waiting

No impact.

2.12.2 Explicit Call Transfer

The interaction between the 3PTY supplementary service and the explicit call transfer supplementary service is contained in Recommendation Q.952.7 [8].

2.12.3 Connected Line Identification Presentation

No impact.

2.12.4 Connected Line Identification Restriction

No impact.

2.12.5 Calling Line Identification Presentation

No impact.

2.12.6 Calling Line Identification Restriction

No impact.

2.12.7 Closed User Group

2.12.7.1 Coding requirements

No impact.

2.12.7.2 Signalling procedures at the coincident S and T reference point

2.12.7.2.1 Creating a three-way conversation

2.12.7.2.1.1 Normal operation

No impact.

2.12.7.2.1.2 Exceptional procedures

If, within the 3PTY supplementary service, the network refuses a request to join two calls because the constituent calls were requested using different closed user groups, the Begin3PTY return error component shall contain the error "supplementaryServiceInteractionNotAllowed".

2.12.7.3 Procedures for interworking with private ISDNs

No impact.

2.12.8 Conference call, add-on

If the served user requests to join two calls and one of the calls is a conference call established by the served user, the network shall apply the procedure described in 2.12.8.2.1 indicating the error "supplementary service interaction not allowed".

2.12.8.1 Coding requirements

No impact.

2.12.8.2 Signalling procedures at the coincident S and T reference point

2.12.8.2.1 Requesting a three-way conversation where one of the connections belongs to a conference call

2.12.8.2.1.1 Normal operation

No impact.

NOTE – The invocation of the 3PTY supplementary service is not allowed for the served user of the conference call, add-on supplementary service.

2.12.8.2.1.2 Exceptional procedures

If, within the 3PTY supplementary service, the network refuses a request to join two calls, because one of the calls is part of a conference controlled by the same served user (local interaction for the call), the network shall send a Begin3PTY return error component to the served user, indicating “supplementaryServiceInteractionNotAllowed”.

2.12.8.2.2 Adding a three-way conversation to a conference

2.12.8.2.2.1 Normal operation

No impact.

NOTE – The invocation of the 3PTY supplementary service is not allowed for the served user of the conference call, add-on supplementary service.

2.12.8.2.2.2 Exceptional procedures

If, within the conference call, add-on supplementary service, the network refuses a request to add a call to a conference, because the call is part of a three-way conversation controlled by the same served user (local interaction for the same call), the network shall send a AddCONF return error component to the served user, indicating “supplementaryServiceInteractionNotAllowed”.

2.12.8.2.3 Invocation of the conference call, add-on supplementary service for a connection in a three-way conversation

2.12.8.2.3.1 Normal operation

No impact.

NOTE – The invocation of the conference call, add-on supplementary service is not allowed for the served user of the 3PTY supplementary service.

2.12.8.2.3.2 Exceptional procedures

If, within the conference call, add-on supplementary service, the network refuses a request to invoke the conference call, add-on supplementary service, because the call is part of a three-way conversation controlled by the same served user (local interaction for the call), the network shall send a BeginCONF return error component to the served user, indicating “supplementaryServiceInteractionNotAllowed”.

2.12.8.2.4 Remote user uses the 3PTY supplementary service

2.12.8.2.4.1 Normal operation

If, during operation of the conference call, add-on supplementary service, a remote user uses the 3PTY supplementary service (remote interaction), then notifications concerning the 3PTY supplementary service shall be sent as normal to the served user, with the following addition:

- the network shall send the Notification indicator information to the served user in a FACILITY message according to the procedures of 6.3.1/Q.932;
- the network shall include in the same message a Facility information element containing an IdentifyConferee invoke component. The IdentifyConferee operation is specified in Table 1-1/Q.954.1. The PartyId parameter shall indicate the remote user pertaining to the provided notification.

2.12.8.2.4.2 Exceptional procedures

No impact.

2.12.8.3 Procedures for interworking with private ISDNs

See 2.12.8.2.4/Q.954.1.

2.12.9 Direct-Dialling-In

No impact.

2.12.10 Diversion services

2.12.10.1 Call Forwarding Busy

No impact.

2.12.10.2 Call Forwarding No Reply

No impact.

2.12.10.3 Call Forwarding Unconditional

No impact.

2.12.10.4 Call Deflection

No impact.

2.12.11 Line Hunting

No impact.

2.12.12 Three-Party

Not applicable.

2.12.13 User-to-User Signalling

No impact.

2.12.14 Multiple Subscriber Number

No impact.

2.12.15 Call Hold

Any party involved in a three-way conversation is able to put the connection to the three-way conversation on hold and later retrieve it.

2.12.15.1 Coding requirements

No impact.

2.12.15.2 Signalling procedures at the coincident S and T reference point

2.12.15.2.1 Creating a three-way conversation from a held call

No impact.

2.12.15.2.2 Holding a three-way conversation

In order to hold a three-way conversation (local interaction for the call), the procedures of 2.5.2.1.1.2/Q.953.2, 2.5.2.1.2/Q.953.2 and 2.5.2.3/Q.953.2 [13] shall apply with the following exceptions:

- a) the Hold function shall be used only for the Active-Idle connection; and
- b) the NOTIFY message, containing a Notification indicator information element with a description of "Remote hold" shall be sent to neither of the remote users.

2.12.15.2.3 Retrieving a three-way conversation

In order to retrieve a three-way conversation (local interaction for the call), the procedures of 2.5.2.1.3/Q.953.2, 2.5.2.1.4/Q.953.2 and 2.5.2.3/Q.953.2 [13] shall apply with the following exceptions:

- a) the Retrieve function shall be used on only one of the two Active-Held connections;
- b) the NOTIFY message, containing a Notification indicator information element with a notification description of "Remote retrieval", shall be sent to neither of the remote users; and
- c) if an attempt is made to perform the Retrieve function on the remaining Active-Held connection, then the Retrieve function shall be rejected according to the procedures of 6.2.3.3/Q.932, with cause #29 "Facility rejected".

2.12.15.3 Procedures for interworking with private ISDNs

No impact.

2.12.16 Advice Of Charge

The interaction between the 3PTY supplementary service and the advice of charge supplementary service are contained in Recommendation Q.956.2 [14].

2.12.17 Sub-addressing

No impact.

2.12.18 Terminal Portability

The interaction between the 3PTY supplementary service and the terminal portability supplementary service will be contained in a future Recommendation of the Q.958.X-Series.

2.12.19 Completion of Calls to Busy Subscriber

No impact.

2.12.20 Malicious Call Identification

No impact.

2.12.21 Reverse Charging

No impact.

2.12.22 Multi-level Precedence and Preemption

The interaction of the 3PTY supplementary service with the multi-level precedence and preemption supplementary service is described in Recommendation Q.955.3 [15].

2.12.23 Support of private numbering plan

No applicable interaction at this time.

2.12.24 International Telecommunication Charge Card

No applicable interaction at this time.

2.12.25 Global virtual networking service

No applicable interaction at this time.

2.13 Parameter values (timers)

No timers are defined.

2.14 Dynamic description (SDLs)

The dynamic descriptions are specified in Figures 2-1 and 2-2. Figures 2-1 and 2-2 are specified according to Recommendation Z.100 [12]; Figure 2-1/Q.954 shows the user of the 3PTY supplementary service and Figure 2-2 shows the network.

The SDLs for the notification procedure of the remote users are according to Annex A/Q.931 [3].

Two basic connections are involved in the 3PTY supplementary service:
 – one Active-Held connection; and
 – one Active-Idle connection.

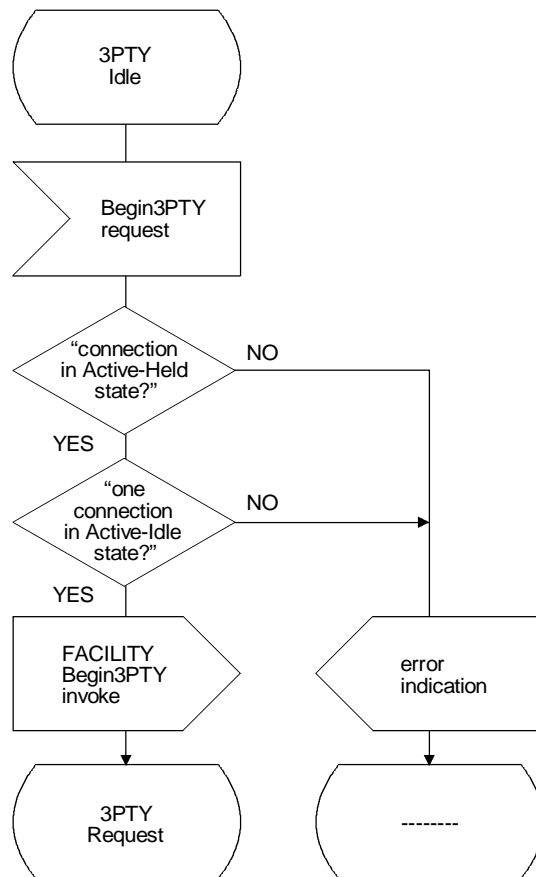

T1167810-94/d01

FIGURE 2-1/Q.954 (sheet 1 of 4)

SDL for user

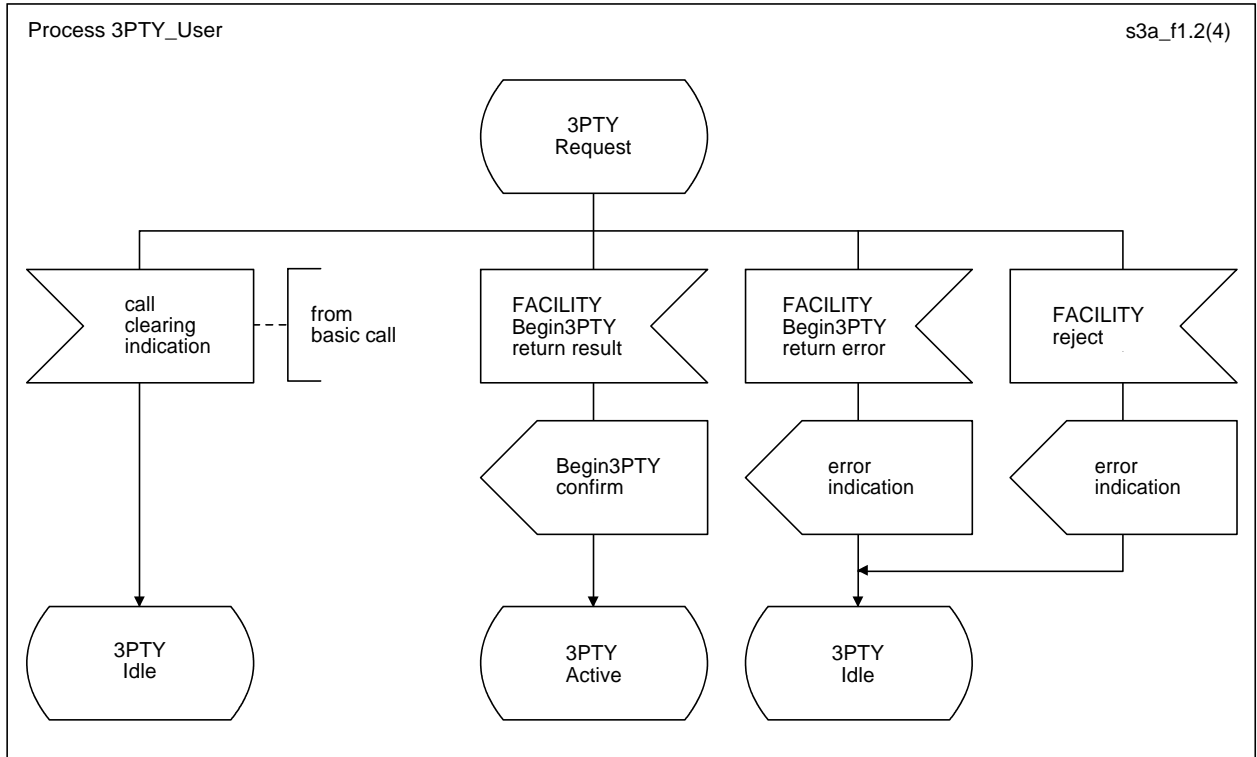

T1167820-94/d02

FIGURE 2-1/Q.954 (sheet 2 of 4)
SDL for user

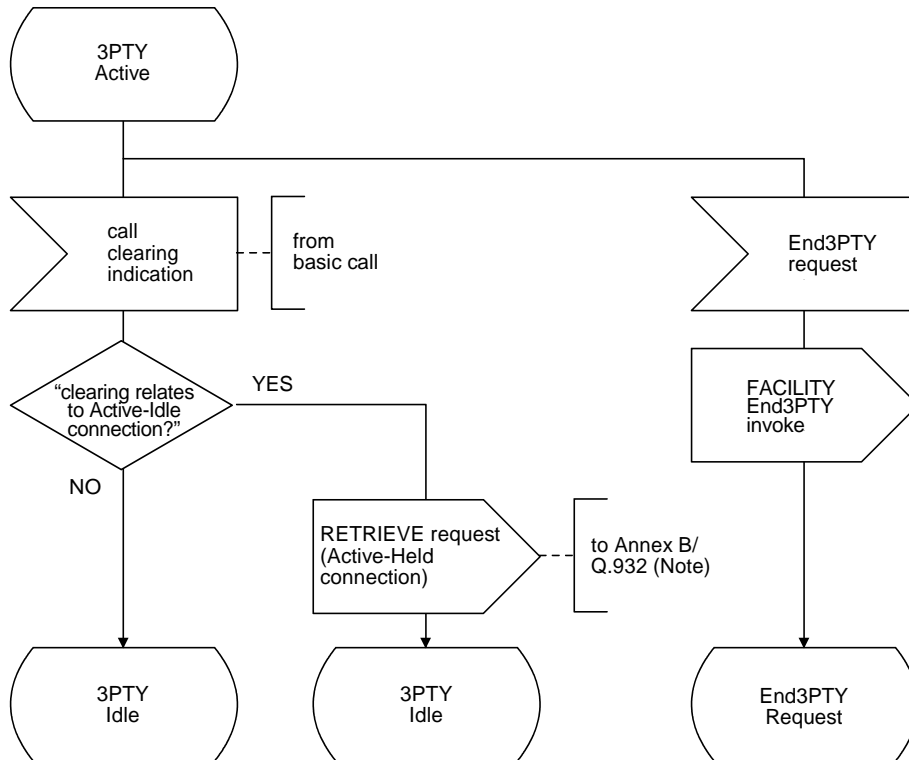

NOTE – Further actions on failure of this request are outside the scope of this Recommendation, but may include the resending of the RETRIEVE request.

FIGURE 2-1/Q.954 (sheet 3 of 4)

SDL for user

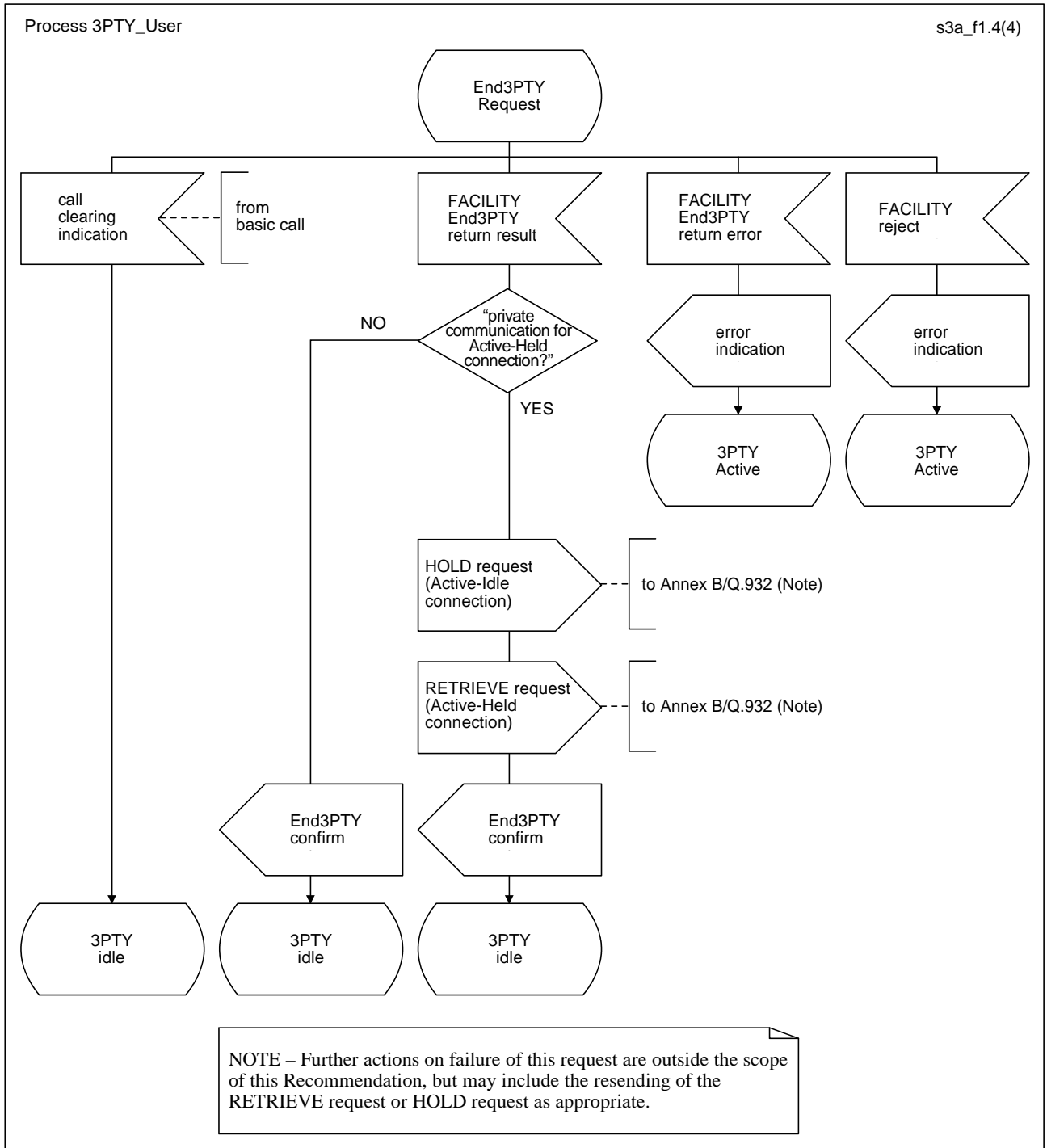

T1167840-94/d04

FIGURE 2-1/Q.954 (sheet 4 of 4)

SDL for user

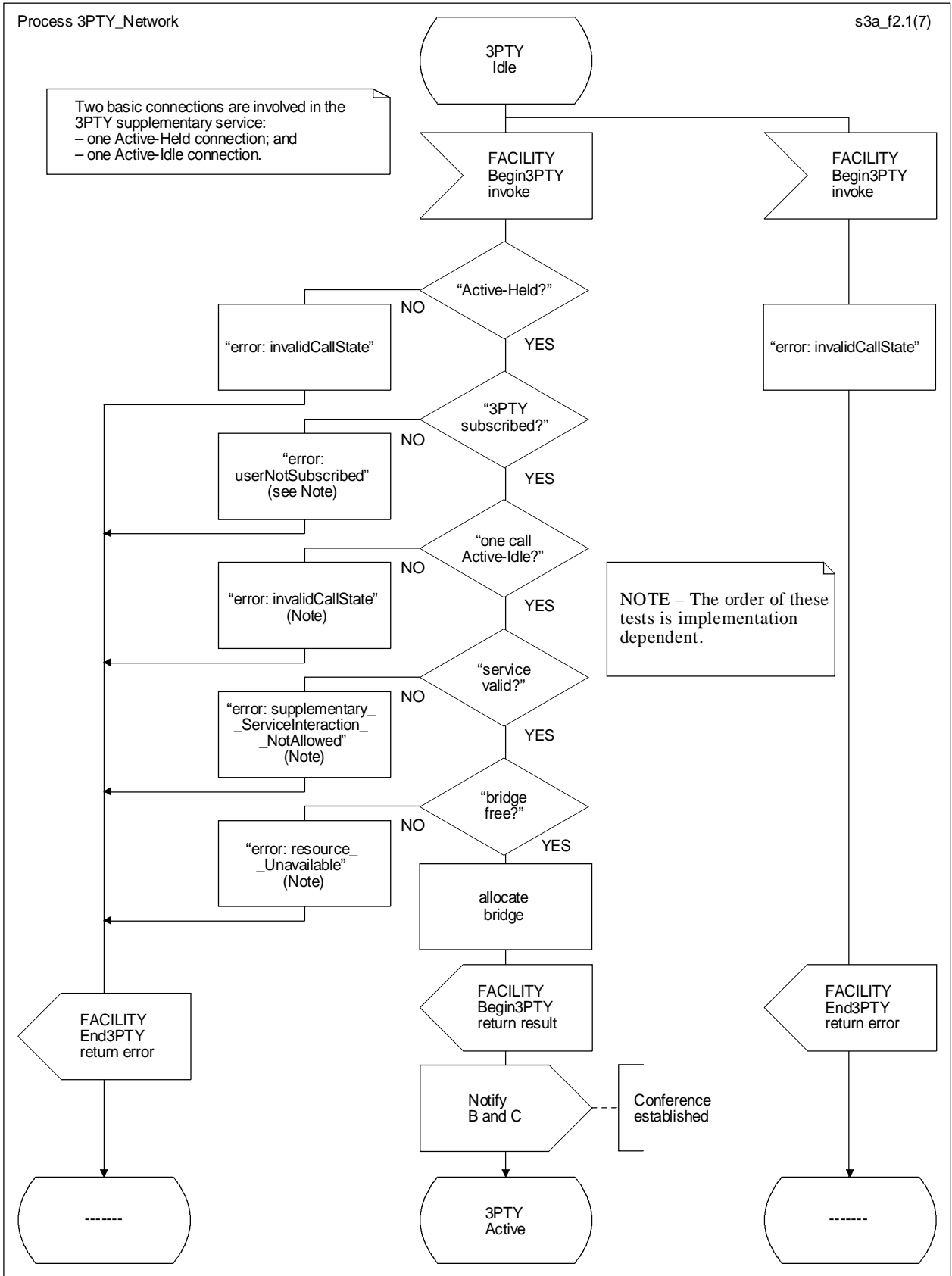

T1167850-94/d05

FIGURE 2-2/Q.954 (sheet 1 of 7)

SDL for network

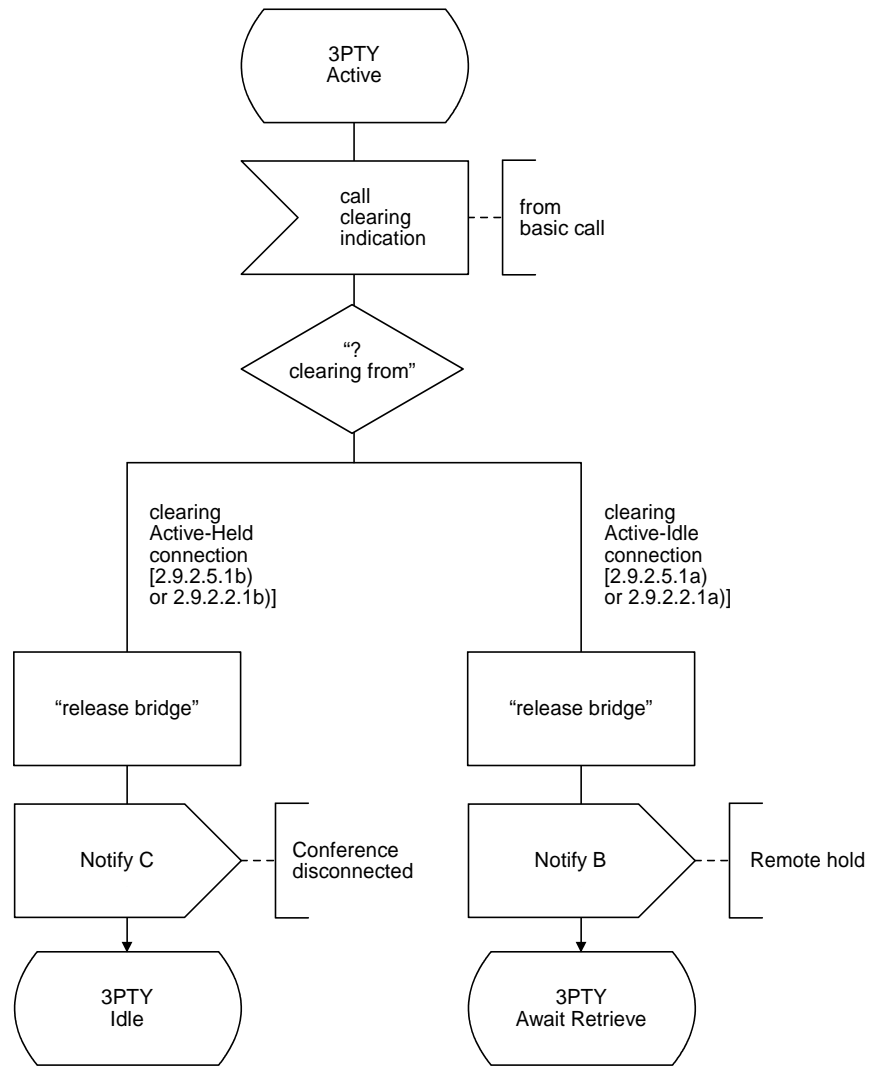

T1167860-94/d06

FIGURE 2-2/Q.954 (sheet 2 of 7)

SDL for network

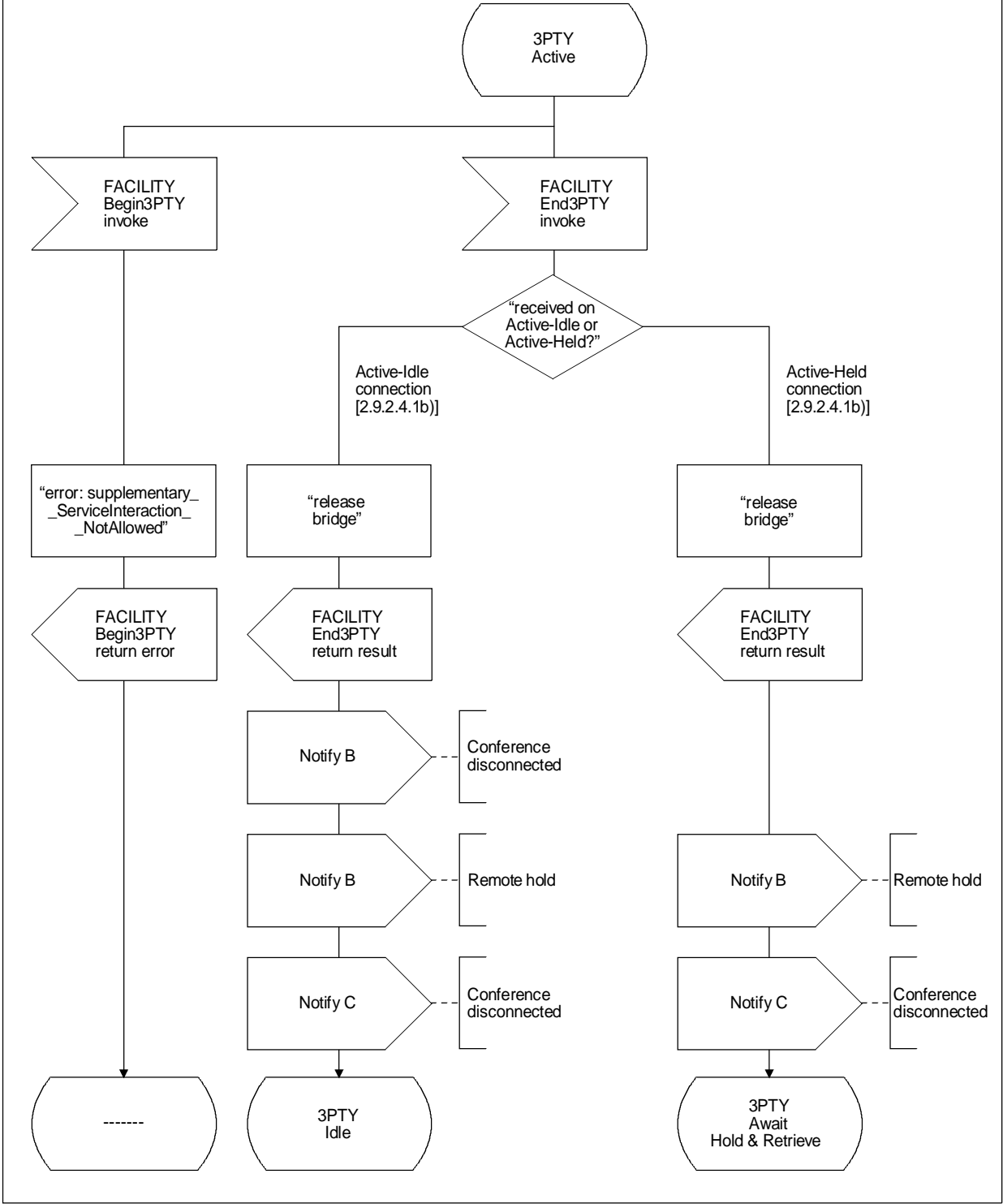

T1167870-94/d07

FIGURE 2-2/Q.954 (sheet 3 of 7)

SDL for network

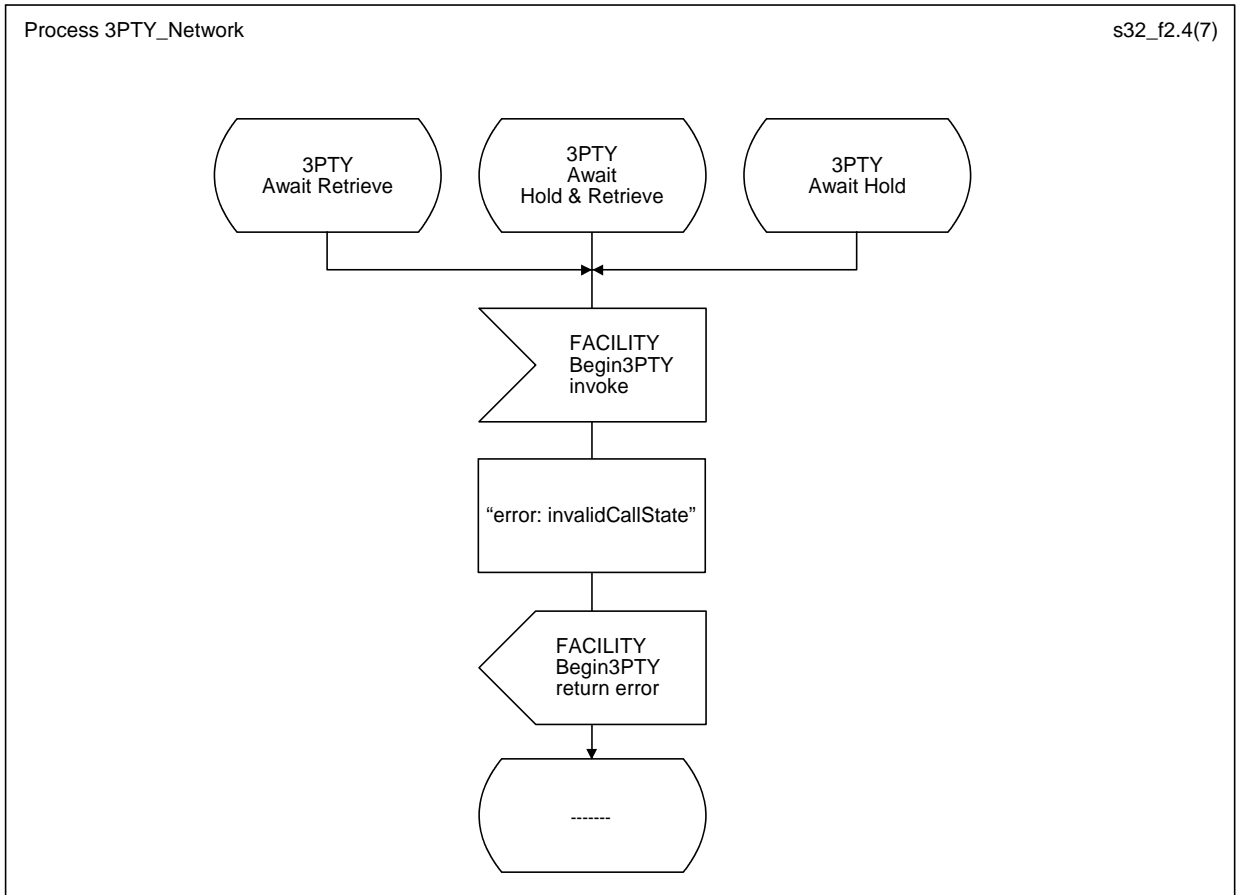

FIGURE 2-2/Q.954 (sheet 4 of 7)

SDL for network

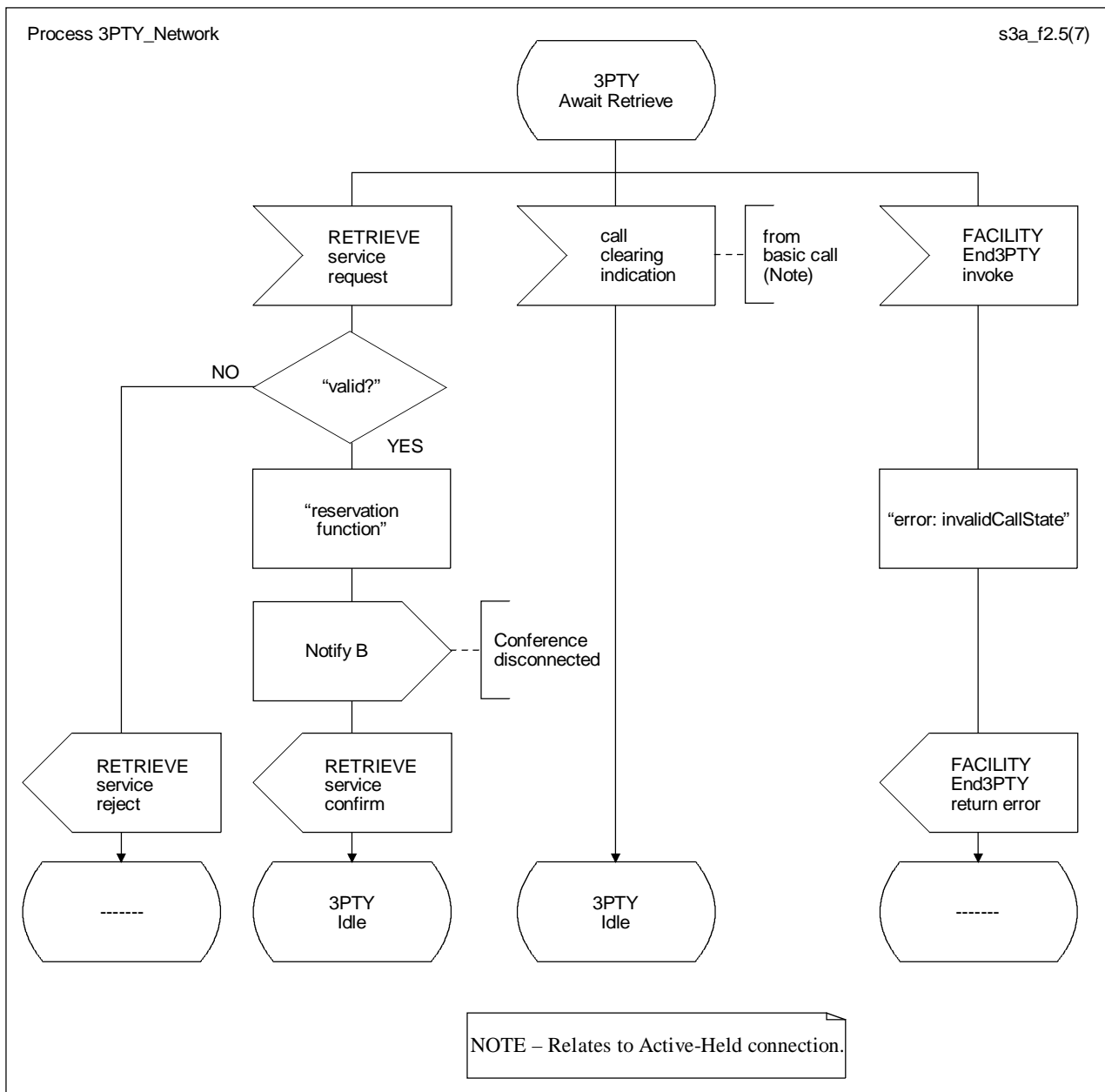

FIGURE 2-2/Q.954 (sheet 5 of 7)

SDL for network

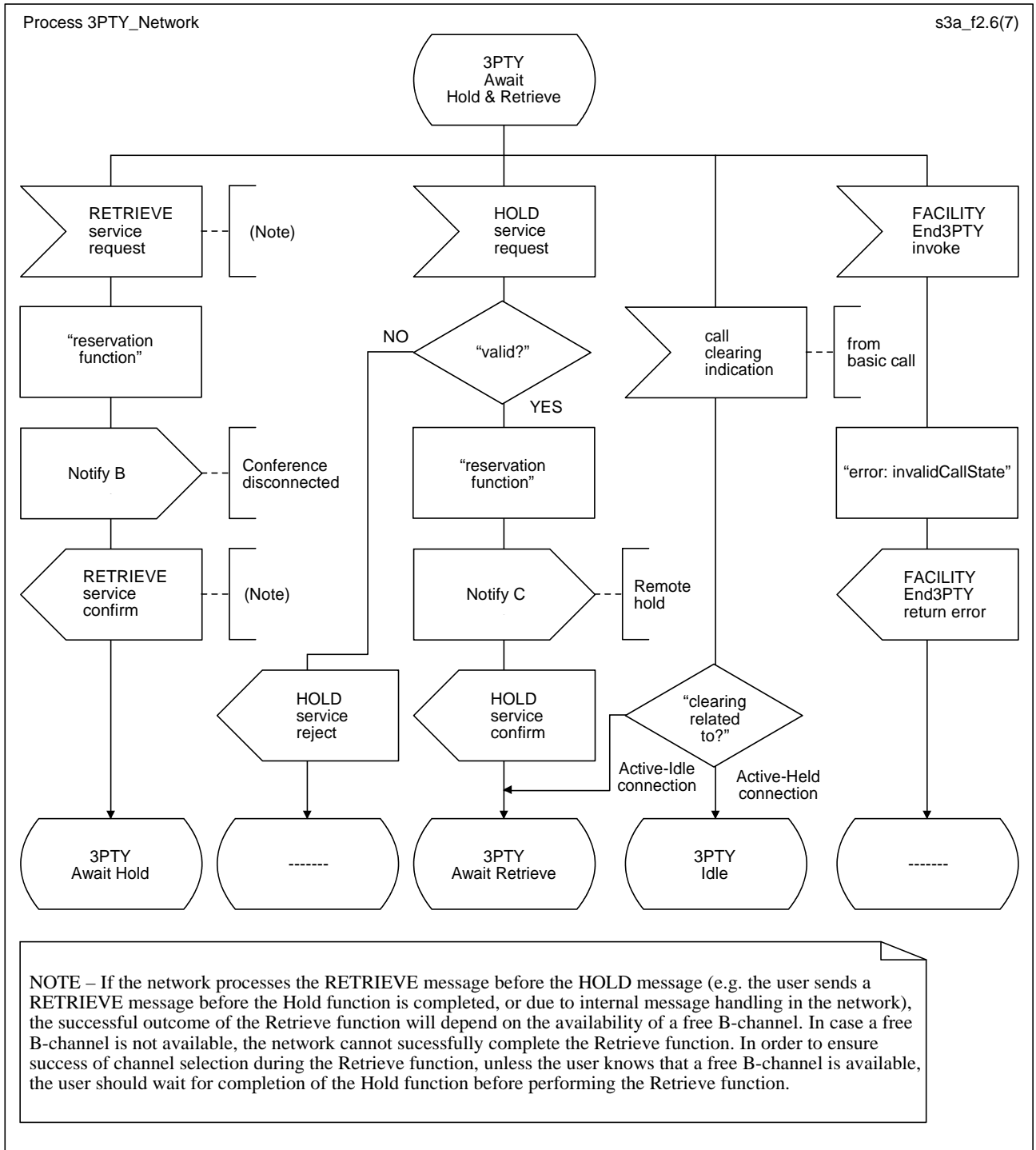
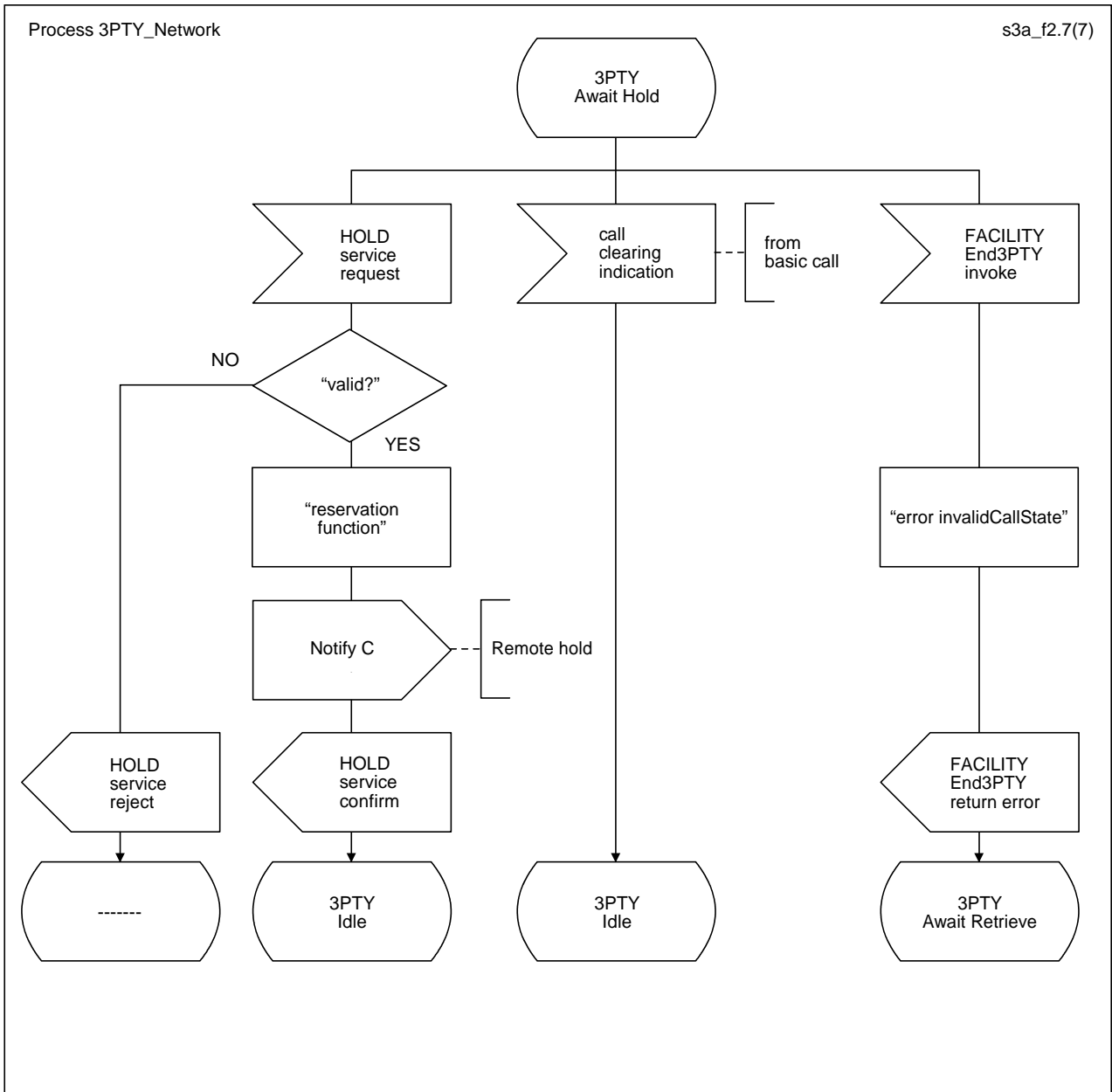

FIGURE 2-2/Q.954 (sheet 6 of 7)

SDL for network



T1167910-94/d11

FIGURE 2-2/Q.954 (sheet 7 of 7)
SDL for network

Appendix I

(to clause 2 of Recommendation Q.954)

Signalling flows

(This appendix does not form an integral part of this Recommendation)

The signalling flows for the 3PTY supplementary service are shown as follows:

- Figure 2-I.1: Request for a three-way conversation;
- Figure 2-I.2: Disconnection of user B;
- Figure 2-I.3: Disconnection of user C;
- Figure 2-I.4: Disconnection of both remote users, user B released first;
- Figure 2-I.5: Disconnection of both remote users, user C released first;
- Figure 2-I.6: Creating a private communication with user B;
- Figure 2-I.7: Creating a private communication with user C;
- Figure 2-I.8: User B disconnects;
- Figure 2-I.9: User C disconnects.

These figures do not reflect all the information elements described in the basic call control (see Recommendation Q.931 [3]). They are only examples describing the operation of the 3PTY supplementary service.

Table 2-I.1 contains the key to the figures in this subclause.

TABLE 2-I.1/Q.954

Key to figures

CRx, CRy	Call reference used
A-B	Call between user A and user B
A-C	Call between user A and user C
Conf. establ.	Conference established
Conf. disc.	Conference disconnected
FIE	Facility Information Element
Rem. retr.	Remote retrieval
Rem. hold	Remote hold
ret. res.	return result

I.1 Request for a three-way conversation

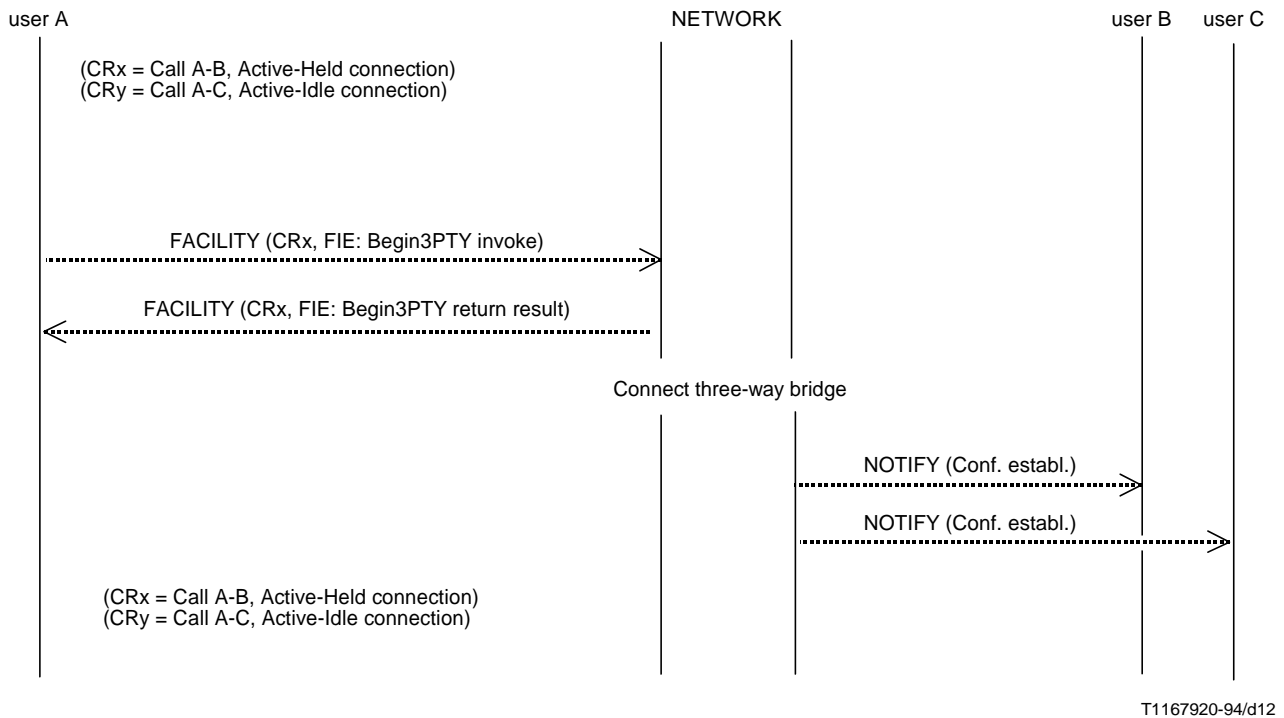

FIGURE 2-I.1/Q.954
Request for a three-way conversation

I.2 Disconnection of one remote user, and retention of the other

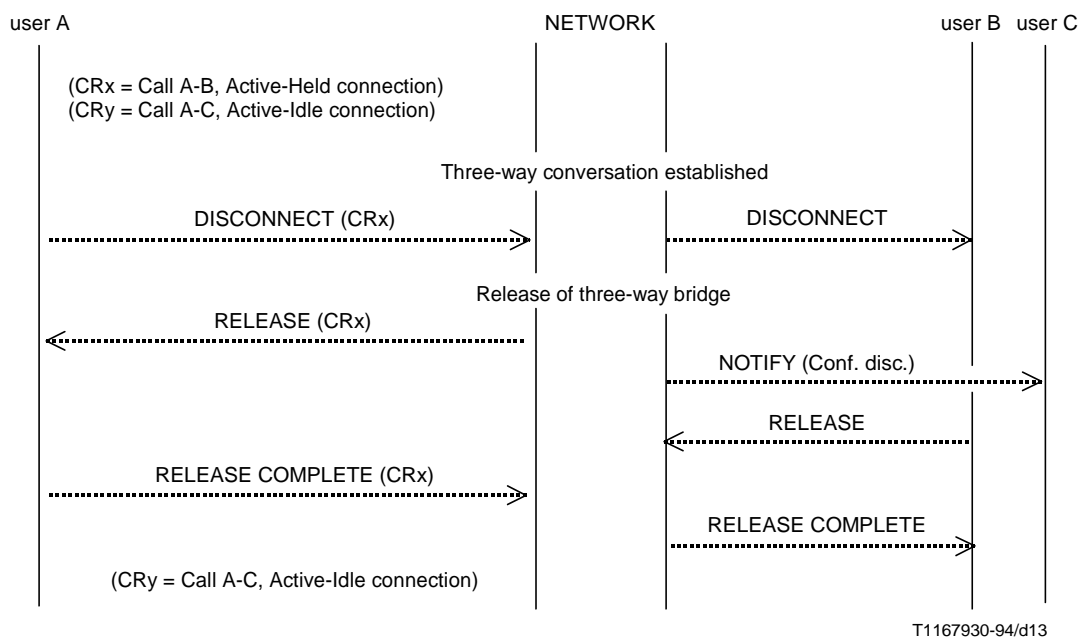
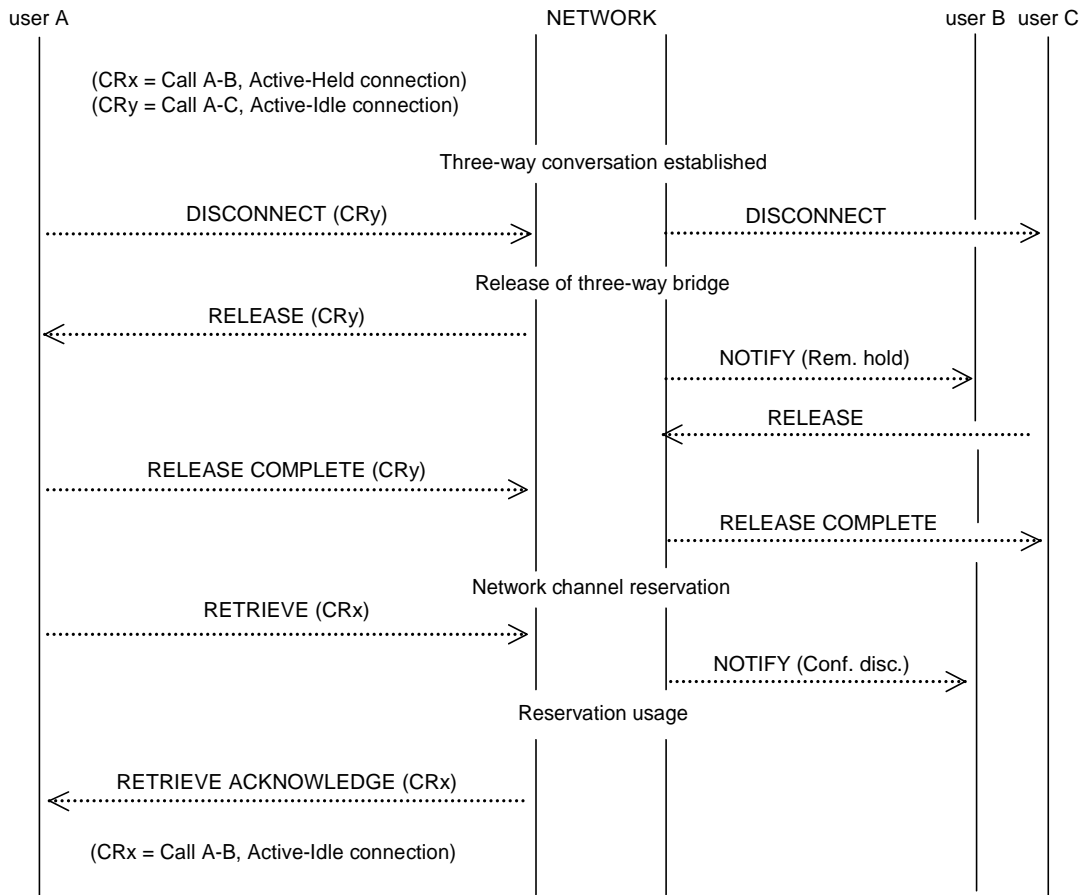

FIGURE 2-I.2/Q.954
Disconnection of user B



T1167940-94/d14

FIGURE 2-I.3/Q.954
Disconnection of user C

I.3 Disconnection of both remote users and terminating the call

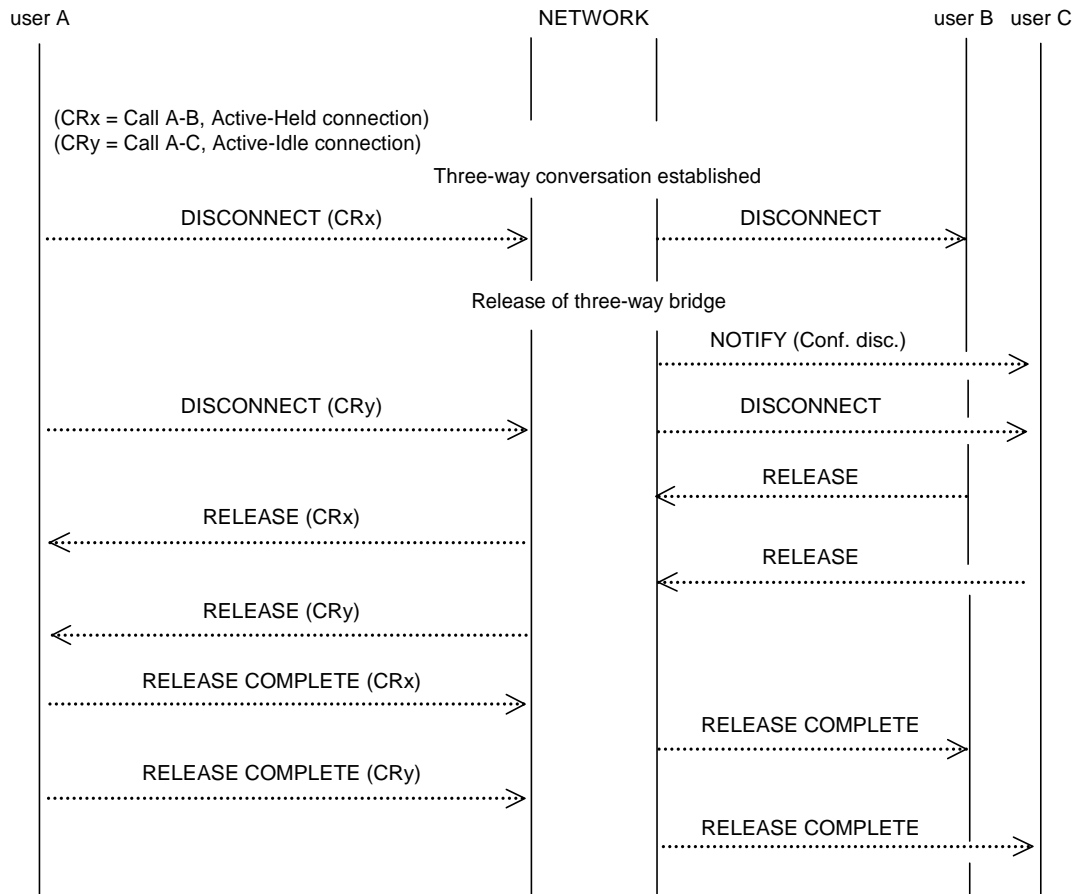

T1167950-94/d15

FIGURE 2-I.4/Q.954
Disconnect of both remote users-user B released first

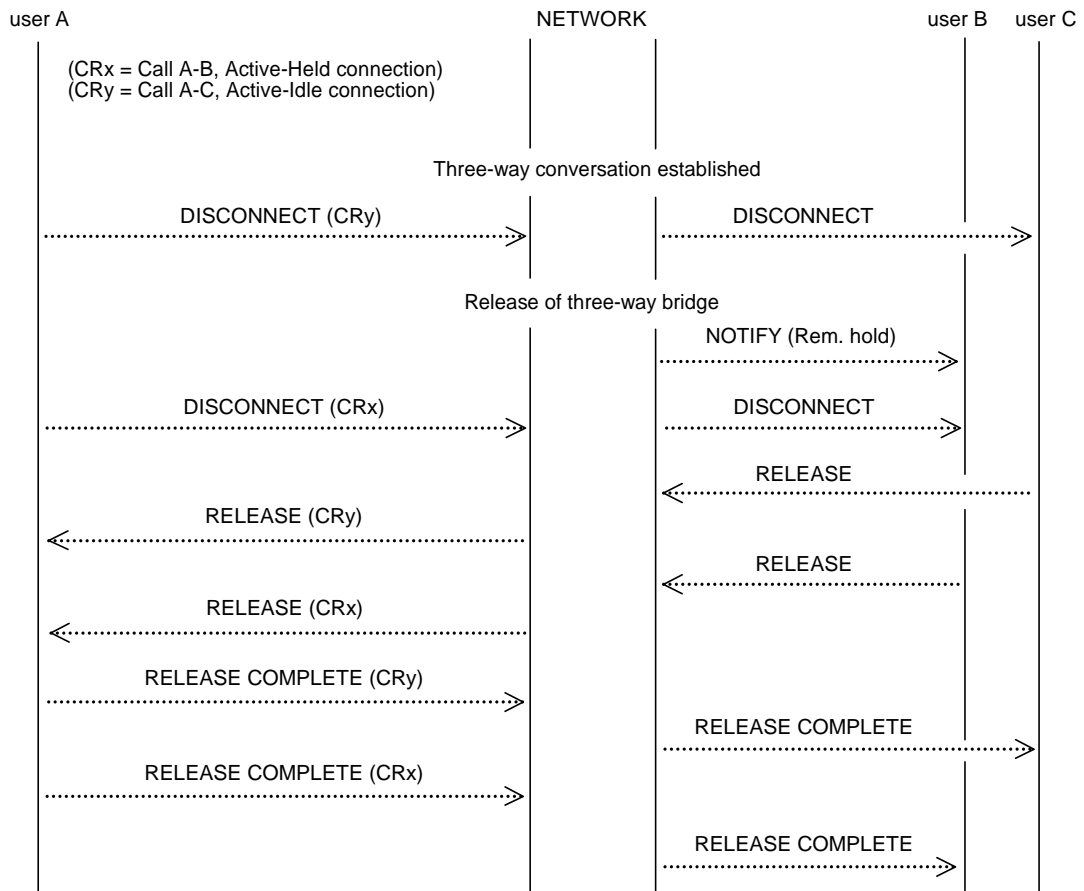

T1167960-94/d16

FIGURE 2-I.5/Q.954
Disconnection of both remote users-user C released first

I.4 Creation of a private communication with a remote user

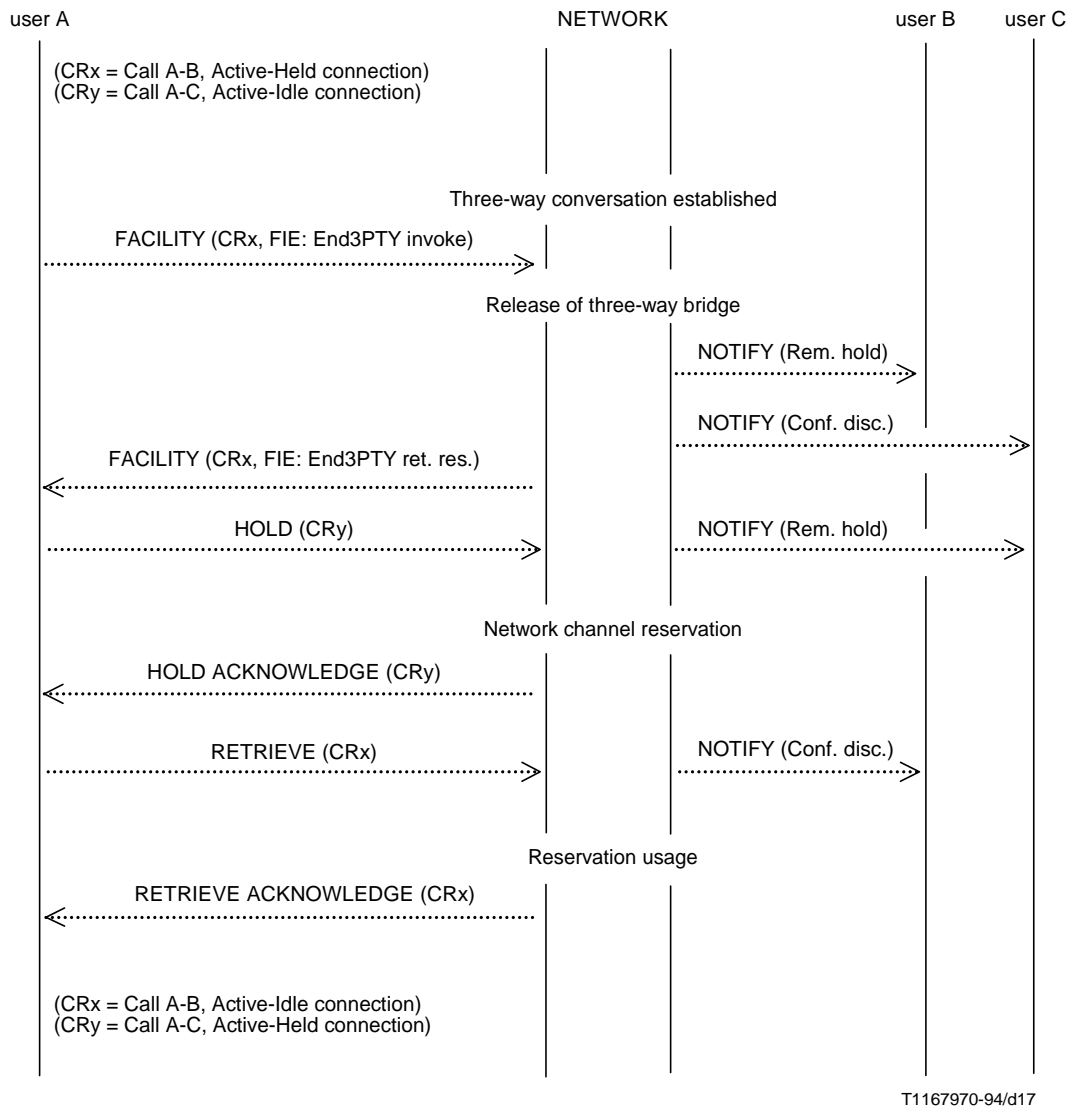

FIGURE 2-I.6/Q.954
Creating a private communication with user B

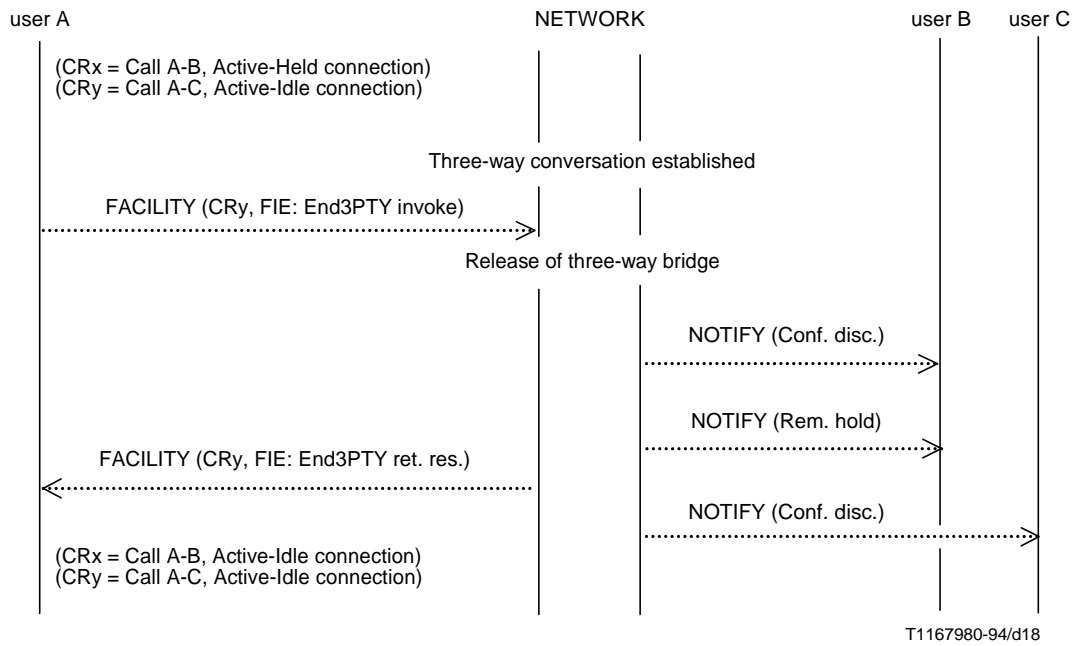

FIGURE 2-I.7/Q.954
Creating a private communication with user C

I.5 Remote user terminates the call

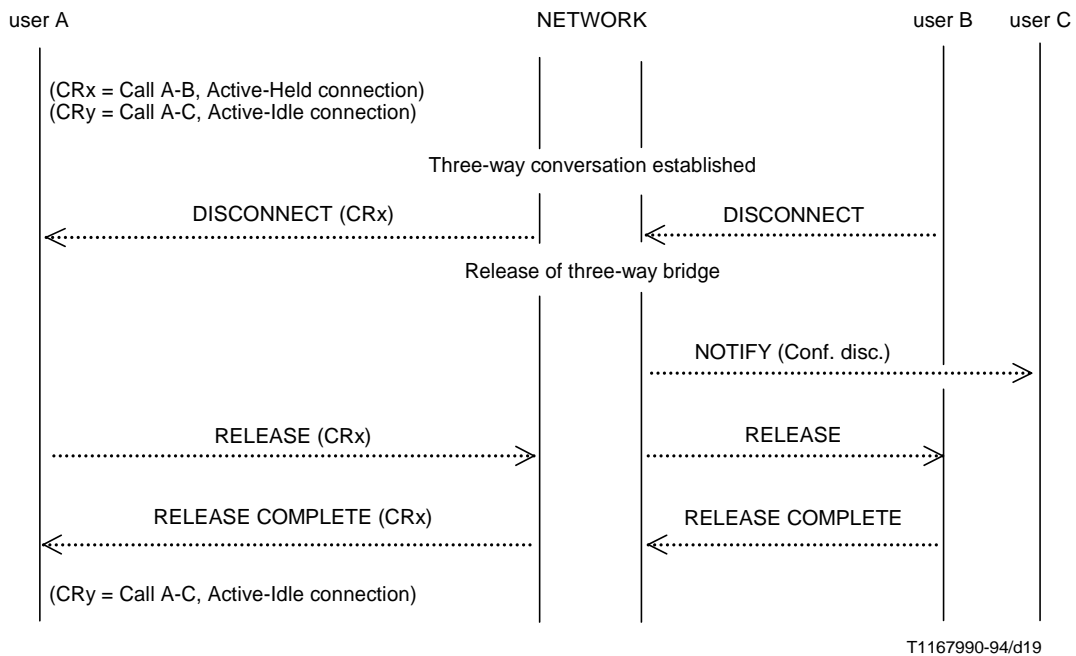
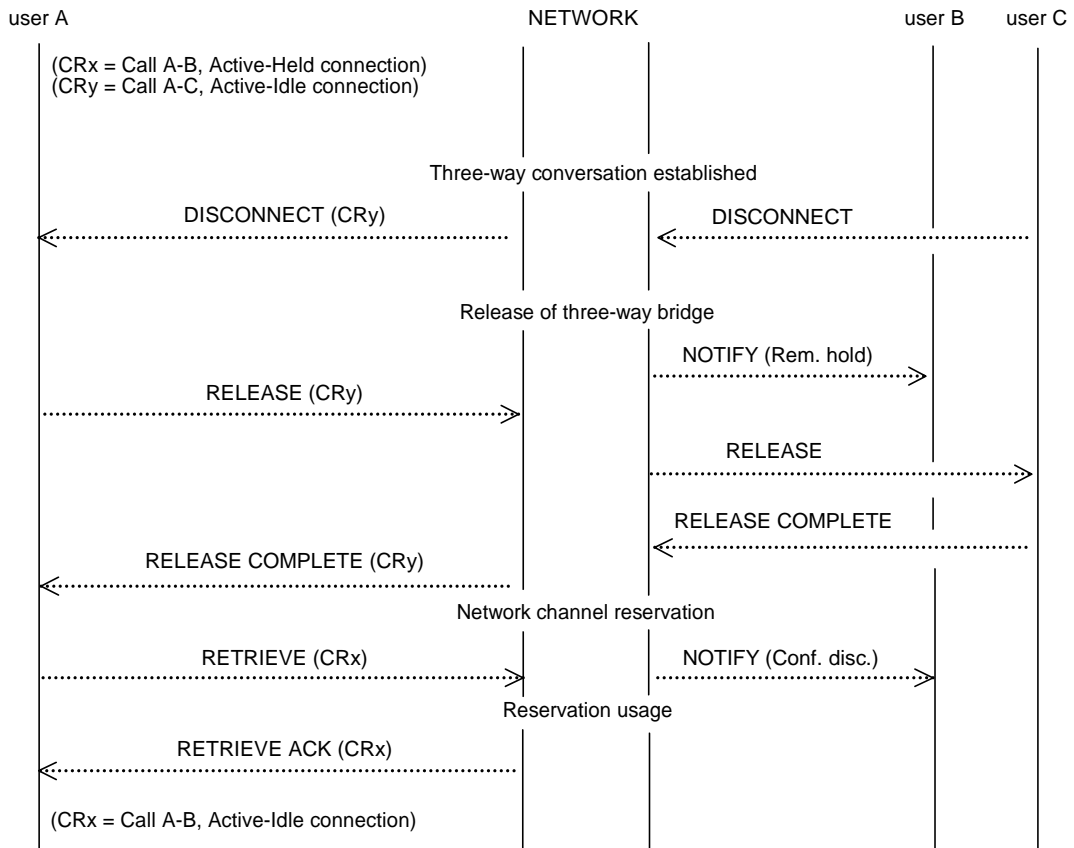

FIGURE 2-I.8/Q.954
User B disconnects



T1168000-94/d20

FIGURE 2-I.9/Q.954
User C disconnects