



INTERNATIONAL TELECOMMUNICATION UNION

ITU-T

TELECOMMUNICATION
STANDARDIZATION SECTOR
OF ITU

Q.834.3

(11/2001)

SERIES Q: SWITCHING AND SIGNALLING

Q3 interface

**A UML description for management interface
requirements for broadband Passive Optical
Networks**

ITU-T Recommendation Q.834.3

ITU-T Q-SERIES RECOMMENDATIONS
SWITCHING AND SIGNALLING

SIGNALLING IN THE INTERNATIONAL MANUAL SERVICE	Q.1–Q.3
INTERNATIONAL AUTOMATIC AND SEMI-AUTOMATIC WORKING	Q.4–Q.59
FUNCTIONS AND INFORMATION FLOWS FOR SERVICES IN THE ISDN	Q.60–Q.99
CLAUSES APPLICABLE TO ITU-T STANDARD SYSTEMS	Q.100–Q.119
SPECIFICATIONS OF SIGNALLING SYSTEM No. 4	Q.120–Q.139
SPECIFICATIONS OF SIGNALLING SYSTEM No. 5	Q.140–Q.199
SPECIFICATIONS OF SIGNALLING SYSTEM No. 6	Q.250–Q.309
SPECIFICATIONS OF SIGNALLING SYSTEM R1	Q.310–Q.399
SPECIFICATIONS OF SIGNALLING SYSTEM R2	Q.400–Q.499
DIGITAL EXCHANGES	Q.500–Q.599
INTERWORKING OF SIGNALLING SYSTEMS	Q.600–Q.699
SPECIFICATIONS OF SIGNALLING SYSTEM No. 7	Q.700–Q.799
Q3 INTERFACE	Q.800–Q.849
DIGITAL SUBSCRIBER SIGNALLING SYSTEM No. 1	Q.850–Q.999
PUBLIC LAND MOBILE NETWORK	Q.1000–Q.1099
INTERWORKING WITH SATELLITE MOBILE SYSTEMS	Q.1100–Q.1199
INTELLIGENT NETWORK	Q.1200–Q.1699
SIGNALLING REQUIREMENTS AND PROTOCOLS FOR IMT-2000	Q.1700–Q.1799
SPECIFICATIONS OF SIGNALLING RELATED TO BEARER INDEPENDENT CALL CONTROL (BICC)	Q.1900–Q.1999
BROADBAND ISDN	Q.2000–Q.2999

For further details, please refer to the list of ITU-T Recommendations.

ITU-T Recommendation Q.834.3

A UML description for management interface requirements for broadband Passive Optical Networks

Summary

This Recommendation provides a UML description for the management interface between a Supplier Management System and an Operator Management System. This work defines part of the management aspects for network resources defined by the G.983 family of Recommendations for Broadband Passive Optical Network (BPON) equipment.

Generally speaking, the Supplier Management System is an Element Management System (EMS) and the Operator Management System is a Network Management System (NMS). However, the Supplier Management System is required to present a "network view" of connection management to the Operator Management System. So it was deemed necessary for clarity's sake to use the terminology adopted in naming the systems involved.

In addition, it should be noted that ITU-T Rec. Q.834.1 contains a set of functionality requirements and a listing of managed entity definitions forming the basis for management information required for a "network element view" of BPON equipment. ITU-T Rec. Q.834.2 completes the management information definition for management of BPON equipment by providing the definitions of managed entities for the network view. The management information found in both of these Recommendations is referenced through this Recommendation. Only the aggregation of this management information is viewed to be sufficient to management BPON equipment.

Source

ITU-T Recommendation Q.834.3 was prepared by ITU-T Study Group 4 (2001-2004) and approved under the WTSA Resolution 1 procedure on 29 November 2001.

Keywords

APON, BPON, UML.

FOREWORD

The International Telecommunication Union (ITU) is the United Nations specialized agency in the field of telecommunications. The ITU Telecommunication Standardization Sector (ITU-T) is a permanent organ of ITU. ITU-T is responsible for studying technical, operating and tariff questions and issuing Recommendations on them with a view to standardizing telecommunications on a worldwide basis.

The World Telecommunication Standardization Assembly (WTSA), which meets every four years, establishes the topics for study by the ITU-T study groups which, in turn, produce Recommendations on these topics.

The approval of ITU-T Recommendations is covered by the procedure laid down in WTSA Resolution 1.

In some areas of information technology which fall within ITU-T's purview, the necessary standards are prepared on a collaborative basis with ISO and IEC.

NOTE

In this Recommendation, the expression "Administration" is used for conciseness to indicate both a telecommunication administration and a recognized operating agency.

INTELLECTUAL PROPERTY RIGHTS

ITU draws attention to the possibility that the practice or implementation of this Recommendation may involve the use of a claimed Intellectual Property Right. ITU takes no position concerning the evidence, validity or applicability of claimed Intellectual Property Rights, whether asserted by ITU members or others outside of the Recommendation development process.

As of the date of approval of this Recommendation, ITU had not received notice of intellectual property, protected by patents, which may be required to implement this Recommendation. However, implementors are cautioned that this may not represent the latest information and are therefore strongly urged to consult the TSB patent database.

© ITU 2002

All rights reserved. No part of this publication may be reproduced, by any means whatsoever, without the prior written permission of ITU.

CONTENTS

	Page
1 Scope	1
2 References	1
3 Definitions	2
3.1 Terms imported from ITU-T Rec. M.3010 [2].....	2
3.2 Terms imported from UML [10].....	2
3.3 New Terms	2
3.4 Abbreviations	3
4 Conventions.....	5
5 GDMI Template	6
5.1 Scope	6
5.2 Requirements.....	6
5.2.1 Business Level Requirements	6
5.2.2 Specification Level Requirements	14
5.3 Analysis.....	44
5.3.1 Access Control	44
5.3.2 Event Handling.....	49
5.3.3 Software and Configuration Data.....	67
5.3.4 Testing.....	90
5.3.5 Installation.....	96
5.3.6 Provisioning	112
5.3.7 Archiving and Bulk Transfer.....	142
5.3.8 Management Information.....	160

Introduction

This Recommendation provides a UML description of a management interface between a Supplier Management System, provided to manage network resources conforming to specifications found in the G.983 family of Recommendations, and a network owner Operation Management System. It follows the process proposed in ITU-T Rec. M.3020 with alternations in order of presentation of material.

ITU-T Recommendation Q.834.3

A UML description for management interface requirements for broadband Passive Optical Networks

1 Scope

This Recommendation addresses management interface behaviour required for mechanisation for the Supplier Management System managing BPON network resources. Behaviour for real time and non-real time interfacing is addressed. All aspects of TMN management functional areas are addressed, except for accounting management, since usage data collection is outside the scope of the BPON equipment reference architecture.

2 References

The following ITU-T Recommendations and other references contain provisions which, through reference in this text, constitute provisions of this Recommendation. At the time of publication, the editions indicated were valid. All Recommendations and other references are subject to revision; users of this Recommendation are therefore encouraged to investigate the possibility of applying the most recent edition of the Recommendations and other references listed below. A list of the currently valid ITU-T Recommendations is regularly published.

- [1] ITU-T Recommendation G.983.1 (1998), *Broadband optical access systems based on Passive Optical Networks (PON)*.
- [2] ITU-T Recommendation M.3010 (2000), *Principles for a telecommunications management network*.
- [3] ITU-T Recommendation M.3200 (1997), *TMN management services and telecommunications managed areas: overview*.
- [4] ITU-T Recommendation M.3400 (2000), *TMN management functions*.
- [5] ITU-T Recommendation X.734 (1992), *Information technology – Open Systems Interconnection – Systems management: Event report management function*.
- [6] ITU-T Recommendation X.735 (1992), *Information technology – Open Systems Interconnection – Systems management: Log control function*.
- [7] ITU-T Recommendation X.744 (1996), *Information technology – Open Systems Interconnection – Systems management: Software management function*.
- [8] ITU-T Recommendation X.745 (1993), *Information technology – Open Systems Interconnection – Systems management: Test management function*.
- [9] ITU-T Recommendation X.746 (2000), *Information technology – Open systems interconnection – System management: Scheduling function*.
- [10] OMG Document formal/99-06-01, *Unified Modelling Language*, Section 1 of OMG Modelling.
- [11] ITU-T Recommendation Q.834.1 (2001), *ATM-PON requirements and managed entities for the network element view*.
- [12] ITU-T Recommendation Q.834.2 (2001), *ATM-PON requirements and managed entities for the network view*.
- [13] ITU-T Recommendation X.741 (1995), *Information technology – Open Systems Interconnection – Systems management: Objects and attributes for access control*.

- [14] ITU-T Recommendation X.780 (2001), *TMN guidelines for defining CORBA managed objects*.
- [15] ITU-T Recommendation X.720 (1992), *Information technology – Open Systems Interconnection – Structure of management information: Management information model*.
- [16] ITU-T Recommendation X.722 (1992), *Information technology – Open Systems Interconnection – Structure of management information: Guidelines for the definition of managed objects*.
- [17] ITU-T Recommendation M.2140 (2000), *Transport network event correlation*.

3 Definitions

This Recommendation defines the following terms:

3.1 Terms imported from ITU-T Rec. M.3010 [2]

- User
- TMN management service
- TMN management function set

3.2 Terms imported from UML [10]

- Activity Diagram
- Actor
- Class
- Class Diagram
- Collaboration Diagram
- Sequence Diagram
- State Diagram
- Stereotype
- Use Case

3.3 New Terms

3.3.1 activate: Execute installed software. Normally implies the switch of installed software from being secondary to primary.

3.3.2 assign: The outcome of service provisioning.

3.3.3 autodiscovery: The autonomous messaging to an OMS of creation or deletion notifications for equipment inventory data.

3.3.4 BPON resource: BPON network resources that need to be managed. These resources can be physical and logical.

3.3.5 build: The construction of a fragment of a management model based on containment rules and defined relationships, i.e. the provisioning of the parameters of a BPON managed resource, resulting from a discovery or autodiscovery process of installed equipment or through a pre-provisioning process prior to physical installation.

3.3.6 data warehouse: Long term archival system, normally implemented as a database management system.

3.3.7 dispatch: To send off craft personnel to a particular location where telecommunications equipment or facilities are or will be installed.

- 3.3.8 factory:** Functionality that manufactures and deletes managed entities.
- 3.3.9 filtering:** Criteria used for selection purposes.
- 3.3.10 includes:** An include relationship from Use Case A to Use Case B indicates that an instance of the Use Case A will also contain the behaviour as specified by B (See [10]).
- 3.3.11 install:** Physical placement of equipment. This means that shelves have been installed and powered. All common equipment is inserted. Management communication has been established. Interface cards may be inserted.
- 3.3.12 management model:** Formal description of managed entities and relationships between them.
- 3.3.13 ranging:** Ranging is a function used to measure the round trip delay between the OLT and each ONU or ONT in order to determine the transmission timing for the subtending ONT or ONU. The process also involves establishing of security mechanisms (churning key algorithm) and the embedded operations channel. Ranging may be initiated manually by supplying the OLT with the serial number of the ONT or ONU. If supported by the implementation, ranging can also be initiated automatically by the OLT.
- 3.3.14 register:** The process used to bring a network resource into the management jurisdiction of the Supplier Management System. The management communication link is established to a physically installed NE, and the NE is included in the management domain for the Supplier Management System.
- 3.3.15 reserve:** The setting aside of network resources before provisioning of service.
- 3.3.16 service instance:** A service instance is defined as a connection between a UNI endpoint on an ONT or NT and an NNI endpoint at an OLT or between UNI endpoints on two ONTs or NTs.
- 3.3.17 transfer function:** This function implies the use of a non real time protocol.
- 3.3.18 user label:** Indicates an identifier that is created and provided by the Operator or Operator Management System to associate with a managed resource by the Supplier Management System.

3.4 Abbreviations

This Recommendation uses the following abbreviations:

AAL	ATM Adaptation Layer
APON	ATM-PON
ATM	Asynchronous Transfer Mode
BICI	Broadband Inter-Carrier Interface
BISSI	Broadband Inter-Switching System Interface
BPON	Broadband Passive Optical Network
CAC	Call Admission Control
CCITT	Consultative Committee on International Telephone & Telegraph
CES	Circuit Emulation Service
CORBA	Common Object Request Broker Architecture
CTP	Connection Termination Point
DCN	Data Communications Network
DSx	Digital Signal x
EM	Element Management
EML	Element Management Layer

EM-OSF	Element Management Layer Operations System Function
EMS	Element Management System
EOC	Embedded Operations Channel
Ex	European digital signal x
FSAN	Full Service Access Network
GDMI	Guidelines for the Definition of Management Interface
GUI	Graphical User Interface
IP	Internet Protocol
ITU	International Telecommunication Union
ME	Managed Entity
MIB	Management Information Base
NE	Network Element
NEL	Network Element Layer
NM	Network Management
NML	Network Management Layer
NM-OSF	Network Management Layer Operations System Function
NMS	Network Management System
NT	Network Termination
OAM&P	Operations, Administration, Maintenance and Provisioning
ODN	Optical Distribution Network
OLT	Optical Line Terminal
OMG	Object Management Group
OMS	Operator Management System
ONT	Optical Network Terminal
ONU	Optical Network Unit
OS	Operations System
OSF	Operations System Function
PON	Passive Optical Network
PVC	Permanent Virtual Circuit
QoS	Quality of Service
RCAA	Root Cause Alarm Analysis
RCIA	Root Cause Impairment Analysis
SDH	Synchronous Digital Hierarchy
SM	Service Management
SML	Service Management Layer
SM-OSF	Service Management Layer Operations System Function
SMS	Service Management System
SNI	Service Node Interface
TCA	Threshold Crossing Alert
TMN	Telecommunication Management Network
TP	Termination Point

TTP	Trail Termination Point
UML	Unified Modelling Language
UNI	User Network Interface
VC	Virtual Channel
VCC	Virtual Channel Connection
VCI	Virtual Channel Identifier
VCL	Virtual Channel Link
VDSL	Very high speed Digital Subscriber Line
VP	Virtual Path
VPC	Virtual Path Connection
VPI	Virtual Path Identifier
VPL	Virtual Path Link

4 Conventions

Any "communicates" association between an actor and Use Case in the Requirements clause (see 5.2), refers to the Q interface addressed in this Recommendation when the actor is any one of the following: OMS, Privileged User, External Event Channel, Profile Object Repository, Data Warehouse, or Secure File Server. The following figure illustrates this diagrammatic reference.

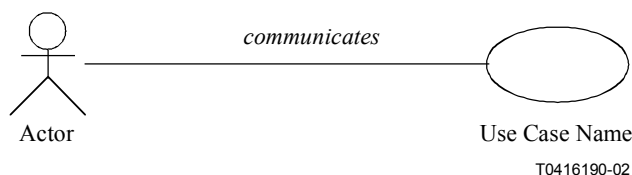

Figure 4-1/Q.834.3 – Q Interface Reference in Use Case diagram

Any association between an actor and an object class in the Analysis clause (see 5.3) may refer to the Q interface addressed in this Recommendation when the actor is any one of the following: OMS, Privileged User, External Event Channel, Profile Object Repository, Data Warehouse, or Secure File Server. The following figure illustrates this diagrammatic reference.



Figure 4-2/Q.834.3 – Q Interface Reference in class diagram

All other associations, as well as other object classes not possessing such an association to these actors in the Analysis clause are provided in this clause in order to complete the description of expected behaviour of the Supplier Management System and the BPON NEs within its management jurisdiction when fulfilling the TMN management needs of the Operator and Operator Management Systems. In general, it is not required that the Supplier Management System explicitly implement these associations, or object classes, provided that the implementation possesses the same behaviour. However, when an object class appears in the Analysis clause, and this class is one of the managed entities of ITU-T Recs. Q.834.1 or Q.834.2, the class shall be implemented within the

Supplier Management System as part of its logical schema. In general, the managed entities of ITU-T Recs. Q.834.1 and Q.834.2 provide management information that is used on the mechanised interface.

5 GDMI Template

5.1 Scope

The scope of this Recommendation includes management aspects for a BPON system as described by the G.983 family of Recommendations. The BPON system can be classified as an Access and Terminal Equipment Network [1]. The management services covered by this Recommendation include aspects of network and service provisioning management, network performance management, traffic management, maintenance management, and security administration. Figure 5-1 below shows the Q interface addressed in this Recommendation.

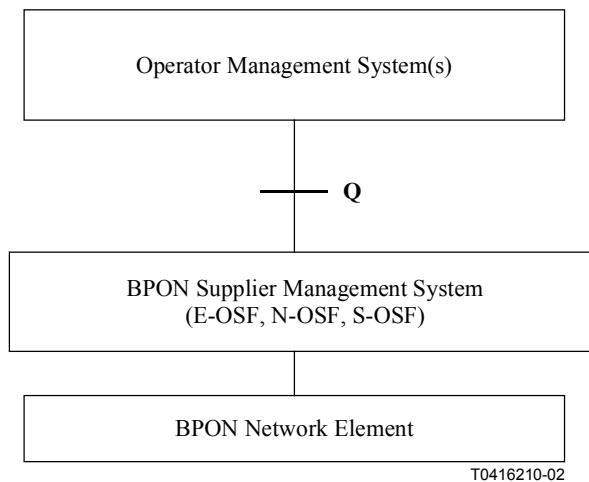

Figure 5-1/Q.834.3 – Reference Interface

5.2 Requirements

5.2.1 Business Level Requirements

Major business requirements concerning the functionality of the Supplier Management System are documented in [11]. Services performed by the Supplier Management System on behalf of the Operator Management System(s) and operator users are controlled by the interfaces supported by the Supplier Management and described by the requirements provided in [11].

5.2.1.1 Actor Roles

There are several actors mentioned in the high-level Use Case diagrams provided in 5.2.1.3. These actors include the following: Operator, Privileged Operator, Operator Management System (OMS), External Event Channel, White Pages, Data Warehouse, BPON NE, Profile Object Repository, and Secure Configuration Server. Figure 5-2 provides a brief definition of the roles that these actors play.

Actor	Roles
Operator	User interacting with the Supplier Management System via a Graphical User Interface.
Privileged User	User with administrative access to the Supplier Management System. Can be a system or operator.
OMS (Operator Management System)	Separate management systems supporting operator TMN management requirements.
External Event Channel	Consumer of BPON events supplied by the Supplier Management System. This channel acts as a conduit of event information to interested client applications.
White Pages	Directory service for resolving names of objects referenced by interface method invocations.
Data Warehouse	Long term archive of records maintained by the operator.
BPON NE	Equipment that is a Network Element.
Secure File Server	Secure and centralised repository of network element configuration data and software generics.
Profile Object Repository	External OMS system where profile objects reside.

Figure 5-2/Q.834.3 – Actors and Roles

5.2.1.2 Telecommunications resources

Figure 5-3 illustrates the BPON System Architecture. The operation system linked to the OLT in this figure is the Supplier Management System. This system is provided, along with the equipment, to a network owner operator. The FSAN consortium has decided to avoid specifying the management communications interface between the OLT and the Supplier Management System. Consequently, both the Supplier Management System and the managed BPON equipment are viewed as relevant telecommunications resources in this Recommendation.

The OLT (or Optical Line Terminal) is a head-end digital terminal commonly located in the central office or some controlled environment structure. The ODN (Optical Distribution Network) is a point-to-multipoint fibre infrastructure employing a passive splitter or coupler device for the fan out. The ONU provides the access network line termination function and the ATM multiplexing and de-multiplexing function. The NT provides the user network interface line termination function. The reference point, indicated by the term UNI, denotes the user network interface. It is used in the most abstract sense and is meant to indicate any type of service interface. The ONT combines the functions of the ONU and NT in one piece of equipment. In some cases, the UNIs from one ONT may belong to different users.

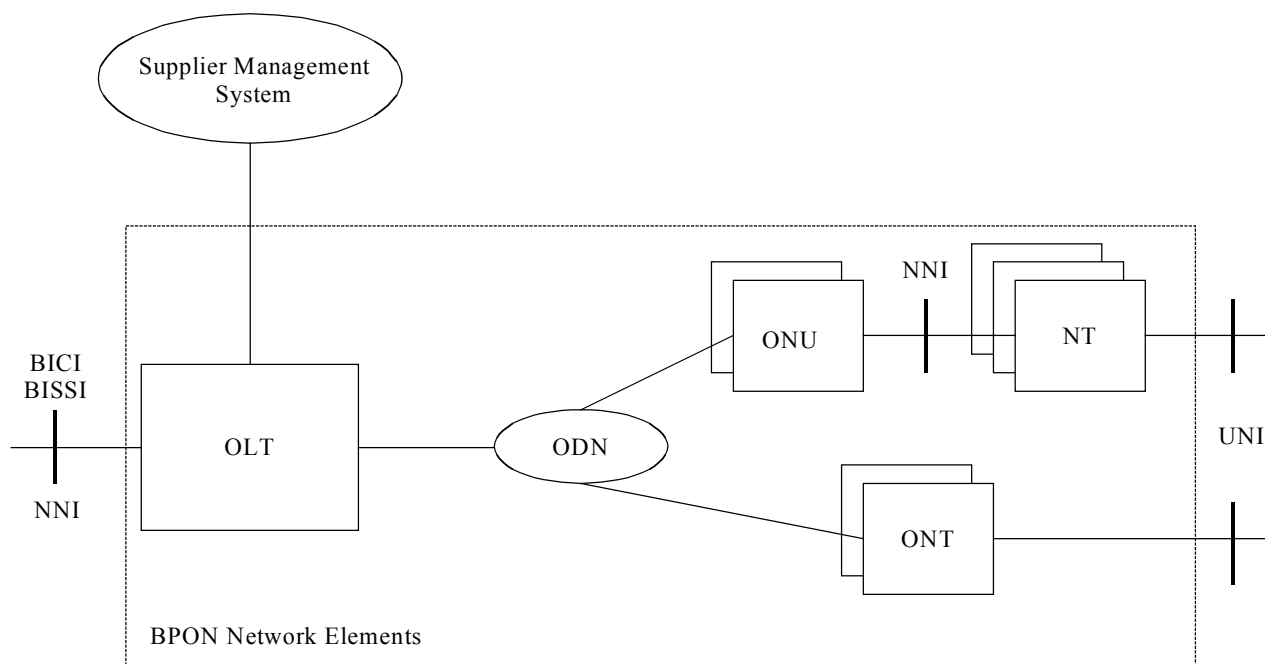

- | | |
|-------|--|
| BICI | Broadband Inter-Carrier Interface |
| BISSI | Broadband Inter-Switching System Interface |
| BPON | Broadband Passive Optical Network |
| NNI | Network-to-Network Interface |
| NT | Network Termination |
| OLT | Optical Line Terminal |
| ODN | Optical Distribution Network |
| ONT | Optical Network Terminal |
| ONU | Optical Network Unit |
| UNI | User Network Interface |

Figure 5-3/Q.834.3 – BPON System Architecture

5.2.1.3 High-Level Use Case diagrams

This clause contains high-level Use Case diagrams that summarise the functionality and interfaces of the Supplier Management System. Use Cases are shown in these diagrams even when they do not have a "communicates" association to an external actor. The internal functionality described by these Use Cases serves an important purpose in that the behaviour of the Supplier Management System would be incompletely characterised without it. In some cases there are specific Use Cases mentioned on more than one high-level diagram. Again, the reason for this duplication is to aid in completing the characterisation of behaviour and functionality. Use Case descriptions are provided for every Use Case pictured in these high-level diagrams.

The first overview Use Case diagram shows the interactions involved administering user access to the Supplier Management System.

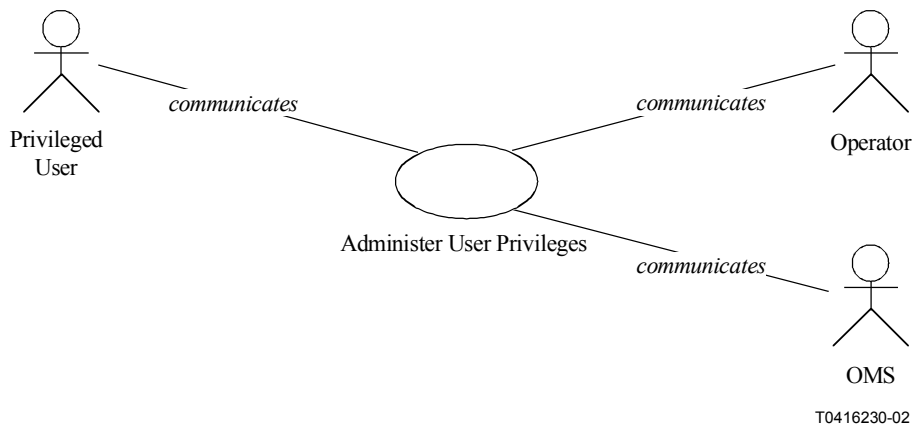

T0416230-02

Figure 5-4/Q.834.3 – Access Control

The second overview Use Case diagram shows the external interactions involved in event handling activities of the Supplier Management System. It includes both real time and non-real time activities.

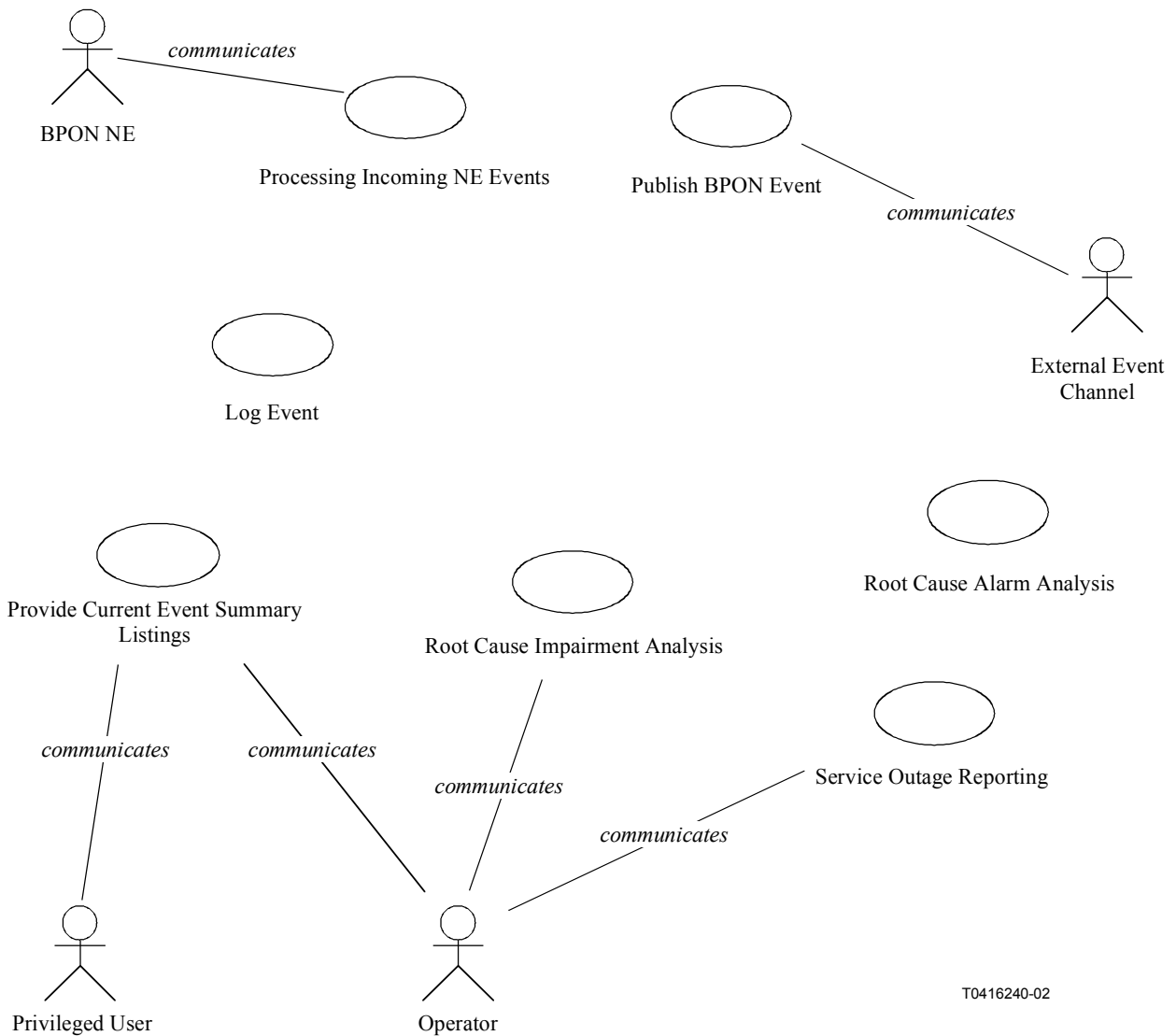

T0416240-02

Figure 5-5/Q.834.3 – Event Handling

The third overview Use Case diagram covers the external interactions involving software and configuration data management by the Supplier Management System.

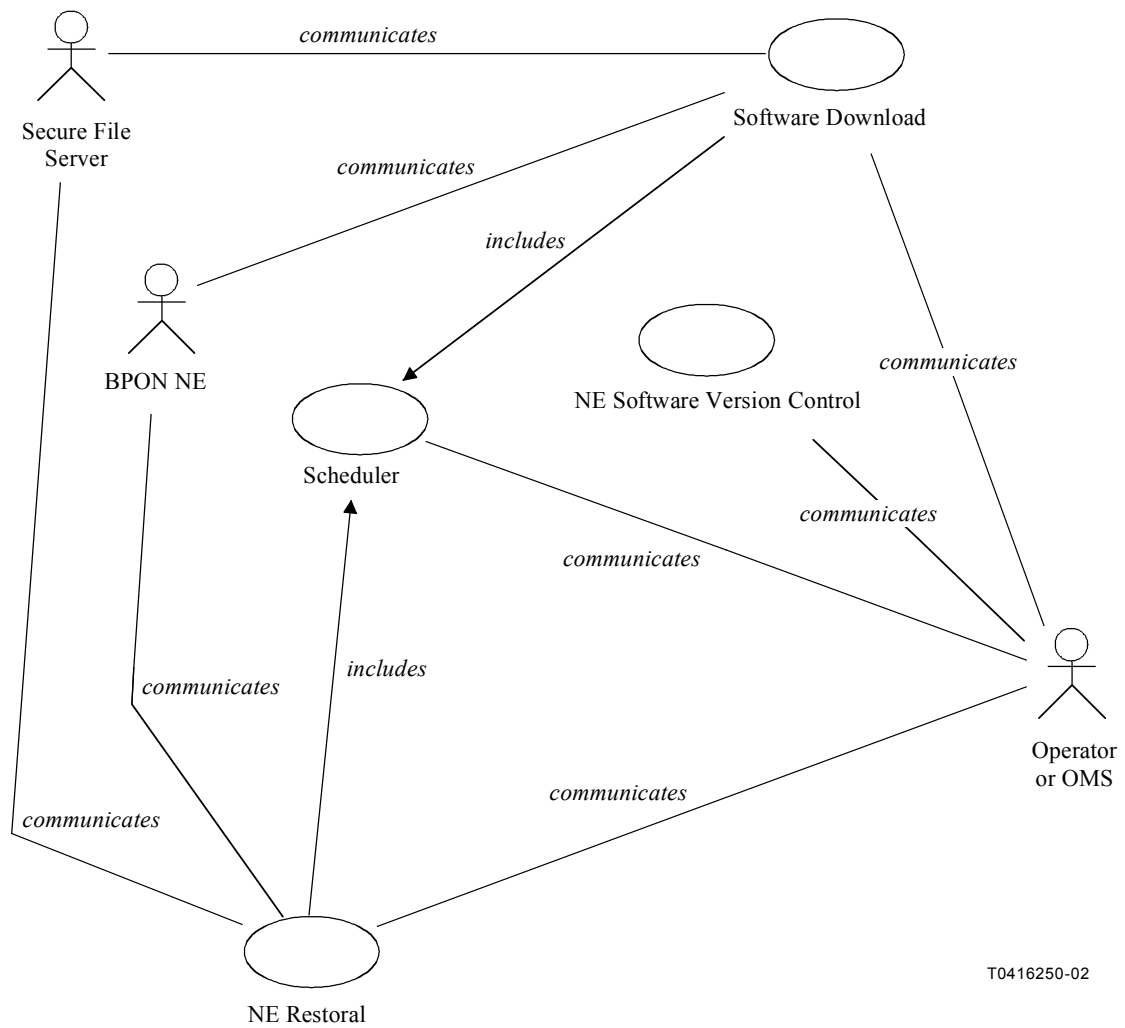

T0416250-02

Figure 5-6/Q.834.3 – Software and Configuration Data Management

The fourth overview Use Case diagram shows the interactions for testing functionality through the support of the Supplier Management System.

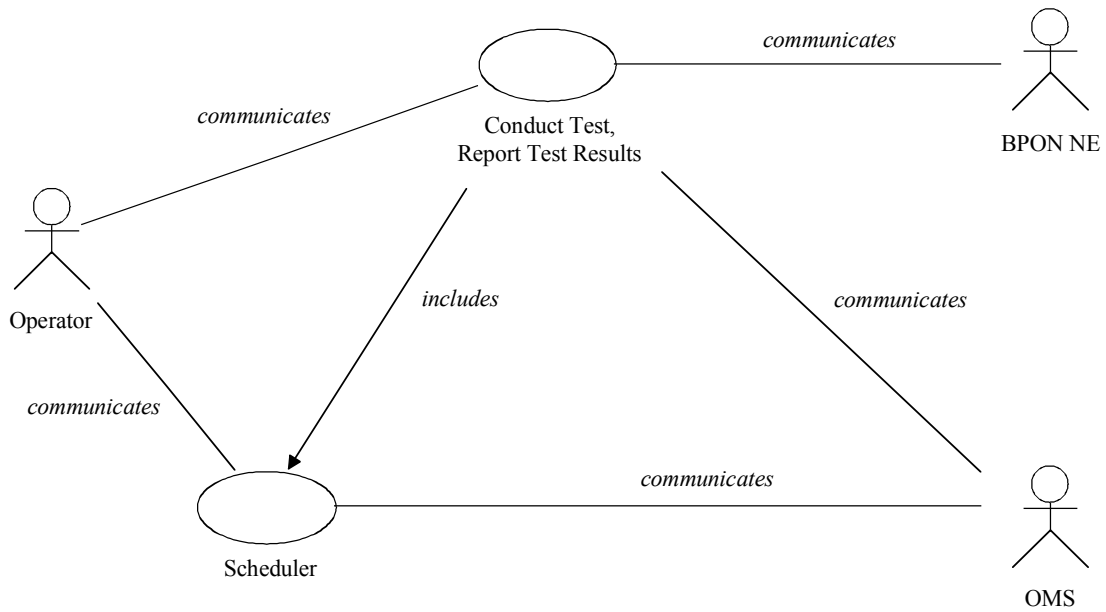

T0416260-02

Figure 5-7/Q.834.3 – Testing

The fifth overview Use Case diagram presents the internal functionality and external interactions of the Supplier Management System associated with the installation of BPON equipment.

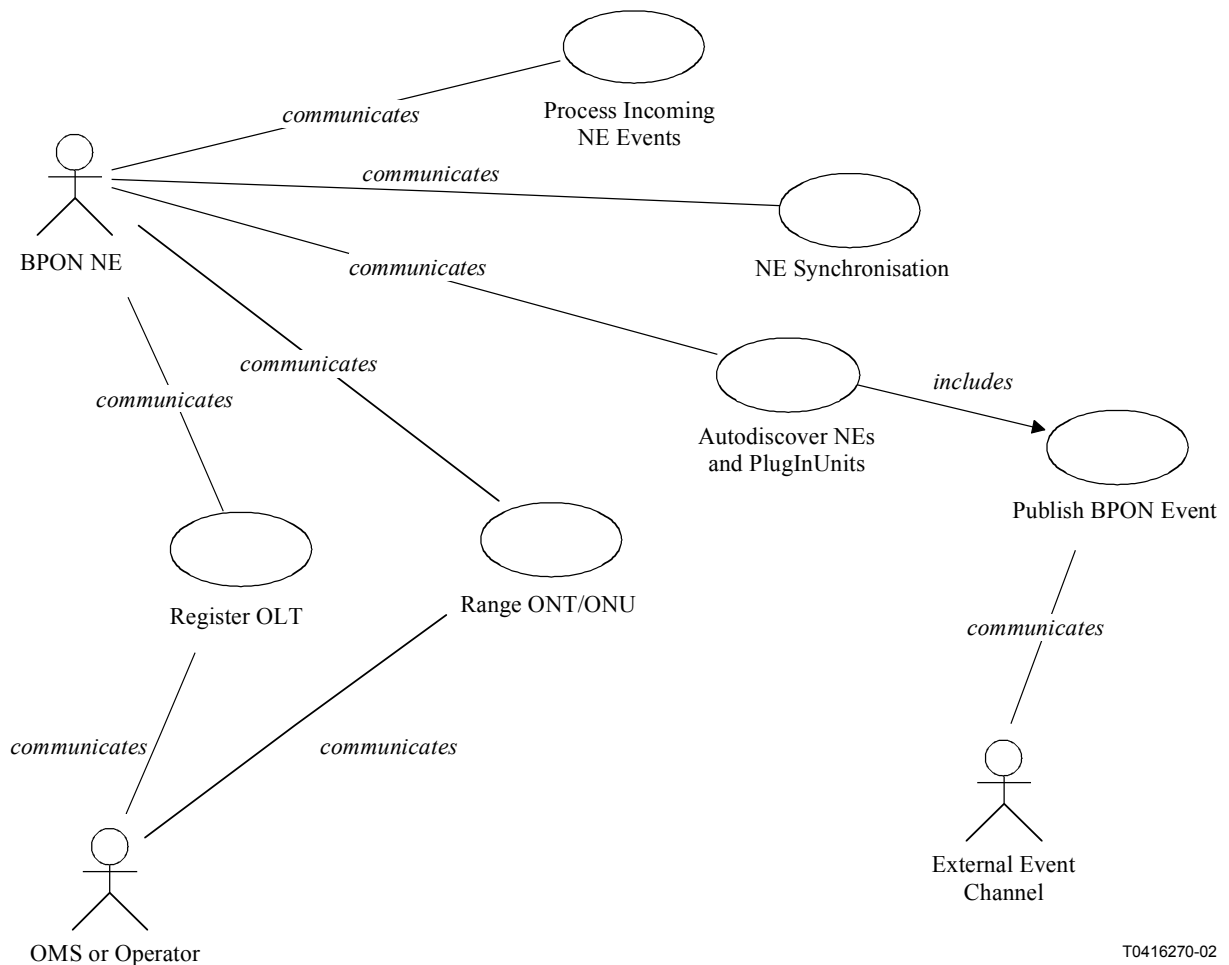

T0416270-02

Figure 5-8/Q.834.3 – Installation

The sixth overview Use Case diagram presents the internal functionality and external interactions of the Supplier Management System associated with provisioning of BPN Network Elements and BPN services.

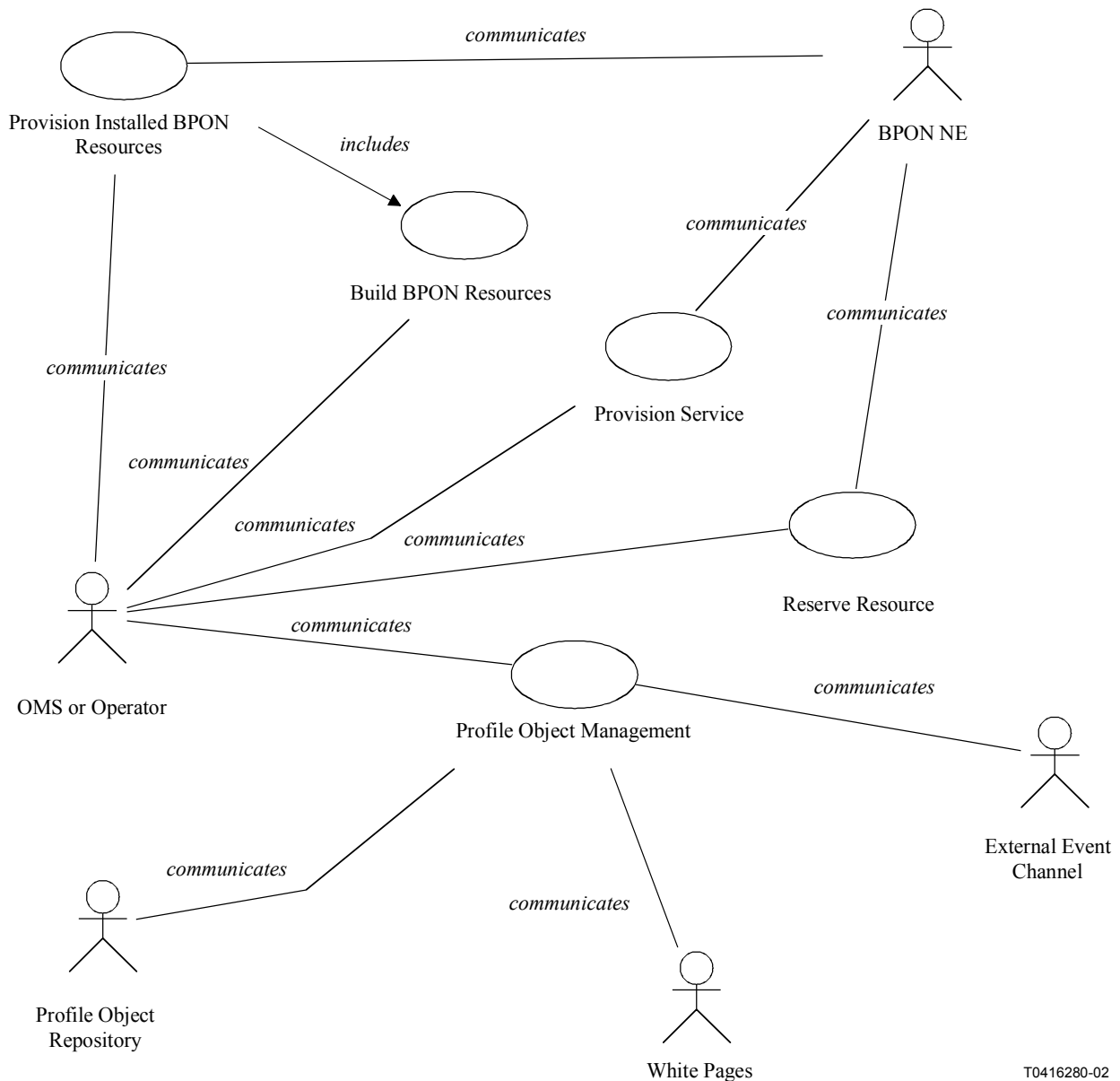
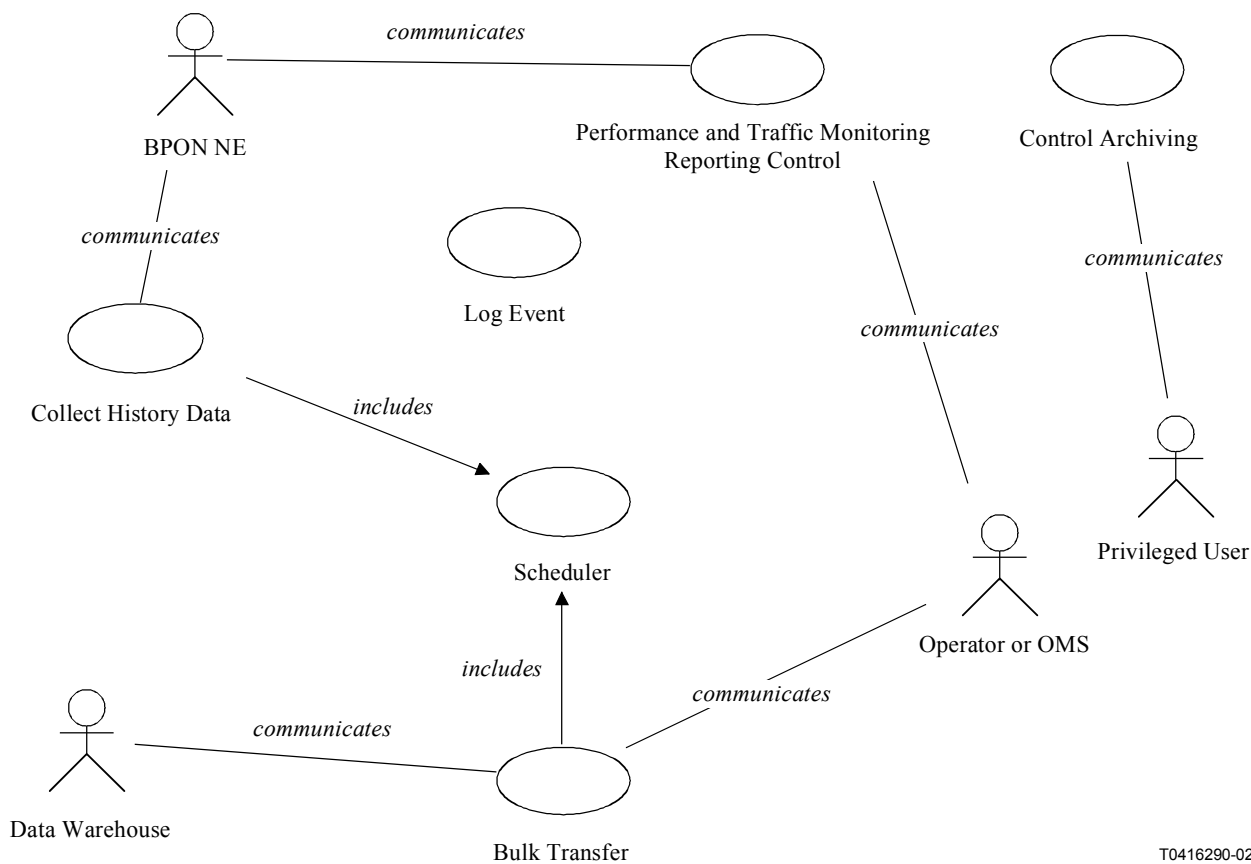

Figure 5-9/Q.834.3 – Provisioning

The seventh overview Use Case diagram presents the external interactions of the Supplier Management System associated with collection of statistics and bulk transfer of large amounts of data stored in short-term archives within the Supplier Management System.



T0416290-02

Figure 5-10/Q.834.3– Archiving and Bulk Transfer

The final Use Case diagram shows the management model and the external interactions that could be supported by the Supplier Management System in order to support the individual manipulation of managed entities defined in [11] and [12]. IIOP and CMIP protocol-specific specifications for these external interactions are captured in [14] to [16].

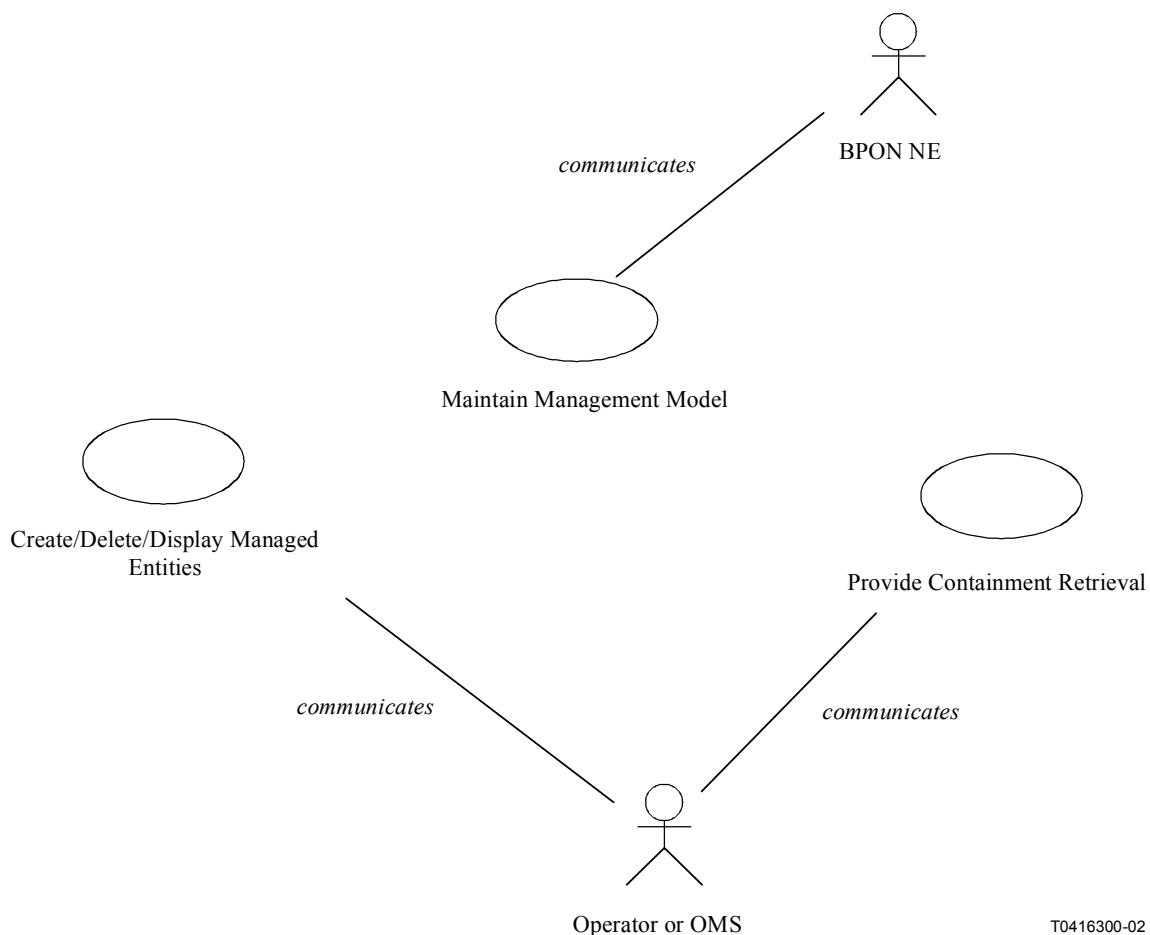

Figure 5-11/Q.834.3 – Management Model and Management Data Manipulation

5.2.2 Specification Level Requirements

This clause contains textual details for each of the Use Cases shown in the high-level Use Case diagrams of the previous clause. The details are provided to clarify the roles of external actors and telecommunications resources, to establish the basis for interactive diagrams in the Analysis clause, and to refine the previous high level Use Case diagrams to a specification level. Use Case details include the following components:

- Summary: short summary of Use Case functionality referencing TMN functionality as needed.
- Assumptions: listing of requirements surrounding the Use Case that would affect the design of the application code of the Supplier Management System.
- Actors: actors are listed as shown in Figure 5-2 followed by parenthetical role characteristic as needed.
- Preconditions: identifies the trigger for the Use Case commencement.
- Description: detailed textual rendition of the functionality of the Use Case including stops where exceptions can occur.
- Exceptions: identifies unsuccessful completion circumstances for the Use Case.
- Postconditions: identifies the conditions that will hold if the Use Case ends successfully.

The Use Case details are listed alphabetically by the Use Case title shown in the diagrams of the previous clause.

5.2.2.1 Administer User Privileges

Summary: This Use Case describes functionality for creating, deleting, assigning, and using access control information for users of the Supplier Management System.¹

Assumptions: Authentication is accomplished through use of an external Authentication Service for operator or OMS access and this function is outside the scope of the Use Case. Control of human user access to the Supplier Management System via the OMS is controlled by the OMS and is outside the scope of this Use Case. Access to the Supplier Management System via an OMS by any human user of the OMS is viewed to have the same privileges as the OMS. The Supplier Management System supports an administrative privileged user. Default logins and passwords have been provided to this user for initial login. Target activities are defined previously and known to the Supplier Management System.

Actors: OMS, Operator, Privileged User.

Preconditions: The Supplier Management System has been installed. Connectivity between the Supplier Management application, OMS systems, and all required GUI client applications has been provided.

Description: This Use Case begins when a privileged user starts login procedures to the Supplier Management System in order to administer user access rights. The Access Control Manager of the Supplier Management System verifies the user Id and password of the privileged user [Unknown User Id] and grants this user access to functionality supporting the manipulation of the access control lists for all operators of the Supplier Management System. The privileged user retrieves the permission listing for any user [Unknown User Id] and makes modifications to the listing according to operational needs. [Unknown Targets] This includes adding, deleting, or modifying the level of accessibility to any activity. The privileged user can also delete a user. The privileged user can add new users (both human and system). [Duplicate User Id] Settings for activity level for each activity for each user Id has values including "monitor only", "allowed to execute", or "no-access", to designate allowable operations on an individual activity basis. In the case of OMS access, particular interface methods are available or not depending on the access control requirements of operations.

Subsequently, operators attempting to log onto the Supplier Management System experience the following verification process. The Access Control Manager of the Supplier Management System verifies the user Id and password of the operator and grants the operator GUI access to the functionality allowed in the permission list. [Unknown User Id, No Activities Allowed].

If the OMS logs into the Supplier Management System, the Access Control Manager of the Supplier Management System verifies the login and password of the OMS and grants all the users of the OMS system uniform access to the same BPON resources with the same activity permission level. [Access Denied, Unknown User Id].

At any time after initial login, the operator, privileged user, or OMS may change their password. [Algorithm Failed]. This Use Case ends when the privileged user has updated permissions as needed.

Exceptions: Unknown User Id, Unknown Targets, Duplicate User Id, Algorithm Failed, Access Denied.

Postconditions: Operator access to the Supplier Management System is restricted to the activities and items that are allowed by the GUI. Restricting access to specific interfaces of the Supplier Management System controls OMS access to the Supplier Management System.

¹ This Use Case description makes use of management functionality described in [13].

5.2.2.2 Autodiscover NEs and PlugInUnits

Summary: The Supplier Management System publishes changes in inventory management information to the operator or OMS. Changes in inventory management information are discovered by the Supplier Management System as results of establishing management communications to an installed BPON NE, or through the insertion or removal of a plugin unit.

Assumptions: Communications between the Supplier Management System and the OLT are in place. Inventory data modelled in the Supplier Management System for a BPON NE (including contained equipment holders) and plugin units may be overwritten based on discovered data. The "to be discovered" equipment is in a stable condition. Embedded BPON NE software is able to detect actual plugin units present and act accordingly (in the case of the ONT or ONU, this implies that the default setting for any slot must be "plug and play"). Inventory management data refers to the type of information normally tracked by a capital asset system concerning physically installed equipment.

Actors: No external actors.

Preconditions: An OLT is registered, an ONT or ONU is ranged, or a plugin unit is manipulated in a slot of an installed BPON NE with operating management communications to the Supplier Management System.

Description: This Use Case begins when any one of the following events takes place:

- an OLT is registered;
- an ONT or ONU is ranged;
- a plugin unit is manipulated in a slot of an installed BPON NE having an available management communications channel to the Supplier Management System and this event is perceived by the Supplier Management System.

Registration of an OLT is an event triggering the synchronization of modelled inventory management data for the OLT with the same inventory properties discovered through direct communications with the OLT. [Comm. Failure] The Supplier Management System uses a Managed Entity Creation Record to format information about discovered properties of the OLT (NEFSAN), the shelves contained within the OLT (equipmentHolderF), the slots within the shelves (equipmentHolderF), the plugin Units inserted in the slots (plugInUnitF), and the embedded software of any plugin unit. [Unknown Plugin, Unknown Software Version].

The ranging of an ONU, whether on demand by the Supplier Management System or through the automatic ranging function described by ITU-T Rec. G.983.1, is an event that also triggers the synchronization of modelled inventory management data for the ONU with the same inventory properties discovered through direct communications with the ONU. [Comm. Failure] The Supplier Management System uses a Managed Entity Creation Record to format information about discovered properties of the ONU (NEFSAN), the shelves contained within the ONU (equipmentHolderF), the slots within the shelves (equipmentHolderF), the plugin Units inserted in the slots (plugInUnitF), and the embedded software of any plugin unit. [Unknown Plugin, Unknown Software Version].

The ranging of an ONT, whether on demand by the Supplier Management System or through the automatic ranging function described by ITU-T Rec. G.983.1, is an event that also triggers the synchronization of modelled inventory management data for the ONT with the same inventory properties discovered through direct communications with the ONT. [Comm. Failure] The Supplier Management System uses a Managed Entity Creation Record to format information about discovered properties of the ONT (NEFSAN), the slots within the ONT (equipmentHolderF), the plugin units inserted in the slots (plugInUnitF), and the embedded software of any plugin unit.

If any port of the ONT is integrated to the ONT (meaning not the port of a plugin unit), then this port information is captured through recognition of the Hardware Version of the ONT. [Unknown Plugin, Unknown Software Version].

The manipulation of a plugin unit in a slot is an event that triggers either the formatting of a Managed Entity Creation Record for the plugin unit in the case of insertion or the formatting of a Managed Entity Deletion Record for the plugin unit in the case of removal. Embedded software of the plugin unit is also discovered.

This Use Case ends when the Supplier Management System formats the information into a form appropriate for publication to the External Event Channel.

Exceptions: Comm. Failure, Unknown Plugin, Unknown Software Version.

Postconditions: The newly discovered data is made available to the OMS and operators responsible for inventory management.

5.2.2.3 Build BPON Resources

Summary: The Supplier Management System builds management model groupings for planned or installed BPON equipment on request of an OMS or Operator, or builds management model groupings as a result of autodiscovery. These resources include nodes (OLT, ONT, ONU) and ports (OLT NNI, OLT PON, ONU PON, ONT PON, ONT UNI, ONU NNI).

Assumptions: The OLT must be registered with the Supplier Management System if autodiscovery triggers this Use Case. If the OLT is already registered, the DCN connection between the Supplier Management System and the OLT must be available to build subtending managed entities. The DCN connection between the Supplier Management System and the Operator or Provisioning OMS is available. The Supplier Management System is responsible for providing unique identifiers for managed entities that are contained within the context of an OLT system that are created by execution of this Use Case.

Actors: OMS, Operator.

Preconditions: The operator wishes to plan for installation of BPON equipment, or autodiscovery detects the installation of new BPON equipment.

Description: This Use Case begins when the operator or OMS issues a planning request to build all or part of a BPON equipment resource or when the Supplier Management System learns of the installation of a BPON equipment resource through notification from the containing OLT. [Unknown Managed Entity Id, Duplicate User Label, Unknown Profiles, Invalid Parameter Value, Invalid Slot Assignment List, Unknown External Time Source, Unrecognized Version, Invalid Serial Number, Duplicate Serial Number] The build process begins with the construction of "highest" containing managed entity. The build process follows containment relationships (i.e. a port is not built unless the containing plugin unit or integrated containing node has been built and a plugin unit is not built until the containing slot has been built within a containing node). Furthermore, in the case of the build for a subtending ONT or ONU, the serving PON interface card port on the OLT must have been previously built. For the most part, the build consists of the creation of configuration managed entities primarily found in the NE view of ITU-T Rec. Q.834.1. The Supplier Management System follows the equipment hierarchy rules for the supplier's equipment, assigning identifiers to the managed entities it builds.

This Use Case also covers the request for change or deletion of groupings of configuration management managed entities. [Unknown Managed Entity Id, Remaining Contained Managed Entities, Duplicate User Label, Unknown Profiles, Invalid Parameter Value, Invalid Slot Assignment List, Unknown External Time Source, Unrecognized Version, Invalid Serial Number, Duplicate Serial Number] In the case of removal, the process follows the reverse order as the build, removing the "lowest" contained managed entities first.

As result of some external process outside the scope of this Use Case, the OMS or operator will have knowledge of the equipment hierarchy and naming conventions of the Supplier Management System. The operator or OMS may be informed of the identity of every managed entity created or deleted by each explicit build request. Business rules determine which identifier values are of interest to the operator.

This Use Case ends when information identifying the relevant configuration managed entities has been formatted and transmitted to the OMS or operator or to any requesting internal Use Case.

Exceptions: Unknown Managed Entity Id, Remaining Contained Managed Entities, Duplicate User Label, Unknown Profiles, Invalid Parameter Value, Invalid Slot Assignment List, Unknown External Time Source, Unrecognized Version, Invalid Serial Number, Duplicate Serial Number.

Post-conditions: The resource is built within the Supplier Management System management model, and is available for activities such as service provisioning. If a plugin is removed without a removal request through the Supplier Management System, an alarm is raised.

5.2.2.4 Bulk Transfer

Summary: Based on a timer (scheduler), explicit operator request, or a archive full indication, the Supplier Management System negotiates the transfer of any archived data through non-real time transfer mechanisms to a separate server known as a Data Warehouse. Archived data includes the contents of logs or record sets of statistics. This functionality includes monitoring and tracking of the transfer procedure.

Assumptions: A communication link exists between the Operator or OMS and the Supplier Management System when making an explicit request or when establishing a schedule. A communication link exists between the Data Warehouse and the Supplier Management System if the file transfer occurs between these systems. A communication link exists between the Data Warehouse and the BPON NE if the file transfer occurs between these systems. The Supplier Management System has authenticated the requesting Operator or OMS. Archived data is accessible. The Data Warehouse is able to store the new files (no obvious memory limitations). The Supplier Management System supports a scheduling function. Every record transferred in a single execution of bulk transfer function shall have the same data structure. After export, all exported data may or may not be deleted from the source location. If deletion of log records is expected, operator requested export should be possible only for special operator groups (authenticated). If a scheduled transfer is desired, a schedule to be used in conjunction with the transfer has been established. Details of the file format are outside the scope of this Use Case.

Actors: Data Warehouse, Operator, BPON NE, or OMS.

Preconditions: Archives have been established within the Supplier Management System and data has been stored in the archives.

Description: This Use Case begins when the operator, OMS, schedule, or internal process (e.g. "filled log") initiates a request for transfer of a file to the Data Warehouse. The request includes information identifying the archived information to be transferred, the file name to be used during transfer, the expected time for initiation of transfer, and the target destination location in the Data Warehouse for the transferred data. [Unknown Record Set, Unknown Scheduler, Unknown Destination Server].

The Supplier Management System initiates the following sequence of activities:

- The data records are grouped together into a file following a data transfer format pre-defined by operator and supplier agreement. The format conventions cover the use of delimiters, file header structure, file trailer structure. If the transfer data is found within a BPON NE, this step is accomplished within the BPON NE by request of the Supplier Management System.

- The Supplier Management System informs the Data Warehouse that the file is ready for transfer.
- The file transfer begins using a designated file transfer protocol at the time provided on the transfer request. [Data Warehouse Busy] The transfer can be either pulled from the source location server by the Data Warehouse or can be pushed from the source location server to the Data Warehouse.
- The Supplier Management System determines when the transfer is complete. [Unsuccessful File Transfer] It relies on file transfer protocol mechanisms to confirm that the transfer was successful.
- If the Data Warehouse is not ready to receive a new file the Supplier Management System tries to have the file transferred several more times during a set period of time. [Unsuccessful File Transfer Timeout].
- The Supplier Management System forms an activity completion record and logs the success or failure of the transfer in an activity completion log.

At anytime before completion of this process the Operator or OMS may check on the status of the transfer. [Unknown Transfer Process].

This Use Case ends when the file transfer is completed.

Exceptions: Data Warehouse Busy, Unsuccessful File Transfer, Unsuccessful File Transfer Timeout, Unknown Record Set, Unknown Scheduler, Unknown Destination Server, Unknown Transfer Process.

Postconditions: The Supplier Management System executes established procedures concerning the retention of successfully exported archived data.

5.2.2.5 Collect History Data

Summary: The Supplier Management System shall provide for the collection of History Data records from the BPON NEs, including both performance and traffic monitoring statistics. This collection shall be timely and occur before requested records can be over-written by the BPON NE. This function supports OMS or Operator data collection from the Supplier Management System.

Assumptions: Performance or traffic monitoring and reporting has been activated by the Operator or OMS for at least one monitoring point on a BPON NE within the management jurisdiction of the Supplier Management System. Monitoring on the BPON NE is accomplished through a register for every monitoring point. "Reset to initial value" for a register is configured for the same start time throughout the BPON NE for any register associated with a specific interval (intervals may be 5 minutes, 15 minutes, or 24 hour in length).

Each type of collectable History Data record is defined by the operator and associated with a specific monitoring interval length and monitoring point. The operator also has chosen consistent start times for these intervals across the management domain of the Supplier Management System. A statistics archive has been created and initialised by the operator (or via Supplier Management System default setting) to hold each type of collectable History Data record. Archives are constructed to only accept records of the same type (e.g. DS1PMHistoryData, or DS3PMHistoryData) involving the same monitoring window length. If performance reporting has been requested by the operator for a particular monitoring point (via the Use Case called "Performance and Traffic Monitoring Reporting Control"), a record showing the values for the counters or gauges is created at the end of the monitoring interval in the BPON NE and is available for collection.

If the collection of History Data records is triggered by a customer complaint, then the Supplier Management System executes the retrieval of pertinent History Data records as a separate process in order to tag each record with the Service Instance Id.

Actors: BPON NE.

Preconditions: All required History Data records have been formed on the BPON NE.

Description: This Use Case begins when the scheduler indicates that another collection interval has been begun. The Supplier Management System systematically communicates with each OLT and retrieves all available and newly formed History Data records for each BPON NE for the previous monitoring time interval for monitoring points of interest for the Operator or OMS. In the case of collection triggered by a customer complaint, the service instance Id is added to the history data records collected because of the customer complaint.

If the communications channel between the Supplier Management System and the BPON NE is interrupted, the Supplier Management System attempts to re-establish communications and retrieve all History Data records for as long this collection can be accomplished before the scheduler triggers another round of collection [Comm. Failure, DCN Congestion]. The Supplier Management System classifies and stores the records in the short-term archive that holds the same record type. The Supplier Management System forms an activity completion record and logs the success or failure of the transfer in an activity completion log.

This Use Case ends when the scheduled collection interval is ended.

Exceptions: Comm. Failure, DCN Congestion.

Postconditions: BPON NE historical performance information is available for subsequent viewing by the operator and for bulk transfer to other file servers. The Supplier Management System archives the resulting information with other records of the same type awaiting the bulk transfer to the Operator Data Warehouse.

5.2.2.6 Conduct Test, Report Test Results

Summary: The Supplier Management System shall participate as required in any operator or OMS directed testing procedure including, but not limited to, ATM OAM cell loopback testing, interface loopback set up on subscriber cards or OLT network interface cards, and ATM continuity checks.

Assumptions: The Supplier Management System communications channel to the NE is working. The Supplier Management System is ready to receive commands from an operator or OMS. Supplier Management System communications channel to Operator or OMS is working. The Test Performer or Test Device of the NE is working. Tests are sequential. The NE has capabilities to conduct the test. This Use Case can conduct tests to assess hardware functioning. This Use Case can also conduct test scenarios in order to address customer complaints of service failures. The OMS or operator constructs various test sequences to address diagnostics for specific detected or reported failure conditions.

Actors: Operator, BPON NE, OMS.

Preconditions: BPON network resources tested by this functionality have been installed and provisioned. In the case of service level testing, service has been provisioned and activated as well.

Description: This Use Case begins when an operator or OMS receives a customer complaint or detects the failure of a BPON network resource. The operator or OMS constructs a test request. Types of tests requested include physical level tests, logical level tests, and service level tests.

Physical level tests include the following: voice frequency, quality of data transmission, multimeter test, signalling test, loop test, wideband test, power on self-test and on demand self-test. Logical level tests include the following: ATM Cell Continuity Check, and ATM Cell Loop Back. Service level tests include protocol tests and service level loopback.

The Supplier Management System executes the following steps:

- identifies the tests requested, [Unknown Test Operations, Invalid Timeout Period];
- identifies the BPON resource to be tested and ancillary BPON resources that must participate in the test, [Unknown BPON Resources];
- prepares the resources for the test (engages the test performer or device of the NE);
- executes the test sequence in collaboration with the NEs, [Comm. Failure, Unable To Execute, Timeout];
- collects the results of the test; and
- reports the results of the testing promptly to the requester.

If the test is of sufficient duration (e.g. interface port loopback tests) and the test is viewed to be controlled, the Supplier Management System supports test interruption from the requesting party and reporting of interim test results. [Unknown Test Process, Unknown Termination Points].

Tests may be triggered by a scheduling function. In this case, the test reporting process retains test results, grouping it with other test results and logged for viewing by the operator at a later date. [Unknown Scheduler].

If the Supplier Management System receives scheduled test requests to occur on the same managed resource, the first scheduled test is executed and the others generate a conflict report that is logged.

This Use Case ends when the test completes execution and results are reported to the requesting system or operator or logged in a activity completion log.

Exceptions: Unable To Execute, Unknown BPON Resources, Unknown Test Operations, Invalid Timeout Period, Unknown Scheduler, Timeout, Unknown Termination Points.

Post-conditions: An operator or OMS has more information with which to resolve the complaint of a customer or to support a maintenance activity.

5.2.2.7 Control Archiving

Summary: The Supplier Management System provides the functionality to manage logs for specific groups of events including the clearing of the contents of the logs. The Privileged User can create, initialise, suspend, resume, and remove event logs. The Supplier Management System also provides the functionality to control the short-term archiving of performance monitoring and traffic monitoring reports, including the clearing of contents of these record sets. This function also includes the reporting of status for current logs or statistics record sets.

Assumptions: The Supplier Management System supports logs and short-term statistics archives. Only a privileged user has permission to create, initialise, suspend, or resume archiving. Access control for the user has been verified prior to this Use Case. There are memory resources available on the server hardware supporting the Supplier Management System. The Supplier Management System tracks the status of logs and archives and provides a notification if a threshold related to the fill status of the log or archive is crossed. A communication link exists between the Privileged User and the Supplier Management System.

Actors: Privileged User.

Preconditions: The Supplier Management System is installed.

Description: This Use Case begins when the Privileged User initiates a request to modify the archiving of events (logs) or performance and traffic statistics.

In case of log creation, the creation request identifies a filter defining the entrance criterion for an event in the log, log maximum size, full action (wrap or stop recording), and an optional size threshold in the case of a stop full action. [Archive Exists, Duplicate User Label].

After the creation of the log, the operator can initialise it for use as well as modify the maximum size, full action, and size threshold values. [Unknown Archive] The Supplier Management System also supports the actions of "suspend" and "resume" for the storing of events in the log. [Unknown Archive, Locked Already, Unlocked Already] At any time the Privileged User can view the current size of the log, its most recent clear time, Suspend Status, and its OperationalState. [Unknown Archive] (For example, the OperationalState of the log is disabled if the log has not been initialised or if hardware memory can no longer support the archiving actions of the log.) The Supplier Management System also supports the removal of the log and its contents.

In the case of performance or traffic statistics recording, the creation request identifies the type of History Data record, the maximum size (in terms of record count), full action (wrap or stop recording), and an optional size threshold (in terms of record count percentage to maximum size) in the case of a stop full action. [Archive Exists, Duplicate User Label] After the creation of the statistics archive, the operator can initialise it for use as well as modify the maximum size, full action, and size threshold values. [Unknown Archive] At any time the Operator or OMS can view the current size of the archive, its most recent clear time, and its OperationalState. [Unknown Archive] (For example, the OperationalState of the record set is disabled if the record set has not been initialised or if hardware memory can no longer support the archiving actions of the statistics record set.)

The privileged user may also delete or purge an archive of entries by specifying the user label of the archive.

This Use Case ends when an archive is created, modified or deleted.

Exceptions: Archive Exists, Unknown Archive, Locked Already, Unlocked Already, Duplicate User Label.

Post-conditions: The archive is created, modified or removed.

5.2.2.8 Distribute Software

Summary: The Supplier Management System provides for the download, distribution, installation (commit), and activation of software generic programs, software upgrades, and software maintenance changes (patches) to BPON NEs based on request of the operator or OMS. The Supplier Management System can accept requests for one or multiple BPON NEs at once.

Assumptions: The destination within the BPON NE for software download is free to accept downloaded software (e.g. no backup in progress). There are no outstanding alarms on BPON NE components involved in software download (e.g. control card operational or other NE components involved in software propagation). Supplier Management System supports software version control. The communication between Supplier Management System and OLT is functional at the beginning of the Use Case. The communication channel between the OLT and the Software File Server is functional at the beginning of the Use Case. Before establishing a scheduled activity, it is assumed that the software set is available and tested.

The operator can abort the download before it is completed. Until software is successfully loaded, propagated and activated, the former "active" version stays active. Software version control functionality is available. The Supplier Management System shall be able to support requests for software download, commitment, and activation for a single instance and/or all instances of ONTs, ONUs, or NTs subtending from one or all PON interfaces on one or more OLTs. The Supplier Management System shall be able to support requests for software download, commitment, and activation for a single instance and/or all instances of a particular card type for one or more OLTs. The activation of software on the OLT and ONU shall not be service affecting. If the activation of software on the ONT or NT is service affecting, the activation period is expected to last less than a few seconds.

Actors: Operator, OMS, BPON NEs, Secure File Server.

Preconditions: The operator or upstream OS desires to load generic programs, software upgrade, software maintenance changes and configuration data to BPON NE.

Description: This Use Case begins when the operator or upstream OS makes a request to the Supplier Management System to load (and eventually activate) new software for the BPON NEs. The request includes a reference to the location of the software item to be downloaded and the target destination(s) of the download. The target destination can be specified at the BPON NE or circuit pack level. The request can include a schedule or reference to a schedule for download and/or activation. The Supplier Management System verifies the use of the software through software version control [Unrecognized Target, Software Load/Hardware Mismatch, Unknown Scheduler, Unknown Software Load].

The Supplier Management System then coordinates OLT access to the new software to be loaded consulting the schedule or via on-demand request. [Source Unreachable] The OLT downloads the software from the Software File Server and applies the software to the target destination(s) and verifies that the delivery process has not introduced any errors to the software load [Comm. Failure, Distribution Failure, Insufficient Memory, Timeout, Download Failure]. The software is not initially loaded to an active segment of the target destination. The software is then "committed", i.e. installed [Installation Failure, Unknown Software Unit] and then activated by the operator or OMS. [Activation Failure, SoftwareNotYetInstalled, Unknown Software Unit] The Supplier Management System shall support both manual and automatic commitment and activation of successfully downloaded software.

If software installation or activation is triggered through a distinct request (i.e. manually), then the Supplier Management System shall reply with notification of success (or failure) of the operation. If software installation or activation is triggered automatically, then the Supplier Management System shall provide autonomous notification of the success (or failure) of the operation. If software installation and activation is triggered through a schedule, then the Supplier Management System shall log the success or failure of these procedures in an activity completion log.

The Operator (or OMS) shall be allowed to cancel the software download process prior to its scheduled installation. [Software Installed, Unknown Software Unit, Comm. Failure, Equipment Failure, Activation Completed].

If the download is unsuccessful due to a break down in the communications network between the Software File Server and the OLT (source unreachable condition), the operator can choose to restart the download without requiring the reformulation of a new download request [Download Failure]. Whether the download is successful or not, the Supplier Management System supports operator and OMS queries concerning the status of the download, distribution, commitment, and activation process. Status values include completed, failed, waiting, and blank.

Exceptions: Software Load/Hardware Mismatch, Download Failure, Distribution Failure, Installation Failure, Activation Failure, Unknown Software Unit, Source Unreachable, Unrecognized Target, Comm. Failure, Unknown Scheduler, Equipment Failure, Software Installed, Software Not Yet Installed, Insufficient Memory, Activation Completed, Timeout.

Postconditions: Successful activation of software implies its subsequent executable use in the BPON NE. Information is made available to Software Version Control concerning the current software in use.

5.2.2.9 Log Event

Summary: The Supplier Management System stores event information in a log based on the filter defining the log. The Supplier Management System forwards the contents of a log as records to a transfer function based on a logFull condition. It makes the contents of a log available to a transfer function for scheduled bulk transfer.

Assumptions: It is possible to construct filters to describe the contents of logs within the Supplier Management System. Operator can create these filters, modify the filters when needed, and delete them when they are no longer needed. A set of default filters is attached to the individual log file, and when not defined, the default is no filtering. Log maintenance is handled by other Use Cases (control archiving and bulk transfer). In other words, logs are created, initialised, and cleared via other Supplier Management functionality. Only privileged users are allowed to create filters that define logs archived within the Supplier Management System.

Actors: There are no external actors.

Preconditions: An event has been processed by the Supplier Management System and a record formatted as result of that processing.

Description: This Use Case begins when the Supplier Management System has processed an incoming event and formatted the resulting event record. Events include alarms, alarm clearings, threshold-crossing alerts, protection switching events, circuit pack removals, creation or deletion of Managed Entities, changes to key state and status variables, and other Supplier Management System-defined conditions. The processed event record is examined to see whether or not the record data matches any of the filter constructs defining the contents of any of the logs created and initialised for the Supplier Management System. [Event Flood] (The filters determine which events are to be added to specific event logs.) If the event record does not match any filter, the event information is discarded. If the event record does match a specific construct, the event record is stored in the relevant event log. [Out of Memory] If the log has been configured as a "wrap around" log, and the log is full, the event record overwrites the oldest record in the log. If the writing of the event record causes a logFull condition, then the current content of the log is made available to a bulk transfer function and contents of the log are cleared immediately afterwards. If the log is not full, the event record is written at the end of the log.

Exceptions: Out of Memory, Event Flood.

Postconditions: The log is available for viewing by the Operator. The contents of the log are available for bulk transfer to another file server called a Data Warehouse.

5.2.2.10 Maintain Management Model

Summary: Maintaining the management model is central to the relationship between the OMS and the Supplier Management System. It is also central to the internal operation of the Supplier Management System. The purpose is to assure that any process can find a representation of the data it needs, with certainty that the information is consistent with the real attribute value for both logical and physical entities.

The Supplier Management System stores information and responds to requests for information. It contains managed entities and, more importantly, relationships between entities. The model understands the relationships. They do not have to be persistent, but the data must reflect the state of the network.

Assumptions: The Use Cases that call for maintenance of the management model are in communication with the management model manager. The relationships in ITU-T Recs. Q.834.1 and Q.834.2 form the basis of the management model.

This Use Case manages the process of converting from one model version to another. Such a conversion process will not disrupt the operation of the Supplier Management System for more than five minutes for a Supplier Management System with 50 fully equipped OLTs.

Actors: BPON NE.

Preconditions: The execution of a Use Case in the Supplier Management System has called for a change in the state of the management model.

Description: This Use Case begins when there is a change in a managed attribute value, a creation, or deletion that affects the management model. On receiving a change to attributes of a managed entity, the Supplier Management System will check it for consistency with the logical schema and existing model. [Managed Entity Not Found, Invalid Attribute, Inconsistent Attribute Value].

When a managed entity is created, the Supplier Management System will assure that the appropriate set of subordinate objects is created, and that all relationships are properly established. [Missing Pointer] When a managed entity is deleted, the Supplier Management System will assure that the caller's intent on deletion of subordinate objects is followed and that all relationships are properly updated.

Each time a piece of data is needed, the model must be able to determine whether it has the appropriate value for a data item locally or whether the information must be retrieved from some other persistent source, e.g. the NE.

When a profile is being considered for deletion, the Supplier Management System will be able to determine if an instance of a profile is still in use as the basis of a managed entity in its domain.

The Supplier Management System must maintain and enforce entity relationships to maintain its internal consistency.

The Supplier Management System must support conversion of the management model from one software version of the application to another with minimal disruption to the operation of the Supplier Management System. This suggests that it might be necessary to build a new model version while the old model is still in use.

This Use Case ends when the Supplier Management System has finished responding to the calling internal Use Case.

Exceptions: Managed Entity Not Found, Invalid Attribute, Inconsistent Attribute Value, Missing Pointer.

Post-conditions: After each transaction, the management model will accurately represent the state of the real and logical entities.

5.2.2.11 NE Restoral

Summary: The Supplier Management System provides the operator with capabilities for backing up and restoring of an OLT system in the case of catastrophic failure of the OLT Network Element Layer.

Assumptions: Stewardship of the OLT system MIB may be in the OLT, may be in the Supplier Management System or may be spread between the two. OLT system refers to the OLT and all its subtending BPON NEs. The OLT has the current copy of MIB data for its subtending BPON NEs. It is necessary to restore the information and normal functioning of the BPON NE (including management by the Supplier Management System) as soon as possible. Backup versions of the OLT system MIB information are available on a Secure File Server.

Before the restore or backup processes can start, DCN communications between the OLT and Supplier Management System and between the OLT and the Secure File Server must be available. Before the restore process begins the OLT equipment must be repaired. Access control for the user has been validated prior to the Use Case.

Actors: Operator, OMS, BPON NE (OLT), Secure File Server.

Preconditions: The operator or OMS wishes to schedule the upload of BPON System MIB data. The BPON OLT is not experiencing a catastrophic failure.

Description: This Use Case is triggered by a request of the Operator (or OMS) or by request of a scheduling utility in the Supplier Management System. In either case, a request for upload is formed and contains information about the OLT system to engage in the upload process (as required) [Unknown OLT], and destination identification for the server, including server DCN address, directory, and file name. [Unknown Destination Server, File Exists, Unknown Scheduler, Comm. Failure, Equipment Failure].

The master of the OLT system MIB data may be the Supplier Management System, may be the OLT, or the responsibility may be shared between the two. As a result, OLT system MIB data may have to be uploaded from several locations at the same time. If the information comes from two locations (OLT and Supplier Management System) the backup data must be held in the same destination server directory. The Supplier Management System returns a BackupProcessId to the request that can be used to cancel, monitor the progress of, or report the success/failure of the upload process. [Unknown Backup Process, Backup Completed].

The server retains multiple versions of backup data. If need be, this server uses tape device backup itself to archive sufficient versions for operator requirements of security and reliability. The Supplier Management System maintains a log of successful uploads.

If an OLT needs to be restored, maintenance activities may be required (including replacement of NEL-related plugin units) before the operator can request a restore of the OLT system. The operator accesses the log of successful uploads and chooses a version to use to restore the OLT. The operator forms a restore request. This request includes the identity of the OLT and the version of archived MIB data to be used. The operator may also let the Supplier Management System make the "best possible" version choice.

The Supplier Management System checks the requested version against current equipment and software versions and determines if the version can be downloaded for NE restoral. [Software Load/Hardware Mismatch, Unknown OLT, Unknown Source File, Unknown Source Server, Comm. Failure, Equipment Failure] In the case that the OLT is the master of the data, the Supplier Management System causes the OLT to pull the correct MIB version from the server. In the case that the Supplier Management System is the master of the data, the Supplier Management System pulls the version of MIB data from the server.

The operator may monitor the progress of, and receives a report of success/failure of the restore process. [Unknown Restore Process, Unknown Archive].

Exceptions: Unknown OLT, Software Load/Hardware Mismatch, Unknown Destination Server, File Exists, Unknown Scheduler, Comm. Failure, Equipment Failure, Unknown Backup Process, Unknown Restore Process, Unknown Source Server, Unknown Source File, Backup Completed, Unknown Archive.

Postconditions: The successful download of MIB data triggers an NE synchronization process.

5.2.2.12 NE Software Version Control

Summary: The Supplier Management System tracks the version and update status of BPON NE software and records this information in a repository accessible by the operator or NML system. The Software Version Control validates the to-be-downloaded software version against the saved version number, and raises exception for invalid to-be-downloaded software version. The Operator can view the software version information in the repository.

Assumption: The Supplier Management System has a repository set up to store BPON NE software version information. The Supplier Management System has buildin algorithms, or rules for version control. The repository is large enough to hold hardware and software version information for all BPON NEs within its engineered management domain.

Actors: Operator, OMS, and BPON NE.

Preconditions: A new version of NE software is due to be downloaded, a new version of NE software has been successfully downloaded and due for activation, or a new NE has been installed in the network and autodiscovery has taken place.

Description: This Use Case begins when a software download is initiated, when a software activation is scheduled, or when a new BPON NE has been installed in the network and autodiscovery has taken place. In each case, the Supplier Management System consults the current software and hardware version information provided within the software control repository for the NE memory area(s). [Unknown BPON NE, Invalid Version Id] It determines if the version of software in the download or activation request, and/or the newly discovered version of software in the BPON NE, matches the rules or algorithmic checks implemented within the Supplier Management System for the corresponding hardware version. It provides notification of mismatch or match to the requesting internal process.

In the case of a newly installed BPON NE, or following the successful download and activation of software to a BPON NE memory target, the Supplier Management System updates software and hardware version information within the repository. [Unrecognized Target].

When the OMS or Operator requests the software version information for a BPON NE, this information is displayed to the Operator or OMS consistent with the BPON NE software/hardware version schema. If desired, this request can include validation of the repository information directly with the BPON NE. [Comm. Failure] The Supplier Management System shall also support Operator or OMS requests for all allowed software versions associated with a particular BPON NE target.

Exceptions: Unrecognized Target, [Invalid Version Id], Unknown BPON NE, Comm. Failure.

Post-conditions: The version information of BPON NE software is updated and accessible to the operator and OMS.

5.2.2.13 NE Synchronization

Summary: The Supplier Management System is responsible for providing synchronization and consistency between all physical and logical BPON network resource data.

Assumption: The management communications channel between the BPON resource is available. The Supplier Management System maintains an information model that captures the configuration data in a BPON system. This information model should reflect the current provisioned state of the BPON system. As provisioning changes are made in the network the information model is updated to reflect the latest changes. These changes may occur by the operator provisioning something through the Supplier Management System, or through a craftsperson provisioning changes in the field.

Actors: BPON NEs, Privileged User.

Preconditions: The Supplier Management System maintains a management model for information concerning a BPON NE.

Description: This Use Case begins when there is an event denoting a DCN connection establishment or recovery, a remote reset of a BPON NE, an ONT or ONU ranging, or a resynchronization of a current event listing. When an ONT is ranged, it is assumed that the OLT will automatically update its local ONT configuration to reflect the state of the ONT. This means that the Supplier Management System will use the range event to trigger an upload of the ONT data from the OLT.

Each time the process is initiated, an NE will be selected for synchronization. The process will initiate an upload of data from the NE. This will be a vendor-specific implementation.

The next step in the sequence is to reconcile the data retrieved from the NE with the current state of the information model. If there is any difference in any data stewarded by the NE, then the model will be updated and (if business rules apply) attribute value change information will be formatted and made available as published notifications to any interested operator or OMS. As updates are made to the information model, events will also be generated in the system. If there is any difference in any data stewarded by the Supplier Management System, then the Supplier Management System issues configuration change requests to the NE.

The process will conclude by returning a value to the initiator (internal procedure) that indicates that the synchronization process was successfully completed, and the information model was updated.

A privileged user can also request, possibly on a scheduled basis, a resynchronization of NE and Supplier Management System management information. The request includes the identification of the BPON NE and reference to the optional schedule. [Comm. Failure, Unknown Scheduler, Unknown BPON NE, Equipment Failure].

Exceptions: Comm. Failure, Unknown Scheduler, Unknown BPON NE, Equipment Failure.

Post-conditions: Management information resident in installed BPON NEs is consistent with the same information resident in the Supplier Management System.

5.2.2.14 Performance and Traffic Monitoring Reporting Control

Summary: The Supplier Management System shall provide for the activation and deactivation of performance data or traffic measurements collection on individual termination points contained in the BPON NEs as required by the operator or OMS. This Use Case also includes the setting of threshold values and describes automatic reporting of performance measurements when thresholds have been crossed.

Assumptions: Hardware and software support for monitoring of all performance and traffic parameters defined in the Current Data and History Data managed entities of ITU-T Recs. Q.834.1 and Q.834.2 is available. Current Data is not directly controlled by OMS. Hardware and firmware support for performance and/or traffic monitoring at all BPON NE monitoring points have been initialised and activated and counters and gauges are operational. The communications channels between the BPON NE and Supplier Management System and between the Supplier Management System and the Operator or OMS are working. The Supplier Management System has verified that the operator or OMS has permission to establish threshold values and/or to request the collection of statistics from the BPON NEs.

The Supplier Management System can hold up to one week of History Data records collected from the BPON NEs within its management domain. The BPON NE can retain historical parameter values for at least one collection period beyond the recording of the data. The ultimate short-term archiving capability for performance and traffic records in the BPON NE is a matter for determination through explicit Operator requirements and is not in the scope of this Use Case. Performance monitoring points of BPON NEs support the raising of threshold crossings alerts based on the setting of threshold values. Only counters are employed in performance monitoring or traffic monitoring for BPON NEs (i.e. gauges do not play a role in ITU-T Recs. Q.834.1 or Q.834.2).

Actors: Operator, OMS, and BPON NE.

Preconditions: The Operator desires to change the setting of Threshold Data values or wishes to collect performance and traffic measurements from BPON NEs.

Description: This Use Case begins when the operator or OMS establishes or modifies values for thresholds for monitored performance or traffic metrics for any or all monitoring points within a BPON NE. The operator or OMS sends a request to the Supplier Management System indicating the monitoring point(s) of the BPON NE, identification of the monitored parameters, and associated

threshold values to be used when the BPON NE generates a Threshold Crossing Alert event. [Unknown Monitoring Point, Unknown Threshold Data, Invalid Threshold Data, Unknown BPON NE] The Supplier Management System transfers each of the threshold values to the identified BPON NE for use at the associated monitoring point. The request process includes the opportunity for the operator to make a default setting assignment for a system-wide threshold value for each monitored parameter type within a specific BPON OLT system.

The BPON NE continues its constant monitoring of performance at each monitoring point for each counter, resetting each measurement to zero at the end of the monitoring interval associated with the counter. There can be 5 minute, 15 minute, and 24-hour counters in the BPON NE. Monitoring intervals are automatically established and applied on a uniform basis across all monitoring points of the BPON NEs within the management domain of the Supplier Management System as each BPON NE is added to the management domain of the Supplier Management System. A single monitoring interval start time can be set whenever a Supplier Management System is brought on line and subsequently modified by the Operator.

The BPON NE uses the threshold value to autonomously alert the Supplier Management System whenever the counter associated with the performance parameter falls out of the acceptable performance range indicated by the threshold value. TCA event processing by the Supplier Management System triggers (in part) the automatic retrieval of the History Data record associated with the TCA event by the Supplier Management System. The History Data record is archived with other records of the same type associated with TCA events and awaits the bulk transfer to the Operator Data Warehouse.

Based on customer complaint, the operator or OMS can request the collection of History Data records for a selection of monitoring points for limited periods of time. The request includes the identification of the BPON NE and monitoring points, the History Data records to be collected, the start time for collection, the collection window length and the Service Instance Id associated with the complaint. [Unknown Monitoring Point, Collection Period Past, Unknown Service Instance Id, Unknown BPON NE] The Supplier Management System notes the monitoring points and monitoring collection intervals and collaborates with the containing BPON NE to enable the subsequent reporting of performance parameter values for each of the collection intervals for each monitoring point. [Collection Limitation].

The operator or OMS may also request the routine collection of certain History Data records from BPON NEs or may request the termination of routine collection. The request made to the Supplier Management System identifies the monitoring point type and History Data type. [Unknown Type, Unknown Scheduler, Unknown BPON NE] The Supplier Management System notes the monitoring points and collaborates with the containing BPON NE to enable the subsequent reporting of performance parameter values for every collection interval for each monitoring point, or to disable the subsequent reporting. If the request indicates that monitoring intervals indicating no impairments (zero values) shall not be reported, then the Supplier Management System collaborates with the containing BPON NE in order to suppress "all zeroes" reporting. [Collection Limitation].

Based on trend analysis or traffic monitoring needs, the operator or OMS can also request the routine auditing (i.e. collection) of History Data records. The request made to the Supplier Management System includes the BPON NE, monitoring point instance, History Data record type and schedule to apply to the collection of the History Data record identified. [Unknown Monitoring Point, Collection Period Past, Unknown BPON NE]. The Supplier Management System notes the monitoring points and monitoring collection intervals and collaborates with the containing BPON NE to enable the subsequent reporting of performance parameter values for each of the collection intervals for each monitoring point. In this case, reporting of zeroes is not suppressed. [Collection Limitation].

Finally, with extremely limited application, the operator can request the repetitive collection of a monitored parameter value in a specific Current Data register. The request identifies the monitoring point instance, the parameter and the monitoring interval start time. [Unknown Monitoring Point, Collection Period Past] Collection is limited to one monitoring interval. The number of values collected will depend on the granularity of measurement and reporting supported by the Supplier's implementation of the BPON NE monitoring point. At the end of the interval the Supplier Management System transfers the information to the operator. [Comm. Failure].

The operator or OMS may query the Supplier Management System at any time to obtain a listing of reporting monitoring points and reporting intervals for each BPON NE.

Exceptions: Collection Limitation, Unknown Monitoring Point, Collection Period Past, Unknown Type, Comm. Failure, Unknown Threshold Data, Invalid Threshold Data, Unknown Service Instance Id, Unknown BPON NE, Reporting Exists, Unknown Scheduler.

Postconditions: The operator has set Threshold Data values for monitored parameters. If the operator request involves the collection of History Data records in the Supplier Management System, then these record sets are available for viewing by the operator, or for transfer to Operator Data Warehouses.

5.2.2.15 Process Incoming NE Events

Summary: The Supplier Management System processes event notifications from the BPON NEs within its management jurisdiction. The Supplier Management System identifies the event type and source, transforms and augments the data into an event record structure of potential benefit to upstream systems and users, and transfers the record into an internal repository accessible to other Supplier Management System functions.²

Assumptions: The communications channels between the Supplier Management System and the NEs are working. The Supplier Management System is able to accept notification of all events from the BPON NEs within its domain of management. Events are time-stamped by the NEs with a consistent timing source. The Supplier Management System coordinates the time stamp mechanism between NEs.

Actors: BPON NE.

Preconditions: An event is detected by an installed BPON NE.

Description: This Use Case begins when an event notification arrives from a BPON NE. Upon receiving an NE event the Supplier Management System uses a soak period to screen event transients (e.g. toggling alarms). This is distinct from the soak period used by the NE to determine that the situation should be reported as an alarm. The Supplier Management System perceives the event (i.e. it screens the source of the event and verifies that it is interested in the event). [Corrupted Event Data, Incomplete Event Data, Unauthorized Source]. The Supplier Management System shall discard any event according to a set of business rules including, but not limited to, the elimination of "toggling" events and congestion conditions on the input event buffer. (Persistency analysis on the event may also have occurred on the NE.) The Supplier Management System further identifies the event. The list of event types consists of alarms (including Threshold Crossing Alerts), attribute value changes (including protection switching events and state changes), and network resource creation and deletion notifications.

The Supplier Management System may add data to the NE event information according to business requirements provided by the network operator. [Unable to Add Required Enhancements] For example in the case of alarm events, the Supplier Management System includes the functionality

² ITU-T Rec. X.721 provides source documentation concerning the format of enhanced information provided to other internal processes.

found within "Maintain Management Model" in order to determine what service instances (if any) are affected by the alarm condition. The addition of the data can also involve consultation with the management model in the Supplier Management System in order to determine if a service outage has occurred and the assignment of alarm severity, if this characteristic has not already been provided by the NE.

This Use Case ends when the Supplier Management System makes the enhanced information accessible to other internal functions by putting it in an event queue.

Exceptions: Corrupted Event Data, Incomplete Event Data, Unauthorized Source, Unable to Add Required Enhancements.

Post-conditions: The functions "Autodiscover NE and PlugInUnits", "Root Cause Alarm Analysis", "Root Cause Impairment Analysis", "Provide Current Event Summary Listings", "Maintain Management Model", and "Log Events" are able to consume properly formatted event records.

5.2.2.16 Profile Object Management

Summary: Once a profile object has been created in the Profile Object Repository, the Supplier Management System can process event information stating this fact and make the Profile Object settings available for use by any Use Case of the Supplier Management System. This functionality includes the ageing out and deletion of these profile settings.

Assumptions: The Supplier Management System maintains information on the syntax and permitted range of values for parameters for each profile type that it recognizes. Supplier Management Systems participating in this Use Case are instances of the same supplier application. The event channel for creation and deletion messages is the same for all profile objects. The operator has determined which Supplier Management Systems are interested consumers for event information. This assumes that the profile object type can be referenced and employed by the Supplier Management System. As required, management communications network links exist to support the publishing of profile object creation/deletion messages to the External Event Channel. Through an external specification process beyond the scope of this Use Case, the Profile Repository is knowledgeable about valid values for Profile Object attributes.

Actors: OMS, Operator, External Event Channel, White Pages, BPON NEs.

Preconditions: A Supplier Management System is installed and determined to be an interested consumer of profile object creation/deletion messages by the operator.

Description: This Use Case begins when a profile object is created in the Profile Object Repository and published to the notification channel on External Event Channel. The message from the notification channel is consumed by the Supplier Management System. [Notification Channel Link down] The message includes the Name and Type of the Profile. It also includes the attribute value listing for the specific values of the profile object instance. The Supplier Management System stores the profile Name and attribute values. In some circumstances, this may mean that the Supplier Management System writes this profile name and attribute values to the NEs within its management jurisdiction. The profile object settings are now available for use by an operator or OMS when interfacing with Supplier Management System.

If creation of the profile object occurs prior to the instantiation of the Supplier Management System, then the Supplier Management System will consult the White Pages whenever it receives a request from an operator or OMS referencing a specific profile object for the first time. Using the directory information provided in the White Pages, the Supplier Management System will locate the implementation of the Profile Object and obtain its attribute values. [Unknown Profiles] As before, the Supplier Management System stores the profile Name and attribute values. In some circumstances, this may mean that the Supplier Management System writes this profile name and attribute values to the NEs within its management jurisdiction. The profile object settings are now

available for use by an operator or OMS when interfacing with Supplier Management System without further consultation with White Pages and, in particular, for the current requested transaction.

The Supplier Management System supports the inquiry by an Operator or OMS if a particular profile is in use in the management model under the jurisdiction of the Supplier Management System. The query includes the Name of the profile object. If required, the Supplier Management System may consult with White Pages in order to locate the named profile object and determine its attribute values.

The Supplier Management System supports the ageing out of use of a particular profile object by request of an operator or OMS. [Unknown Profiles] In this case, the Supplier Management System discontinues the use of the named profile object by any external or internal interaction.

The Supplier Management System also supports deletion of all references to a particular Profile Object instance. A deletion request includes the name of the profile object. [Unknown Profiles] Based on operator inquiry, each Supplier Management System verifies that no use of the profile object is being made by any managed entity within its domain of management. [Profile In Use] This verification is accomplished by checking the management model. The Supplier Management System deletes all reference to the profile object.

This Use Case ends when the profile object parameters have been created, aged out, or deleted in the Supplier Management System.

Exceptions: Unknown Profile Type, Inconsistent Parameters, Values Not Allowed, Unknown Profiles, Profile In Use.

Postconditions: At the end of its lifecycle, the profile object is unavailable for use by any Supplier Management System. Prior to that point, the profile object is available for use by an operator or OMS when interfacing with the Supplier Management System provided it has not been discontinued from use by an ageing out request of the Operator or OMS.

5.2.2.17 Provide Current Event Summary Listings

Summary: The Supplier Management System will provide access to information showing the current value of key status and state parameters and group this information in a listing for perusal by the operator. The listings are continuously and autonomously updated by the Supplier Management System based ongoing events within the BPON NEs.

Assumptions: Lists are limited to information concerning failure conditions within the BPON NEs. This functionality might include the following: current alarm summaries, listing of successful and unsuccessful protection switching events where the protected resource is not functioning as primary, service instances currently experiencing a service outage, or managed entities whose Administrative State is "locked".

The Supplier Management System can process incoming BPON NE and operator interaction events. The Supplier Management System can correlate events and service information, can conclude that a service outage exists for a particular failure condition (considering all affecting conditions like protection switching events and that a service has indeed been provisioned), and can correlate protection group provisioning information with protection switching events. Events can come from BPON NEs or operator interaction. Operator has specified through system requirements what type of information should be handled via a current summary event list.

Actors: Operator, BPON NE, Privileged User.

Preconditions: Current listings and event queues have been initialised as the Supplier Management System is installed.

Description: This Use Case begins when events of interest are detected at the BPON NE and event information is set to the Supplier Management System. The Supplier Management System examines events indicating changes in state and status. If the variable is one tracked for a current summary event listing, the listing is consulted. If the event indicates the start of a tracked condition, information concerning the managed entity associated with the event and attribute is added to the listing along with a timestamp of the event. If the event indicates the end of a tracked condition, the listing is consulted and the most recent listing entry concerning the start of the condition is removed. Listings summarise conditions on a BPON OLT system basis.

The listing is always accessible to viewing by the operator through a graphical user interface. Changes to the listing happen autonomously without need for operator refreshing of the screen. Desired modes of presentation of the listing are determined via operator system requirements.

Operators with privileged status are allowed to resynchronize current summary event listings. Based on operator request, and after user permission is verified, the Supplier Management System retrieves the current value of the state, status, or management attribute tracked by the current summary event listing for the BPON system for any managed entity contained in the system that possesses the characteristic attribute. [Comm. Failure, Timeout] If the BPON system retrieval process shows that the listing is not up-to-date with the current conditions of the system, then the listing is modified (through deletion of an entry or insertion of a new entry) in order to correct the listing.

Listing entries are correlated with information retrieved from the system via the identifier of the managed entity. Deletion of an entry can occur if a listed managed entity no longer exists contained within the BPON system, or if a failure condition or test has ended and the system has reverted to normal functioning. If either of these situations occur, all entries concerning the same managed entity are removed from the listing. Insertion can occur when no listing entry exists for a managed entity now indicating a change in functioning.

The OMS can retrieve the contents of any current event listing by specifying the name of the listing. This Use Case ends when the listing has been properly updated.

Exceptions: Comm. Failure, Timeout.

Post-conditions: Accurate current event list information is accessible to the operator and OMS.

5.2.2.18 Provision Installed BPON Resources

Summary: Installed BPON resources are provisioned with configuration settings in anticipation of service provisioning.

Assumptions: Management communications between the Supplier Management System and the installed BPON resource is operational. In the case of the OLT, this means that the OLT has been registered. In the case of an ONT or ONU, this means that the ONT or ONU has been ranged. In the case of an NT, this means that the upstream ONU has been ranged and that management communications exists between the NT and ONU. Configuration settings may (or may not) have been previously supplied to the Supplier Management System.

Actors: BPON NE, Operator, or OMS.

Preconditions: The Operator or OMS wishes to apply configuration settings to an installed BPON resource.

Description: This Use Case begins when a BPON resource has been installed. BPON resources include BPON NEs (OLT, ONT, ONU, NT) and/or plugin units. The autodiscovery function provides the Supplier Management System with inventory data describing the type of equipment installed. The Supplier Management System automatically "builds" the BPON resource in the management model.

If the information constructed in the management model matches inventory data supplied previously to the Supplier Management System (through a "pre-provisioning" build transaction from the Operator or OMS), the Supplier Management System automatically applies to the constructed resource any additional configuration settings supplied via the previous transaction. If the information constructed in the management model does not match inventory data supplied previously to the Supplier Management System, the Supplier Management System prepares one or more event records to notify interested consumers of the mismatch.

If no previous "pre-provisioning" build transaction has taken place, then the information constructed in the management model is made available to the Operator or Provisioning OMS. The Operator or Provisioning OMS formulates a provisioning request identifying the discovered BPON resource and providing configuration settings necessary to prepare the BPON resource for use in service provisioning. The Supplier Management System applies these settings to the identified BPON resource and updates the management model appropriately. [Unknown BPON Resources].

This Use Case ends when provisioning information has been transferred (as needed) to the pertinent network resources by the Supplier Management System.

Exceptions: Unknown BPON Resources.

Postconditions: The BPON resource is ready to participate in service provisioning activities.

5.2.2.19 Provision Service

Summary: The Supplier Management System selects ports, facilities, and bandwidth from BPON resources determined to be available in order to complete the design, selection, and assignment process associated with a set of services for a particular customer. Activation of network resources occurs simultaneously provided immediate activation is required. A service is defined as a connection between a UNI endpoint on an ONT and an NNI endpoint at an OLT, or between UNI endpoints on two ONTs subtending from the same OLT.

Assumptions: The OLT is registered with the Supplier Management System. The PON interface plugin unit on the OLT may, or may not, be installed. In any case, the PON port has been built (meaning that an APON TTP, APONCTP, and APONLink have been created to associate with the PON port). The ONT may, or may not, be installed. ONT resources have been built if not installed (meaning that an APONTTP, APONCTP, APONLinkConnection, APONTrail, two APONNetworkCTPs, and two APONNetworkTTPs exist and the APONLink has been modified to include the new APONLinkConnection). Also two vpCTPs and two vpTTPs exist for the embedded operations channel as well as two tcAdaptorFs. An operator or provisioning OMS selects the endpoints. The provisioning system or operator has access to the valid/permissible range of VPI/VCI values for the NNI and UNI interfaces (through knowledge of the associated ATMNetworkAccessProfileF and the UNIInfoF). The communications channel between the Supplier Management System and OLT is up at the start of the Use Case. An instance of the ME ATMCrossConnectionControlF exists for the OLT and ONT. Resources may, or may not, have been reserved prior to this Use Case for the service connection.

Actors: OMS, Operator, BPON NEs.

Preconditions: A service request has triggered the need for a connection between an UNI endpoint on an ONT or NT and an NNI endpoint on an OLT or between two UNI endpoints of ONTs subtending from the same OLT.

Description: This Use Case begins when the OMS or Operator sends a service connection set up request to the Supplier Management System. The request includes a Service Instance Identifier, identifiers and characteristics for the endpoints (i.e. VPI and VCI values for ATM endpoints), the OLT Id, a Reservation Id (if relevant), and profile pointers that characterise the service connection desired. [Duplicate Service Instance Id] The Supplier Management System validates existence of the end points. [Unknown ONT, Unknown OLT, Unknown Port] It checks to see if the VPI/VCI

values are in use and are valid. [VPI/VCI In Use, Invalid VPI/VCI] It checks to see if resources have already been reserved against this Service Instance Id [Reservation Id Mismatch]. The Supplier Management System also validates that required network resources exist to provision this service if resources have not been reserved (e.g. bandwidth over the PON and on the designated network interface). [Insufficient Bandwidth].

When the Supplier Management System finishes the validation phase successfully, the connection between end points will be established, based on the parameters contained in the request. It changes any "reserved" resource allocations to "assigned". VpCTPs and vpTTPs are created in the OLT and ONT if no existing VPC is to be used. VcCTPs are created on the OLT and may be created on the ONT. VcTTPs are created wherever AAL 1, AAL 2, or AAL 5 is employed on the OLT or ONT. ATM cross-connections in the OLT and ONT are created. The APONLink has attributes that are modified. VcNetworkCTPs, vpNetworkCTPs, vpNetworkTTPs, vpLinkConnection(s), vpSubnetworkConnection(s), and at least one vcSubnetworkConnection are also created.

Depending on the type of service, the type of the network-side interface on the OLT, and the type of UNI, instance(s) of the following managed entities may also be created: DS1NetworkCTP, DS1NetworkTTP, DS3NetworkCTP, DS3NetworkTTP, vcNetworkTTP, VoiceNetworkCTP, VoiceNetworkTTP, DS1SubnetworkConnection, DS3SubnetworkConnection, BridgedLANNetworkCTP, BridgedLANNetworkTTP, BridgedLANSubnetworkConnection, and VoiceSubnetworkConnection. [Comm. Failure] (The creation of these managed entities follows a set of rules derived from the relationships between the Managed Entities defined in ITU-Recs. Q.834.1 and Q.834.2.) Profiles are associated with the individual end points and related termination points that are created as part of satisfying the service provisioning request. [Unknown Profiles].

At some later point, it might be necessary to modify the traffic characteristics describing the connection. In this case, a modification request is made from the Operator or OMS to the Supplier Management System that includes the Service Instance Id and a listing of pairs of service profile names (existing paired with desired new ones). [Unknown Service, Unknown Profiles] The Supplier Management System validates that required network resources exist to provision this service change (e.g. bandwidth over the PON and on the designated network interface) [Insufficient Bandwidth] and applies the new traffic profile characteristics to the service connection.

The Operator or OMS may request the removal of a service connection. In this case, the deletion request includes the service instance Id. [Unknown Service] The Supplier Management System makes resources formerly assigned to the service available for use by any subsequent connection request, modifying managed entities tracking these resource values. It also removes logical managed entities such as Network TTPs and CTPs, Link Connections, and Subnetwork Connections associated with the connection from the management model within the Supplier Management System.

This Use Case ends when the service set up, modification, or delete request completes successfully, or fails, and relevant service provisioning information has been transferred to the pertinent NE(s) as they are installed.

Exceptions: Insufficient Bandwidth, Unknown Port, Unknown OLT, Unknown ONT, Unknown NT, Unknown Profiles, Comm. Failure, Reservation Id Mismatch, VPI/VCI In Use, Unknown Service, Duplicate Service Instance Id, Unknown Reservation Id, Invalid VPI/VCI.

Postconditions: Connection information is available to be applied to (eventually) installed BPON network resources. Service activation occurs automatically once physical resources are installed.

5.2.2.20 Publish BPON Event

Summary: On receipt of processed configuration, performance, or fault event information provided by other Use Cases within the Supplier Management System and based on rules concerning

publication, the Supplier Management System queues and channels event information to all interested consumers, including Operators and OMS(s).

Assumptions: Management communications channels are available between the Supplier Management System and interested consumers (users and systems) allowing the transfer of event information. The actual notification mechanisms are dependent on the communications protocol and can range from trap-directed polling, to publishing, to specific event channels, to directing of event messages to individual consumers based on a discriminator construct filter. Details of the autonomous mechanisms are outside the scope of the Use Case although implemented on the Supplier Management System. Operator business rules have been implemented in the Supplier Management System describing the event data that should be immediately transferred to upstream OMS(s) or Operators. Relationships between event type and suitable notification channels have also been implemented.

Actors: External Event Channel.

Preconditions: The Supplier Management System formats an event record.

Description: This Use Case begins when the Supplier Management System becomes aware of the creation of an event record from an internal process. Event records can be created because of Profile Object creation, Profile Object deletion, Managed Entity creation, Managed Entity deletion, alarms, threshold crossing alerts in performance monitoring, and attribute value changes, including, but not limited to, changes in state and status variables, circuit pack removal from slots, and protection switching occurrences.

The Supplier Management System applies business rules provided by operator requirements to determine whether or not the event record is of interest to any consumers. If the event record is not of interest to any consumers, it is discarded. If the event record is qualified for immediate transfer, the Supplier Management System provides the event record information to the notification mechanism implemented on the Supplier Management System that is specific to the communications protocol in use between the Supplier Management System and any interested event consumer. [Comm. Failure] In some cases there may be multiple notification channels, in which case the Supplier Management System will also determine the channels to be used. [Can Not Determine Channel].

This Use Case ends when the event record has been successfully transferred to an External Event Channel.

Exceptions: Comm. Failure.

Post-conditions: The event information is available for use by the Operator or OMS.

5.2.2.21 Range ONT/ONU

Summary: Based on the installation or replacement of an ONT or ONU, the Supplier Management System directs the OLT to range a subtending ONT or ONU.

Assumptions: The OLT has been installed and is equipped with a PON interface card. The DCN is working between the Supplier Management System and OLT. The OLT supports ranging as described in ITU-T Rec. G.983.1. The ONT or ONU has been installed and is equipped with power. The OLT PON interface card has been installed and provisioned, so APON TTP, APON CTP, physicalPathTPF, and APONLink already exist for the OLT PON interface port. There is an ODN connection between the OLT PON interface port and the ONT (or ONU). Ranging can be accomplished without use of service demand information.

The Supplier's manufacturing process control prevents the possibility of duplicate serial numbers. The Supplier Management System may support rules concerning serial number syntax and the maximum number of subtending ONT or ONUs on any OLT PON interface card port.

Actors: Operator, OMS, and BPON NE (OLT).

Preconditions: An ONT or ONU has been installed.

Description: This Use Case begins when the Supplier Management System obtains the serial number for a newly installed ONT or ONU. The serial number may be provided from an operator or OMS, or through an automatic protocol detection mechanism. If the serial number is associated with a newly established ODN connection, and the serial number is provided through a request from the Operator or OMS, the requests includes the OLT User Label, the PON interface card port Id, the ONT/ONU User Label, and the ONT/ONU serial number. [Unknown OLT, Unknown PON Port] If the serial number is automatically detected, the Supplier Management System needs only to be supplied with the ONT/ONU User Label.

The Supplier Management System directs the OLT to range the new subtending ONT or ONU based on its serial number. [Invalid Serial Number, No Response, Duplicate ONT-ONU User Label, Insufficient PON Bandwidth, Max Subtending Nodes Exceeded, Equipment Failure, Invalid User Label Syntax] This ranging activity calculates the optical distance between the OLT and ONT/ONU, establishes security mechanisms, sets up the upstream time slot for the ONT/ONU, assigns an index number for the ONT/ONU, and establishes the VCC for the embedded operations channel between the OLT and ONT/ONU. The latter action establishes management communication between the Supplier Management System and the ONT/ONU and new node and service provisioning can commence. The Supplier Management System associates the ONT (or ONU) with an index number. It also associates the User Label supplied on the request with the index number and the ONT (or ONU) Managed Entity Id.

If the serial number involves an ONT or ONU replacement, the operator or OMS request includes the OLT User Label, the PON interface card port Id, the ONT/ONU serial number, and the ONT/ONU index number. [Invalid Serial Number, No Response, APON Layer Failure, Equipment Failure, Unknown PON Port] If the new serial number is automatically detected through the protocol, existing values for these attributes are applied.

Existing service connections are automatically downloaded to the replacement NE as well as associations to User Label.

The operator may change the traffic descriptor profile used to establish the EOC by making a request to the Supplier Management System identifying the desired traffic descriptor profile name. [Unknown Profiles].

This Use Case ends when the ONT or ONU has been ranged successfully and all pertinent managed entities have been built in the Supplier Management System.

Exceptions: Invalid Serial Number, No Response, Unknown OLT, Unknown Profiles, APON Layer Failure, Duplicate ONT_ONU User Label, Insufficient PON Bandwidth, Max Subtending Nodes Exceeded, Equipment Failure, Invalid User Label Syntax, and Unknown PON Port.

Post-conditions: The ONT or ONU is ready for further provisioning as an installed network and is capable of supporting autodiscovery.

5.2.2.22 Register OLT

Summary: The management communications channel between the Supplier Management System and OLT is verified and the OLT is registered for management by the Supplier Management System.

Assumptions: The OLT is installed. The power supply is working. An operator-defined name (OLT User Label) and DCN Address (e.g. IP Address) have been configured on the installed OLT via local craft interface or some factory provisioning mechanism. Registration takes less than one minute. The DCN connection has been installed and configured. A check of DCN connectivity times-out from the Supplier Management System if no response from the remote end is received

within 10 seconds. If privileged user status is required for the Provisioner, access control mechanisms have been verified in advance of this Use Case.

Actors: Operator (Provisioner), OMS, BPON NE (OLT).

Preconditions: The Operator wishes to manage the OLT via the Supplier Management System application.

Description: This Use Case begins when the network provisioner requests that a Supplier Management System build a new OLT within its management domain. The request includes the DCN Address associated with the OLT and an OLT User Label. The request may also include references to topological and geographical map coordinates. [Too many OLTs, Duplicate OLT User Label] The Supplier Management System stores the address, label, and map information and checks the DCN connection between itself and the OLT. [DCN Timeout] The Supplier Management System establishes application layer to application layer communications between itself and the OLT and verifies this communication by retrieving the OLT User Label. [Denied Access, Cannot Retrieve User Label, Address/Label Mismatch] The Supplier Management System then assigns an OLTid (Managed Entity Id) to the OLT thus exercising its role as manager of the OLT. [Cannot Assign OLTid].

The Supplier Management System responds to the registration request with the OLT User Label and OLT Id. Upon request of the OMS or operator, the Supplier Management System can change the DCN Address of an OLT belonging to its management domain. In this situation, the request includes the OLT User Label, the old DCN Address, and the new DCN Address. The Supplier Management System verifies the old DCN address [Address/Label Mismatch], checks the DCN connection between itself and the OLT using the new DCN Address [DCN Timeout] and verifies management capabilities by retrieving the OLT User Label. [Denied Access, Cannot Retrieve OLT User Label].

This Use Case ends when the Supplier Management System has added the OLT to its domain of management and has established an application association with the OLT.

Exceptions: DCN Timeout, Too Many OLTs, Cannot Assign OLTid, Cannot Retrieve User Label, Denied Access, Address/Label Mismatch, Duplicate OLT User Label.

Post-conditions: As long as the OLT is registered with the Supplier Management System it is available for management by the operator through the Supplier Management System.

5.2.2.23 Reserve Resources Before Dispatch

Summary: The Supplier Management System supports reservation of bandwidth pending installation of an ONT, ONU, NT, or subscriber port in the ONT or NT for a particular OLT prior to the dispatch of personnel to the ONT, ONU, or NT installation location. This function includes cancel and modification of resource reservation.

Assumptions: The Supplier Management System may support rules concerning the maximum number of subtending ONT on any OLT PON interface card port for the OLT. The OLT has been provisioned as well as the relevant PON interface slot and NNI slot. The Supplier Management System has an accurate view of current network resources for a specific OLT, including installed, assigned, and reserved resources. CAC calculation capability is supported either by an installed OLT or by the Supplier Management System. Slot assignments do not change within this Use Case.

A GUI exists and supports operator bandwidth and capacity reservations. Similarly, a mechanised interface exists to support upstream OS reservation of bandwidth and capacity. Appropriate DCN communications between the Supplier Management System, GUI clients, upstream OMS(s), and OLT are available as needed at the start of the Use Case. Reservation of bandwidth is supported on a per service instance basis (implying the eventual creation of a subnetwork connection).

Actors: Operator, OMS, BPON NE (OLT).

Preconditions: A work order has been issued to install a new ONT or NT or a new subscriber line card or port in an existing ONT or NT triggered by a service request.

Description: This Use Case begins when an operator or OMS receives a work order to install a new ONT, a new ONU, a new NT, or a new subscriber line card in an existing NT or ONT. The operator or OMS formulates a reservation of bandwidth request including serving OLT User Label, EquipmentHolderFid and Port Number for the desired PON interface, appropriate ATM Network Access Profile, and service information to associate with the bandwidth or capacity reservation. The service information includes Service Instance Id, OLT and ONT/ONU traffic descriptor profile references, OLT Overbooking Factor. [Unknown Profiles] The Supplier Management System processes the information provided on the request and performs the following:

- verifies network resource identifiers [Unknown OLT, Duplicate Service Instance Id, Unknown PON Port];
- accesses a CAC calculation mechanism to determine whether there is sufficient bandwidth in the OLT to admit the service [Insufficient Bandwidth];
- uses connection counts, grant bandwidth metrics, and port line bit rate information to determine whether there is sufficient capacity on the OLT (includes ODN limitations) and on the prospective interfaces of the OLT to satisfy the service demand [Max Subtending Nodes Exceeded, Connection Count Exceeded];
- reserves bandwidth, capacity, and connections [Comm. Failure];
- makes association of reserved resources to Service Instance Id;
- provides the Reservation Id to the requesting operator (or Provisioning system) as identification for the reserved resources.

The operator or OMS makes requests until reservation of all resources in the OLT required for the installation of the ONT, NT, or port/circuit pack is finished.

The Supplier Management System shall also support requests by the operator provisioning OMS to cancel reserved resources. The operator or OS references the Reservation Id with the cancel request. [Unknown Reservation Id] The Supplier Management System releases all network resources whose reservation is tagged by the Reservation Id.

The Supplier Management System shall support requests by the operator or provisioning OMS to modify a reservation. In this case, the modification request includes the Reservation Id along with information having the same data structure as the original reservation request. [Unknown Reservation Id] The Supplier Management System releases the reserved network resources identified by the Reservation Id and follows the same procedure outlined above in associating the Reservation Id with a new set of network resources raising similar exceptions if required. The Supplier Management System shall also support retrieval of a Reservation Id given a Service Instance Id value originally provided with a successfully completed reservation request. [Unknown Service Instance].

This Use Case ends when reservation of bandwidth, connections, and other capacity metrics is completed and reservation information has been transferred as needed to the pertinent NE(s). The reservation Id is also made available for reuse by the Supplier Management System.

Exceptions: Unknown OLT, Unknown PON Port, Insufficient Bandwidth, Max Subtending Nodes Exceeded, Connection Count Exceeded, Duplicate Service Instance Id, Unknown Service Instance, Unknown Reservation Id, Comm. Failure, Unknown Profiles.

Post-conditions: Bandwidth, connections, and capacity are marked as "reserved" in any subsequent capacity inventory reporting and dedicated for future provisioning activities for the identified service instance.

5.2.2.24 Root Cause Alarm Analysis

Summary: When there is an occurrence of a set of alarms associated with a single failure condition, the Supplier Management System shall analyse and correlate the alarm events within its domain to the best of its ability and determine the underlying root cause of the problem. It prepares an alarm record for the root cause failure condition for forwarding to OMS(s) and Operators. If root cause is not determined, the Supplier Management System prepares a set of alarm records for publication to OMSs and Operators.³

Assumptions: One failure condition in a BPON network resource may result in many alarm events from multiple managed entities. Multiple alarm events occurred at approximately the same time. These events were already evaluated and validated by the Supplier Management System ("Process Incoming NE Events") and shown to possess enough information for alarm analysis purposes. The Supplier Management System maintains a management model containing (in part) dependency relationships between managed resources including unmonitored resources. Redundant alarm events are eliminated.

Actors: No external actors.

Preconditions: Multiple failure conditions have been detected by a BPON NE within a short period of time.

Description: This Use Case begins when multiple incoming alarm events have been processed by the Supplier Management System within a small period of time. The Supplier Management System groups together related alarm events into an event set for direct comparison or patterning. Event sets are created via rules determined by managed entity dependency relationships. The Supplier Management System engages in an event comparison process with the goal of finding one active, underlying, independent event for the event set. The process starts with the first alarm event in the event set and compares the next event to see if one of them may be eliminated through rules of event correlation. The process continues until all events in the event set have been processed. If the comparison process detects an event that cannot supersede or be superseded by a previous event, it will be combined with remaining previous events. The result of this comparison process is either determination of a single root cause failure condition or a filtered set of alarm events.

Dependencies are relationships between equipment components and/or transmission media determined by the topology of the network, client-server associations, and cross connections. Patterning may be done recursively to infer trouble with a resource such as a conduit or power supply from indications in many indirectly supported resources. State change information also plays a role in alarm event correlation. There are several types of failure conditions: equipment failures, communications failures, processing errors, environmental concerns, and security violations. There can be dependencies and causality relationships between different types of failure conditions.

Communication alarms may be triggered by an equipment fault. Therefore, if an equipment alarm is received, all communication alarms for termination points contained by the equipment component should be superseded. That is, communication alarms are only considered when they occur without related equipment alarms. If no equipment alarms related to the trail are received, but communication alarms are received, then the cause of the fault might be outside of the Supplier Management System management domain, might be due to some unmonitored equipment component within its domain, or might arise from the transmission medium that carries the characteristic signal between the BPON NEs. In this case, the upstream communication alarm might be considered the best root cause information within the Supplier Management System domain.

Environmental alarms should be given high priority in searching for root cause since they point to problems for entire BPON nodes or all NEs at a given location (i.e. they relate to many equipment

³ This Use Case description makes significant use of management functionality described in [17].

components and many trails). State changes can also serve as a backup method of detecting faults. Administrative and operational state changes should be treated like equipment alarms, since they always indicate a change in the ability of a resource to fulfil its function. The details of alarm event correlation are left up to the individual Supplier Management System.

This Use Case ends when a root cause has been determined, or when an event set has been filtered to the greatest extent possible. The alarm information is formatted in records and made available to interested consumers.

Exceptions: None known at this time.

Postconditions: Root cause alarm information has been formatted and is available to be transferred to interested consumers.

5.2.2.25 Root Cause Impairment Analysis

Summary: When there is an occurrence of a set of Threshold Crossing Alerts associated with a single performance degradation condition, the Supplier Management System shall analyse and correlate the alert events within its domain to the best of its ability, determine the underlying root cause of the problem, and store this information in a log. If several occurrences of the same root cause impairment are detected within a period of time, the Supplier Management System shall prepare a QoS alarm record for publication by any interested consumer (Operator or OMS).

Assumptions: One impairment condition in a BPON network resource may result in the notification of multiple TCA events associated with multiple managed entities. Multiple TCA events occurred at approximately the same time. These events were already evaluated and validated by the Supplier Management System ("Process Incoming NE Events") and shown to possess enough information for impairment analysis purposes. The Supplier Management System maintains a management model containing (in part) dependency relationships between managed resources including unmonitored resources. Redundant TCA events are eliminated. The Supplier Management System shall support the collection of performance monitored parameters including, but not limited to, those listed as History Data managed entities.

Actors: Operator or OMS.

Preconditions: Multiple impairments have been detected on a BPON NE within a short time window.

Description: This Use Case begins when multiple incoming TCA events have been processed by the Supplier Management System within a small period of time. The Supplier Management System groups together related TCA events into an event set for direct comparison or patterning. Event sets are created via rules determined by managed entity dependency relationships. The Supplier Management System engages in an event comparison process with the goal of determining one active, underlying, and independent priority impairment for the event set.

The process starts with the first TCA event in the event set and compares the next event to see if one of them may be eliminated through rules of event correlation (see below for some filtering rules). The process continues until all events in the event set have been processed. If the comparison process detects an event that cannot supersede, or be superseded by, a previous event, it will be combined with remaining previous events. The result of this comparison process is either determination of a single root cause impairment condition or a filtered set of TCAs.

Dependencies are relationships between equipment components and/or transmission media determined by the topology of the network, client-server associations, and cross connections. With the exception of physical interface termination points on the subscriber plugins, the Supplier Management System shall collect only near-end performance monitored parameters. The Supplier Management System shall suppress the processing and reporting of TCA on trails when the trails have an active failure condition. For each TCA, the Supplier Management System shall filter out

any downstream near-end and far-end TCAs relating to the same direction of transmission for lower level trails served by the trail generating the TCA. For a set of TCAs involving the same parameter for the same trail, the Supplier Management System shall filter out all but the first TCA received during the interval of collection. TCAs may be further filtered according to precedence within each History Data parameter category.

At the end of the precedence and comparison filtering process, the Supplier Management System shall support tagging of the remaining TCAs. If a particular TCA persists for X intervals within a window of Y collection intervals (where X and Y are settable), the TCA will be called a persistent root cause impairment. The Supplier Management System shall notify all interested clients of any such persistent filtered root cause impairments using a Quality of Service Alarm and providing the necessary information including Managed Entity Id, Performance Parameter, Threshold Value, and Observed Value.

The Supplier Management System supports Operator or OMS setting of X and Y values for each thresholded performance parameter monitored in the BPON NE. X and Y values can be modified per monitoring point type or per monitoring point instance. [Unknown Instance, Unknown Type, Total Too Large, Min Greater Than Total, Invalid Monitored Parameter] This Use Case ends when root cause impairment information has been formatted in a record.

Exceptions: Unknown Instance, Unknown Type, Total Too Large, Min Greater Than Total, Invalid Monitored Parameter.

Postconditions: Root cause impairment information available for notification to all interested consumers.

5.2.2.26 Scheduler

Summary: The Supplier Management System provides a scheduler function for activities to be carried out at a later date. The operator or OMS can create a new schedule, view a schedule, and delete or modify an existing schedule if it is not in use.

Assumptions: A communication link exists between the Operator or OMS and the Supplier Management System. The Supplier Management System has authenticated the Operator or OMS to access the scheduling function.

Actors: Operator or OMS.

Preconditions: The operator or OMS wishes to create a new schedule to associate with a scheduled activity of the Supplier Management System and devises a reasonable set of trigger times.

Description: This Use Case begins when the OMS or Operator initiates a request to create a new schedule, or to modify/delete an existing schedule if it is not in use. To create a new schedule, the following parameters are included: schedule name, start and stop times for when the schedule can be applied, schedule trigger point times, and iteration value. [Duplicate User Label, Matrix Scheduler Type Mismatch, Invalid Start Time, Invalid Stop Time] (If the value is 1, it means one time only, but the iteration value can also be daily, weekly, monthly, yearly.) Once the schedule is created, operator can initiate request to schedule an activity such as NE MIB uploading, bulk transfer, testing, or software downloading by referencing the schedule name. The scheduled activity is in pending mode prior to the trigger time, and in progress mode until it is successfully (or unsuccessfully) completed.

The Scheduler supports the operator's need to delete or modify an existing, but not in use, schedule. [Unknown Scheduler, Schedule In Use, Invalid Start Time, Invalid Stop Time, Matrix Scheduler Type Mismatch, Race Condition] The Supplier Management System also supports the operator's need to suspend or resume activities via reference to the schedule. [Scheduler Already Suspended, Scheduler Already Active, Unknown Scheduler].

The Operator can view the content of all or individual created schedules by providing the name list. [Unknown Scheduler] The Operator is allowed to suspend a scheduled activity by locking the administrative state of the associated schedule. [Unknown Scheduler, Scheduler In Use].

This Use Case ends when a schedule has been created, modified, or deleted.

Exceptions: Unknown Scheduler, Schedule In Use, Duplicate User Label, Unknown Archive, Race Condition, Matrix Scheduler Type Mismatch, Invalid Start Time, Invalid Stop Time, Scheduler Already Suspended, Scheduler Already Active.

Postconditions: At least one of the following holds: a new schedule is created, an existing schedule is modified or deleted, scheduling details are displayed, all activities with the same schedule are displayed, or a pending scheduled event(s) is cancelled.

5.2.2.27 Service Outage Reporting

Summary: When a network outage occurs, the Supplier Management System should be able to detect it based on incoming alarms and events, identify affected services and BPON resources, generate service outage records and report the outage to the OMS or Operator.

Assumptions: The Supplier Management System establishes a proper channel to receive incoming alarms/events. It also establishes the proper channel to the OMS to report possible outages. The Supplier Management System has the necessary information about the services and BPON resources that it manages. It also contains proper logic to detect outage and affected service/resources based on incoming alarms/events.

Actors: BPON NE.

Preconditions: Events reflecting possible network outage are detected by the BPON NE.

Description: This Use Case begins when the Supplier Management System receives NE event information reflecting a possible network outage. The Supplier Management System proceeds with root cause analysis in an attempt to determine the fundamental cause of the failure. It also accesses events from the alarm event queue and protection switching event queue for the affected BPON NE in order to determine whether or not the network outage is service affecting. If so, the Supplier Management System consults with the management model in order to identify the service instances that have been affected by the network outage and creates a service outage event record for each instance affected. Each service outage record shall include identification of the affected service, values of relevant state attributes, cause of outage, outage start time. The Supplier Management System posts the outage event record to a current listing for such outages. The operator can view the current listing of service outages using a GUI, and the OMS receives the same information via an explicit request.

Later, when event information indicating the clearing of the network outage is received and processed by the Supplier Management System, the Supplier Management System removes the outage event information from the current listing, appends the outage stop time to the record, and records the enhanced record in a log on the Supplier Management System.

This Use Case ends when expanded outage record has been posted to the log.

Exceptions: None known at the moment.

Postconditions: Service outage records are available for retrieval by the OMS from the log.

5.2.2.28 View Record Set

Summary: The Supplier Management System will provide means to view all logged events or other records archived temporarily at the Supplier Management System. It will also provide a way to retrieve a subset of records for transfer to an OMS.

Assumptions: Any access control for monitoring of archived records on the Supplier Management System is executed prior to this Use Case. Selection filters have been specified and implemented.

Actors: Operator and OMS.

Preconditions: The Operator or OMS wishes to review records archived on the Supplier Management System.

Description: The Operator or OMS first identifies the type of record sets that are currently maintained on the Supplier Management System and, from this, chooses the record set desired for review. A request is sent to the record set to obtain all, or part of, the records held by the record set. The selection criteria may include such parameters as:

- Managed Entity Id.
- Time interval.
- Record Type.

The record set will process the retrieval request and find the records contained in the record set that meet the selection criterion. [No Such Records] The list of records will be returned to the operator. [Timeout].

The OMS may query for the size of any existing record set. [Unknown Archive].

This Use Case ends when the contents, or size information, has been provided to the requesting operator or OMS.

Exceptions: Timeout, No Such Records, Unknown Archive.

Post-conditions: The records are available for reviewing by the operator on the GUI, or for processing by the OMS.

5.3 Analysis

Detailed class, sequence, and state change diagrams will be offered only for those situations where an interface to an external actor exists, or for those cases that these details are necessary to explain behaviour. Each section of the analysis begins with a high-level view of the classes involved in the high-level Use Case diagrams of 5.2.1.3 with details of specific Use Cases following this summary. This is followed by references to any managed entities (the management information data structures from [11] and [12]) that may be involved in the Use Case. In some cases, the references to managed entities is followed by a listing to "management support entities" referring to familiar entities from existing ITU-T Recommendations. Next follows signatures for any real time operations between an external actor and the Supplier Management System. This information is accompanied by a brief description of each exception raised by the operations listed. Finally, the reader may assume that every operation is atomic except where indicated as "best effort".

5.3.1 Access Control

The following simplified class diagrams show interactions between actors and classes internal to the Supplier Management System when administering user access to the Supplier Management System.

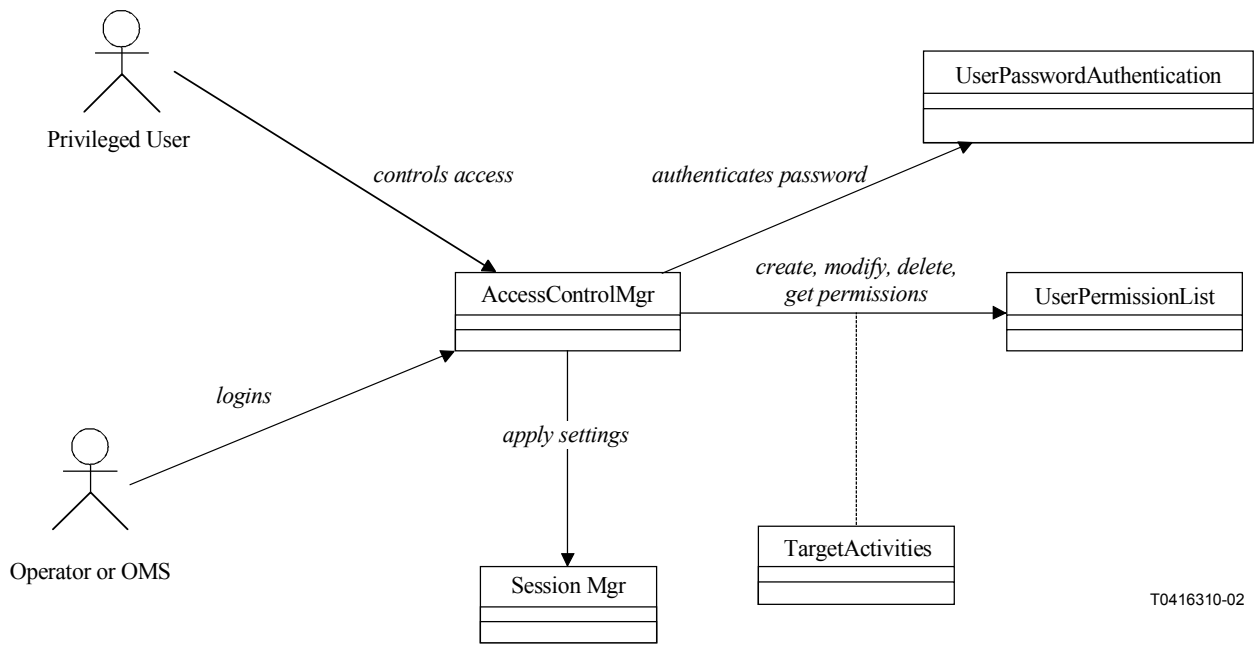

T0416310-02

Figure 5-12/Q.834.3 – Access Control Classes

5.3.1.1 Administer User Privileges

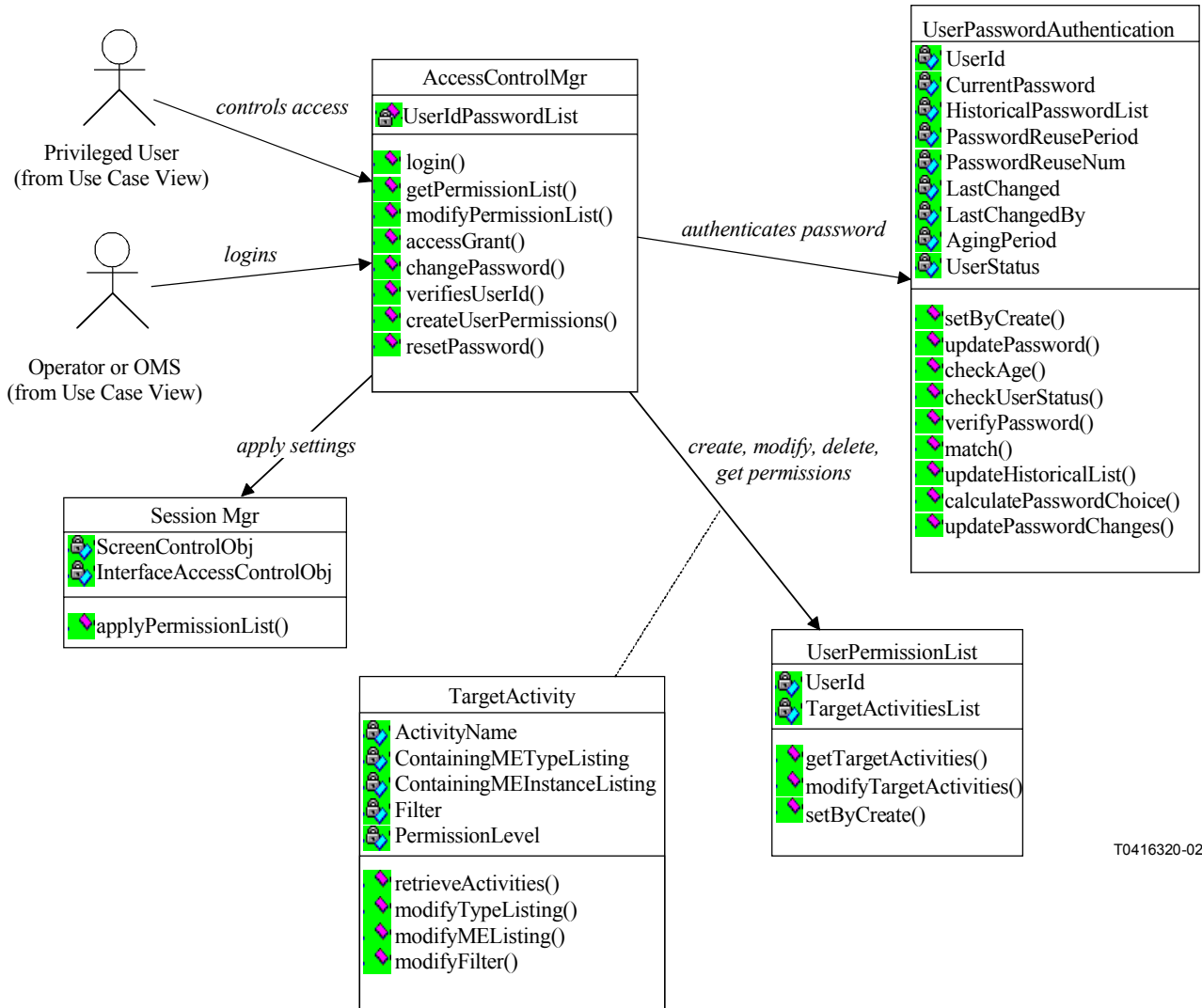

T0416320-02

Figure 5-13/Q.834.3 – Administer User Privileges Class diagram

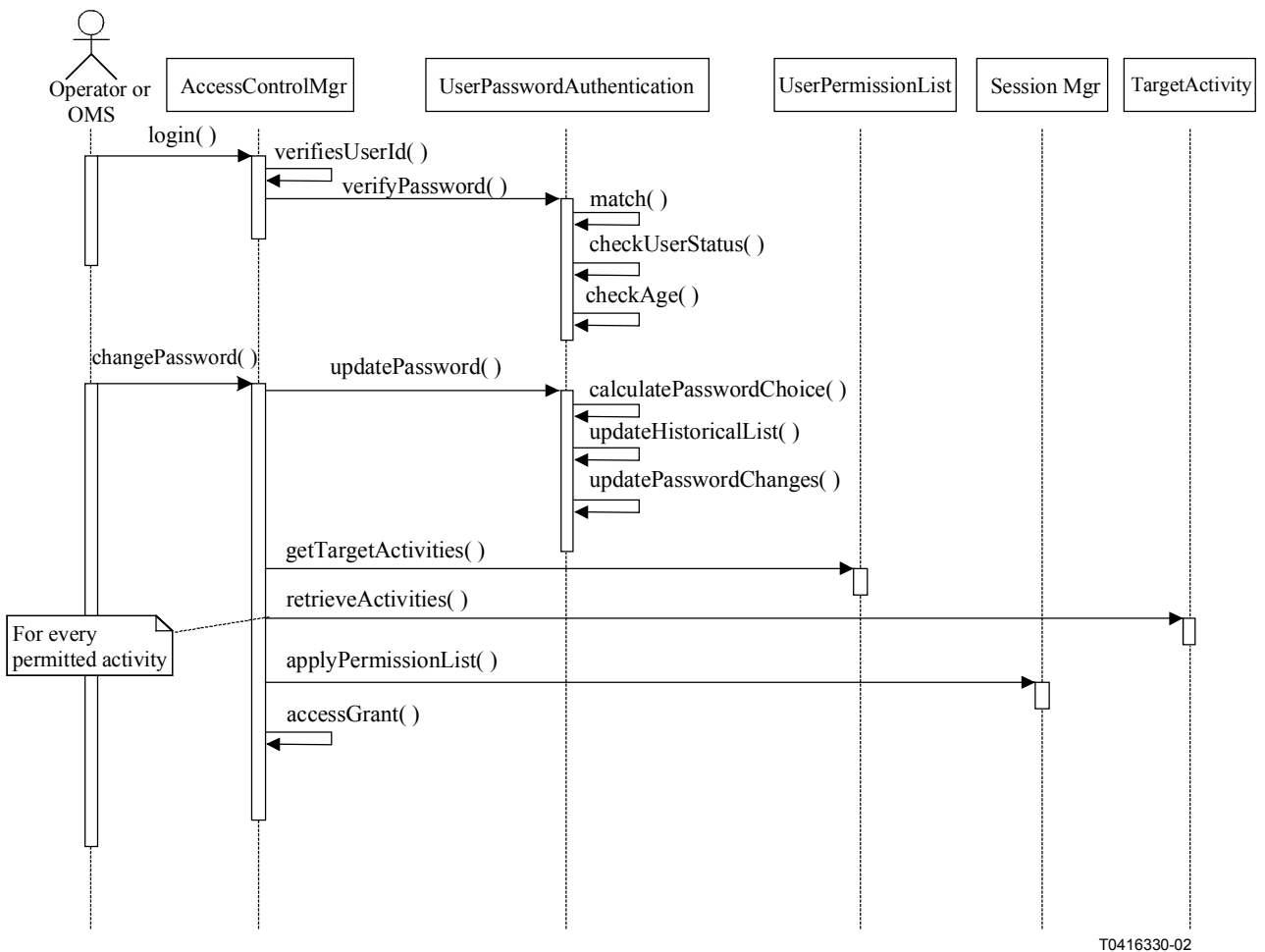
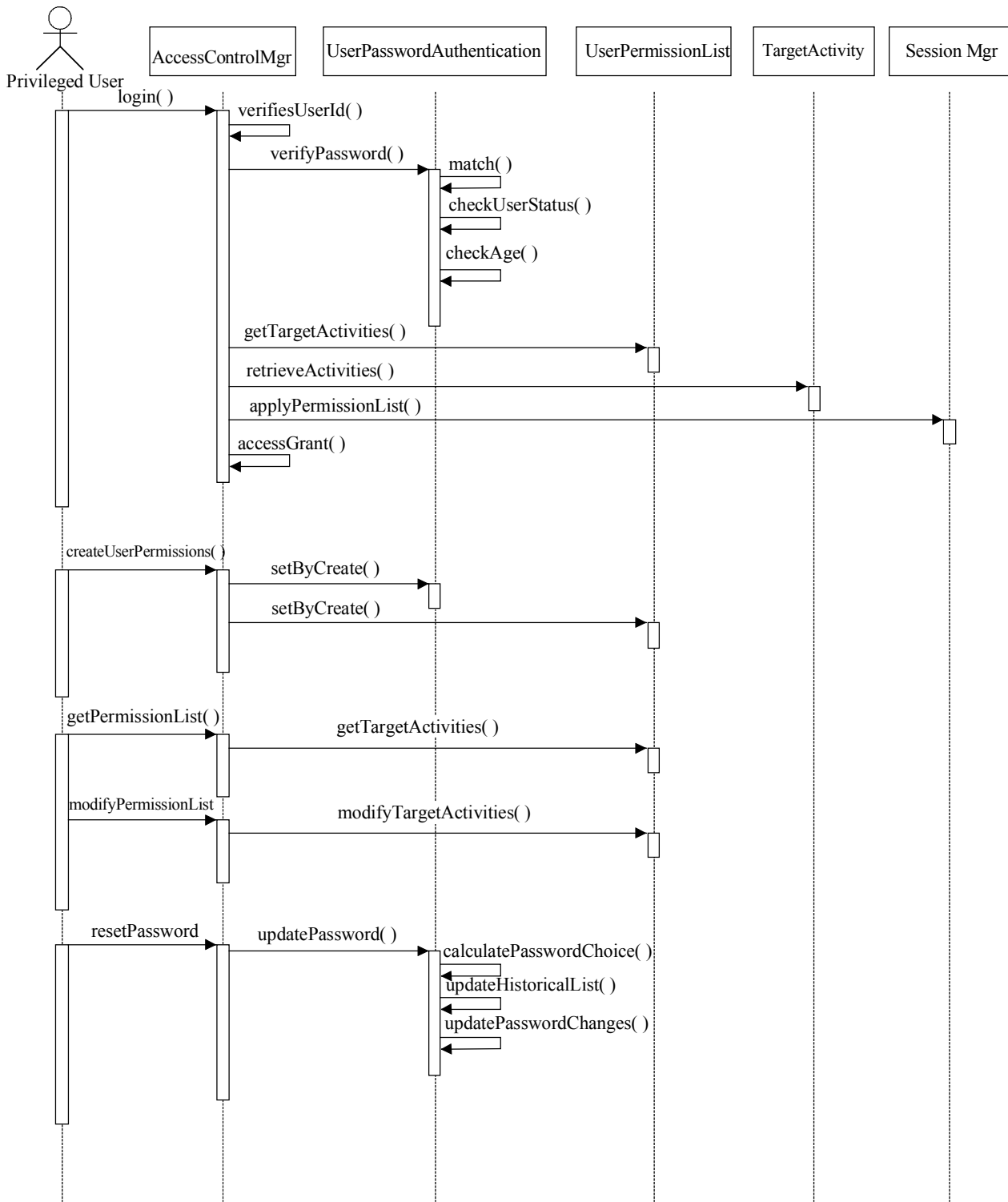

Figure 5-14/Q.834.3 – User Login Sequence diagram



T0416340-02

Figure 5-15/Q.834.3 – Administer User Permissions Sequence diagram

Managed Entities: References not yet provided by [11] or [12].

Management Support Entities: TargetActivity, UserPasswordAuthentication.

Operations:

Operation Name	Input Parameters	Return Value	Exceptions
1) login	UserId Password	PasswordAgingStatus	Unknown User Id Access Denied
2) changePassword	UserId CurrentPassword NewPassword	void	Algorithm Failed
3) resetPassword	UserId NewPassword	void	Algorithm Failed
4) createUserPermissions	UserId TargetAdditions	Creation Status	Duplicate User Id Unknown Targets
5) getPermissionList	UserId	TargetActivities	Unknown User Id
6) modifyPermissionList	UserId TargetAdditions TargetDeletions	TargetActivities	Unknown User Id Unknown Targets

Exceptions:

Exception Raised	Description
Unknown User Id	User is unknown to the Supplier Management System.
Algorithm Failed	Password offered fails definition constraints.
Duplicate User Id	Access control profile has already been established for this User Id.
Incorrect Targets	List of unknown target activities.
Access Denied	System is not granted access to this interface object.

5.3.2 Event Handling

The following simplified class diagram show interactions between external actors and classes internal to the Supplier Management System when events are processed in the Supplier Management System. This diagram serves to consolidate and provide consistency to the subsequent diagrams found within this clause.

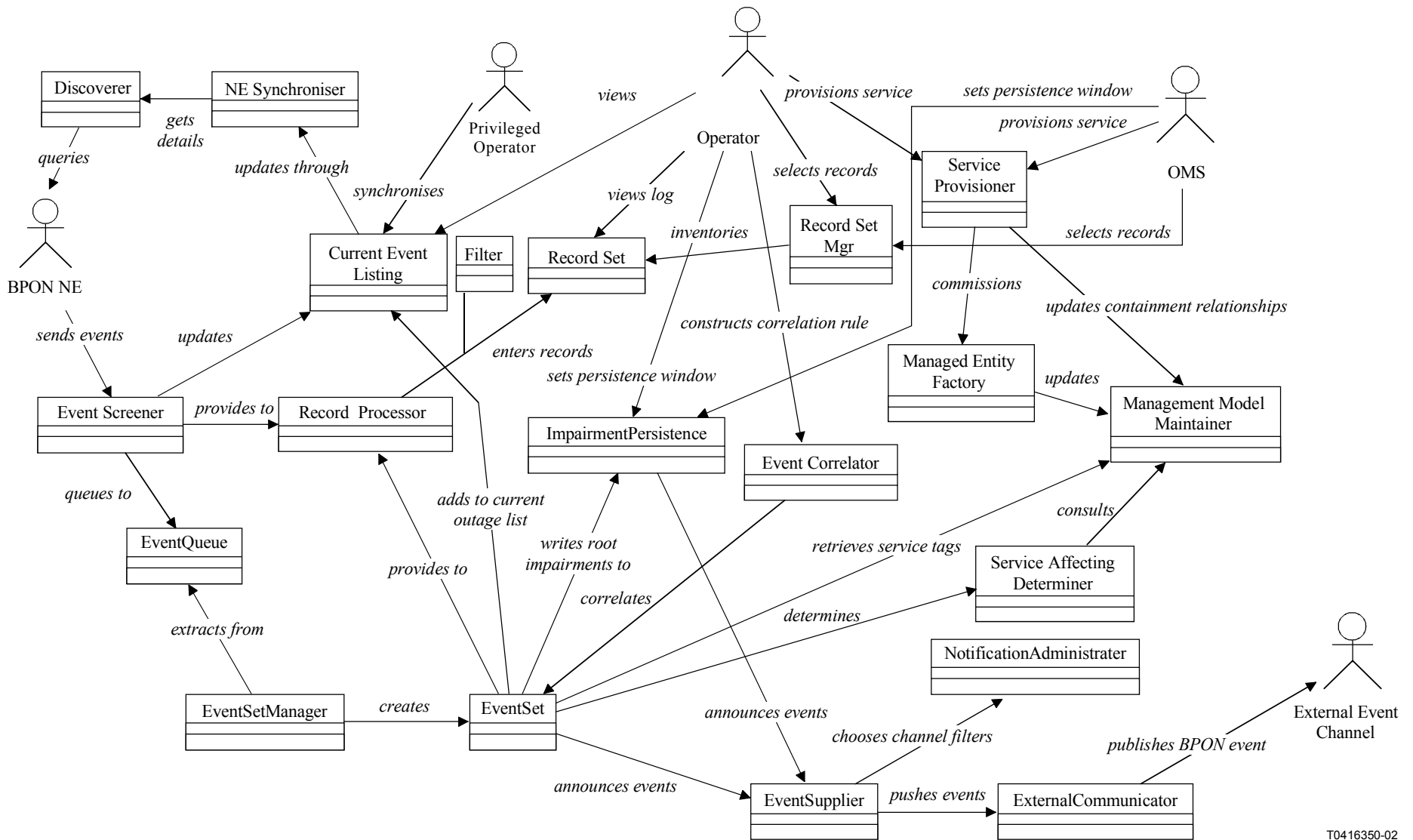

T0416350-02

Figure 5-16/Q.834.3 – Event Handling Class diagram

5.3.2.1 Log Event

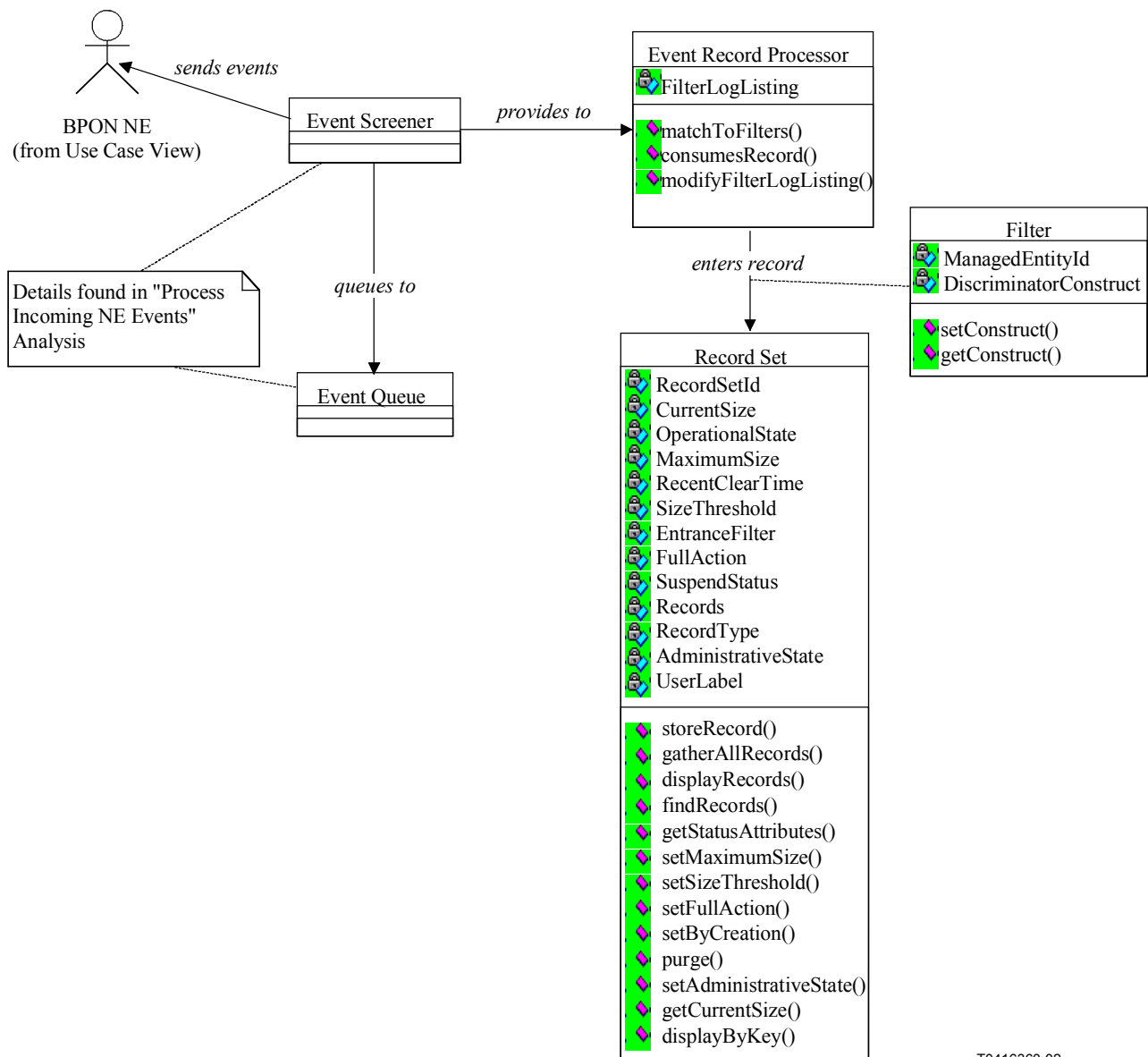

Figure 5-17/Q.834.3 – Log Event Class diagram

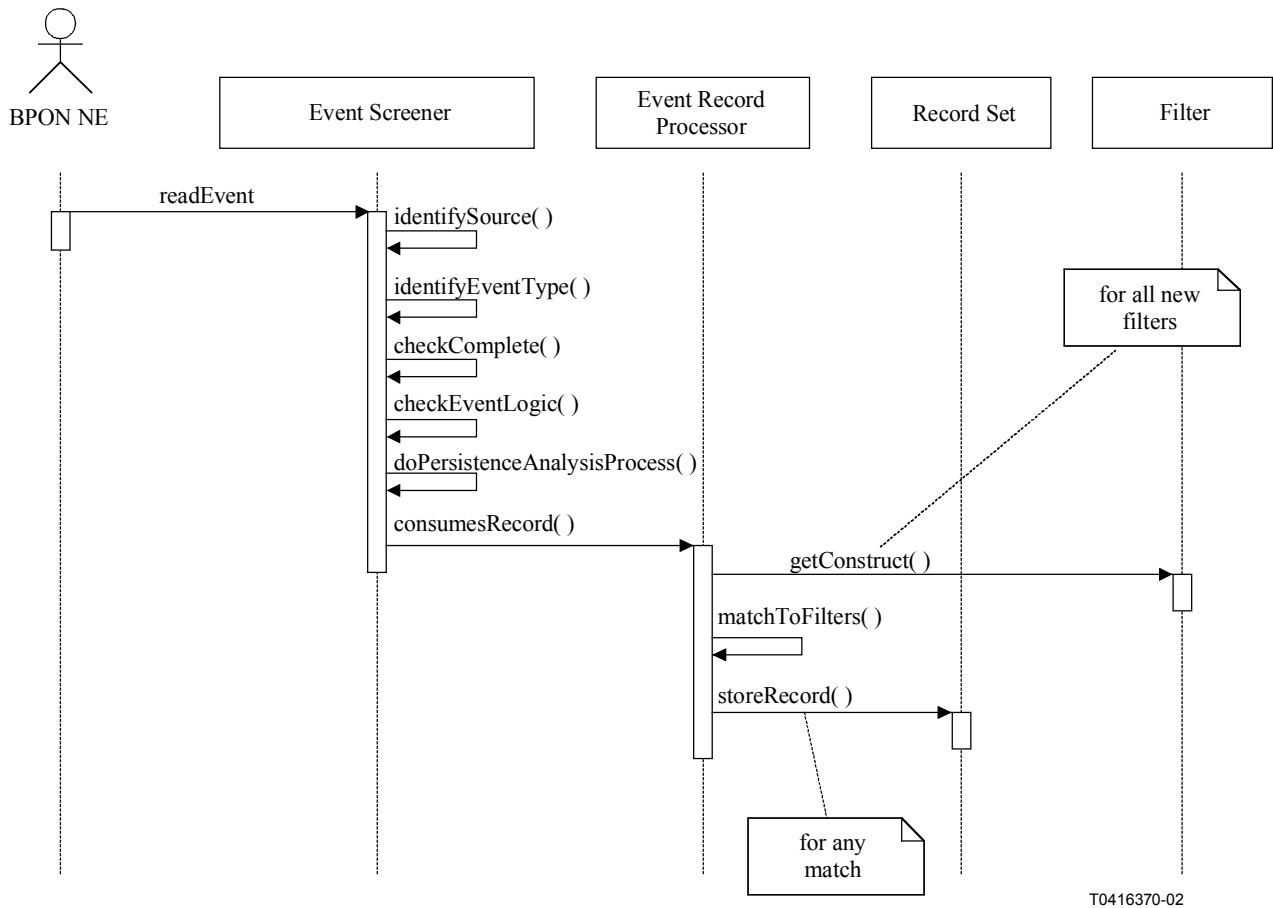

Figure 5-18/Q.834.3 – Log Event Sequence diagram

Managed Entities: logF, alarmLogRecordF, managedEntityCreationRecordF, managedEntityDeletionRecordF, attributeValueChangeRecordF, filterProfileF.

5.3.2.2 Process Incoming NE Events

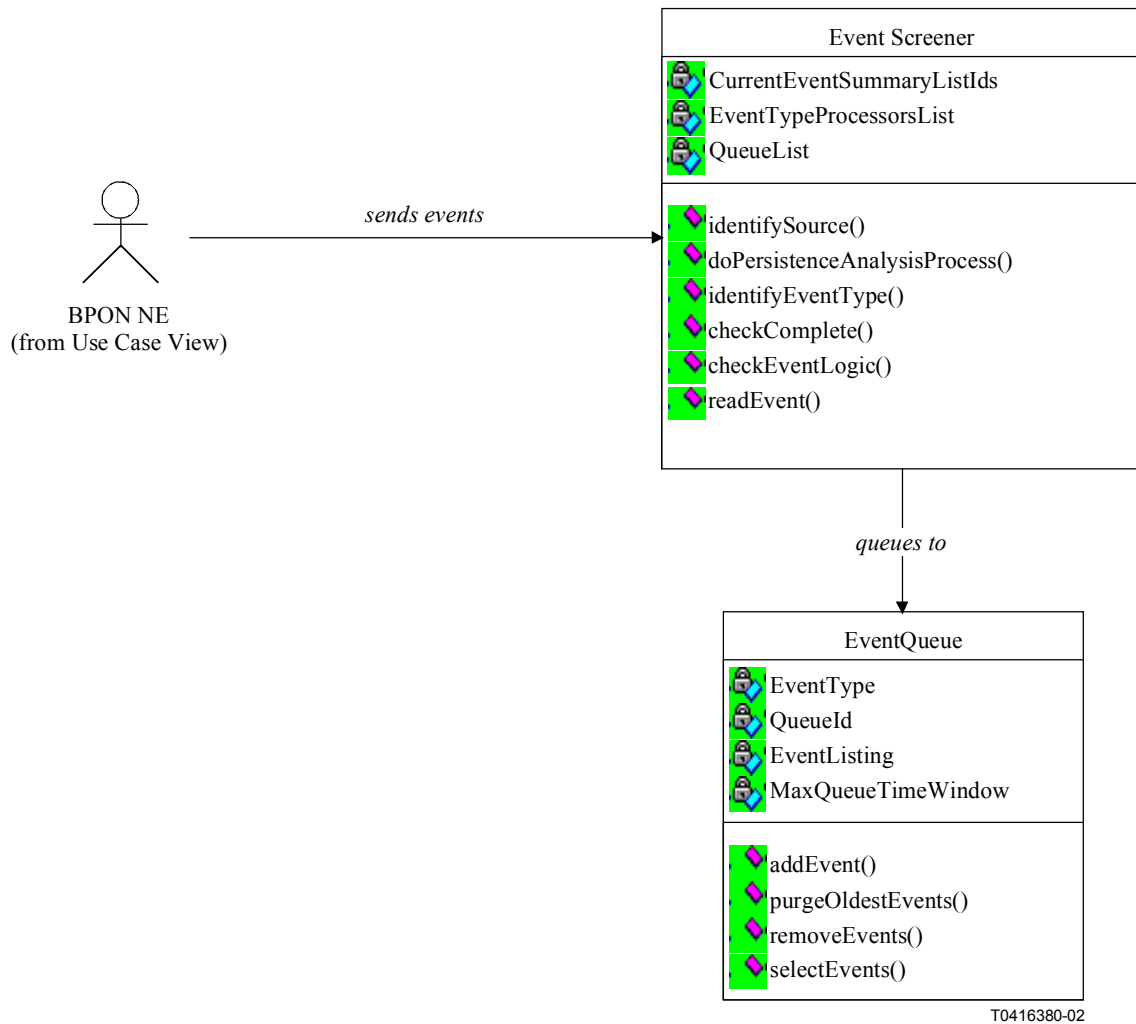

Figure 5-19/Q.834.3 – Process Incoming NE Events Class diagram

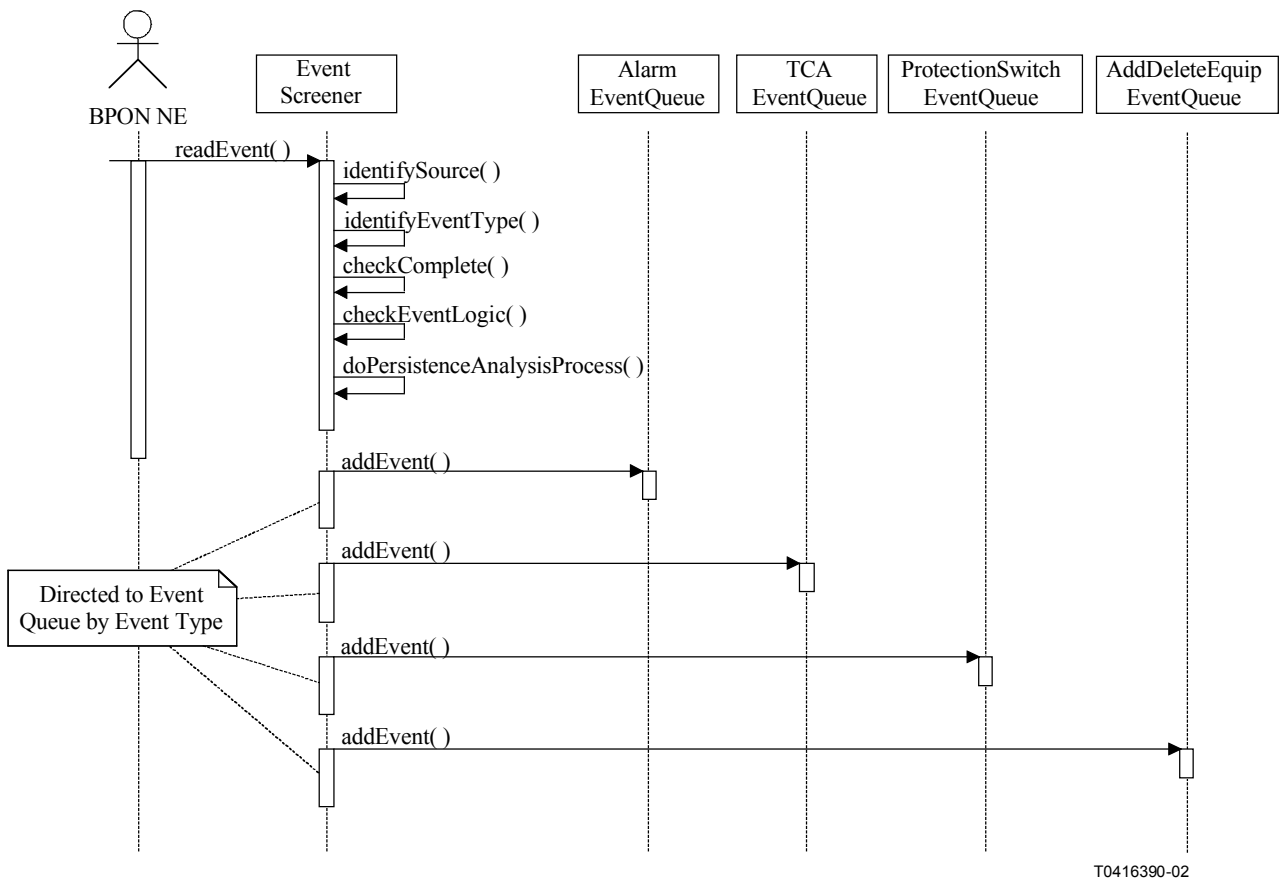

Figure 5-20/Q.834.3 – Process Incoming NE Events Sequence diagram

Managed Entities: alarmLogRecordF, alarmSeverityAssignmentProfileF, APONTTP, adslTTPF, vdslTTPF, cellBasedTTPF, E1TTPF, E3TTPF, msTTPF, rsTTPF, v3TTPF, v4TTPF, linkConnectionF, DS1TTPF, DS1CTPF, DS3TTPF, physicalPathTPF, plugInUnitF, OLT, ONT, ONU, NT, equipmentHolderF, vcCTPF, vpTTPF, vpCTPF, tcAdaptorF, VoiceTTPF, and vcTTPF, networkCTPF, networkTTPF, subnetworkConnectionF, subnetworkF, trailF, ATMCrossConnectionF, ATMCrossControlF, filterProfileF, logF, softwareF.

5.3.2.3 Provide Current Event Summary Listings

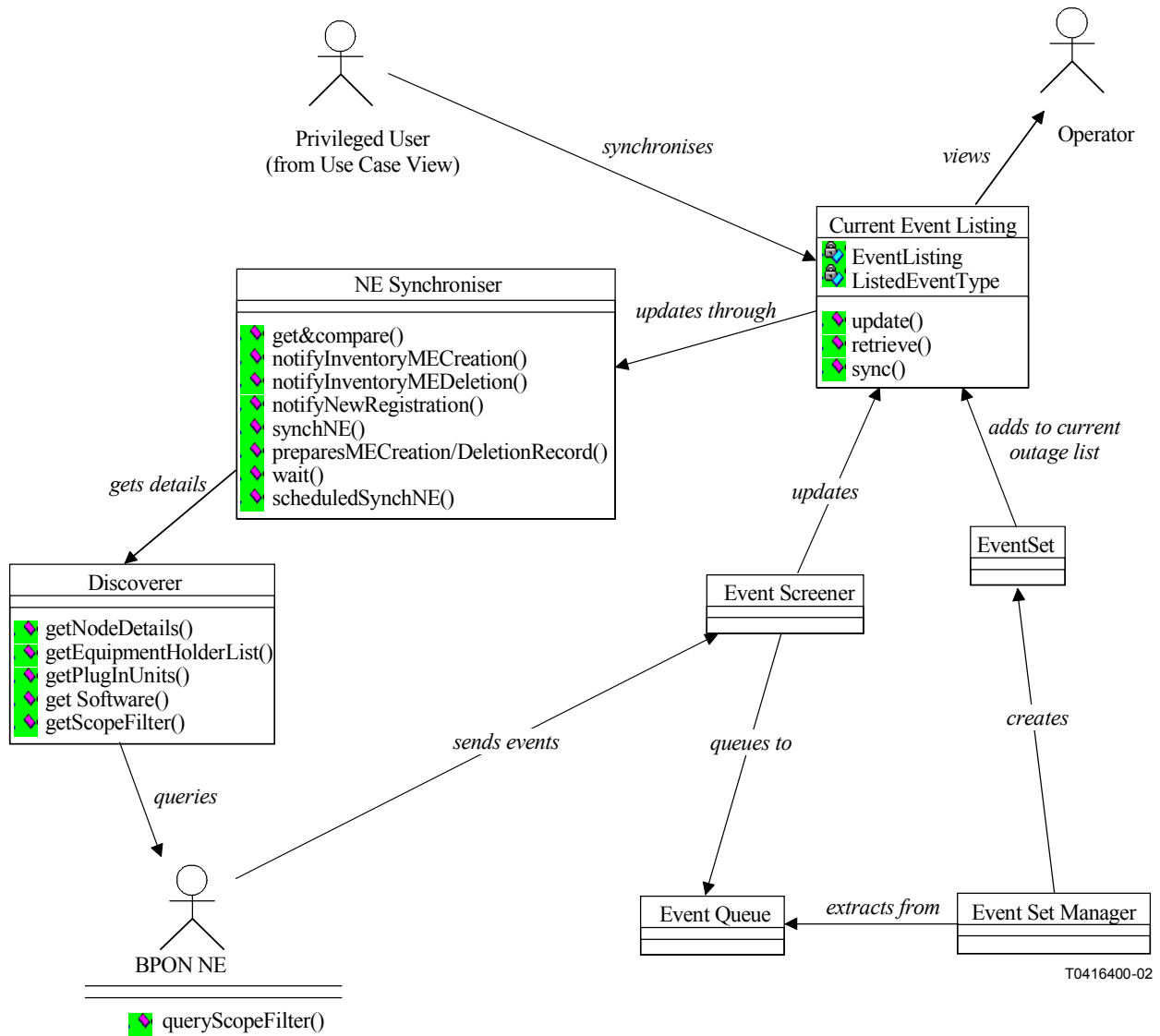

Figure 5-21/Q.834.3 – Provide Current Event Listing Class diagram

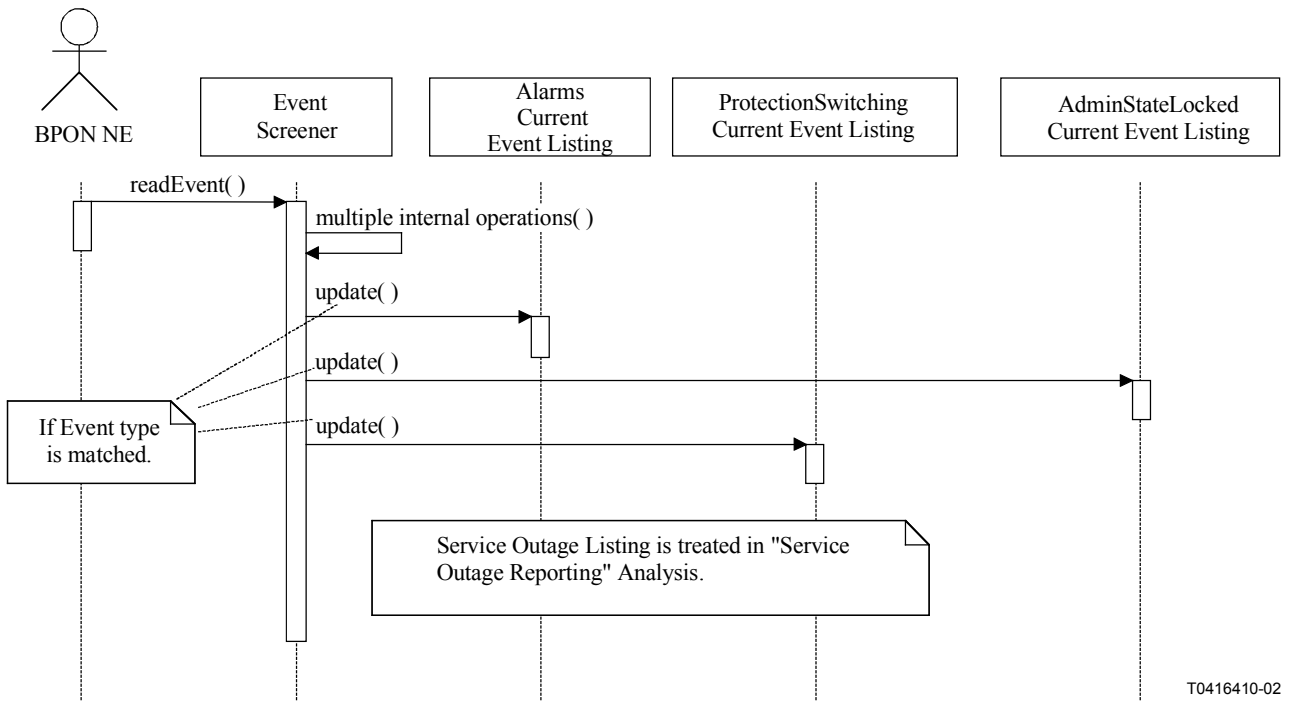

Figure 5-22/Q.834.3 – Update Current Event Listing Sequence diagram

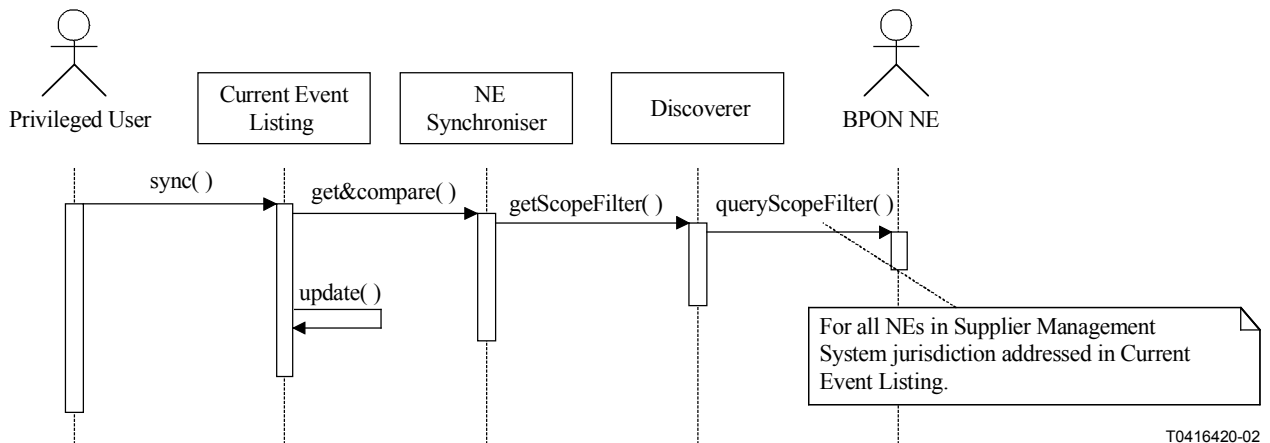

Figure 5-23/Q.834.3 – Synchronize Current Event Listing Sequence diagram

Managed Entities: alarmLogRecordF, attributeValueChangeRecordF.

Operations⁴:

Operation Name	Input Parameters	Return Value	Exceptions
1) synch	NA	CurrentEventListingWithSuspect Flag	Comm. Failure Timeout

⁴ The "synch" operation is a best effort attempt. If the results are suspect as detected by the Supplier Management System, then the Suspect Flag is set to TRUE.

Exceptions:

Exception Raised	Description
Comm. Failure	The DCN communications link between at least one of the BPON NEs and the Supplier Management System fails while the current state or status information is being transferred.
Timeout	The DCN communications link between at least one of the BPON NEs and the Supplier Management System is so congested that current state or status information cannot be transferred within a system defined synch time.

5.3.2.4 Publish BPON Event

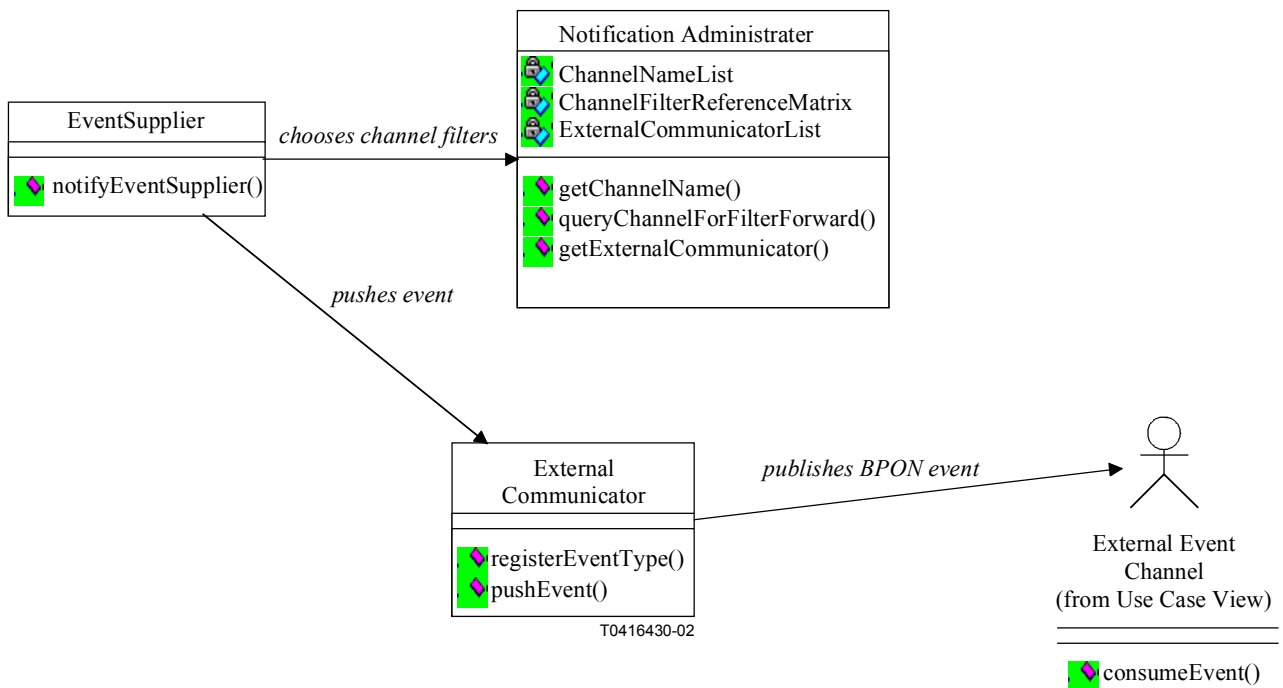

Figure 5-24/Q.834.3 – Publish BPON Event Class diagram

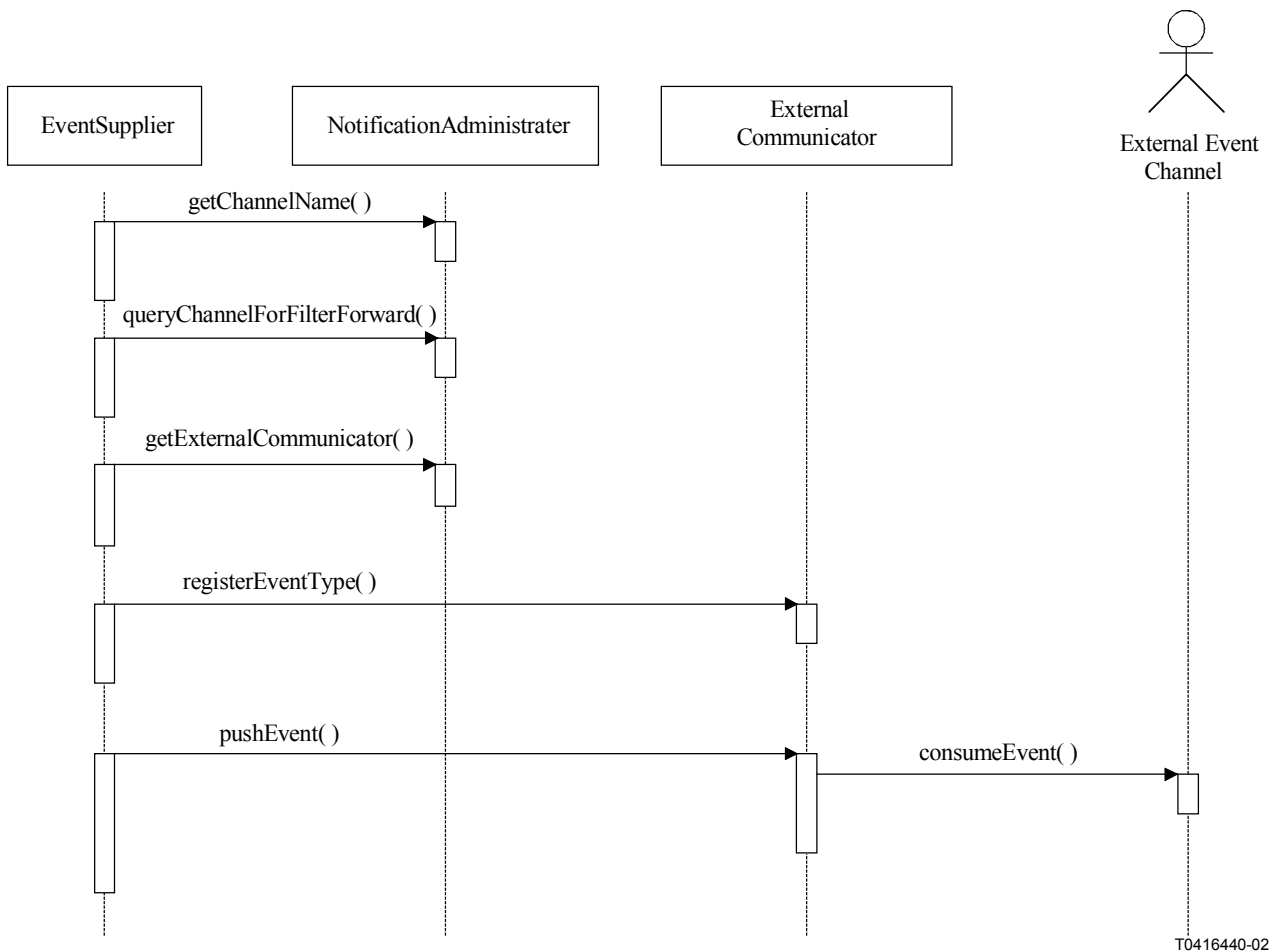

Figure 5-25/Q.834.3 – Publish BPON Event Sequence diagram

Managed Entities: ObjectCreationRecord, ObjectDeletionRecord, alarmLogRecordF, managedEntityCreationRecord, managedEntityDeletionRecord, attributeValueChangeRecordF.

Operations:

Operation Name	Input Parameters	Return Value	Exceptions
1) consumeEvent	Event Object	SuccessIndication	Comm. Failure

Exceptions:

Exception Raised	Description
Comm. Failure	The DCN communications link between the External Event Channel and the Supplier Management System fails while the event information is being transferred

5.3.2.5 Root Cause Alarm Analysis and Root Cause Impairment Analysis

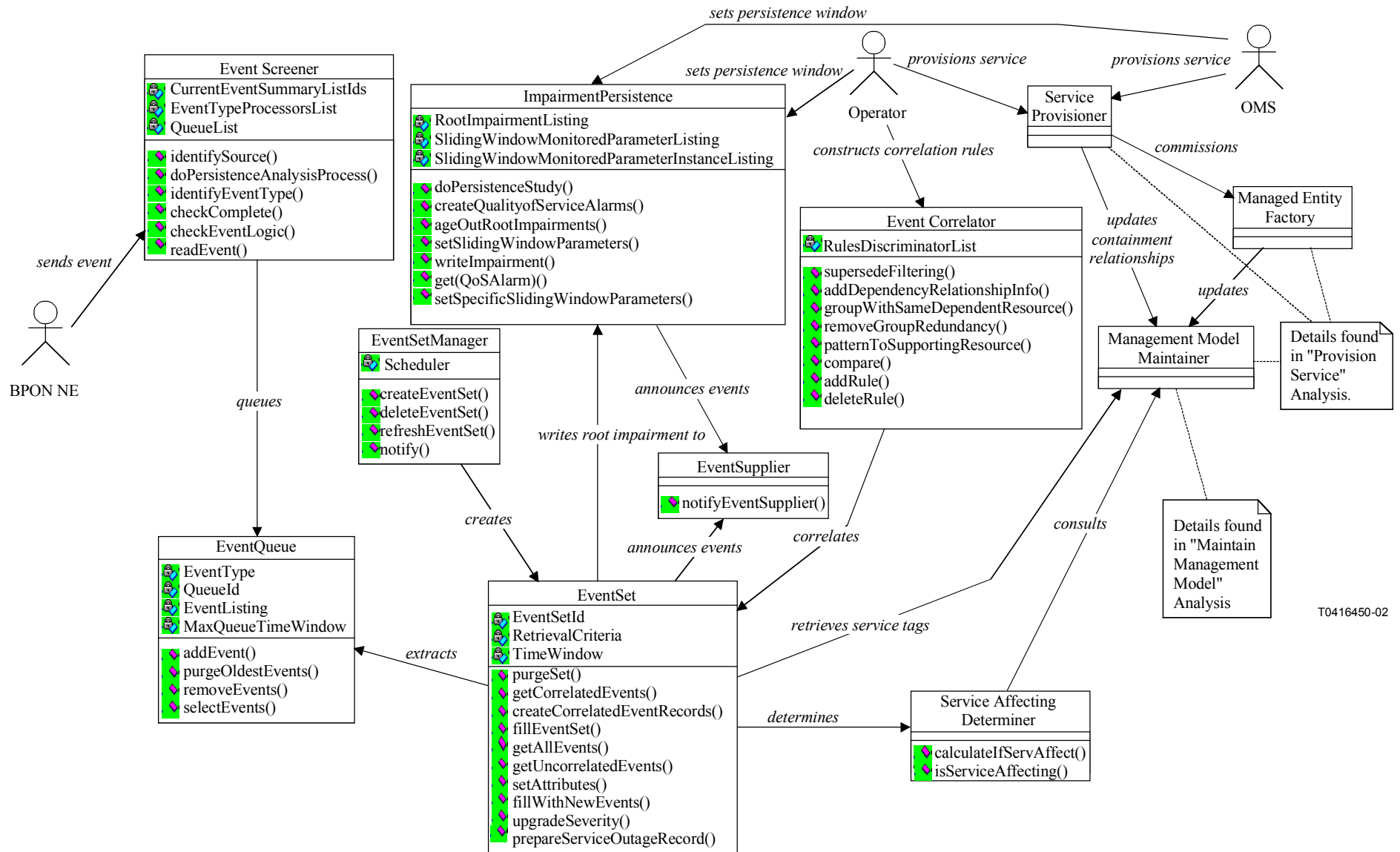

T0416450-02

Figure 5-26/Q.834.3 – RCA and RCIA Class diagram

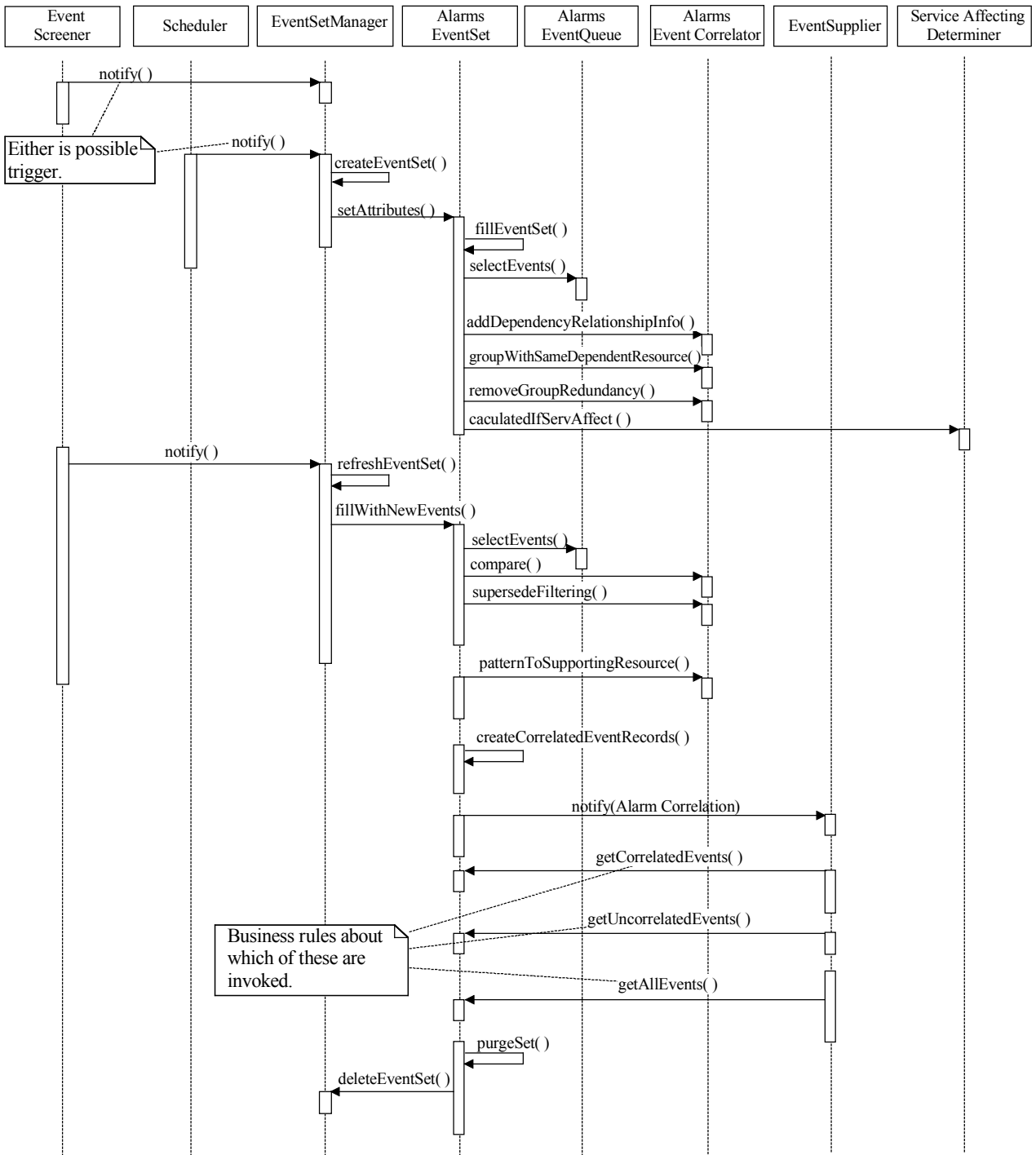

T0416460-02

Figure 5-27/Q.834.3 – RCAA Sequence diagram

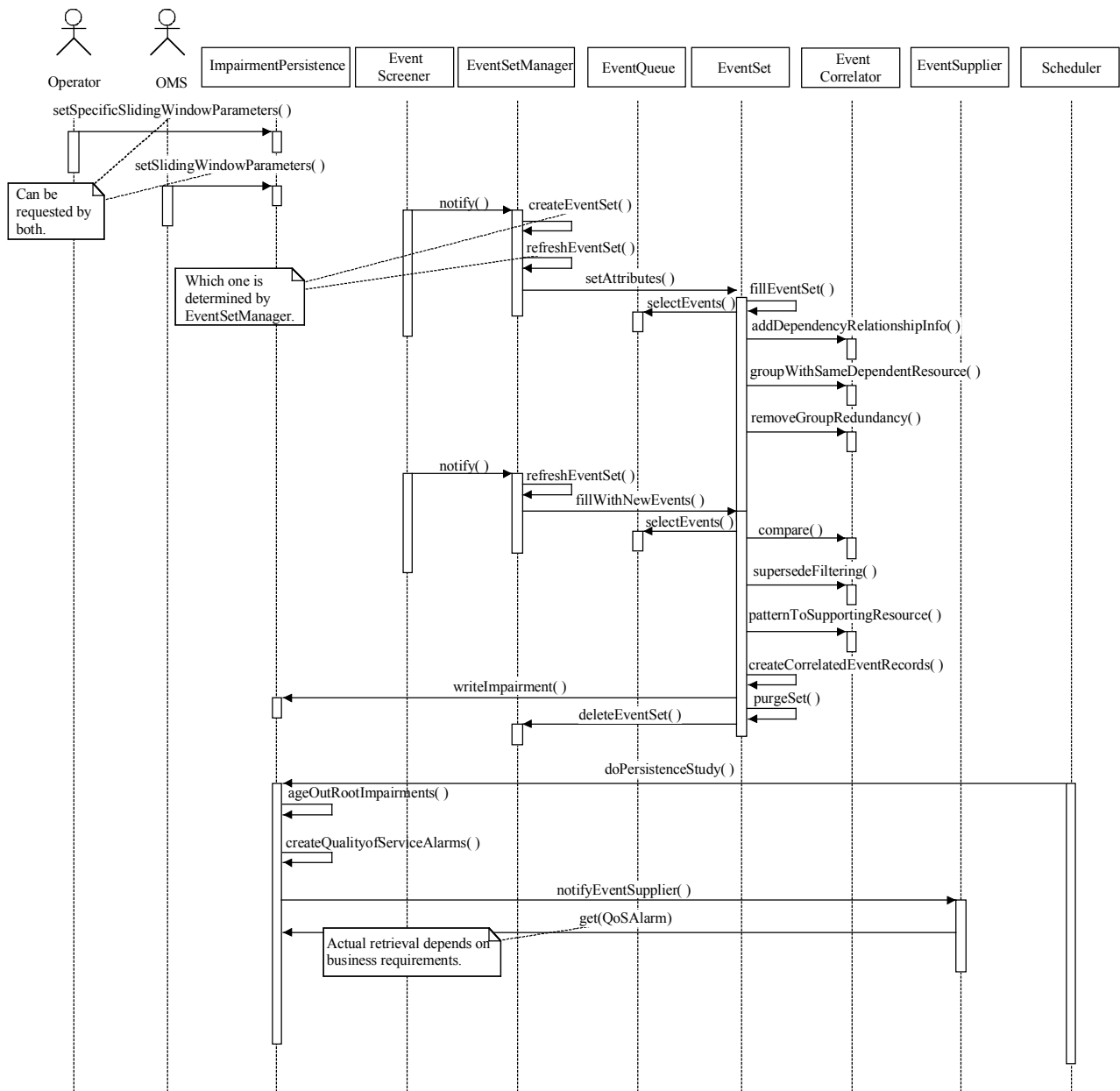

T0416470-02

Figure 5-28/Q.834.3 – RCIA Sequence diagram

Managed Entities: AAL1PMCurrentDataF, AAL1PMHistoryDataF, AAL2PMCurrentDataF, AAL2PMHistoryDataF, AAL5PMCurrentDataF, AAL5PMHistoryDataF, APONPMCurrentData, APONPMHistoryData, ATMTrafficLoadCurrentDataF, ATMTrafficLoadHistoryDataF, thresholdDataF, DS1PMCurrentDataF, DS1PMHistoryDataF, DS3PMCurrentDataF, DS3PMHistoryDataF, E1PMCurrentDataF, E1PMHistoryDataF, E3PMCurrentDataF, E3PMHistoryDataF, EthernetPMCurrentDataF, EthernetPMHistoryDataF, MACBridgePMCurrentDataF, MACBridgePMHistoryDataF, MACBridgePortPMCurrentDataF, MACBridgePortPMHistoryDataF, upcNpcDisagreementPMCurrentDataF, upcNpcDisagreementPMHistoryDataF, voicePMCurrentDataF, voicePMHistoryDataF, vpvcpmCurrentDataF, vpvcpmHistoryDataF, alarmLogRecordF, alarmSeverityAssignmentProfileF, APONTTP, ads1TTPF, vds1TTPF, cellBasedTTPF, E1TTPF, E3TTPF, msTTPF, rsTTPF, v3TTPF, v4TTPF, linkConnectionF, DS1TTPF, DS1CTPF, DS3TTPF, physicalPathTTPF, plugInUnitF, OLT, ONT, ONU, NT, equipmentHolderF, vcCTPF, vpTTPF, vpCTPF, tcAdaptorF, VoiceTTPF, and vcTTPF, networkCTPF, networkTTPF,

subnetworkConnectionF, subnetworkF, trailF, ATMCrossConnectionF, ATMCrossControlF, filterProfileF, logF, softwareF.

Operations⁵:

Operation Name	Input Parameters	Return Value	Exceptions
1) setSlidingWindowParameters	MonitorPointType MonitoredParameter TotConsecutiveIntvls PersistenceMinimum	void	Unknown Type Total Too Large Min. Greater Than Total Invalid Monitored Parameter Access Denied
2) setSpecificSlidingWindow-Parameters	MonitorPointInstance MonitoredParameter TotConsecutiveIntvls PersistenceMinimum	void	Unknown Instance Total Out of Range Min. Greater Than Total Invalid Monitored Parameter Access Denied

Exceptions:

Exception Raised	Description
Unknown Type	The monitoring point provided on the request is unknown to the Supplier Management System.
Total Too Large	The Supplier Management System is unable to perform persistence studies spanning these many intervals of collection.
Min. Greater Than Total	Y is less than X, so the sliding window definition is invalid.
Invalid Monitored Parameter	The specified parameter cannot be monitored at the monitoring point type.
Unknown Instance	The monitoring point instance provided on the request is unknown to the Supplier Management System.
Access Denied	System is not granted access to this interface object.

⁵ The "set" operations listed above modify (overwrite) an existing X,Y sliding window specification. If no such specification exists for the monitored parameter, then the "set" operations are viewed to be additional specifications.

5.3.2.6 Service Outage Reporting

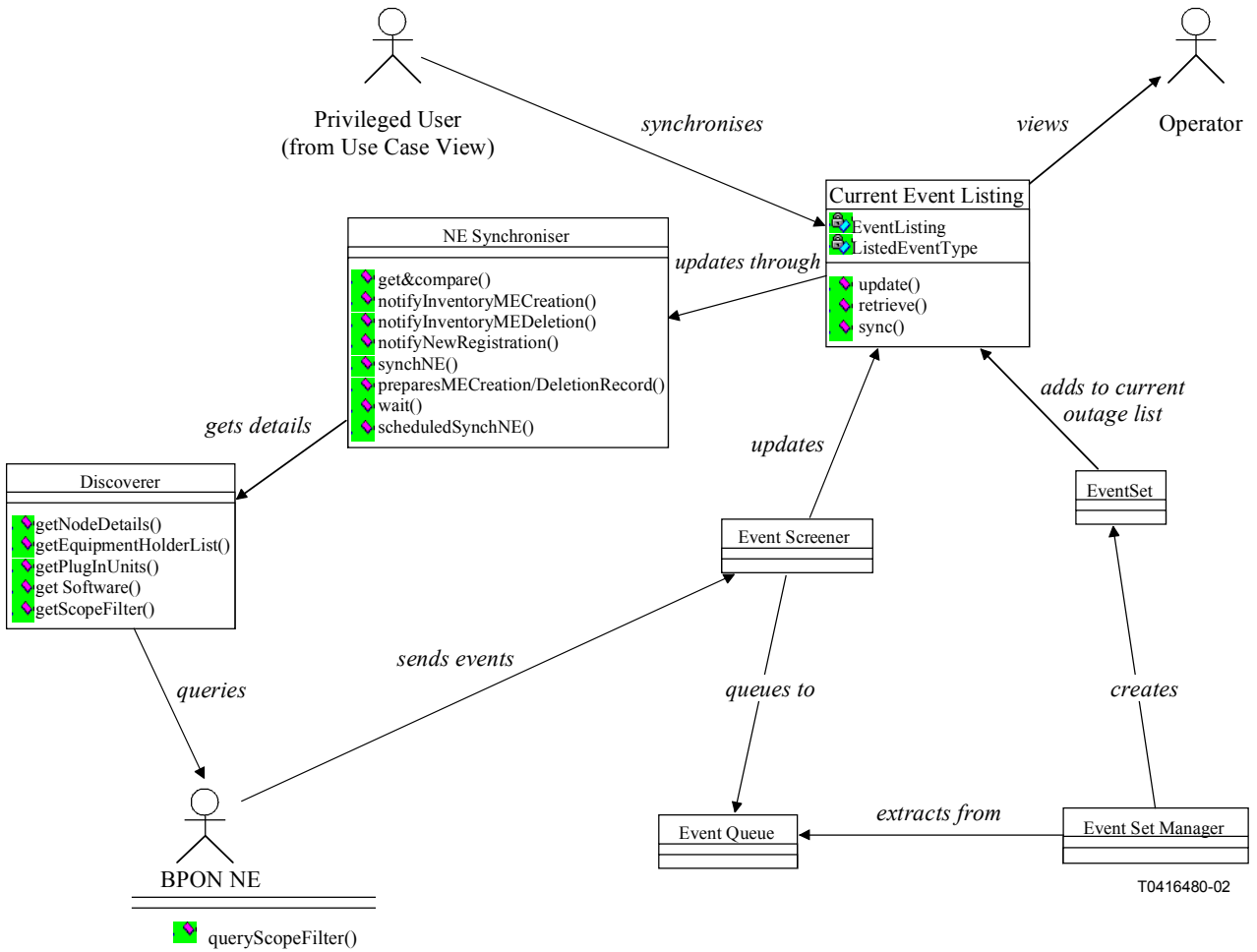

Figure 5-29/Q.834.3 – Service Outage Reporting Class diagram

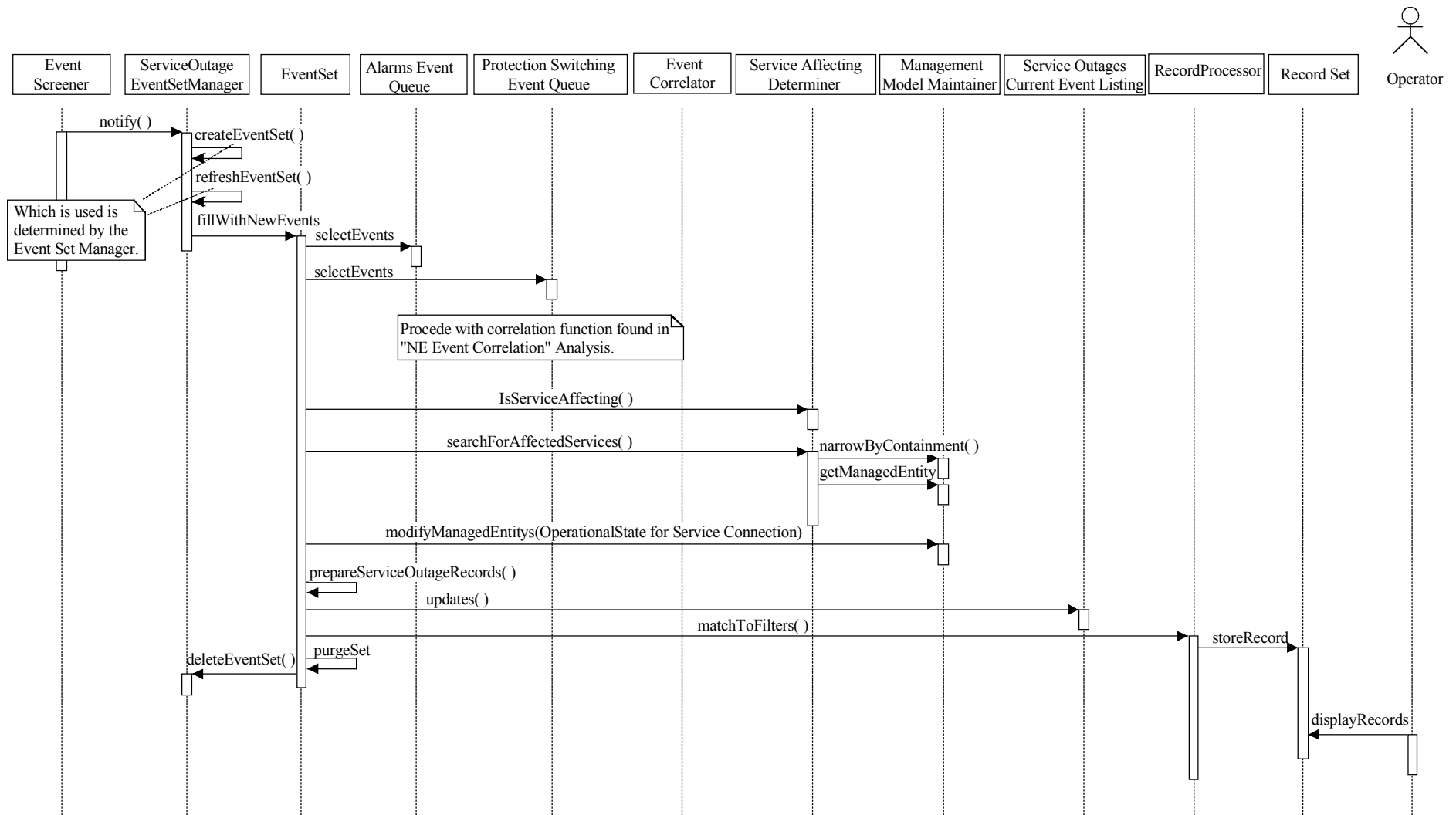
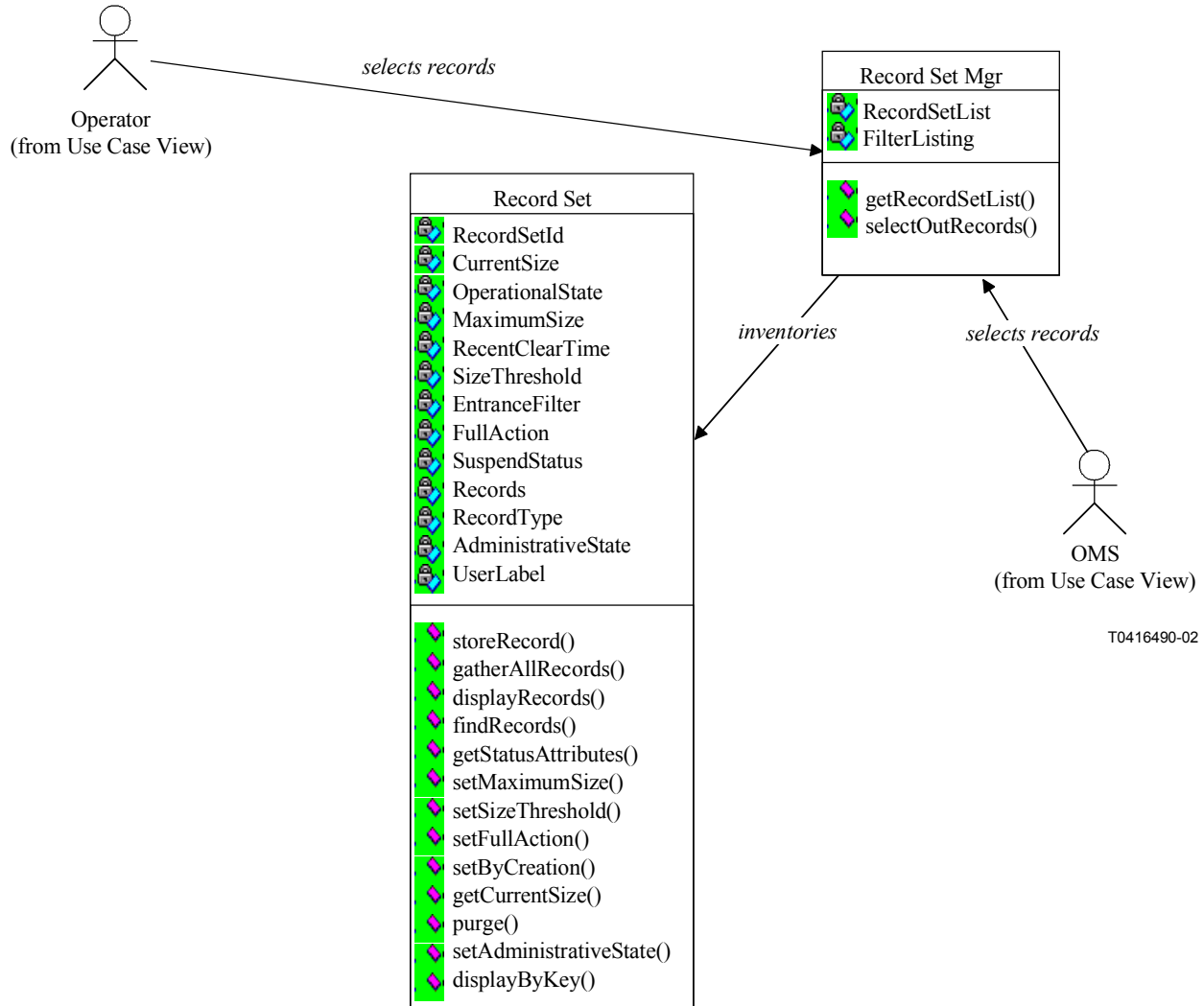

Figure 5-30/Q.834.3 – Service Outage Reporting Sequence diagram

Managed Entities: plugInUnitF, NEFSAN, ATMCrossConnectionF, OLT, ONT, ONU, NT, APONLinkConnection, APONTrail, DS1SubnetworkConnectionF, DS3SubnetworkConnectionF, E1SubnetworkConnectionF, E3SubnetworkConnectionF, vcLinkConnectionF, vcSubnetworkConnectionF, vpLinkConnectionF, vpSubnetworkConnectionF.

5.3.2.7 View Record Set



T0416490-02

Figure 5-31/Q.834.3 – View Record Set Class diagram

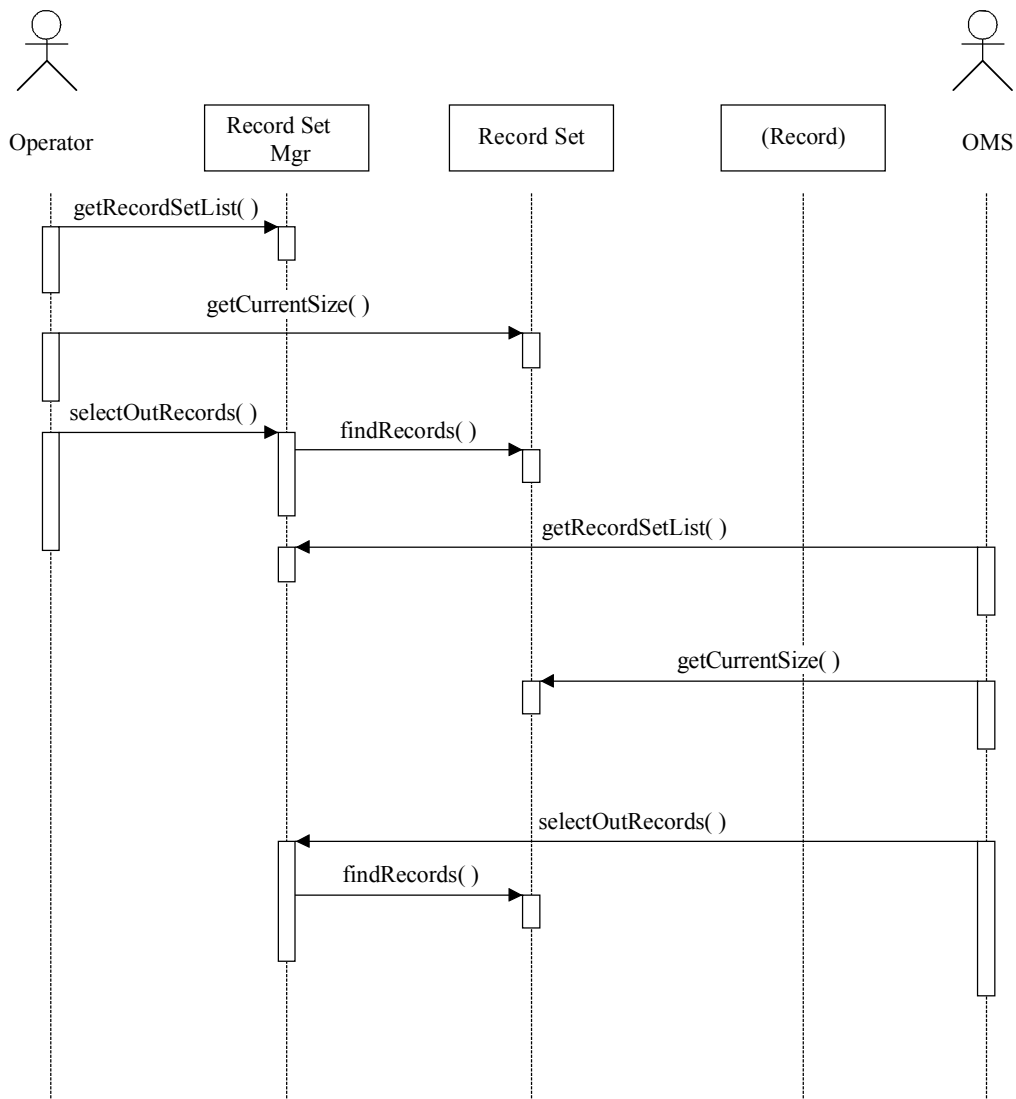

T0416500-02

Figure 5-32/Q.834.3 – View Record Set Sequence diagram

Managed Entities: logF, alarmLogRecordF, managedEntityCreationRecordF, managedEntityDeletionRecordF, AAL1PMHistoryDataF, AAL2PMHistoryDataF, AAL5PMHistoryDataF, APONPMHistoryData, ATMTrafficLoadHistoryDataF, DS1PMHistoryDataF, DS3PMHistoryDataF, E1PMHistoryDataF, E3PMHistoryDataF, EthernetPMHistoryDataF, MACBridgePMHistoryDataF, upcNpcDisagreementPMHistoryDataF, VoicePMHistoryDataF, vpvcpMHistoryDataF, attributeValueChangeRecordF, filterProfileF.

Operations:

Operation Name	Input Parameters	Return Value	Exceptions
1) getSize	Record Set Name	Current Size	Unknown Archive
2) selectOutRecords	Selection Filter Record Set Name List	RecordsListing	Timeout No Such Records
3) getRecordSetList		RecordSetNameListing	

Exceptions:

Exception Raised	Description
Unknown Archive	The Record Set is unknown to the Supplier Management System.
Timeout	Retrieval of records based on selection criteria takes too long.
No Such Records	No records among the designated Record Sets matches the selection criteria.

5.3.3 Software and Configuration Data

The following simplified class diagram show interactions between external actors and classes internal to the Supplier Management System when software and NE configuration data is managed with the Supplier Management System. This diagram serves to consolidate and provide consistency to the subsequent diagrams found within this clause.

5.3.3.1 Distribute Software

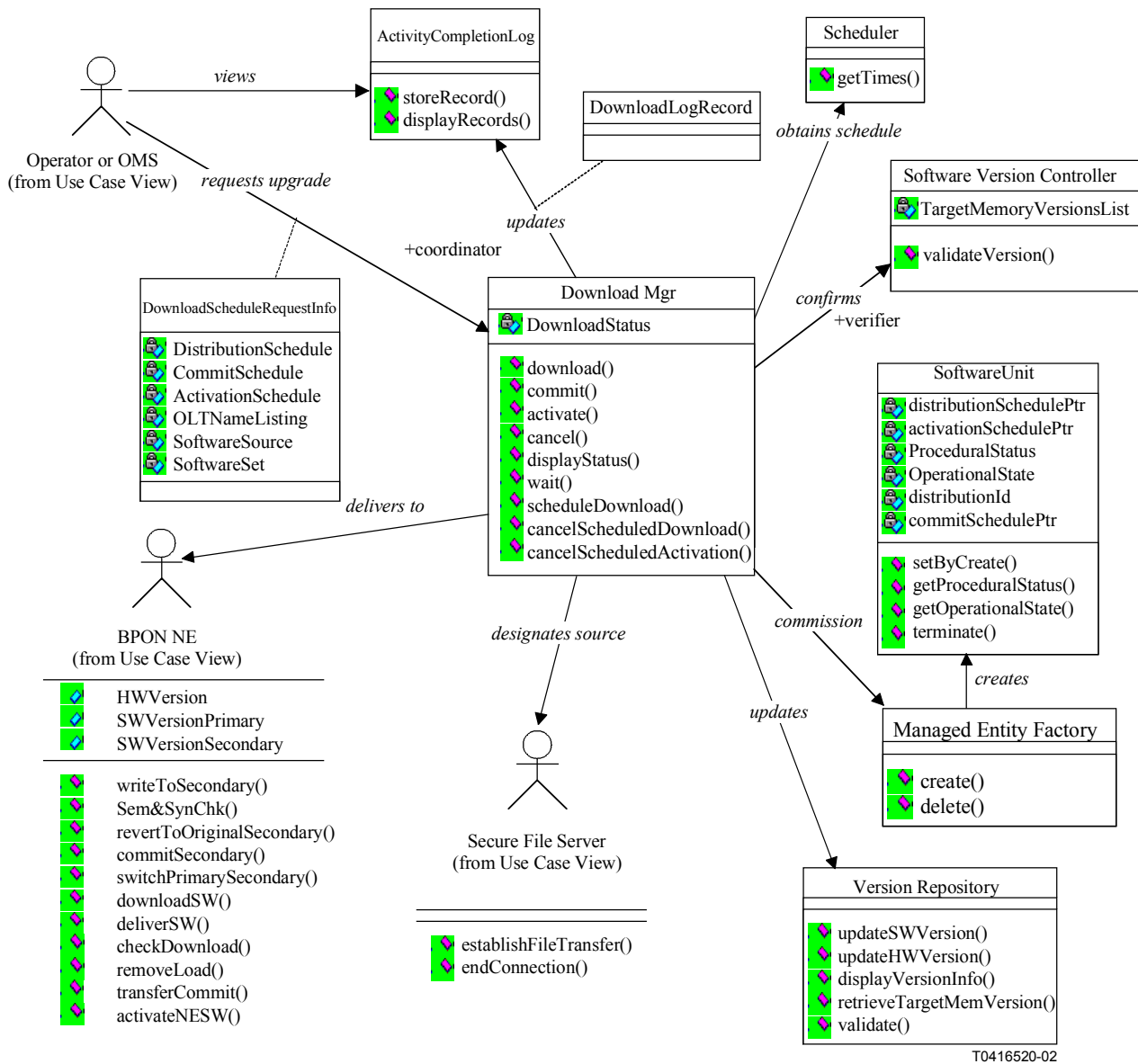

T0416520-02

Figure 5-34/Q.834.3 – Distribute Software Class diagram

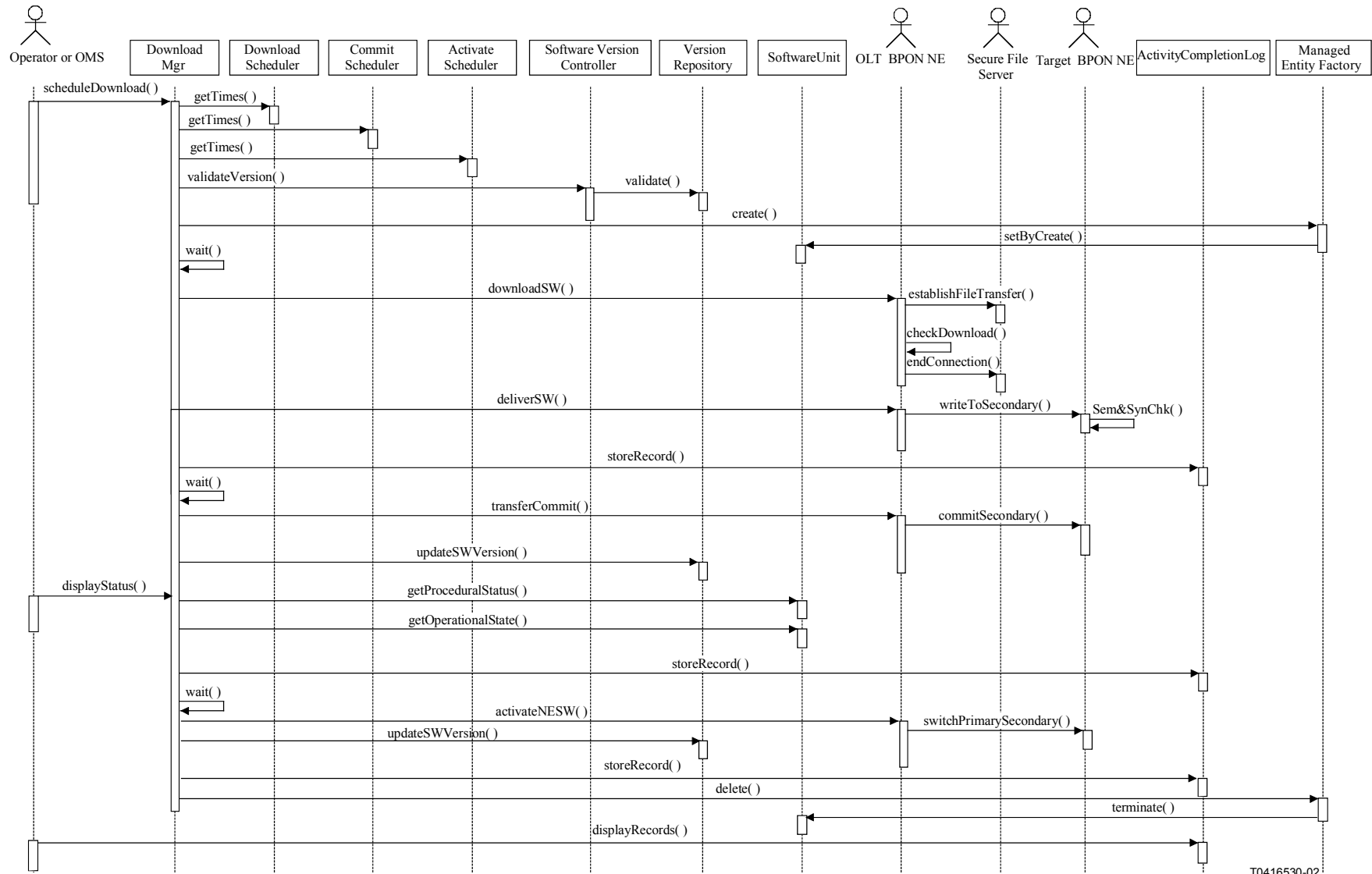

T0416530-02

Figure 5-35/Q.834.3 – Scheduled Distribute, Commit, Activate Software Download Sequence diagram

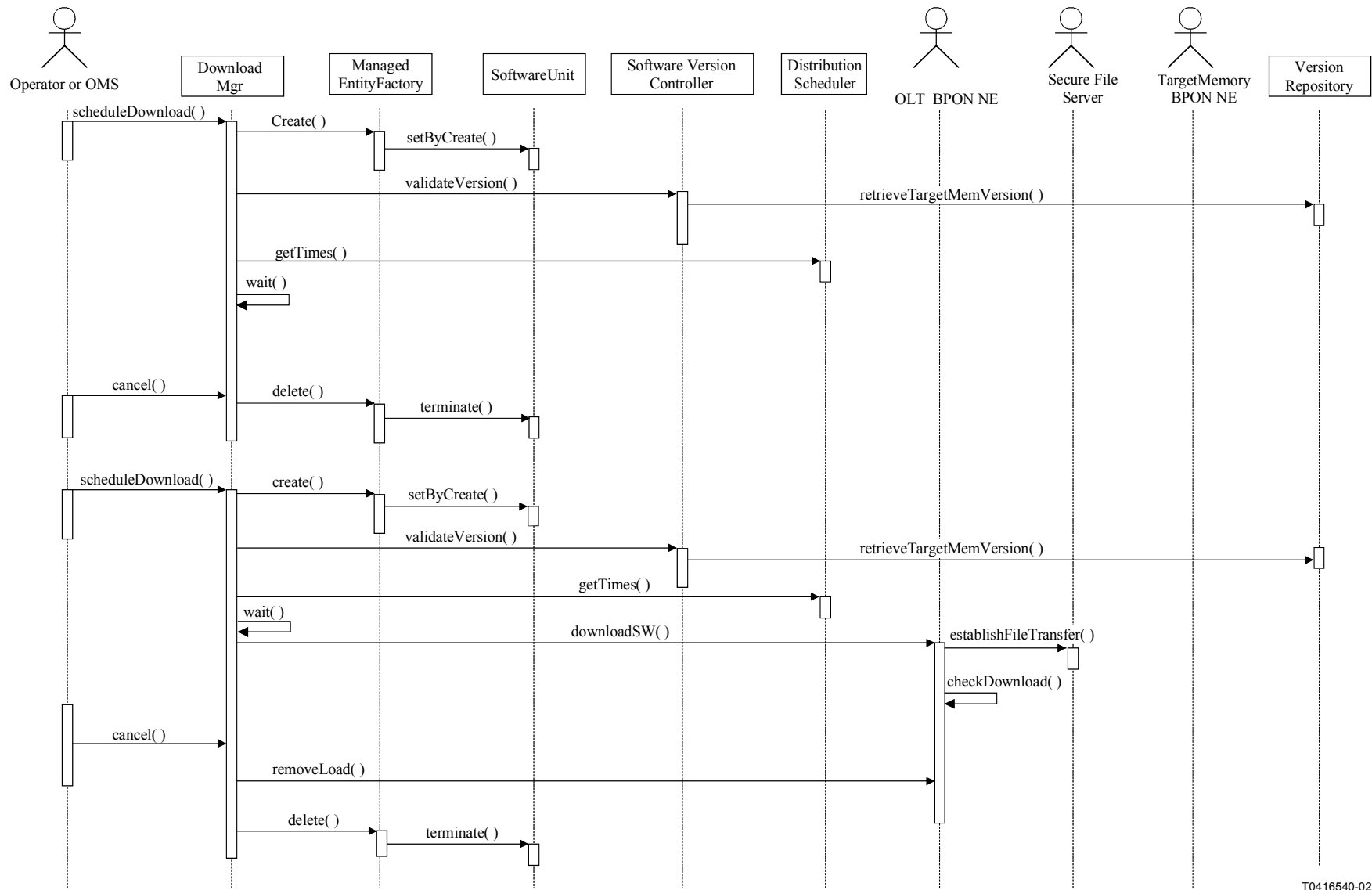

T0416540-02

Figure 5-36/Q.834.3 – Cancel Software Download Sequence diagram (Part 1)

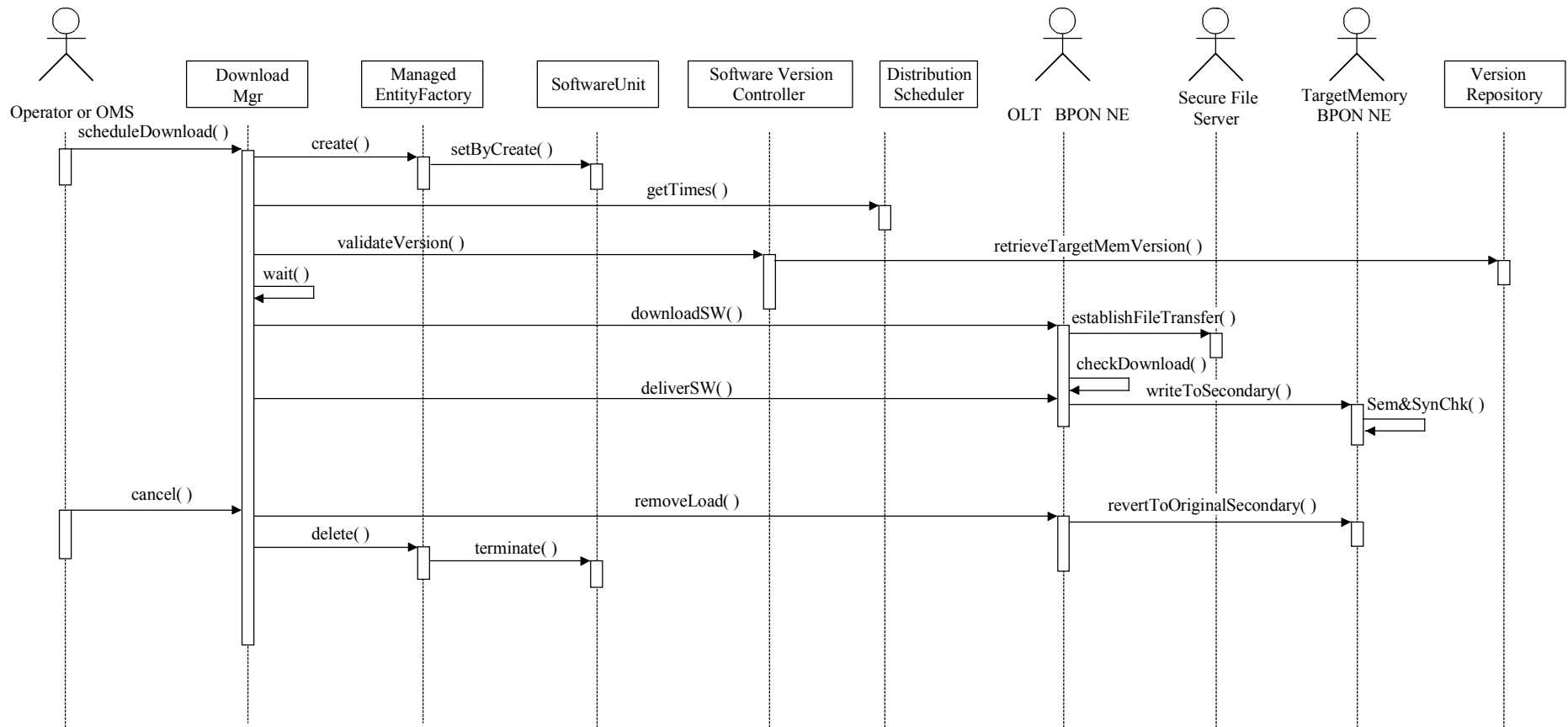

T0416550-02

Figure 5-37/Q.834.3 – Cancel Software Download Sequence diagram (Part 2)

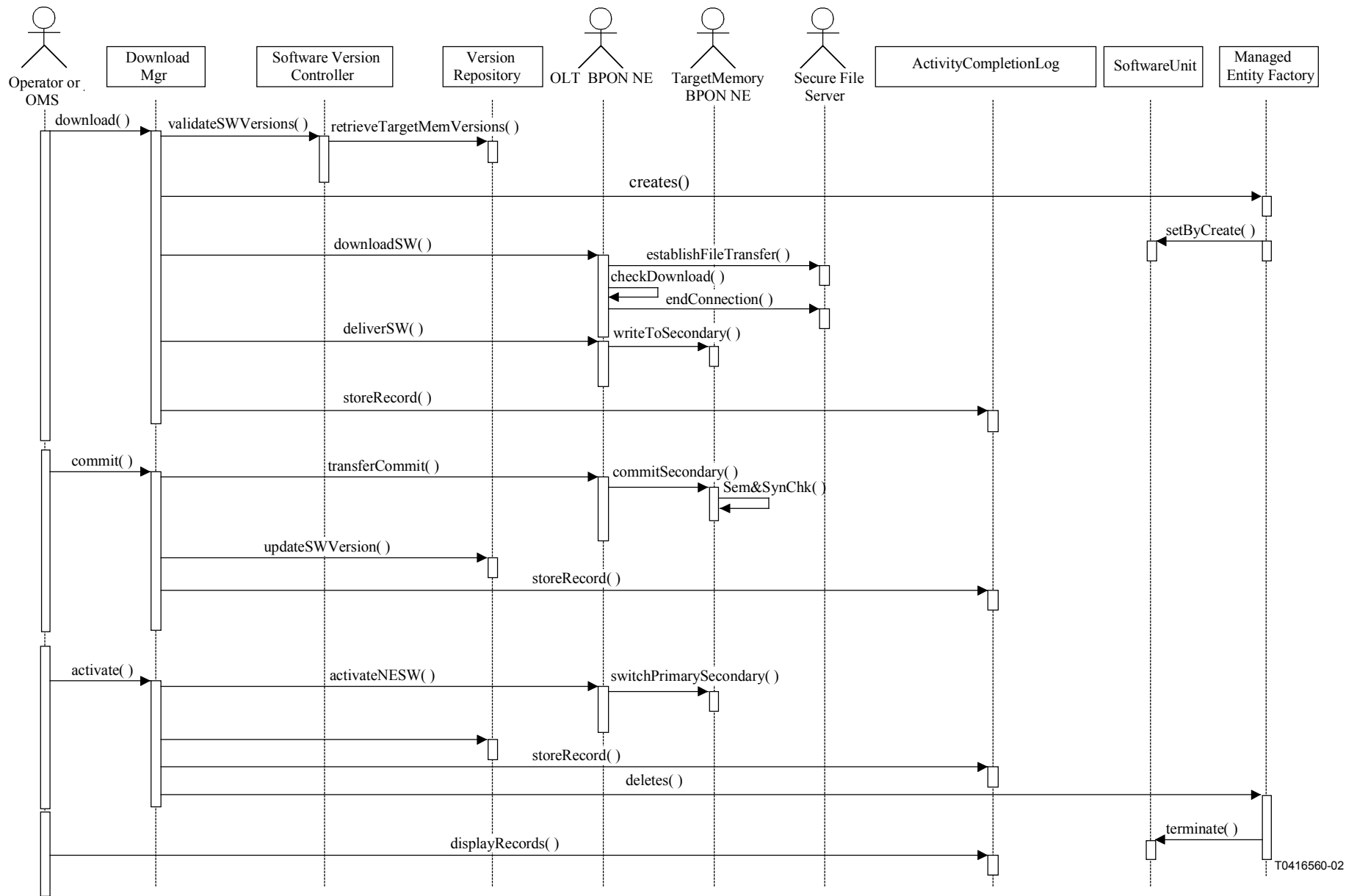

Figure 5-38/Q.834.3 – Software Download (without Scheduling) Sequence diagram

Managed Entities: softwareF.

Managed Support Entities: Scheduler, SoftwareUnit.

Operations:

Operation Name	Input Parameters	Return Value	Exceptions
1) downloadDistribute	SoftwareSet SoftwareSource OLTNameListing	SoftwareUnitId	Comm. Failure Download Failure Unrecognized TargetDistribution Failure Insufficient Memory Software Load/HW Mismatch Source Unreachable Unknown Software Load Timeout Access Denied
2) commit	SoftwareUnitId	void	Installation Failure Unknown Software Unit Access Denied
3) activate	SoftwareUnitId	void	Unknown Software Unit SoftwareNotYetInstalled Activation Failure Access Denied
4) displayStatus	SoftwareUnitId	StatusAttributes	Unknown Software Unit
5) cancel	SoftwareUnitId	void	Software Installed Unknown Software Unit Equipment Failure Comm. Failure Activation Completed Access Denied
6) scheduleDownload	SoftwareSet SoftwareSource OLTNameListing DownloadScheduler CommitScheduler ActivateScheduler	SoftwareUnitId	Software Load/HW Mismatch Unknown Scheduler Access Denied
7) cancelScheduledDownload	SoftwareUnitId	CancellationStatus	Unknown Software Unit Download Completed Access Denied
8) cancelScheduledActivation	SoftwareUnitId	CancellationStatus	Unknown Software Unit Activation Completed Access Denied

Exceptions:

Exception Raised	Description
Comm. Failure	There was a DCN link failure between the BPON NE and the Supplier Management System.
Unknown Scheduler	The named Scheduler is unknown to the Supplier Management System.
Software Load/HW Mismatch	The designated software may not be loaded onto the equipment hardware since the version of the hardware can not accept the software load.
Equipment Failure	The BPON NE currently has a failure condition preventing the requested transaction from being completed.
Unknown Software Unit	The named Software Unit (refers to software distributed to an NE) is unknown to the Supplier Management System.
Software Installed	The process may not be cancelled since the software is already installed.
SoftwareNotYetInstalled	The software may not be activated since it has not yet been installed.
Activation Failure	Software activation process failure.
Installation Failure	Software installation process failure.
Insufficient Memory	There is insufficient memory on the BPON NE to load the software unit.
Download Completed	Indicates that software download has been completed so that the process cannot be cancelled.
Activation Completed	Indicates that software activation has been executed so that activation cannot be cancelled.
Download Failure	The designated Software Set could not be downloaded to the named OLT(s).
Distribution Failure	The download Software Set could not be distributed to the final circuit packs and/or subtending nodes.
Source Unreachable	The server holding the software load to be downloaded could not be reached by the OLT.
Unrecognized Target	The designated software in the Secure File Server is unknown to the Supplier Management System.
Access Denied	System is not granted access to this interface object.
Timeout	The process duration reached a system-defined timeout before the process could complete.

5.3.3.2 NE Restoral

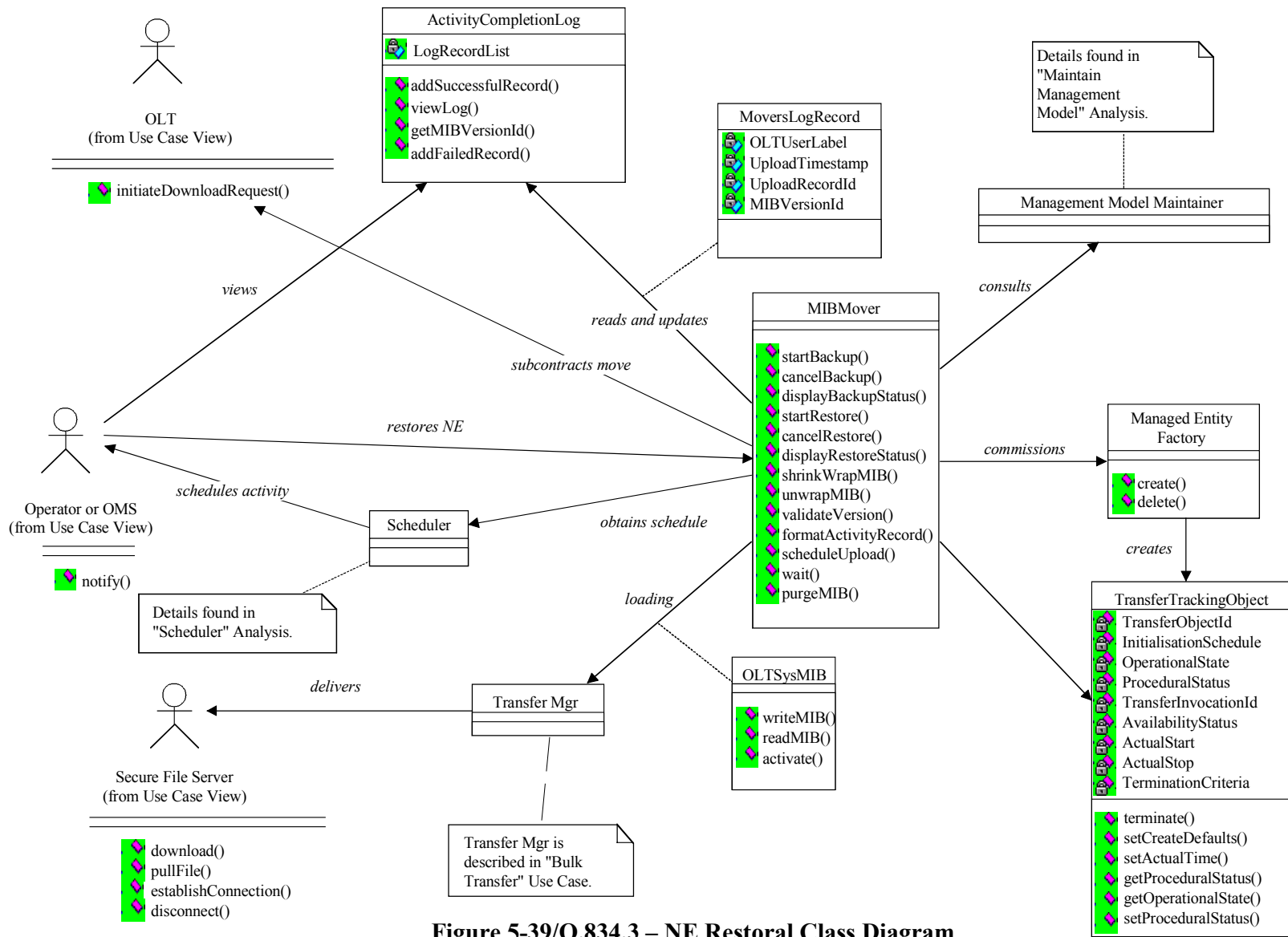

Figure 5-39/Q.834.3 – NE Restoral Class Diagram

T0416570-02

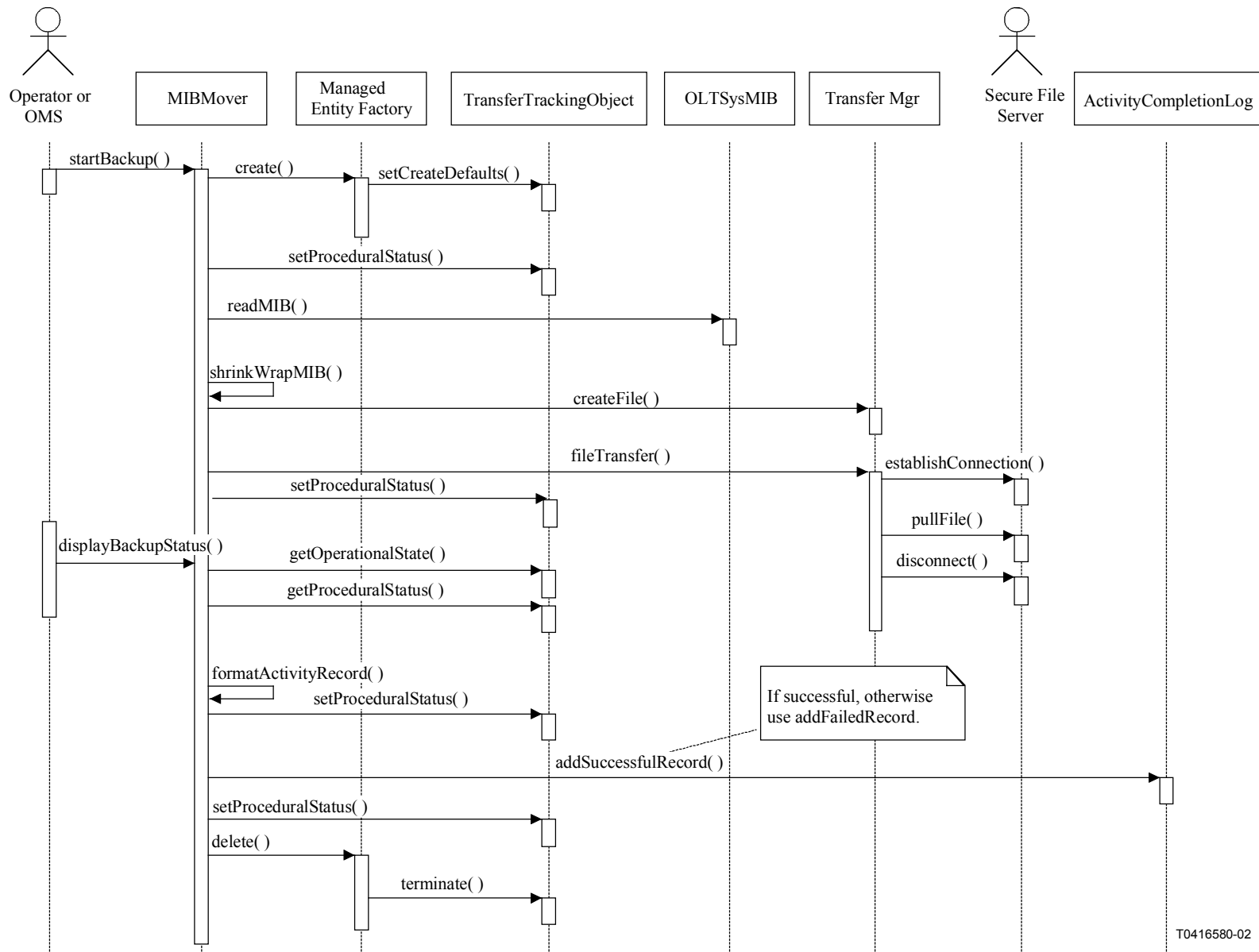

Figure 5-40/Q.834.3 – NE Upload (Showing Internal Procedural Status Changes) sequence diagram

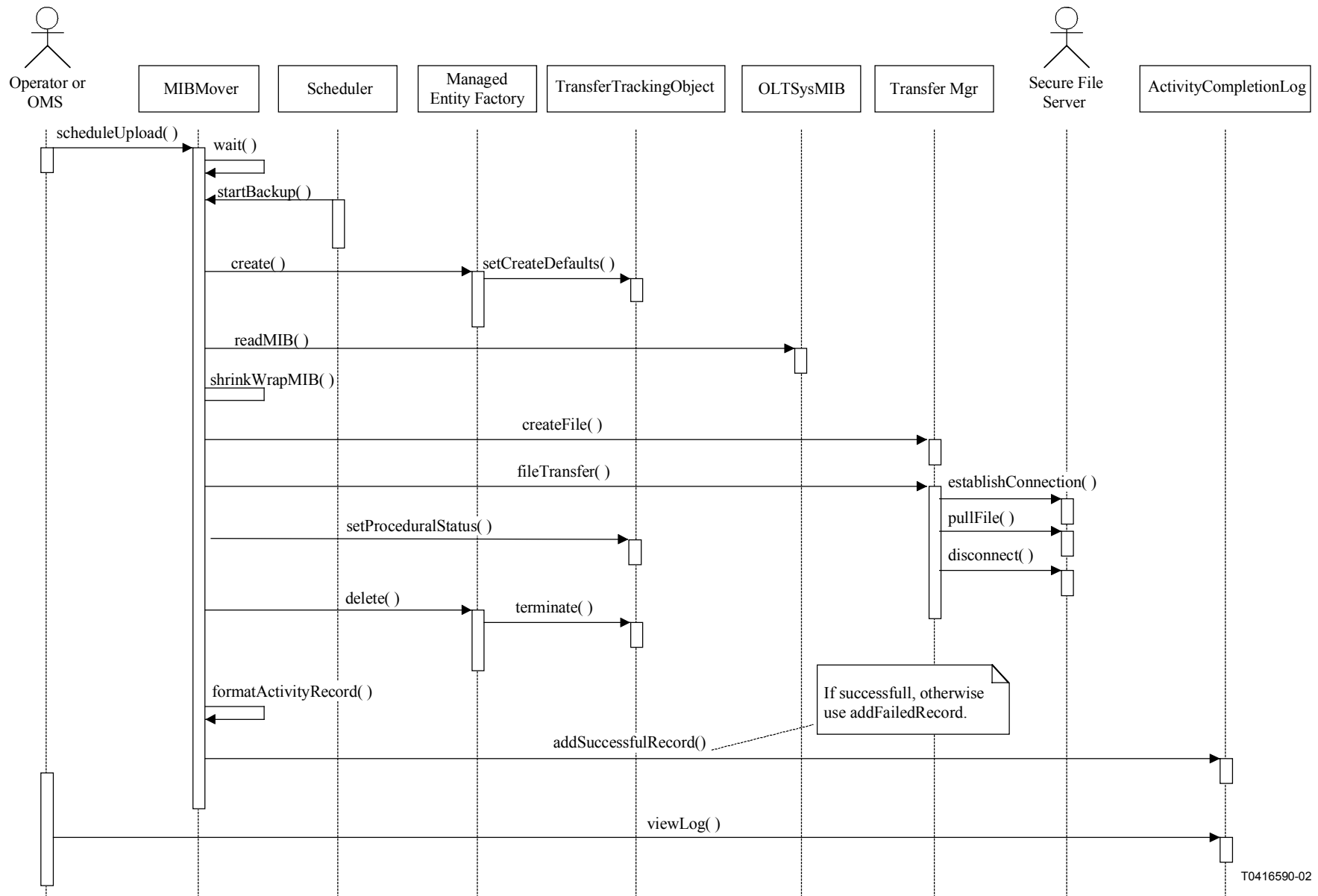
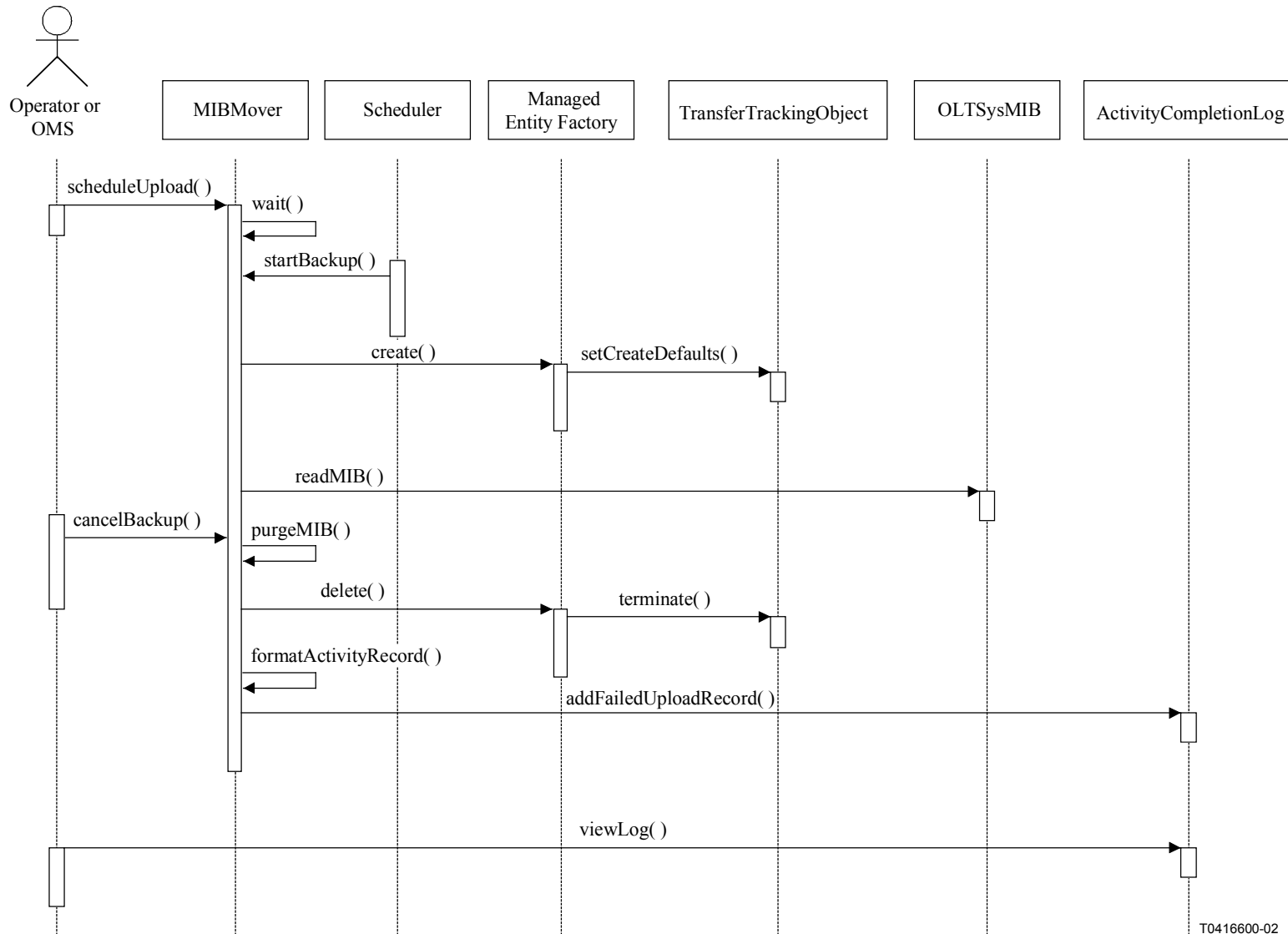
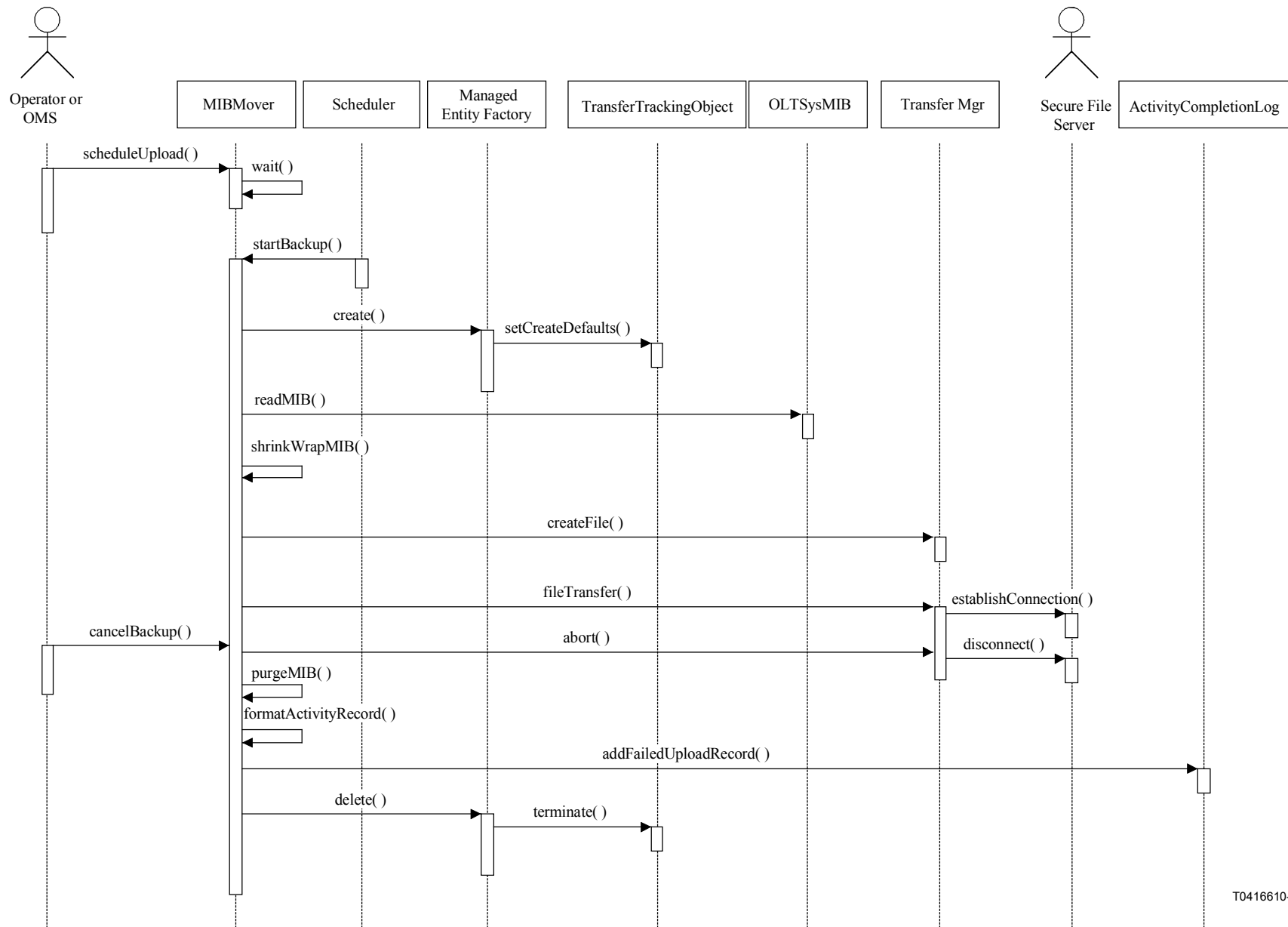

Figure 5-41/Q.834.3 – Scheduled NE Upload sequence diagram



T0416600-02

Figure 5-42/Q.834.3 – Scheduled Upload Cancelled sequence diagram (Part 1)



T0416610-02

Figure 5-43/Q.834.3 – Scheduled Upload Cancelled sequence diagram (Part 2)

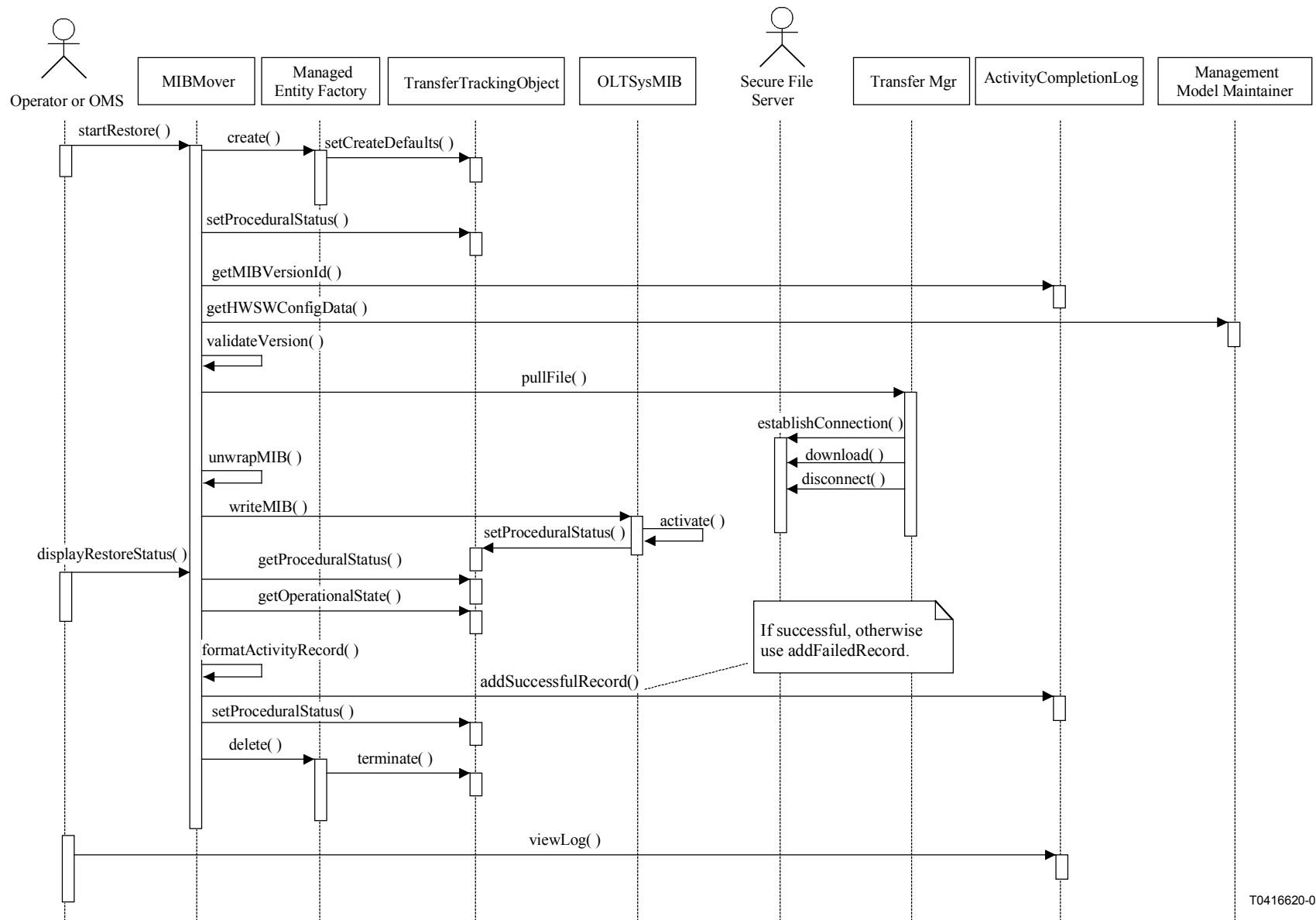

T0416620-02

Figure 5-44/Q.834.3 – NE Restore (Showing Internal Procedural Status Changes) sequence diagram

Managed Entities: OLT, ONU, ONT, NT, logF.

Management Support Entities: Scheduler, ActivityCompletionLog.

Operations⁶:

Operation Name	Input Parameters	Return Value	Exceptions
1) startBackup	OLT User Label Destination Server Destination File	Transfer Tracking Object Id	Unknown OLT Unknown Destination Server File Exists Comm. Failure Equipment Failure Denied Access
2) overWriteBackup	OLT User Label Destination Server Destination File	Transfer Tracking Object Id	Unknown OLT Unknown Destination Server Comm. Failure Equipment Failure Denied Access
3) displayBackUpStatus	TransferTracking ObjectId	StatusAttributes	Unknown Backup Process
4) scheduleBackup	OLT User Label Scheduler Destination Server Destination Files	Transfer Tracking Object Id	Unknown OLT Unknown Scheduler Unknown Destination Server Denied Access
5) cancelBackup	Transfer Tracking Object Id	void	Unknown Backup Process Comm. Failure Equipment Failure Backup Completed Denied Access
6) viewLog	RecordSet User Label	Records	Unknown Archive

⁶ The operation "overWriteBackup" has the same behaviour as "startBackup" except that the named destination file (the target) may be non-empty.

Operation Name	Input Parameters	Return Value	Exceptions
7) startRestore	OLT User Label Source Server Source File	Transfer Tracking Object Id	Unknown OLT Unknown Source File Unknown Source Server Comm. Failure Equipment Failure Denied Access Software Load/Hardware Mismatch
8) displayRestoreStatus	Transfer Tracking Object Id	StatusAttributes	Unknown Restore Process

Exceptions:

Exception Raised	Description
Comm. Failure	There was a DCN link failure between the BPON NE and the Supplier Management System.
Unknown Scheduler	The named Scheduler is unknown to the Supplier Management System.
Equipment Failure	The BPON NE currently has a failure condition preventing the requested transaction from being completed.
Unknown Destination Server	The Supplier Management System and/or OLT cannot communicate with the Destination Server. The DCN address is unknown or access is blocked.
Unknown Restore Process	The named transfer-tracking object identifying the file transfer process is unknown to the Supplier Management System.
Unknown OLT	The name OLT is not within the management jurisdiction of the Supplier Management System.
Unknown Source Server	The Supplier Management System and/or OLT cannot communicate with the Source Server. The DCN address is unknown or access is blocked.
Unknown Source File	The Supplier Management System does not recognize the named Source File as one to which system configuration information has been uploaded.
Unknown Backup Process	The named transfer-tracking object identifying the file transfer process is unknown to the Supplier Management System.
File Exists	The uploading of configuration data cannot be accomplished since the process would overwrite an existing file.
Backup Completed	The process cannot be cancelled since it has already completed successfully.
Denied Access	System is not granted access to this interface object.
Unknown Archive	Designated Record Set is unknown to the Supplier Management System.
Software Load/Hardware Mismatch	The former NE configuration data could not be downloaded to the NE because there were changes made to the NE hardware that caused an incompatibility.

5.3.3.3 NE Software Version Control

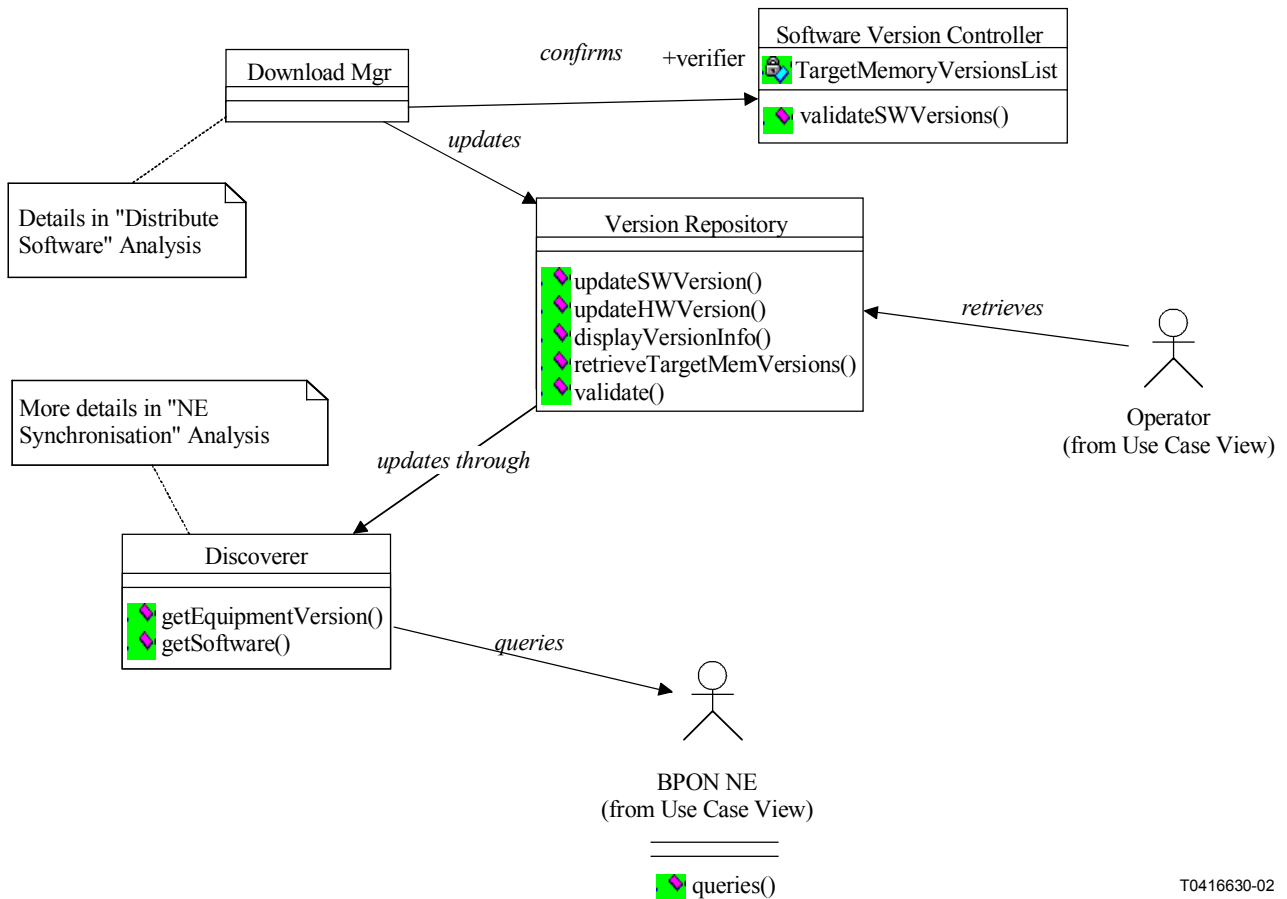

Figure 5-45/Q.834.3 – NE Software Version Control class diagram

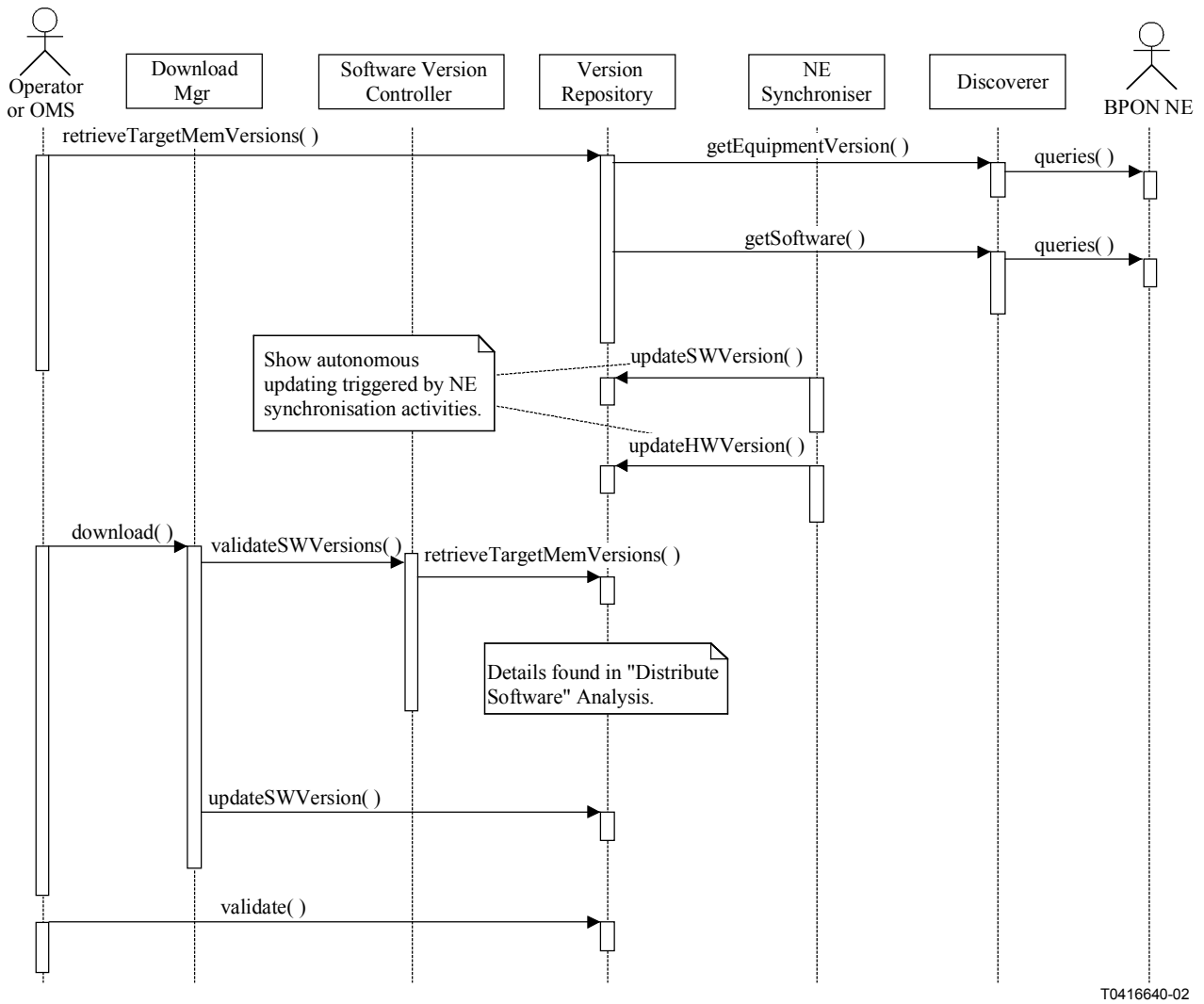

Figure 5-46/Q.834.3 – NE Software Version Control sequence diagram

Managed Entities: FSANNE, softwareF, plugInUnitF.

Operations:

Operation Name	Input Parameters	Return Value	Exceptions
1) retrieveTargetMemVersions	BPON NE User Label	TargetMemoryVersionsList	Comm. Failure Unknown BPON NE
2) validate	BPON NE User Label Hardware Version Software Version	void	Invalid Version Id Unknown BPON NE

Exceptions:

Exception Raised	Description
Comm. Failure	There was a DCN link failure between the BPON NE and the Supplier Management System.
Unknown BPON NE	The named BPON NE is unknown to the Supplier Management System.
Invalid Version Id	The version supplied on the validation request cannot be used with the designated NE hardware.

5.3.3.4 Scheduler

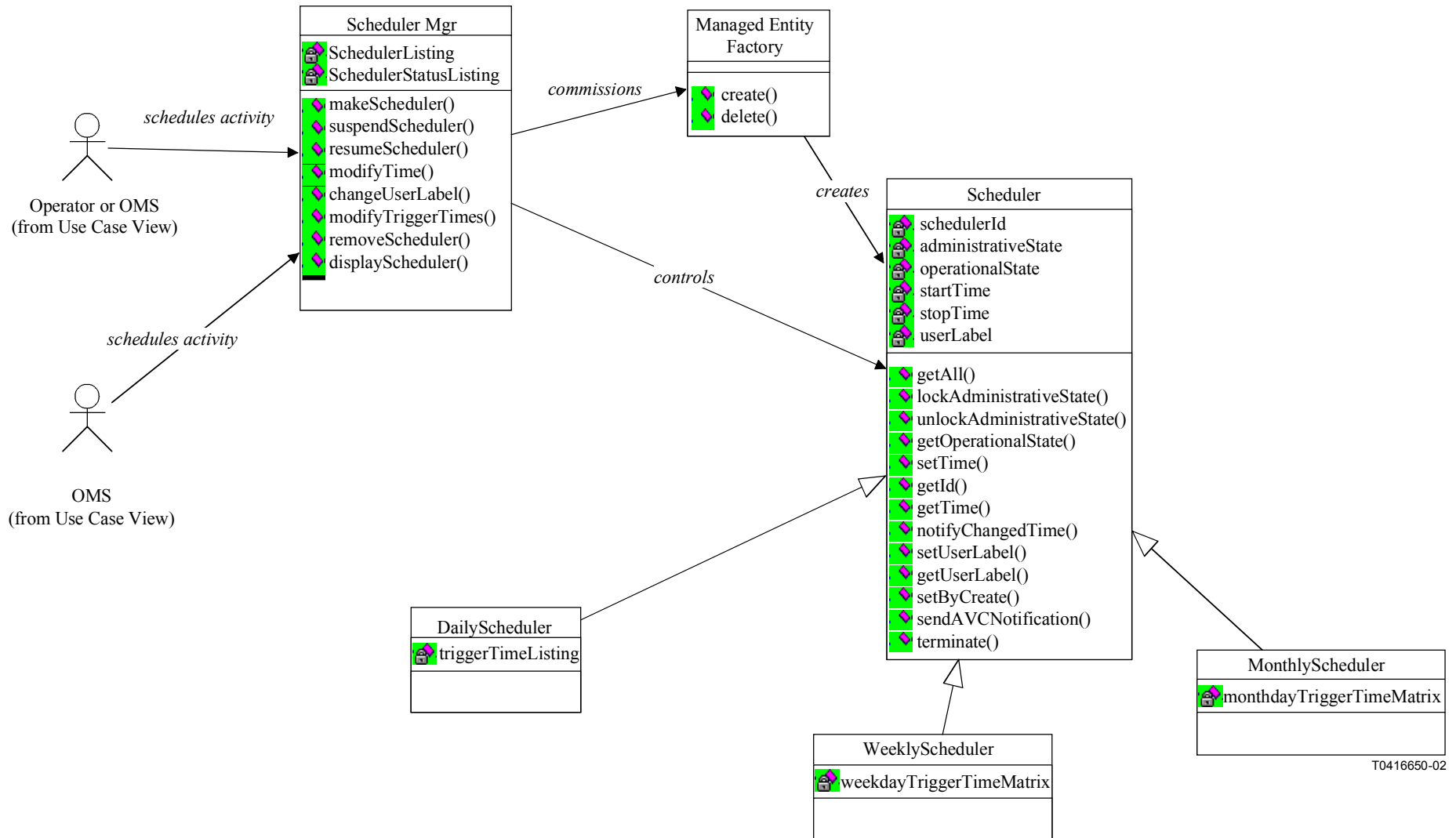

T0416650-02

Figure 5-47/Q.834.3 – Scheduler class diagram

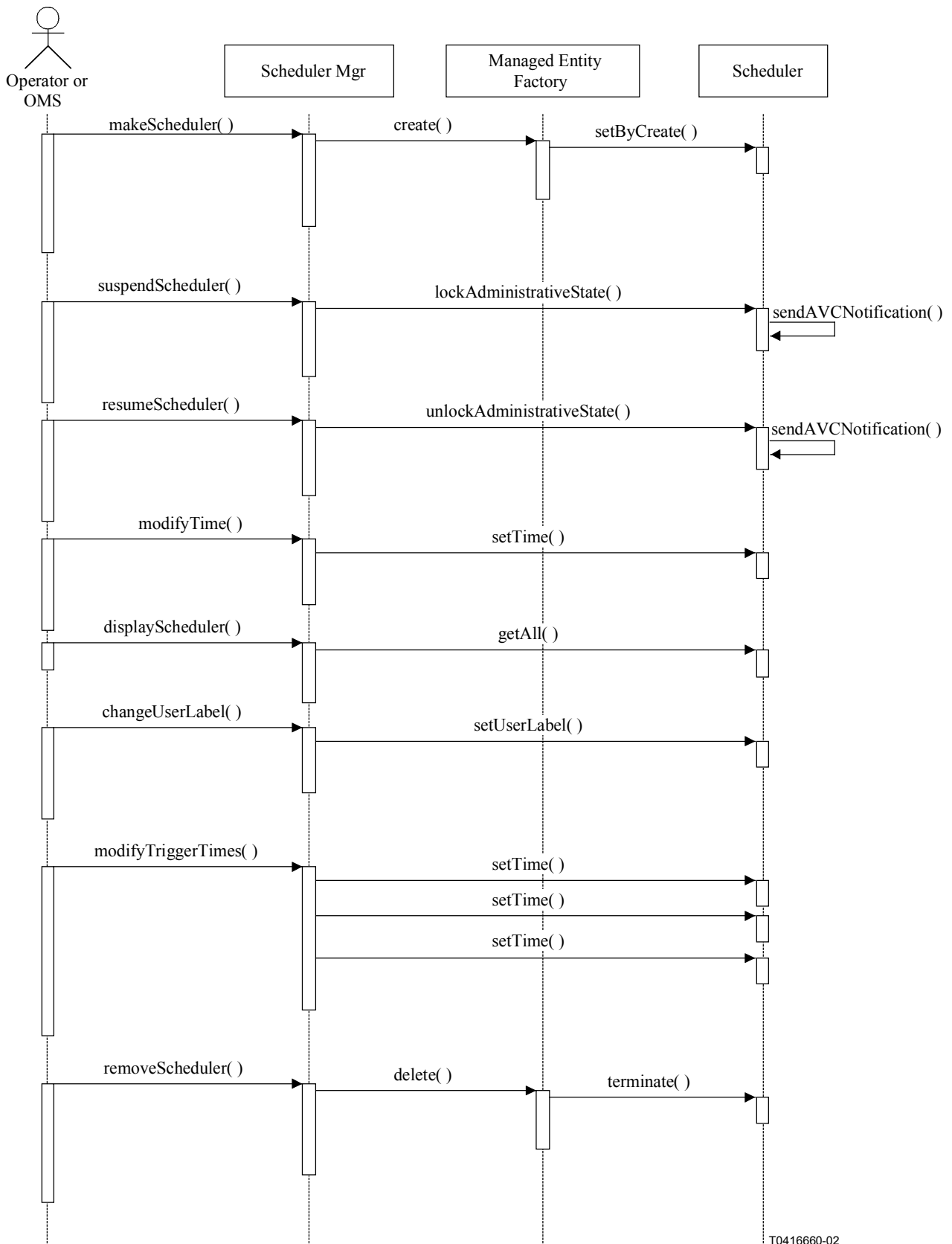

T0416660-02

Figure 5-48/Q.834.3 – Scheduler sequence diagram

Managed Entities: None yet provided by [11] or [12].

Managed Support Entities: Scheduler.

Operations:

Operation Name	Input Parameters	Return Value	Exceptions
1) makeScheduler	User Label Start Time Stop Time DailyWeeklyMonthlyInd TriggerTimeMatrix	SchedulerId	Invalid Start Time Invalid Stop Time Duplicate User Label Matrix Scheduler Type Mismatch Access Denied
2) suspendScheduler	User Label	void	Unknown Scheduler Scheduler Already Suspended Access Denied
3) resumeScheduler	User Label	void	Unknown Scheduler Scheduler Already Active Access Denied
4) modifyTime	User Label NewStartTime NewStopTime	void	Invalid Start Time Invalid Stop Time Unknown Scheduler Matrix Scheduler Type Mismatch Access Denied
5) displaySchedule	UserLabel	Scheduler Object	Unknown Scheduler
6) changeUserLabel	PresentUserLabel NewUserLabel	void	Unknown Scheduler Duplicate User Label Access Denied
7) modifyTriggerTimes	UserLabel PresentTriggerTimeMatrix NewTriggerTimeMatrix	void	Unknown Scheduler Matrix Scheduler Type Mismatch Access Denied
8) removeScheduler	UserLabel	void	Unknown Scheduler Race Condition Access Denied

Exceptions:

Exception Raised	Description
Unknown Archive	Record set is unknown to the Supplier Management System.
Unknown Scheduler	The named Scheduler is unknown to the Supplier Management System.
Race Condition	The scheduler could not be removed fast enough.
Matrix Scheduler Type Mismatch	The syntax for the Trigger Time Matrix is mismatched with the type of scheduler named.
Duplicate User Label	The named User Label is in use already for another Scheduler defined within the Supplier Management System.
Invalid Start Time	The new start time is inconsistent with the current trigger time matrix or the new stop time.
Invalid Stop Time	The new stop time is inconsistent with the current trigger time matrix or the new start time.
Scheduler Already Active	The request for resumption of the function of the named Scheduler is unnecessary since the Administrative State of the Scheduler is unlocked.
Scheduler Already Suspended	The request for suspension of the functioning of the named Scheduler is unnecessary since the Administrative State of the Scheduler is already locked.
Access Denied	System is not granted access to this interface object.

5.3.4 Testing

The following simplified class diagram show interactions between external actors and classes internal to the Supplier Management System when testing functionality is supported by the Supplier Management System. This diagram serves to consolidate and provide consistency to the subsequent diagrams found within this clause.

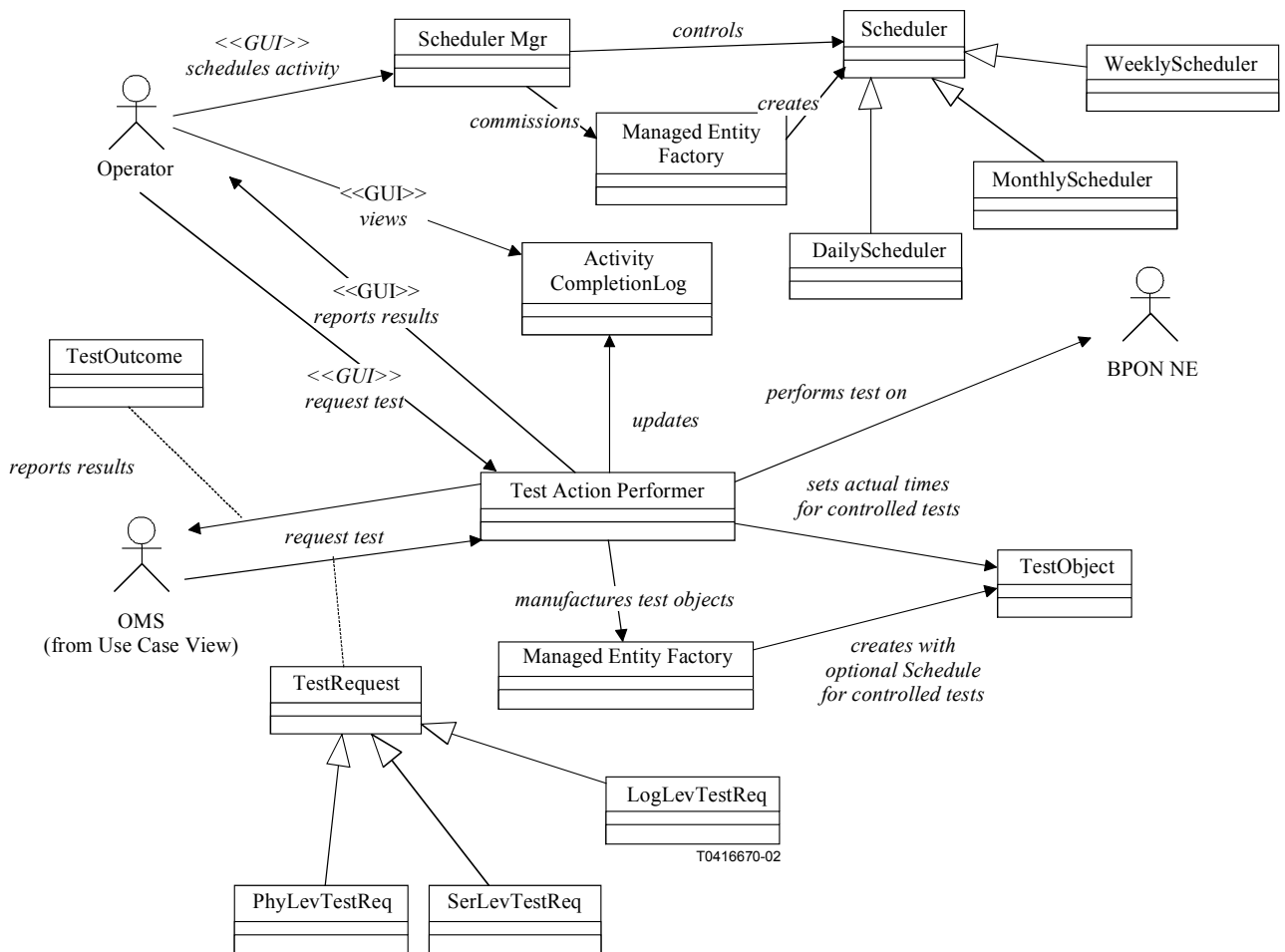

Figure 5-49/Q.834.3 – Testing class diagram

5.3.4.1 Conduct Test, Report Test Results

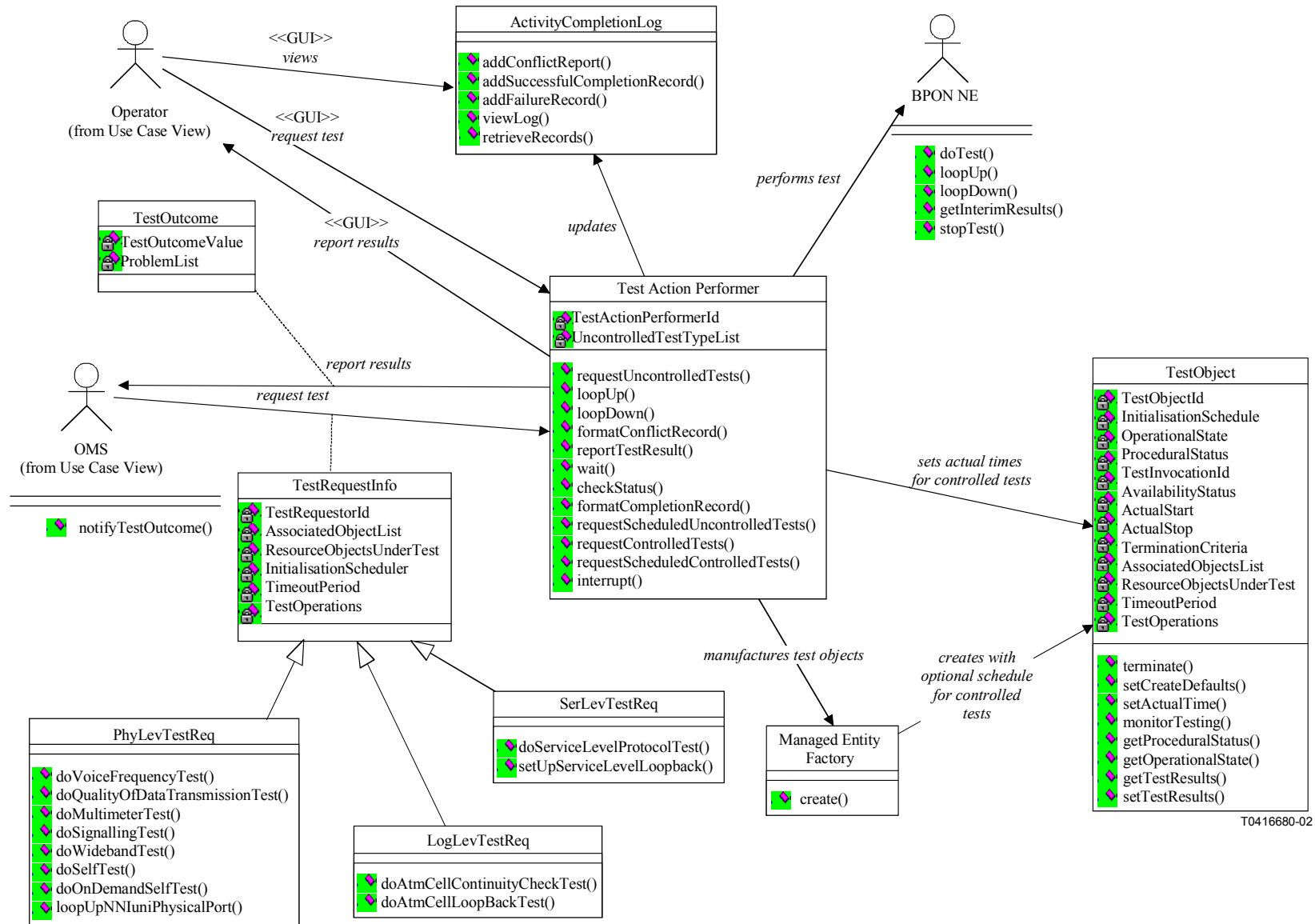
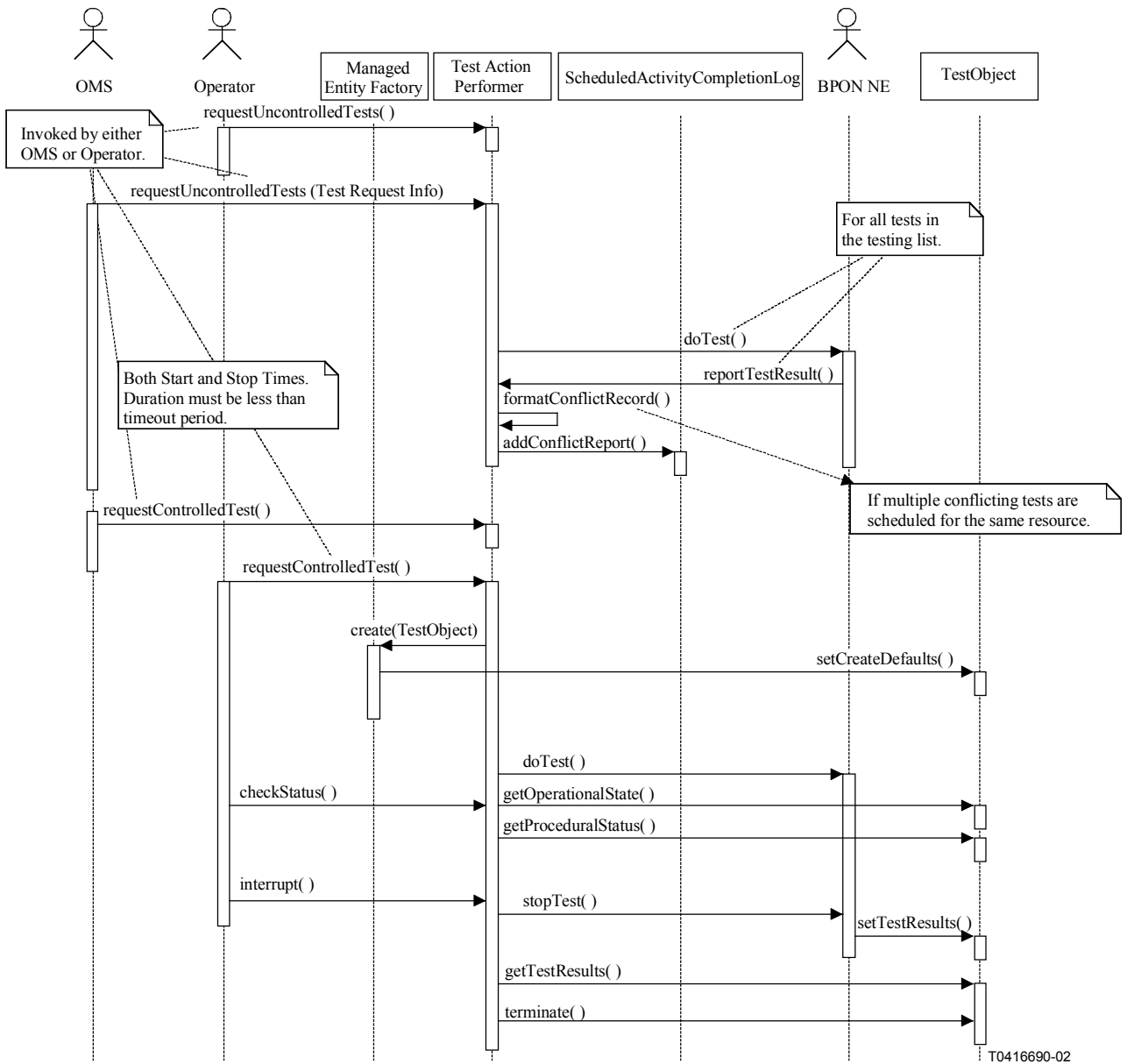
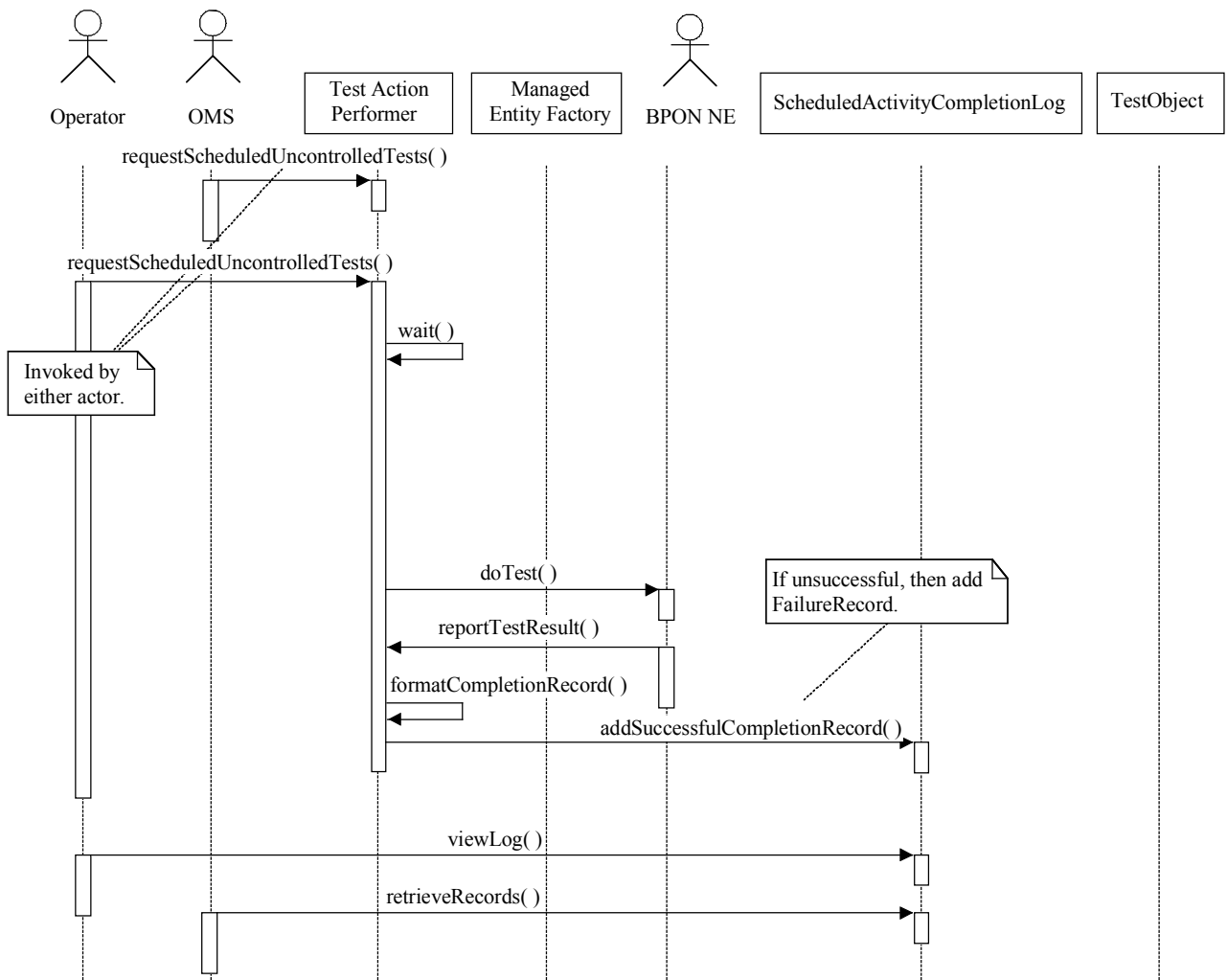

Figure 5-50/Q.834.3 – Conduct Test, Report Results class diagram



T0416690-02

Figure 5-51/Q.834.3 – Conduct Uncontrolled and Controlled Test and Report Results sequence diagram



T0416700-02

Figure 5-52/Q.834.3 – Scheduled Uncontrolled Testing sequence diagram⁷

Managed Entities: None provided by [11] or [12].

Management Support Entities: Scheduler, Test Action Performer, Test Object.

⁷ Operations viewLog and retrieveRecords are covered in the View Record Set Use Case.

Operations⁸:

Operation Name	Input Parameters	Return Value	Exceptions
1) requestScheduledUncontrolledTests	TestRequestorId AssociatedObjectList ResourceObjectsUnder Test Scheduler TimeoutPeriod TestOperations	void	Unknown BPON Resources Unknown Scheduler Unknown Test Operations Invalid Timeout Period Access Denied
2) requestScheduledControlledTests	TestRequestorId AssociatedObjectList ResourceObjectsUnder Test Scheduler TimeoutPeriod TestOperations	Test Object Id	Unknown BPON Resources Unknown Scheduler Unknown Test Operations Invalid Timeout Period Access Denied
3) checkStatus	Test Object Id	Status Attributes	Unknown Test Process
4) requestUncontrolledTest	TestRequestorId AssociatedObjectList ResourceObjectsUnder Test TimeoutPeriod TestOperations	Test Outcome	Unknown BPON Resources Timeout Unknown Test Operations Invalid Timeout Period Unable to execute Access Denied Comm. Failure

⁸ At the moment, controlled testing is not required for BPON network resources. However, for the sake of completeness, two operations called "requestControlledTest" and "requestScheduledControlledTest" have been included and shown in the sequence diagrams. Scheduled tests can be periodic.

Operation Name	Input Parameters	Return Value	Exceptions
5) requestControlledTest	TestRequestorId AssociatedObjectList ResourceObjectsUnder Test TimeoutPeriod TestOperations	Test Object Id	Unknown BPON Resources Unknown Test Operations Invalid Timeout Period Access Denied Comm. Failure
6) loopUp	TestRequestorId LoopUpTimeIntvl TerminationPoints	Test Object Id	Unknown Termination Points Comm. Failure Access Denied

Exceptions:

Exception Raised	Description
Unknown BPON Resources	BPON resources mentioned in the test request that are unknown to the Supplier Management System. This list can include the resource being tested as well as any ancillary resources cooperating with the test operations.
Timeout	Uncontrolled test has timed out before producing test outcome.
Unknown Test Operations	Identified test operations unknown to the Supplier Management System.
Unknown Test Process	Status for a controlled test was not retrievable because the identified test process is not recognized.
Invalid Timeout Period	Designated timeout period violates definition of valid values.
Unable to execute	Requested uncontrolled test was unable to execute due to failure conditions for the resources participating in the test.
Unknown Termination Points	Designated loopback locations are unknown to the Supplier Management System.
Unknown Scheduler	Scheduler identified in a request for a scheduled test (both controlled and uncontrolled) is unknown to the Supplier Management System.
Access Denied	System is not granted access to this interface object.
Comm. Failure	Supplier Management System experienced a DCN failure to the BPON NE.

5.3.5 Installation

The following simplified class diagram show interactions between external actors and classes internal to the Supplier Management System when BPON equipment is being installed. This diagram serves to consolidate and provide consistency to the subsequent diagrams found within this clause.

5.3.5.1 Autodiscover NEs and PlugInUnits

Figure 5-54 provides a detailed view of the classes involved in autodiscovery. Figures 5-55 and 5-56 present high-level views of two different ways that the Supplier Management System could support autodiscovery when a BPON Network Element is registered with the Supplier Management System. The actual implementation might combine both views. In any case, the Supplier Management System uses a synchronization function to prepare up-to-date event information for publication to interested client applications through an event channel mechanism. Figure 5-57 shows how insertion of a circuit pack in a slot in a BPON NE triggers the autodiscovery function in the Supplier Management System.

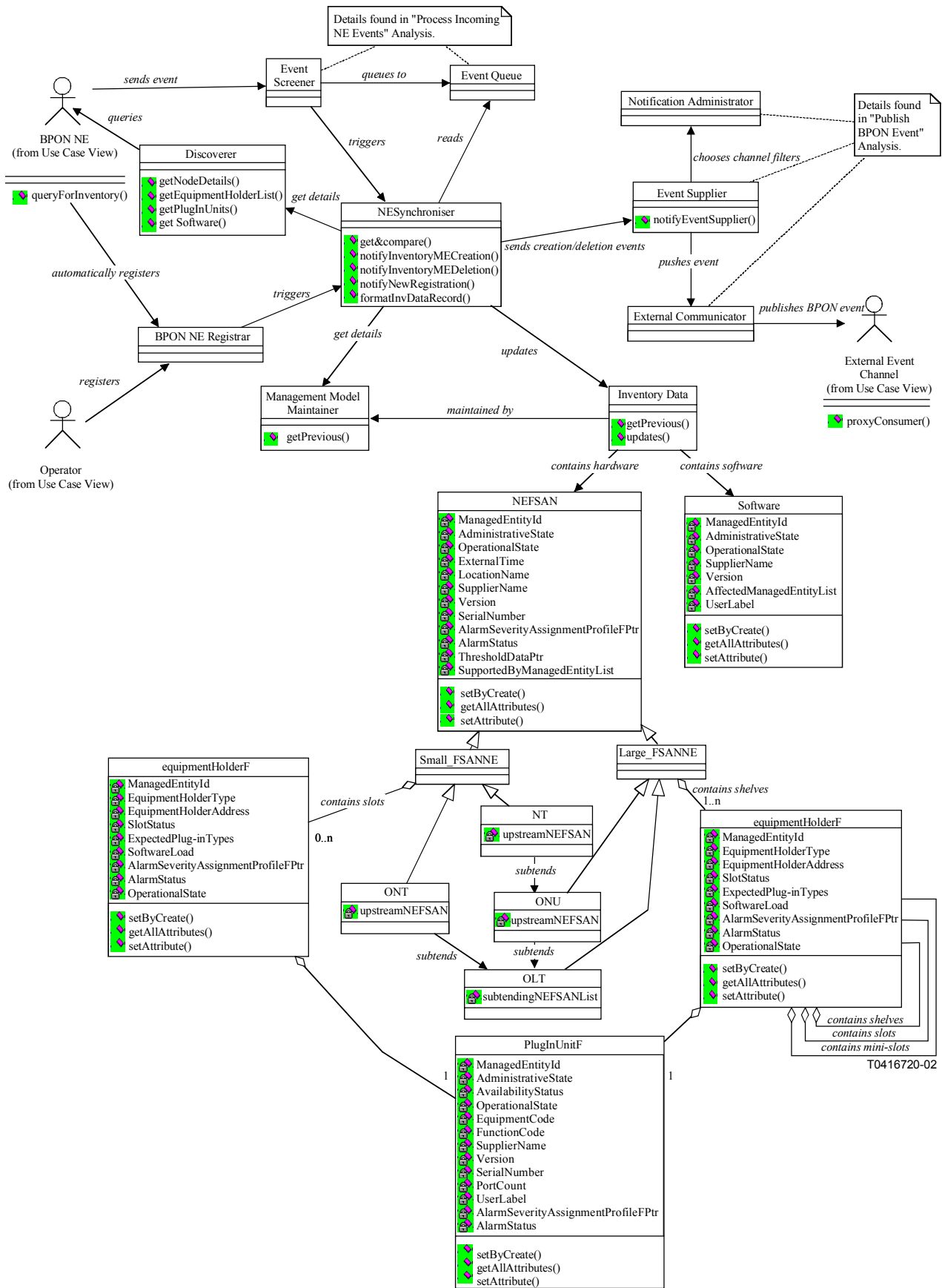

Figure 5-54/Q.834.3 – Autodiscovery for NEs and Plugin Units Class diagram

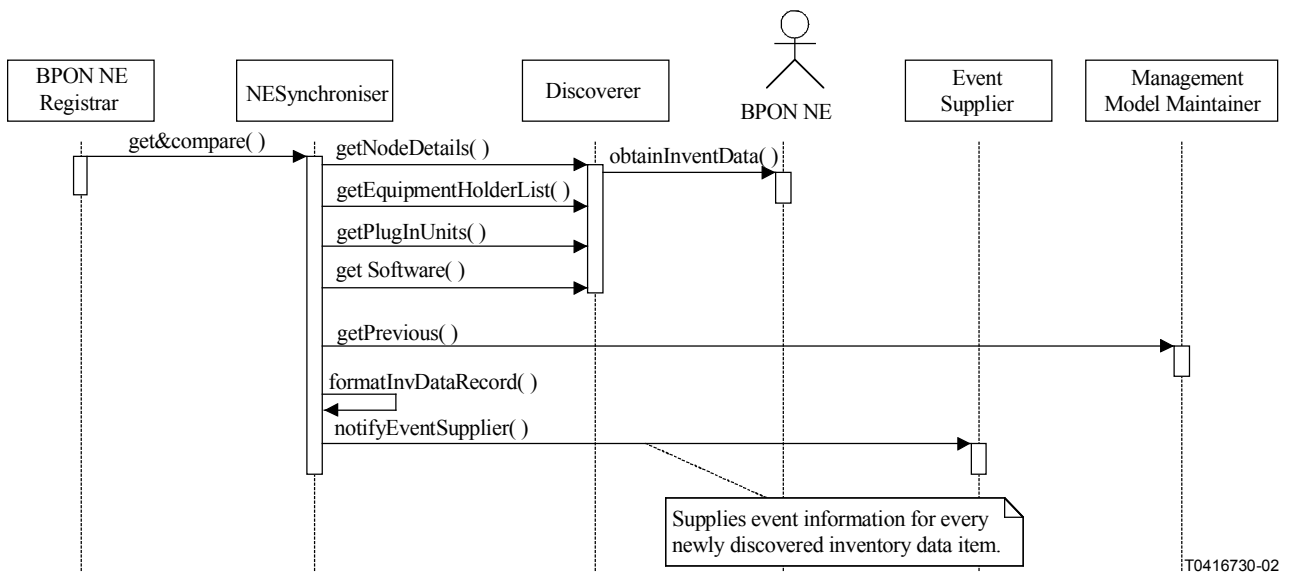

Figure 5-55/Q.834.3 – NE Autodiscovery sequence diagram – Polling

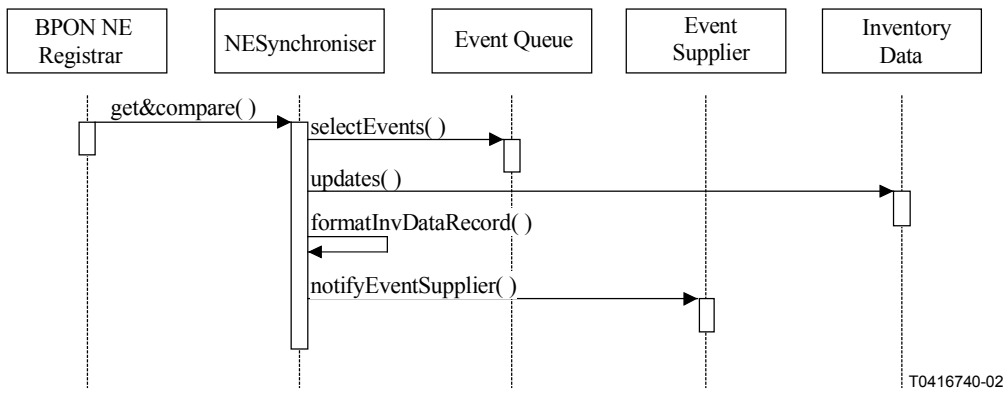

Figure 5-56/Q.834.3 – NE Autodiscovery sequence diagram – Reading NE Events

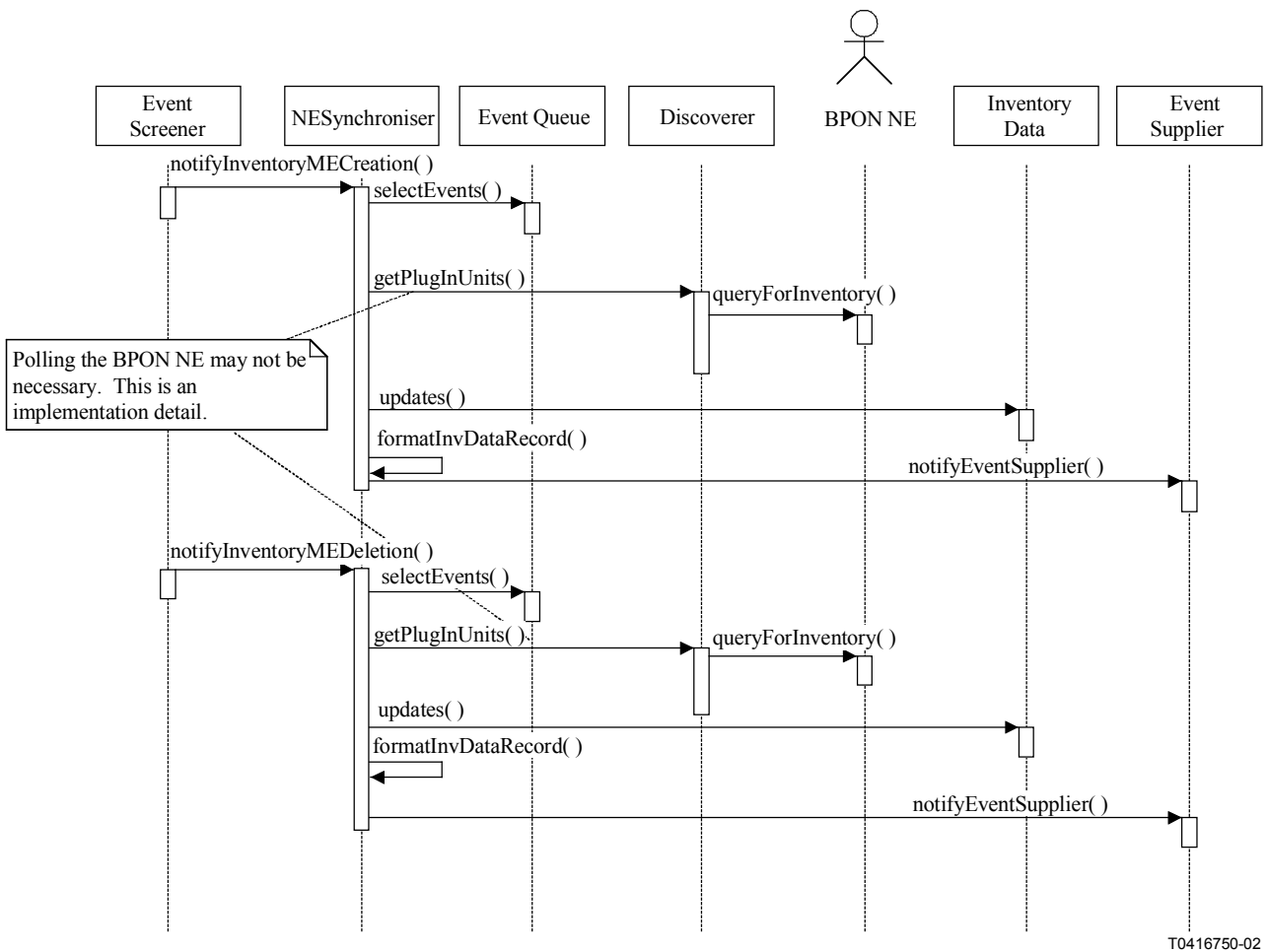

Figure 5-57/Q.834.3 – Plugin Unit Autodiscovery sequence diagram

Managed Entities: NEFSAN, OLT, ONT, ONU, NT, equipmentHolderF, plugInUnitF, softwareF.

5.3.5.2 NE Synchronization

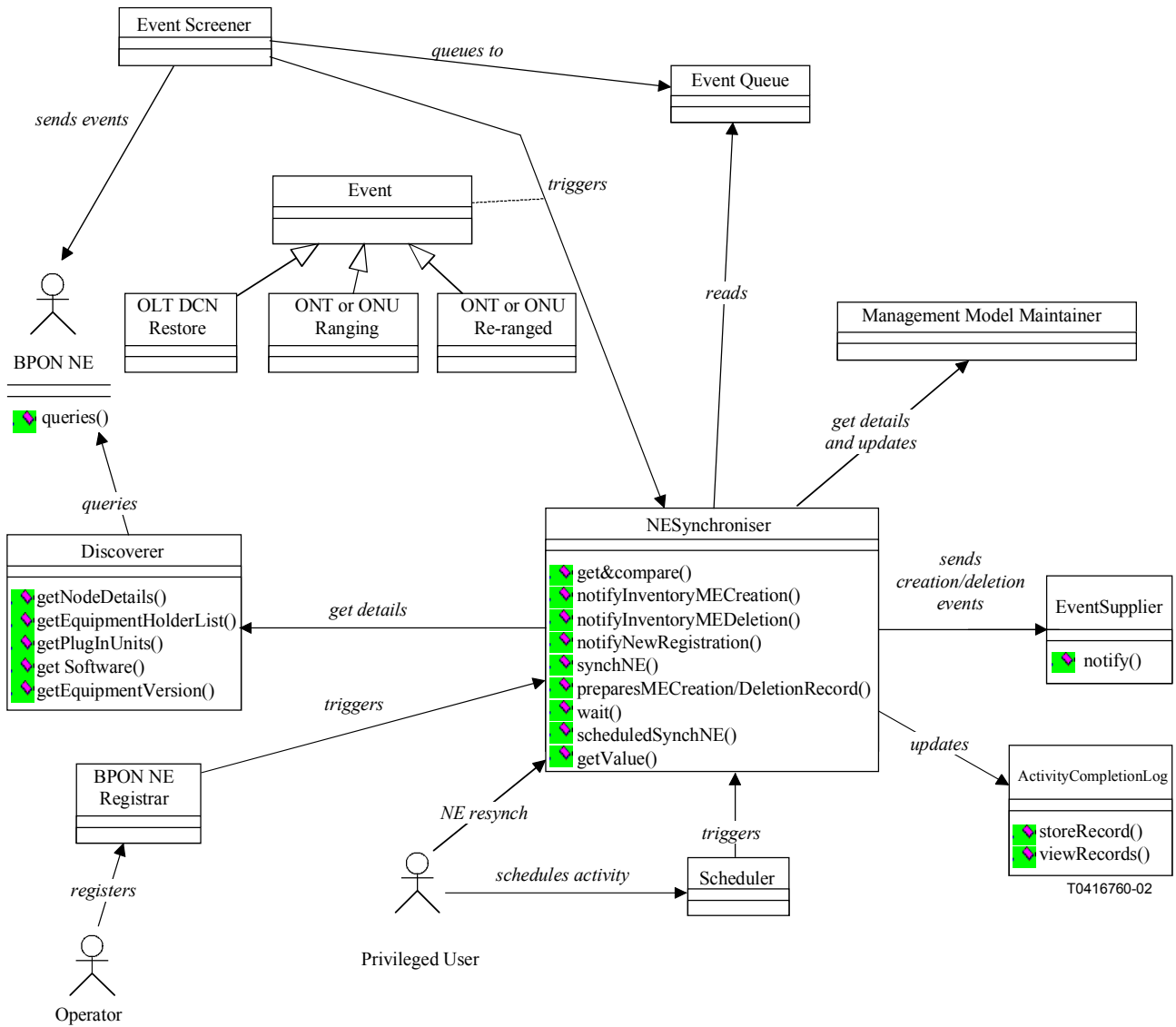

Figure 5-58/Q.834.3 – NE Synchronization class diagram

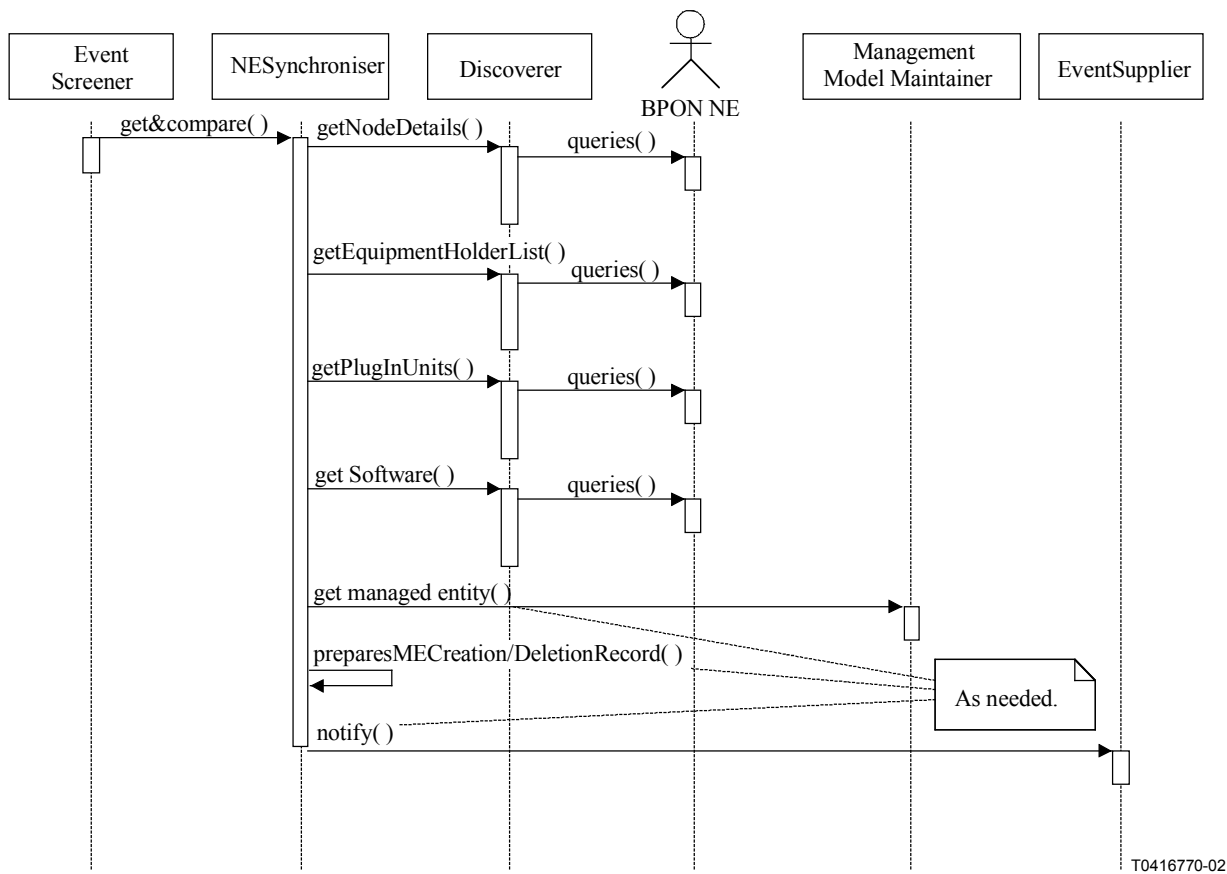
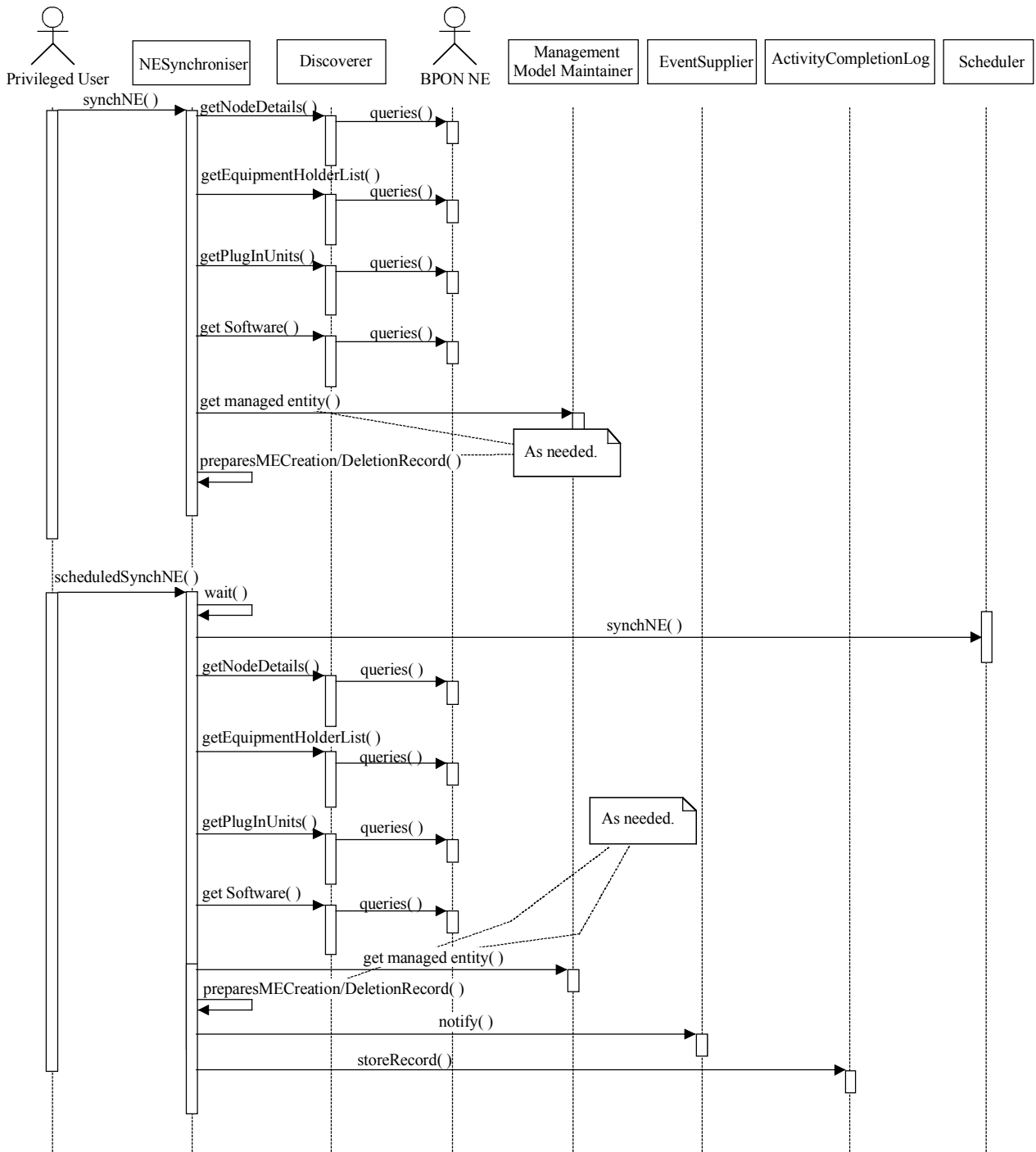

Figure 5-59/Q.834.3 – Event Triggered NE Synchronization sequence diagram

(Please note that the BPON Registrar triggers exactly the same sequence of actions.)



T0416780-02

Figure 5-60/Q.834.3 – NE Synchronization Explicitly Requested by Privileged User sequence diagram

Managed Entities: All.

Operations:

Operation Name	Input Parameters	Return Value	Exceptions
1) scheduledSynchNE	BPON NE User Label Scheduler	void	Unknown BPON NE Unknown Scheduler
2) synchNE	BPON NE User Label	SuccessInd	Unknown BPON NE Comm. Failure Equipment Failure

Exceptions:

Exception Raised	Description
Unknown BPON NE	The identified BPON NE is unknown to the Supplier Management System.
Unknown Scheduler	The identified Scheduler is unknown to the Supplier Management System and cannot be located.
Comm. Failure	There was a DCN link failure while the BPON NE was synchronizing with the Supplier Management System.
Equipment Failure	The BPON NE currently has a failure condition preventing the requested transaction from being completed.

5.3.5.3 Range of ONT or ONU

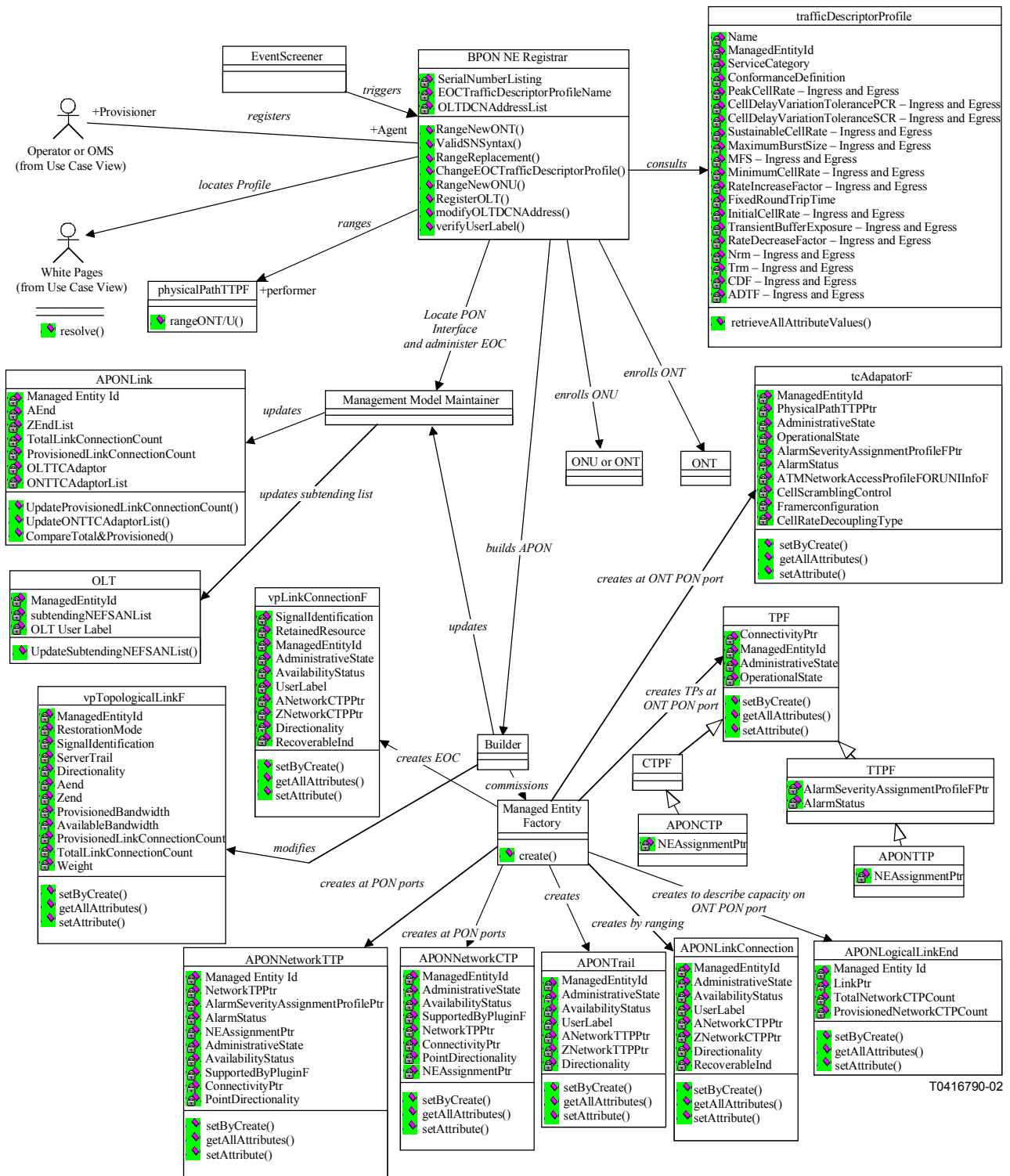

T0416790-02

Figure 5-61/Q.834.3 – Range of ONT or ONU class diagram

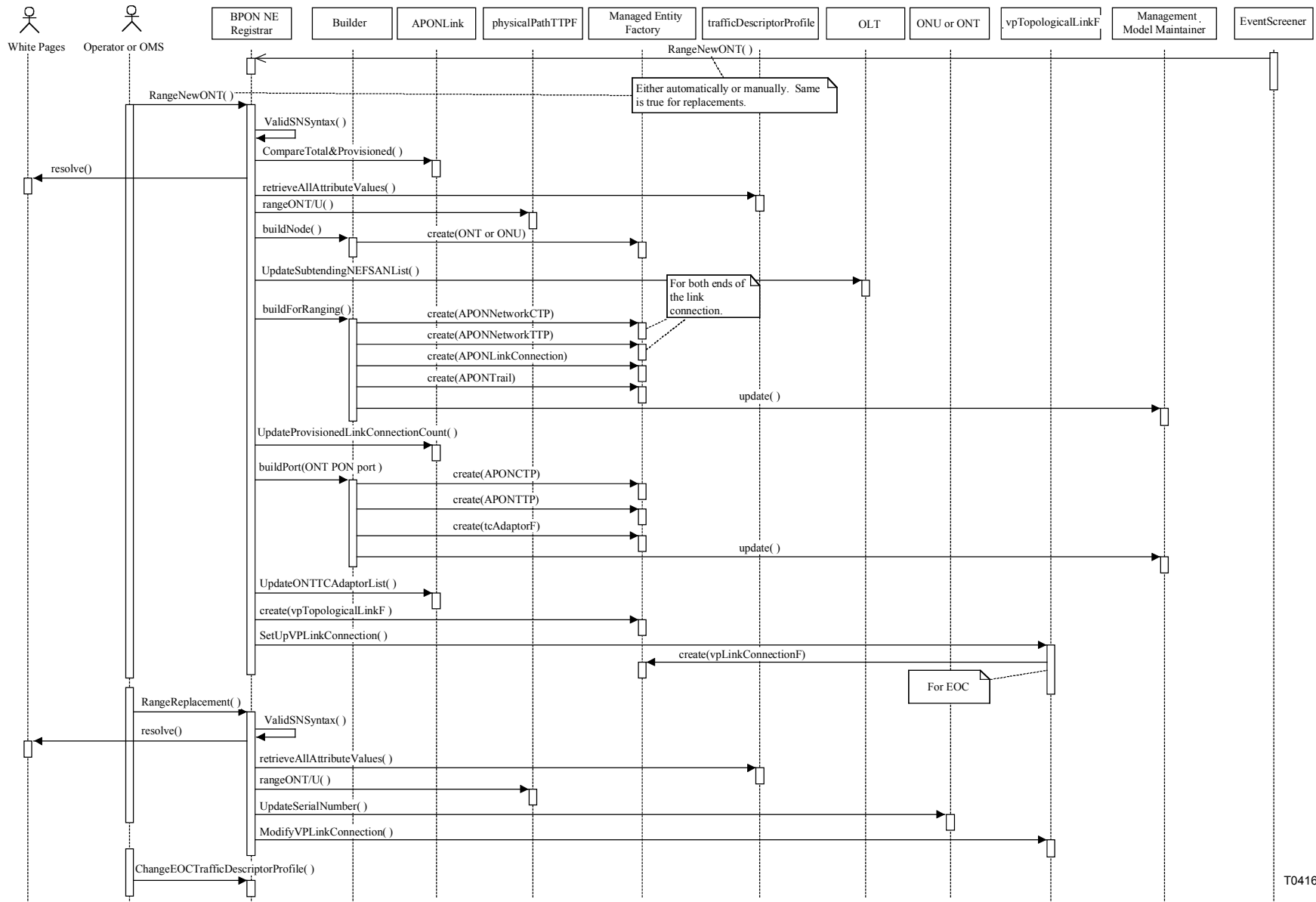

T0416800-02

Figure 5-62/Q.834.3 – Range of ONT or ONU sequence diagram (only ONT shown for sake of clarity)

Managed Entities: ONT, ONU, OLT, APONLink, vpLinkConnectionF, vpTopologicalLinkF, equipmentHolderF, plugInUnitF, APONTTP, APONCTP, APONTrail, APONNetworkCTP, APONNetworkTTP, trafficDescriptorProfileF, tcAdaptorF, APONLinkConnection, and physicalPathTPF.

Operations⁹:

Operations Name	Input Parameters	Return Value	Exceptions
1) RangeNewONT	ONT Serial Number ONT User Label OLT User Label OLT PON Port	ONT Id	Unknown OLT Unknown PON Port Max. Subtending Nodes Exceeded Insufficient PON Bandwidth APON Layer Failure Equipment Failure Duplicate ONU/T User Label Invalid Serial Number Syntax No Response Invalid User Label Syntax Access Denied
2) RangeNewONU	ONU Serial Number ONU User Label OLT User Label OLT PON Port	ONU Id	Unknown OLT Unknown PON Port Max. Subtending Nodes Exceeded Insufficient PON Bandwidth APON Layer Failure Equipment Failure Duplicate ONU/T User Label Invalid Serial Number Syntax No Response Invalid User Label Syntax Access Denied

⁹ The operation "rangeNewONU" has the same behaviour as "rangeNewONT" so there was no apparent need to show another sequence diagram.

Operations Name	Input Parameters	Return Value	Exceptions
3) changeDefaultEOCTrafficDescriptor Profile	NewProfileName	void	Unknown Profiles Access Denied
4) rangeReplacement	New Serial Num PON Index Num OLT User Label OLT PON Port	ONT Id or ONU Id	APON Layer Failure Equipment Failure Unknown PON Port Unknown OLT Invalid Serial Number Syntax No Response Access Denied

Exceptions:

Exception Raised	Description
Unknown OLT	The identified BPON NE is unknown to the Supplier Management System.
Unknown Profiles	The identified traffic descriptor profile is unknown to the Supplier Management System and cannot be located.
APON Layer Failure	There was a APON protocol ranging failure between the OLT and the designed subtending node.
Equipment Failure	The BPON NE currently has a failure condition preventing the requested transaction from being completed.
Unknown PON Port	The identified PON port is unknown (not installed and/or provisioned) to the Supplier Management System.
Duplicate ONU/T User Label	The user label provided on the request is already in use on the Supplier Management System.
Insufficient PON Bandwidth	The ONT or ONU cannot be ranged due to insufficient bandwidth on the APONLink.
Max Subtending Nodes Exceeded	The maximum number of subtending nodes is exceeded with the ranging request.
Invalid Serial Number Syntax	The serial number provided on the request has a syntax that violates supplier implemented rules of syntax.
No Response	The ONT or ONU could not be ranged and the failure was due to something other than a detected problem with the serial number syntax, the APON Layer protocol, or duplicate or invalid user labels.
Invalid User Label Syntax	The User Label provided for the ONU or ONT violates business rules of syntax defined by the operator and implemented in the Supplier Management System.
Access Denied	System is not granted access to this interface object.

5.3.5.4 Register OLT

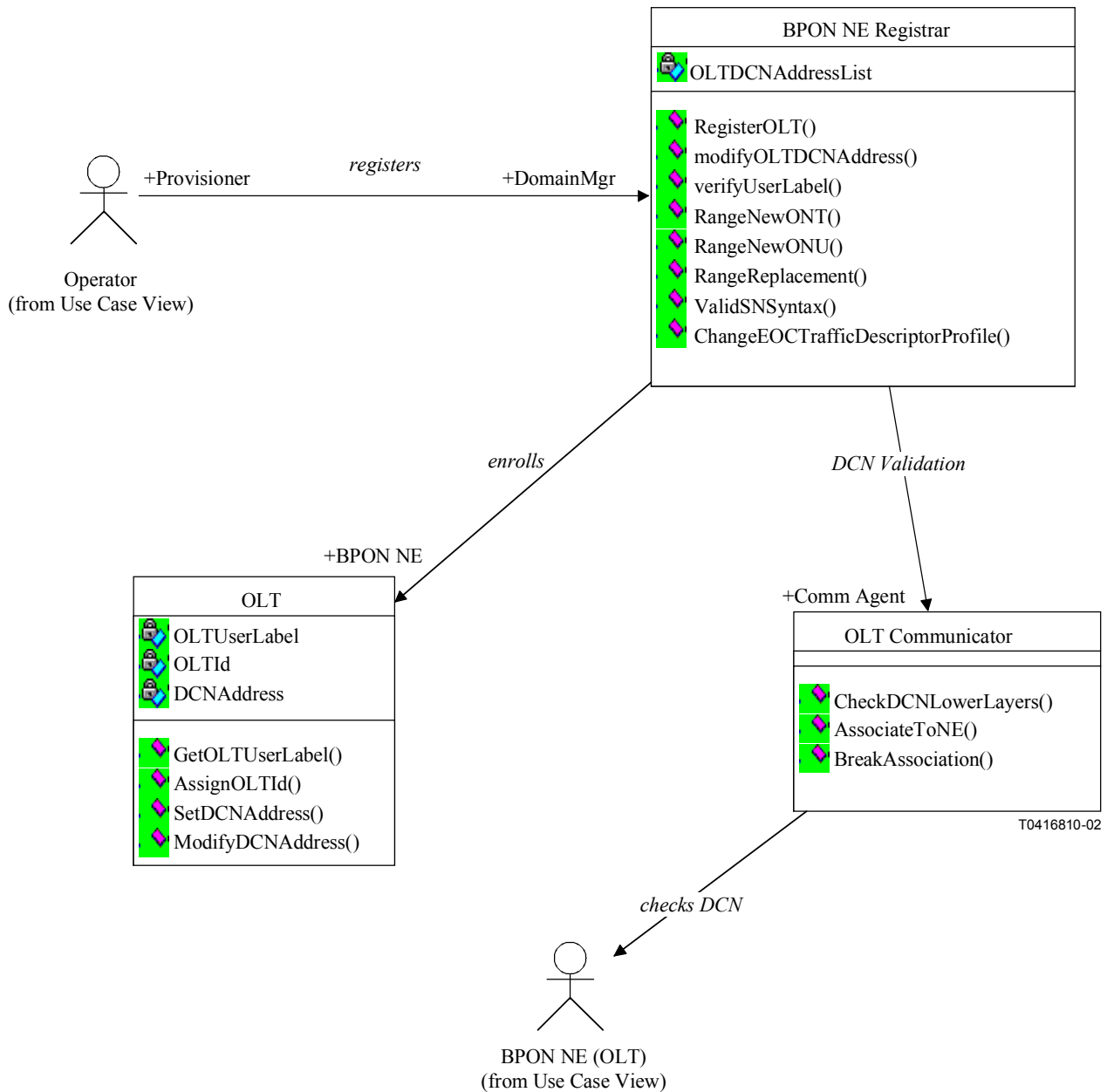
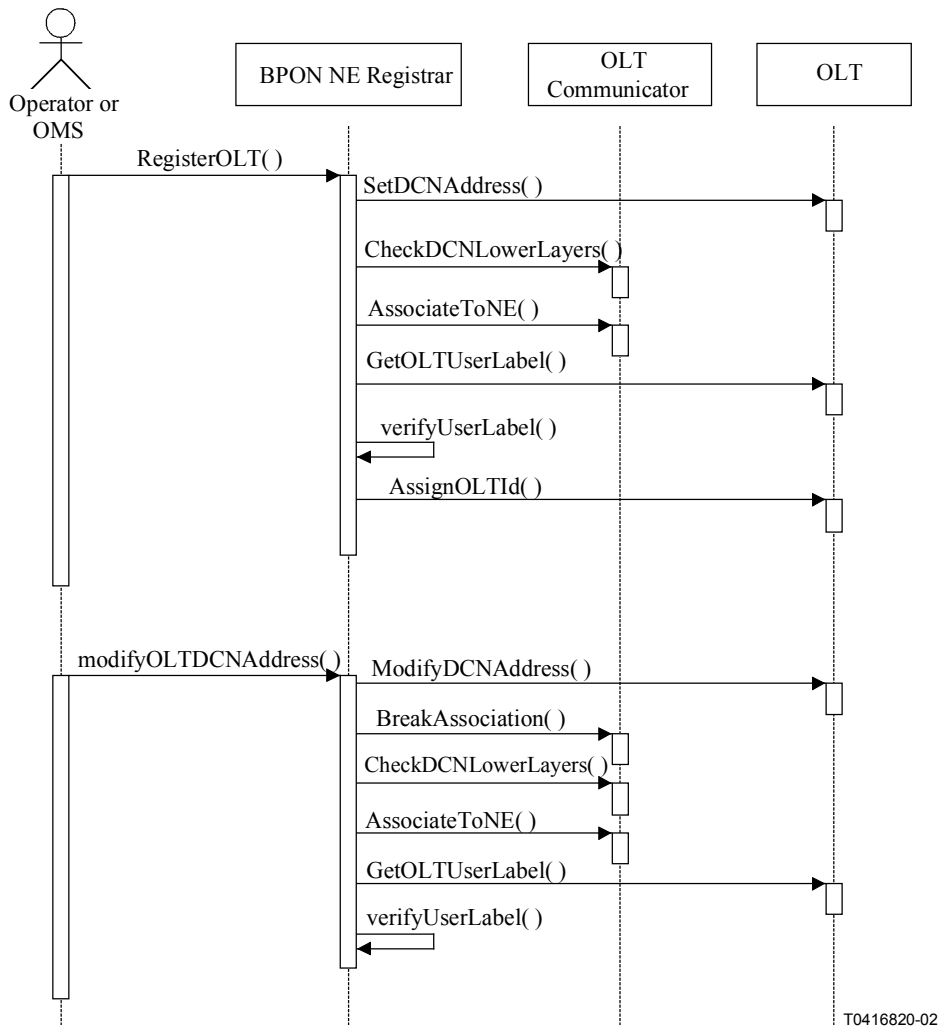

Figure 5-63/Q.834.3 – Register OLT class diagram



T0416820-02

Figure 5-64/Q.834.3 – Register OLT sequence diagram

Managed Entities: OLT.

Operations:

Operation Name	Input Parameters	Return Value	Exceptions
1) RegisterOLT	OLT User Label OLT DCN Addr	OLT Id	DCN Timeout Too Many OLTs Cannot Assign OLTId Cannot Retrieve User Label Denied Access Address/Label Mismatch Duplicate OLT User Label Access Denied
2) modifyOLTDCNAddress	OLT User Label Current DCN Addr New DCN Addr	void	Address/Label Mismatch Cannot retrieve User Label Denied Access DCN Timeout Access Denied

Exceptions:

Exception Raised	Description
Address/Label Mismatch	The identified BPON NE does not have the current DCN Address provided in the request.
Cannot Retrieve User Label	The Supplier Management System was unable to read the User Label provisioned on the OLT.
Denied Access	The Supplier Management System is denied access to the OLT.
DCN Timeout	The DCN Link failed during the Use Case.
Duplicate OLT User Label	The OLT User Label is in use.
Too Many OLTs	The Supplier Management System can not manage one more OLT.
Cannot Assign OLTId	The Supplier Management System was unable to set the OLT Id, thus indicating that the Supplier Management System is unable to manage the OLT.
Access Denied	System is not granted access to this interface object.

5.3.6 Provisioning

Figure 5-65 shows interactions between external actors and classes internal to the Supplier Management System when BPON equipment and services are being provisioned. This diagram serves to consolidate and provide consistency to the subsequent diagrams found within this clause.

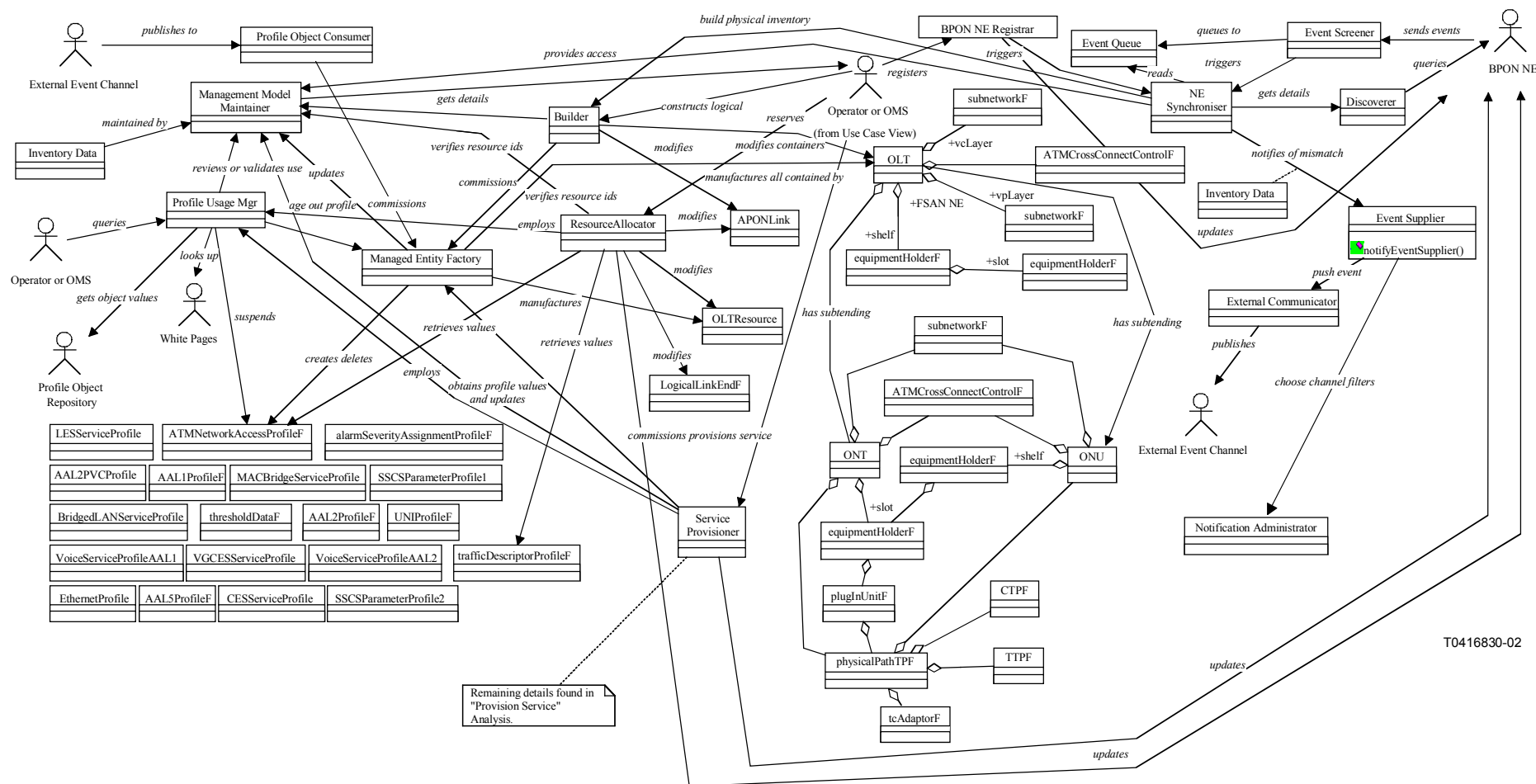

T0416830-02

Figure 5-65/Q.834.3 – Provisioning class diagram

5.3.6.1 Build BPON Resources

This clause shows the construction of management infrastructure to support the management of an OLT, an ONT or ONU, and of a port. In each case, a class diagram is followed by the associated sequence diagram.

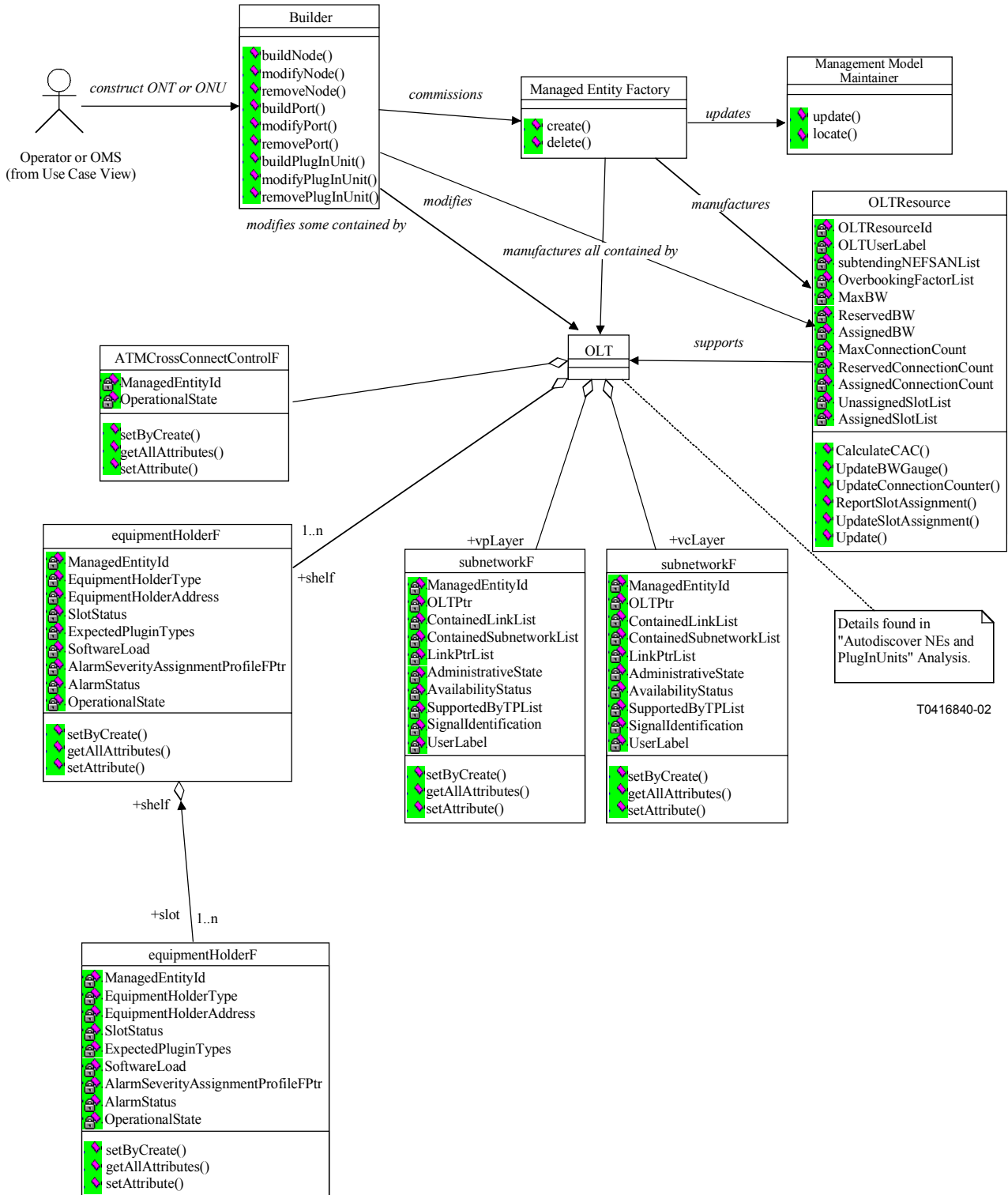
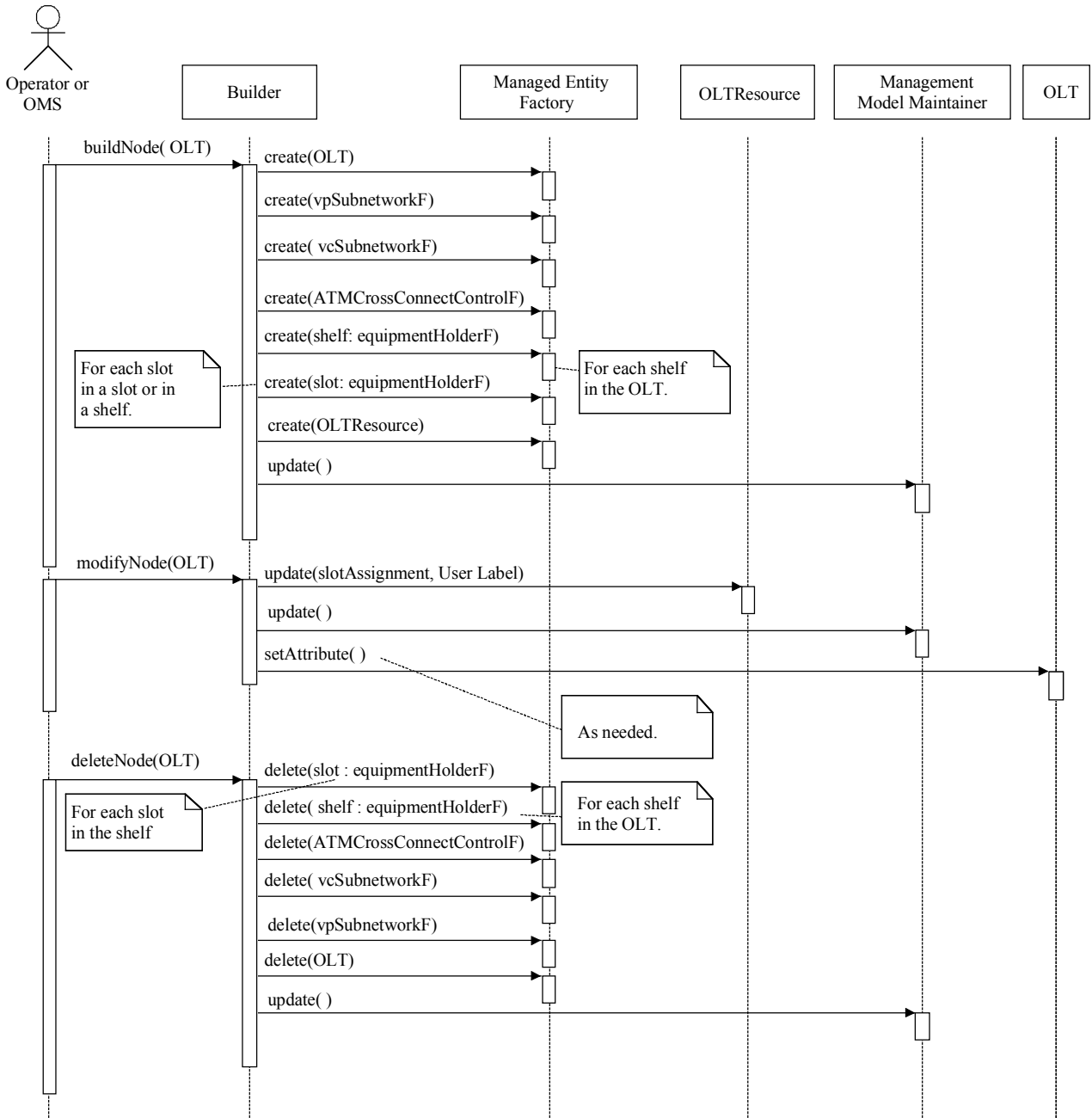
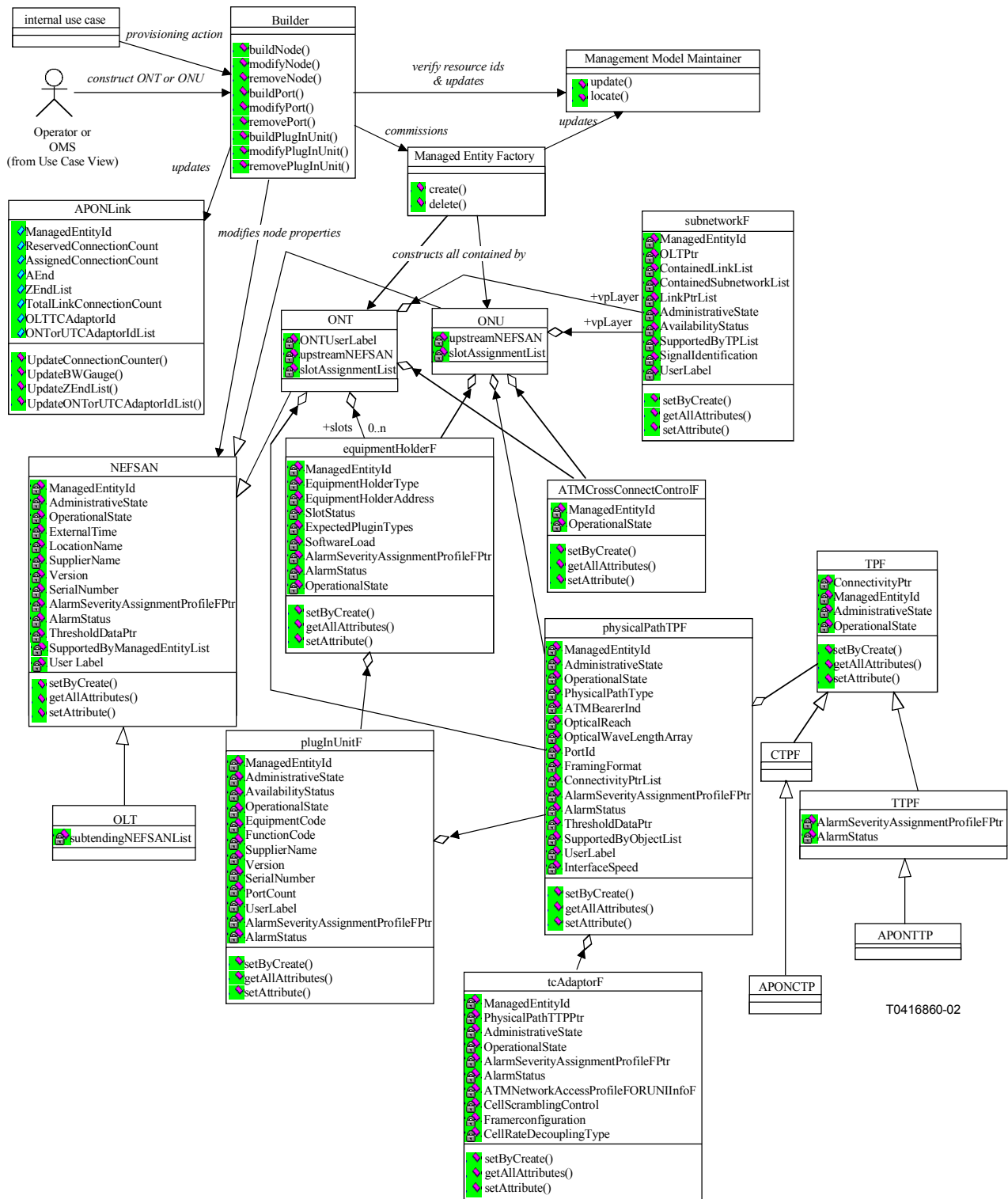

Figure 5-66/Q.834.3 – Build OLT class diagram



T0416850-02

Figure 5-67/Q.834.3 – Build OLT sequence diagram



T0416860-02

Figure 5-68/Q.834.3 – Build ONT or ONU class diagram

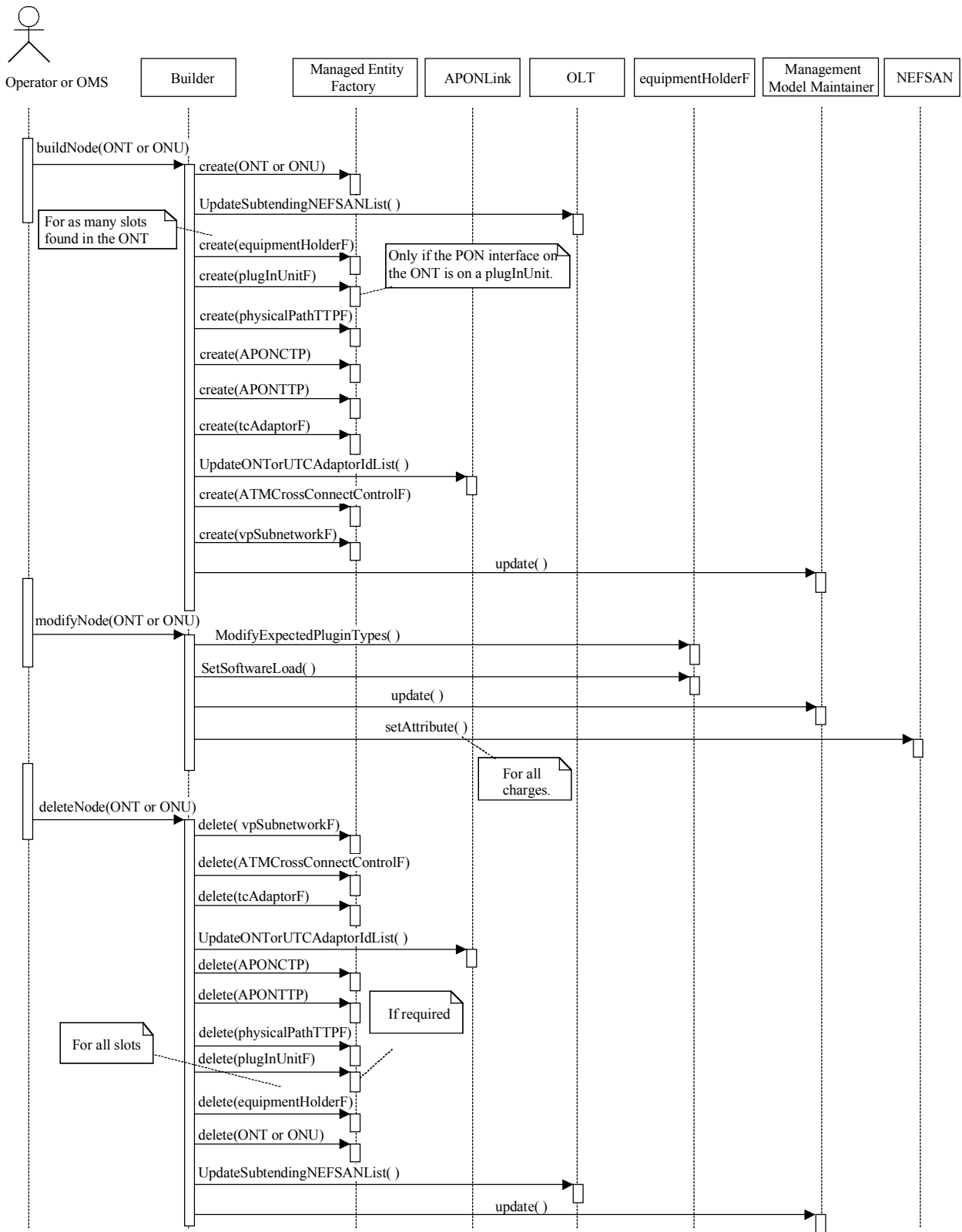

T0416870-02

Figure 5-69/Q.834.3 – Build ONT or ONU sequence diagram

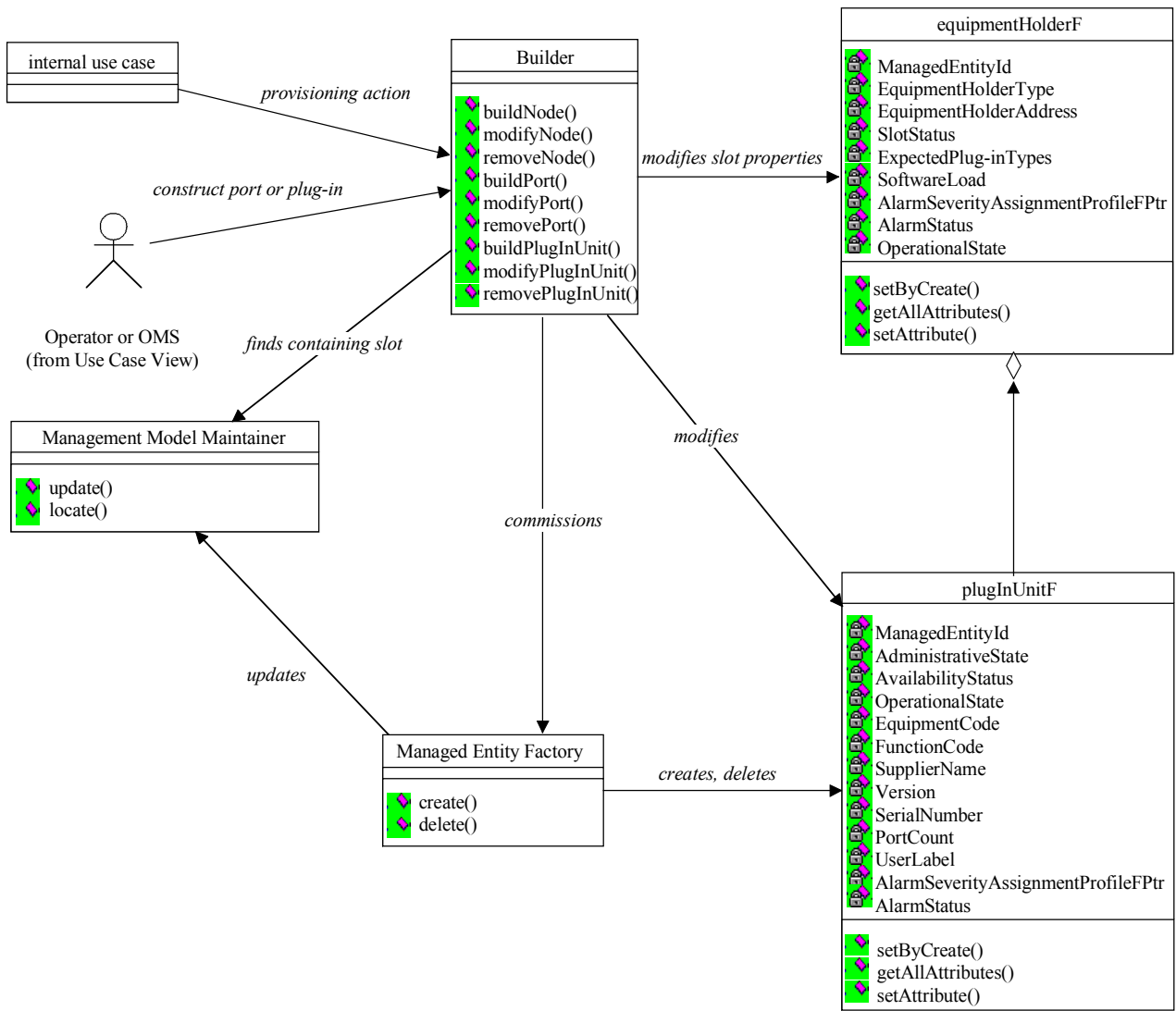

T0416880-02

Figure 5-70/Q.834.3 – Build PlugInUnit class diagram

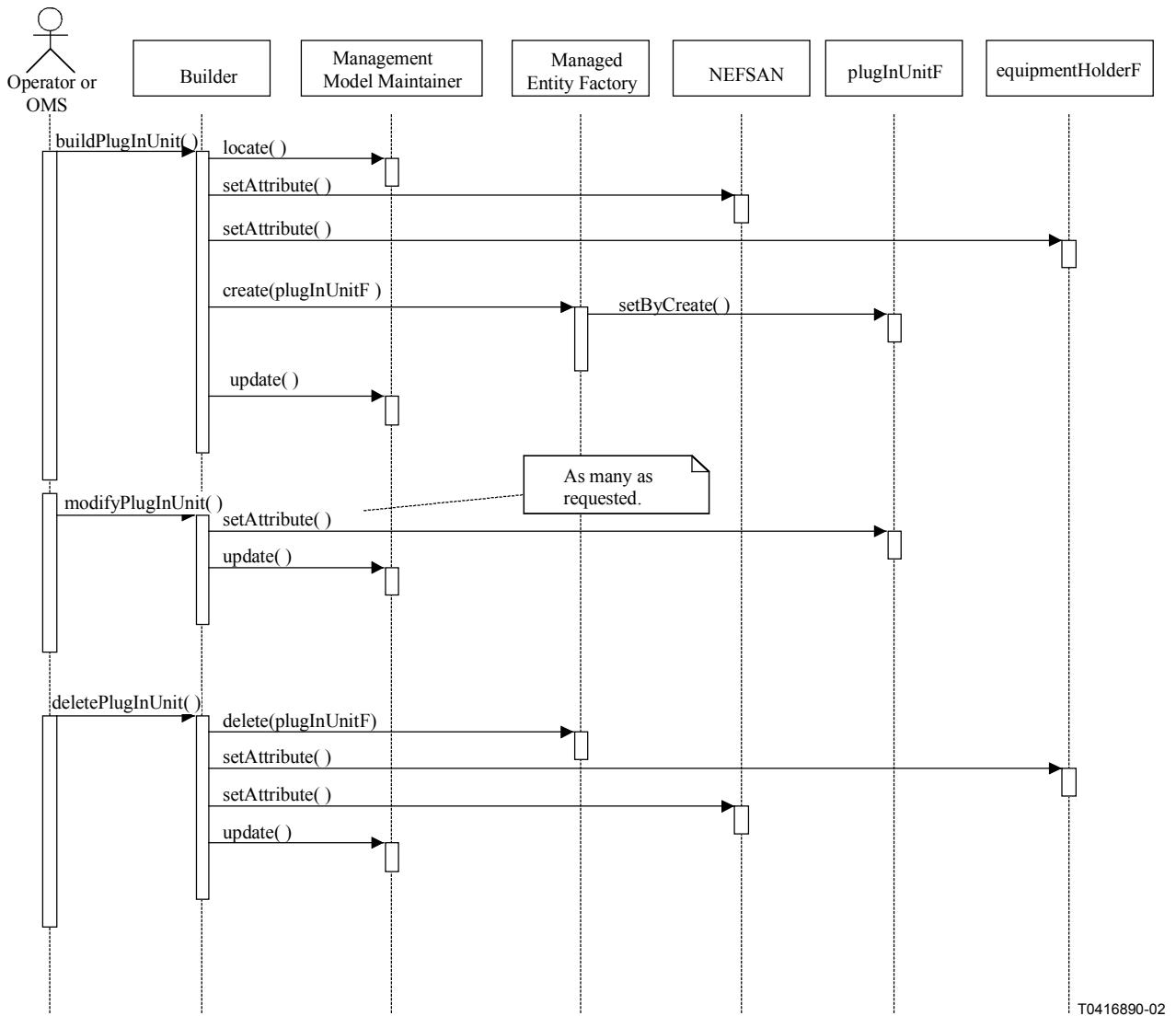

T0416890-02

Figure 5-71/Q.834.3 – Build PlugInUnit sequence diagram

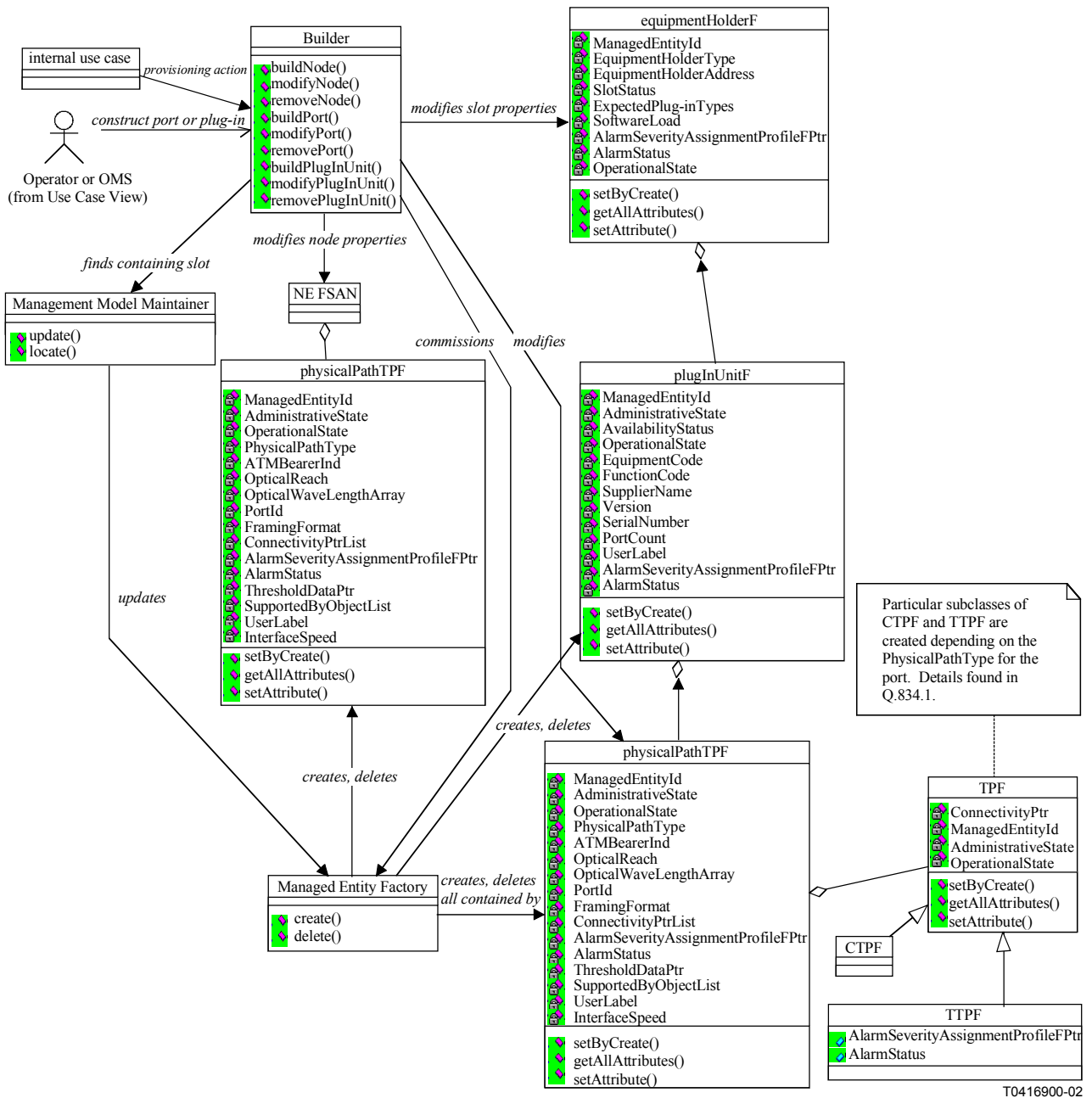
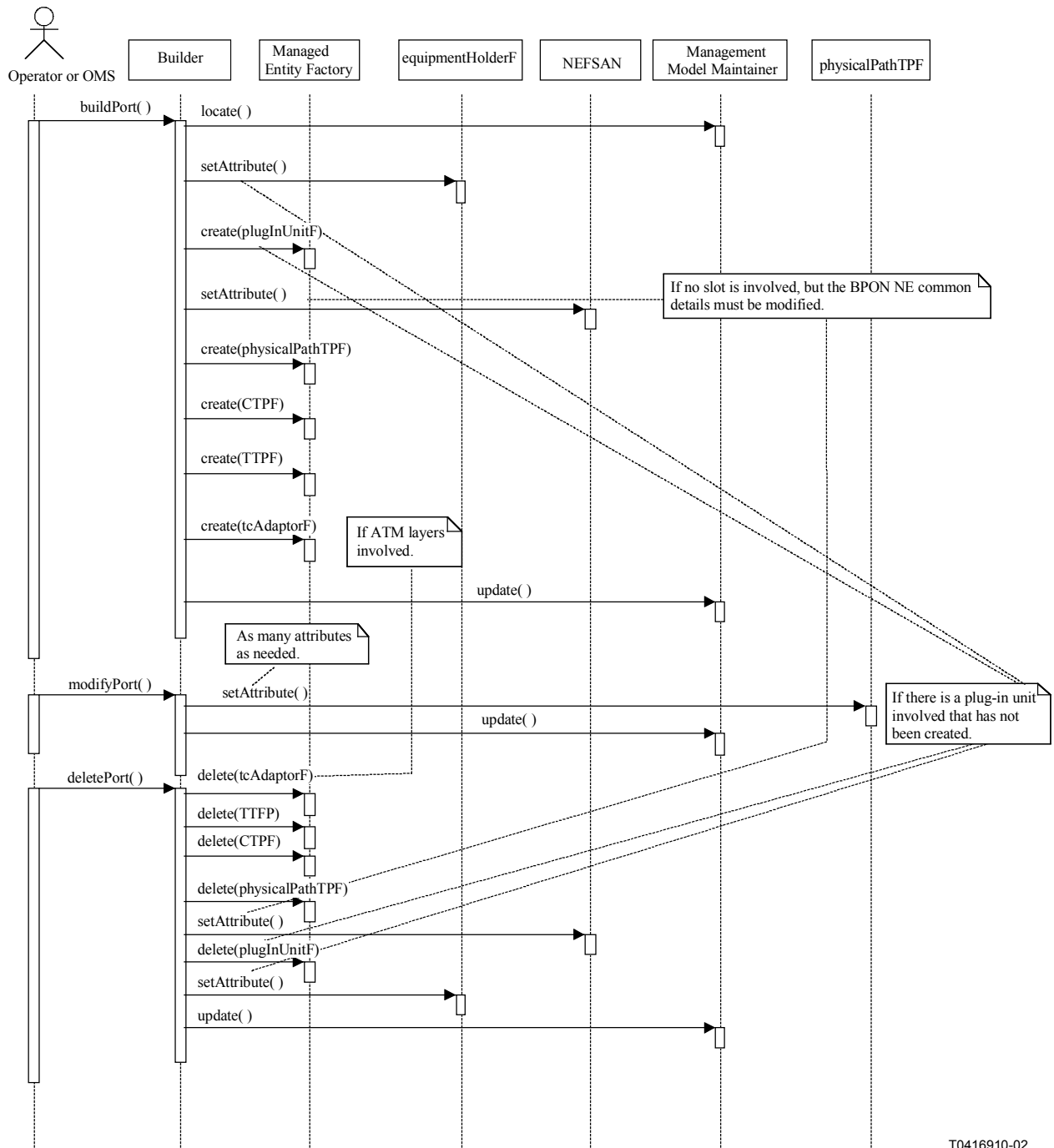

Figure 5-72/Q.834.3 – Build Port class diagram



T0416910-02

Figure 5-73/Q.834.3 – Build Port sequence diagram

Managed Entities: OLT, ONT, ONU, NT, BICIF, BISSIF, UNIF, plugInUnitF, equipmentHolderF, vpSubnetworkF, vcSubnetworkF, physicalPathTPF, tcAdaptorF, APONTTP, APONCTP, DS1TTP, DS1CTP, DS3TTP, DS3CTP, au3CTP, au4CTP, adslTTPF, adslCTPF, vdslTTPF, vdslCTPF, cellBasedTTPF, cellBasedCTPF, E1TTPF, E1CTPF, E3TTPF, E3CTPF, msTTPF, msCTPF, rsTTPF, rsCTPF, v3TTPF, v4TTPF, EthernetCTPF, EthernetTTPF, VoiceTTPF, VoiceCTPF, atmCrossConnectControlF.

Management Support Entities: OLT Resource.

Operations:

Operation Name	Input Parameters	Return Value	Exceptions
1) buildNode	BPON NE Type Supplier Name External Time Location Name Version Serial Number AlarmProfileObjectList ThresholdDataProfileObjectList SlotAssignmentList OLT PON Port UserLabel	NEFSANId	Unknown External Time Source Unrecognized Version Invalid Serial Number Duplicate Serial Number Unknown Profiles Invalid SlotAssignmentList Unknown Managed Entity Id Duplicate User Label Access Denied
2) modifyNode	NEFSAN User Label NewSlotAssignmentList External Time AlarmProfileObjectList ThresholdDataProfileObjectList OLT PON Port	void	Unknown NE Invalid SlotAssignmentList Unknown External Time Source Unknown Profiles Access Denied
3) deleteNode	NEFSAN User Label	void	Unknown NE Remaining Contained Managed Entities Access Denied
4) buildPort	NEFSAN User Label PhysicalPathType UserLabel ATMBearerInd OpticalReach OpticalWavelengthArray PortId FrameFormat InterfaceSpeed AlarmProfileObject ThresholdDataProfileObject	TerminationPointsList	Unknown NE Duplicate User Label Invalid Parameter Value Unknown Profiles Access Denied

Operation Name	Input Parameters	Return Value	Exceptions
5) modifyPort	PhysicalPathTPIId LabelAlarmProfileObject ThresholdDataProfileObject	void	Unknown Managed Entity Id Unknown Profiles Access Denied
6) deletePort	PhysicalPathTPIId	void	Unknown Managed Entity Id Remaining Contained Managed Entities Access Denied
7) buildPlugInUnit	NEFSAN User Label AlarmProfileObject User Label Version Equipment Code Function Code Serial Number	PlugInUnitFId	Unknown NE Duplicate User Label Invalid Parameter Value Unknown Profiles Unrecognized Version Invalid Serial Number Duplicate Serial Number Access Denied
8) modifyPlugIn Unit	PlugInUnitFId AlarmProfileObject Equipment Code Function Code	void	Unknown Managed Entity Id Unknown Profiles Access Denied
9) deletePlugInUnit	PlugInUnitFId	void	Unknown Managed Entity Id Remaining Contained Managed Entities Access Denied

Exceptions:

Exception Raised	Description
Unknown Managed Entity Id	Identifier for plugInUnit or portisunknown to the Supplier Management System.
Unknown NE	Identified NE is unknown to the Supplier Management System.
Duplicate User Label	Existing equipment identified with this user label.
Unknown Profiles	Name for profile object unknown to the Supplier Management System and cannot be retrieved via White Pages.
Invalid Parameter Value	Parameter named in the exception has value lying outside permitted range of values.
Invalid SlotAssignmentList	Expected slot provisioning rules are violated by slot assignment provided.
Remaining Contained Managed Entities	Contained circuit packs or equipment holders have not been deleted yet.
Unknown External Time Source	External time source unknown to the Supplier Management System.
Unrecognized Version	Equipment version provided does not match known values.
Invalid Serial Number	Syntax of the serial number provided does not match definition rules.
Duplicate Serial Number	There exists other equipment of the same type with this serial number.
Unknown PON Port	PON port unknown to Supplier Management System.
Access Denied	System is not granted access to this interface object.

5.3.6.2 Profile Object Management

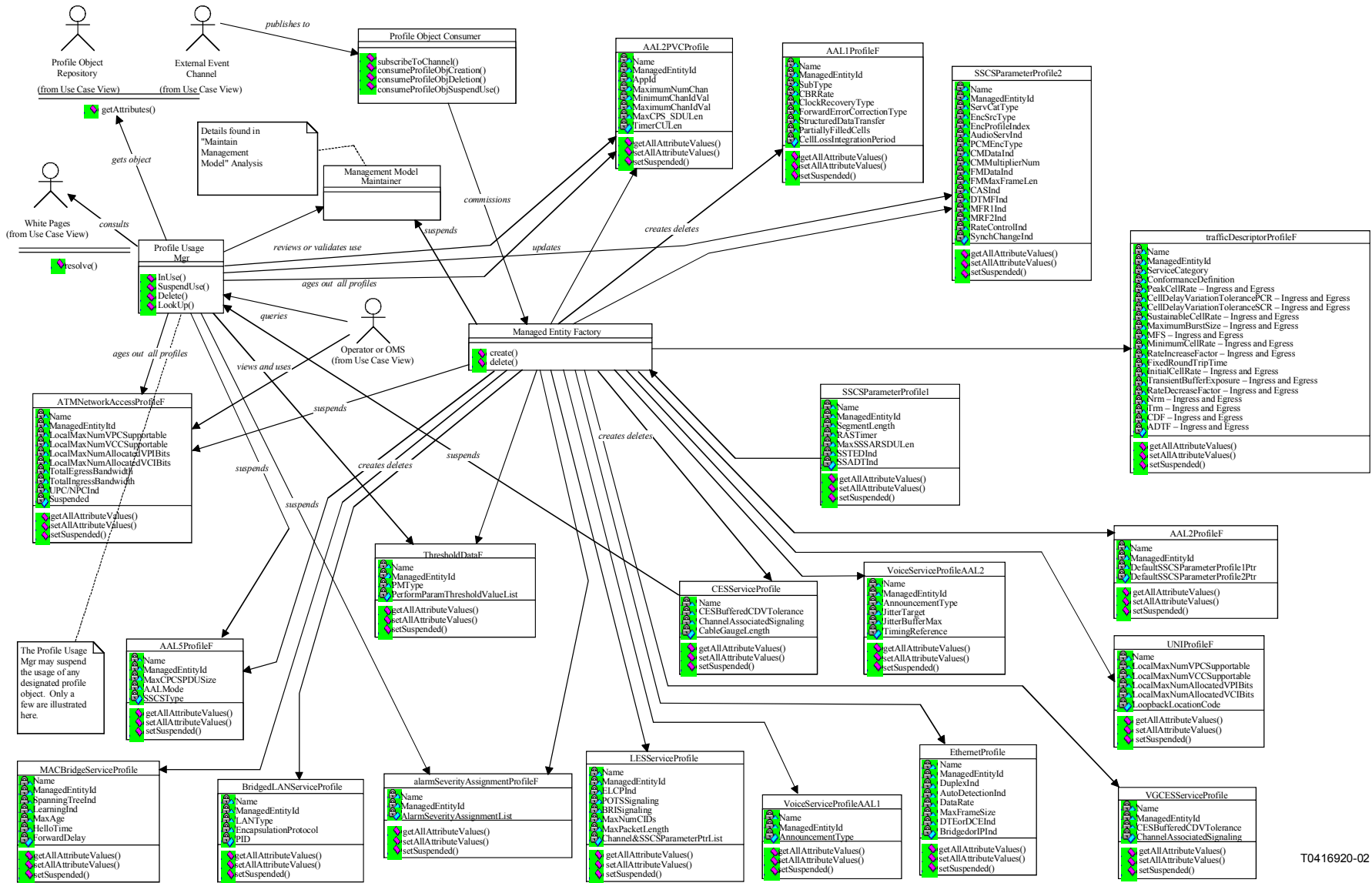
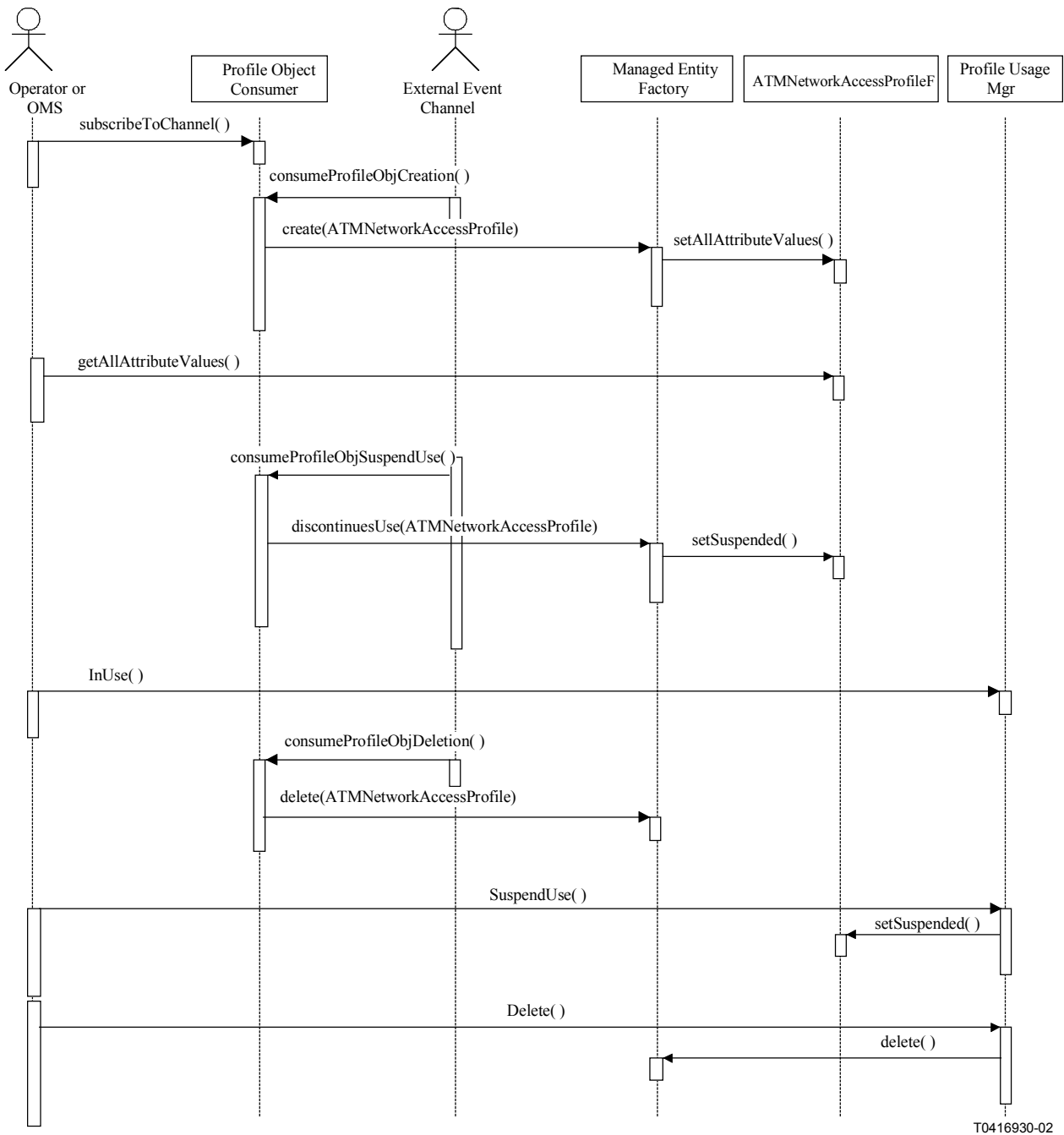

Figure 5-74/Q.834.3 – Profile Object Management class diagram

T0416920-02



T0416930-02

Figure 5-75/Q.834.3 – Profile Object Management sequence diagram – ATMNetworkAccessProfile Example

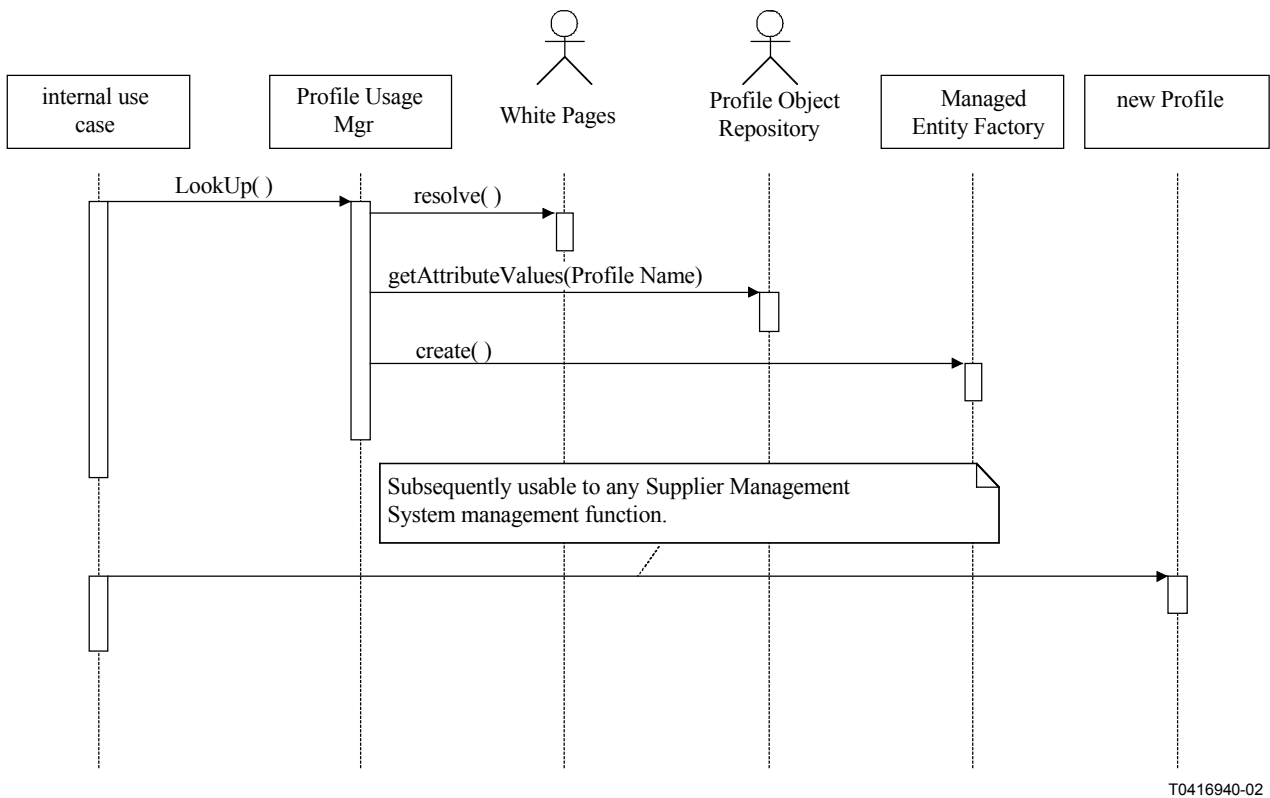

Figure 5-76/Q.834.3 – Profile Object Management – New Supplier Management System

Managed Entities: alarmSeverityAssignmentProfileF, ATMNetworkAccessProfileF, trafficDescriptorProfileF, AAL1ProfileF, AAL5ProfileF, CESServiceProfile, EthernetProfile, UNIPProfileF, IDLCCallProcessingProfile, AAL2Profile, AAL2PVCProfile, DS1Profile, DS3Profile, LESServiceProfile, SSCSPParameterProfile1, SSCSPParameterProfile2, VoiceServiceProfileAAL2, VoiceServiceProfileAAL1, BridgedLANServiceProfile, and MACBridgeServiceProfile.

Operations:

Operation Name	Input Parameters	Return Value	Exceptions
1) SuspendUse	Profile Object Name	void	Unknown Profiles Denied Access
2) InUse	Profile Object Name	InUseIndicator	Unknown Profiles
3) Delete	Profile Object Name	DeletionIndicator	Profile In Use Denied Access
4) consumeProfile ObjectCreation	Event Object	void	

Exceptions:

Exception Raised	Description
Unknown Profiles	The named profile instance is not known to the Supplier Management System and cannot be located via White Pages.
Profile In Use	The named profile is still being used for provisioning service or nodes within the system.
Denied Access	System is not granted access to this interface object.

5.3.6.3 Provision Installed BPON Resources

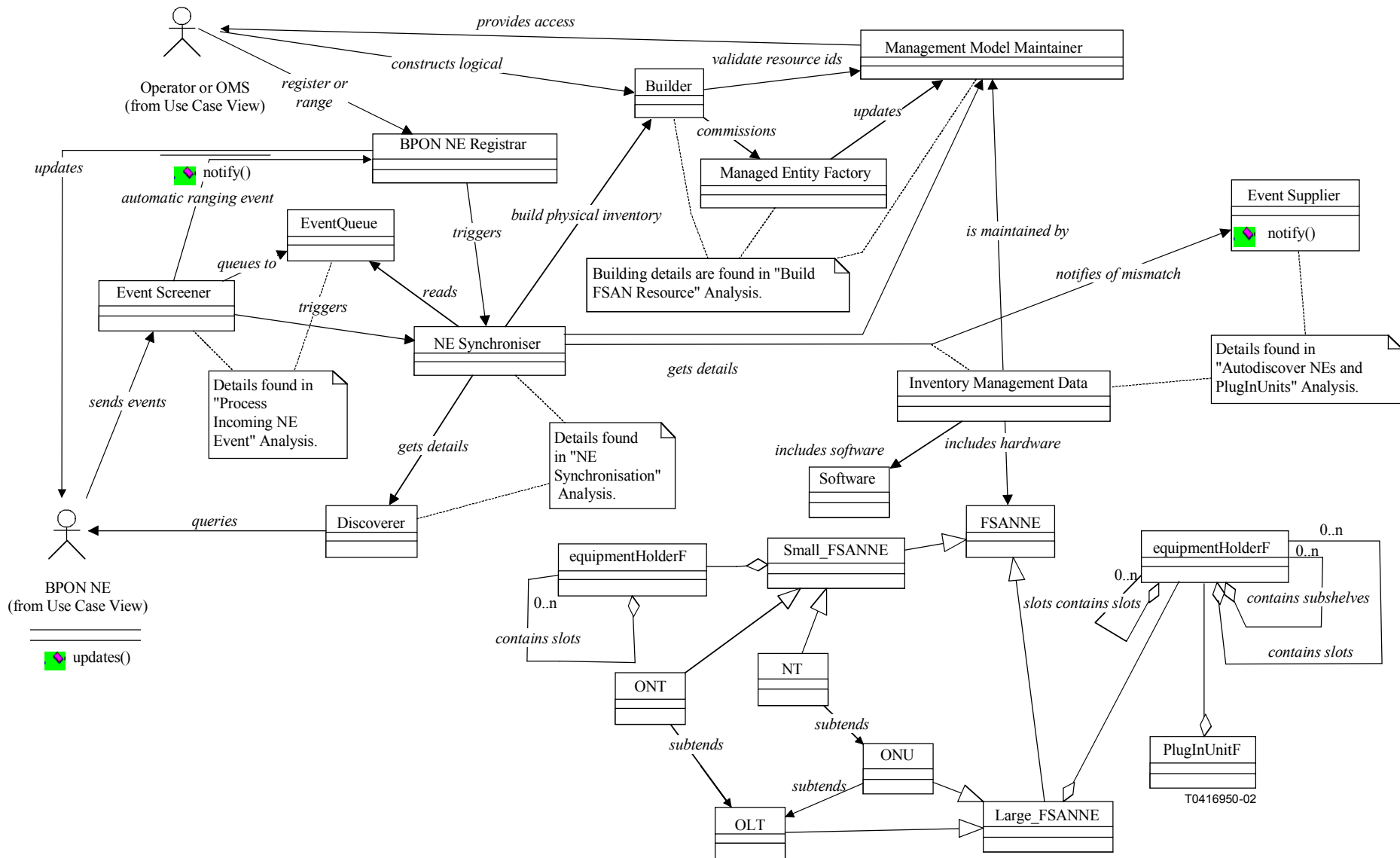
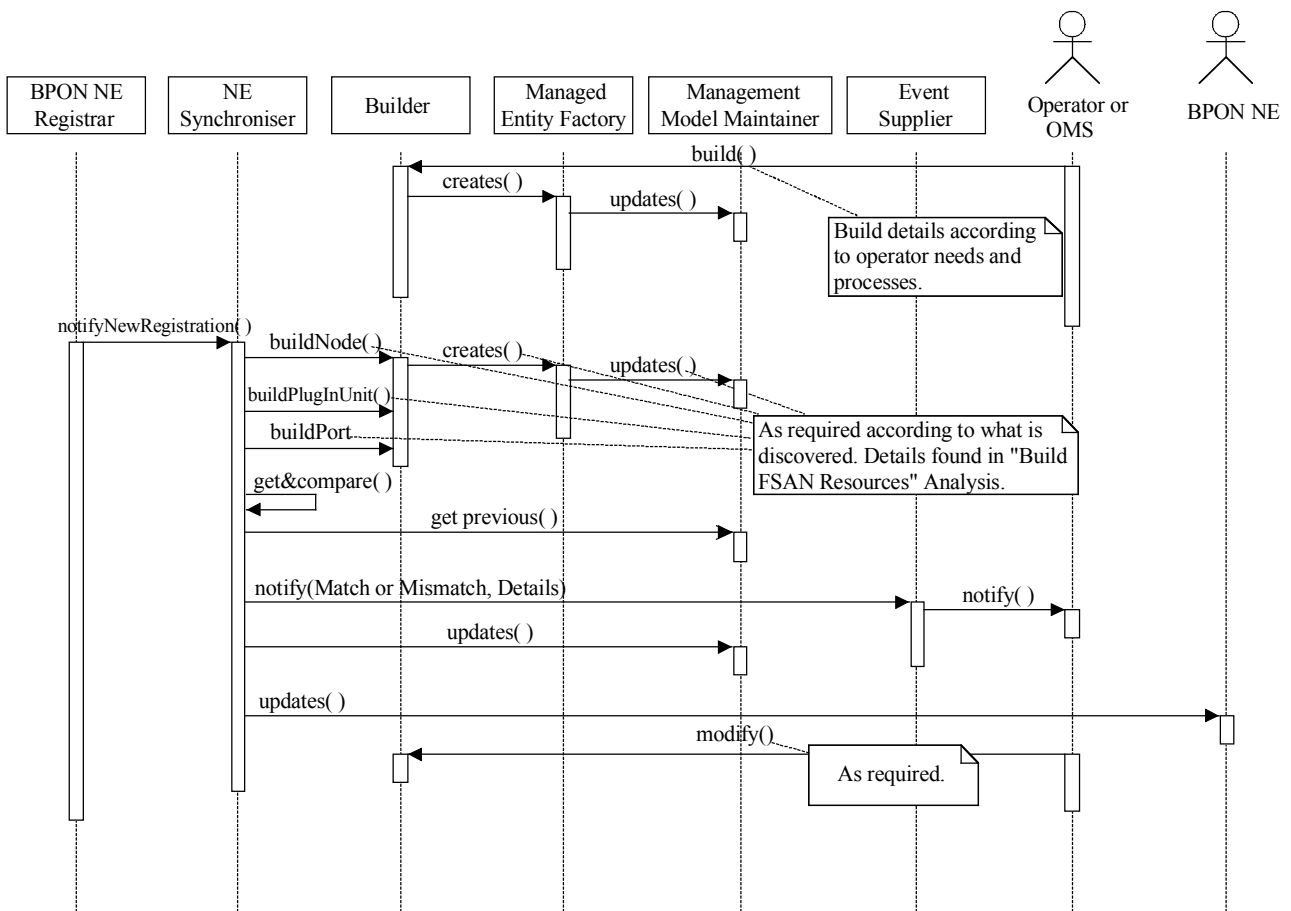

Figure 5-77/Q.834.3 – Provision Installed BPON Resources class diagram



T0416960-02

Figure 5-78/Q.834.3 – Provision Installed BPON Resources sequence diagram with Pre-provisioning

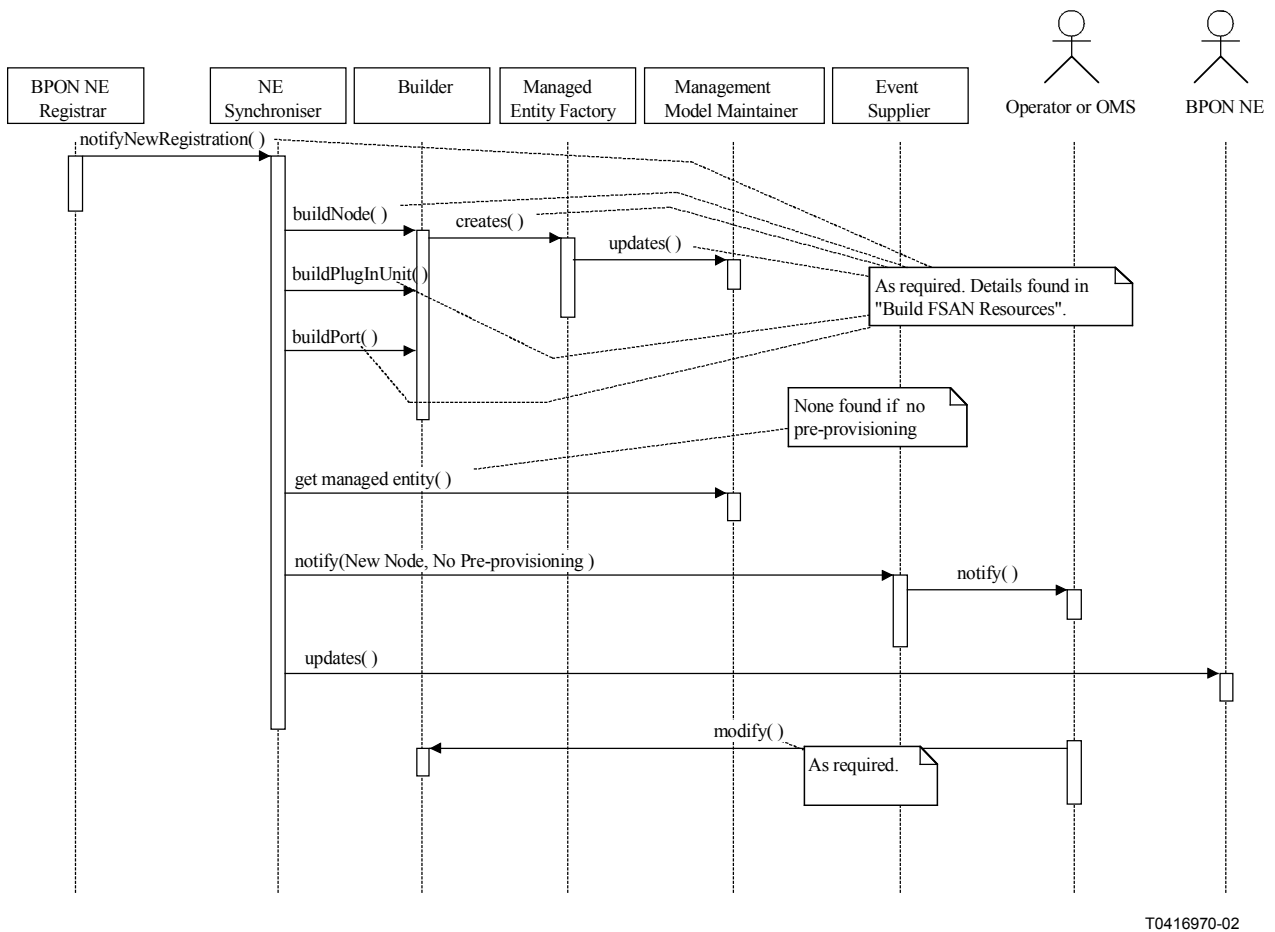

Figure 5-79/Q.834.3 – Provision Installed BPON Resources sequence diagram – No Pre-provisioning

Managed Entities: alarmSeverityAssignmentProfileF, ATMNetworkAccessProfileF, trafficDescriptorProfileF, AAL1ProfileF, AAL5ProfileF, CESServiceProfileF, EthernetProfile, UNIPprofile, IDLCCallProcessingProfile, AAL2Profile, AAL2PVCProfile, DS1Profile, DS3Profile, LESServiceProfile, SSCSPparameterProfile1, SSCSPparameterProfile2, VoiceServiceProfileAAL2, VoiceServiceProfileAAL1, BridgedLANServiceProfile, and MACBridgeServiceProfile, OLT, ONT, ONU, NT, plugInUnitF.

5.3.6.4 Provision Service

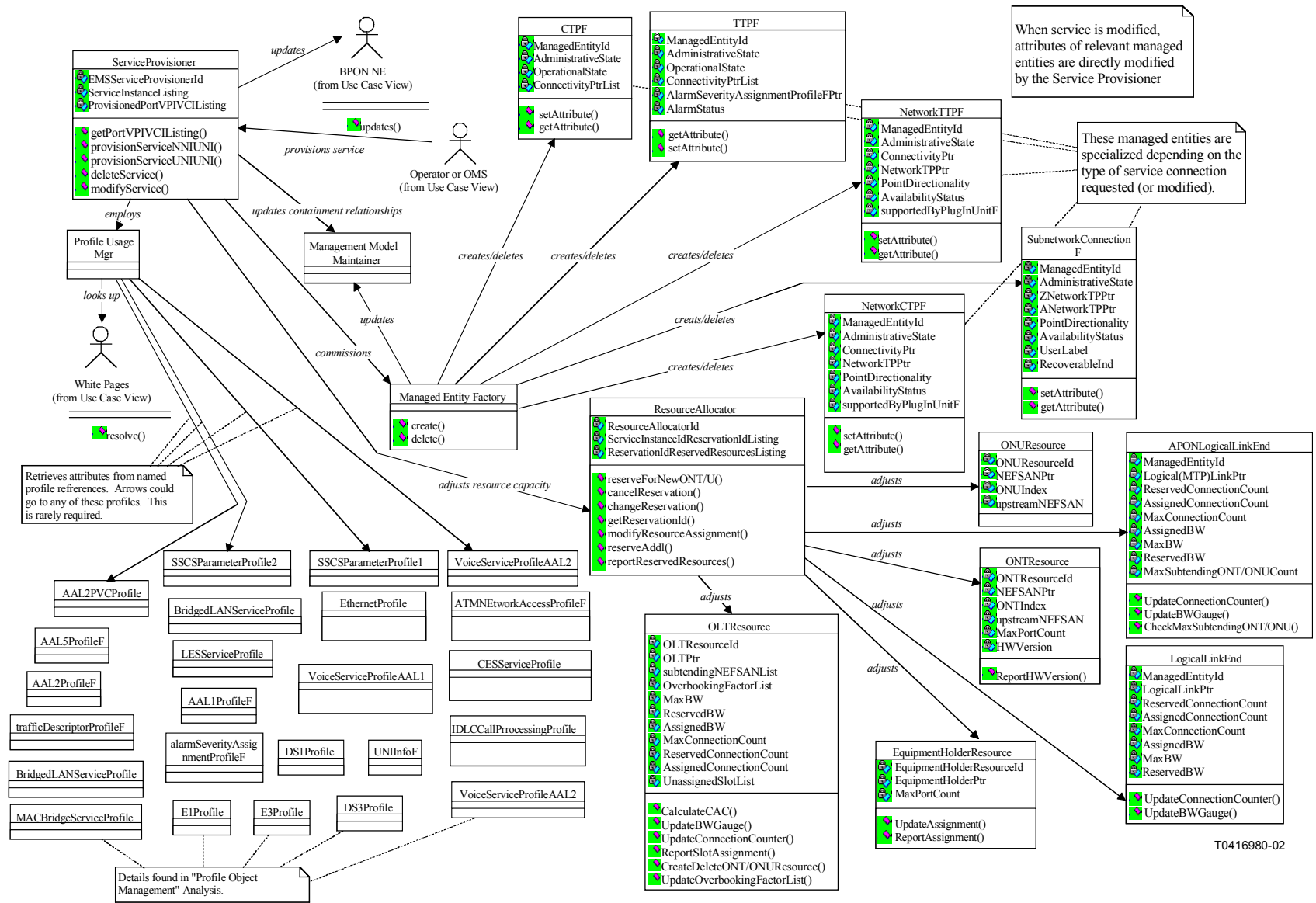

Figure 5-80/Q.834.3 – Provision Service class diagram

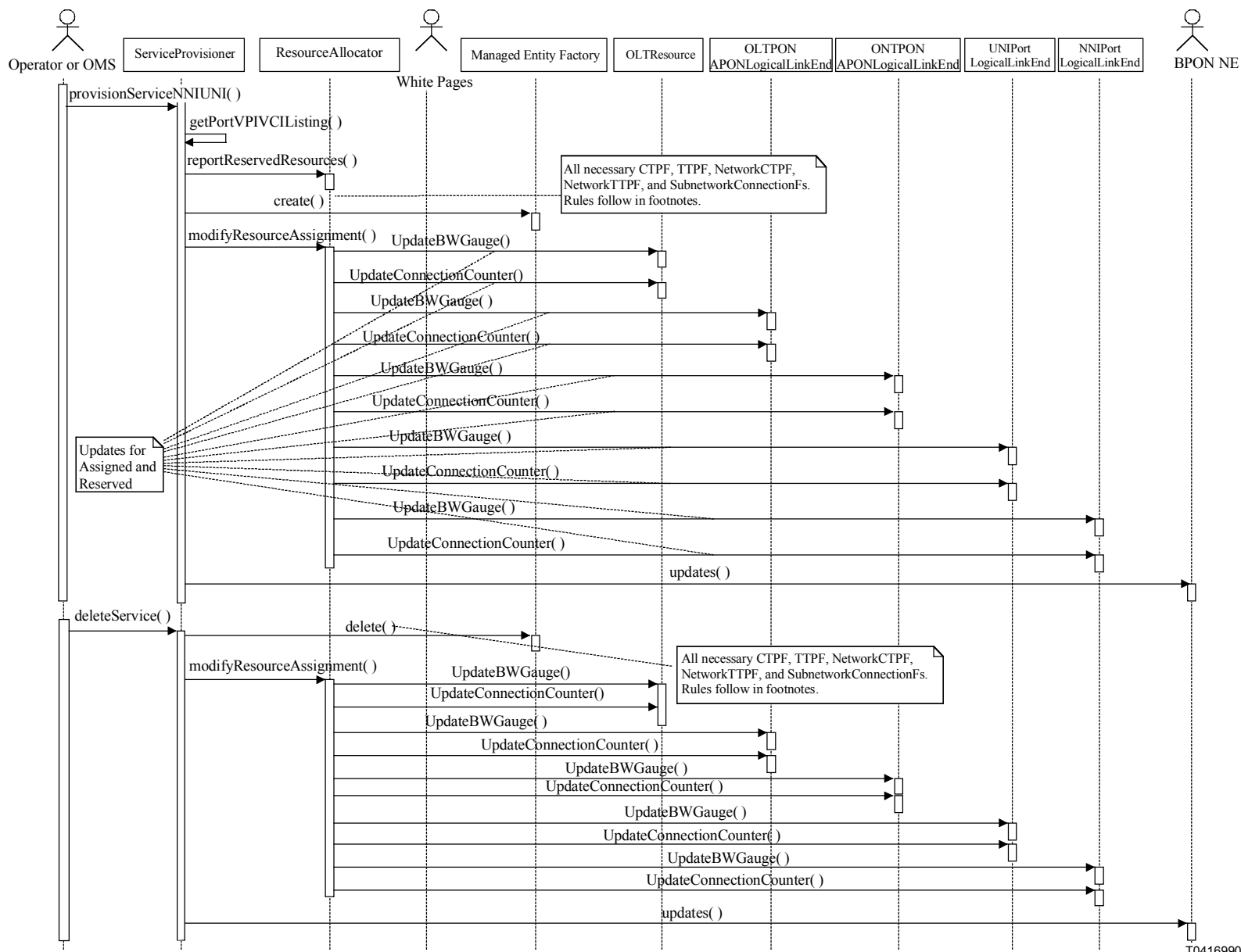
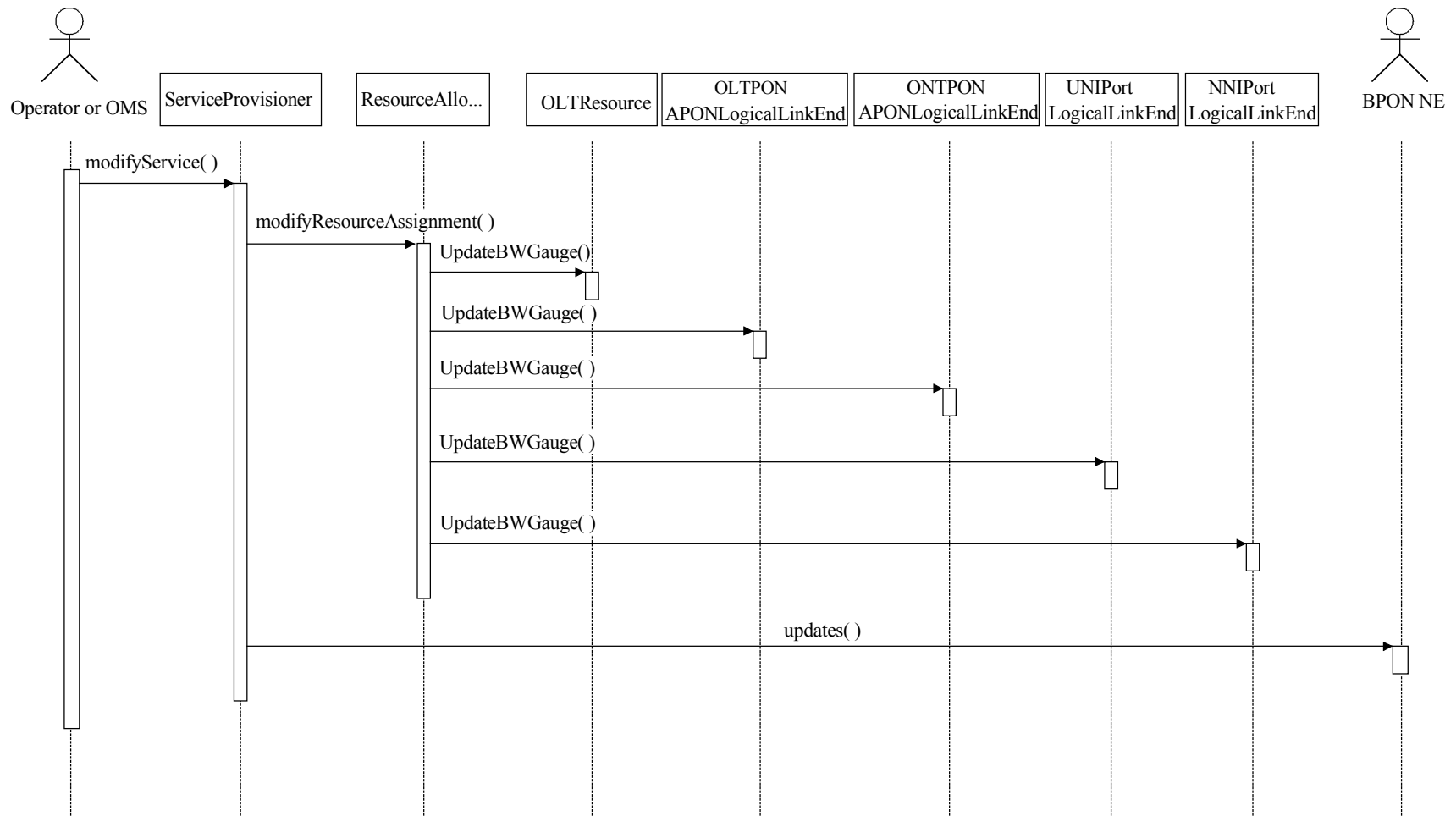

Figure 5-81/Q.834.3 – Provision NNI to UNI Service sequence diagram



T0417000-02

Figure 5-82/Q.834.3 – Modify NNI to UNI Service sequence diagrams

Managed Entities: vpCTPF, vpTTPF, plugInUnitF, OLT, ONT, ONU, NT, vcCTPF, vcTTPF, APONNetworkCTP, APONNetworkTTP, APONLinkConnection, DS1CTPF, DS1TTPF, DS1NetworkCTPF, DS1NetworkTTPF, DS3CTPF, DS3TTPF, DS3NetworkCTPF, DS3NetworkTTPF, vcNetworkCTPF, vcNetworkTTPF, vpNetworkCTPF, vpNetworkTTPF, VoiceCTPF, VoiceTTPF, VoiceNetworkCTPF, VoiceNetworkTTPF, vpSubnetworkConnectionF, vcSubnetworkConnectionF, DS1SubnetworkConnectionF, DS3SubnetworkConnectionF, EthernetCTPF, EthernetTTPF, BridgedLANNetworkCTPF, BridgedLANNetworkTTPF, and VoiceSubnetworkConnectionF, alarmSeverityAssignmentProfileF, equipmentHolderF, thresholdDataF, trafficDescriptorProfileF, AAL1ProfileF, AAL5ProfileF, CESServiceProfileF, EthernetProfileF, AAL2ProfileF, AAL2PVCProfileF, LESServiceProfileF, SSCSPParameterProfile1F, SSCSPParameterProfile2F, VoiceServiceProfileAAL2F, VoiceServiceProfileAAL1F, BridgedLANServiceProfileF, and MACBridgeServiceProfileF.

Operations:

Operation Name	Input Parameters	Return Value	Exceptions
1) provisionService NNIUNI	OLT User Label ONT User Label ServiceInstanceId NetworkCharacteristics Profile ObjectList ServiceCharacteristics Profile ObjectList NNILayerParameters NNIPortId UNILayerParameters UNIPortId PONPortId ReservationId	ServiceInfoObject	Unknown OLT Unknown ONT Unknown Profiles Unknown Port Duplication Service Instance Id Insufficient Bandwidth Connection Count Exceeded Comm. Failure Equipment Failure Unknown Reservation Id Reservation Id Mismatch VPI/VCI In Use Invalid VPI/VCI Access Denied

Operation Name	Input Parameters	Return Value	Exceptions
2) provisionService UNIUNI	OLT User Label ONT User Label ServiceInstanceId NetworkCharacteristics Profile ObjectList ServiceCharacteristics Profile ObjectList UNILayerParametersA UNIPortIdA UNILayerParametersB UNIPortIdB PONPortIdA PONPortIdB ReservationId	ServiceInfoObject	Unknown OLT Unknown ONT Unknown Profiles Unknown Port Duplication Service Instance Id Insufficient Bandwidth Connection Count Exceeded Comm. Failure Equipment Failure Unknown Reservation Id Reservation Id Mismatch VPI/VCI In Use Invalid VPI/VCI Access Denied
3) deleteService	ServiceInfoObject	void	Unknown Service Comm. Failure Equipment Failure Access Denied
4) modifyService	ServiceInfoObject NewNetworkCharacteristics ProfileObjectList NewServiceCharacteristics ProfileObjectList	ServiceInfoObject	Unknown Service Unknown Profiles Insufficient Bandwidth Access Denied

Exceptions:

Exception Raised	Description
Unknown OLT	The named OLT is unknown to the Supplier Management System.
Unknown ONT	The named ONT is unknown to the Supplier Management System.
Unknown Profiles	The listed profile objects are unknown to the Supplier Management System and cannot be retrieved via White Pages.
Unknown Port	The identified port is unknown to the Supplier Management System.
Duplicate Service Instance Id	The named Service Instance Id is in use already within the management jurisdiction of the Supplier Management System.
Insufficient Bandwidth	The CAC algorithm indicates that requested service requires too much bandwidth for the OLT.
Insufficient grants	The maximum number of grants for the identified PON interface has been exceeded with this request for service provisioning.
Connection Count Exceeded	The maximum number of connections for the OLT or PON port has been exceeded with this request for service provisioning.
Unknown Service	The described Service is unknown to the Supplier Management System.
Comm. Failure	There was a DCN link failure between the BPON NE and the Supplier Management System.
Equipment Failure	The BPON NE currently has a failure condition preventing the requested transaction from being completed.
Reservation Id Mismatch	The Service Instance Id and Reservation Id do not match.
Unknown Reservation Id	The Supplier Management System does not recognize this Reservation Id.
Invalid VPIVCI	The designated VPI/VCI values are out of range for the system.
VPIVCI In Use	The designated VPI/VCI values are already being used by the system for another connection.
Access Denied	System is not granted access to this interface object.

5.3.6.5 Reserve Resources

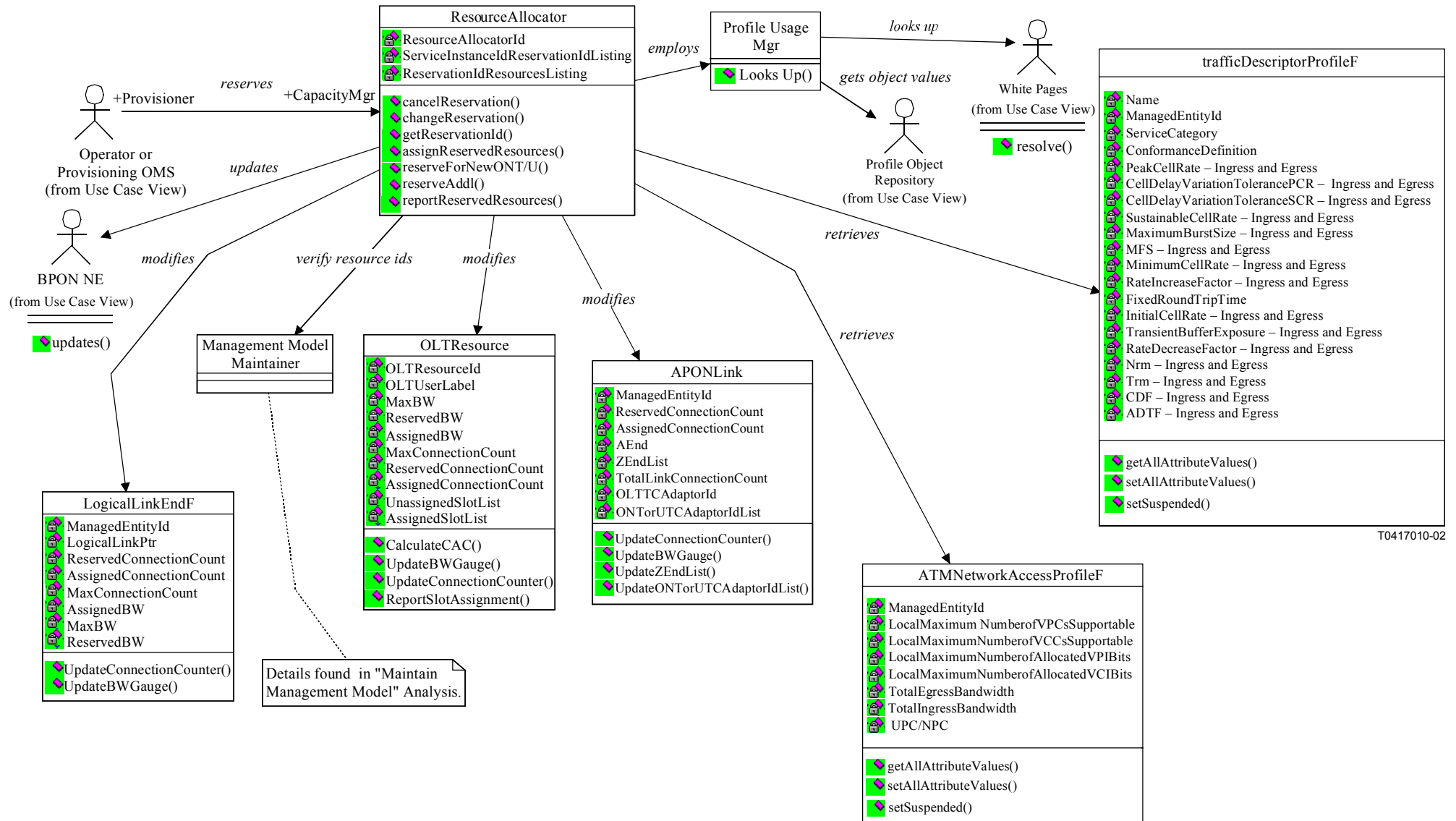

Figure 5-83/Q.834.3 – Reserve Resources class diagram

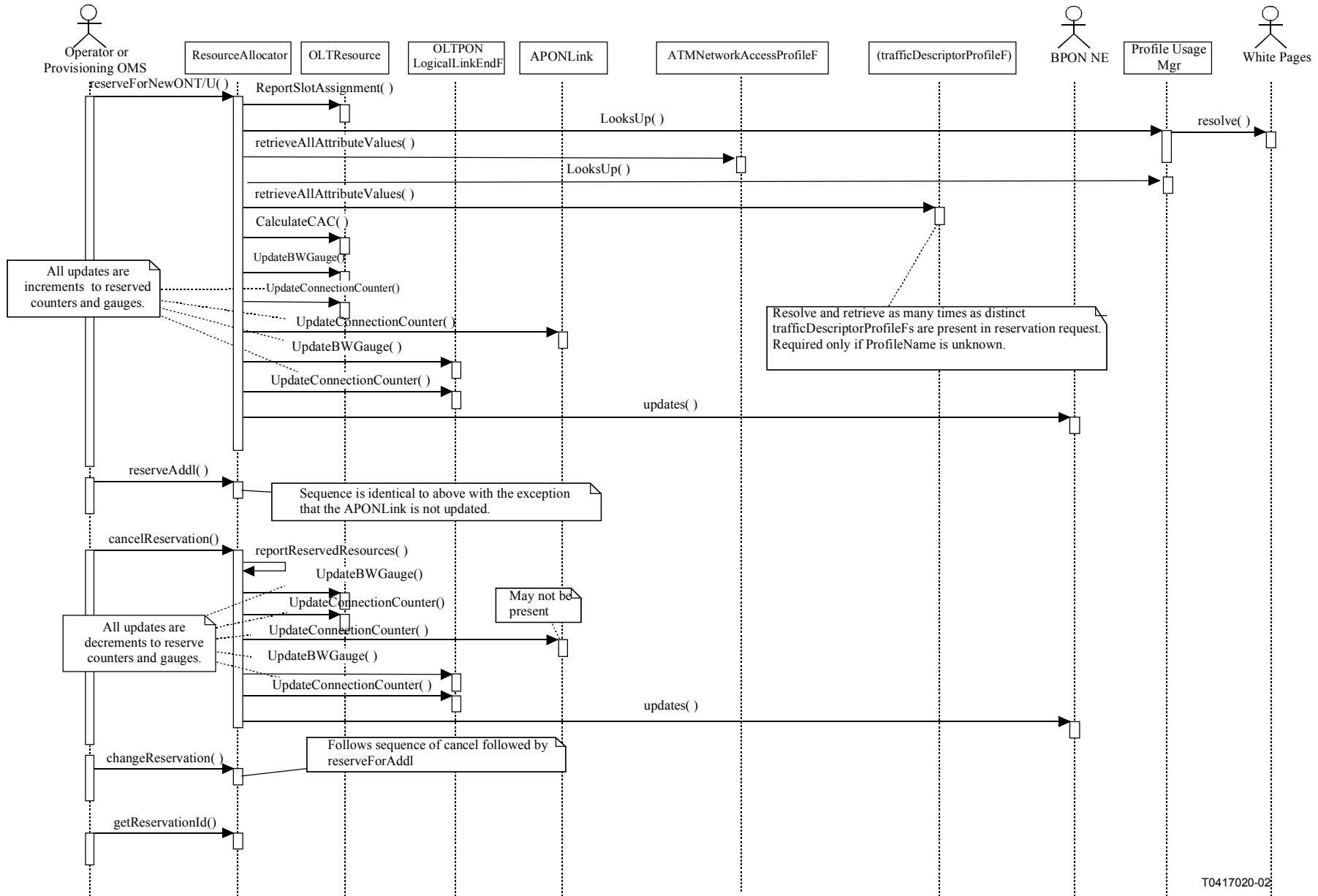

Figure 5-84/Q.834.3 – Reserve Resources sequence diagram

Managed Entities: trafficDescriptorProfileF, OLT, ATMNetworkAccessProfileF, APONLink, and LogicalLinkEndF.

Operations:

Operation Name	Input Parameters	Return Value	Exceptions
1) reserveForNew ONT/U	OLT User Label PONPhysicalPathTPIId NetworkCharacteristics-ProfileObjectList ServiceInstanceId	ReservationId	Unknown OLT Unknown PON Port Unknown Profiles Duplicate Service Instance Id Insufficient Bandwidth Max. Subtending Nodes Exceeded Connection Count exceeded Comm. Failure Access Denied
2) reserveAddl	OLT User Label PONPhysicalPathTPIId NetworkCharacteristics-ProfileObjectList ServiceInstanceId	ReservationId	Unknown OLT Unknown PON Port Unknown Profiles Duplication Service Instance Id Insufficient Bandwidth Connection Count Exceeded Comm. Failure Access Denied
3) cancelReservation	ReservationId	AvailableBandwidth	Unknown Reservation Id Comm. Failure Access Denied

Operation Name	Input Parameters	Return Value	Exceptions
4) changeReservation	ReservationId OLT User Label PONPhysicalPathTPIId NetworkCharacteristics-ProfileObjectList	ReservationId	Unknown Reservation Id Unknown OLT Unknown PON Port Unknown Profiles Insufficient Bandwidth Max. Subtending Nodes Exceeded Connection Count exceeded Comm. Failure Access Denied
5) getReservation	ServiceInstanceId	ReservationId	Unknown Service Instance Id

Exceptions:

Exception Raised	Description
Unknown Service Instance Id	The named Service Instance is unknown to the Supplier Management System.
Connection Count Exceeded	The maximum number of connections for the OLT or PON port has been exceeded with this request for service provisioning.
Max. Subtending Nodes Exceeded	The maximum engineered number of subtending nodes for the identified PON interface has been exceeded with this request for service provisioning.
Insufficient Bandwidth	The CAC algorithm indicates that requested service requires too much bandwidth for the OLT.
Duplication Service Instance Id	The named Service Instance Id is in use already within the management jurisdiction of the Supplier Management System.
Unknown Profiles	The listed profile objects are unknown to the Supplier Management System and can not be retrieved via White Pages.
Unknown PON Port	The named PON port is unknown to the Supplier Management System.
Unknown OLT	The named OLT is unknown to the Supplier Management System.
Unknown Reservation Id	The named Reservation Id is unknown to the Supplier Management System.
Comm. Failure	There was a DCN link failure between the BPON NE and the Supplier Management System.
Access Denied	System is not granted access to this interface object.

5.3.7 Archiving and Bulk Transfer

Figure 5-85 shows interactions between external actors and classes internal to the Supplier Management System when statistics are archived for short periods of time in the Supplier Management System and eventually transferred, via a file transfer protocol, to long-term archives within an operator Data Warehouse. This diagram serves to consolidate and provide consistency to the subsequent diagrams found within this clause.

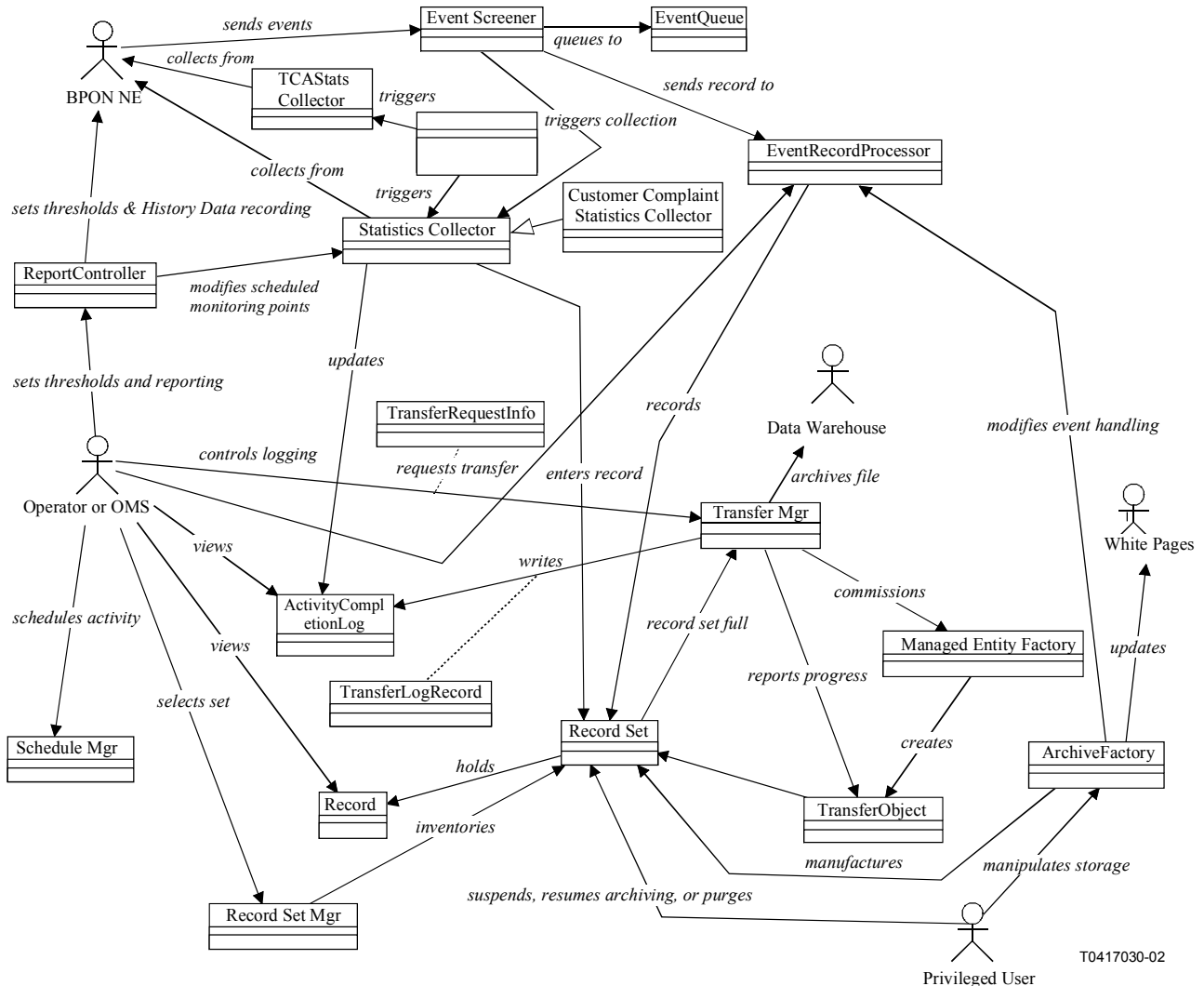
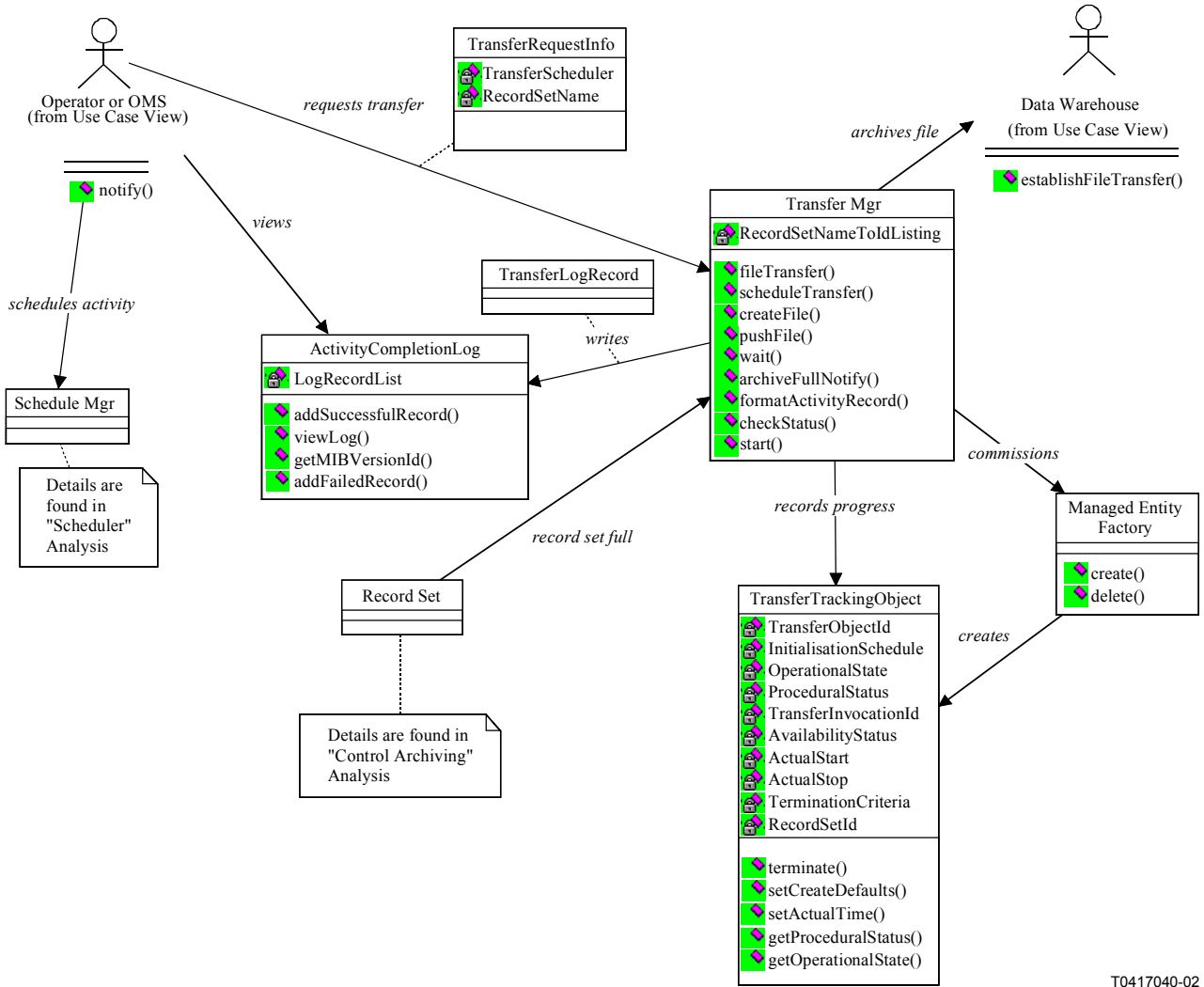

Figure 5-85/Q.834.3 – Archiving and Bulk Transfer class diagram

5.3.7.1 Bulk Transfer



T0417040-02

Figure 5-86/Q.834.3 – Bulk Transfer class diagram

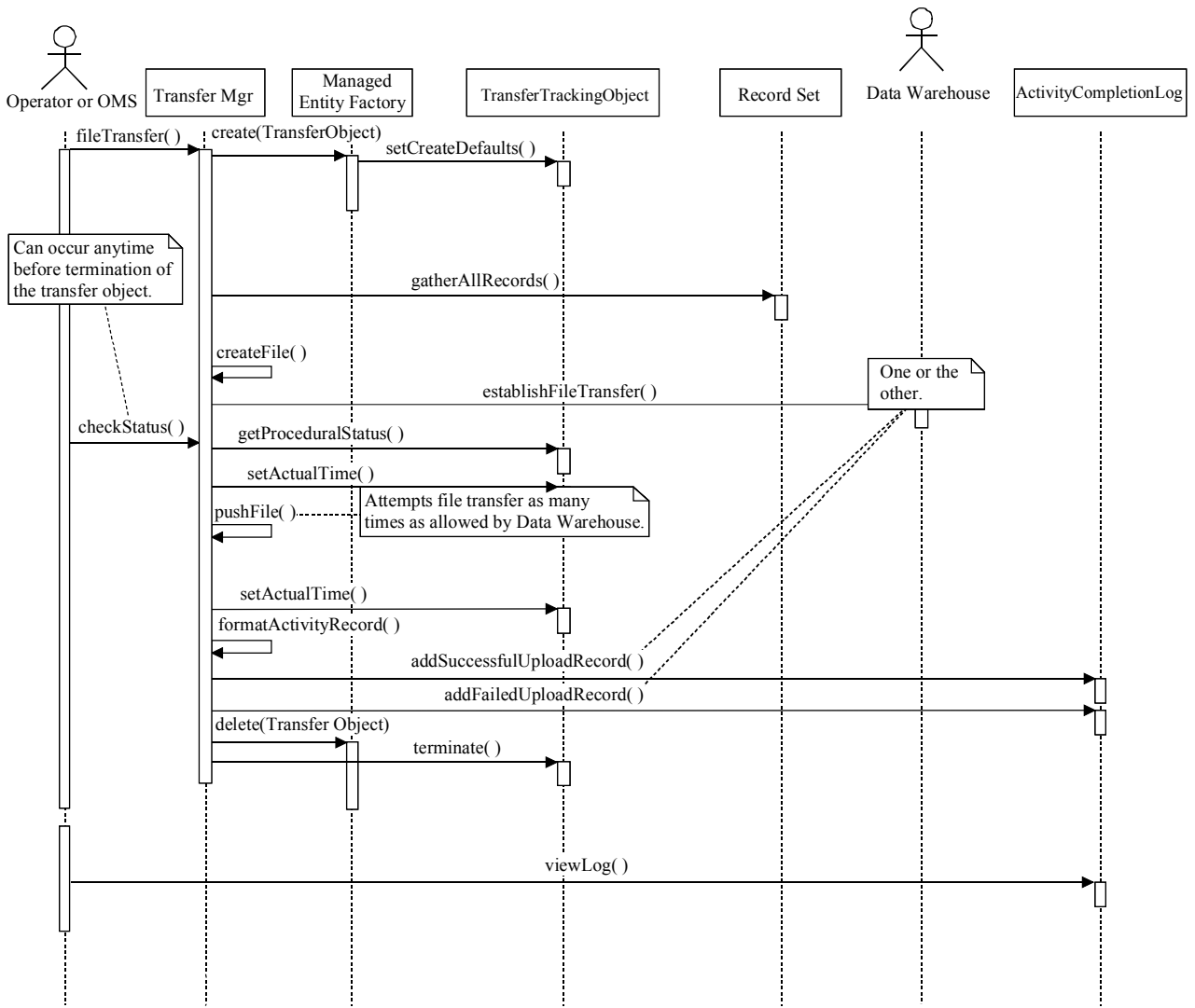

T0417050-02

Figure 5-87/Q.834.3 – Operator-requested Bulk Transfer sequence diagram

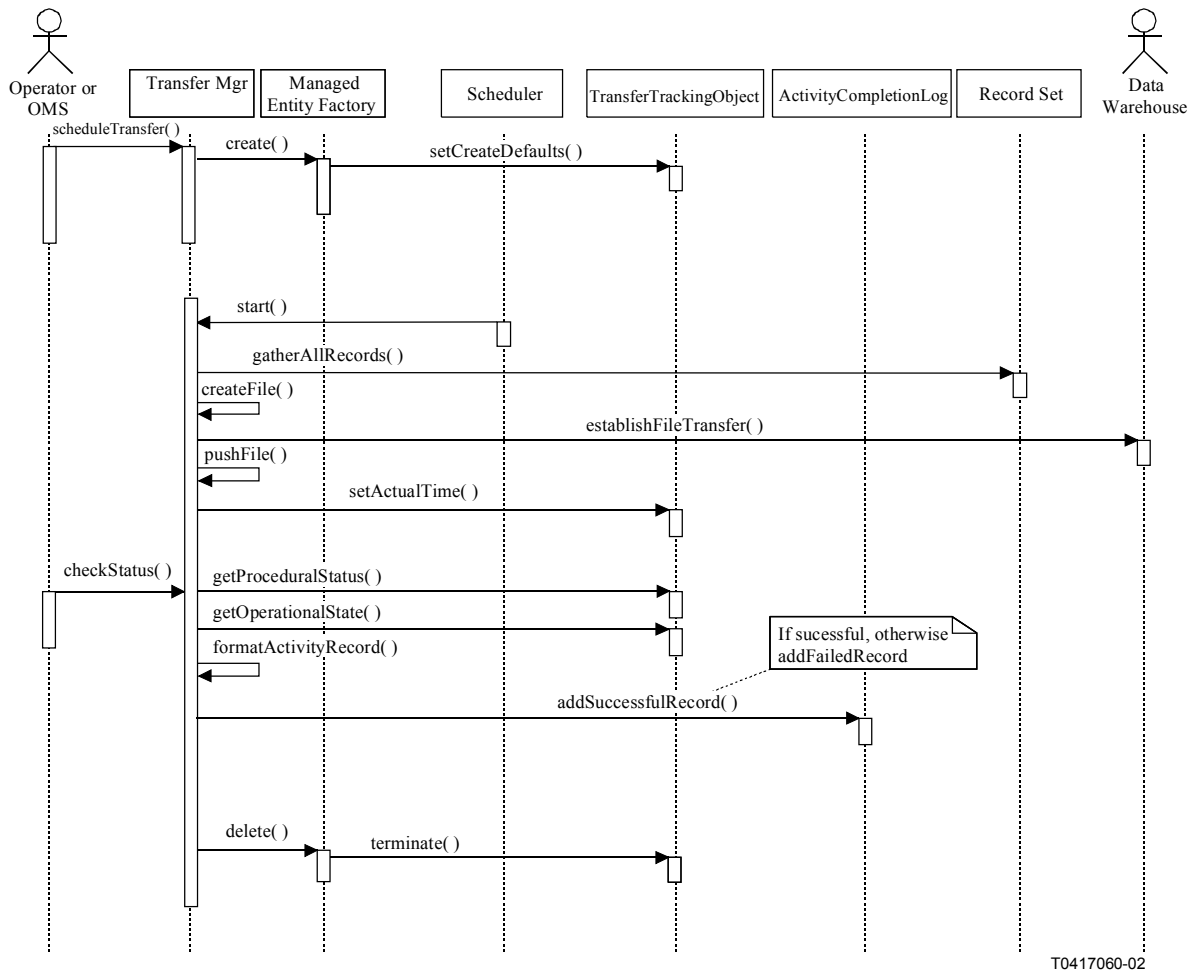

T0417060-02

Figure 5-88/Q.834.3 – Scheduled Bulk Transfer sequence diagram

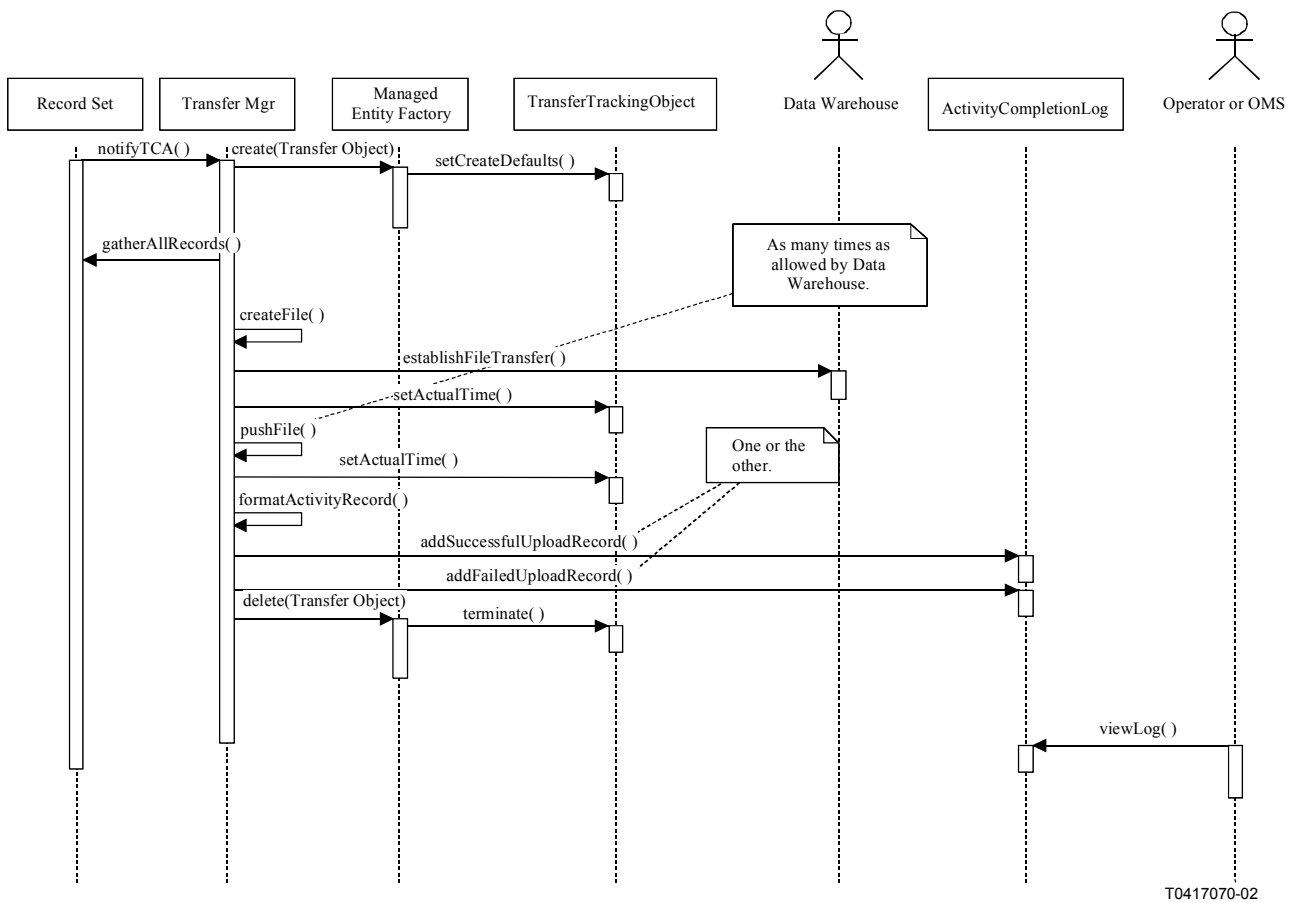

Figure 5-89/Q.834.3 – Bulk Transfer Triggered by Record Set Full sequence diagram

Managed Entities: None yet available in [11] or [12].

Management Support Entities: ActivityCompletionLog, TransferTrackingObject.

Operations:

Operation Name	Input Parameters	Return Value	Exceptions
1) fileTransfer	Record Set Name Destination Server Destination File	TransferObjectId	Unknown Record Set Unknown Destination Server Access Denied
2) checkStatus	TransferObjectId	StatusAttributes	Unknown Transfer Process
3) scheduleTransfer	Record Set Name Scheduler Destination Server Destination File	TransferObjectId	Unknown Record Set Unknown Scheduler Unknown Destination Server Access Denied

Exceptions:

Exception Raised	Description
Unknown Record Set	Record set identified in the request is unknown to the Supplier Management System.
Unknown Transfer Process	The status of the identified transfer process could not be checked because it is unknown to the Supplier Management System.
Unknown Scheduler	The named scheduler is unknown to the Supplier Management System.
Unknown Destination Server	The identified destination server can not be accessed by the transfer agent.
Access Denied	System is not granted access to this interface object.

5.3.7.2 Collect History Data

Figure 5-90 provides the class diagram associated with history data collection triggered by routine needs for performance monitoring as well as by customer complaint or detection of threshold crossing alerts for a monitored performance parameter. Figure 5-91 provides a sequence diagram that shows separate processes for history data collection triggered by customer complaint and history data collection triggered by all other mechanisms.

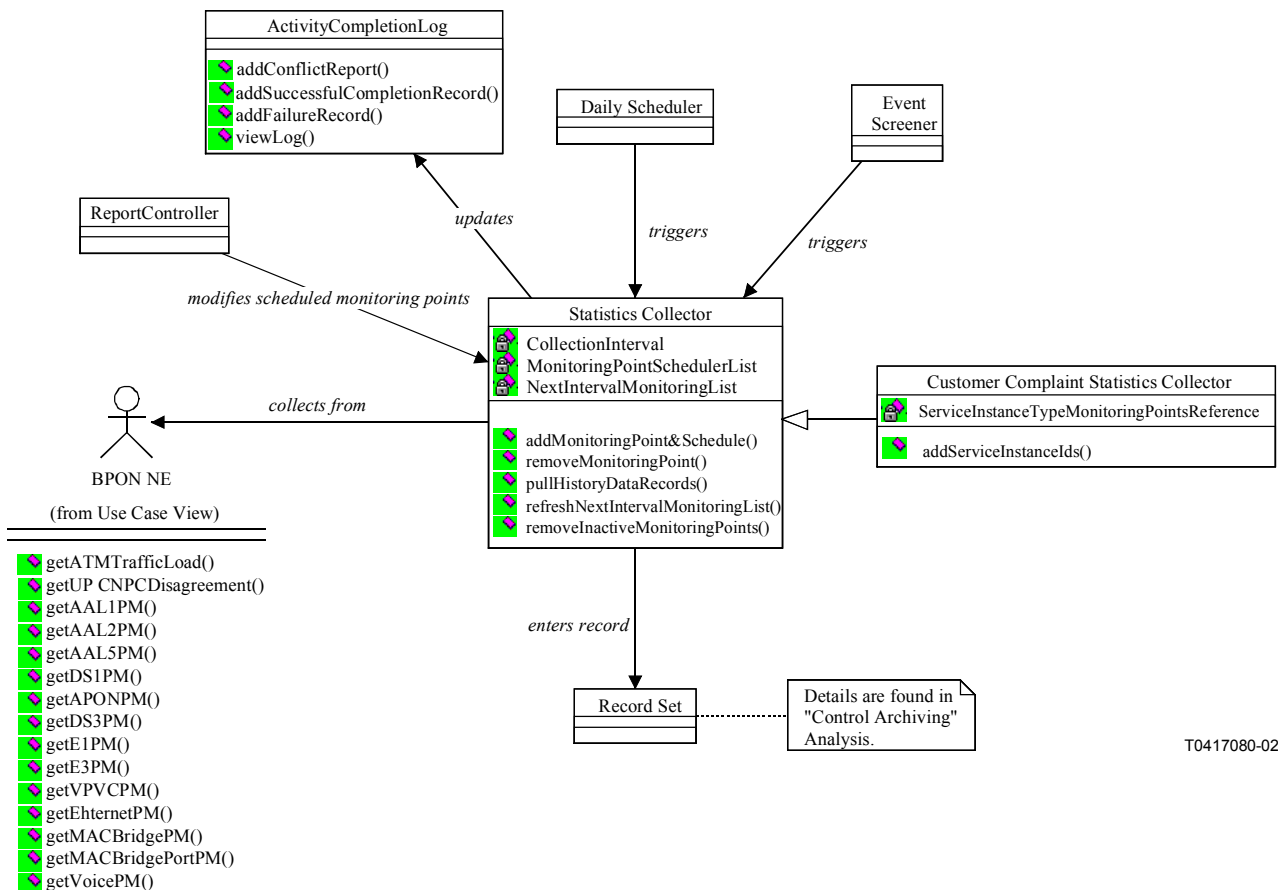
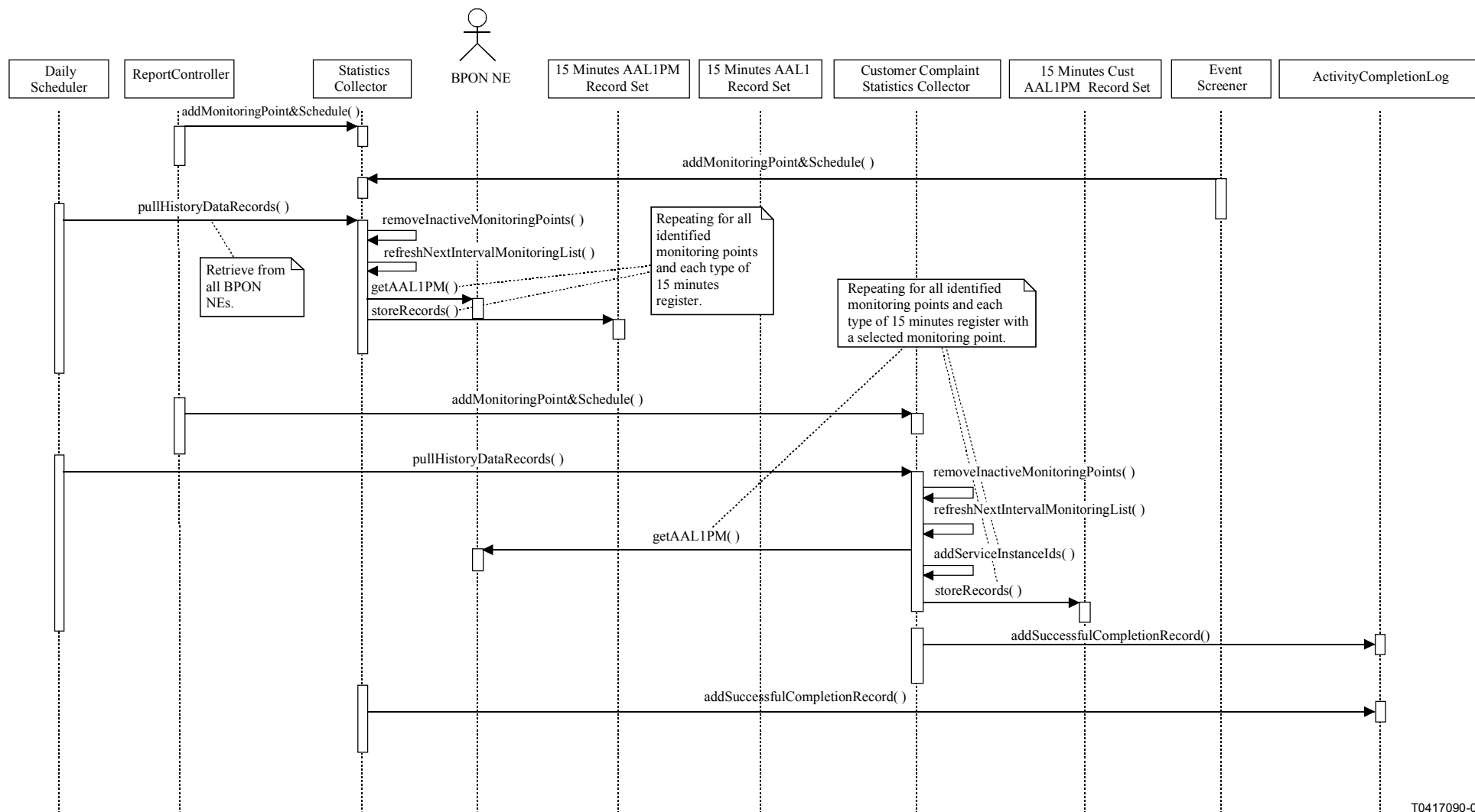

Figure 5-90/Q.834.3 – Collect History Data class diagram



T0417090-02

Figure 5-91/Q.834.3 – Collet History Data sequence diagram

Managed Entities: AAL1PMHistoryDataF, AAL2PMHistoryDataF, AAL5PMHistoryDataF, APONPMHistoryData, ATMTrafficLoadHistoryDataF, DS1PMHistoryDataF, DS3PMHistoryDataF, E1PMHistoryDataF, E3PMHistoryDataF, EthernetPMHistoryDataF, MACBridgePMHistoryDataF, MACBridgePortPMHistoryDataF, upcNpcDisagreementPMHistoryDataF, voicePMHistoryDataF, vpvPMHistoryDataF.

Management Support Entities: Scheduler.

5.3.7.3 Control Archiving

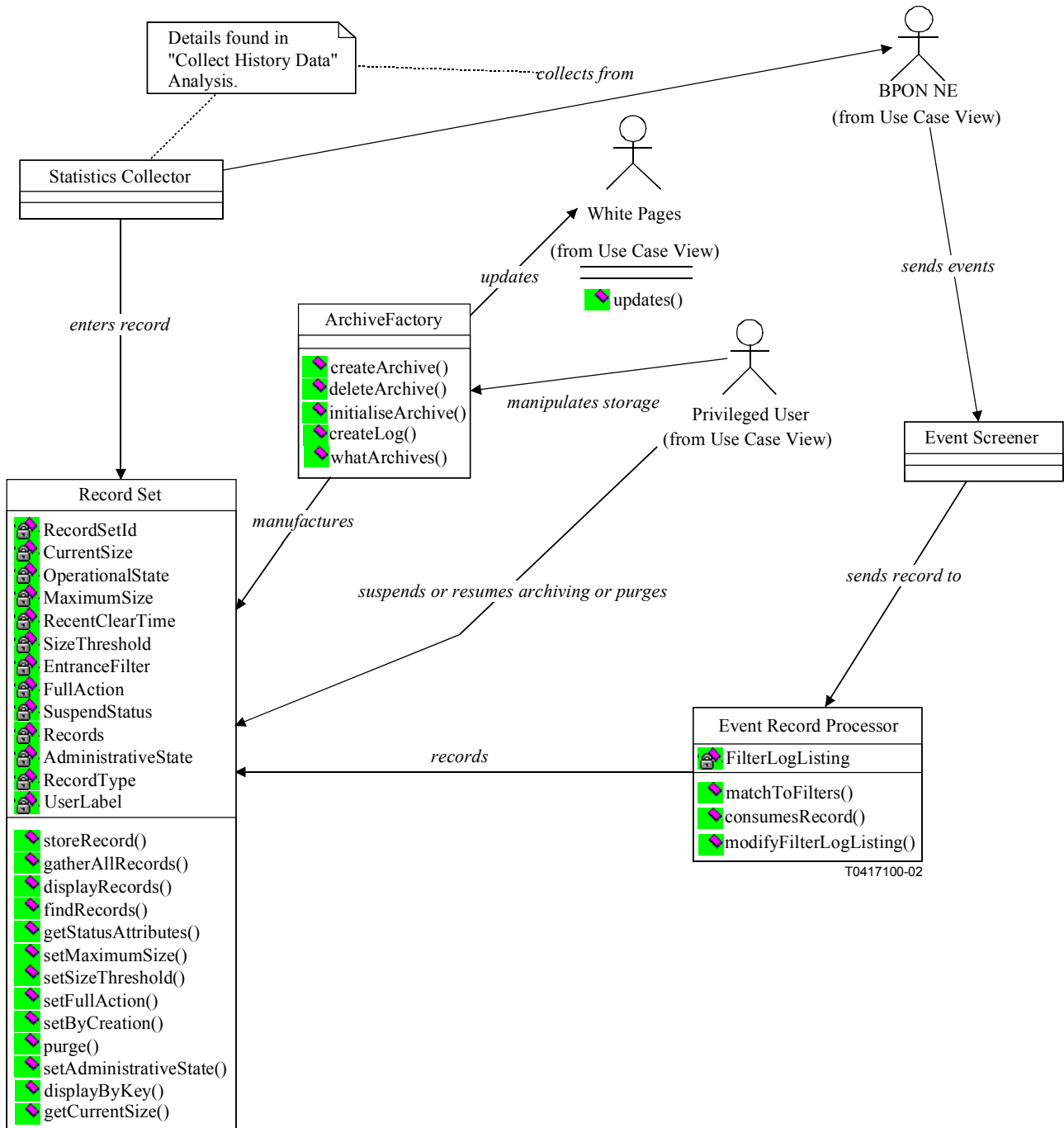
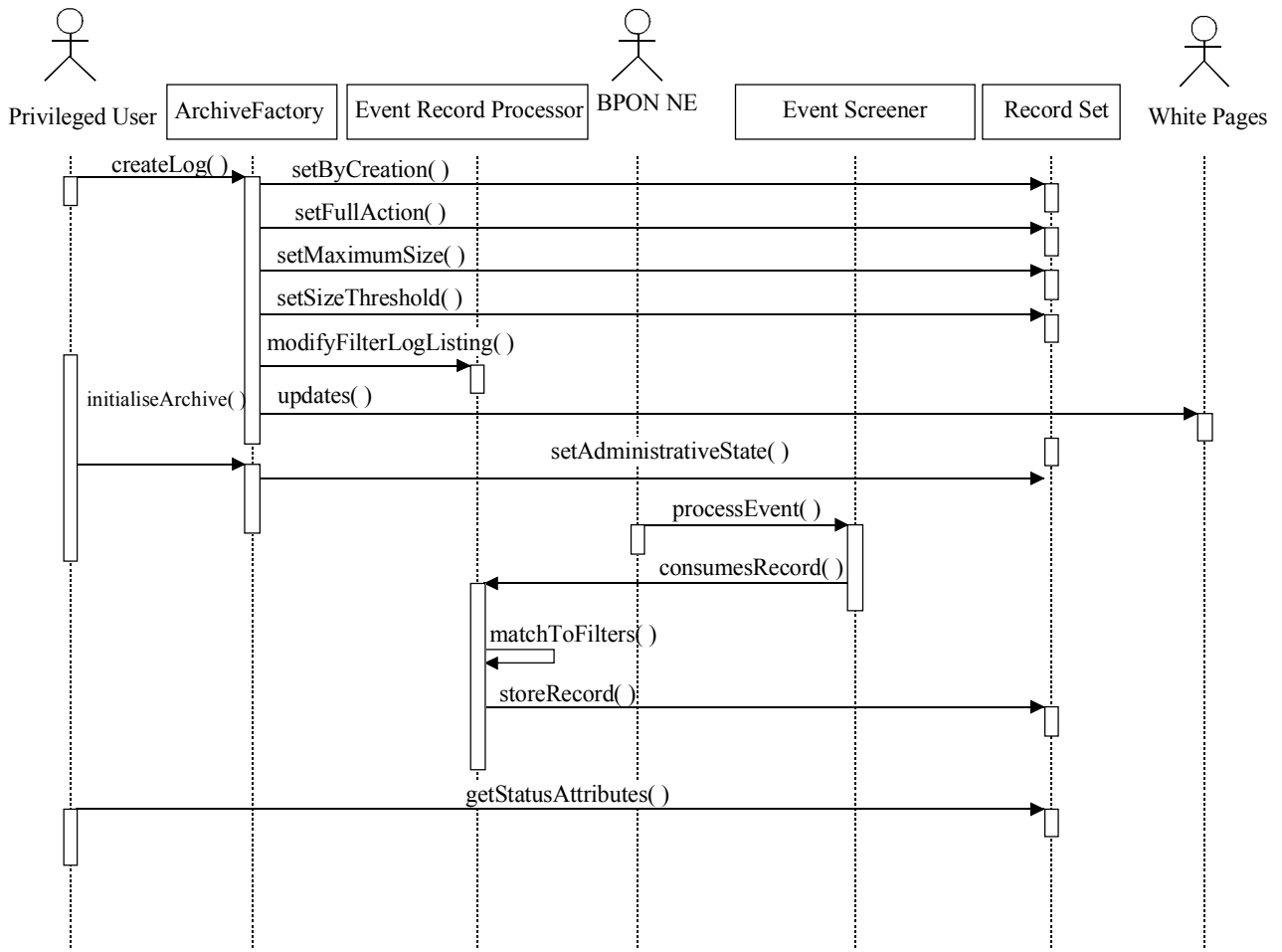
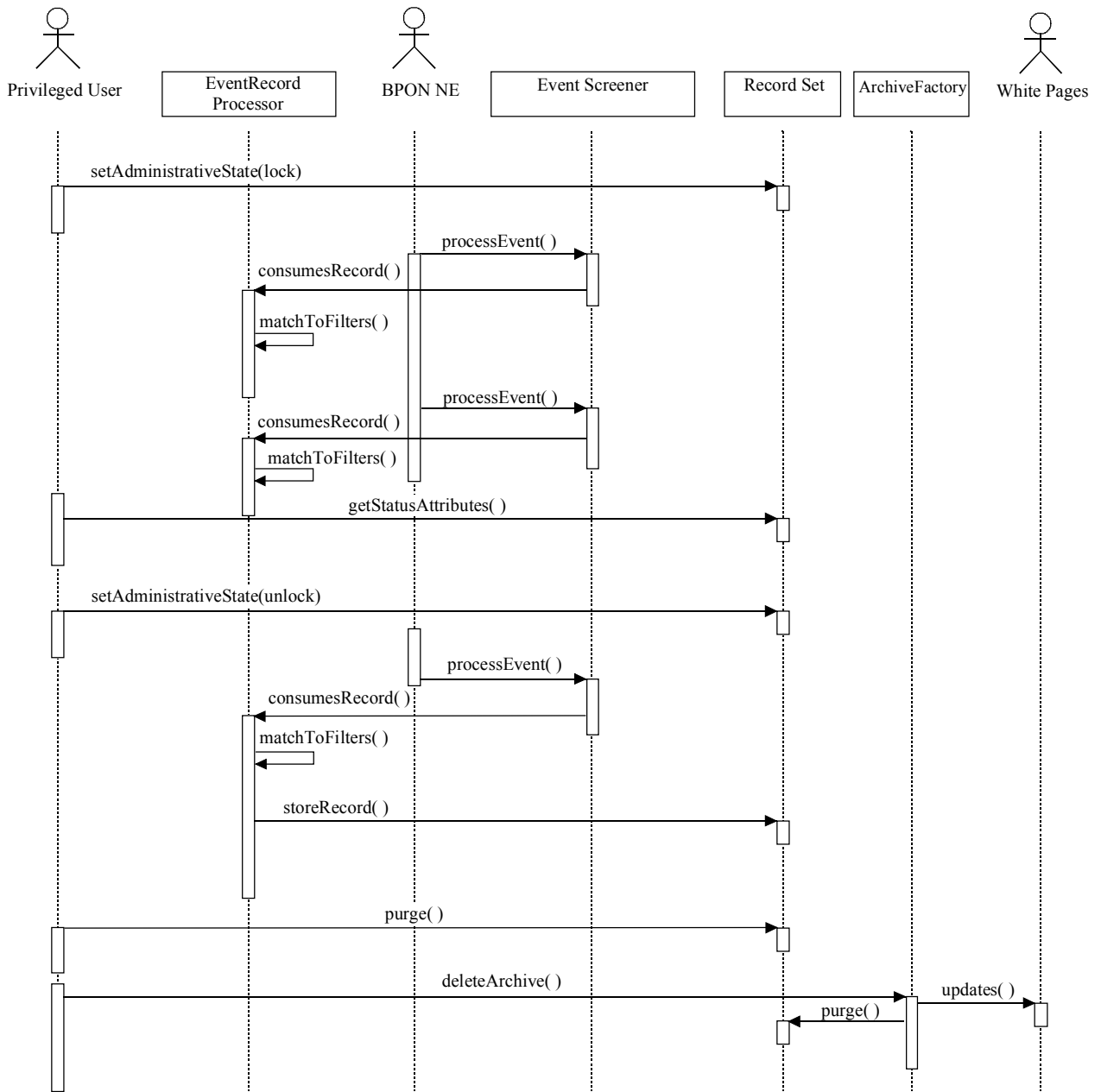

Figure 5-92/Q.834.3 – Control Archiving class diagram



T0417110-02

Figure 5-93/Q.834.3 – Create Log sequence diagram



T0417120-02

Figure 5-94/Q.834.3 – Control Log sequence diagram

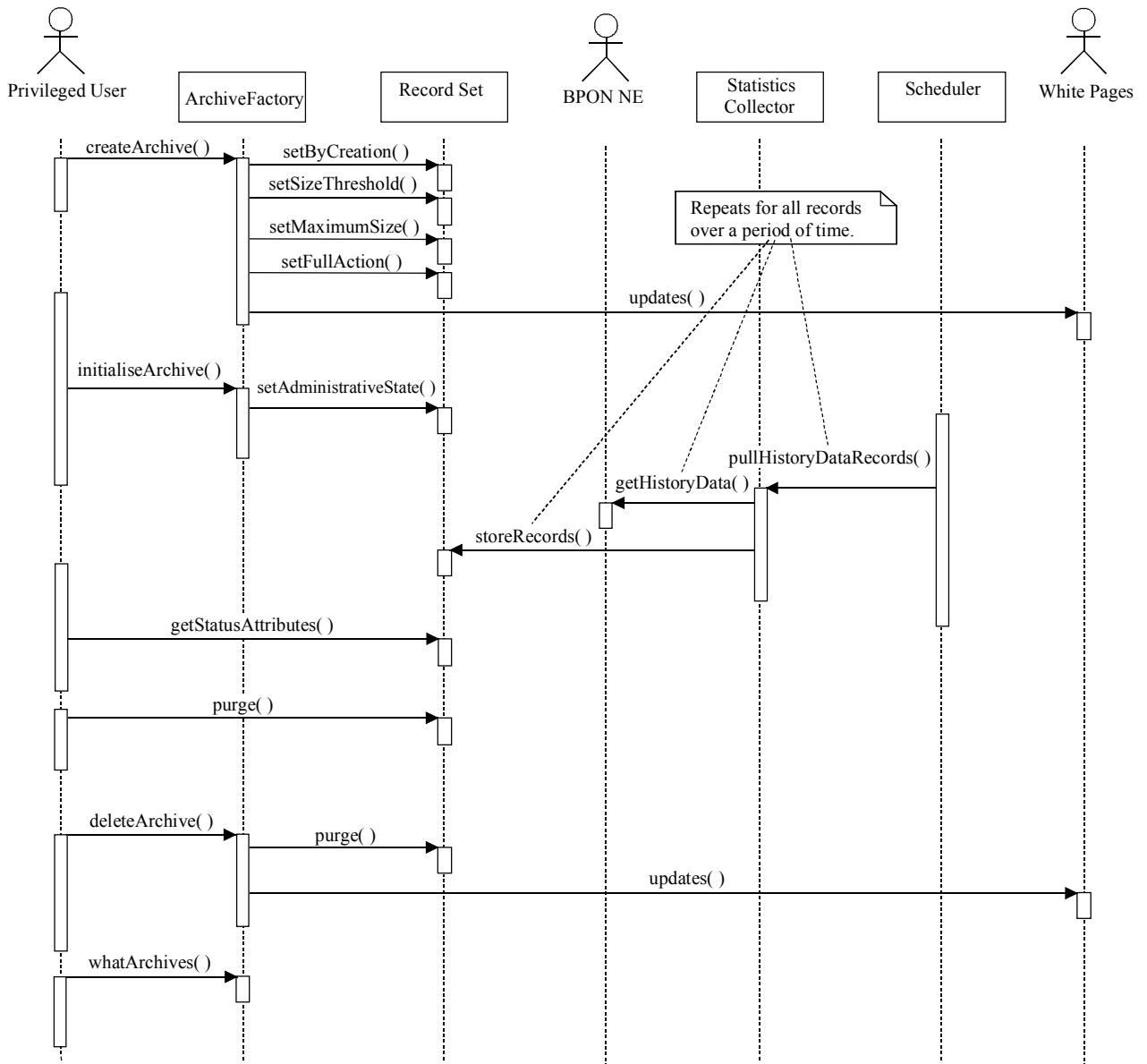

T0417130-02

Figure 5-95/Q.834.3 – Control Statistics Archiving sequence diagram

Managed Entities: logF.

Operations:

Operation Name	Input Parameters	Return Value	Exceptions
1) createLog	UserLabel FilterConstruct FullAction MaxSize SizeThreshold	RecordSetObject	Archive Exists Duplicate User Label
2) createArchive	UserLabel RecordType MaxSize	RecordSetObject	Archive Exists Duplicate User Label
3) getStatusAttributes	Record Set User Label	StatusStruct – (Size, OperationalState, RecentClearTime)	Unknown Archive
4) initialiseArchive	RecordSet User Label	void	Unknown Archive
5) setAdministrativeState	RecordSet User Label LockInd	void	Locked Already Unlocked Already
6) deleteArchive	RecordSet User Label	void	Unknown Archive
7) purgeArchive	RecordSet User Label	void	Unknown Archive
8) whatArchives		ArchiveUserLabelList	

Exceptions:

Exception Raised	Description
Archive Exists	The archive defined by the parameters of creation request already exists in the Supplier Management System.
Duplicate User Label	The User Label provided in the request has been used to label another archive, i.e. one that is defined by a different set of creation request parameters.
Unknown Archive	The Record Set Id is unknown to the Supplier Management System.
Locked Already	The archive already has AdministrativeState with value "locked".
Unlocked Already	The archive already has AdministrativeState with value "unlocked".

5.3.7.4 Performance and Traffic Monitoring Reporting Control

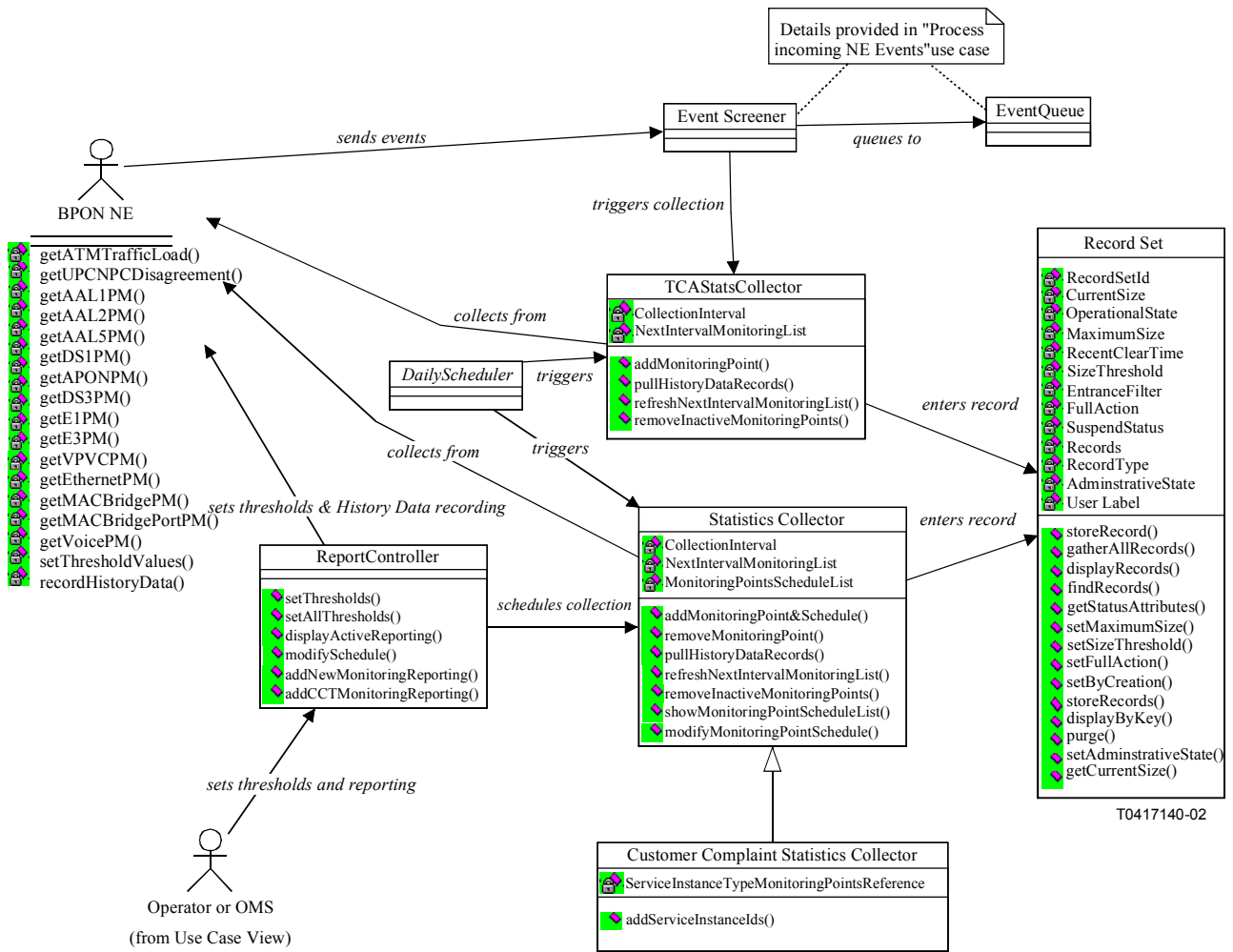

Figure 5-96/Q.834.3 – Performance and Traffic Monitoring Reporting Control class diagram

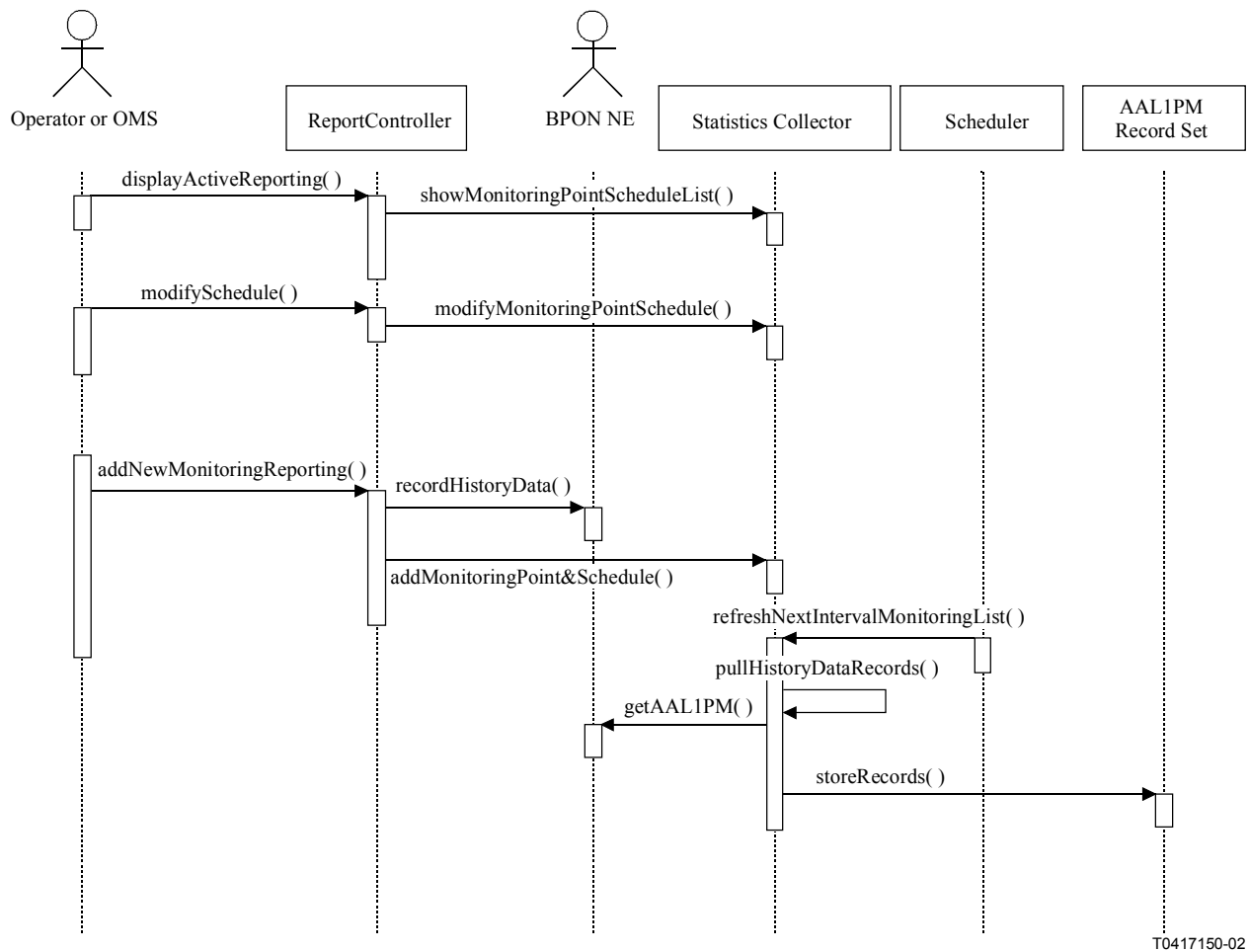
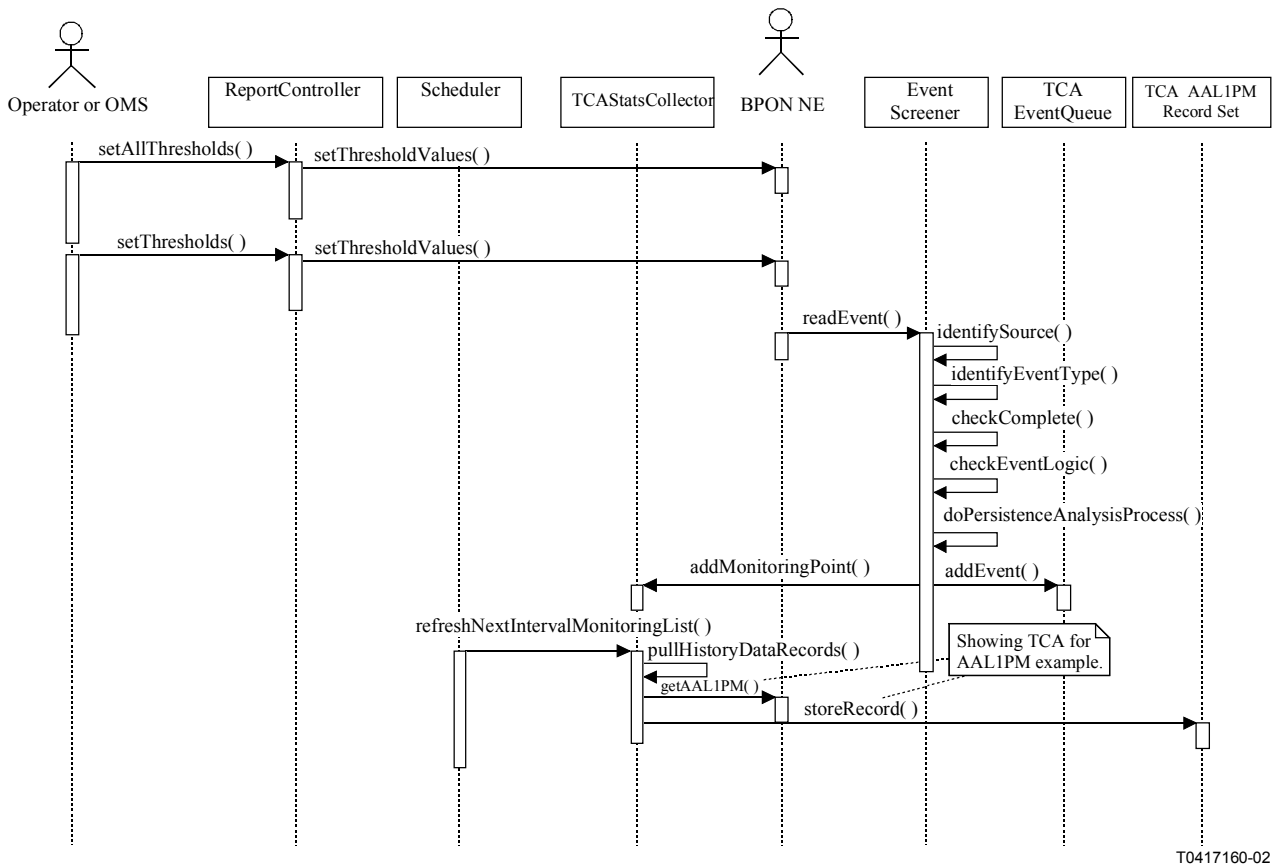
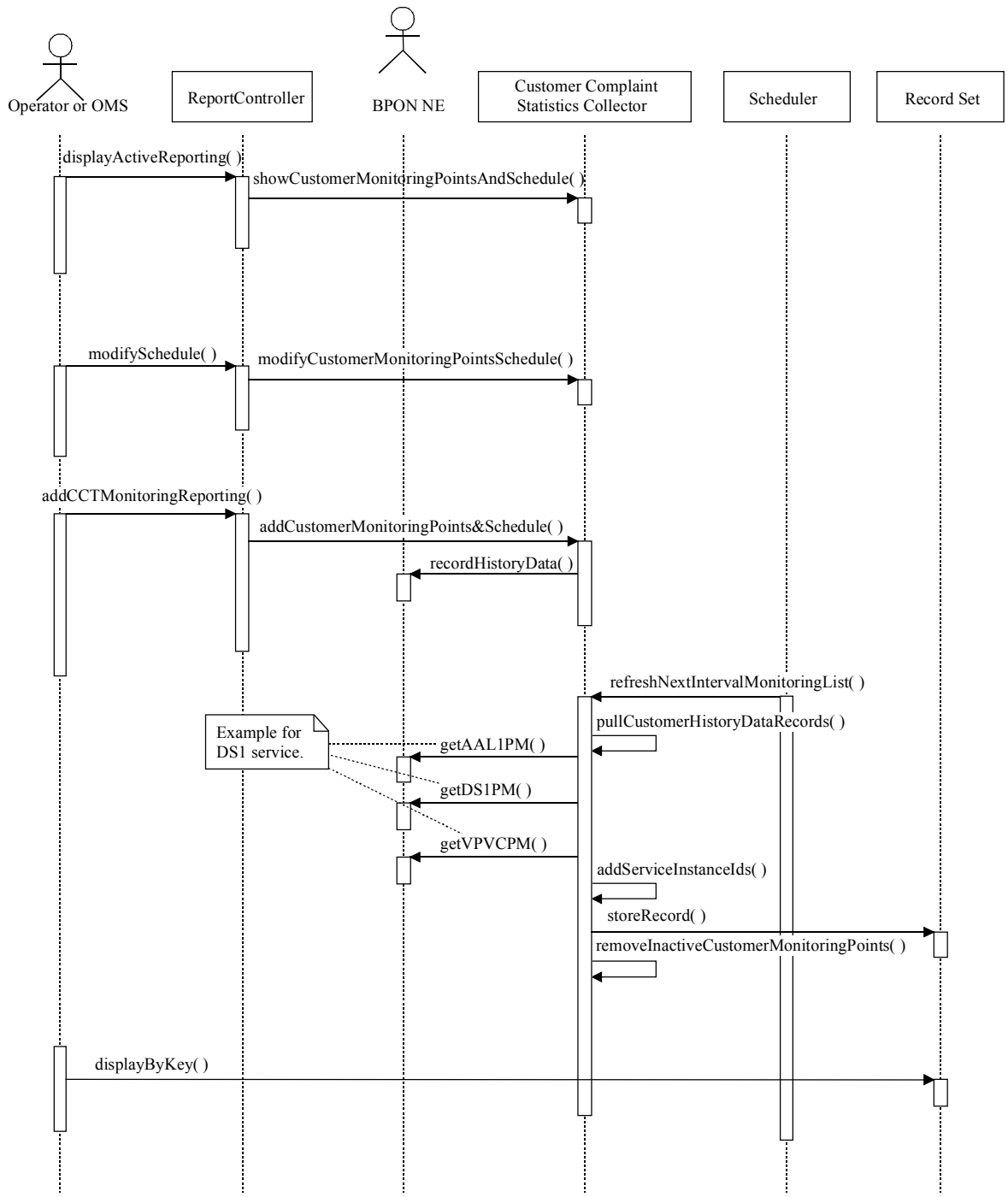

Figure 5-97/Q.834.3 – Performance and Traffic Monitoring Reporting (Scheduled) sequence diagram – AAL1PM Example



T0417160-02

Figure 5-98/Q.834.3 – Performance Monitoring Reporting (TCA Triggered) sequence diagram – AAL1PM Example



T0417170-02

Figure 5-99/Q.834.3 – Performance and Traffic Monitoring Reporting (Customer Complaint) sequence diagram

Managed Entities: AAL1PMCurrentDataF, AAL1PMHistoryDataF, AAL2PMCurrentDataF, AAL2PMHistoryDataF, AAL5PMCurrentDataF, AAL5PMHistoryDataF, APONPMCurrentData, APONPMHistoryData, ATMTrafficLoadCurrentDataF, ATMTrafficLoadHistoryDataF, thresholdDataF, DS1PMCurrentDataF, DS1PMHistoryDataF, DS3PMCurrentDataF, DS3PMHistoryDataF, E1PMCurrentDataF, E1PMHistoryDataF, E3PMCurrentDataF, E3PMHistoryDataF, EthernetPMCurrentDataF, EthernetPMHistoryDataF, MACBridgePMCurrentDataF, MACBridgePMHistoryDataF, MACBridgePortPMCurrentDataF, MACBridgePortPMHistoryDataF, upcNpcDisagreementPMCurrentDataF, upcNpcDisagreementPMHistoryDataF, voicePMCurrentDataF, voicePMHistoryDataF, vpvPMCurrentDataF, vpvPMHistoryDataF, alarmLogRecordF.

Management Support Entities: Scheduler.

Operations:

Operation Name	Input Parameters	Return Value	Exceptions
1) displayActiveReporting	BPONNEUserLabel CustCompInd	MonitoringSchedule List	Unknown BPON NE
2) modifySchedule	BPONNEUserLabel MonitoringPointId CurrentScheduler NewScheduler	void	Unknown Monitoring Point Unknown Scheduler Unknown BPON NE Access Denied
3) addNewMonitoring- Reporting	BPONNEUserLabel MonitoringPointId StopTime	void	Reporting Exists Unknown Monitoring Point Unknown Scheduler Unknown BPON NE Collection Limitation Collection Period Past Reporting Exists Access Denied
4) addCCTMonitoring- Reporting	BPONNEUserLabel MonitoringPointId ServiceInstanceId StopTime	void	Reporting Exists Unknown Monitoring Point Unknown Scheduler Unknown Service Instance Id Unknown BPON NE Collection Limitation Collection Period Past Reporting Exists Access Denied

Operation Name	Input Parameters	Return Value	Exceptions
5) setThreshold	BPONNEUserLabel MonitoringPointId ThresholdData Name	void	Unknown BPON NE Unknown Monitoring Point Unknown Profile Invalid Threshold Data Access Denied
6) setAllThresholds	BPONNEUserLabel MonitoringPointType- ThresholdDataName- Matrix	void	Unknown BPON NE Unknown Type Unknown Profile Unknown Profiles Access Denied
7) displayByKey	ServiceInstanceId	RecordsList	Unknown Service Instance Id

Exceptions:

Exception Raised	Description
Unknown BPON NE	The network element identified in the reporting request is unknown to the Supplier Management System.
Unknown Type	The monitoring point type identified in the reporting request is unknown to the Supplier Management System.
Unknown Profiles	The Threshold Data Profile identified in the reporting request is unknown to the Supplier Management System and cannot be located via White Pages.
Unknown Monitoring Point	The monitoring point instance identified in the reporting request is unknown to the Supplier Management System.
Unknown Scheduler	The schedule identified in the scheduled reporting request is unknown to the Supplier Management System.
Unknown Service Instance Id	The Service Instance Id provided in the reporting request is unknown to the Supplier Management System.
Reporting Exists	Indicates that reporting of performance data has already been established
Collection Limitation	Indicates that the limitation of collection of History Data from the designated BPON NE is exceeded.
Collection Period Past	Indicates that stop time is past.
Invalid Threshold Data	The Threshold Data Profile Object cannot be associated with the designated monitoring point.
Access Denied	System is not granted access to this interface object.

5.3.8 Management Information

The final Use Case analysis focuses on direct manipulation of management information within the Supplier Management System. The high level class diagram is given in Figure 5-100. Since other Recommendations (e.g. [12] to [14]) have provided detailed analysis and design for the external interface mechanisms for managed entity creation, deletion, modification, display, and retrieval by containment relationships, only the Use Case "Maintain Management Model" will be further analyzed below.

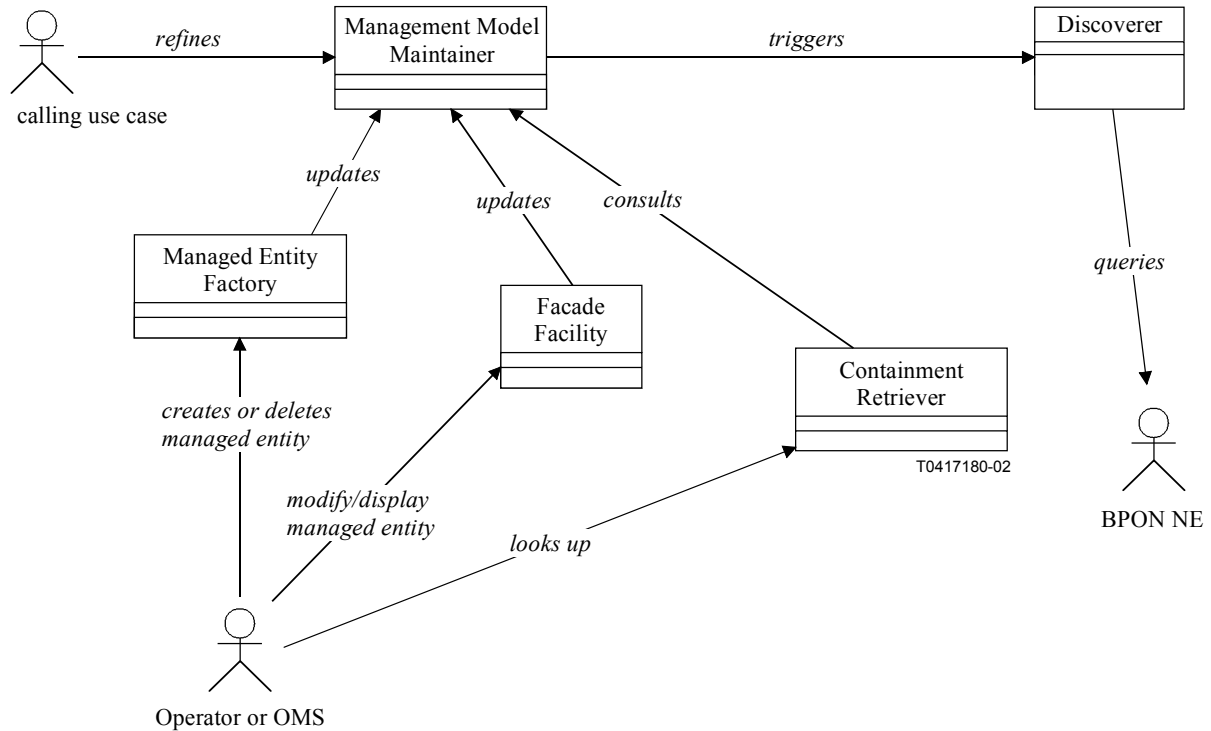

Figure 5-100/Q.834.3 – Management Information Manipulation

5.8.3.1 Maintain Management Model

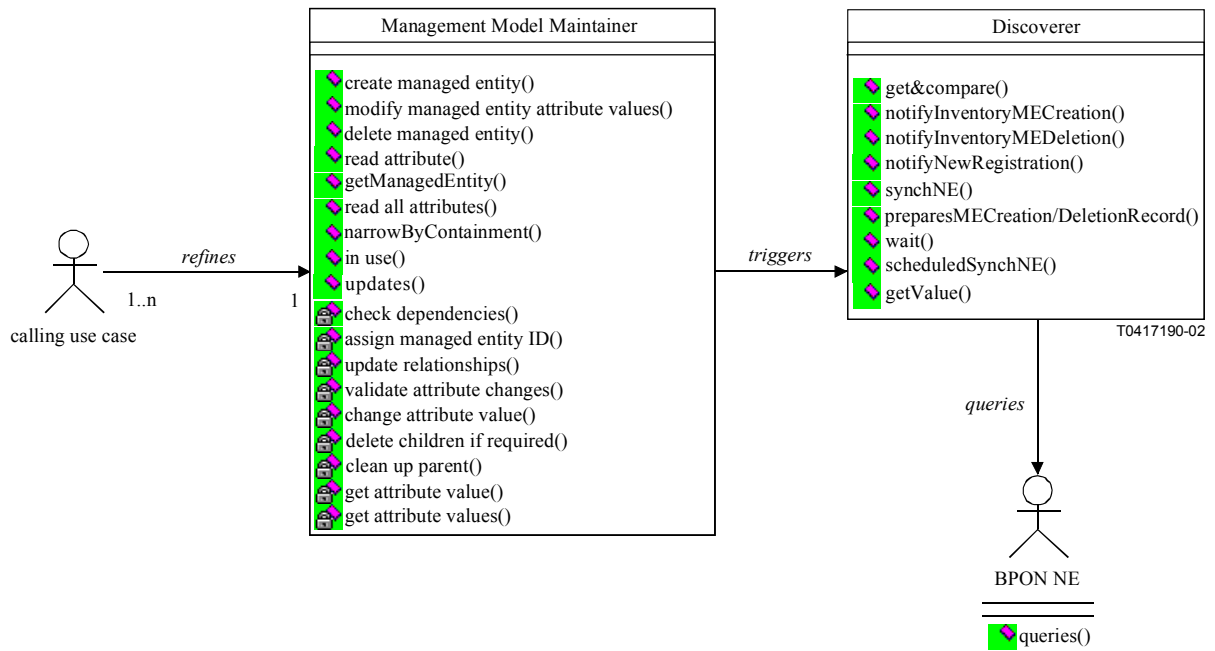

Figure 5-101/Q.834.3 – Maintain Management Model class diagram

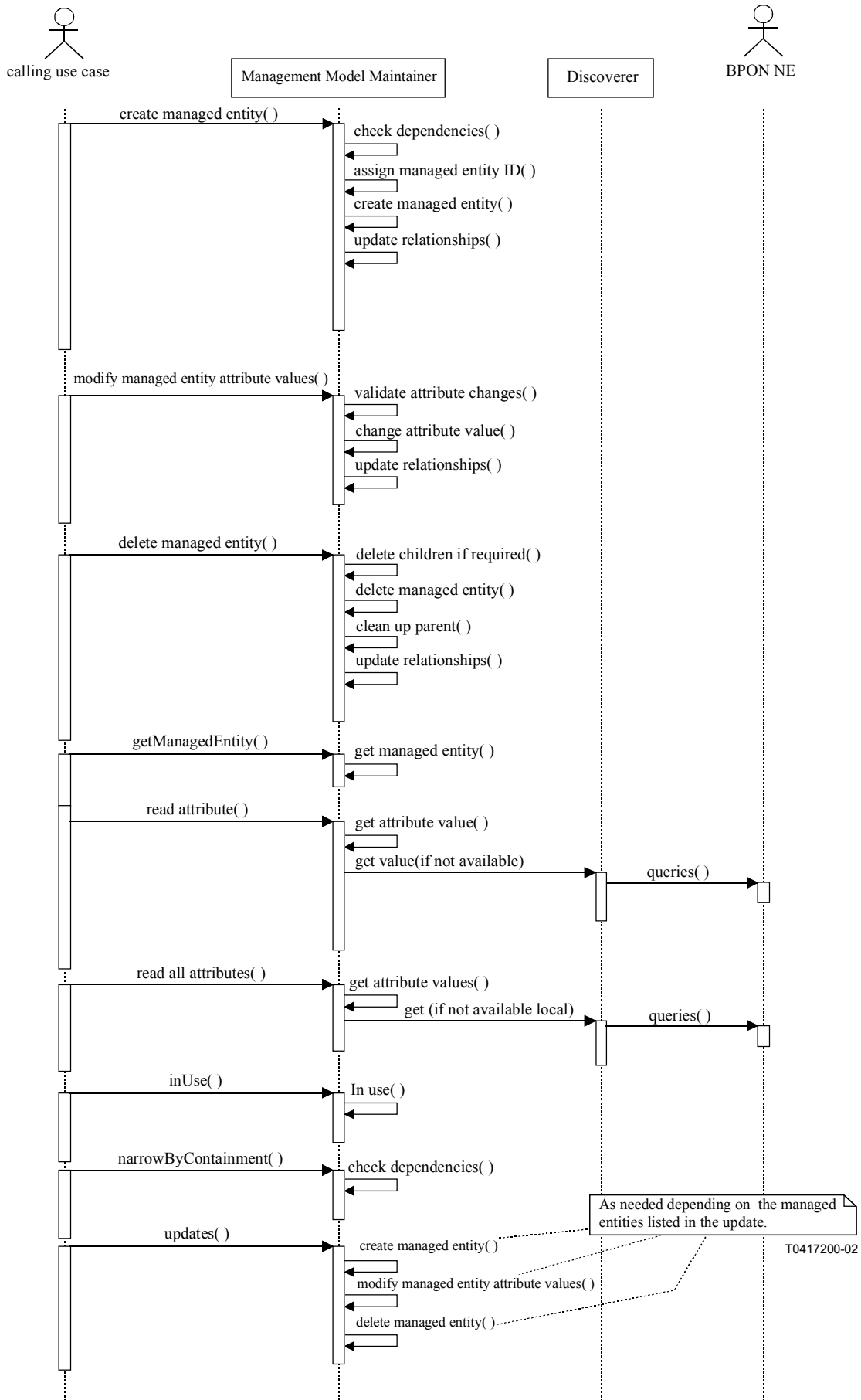

Figure 5-102/Q.834.3 – Maintain Management Model Sequence Diagram

Managed Entities: all Managed Entities are found in [11] and [12].

SERIES OF ITU-T RECOMMENDATIONS

Series A	Organization of the work of ITU-T
Series B	Means of expression: definitions, symbols, classification
Series C	General telecommunication statistics
Series D	General tariff principles
Series E	Overall network operation, telephone service, service operation and human factors
Series F	Non-telephone telecommunication services
Series G	Transmission systems and media, digital systems and networks
Series H	Audiovisual and multimedia systems
Series I	Integrated services digital network
Series J	Cable networks and transmission of television, sound programme and other multimedia signals
Series K	Protection against interference
Series L	Construction, installation and protection of cables and other elements of outside plant
Series M	TMN and network maintenance: international transmission systems, telephone circuits, telegraphy, facsimile and leased circuits
Series N	Maintenance: international sound programme and television transmission circuits
Series O	Specifications of measuring equipment
Series P	Telephone transmission quality, telephone installations, local line networks
Series Q	Switching and signalling
Series R	Telegraph transmission
Series S	Telegraph services terminal equipment
Series T	Terminals for telematic services
Series U	Telegraph switching
Series V	Data communication over the telephone network
Series X	Data networks and open system communications
Series Y	Global information infrastructure and Internet protocol aspects
Series Z	Languages and general software aspects for telecommunication systems