

International Telecommunication Union

ITU-T

TELECOMMUNICATION
STANDARDIZATION SECTOR
OF ITU

Q.3314

(05/2012)

SERIES Q: SWITCHING AND SIGNALLING

Signalling requirements and protocols for the NGN –
Resource control protocols

**Requirements and protocol at the interface
between the mobile location management
physical entity used as a proxy and the central
instance of the mobile location management
physical entity (M9 interface)**

Recommendation ITU-T Q.3314



ITU-T Q-SERIES RECOMMENDATIONS
SWITCHING AND SIGNALLING

SIGNALLING IN THE INTERNATIONAL MANUAL SERVICE	Q.1–Q.3
INTERNATIONAL AUTOMATIC AND SEMI-AUTOMATIC WORKING	Q.4–Q.59
FUNCTIONS AND INFORMATION FLOWS FOR SERVICES IN THE ISDN	Q.60–Q.99
CLAUSES APPLICABLE TO ITU-T STANDARD SYSTEMS	Q.100–Q.119
SPECIFICATIONS OF SIGNALLING SYSTEMS No. 4, 5, 6, R1 AND R2	Q.120–Q.499
DIGITAL EXCHANGES	Q.500–Q.599
INTERWORKING OF SIGNALLING SYSTEMS	Q.600–Q.699
SPECIFICATIONS OF SIGNALLING SYSTEM No. 7	Q.700–Q.799
Q3 INTERFACE	Q.800–Q.849
DIGITAL SUBSCRIBER SIGNALLING SYSTEM No. 1	Q.850–Q.999
PUBLIC LAND MOBILE NETWORK	Q.1000–Q.1099
INTERWORKING WITH SATELLITE MOBILE SYSTEMS	Q.1100–Q.1199
INTELLIGENT NETWORK	Q.1200–Q.1699
SIGNALLING REQUIREMENTS AND PROTOCOLS FOR IMT-2000	Q.1700–Q.1799
SPECIFICATIONS OF SIGNALLING RELATED TO BEARER INDEPENDENT CALL CONTROL (BICC)	Q.1900–Q.1999
BROADBAND ISDN	Q.2000–Q.2999
SIGNALLING REQUIREMENTS AND PROTOCOLS FOR THE NGN	Q.3000–Q.3999
General	Q.3000–Q.3029
Network signalling and control functional architecture	Q.3030–Q.3099
Network data organization within the NGN	Q.3100–Q.3129
Bearer control signalling	Q.3130–Q.3179
Signalling and control requirements and protocols to support attachment in NGN environments	Q.3200–Q.3249
Resource control protocols	Q.3300–Q.3369
Service and session control protocols	Q.3400–Q.3499
Service and session control protocols – supplementary services	Q.3600–Q.3649
NGN applications	Q.3700–Q.3849
Testing for next generation networks	Q.3900–Q.3999

For further details, please refer to the list of ITU-T Recommendations.

Recommendation ITU-T Q.3314

Requirements and protocol at the interface between the mobile location management physical entity used as a proxy and the central instance of the mobile location management physical entity (M9 interface)

Summary

Recommendation ITU-T Q.3314 provides the signalling requirements and protocol for the M9 interface between the mobile location management physical entity as proxy (MLM-PE(P)) and the MLM-PE as the central instance (MLM-PE(C)) specified in Recommendation ITU-T Y.2018. The M9 interface provides information from the MLM-PE(P) and the MLM-PE(C) to registration/update and query mobility location information in both host-based and network-based mobility cases.

History

Edition	Recommendation	Approval	Study Group
1.0	ITU-T Q.3314	2012-05-22	11

Keywords

M9 interface, MMCF, mobility control.

FOREWORD

The International Telecommunication Union (ITU) is the United Nations specialized agency in the field of telecommunications, information and communication technologies (ICTs). The ITU Telecommunication Standardization Sector (ITU-T) is a permanent organ of ITU. ITU-T is responsible for studying technical, operating and tariff questions and issuing Recommendations on them with a view to standardizing telecommunications on a worldwide basis.

The World Telecommunication Standardization Assembly (WTSA), which meets every four years, establishes the topics for study by the ITU-T study groups which, in turn, produce Recommendations on these topics.

The approval of ITU-T Recommendations is covered by the procedure laid down in WTSA Resolution 1.

In some areas of information technology which fall within ITU-T's purview, the necessary standards are prepared on a collaborative basis with ISO and IEC.

NOTE

In this Recommendation, the expression "Administration" is used for conciseness to indicate both a telecommunication administration and a recognized operating agency.

Compliance with this Recommendation is voluntary. However, the Recommendation may contain certain mandatory provisions (to ensure, e.g., interoperability or applicability) and compliance with the Recommendation is achieved when all of these mandatory provisions are met. The words "shall" or some other obligatory language such as "must" and the negative equivalents are used to express requirements. The use of such words does not suggest that compliance with the Recommendation is required of any party.

INTELLECTUAL PROPERTY RIGHTS

ITU draws attention to the possibility that the practice or implementation of this Recommendation may involve the use of a claimed Intellectual Property Right. ITU takes no position concerning the evidence, validity or applicability of claimed Intellectual Property Rights, whether asserted by ITU members or others outside of the Recommendation development process.

As of the date of approval of this Recommendation, ITU had not received notice of intellectual property, protected by patents, which may be required to implement this Recommendation. However, implementers are cautioned that this may not represent the latest information and are therefore strongly urged to consult the TSB patent database at <http://www.itu.int/ITU-T/ipr/>.

© ITU 2013

All rights reserved. No part of this publication may be reproduced, by any means whatsoever, without the prior written permission of ITU.

Table of Contents

	Page
1 Scope	1
2 References.....	1
3 Definitions	2
3.1 Terms defined elsewhere	2
3.2 Terms defined in this Recommendation.....	2
4 Abbreviations and acronyms	2
5 M9 interface.....	3
5.1 Overview	3
5.2 M9 reference model.....	3
5.3 Physical entities and capabilities	3
6 Protocol specifications.....	4
6.1 Location binding registration/update request/response	5
6.2 Mobility location query request/response	5
7 Message specification.....	7
7.1 Use of Diameter base protocol	7
7.2 Diameter base protocol message mapping on the M9 interface.....	8
7.3 Diameter base protocol message formats on the M9 interface.....	10
8 Security considerations	15
Appendix I – High-level information flow at M9.....	16
I.1 Mobility location binding registration/update during network attachment....	16
I.2 Mobility location binding registration/update during handover.....	17
I.3 Route optimization considerations for network-based handover	19
Bibliography.....	22

Recommendation ITU-T Q.3314

Requirements and protocol at the interface between the mobile location management physical entity used as a proxy and the central instance of the mobile location management physical entity (M9 interface)

1 Scope

This Recommendation defines the protocol for the M9 interface between the mobile location management physical entity as proxy (MLM-PE(P)) and the MLM-PE as the central instance (MLM-PE(C)) specified in [ITU-T Y.2018]. The M9 reference point provides the information flows to register and update mobility location information in both host-based and network-based mobility cases specified in [ITU-T Y.2018]. In the network-based mobility case, the MLM-PE(P) sends the location registration and/or update request to the MLM-PE(C). In the host-based mobility case, the user equipment (UE) sends the location registration and/or update request to the MLM-PE(P), which will forward it to the MLM-PE(C).

The M9 reference point also provides the information flows for retrieving the binding location information regarding UE's reachability. The MLM-PE(P) holds the binding information between mobile user ID (or persistent address) and temporary address (or lower tunnel end point address). The MLM-PE(C) holds the binding information between mobile user ID (or persistent address), and address of the MLM-PE(P). The MLM-PE(P) may identify the corresponding MLM-PE(C) by extracting the home domain from the mobile user ID. The MLM-PE(P) may initiate route optimization through this interface.

2 References

The following ITU-T Recommendations and other references contain provisions which, through reference in this text, constitute provisions of this Recommendation. At the time of publication, the editions indicated were valid. All Recommendations and other references are subject to revision; users of this Recommendation are therefore encouraged to investigate the possibility of applying the most recent edition of the Recommendations and other references listed below. A list of the currently valid ITU-T Recommendations is regularly published. The reference to a document within this Recommendation does not give it, as a stand-alone document, the status of a Recommendation.

- [ITU-T Y.2018] Recommendation ITU-T Y.2018 (2009), *Mobility management and control framework and architecture within the NGN transport stratum*.
- [ITU-T Y.2701] Recommendation ITU-T Y.2701 (2007), *Security requirements for NGN release 1*.
- [ETSI ES 283 034] ETSI ES 283 034 (2008), *e4 interface based on the Diameter protocol*.
- [ETSI ES 283 035] ETSI ES 283 035 (2008), *e2 interface based on the Diameter protocol*.
- [ETSI TS 129 229] ETSI TS 129 229 (2010), *Cx and Dx interfaces based on the Diameter protocol; Protocol details (3GPP TS 29.229 version 9.3.0 Release 9)*.
- [ETSI TS 129 272] ETSI TS 129 272 v9.2.0 (2010), *Mobility Management Entity (MME) and Serving GPRS Support Node (SGSN) related interfaces based on Diameter protocol (3GPP TS 29.272 version 9.2.0 Release 9)*.

3 Definitions

3.1 Terms defined elsewhere

This Recommendation uses the following term defined elsewhere:

3.1.1 authentication [b-ITU-T Y.2014]: A property by which the correct identifier of an entity or party is established with a required assurance. The party being authenticated could be a user, subscriber, home environment or serving network.

3.2 Terms defined in this Recommendation

3.2.1 location information (Based on the definition given in [b-ITU-T Q.1001]): Actual location of the mobile station (e.g., PLMN, MSC area, location area, as required).

3.2.2 location registration (Based on the definition given in [b-ITU-T Q.1741.3]): The procedure to register its presence in a registration area when the user equipment enters a new registration area.

3.2.3 nomadism (Based on the definition given in [b-ITU-T Q.1761]): Ability of the user to change his network access point after moving; when changing the network access point, the user's service session is completely stopped and then started again, i.e., there is no session continuity or hand-over possible.

NOTE – It is assumed that the normal usage pattern is that users shutdown their service session before moving to another access point.

4 Abbreviations and acronyms

This Recommendation uses the following abbreviations and acronyms:

ATM	Asynchronous Transfer Mode
AVP	Attribute-Value Pair
FQDN	Fully Qualified Domain Name
GPRS	General Packet Radio Service
GTP	GPRS Tunnelling Protocol
HDC-PE	Handover Decision and Control Physical Entity
ID	Identification
MLM-FE	Mobile Location Management Functional Entity
MLM-PE	Mobile Location Management Physical Entity
MMCF	Mobility Management Control Functions
MLM-PE(C)	An instance of the MLM-PE performing the Central mobile location management role
MLM-PE(P)	An instance of the MLM-PE performing the Proxy mobile location management role
MPLS	Multiprotocol Label Switching
NACF	Network Attachment Control Function
NAT	Network Address Translation
NID-PE	Network Information Distribution Physical Entity
NIR-PE	Network Information Repository Physical Entity
PD-PE	Policy Decision Physical Entity

PPP	Point-to-Point Protocol
RACF	Resource Admission and Control Function
SCTP	Stream Control Transport Protocol
TLM-PE	Transport Location Management Physical Entity
UE	User Equipment
VCI	Virtual Circuit Identifier
VPI	Virtual Path Identifier

5 M9 interface

5.1 Overview

This Recommendation specifies the protocol for the M9 reference point.

The M9 reference point provides the information flows to register and update mobility location information via the M9 interface specified in [ITU-T Y.2018] in both the host-based and network-based mobility cases. The M9 reference point also provides the information flows for retrieving the binding location information regarding the UE's reachability.

Therefore, two operations may occur at the M9 interface as follows:

- mobility location binding registration and/or update
- mobility location query.

5.2 M9 reference model

Figure 5-1 describes the M9 reference architecture. This illustration can be used as the initial architecture.

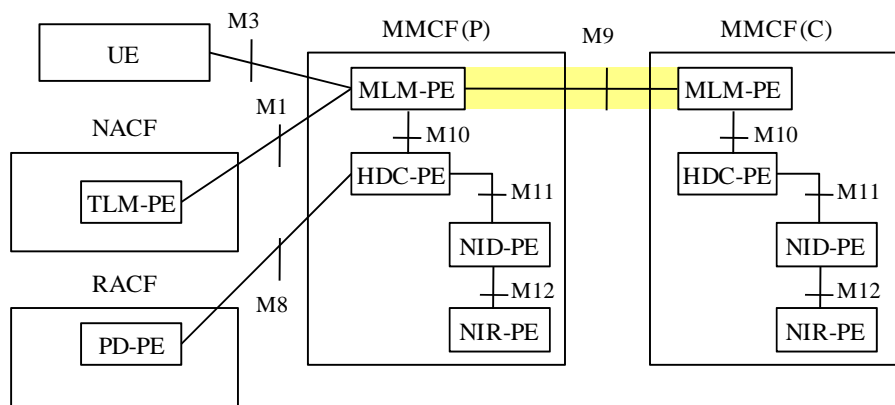

Figure 5-1 – M9 reference model

5.3 Physical entities and capabilities

5.3.1 Mobile location management physical entity (MLM-PE)

The MLM-PE has the following responsibilities:

- in the case of network-based mobility, initiating location registration on behalf of the UE;
- processing location registration messages sent from, or on behalf of the UE;
- optionally, maintaining the binding between the mobility service user ID and persistent IP address assigned to the UE;

- management of the binding between the persistent IP address assigned to the UE and its temporary IP address, in the case of host-based mobility, or the address of the lower tunnel end point, in the case of network-based mobility;
- optionally, holding two location bindings for the mobile UE by marking the binding for the serving network as active state and marking the binding for target network as standby state;
- supporting separation of control and data plane by allowing the MLM-PE address and data forwarding end point address (i.e., tunnel end point address) to be different;
- indication of a new mobility location binding and distribution of binding information to the HDC-PE.

The MLM-PE has two roles, as proxy (MLM-PE(P)) and as the central instance (MLM-PE(C)). The MLM-PE(P) and MLM-PE(C) roles may be co-located in specific deployments providing only host-based mobility. The MLM-PE(C) provides a central point of contact for correspondent nodes (e.g., the service control function (SCF)). The MLM-PE(P) and MLM-PE(C) together provide hierarchical location management. The MLM-PE(P) holds and updates the binding between mobile user ID, persistent address, and temporary/lower tunnel end point address. The MLM-PE(C) holds the binding between mobile user ID, persistent address, and address of the MLM-PE(P). The MLM-PE(P) may identify the corresponding MLM-PE(C) by extracting the home domain from the mobile user ID.

The MLM-PE(P) consists of the following functions:

- In the host-based case, it provides the first point of contact for location registration for mobile users. As such, it appears as a proxy for the MLM-PE(C) from the point of view of the UE, while appearing as a proxy for the UE from the point of view of the MLM-PE(C). The mobile UE obtains the address of the MLM-PE(P) in the attachment procedure.
- In the network-based mobility case, the MLM-PE(P) acts as a proxy for the UE from the point of view of the network side.
- The MLM-PE(P) supports IP-based paging to locate the mobile UE.
- In the host-based case, the MLM-PE(P) may interwork between different mobility signalling protocols (e.g., due to a difference in IP versions supported) at the UE and at the MLM-PE(C).
- Signalling for location registration in the host-based case is secured through the security association between the UE and the MLM-PE(P). The security association is dynamically created based on the keying materials generated in the attachment procedure.
- The MLM-PE(P) is responsible for requesting the HDC-PE to perform handover control as a consequence of mobile location registration or update.
- The MLM-PE(P) may be the proxy of the UE for initiating route optimization, especially in the case of interworking between signalling protocols.
- If there is a second anchor point between the UE and the anchor point to which the MLM-PE(C) corresponds, the MLM-PE(P) carries the additional address binding.
- The MLM-PE(P) may be used to transform addresses within the signalling because of intervening network address translations (NATs).
- The MLM-PE(P) may be used to provide address anonymity to the UE.

6 Protocol specifications

The M9 reference point enables the MLM-PE(P) to query and update binding location information from/to the MLM-PE(C). The primary parameter for retrieving the binding location information shall be the mobile user identification (ID), persistent address, and address of the MLM-PE(P).

The following information primitives are used in this interface:

- mobility location binding registration and/or update request and/or response;
- mobility location query request and/or response.

6.1 Location binding registration/update request/response

This information flow is used to register and update mobility location information in both the host-based and network-based mobility cases. In the network-based mobility case, the MLM-PE(P) will send the location registration/update request to the MLM-PE(C). In the host-based mobility case, the UE will send the location registration/update request to the MLM-PE(P), which will pass it on to the MLM-PE(C).

The mobility service subscriber ID and information providing the location binding between the persistent location identifier and the location of the MLM-PE(P) are included in the messages for both host-based and network-based mobility.

The reference point M9 supports the following two primitives for this operation:

- mobility location binding registration/update request (see Table 6-1);
- mobility location binding registration/update response (see Table 6-2).

**Table 6-1 – Mobility location binding registration/update request
(MLM-PE(P) → MLM-PE(C))**

Information element	Explanation
Mobility service subscriber identifier (conditionally mandatory) (Note)	The user/UE identifier authenticated for mobility services. This will be the same as the transport subscriber identifier in the integrated scenario.
Persistent IP address information	A set of IP address information used for locating the mobile UE.
– Unique IP address	The persistent IP address allocated to the attached mobile UE.
– Address realm	The addressing domain in which the IP address is significant.
Address of MLM-PE(P)	The address of the MLM-PE instance which sends the location registration.
NOTE – Mobility service subscriber identifier is required if persistent address is private.	

**Table 6-2 – Mobility location binding registration/update response
(MLM-PE(C) → MLM-PE(P))**

Information element	Explanation
Mobility service subscriber identifier	The identifier of the subscriber for which the mobility service is to be provided.
Binding request result	Indication of the success or failure of the binding request.

6.2 Mobility location query request/response

In the route optimization case (see clause 7.3.5 of [ITU-T Y.2018]), the MLM-PE(C) may query and obtain the mobile UE's current binding location information through this reference point in order to pass it to the MLM-PE(C) associated with a correspondent UE.

If a related entity (e.g., a correspondent node) requests the MLM-PE(C) to provide an indication regarding UE reachability, the MLM-PE(C) may send a response to the MLM-PE(P) through this

reference point to get that information. The MLM-PE(P) will send the location binding information to the related entity (e.g., correspondent node) via the MLM-PE(C).

Reference point M9 supports two primitives for this purpose:

- mobility location query request (see Table 6-3);
- mobility location query response (see Table 6-4).

Table 6-3 – Mobility location query request (MLM-PE(C) → MLM-PE(P))

Information element	Explanation
Mobility service subscriber identifier (Note)	The identifier of the subscriber for which the mobility service is to be provided.
Persistent IP address information (Note)	A set of IP address information used for locating the mobile UE.
– Unique IP address	The persistent IP address allocated to the attached mobile UE.
– Address realm	The addressing domain in which the IP address is significant.
Requested items	The item list to the requested information.
Address of MLM-PE(P)	The address of the MLM-PE instance which sends the location query.
NOTE – Either the mobility service subscriber identifier or the persistent IP address information is required.	

Table 6-4 – Mobility location query response (MLM-PE(P) → MLM-PE(C))

Information element	Explanation
Mobility service subscriber identifier	The identifier of the subscriber for which the mobility service is to be provided.
Persistent IP address information	A set of IP address information used for locating the mobile UE.
– Unique IP address	The persistent IP address allocated to the attached mobile UE.
– Address realm	The addressing domain in which the IP address is significant.
Temporary IP address information	A set of IP address information used for locating the access network to which the UE is attached.
– Unique IP address	The temporary IP address allocated to the attached mobile UE.
– Address realm	The addressing domain in which the IP address is significant.
Address of MLM-PE(P)	The address of the MLM-PE instance which the mobile UE is attached.
RACS contact point (optional)	The fully qualified domain name (FQDN) or IP address of the RACS where resource request shall be sent (i.e., PD-PE address).
Terminal type (optional)	The type of the mobile UE.
Type of access transport (optional)	The type of access network to which the mobile UE is attached.
IP connectivity status (optional)	Whether IP connectivity to/from the user equipment is currently available.

Table 6-4 – Mobility location query response (MLM-PE(P) → MLM-PE(C))

Information element	Explanation
Physical connection identifier (optional)	A local identifier for physical connection of access transport network that the mobile UE is attached to (e.g., IP address of PE-PE device, and MAC address or link ID and physical port).
Logical connection identifier (optional)	A local identifier for logical connection of access transport network to which the mobile UE is connected (e.g., ATM VPI/VCI, PPP, MPLS label, GTP tunnel and logical port). It can be used to locate the layer 2 connection and pertinent network devices for a particular UE requesting the access transport resource.

7 Message specification

7.1 Use of Diameter base protocol

Along with the clarifications listed in the following clauses (i.e., 7.1.1-7.1.6), the Diameter base protocol defined in [b-IETF RFC 3588] shall apply.

7.1.1 Securing Diameter messages

For secure transport of Diameter messages, IPsec may be used. Guidelines on the use of stream control transport protocol (SCTP) with IPsec can be found in [b-IETF RFC 3554].

7.1.2 Accounting functionality

Accounting functionality (accounting session state machine, related command codes and AVPs) is not used at the M9 interface.

7.1.3 Use of sessions

Diameter sessions are implicitly terminated. An implicitly terminated session is one for which the server does not maintain state information. The client does not need to send any re-authorization or session termination requests to the server [b-IETF RFC 3588].

The Diameter base protocol includes the Auth-Session-State AVP as the mechanism for the implementation of implicitly terminated sessions.

The client (server) shall include, in its requests or responses, the Auth-Session-State AVP set to the value NO_STATE_MAINTAINED (1), as described in [b-IETF RFC 3588]. As a consequence, the server does not maintain any state information about this session and the client does not need to send a session termination request. Neither the Authorization-Lifetime AVP, nor the Session-Timeout AVP shall be present in requests or responses.

7.1.4 Transport protocol

Diameter messages over the M9 interface shall make use of SCTP as defined in [b-IETF RFC 2960] and shall utilize the new SCTP checksum method specified in [b-IETF RFC 3554].

7.1.5 Routing considerations

This clause specifies the use of the Diameter routing AVPs, Destination-Realm and Destination-Host.

With reference to the Diameter protocol used at the M9 interface, the MLM-PE(P) acts as the Diameter client and the MLM-PE(C) acts as a Diameter server.

Requests initiated by the MLM-PE(P) towards a MLM-PE(C) shall include both Destination-Host and Destination-Realm AVPs. The MLM-PE(P) obtains the Destination-Host AVP to use in requests towards a MLM-PE(C) from configuration data and/or the subscriber profile. Consequently, the Destination-Host AVP is declared as mandatory for all requests initiated by the MLM-PE. A Destination-Realm AVP is declared as mandatory for all requests initiated by the MLM-PE.

7.1.6 Advertising application support

The Capabilities-Exchange-Request (CER) and the Capabilities-Exchange-Answer (CEA) commands are specified in [b-IETF RFC 3588]. The Diameter-base application identifier (0) shall be used in the Diameter message header of these messages.

If both MLM-PE(P) and MLM-PE(C) indicate support of the M9 application, then the M9 application identifier (16777306) shall be used in the Diameter message header of all subsequent messages exchanged within this association.

Support of the M9 application within the CER/CEA is indicated by supplying an instance of the Vendor-Specific-Application-Id containing a Vendor-Id AVP set to ITU-T (11502) and an Auth-Application-Id AVP set to M9 (16777306).

The vendor identifier value of ITU-T (11502) shall be included in the Vendor-Id AVP of the CER and CEA commands, and in the Vendor-Id AVP within the Vendor-Specific-Application-Id grouped AVP of the CER and CEA commands. Additionally, the MLM-PE(C) and the MLM-PE(P) are required to advertise the support of AVPs specified in the Diameter related documents of 3GPP, ETSI and ITU-T, by including the values 10415 (3GPP), 13019 (ETSI) and 11502 (ITU-T) in three different instances of the Supported-Vendor-Id AVP in the CER and CEA commands respectively. See Table 7-1.

Table 7-1 – Vendor identifiers for M9

Vendor	Vendor identifier
3GPP	10415
ETSI	13019
ITU-T	11502

NOTE – The Vendor-Id AVP included in CER and CEA commands that are not included in the Vendor-Specific-Application-Id AVPs, as described above, shall indicate the manufacturer of the Diameter node as per [b-IETF RFC 3588].

7.2 Diameter base protocol message mapping on the M9 interface

This Recommendation uses the four Diameter commands identified in Table 7-2 which are defined in [ETSI TS 129 229] and [ETSI TS 129 272]. Other commands are ignored by the MLM-PE(P) and the MLM-PE(C).

Table 7-2 – Command code

Command	Abbreviation	Defining reference	Command code	See clause
Update-Location-Request	ULR	[ETSI TS 129 272]	316	7.2.1
Update-Location-Answer	ULA	[ETSI TS 129 272]	316	7.2.2
Location-Information-Request	LIR	[ETSI TS 129 229]	302	7.2.3
Location-Information-Answer	LIA	[ETSI TS 129 229]	302	7.2.4

Clauses 7.2.1 and 7.2.2 describe the mapping between information elements defined in the M9 interface and Diameter AVPs.

Tables 7-3, 7-4, 7-5 and 7-6 describe this mapping, and each information element is marked as (M) mandatory, (C) conditional or (O) optional. See [ETSI ES 129 272].

7.2.1 Mobility location binding registration/update

Mobility location binding registration/update request/response is mapped to the commands Update-Location-Request Answer in the Diameter application specified in S6a interface. See [ETSI TS 129 272]. Tables 7-3 and 7-4 detail the information elements involved and their mappings to Diameter AVPs.

Table 7-3 – Mapping of mobility location binding registration/update request to Diameter AVP

Information element name		Diameter AVP	Category
Mobility service subscriber identifier		User-Name	C
Persistent IP address information	Unique IP Address	Globally-Unique-Address	C
	Address Realm		
Address of MLM-PE(P)		MLM-PE-Contact-Point	M

Table 7-4 – Mapping of mobility location binding registration/update response to Diameter AVP

Information element name		Diameter AVP	Category
Mobility service subscriber identifier		User-Name	C
Binding request result		Experimental_Result	M

7.2.2 Mobility location query

Mobility location query request/response is mapped to the commands Location Information Request/Answer in the Diameter application specified in Cx interface defined in [ETSI TS 129 229]. Tables 7-5 and 7-6 detail the information elements involved and their mappings to Diameter AVPs.

Table 7-5 – Mapping of mobility location query request to Diameter AVP

Information element name		Diameter AVP	Category
Mobility service subscriber identifier		User-Name	C
Persistent IP address information	Unique IP Address	Globally-Unique-Address	C
	Address Realm		
Requested items		Requested-Information	O
Address of MLM-PE(P)		MLM-PE-Contact-Point	M

Table 7-6 – Mapping of mobility location query response to Diameter AVP

Information element name		Diameter AVP	Category
Result		Result-Code/Experimental-Result	M
Mobility service subscriber identifier		User-Name	O
Persistent IP address information	Unique IP Address	Globally-Unique-Address	C
	Address Realm		
Temporary IP address information	Unique IP Address	Globally-Unique-Address	C
	Address Realm		
Address of MLM-PE(P)		MLM-PE-Contact-Point	O
RACS contact point		RACS-Contact-Point	O
Access transport network type		Access-Network-Type	O
Terminal type		Terminal-Type	O
IP connectivity status		IP-connectivity-status	O
Physical connection identifier		Physical-Connection-Identifier	O
Logical connection identifier		Logical-Connection-Identifier	O

7.3 Diameter base protocol message formats on the M9 interface

7.3.1 Commands

7.3.1.1 Mobility location binding registration/update request

The mobility location binding registration/update request, indicated by the Command-Code field set to 316 and the "R" bit set in the Command Flags field, is sent by the MLM-PE(C) to the MLM-PE(P) in order to notify changes in the user location data in the MLM-PE(C). This command is defined in [ETSI TS 129 272] and used with additional AVPs defined in this Recommendation.

Message format:

```
< Update-Location-Request > ::= < Diameter Header: 316, REQ, PXY, 16777306 >
    < Session-Id >
    { Vendor-Specific-Application-Id }
    { Auth-Session-State }
    { Origin-Host }
    { Origin-Realm }
    [ Destination-Host ]
    { Destination-Realm }
    [ User-Name ]
    [ Globally-Unique-Address ]
    { MLM-PE-Contact-Point }
    * [ AVP ]
    * [ Proxy-Info ]
    * [ Route-Record ]
```

7.3.1.2 Mobility location binding registration/update response

The mobility location binding registration/update response, indicated by the Command-Code field set to 316 and the "R" bit cleared in the Command Flags field, is sent by a client in response to the Update-Location-Request (ULR) command. The Experimental-Result AVP may contain one of the values defined in clause 7.3.2.

Message format:

```
< Update-Location-Answer > ::= < Diameter Header: 316, PXY, 16777306>
    < Session-Id >
    { Vendor-Specific-Application-Id }
    [ Result-Code ]
    [ Experimental-Result ]
    { Auth-Session-State }
    { Origin-Host }
    { Origin-Realm }
    [ User-Name ]
    [ Experimental-Result ]
    *[ AVP ]
    *[ Failed-AVP ]
    *[ Proxy-Info ]
    *[ Route-Record ]
```

7.3.1.3 Mobility location query request

The mobility location query request, indicated by the Command-Code field set to 302 and the "R" bit set in the Command Flags field, is sent by a Diameter client to a Diameter server in order to request user data. This command is defined in [ETSI TS 129 229] and used with the additional AVPs defined in this Recommendation.

Message format:

```
< Location-Information-Request > ::= < Diameter Header: 302, REQ, PXY, 16777306>
    < Session-Id >
    { Vendor-Specific-Application-Id }
    { Auth-Session-State }
    { Origin-Host }
    { Origin-Realm }
    [ Destination-Host ]
    { Destination-Realm }
    [ User-Name ]
    [ Globally-Unique-Address ]
    [ Requested-Information ]
    { MLM-PE-Contact-Point }
    *[ AVP ]
    *[ Proxy-Info ]
    *[ Route-Record ]
```

7.3.1.4 Mobility location query response

The mobility location query response, indicated by the Command-Code field set to 302 and the "R" bit cleared in the Command Flags field, is sent by a server in response to the Location-Information-Request command. This command is defined in [ETSI TS 129 229] and used with the additional AVPs defined in this Recommendation. The Experimental-Result AVP may contain one of the values defined in clause 7.3.2.

Message format:

```
< Location-Information-Answer > ::= < Diameter Header: 302, PXY, 16777306>
    < Session-Id >
    { Vendor-Specific-Application-Id }
```

```

[ Experimental-Result ]
{ Auth-Session-State }
{ Origin-Host }
{ Origin-Realm }
[ User-Name ]
[ Globally-Unique-Address ]
[ Globally-Unique-Address ]
[ MLM-PE-Contact-Point ]
[ RACS-Contact-Point ]
[ Access-Network-Type ]
[ Terminal-Type ]
[ IP-Connectivity-status ]
[ Physical-Connection-Identifier ]
[ Logical-Connection-Identifier ]
*[ AVP ]
*[ Failed-AVP ]
*[ Proxy-Info ]
*[ Route-Record ]

```

7.3.2 Experimental-Result-Code AVP values

This clause defines specific values of the Experimental-Result-Code AVP used in this Recommendation. The Experimental-Result-Code AVP shall be used to indicate success/errors as defined in the Diameter base protocol. Most of the specific values are imported from 3GPP and ETSI specifications, as indicated in [ETSI TS 129 272].

7.3.3 Attribute value pairs (AVPs)

Tables 7-7, 7-8 and 7-9 summarize the AVPs used in this Recommendation. These are in addition to the AVPs defined in [b-IETF RFC 3588].

Table 7-7 describes the Diameter AVPs that are used within this Recommendation that have been defined by ETSI [ETSI ES 283 035]. This table provides their AVP code values, types, possible flag values and whether or not the AVP may be encrypted. The Vendor-Id header of all AVPs identified in this table shall be set to ETSI (13019). These AVPs are described in this Recommendation for information only; however, the normative detail for these AVPs is contained in [ETSI ES 283 035].

Table 7-7 – Diameter AVPs imported from [ETSI ES 283 035]

Attribute name	AVP code	Clause defined	Value type (Note 2)	AVP flag rules (Note 1)				May encrypt
				Must	May	Should not	Must not	
RACS-Contact-Point	351	7.3.3.5	DiameterIdentity	V	M			Y
Terminal-Type	352	7.3.3.6	OctetString	V	M			Y
Requested-Information	353	7.3.3.2	Enumerated	V			M	Y
NOTE 1 – The AVP header bit denoted as 'M' indicates whether support of the AVP is required. The AVP header bit denoted as 'V' indicates whether the optional Vendor-Id field is present in the AVP header. For further details, see [b-IETF RFC 3588]. NOTE 2 – The value types are defined in [b-IETF RFC 3588].								

Table 7-8 describes the Diameter AVPs defined by the e4 interface protocol [ETSI ES 283 034] and used within this Recommendation. These AVPs are described in this Recommendation for information only; however, the normative details for these AVPs are contained in [ETSI ES 283 034]. The Vendor-Id header of all AVPs defined in Table 7-8 shall be set to ETSI (13019).

Table 7-8 – Diameter AVPs imported from [ETSI ES 283 034]

Attribute name	AVP code	Clause defined	Value type	AVP flag rules				May encrypt
				Must	May	Should not	Must not	
Globally-Unique-Address	300	7.3.3.1	Grouped	M,V				Y
Logical-Connection-Identifier	302	7.3.3.9	OctetString	V	M			Y
Access-Network-Type	306	7.3.3.3	Grouped	V	M			Y
IP-Connectivity-Status	305	7.3.3.7	Enumerated	V	M			Y
Physical-Connection-Identifier	313	7.3.3.8	UTF8String	V	M			Y

Table 7-9 describes the AVPs defined solely within this Recommendation. The ITU-T Vendor-Id (11502) shall be used in the Vendor-Id field of the AVP header.

Table 7-9 – Diameter AVPs defined in this Recommendation

Attribute name	AVP code	Clause defined	Value type	AVP flag rules				May encrypt
				Must	May	Should not	Must not	
MLM-PE-Contact-Point	1040	7.3.3.4	DiameterIdentity	M,V				Y

7.3.3.1 Globally-Unique-Address AVP

The Globally-Unique-Address AVP (AVP code 300 13019) is of type Grouped.

AVP format:

```
Globally-Unique-Address ::= < AVP Header: 300 13019 >
    [Framed-IP-Address]
    [Framed-IPv6-Prefix]
    [Address-Realm]
```

7.3.3.2 Requested-Information AVP

The Requested-Information AVP (AVP code 353 13019) is of type Enumerated. The following values are defined:

- SUBSCRIBER-ID (0)
- LOCATION-INFORMATION (1)
- RACS-CONTACT-POINT (2)
- ACCESS-NETWORK-TYPE (3)
- Terminal-TYPE (4)
- LOGICAL-CONNECTION-IDENTIFIER (5)
- PHYSICAL-CONNECTION-IDENTIFIER (6)
- ACCESS-NETWORK-TYPE (7)
- DEFAULT-CONFIGURATION (8)
- TRANSPORT-RESOURCE-SUBSCRIPTION (9)

- IP-CONNECTIVITY-STATUS (10).

7.3.3.3 Access-Network-Type AVP

The Access-Network-Type AVP (AVP code 306 13019) is of type Grouped; it indicates the type of port on which the user equipment is connected and the type of aggregation network.

AVP format:

```
Access-Network-Type ::= < AVP Header: 306 13019 >
    {NAS-Port-Type}
    [Aggregation-Network-Type]
```

7.3.3.4 MLM-PE-Contact-Point AVP

The MLM-PE-Contact-Point AVP (ITU-T AVP code 1040 11502) is of type DiameterIdentity and identifies the Local MLM-PE to which the mobile UE is attached.

7.3.3.5 RACS-Contact-Point AVP

The RACS-Contact-Point AVP (AVP code 351 13019) is of type DiameterIdentity and identifies the Resource and Admission Control Subsystem (RACS) element to which the resource reservation requests shall be sent.

7.3.3.6 Terminal-Type AVP

The Terminal-Type AVP (AVP code 352 13019) is of type OctetString and contains a value of the User Class DHCP Option (77).

7.3.3.7 IP-Connectivity-Status AVP

The IP-Connectivity-Status AVP (AVP code 305 13019) is of type Enumerated.

The following values are defined:

- IP-CONNECTIVITY-ON (0)
- IP-CONNECTIVITY-LOST (1).

7.3.3.8 Physical-Connection-Identifier AVP

The Physical-Connection-Identifier AVP (AVP code 313 13019) is of type UTF8String and identifies the physical access to which the user equipment is connected. It includes a port identifier and the identity of the access node where the port resides.

7.3.3.9 Logical-Connection-Identifier AVP

The Logical-Connection-Identifier AVP (AVP code 302 13019) is of type OctetString. This AVP contains either a Circuit-ID (as defined in [b-IETF RFC 3046]) or a technology independent identifier.

NOTE – In the xDSL/ATM case, the logical access ID may explicitly contain the identity of the VP (Virtual Path) and the VC (Virtual Circuit) carrying the traffic.

7.3.3.10 User-Name AVP

The User-Name AVP is of type UTF8String according to [b-IETF RFC 3588]. This AVP shall contain the international Mobility Service Subscribe Identity, such as Mobile Equipment Identity specified in 3GPP. See [ETSI TS 129 272].

7.3.4 Use of namespaces

This clause contains the namespaces that have either been created in this Recommendation, or the values assigned to existing namespaces managed by the Internet Assigned Numbers Authority (IANA). This Recommendation uses AVP values from the AVP Code namespace managed by ETSI for its Diameter vendor-specific applications. In addition, this Recommendation assigns AVP code values within the Diameter AVP Code namespace managed by ITU-T.

7.3.4.1 AVP codes

See clause 7.3.3.

7.3.4.2 Experimental-Result-Code AVP values

This Recommendation assigns the Experimental-Result-Code AVP values from the AVP Code namespace managed by ETSI for its Diameter vendor-specific applications. See clause 7.3.2.

7.3.4.3 Command code values

This Recommendation does not assign command code values but uses existing commands defined by the Internet Engineering Task Force (IETF), including those requested by 3GPP.

7.3.4.4 Application-ID value

This Recommendation defines the M9 Diameter application with Application-ID 16777306. The vendor identifier assigned by IANA to ITU-T (<http://www.iana.org/assignments/enterprise-numbers>) is 11502.

8 Security considerations

The security requirements within the requirements and protocol at the M9 interface are addressed by the security requirements for NGN as specified in [ITU-T Y.2701]. The M9 interface shall follow the security requirements specified in [ITU-T Y.2018].

Appendix I

High-level information flow at M9

(This appendix does not form an integral part of this Recommendation.)

I.1 Mobility location binding registration/update during network attachment

This clause describes the information flows required to achieve mobility location binding registration/update for a mobile UE. At each stage, the procedures vary depending on UE capabilities and network arrangements. Therefore, the scenarios in this Recommendation can be referred to as examples only.

The procedures for network attachment of a mobile UE differ from those for a fixed or merely nomadic terminal because:

- the part of the user profile that specifies the mobility service to be granted to the UE must be made available to the access network; and
- the functions related to mobility service must be engaged.

The first task in this procedure is to obtain the user identifier for the purpose of authorizing mobility service, which will be an authentication, authorization and accounting (AAA) entity in the mobile subscriber's home network. This will, in general, lead to an authentication exchange between the UE and the AAA entity, relayed by the transport authentication and authorization physical entity (TAA-PE). After the new IP addresses are configured, the mobile UE is ready for mobility location update and new data path creation for the target network. If successful, the user traffic towards mobile UE may be forwarded to the serving network and the target network simultaneously.

As noted in clause 6.4.1 in [ITU-T Y.2018], the MLM-PE(P) is the first point of contact for mobility location management signalling. The MLM-PE may hold two location bindings for the mobile UE; the binding for the serving network is marked as active while the binding for target network is marked as in standby state. To support separation of control and data plane, the MLM-PE address and the data forwarding end point address (i.e., tunnelling end point address) may be different.

I.1.1 Procedures for attachment in the case of host-based mobility

Figure I.1 shows the message flow, which is divided into four phases: the mobility location registration request phase from the UE (see 1.1 in Figure I.1), the mobility location registration request phase to MLM-PE(C) (see 1.2 in Figure I.1), the mobility location registration response phase to the MLM-PE(P) (see 1.3 in Figure I.1) and the mobility binding registration response phase to the UE (see 1.4 in Figure I.1). If a hierarchical mobility mechanism is adopted and the UE moves within the scope of a single MLM-PE(P), the MLM-PE(P) will update its own mobility location bindings but does not need to notify the MLM-PE(C).

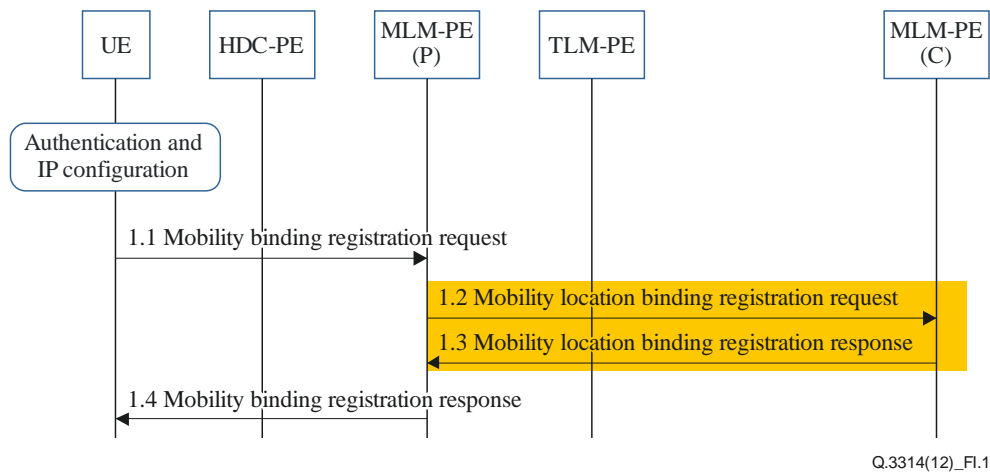

Figure I.1 – Information flows for location binding registration in the case of host-based mobility

I.1.2 Procedures for attachment in the case of network-based mobility

Figure I.2 shows the information flows in the case of network-based mobility. The same phases apply as in the host-based case. However, because there is no potential race between a binding update from the UE and the configuration of the MLM-PE(P), the mobility location management is triggered by TLM-PE. The MLM-PE(P) initiates the mobility location management procedure at the MLM-PE(C). The mobility management functions are shown in Figure I.2. In this figure, the MLM-PE(P) pushes the mobility binding registration request to the MLM-PE(C) (see 2.2 in Figure I.2) and MLM-PE(C) replies the mobility binding registration response to the MLM-PE(P) (see 2.3 in Figure I.2).

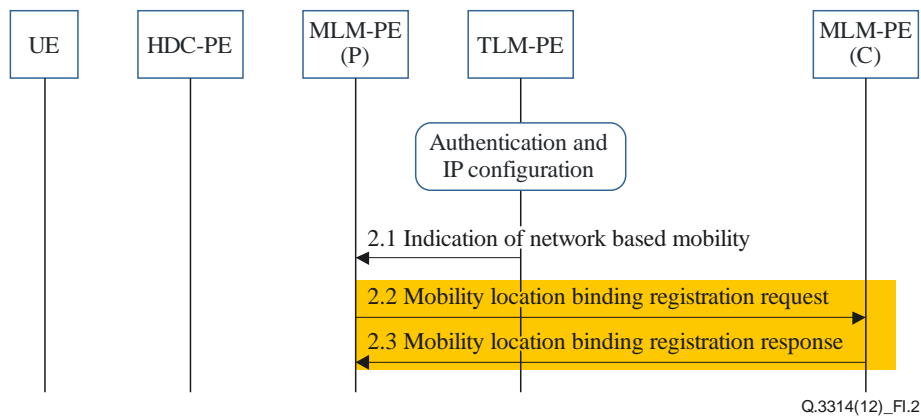

Figure I.2 – Information flows for location binding registration in the case of network-based mobility

I.2 Mobility location binding registration/update during handover

This clause describes the information flows required to achieve handover for a mobile UE. In each stage, the procedures vary depending on UE capabilities and network arrangements. Therefore, the scenarios in this Recommendation are provided as examples only.

Before the UE can achieve handover to a new access point or network, the network discovery and decision procedure must be performed. Network discovery is performed by the UE when it detects alternative access points to which it may move. The handover decision is the process of choosing an access point to which to move. Network discovery and the handover decision must consider the following three cases:

- the network makes the handover decision with input from the UE;
- the UE makes the handover decision with the assistance of information from the network;
- the UE makes the handover decision without assistance from the network.

In the latter two cases the UE can request user input or can be constrained by user intervention.

I.2.1 Procedures for location binding update in the case of host-based mobility

When the UE is acting together with the network, the UE makes the handover decision process. The UE may report a list of alternative access points to the HDC-PE. The UE may indicate its preference at this time regarding which entity makes the handover decision and which entity actually triggers the handover. Based on this information, the HDC-PE requests the RACF to check network resource availability on the potential path through each candidate network, and receives the resource check result from RACF. The HDC-PE then responds to the UE with a candidate access point list that is based on the UE's input, but reflects the results of the resource check and perhaps of local policy.

The UE makes its selection about the target networks, and then informs the HDC-PE (see 3.1 in Figure I.3). The HDC-PE prepares the new access point, as described in the next two clauses, and responds to the UE (see 3.2 in Figure I.3).

The UE sends the mobility location binding update request to the MLM-PE(P) (see 3.3 in Figure I.3). The mobility location binding update request is then relayed to the MLM-PE(C) (see 3.4 in Figure I.3) and the MLM-PE(C) replies the mobility binding registration response to the UE via the MLM-PE(P) (see 3.5 and 3.6 in Figure I.3).

After the mobility location binding update is finished, the UE is ready for new data path creation for the target network. If successful, the user traffic towards mobile UE may be forwarded to the serving network and the target network simultaneously.

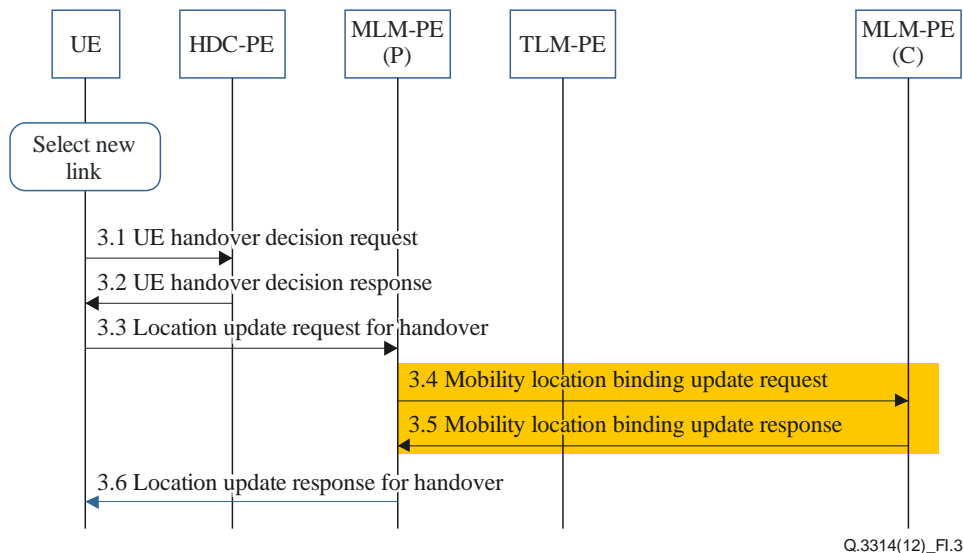

Figure I.3 – Information flows for location binding update during handover in the case of host-based mobility

I.2.2 Procedures for location binding update in the case of network-based mobility

The HDC-PE prepares the new access point during handover. The HDC-PE retrieves static network information about the target networks from the NID-PE and checks network resource availability on the potential path through each candidate network and receives the resource check result from RACF. Based on this information, the HDC-PE sends the network handover decision request to the UE indicating its choice of deciding entity and triggering entity. The UE reports a list of alternative

access points to the HDC-PE. The UE may indicate its preference at this time regarding which entity makes the handover decision and which entity actually triggers the handover.

The HDC-PE sends the mobility location binding update request to the MLM-PE(P) (see 4.3 in Figure I.4). The mobility location binding update request is then relayed to the MLM-PE(C) (see 4.4 in Figure I.4) and the MLM-PE(C) replies the mobility binding registration response to the HDC-PE via the MLM-PE(P) (see 4.5 and 4.6 in Figure I.4).

After the mobility location binding update is finished, the HDC-PE is ready for mobility location update and new data path creation for the target network. The actual triggering of handover execution is done by the HDC-PE.

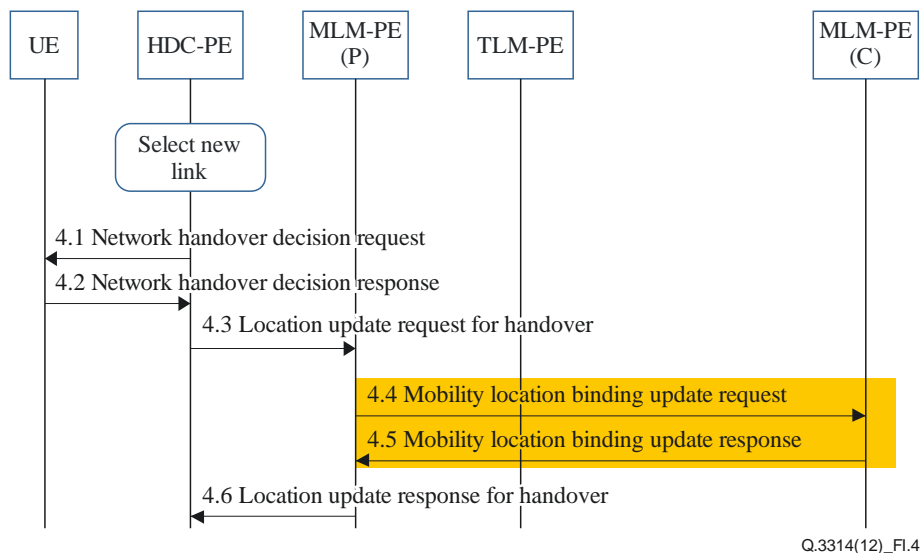

Figure I.4 – Information flows for location binding update during handover in the case of network-based mobility

I.3 Route optimization considerations for network-based handover

When a correspondent UE communicates with the mobile UE, normally packets from the correspondent UE will be intercepted by the transport function associated with the MLM-PE(C) (i.e., the L3HEF at the anchor point), then encapsulated and tunnelled to the current location of UE. For data path optimization, the MLM-PE(P) to which a correspondent UE is associated, may – based on administrative policies, cooperate with the MLM-PE(P) to which the mobile UE is associated to establish a direct tunnel between their respective networks. At this point the L3HEF at each end will encapsulate packets based on the location binding information exchanged between the two MLM-PE(P)s and will forward them directly to its peer L3HEF via the tunnel between them. The peer L3HEF delivers the de-capsulated packets to the correspondent or mobile UE respectively.

The L3HEF is required to be aware of active communication between the mobile UE and correspondent UE. The process is triggered when it detects a flow that matches policy indicating that route optimization may be attempted. It then indicates route optimization to its associated MLM-PE(P)(A) via the HDC-PE (see 5.1 in Figure I.5). The MLM-PE(P)(A) sends a location binding query request message to the MLM-PE(C) which contains a route optimization (RO) indication (see 5.2 in Figure I.5).

Upon receiving a location binding query request message including an RO request from MLM-PE(P)(A), MLM-PE(C) will perform route optimization operation and forward the location binding query request message to MLM-PE(P)(B) associated with the correspondent UE (see 5.3 in Figure I.5). MLM-PE(P)(B) replies with the location binding query response message including an RO response to MLM-PE(P)(A) via MLM-PE(C) (see 5.4 and 5.5 in Figure I.5). Upon receiving the RO response, MLM-PE(P)(A) sends the mobility location binding update request to

MLM-PE(P)(B) via MLM-PE(C) (see 5.6 and 5.7 in Figure I.5). MLM-PE(P)(B) replies with a location binding update response message to MLM-PE(P)(A) via MLM-PE(C) (see 5.8 and 5.9 in Figure I.5).

MLM-PE(C) may look up its location binding list and determine whether the two MLM-PE(P) instances have both registered to it. The MLM-PE(P)s are also registered to the correspondent MLM-PE(P) instance, indicating the location of each MLM-PE(P) to one another.

After route optimization operations are completed between the two MLM-PE(P)s, the location binding cache in each MLM-PE(P) is updated and the optimized tunnel is installed.

If the two MLM-PE(P) instances register to different MLM-PE(C) instances, the MLM-PE(C) associated with the mobile UE and MLM-PE(C) associated with the correspondent UE will coordinate with each other to provide the location of each MLM-PE(P) instance to the other. If the MLM-PE(C) associated with the mobile UE fails to retrieve the location of the MLM-PE(C) associated with the correspondent UE, it will notify the MLM-PE(P) associated with the mobile UE that route optimization is not available. The details for the different MLM-PE(C) case are shown in Figure I.6.

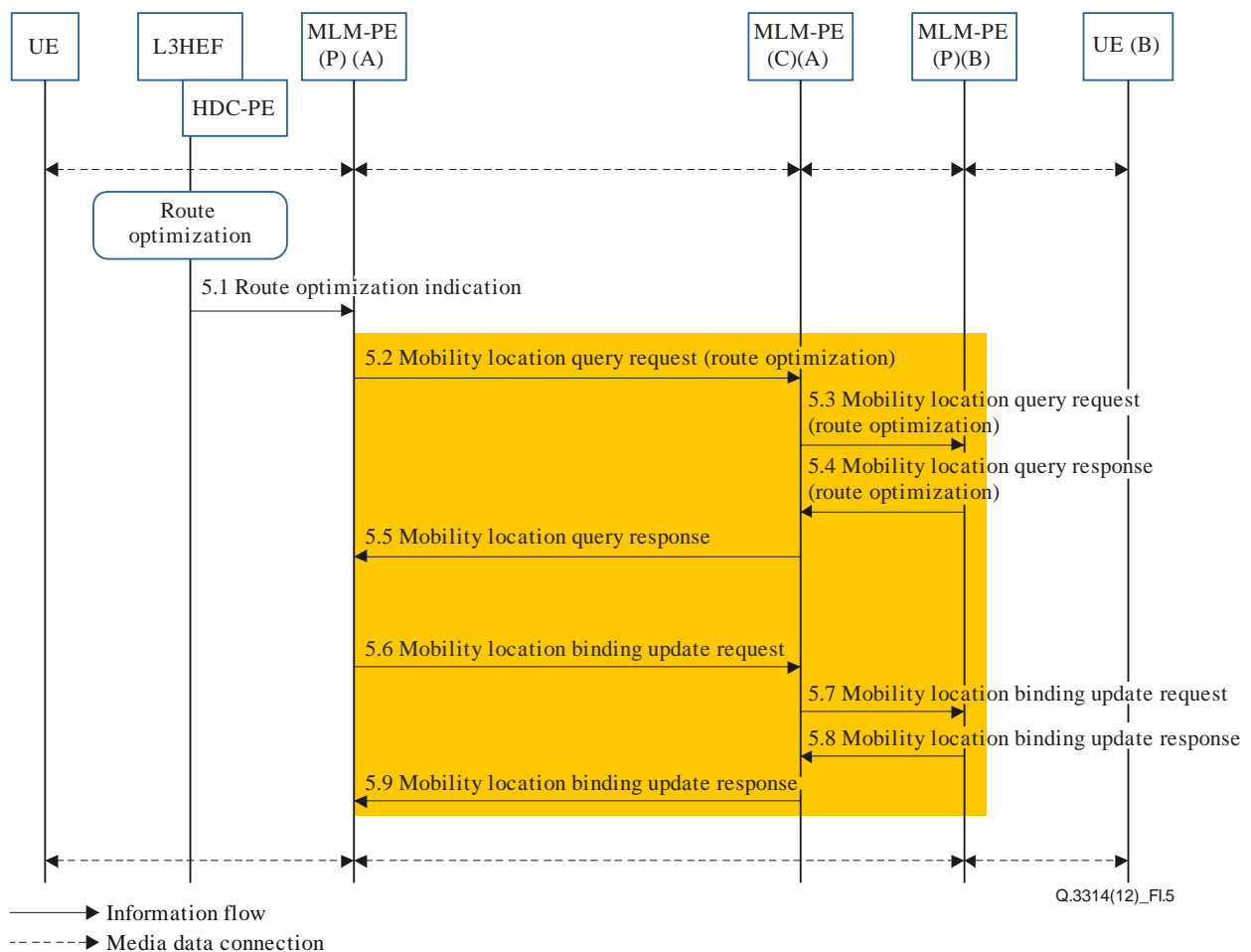

Figure I.5 – Route optimization considerations for the common MLM-PE(C)

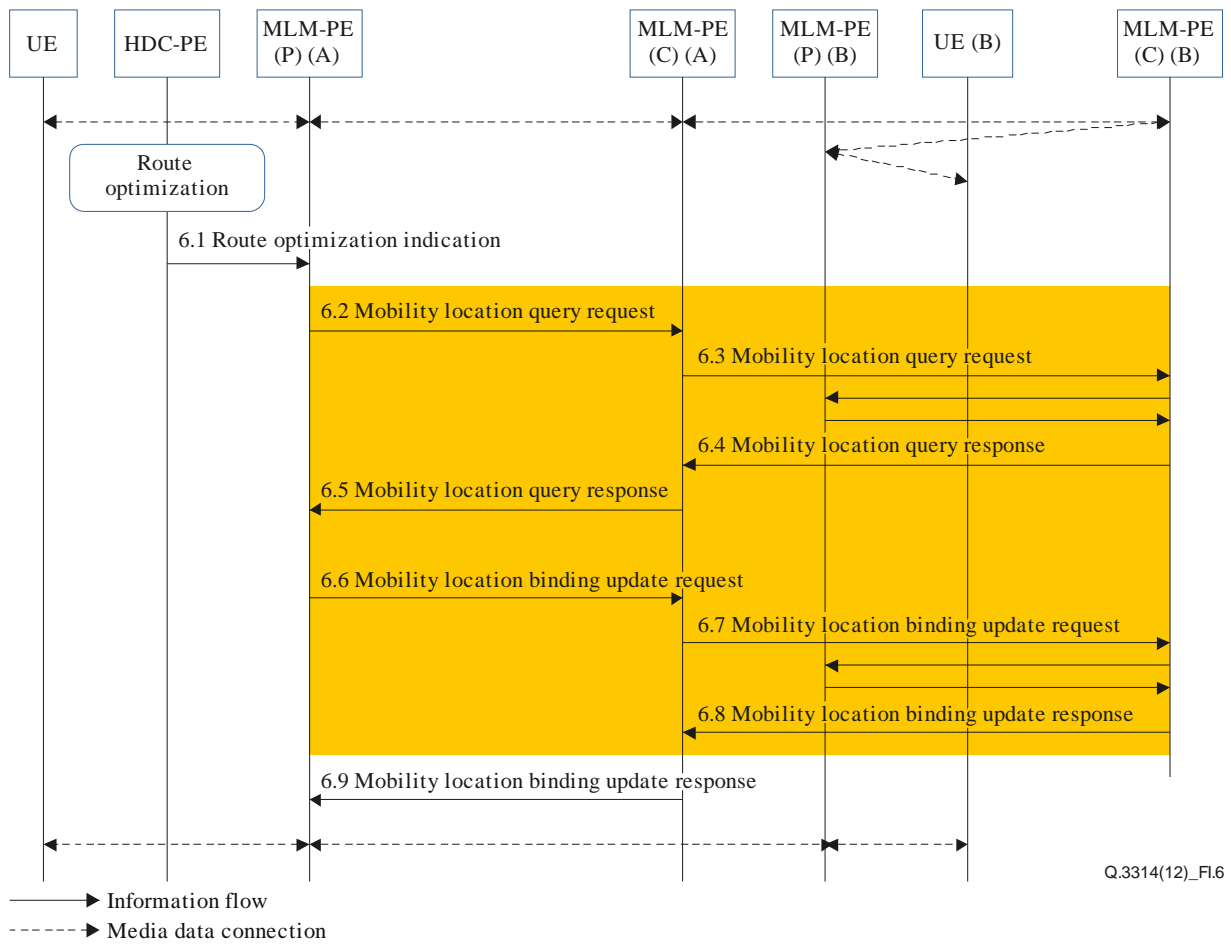

Figure I.6 – Route optimization considerations for the different MLM-PE(C)s

Bibliography

- [b-ITU-T Q.1001] Recommendation ITU-T Q.1001 (1988), *General aspects of public land mobile networks*.
- [b-ITU-T Q.1741.3] Recommendation ITU-T Q.1741.3 (2003), *IMT-2000 references to release 5 of GSM evolved UMTS core network*.
- [b-ITU-T Q.1761] Recommendation ITU-T Q.1761 (2004), *Principles and requirements for convergence of fixed and existing IMT-2000 systems*.
- [b-ITU-T Q.3222] Recommendation ITU-T Q.3222 (2010), *Requirements and protocol at the Ng interface between the transport location management physical entities*.
- [b-ITU-T Y.2012] Recommendation ITU-T Y.2012 (2010), *Functional Requirements and Architecture of next generation networks*.
- [b-ITU-T Y.2014] Recommendation ITU-T Y.2014 (2010), *Network attachment control functions in next-generation networks*.
- [b-IETF RFC 2960] IETF RFC 2960 (2000), *Stream Control Transmission Protocol*.
- [b-IETF RFC 3046] IETF RFC 3046 (2001), *DHCP Relay Agent Information Option*.
- [b-IETF RFC 3220] IETF RFC 3220 (2002), *IP Mobility Support for IPv4*.
- [b-IETF RFC 3554] IETF RFC 3554 (2003), *On the Use of Stream Control Transmission Protocol (SCTP) with IPSec*.
- [b-IETF RFC 3588] IETF RFC 3588 (2003), *Diameter Base Protocol*.
- [b-IETF RFC 3775] IETF RFC 3775 (2004), *Mobility Support in IPv6*.
- [b-IETF RFC 4005] IETF RFC 4005 (2005), *Diameter Network Access Server Application*.
- [b-IETF RFC 5191] IETF RFC 5191 (2008), *Protocol for Carrying Authentication for Network Access (PANA)*.
- [b-IETF RFC 5213] IETF RFC 5213 (2008), *Proxy Mobile IPv6*.

SERIES OF ITU-T RECOMMENDATIONS

Series A	Organization of the work of ITU-T
Series D	General tariff principles
Series E	Overall network operation, telephone service, service operation and human factors
Series F	Non-telephone telecommunication services
Series G	Transmission systems and media, digital systems and networks
Series H	Audiovisual and multimedia systems
Series I	Integrated services digital network
Series J	Cable networks and transmission of television, sound programme and other multimedia signals
Series K	Protection against interference
Series L	Construction, installation and protection of cables and other elements of outside plant
Series M	Telecommunication management, including TMN and network maintenance
Series N	Maintenance: international sound programme and television transmission circuits
Series O	Specifications of measuring equipment
Series P	Terminals and subjective and objective assessment methods
Series Q	Switching and signalling
Series R	Telegraph transmission
Series S	Telegraph services terminal equipment
Series T	Terminals for telematic services
Series U	Telegraph switching
Series V	Data communication over the telephone network
Series X	Data networks, open system communications and security
Series Y	Global information infrastructure, Internet protocol aspects and next-generation networks
Series Z	Languages and general software aspects for telecommunication systems