



INTERNATIONAL TELECOMMUNICATION UNION

ITU-T

TELECOMMUNICATION
STANDARDIZATION SECTOR
OF ITU

Q.2110

(07/94)

BROADBAND ISDN

**B-ISDN ATM ADAPTATION LAYER –
SERVICE SPECIFIC CONNECTION
ORIENTED PROTOCOL (SSCOP)**

ITU-T Recommendation Q.2110

(Previously “CCITT Recommendation”)

FOREWORD

The ITU-T (Telecommunication Standardization Sector) is a permanent organ of the International Telecommunication Union (ITU). The ITU-T is responsible for studying technical, operating and tariff questions and issuing Recommendations on them with a view to standardizing telecommunications on a worldwide basis..

The World Telecommunication Standardization Conference (WTSC), which meets every four years, establishes the topics for study by the ITU-T Study Groups which, in their turn, produce Recommendations on these topics.

The approval of Recommendations by the Members of the ITU-T is covered by the procedure laid down in WTSC Resolution No. 1 (Helsinki, March 1-12, 1993).

ITU-T Recommendation Q.2110 was prepared by ITU-T Study Group 11 (1993-1996) and was approved under the WTSC Resolution No. 1 procedure on the 29th of July 1994.

NOTE

In this Recommendation, the expression "Administration" is used for conciseness to indicate both a telecommunication administration and a recognized operating agency.

© ITU 1995

All rights reserved. No part of this publication may be reproduced or utilized in any form or by any means, electronic or mechanical, including photocopying and microfilm, without permission in writing from the ITU.

CONTENTS

	<i>Page</i>
1 Scope	1
2 Normative references	1
3 Abbreviations	1
4 General	3
5 Functions of the SSCOP.....	4
6 Elements for layer to layer communication.....	5
6.1 Signals between SSCOP and SSCF, and SSCOP and SSCS layer management.....	5
6.2 State transition diagram for sequences of signals	7
6.3 Signals between SSCOP and CPCS.....	7
7 Protocol elements for peer-to-peer communications.....	9
7.1 SSCOP PDUs	9
7.2 SSCOP PDU formats	11
7.3 States of SSCOP protocol entity	16
7.4 SSCOP state variables	17
7.5 SSCOP PDU parameters.....	18
7.6 SSCOP timers	19
7.7 SSCOP parameters.....	20
7.8 SSCOP credit and flow control.....	21
8 Specification of SSCOP	22
8.1 Overview	22
8.2 SDL diagrams	24
Annex A – Management error indications	78
Annex B – Protocol implementation conformance statement (PICS) proforma to Recommendation Q.2110.....	79
B.1 General.....	79
B.2 Abbreviations and special symbols.....	79
B.3 Instructions for completing the PICS proforma	79
B.4 Global statement of conformance	80
B.5 SSCOP – Q.2110	80
Appendix I – Concepts and terminology	83
Appendix II – Examples of SSCOP operation	85
Appendix III – Summary of buffer and state variable management.....	93
Appendix IV – Default window size for SSCOP	95

SUMMARY

The intent of this Recommendation is to provide a new protocol specification that can be used in the B-ISDN ATM Adaptation Layer (AAL). This protocol, called the Service Specific Connection Oriented Protocol (SSCOP), provides assured data delivery between AAL connection endpoints.

The ATM Adaptation layer (AAL) is defined as enhancing the services provided by the ATM layer to support the functions required by the next higher layer. Different AALs support various protocols to suit the different needs of a range of AAL service users. One particular type of AAL service user is the signalling entity wishing to communicate with a peer entity. The signalling AAL (SAAL) comprises AAL functions necessary to support such a signalling entity. The structure of the SAAL is defined in Recommendation Q.2100.

The SSCOP has been defined to provide functions required in the SAAL. The SAAL is a combination of two sublayers: a common part and a service specific part. The common part protocol is defined in Recommendation I.363. The service specific part is also known as the Service Specific Convergence Sublayer (SSCS). In the SAAL, the SSCS itself is functionally divided into the SSCOP and an Service Specific Coordination Function (SSCF) which maps the services provided by the SSCOP to the needs of the user of the SAAL. This structure allows a common connection oriented protocol with error recovery (the SSCOP) to provide a generic reliable data transfer service for different AAL interfaces defined by the SSCF. Two such SSCFs, one for signalling at the User Network Interface (UNI) and one for signalling at the Network to Network Interface (NNI), have been defined in Recommendations Q.2130 and Q.2140, respectively. It is also possible to define additional SSCFs over the common SSCOP to provide different AAL services.

The SSCOP is a peer-to-peer protocol which provides the following functions:

- transfer of user data with sequence integrity;
- error correction by selective retransmission;
- flow control;
- connection control;
- error reporting to layer management;
- connection maintenance in the prolonged absence of data transfer;
- local data retrieval by the user;
- error detection of protocol control information; and
- status reporting.

This Recommendation describes for SSCOP the necessary elements for layer to layer communication, the elements for peer-to-peer communication, a detailed protocol specification, and examples of SSCOP operation.

Keywords

AAL	ATM Adaptation Layer
ATM	Asynchronous Transfer Mode
B-ISDN	Broadband Integrated Services Network
NNI	Network Node Interface
SAAL	Signalling AAL
SSCF	Service Specific Coordination Function
SSCOP	Service Specific Connection Oriented Protocol
SSCS	Service Specific Convergence Sublayer
UNI	User to Network Interface

B-ISDN ATM ADAPTATION LAYER – SERVICE SPECIFIC CONNECTION ORIENTED PROTOCOL (SSCOP)

(Geneva, 1994)

1 Scope

This Recommendation describes the Service Specific Connection Oriented Protocol (SSCOP). This Recommendation specifies the peer-to-peer protocol for the transfer of information and control between any pair of SSCOP entities, the interactions between the SSCOP and an SSCF, the interactions between the SSCOP and the AAL Common Part, and the interactions between the SSCOP and the AAL management plane. Recommendation Q.2100 [8] describes how this Recommendation is related to the SSCF for signalling at the UNI, Recommendation Q.2130 [9], and to the SSCF for signalling at the NNI, Recommendation Q.2140 [10].

2 Normative references

The following Recommendations and other references contain provisions which, through reference in this text, constitute provisions of this Recommendation. At the time of publication, the editions indicated were valid. All Recommendations and other references are subject to revision: all users of this Recommendation are therefore encouraged to investigate the possibility of applying the most recent edition of the Recommendations and other references listed below. A list of currently valid ITU-T Recommendation is published.

- [1] CCITT Recommendation X.200, *Reference model of open systems interconnection for CCITT applications.*
- [2] CCITT Recommendation X.210, *OSI layer service conventions.*
- [3] ITU-T Recommendation I.150, *B-ISDN Asynchronous Transfer Mode Functional Characteristics.*
- [4] ITU-T Recommendation I.361, *B-ISDN ATM Layer Specification.*
- [5] ITU-T Recommendation Q.2931, *B-ISDN access signalling system DSS2 (Digital Subscriber Signalling System No. 2).*
- [6] ITU-T Recommendation Q.704, *Signalling Network Functions and Messages.*
- [7] ITU-T Recommendation I.363, *B-ISDN ATM Adaptation Layer (AAL) Specification.*
- [8] ITU-T Recommendation Q.2100, *B-ISDN Signalling ATM Adaptation Layer (SAAL) overview description.*
- [9] ITU-T Recommendation Q.2130, *B-ISDN Signalling ATM Adaptation Layer – Service Specific Coordination Function for support of signalling at the user-to-network interface (SSCF at UNI).*
- [10] ITU-T Recommendation Q.2140, *B-ISDN Signalling ATM Adaptation Layer – Service Specific Coordination Function for Signalling at the Network Node Interface (SSCF at NNI).*

3 Abbreviations

AA	ATM Adaptation
AAL	ATM Adaptation Layer
ATM	Asynchronous Transfer Mode

B-ISDN	Broadband Integrated Services Digital Network
BGAK	Begin Acknowledge (PDU)
BGN	Begin (PDU)
BGREJ	Begin Reject (PDU)
BR	Buffer Release
CPCS	Common Part Convergence Sublayer
END	End (PDU)
ENDAK	End Acknowledge (PDU)
ER	Error Recovery (PDU)
ERAK	Error Recovery Acknowledge (PDU)
ID	Interface Data
LM	Layer Management
MAA	Management ATM Adaptation
MaxCC	Maximum Connection Control (Count)
MaxPD	Maximum Poll Data (Count)
MaxSTAT	Maximum STAT (Count)
MD	Management Data (PDU)
MSB	Most Significant Bit
MTP	Message Transfer Part
MU	Message Unit
NNI	Network Node Interface
OSI	Open Systems Interconnection
PAD	Padding
PCI	Protocol Control Information
PD	POLL Data
PDU	Protocol Data Unit
PICS	Protocol Implementation Conformance Statement
PL	Pad Length
POLL	Poll (PDU)
QOS	Quality of Service
R	Reserved (field)
RN	Retrieval Number
RS	Resynchronization (PDU)
RSAK	Resynchronization Acknowledge (PDU)
Rsvd	Reserved (field)
S	Source (field)
SAAL	Signalling ATM Adaptation Layer
SAP	Service Access Point
SAR	Segmentation And Reassembly
SD	Sequenced Data (PDU)
SDL	Specification and Description Language
SDU	Service Data Unit
SN	Sequence Number
SSCF	Service Specific Coordination Function
SSCOP	Service Specific Connection Oriented Protocol
SSCS	Service Specific Convergence Sublayer

STAT	Solicited Status (PDU)
UD	Unnumbered Data (PDU)
UNI	User Network Interface
USTAT	Unsolicited Status (PDU)
UU	User-to-User
VR	Receiver state Variable
VT	Transmitter state Variable

4 General

The Service Specific Connection Oriented Protocol (SSCOP) resides in the Service Specific Convergence Sublayer (SSCS) of the ATM Adaptation Layer (AAL). Figure 1 illustrates the structure of the AAL. SSCOP is used to transfer variable length Service Data Units (SDUs) between users of SSCOP.

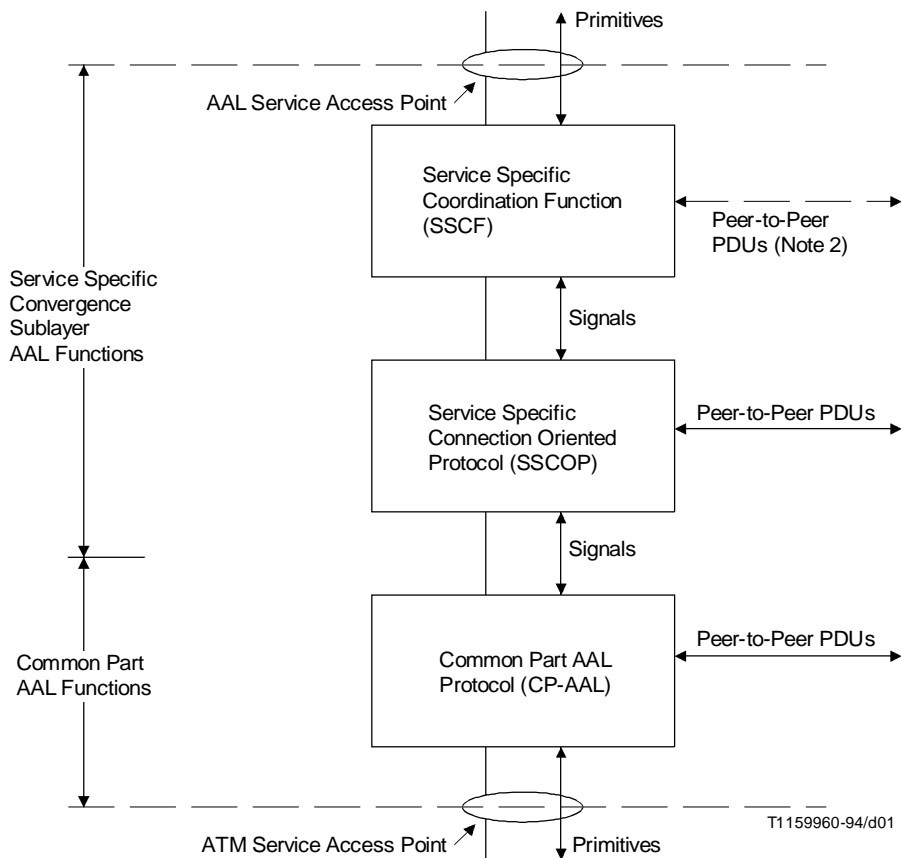

NOTES

- 1 The figure represents the allocation of functions and is not extended to illustrate sub-layers as defined by OSI modeling principles. The Common Part AAL jointly consists of the CPCS and SAR protocols.
- 2 A particular SSCF may include a protocol for the exchange of PDUs.

FIGURE 1/Q.2110
AAL Structure

SSCOP provides its service to a Service Specific Coordination Function (SSCF). The SSCF maps the service of SSCOP to the needs of the AAL user. The SSCFs are specified in other Recommendations. SSCOP utilizes the service of the CPCS (Common Part Convergence Sublayer) and SAR protocols which provide an unassured information transfer and a mechanism for detecting corruption of SSCOP Protocol Data Units (PDUs). The CPCS and SAR protocols are specified in Recommendation I.363 [7].

As shown in Figure 1, the AAL is functionally divided into the common part and the Service Specific Convergence Sublayer (SSCS). The SSCS is specific to the needs of the particular service application and in some cases may be functionally null. The SSCOP can operate over different AAL Common Part Protocols and may be used by different SSCFs; the SSCF is specific to the needs of the service application. The Common Part protocols are specified in Recommendation I.363 [7].

One currently defined use of SSCOP is within the signalling AAL (SAAL). The purpose of the SAAL is to convey information between layer 3 entities across the UNI and NNI using Asynchronous Transfer Mode (ATM) virtual channels. Other uses of SSCOP are for further study.

The definition of the SAAL takes into consideration the principles and terminology of Recommendations X.200 [1] and X.210 [2] – The reference model and layer service conventions for Open Systems Interconnection (OSI).

NOTES

1 The physical layer is currently defined in Recommendations I.150 [3] and I.361 [4]. Layer 3 is defined in Recommendations Q.2931 [5] for the UNI and Recommendation Q.704 [6] for the NNI. References should be made to these Recommendations for the complete definition of the protocols and procedures across the B-ISDN UNI and NNI, respectively.

2 The term “layer 3” is used to indicate the layer above the SAAL, the user of the SAAL services.

This Recommendation specifies:

- a) the peer-to-peer protocol for the transfer of information and control between any pair of SSCOP entities;
- b) the interactions between the SSCOP and an SSCF;
- c) the interactions between the SSCOP and the AAL Common Part;
- d) the interactions between the SSCOP and the AAL management plane.

5 Functions of the SSCOP

The SSCOP performs the following functions.

a) *Sequence Integrity*

This function preserves the order of SSCOP SDUs that were submitted for transfer by SSCOP.

b) *Error Correction by Selective Retransmission*

Through a sequencing mechanism, the receiving SSCOP entity can detect missing SSCOP SDUs. This function corrects sequence errors through retransmission.

c) *Flow Control*

This function allows an SSCOP receiver to control the rate at which the peer SSCOP transmitter entity may send information.

d) *Error Reporting to Layer Management*

This function indicates to layer management errors which have occurred.

e) *Keep Alive*

This function verifies that the two peer SSCOP entities participating in a connection are remaining in a link connection established state even in the case of a prolonged absence of data transfer.

f) *Local Data Retrieval*

This function allows the local SSCOP user to retrieve in-sequence SDUs which have not yet been released by the SSCOP entity.

g) *Connection Control*

This function performs the establishment, release, and resynchronization of an SSCOP connection. It also allows the transmission of variable length user-to-user information without a guarantee of delivery.

h) *Transfer of User-Data*

This function is used for the conveyance of user data between users of the SSCOP. SSCOP supports both assured and unassured data transfer.

i) *Protocol Error Detection and Recovery*

This function detects and recovers from errors in the operation of the protocol.

j) *Status Reporting*

This function allows the transmitter and receiver peer entities to exchange status information.

6 Elements for layer to layer communication

This clause defines the signals and state transition diagram for sequences of signals between SSCOP and the SSCF. The term “signal” is used instead of “primitive” in order to reflect the fact that between SSCF and SSCOP there is no service access point defined.

6.1 Signals between SSCOP and SSCF, and SSCOP and SSCS layer management

The following repertoire of AA-signals between SSCF and SSCOP, and MAA-signals between the SSCS layer management and SSCOP, is defined (see Table 1):

TABLE 1/Q.2110

SSCOP signals and parameters

Generic Name	Type			
	Request	Indication	Response	Confirmation
AA-ESTABLISH	SSCOP-UU BR	SSCOP-UU	SSCOP-UU BR	SSCOP-UU
AA-RELEASE	SSCOP-UU	SSCOP-UU Source	Not Defined	–
AA-DATA	MU	MU SN	Not Defined	Not Defined
AA-RESYNC	SSCOP-UU	SSCOP-UU	–	–
AA-RECOVER	Not Defined	–	–	Not Defined
AA-UNITDATA	MU	MU	Not Defined	Not Defined
AA-RETRIEVE	RN	MU	Not Defined	Not Defined
AA-RETRIEVE COMPLETE	Not Defined	–	Not Defined	Not Defined
MAA-ERROR	Not Defined	Code Count	Not Defined	Not Defined
MAA-UNITDATA	MU	MU	Not Defined	Not Defined
– The signal has no parameters.				

6.1.1 Signal definition

The definition of these signals is as follows:

- a) The **AA-ESTABLISH signals** are used to establish a point-to-point connection for assured information transfer between peer user entities.
- b) The **AA-RELEASE signals** are used to terminate a point-to-point connection for assured information transfer between peer user entities.
- c) The **AA-DATA signals** are used for the assured point-to-point transfer of SDUs between peer user entities.
- d) The **AA-RESYNC signals** are used to resynchronize the SSCOP connection.
- e) The **AA-RECOVER signals** are used during recovery from protocol errors.
- f) The **AA-UNITDATA signals** are used for the non-assured, broadcast and point-to-point, transfer of SDUs between peer user entities.
- g) **AA-RETRIEVE signals** are used to retrieve SDUs submitted by the user for transmission but not yet released by the transmitter.
- h) **AA-RETRIEVE COMPLETE signal** is used to indicate that there are no additional SDUs to be returned to the SSCOP user.
- i) **MAA-ERROR signals** are used to report SSCOP protocol errors and certain events to layer management.
- j) **MAA-UNITDATA signals** are used for the non-assured, broadcast and point-to-point, transfer of SDUs between SSCOP and peer layer management entities.

6.1.2 Parameter definition

Table 1 lists the parameters associated with each SSCOP signal. The definition of the parameters is as follows:

- a) The **message Unit (MU) parameter** is used during information transfer to convey a variable-length message. In AA-DATA.request, AA-UNITDATA.request, and MAA-UNITDATA.request signals, this parameter is mapped transparently into the Information field of an SSCOP PDU. For AA-DATA.indication, AA-UNITDATA.indication, and MAA-UNITDATA.indication signals, this parameter contains the contents of the information field of the received SSCOP PDU. In AA-RETRIEVE.indication signals, this parameter contains a message unit returned to the SSCOP user from either the transmitter queue (data not yet sent) or the transmitter buffer. The MU is an integral multiple of one octet.
- b) The **SSCOP user-to-user information (SSCOP-UU) parameter** is used during connection control to convey a variable-length user-to-user message. The transfer of SSCOP-UU in BGN, BGAK, BGREJ, RS, and END PDUs can not be guaranteed. In request and response signals, this parameter is mapped transparently into the SSCOP-UU (SSCOP User-to-User) field of an SSCOP PDU. For indication and confirm signals, this parameter contains the contents of the SSCOP-UU field of the received SSCOP PDU. The SSCOP-UU is an integral multiple of one octet, if it is present. The SSCOP-UU may be null (no data present).
- c) The **sequence number (SN) parameter** indicates the value of N(S) in the received SD PDU, and may be used to support the data retrieval operation.
- d) The **retrieval number (RN) parameter** is used to support data retrieval. The value RN + 1 indicates the value of the N(S) for the first SD PDU to be retrieved. A value of "Unknown" indicates that only the not yet transmitted SD PDUs are to be retrieved. A value of "Total" indicates that all the SD PDUs in both the transmission buffer and transmission queue are to be retrieved.
- e) The **buffer release (BR) parameter** indicates whether the transmitter may release its buffers upon subsequent release of the connection. This parameter also allows for the release of selectively acknowledged messages from the transmitter buffer. A value of "Yes" indicates that the transmission buffer and transmission queue may be released, and a value of "No" indicates that the transmission buffer and transmission queue may not be released.

- f) The **code parameter** indicates the type of protocol error that occurred. The Code parameters are defined in Annex A.
- g) The **source parameter** indicates to the SSCOP user whether the SSCOP layer or the peer SSCOP user originated the connection release. This parameter assumes one of two values: “SSCOP” or “User”. If “SSCOP” is indicated, the user should disregard the SSCOP-UU parameter, if present.
- h) The **count parameter** indicates the number of SD PDU retransmissions that occurred.

6.2 State transition diagram for sequences of signals

This subclause defines the constraints on the sequences in which the signals may occur. The sequences are related to the states at one point-to-point SSCOP endpoint, between SSCOP and an SSCF.

The possible overall sequences of signals at a point-to-point SSCOP endpoint are defined in the state transition diagram, Figure 2. The model illustrates the behaviour of SSCOP as seen by the SSCF. This model assumes that a request or response signal is never issued at the same time as an indication or confirm signal. The model also assumes that the signals are serviced immediately and in zero time. In the diagram:

- a) the signals AA-UNITDATA request and AA-UNITDATA indication are associated with Unacknowledged Data Transfer and thus permitted in any state – they are not shown;
- b) any other signal which is not shown as resulting in a transition (from one state to the same state, or from one state to a different state) is not permitted in that state;
- c) it is assumed that the signals passed between SSCOP and an SSCF are coordinated so that collisions do not occur;
- d) the Idle state (State 1) reflects the absence of a connection. It is the initial and final state of any sequence, and once it has been re-entered, the connection is released.

6.3 Signals between SSCOP and CPCS

This Recommendation assumes the CPCS message mode of operation without the option “corrupted data delivery”. Use of Streaming Mode is for further study.

The SSCOP makes use of two signals between the SSCOP and CPCS: CPCS-UNITDATA.invoke and CPCS-UNITDATA.signal. SSCOP PDUs submitted for transmission to the peer are placed in the Interface Data (ID) parameter of the CPCS-UNITDATA.invoke. Messages extracted from the Interface Data (ID) parameter of the CPCS-UNITDATA.signal are received SSCOP PDUs from the peer.

Additional parameters of the CPCS-UNITDATA are set as follows:

- CPCS-LP For CPCS-UNITDATA.invoke, CPCS-LP = 0. This parameter is ignored in CPCS-UNITDATA.signal.
- CPCS-CI For CPCS-UNITDATA.invoke, CPCS-CI = 0. The use of this parameter for CPCS-UNITDATA.signal is for further study.
- CPCS-UU This parameter is set to zero by the transmitting entity and is ignored by the receiver.

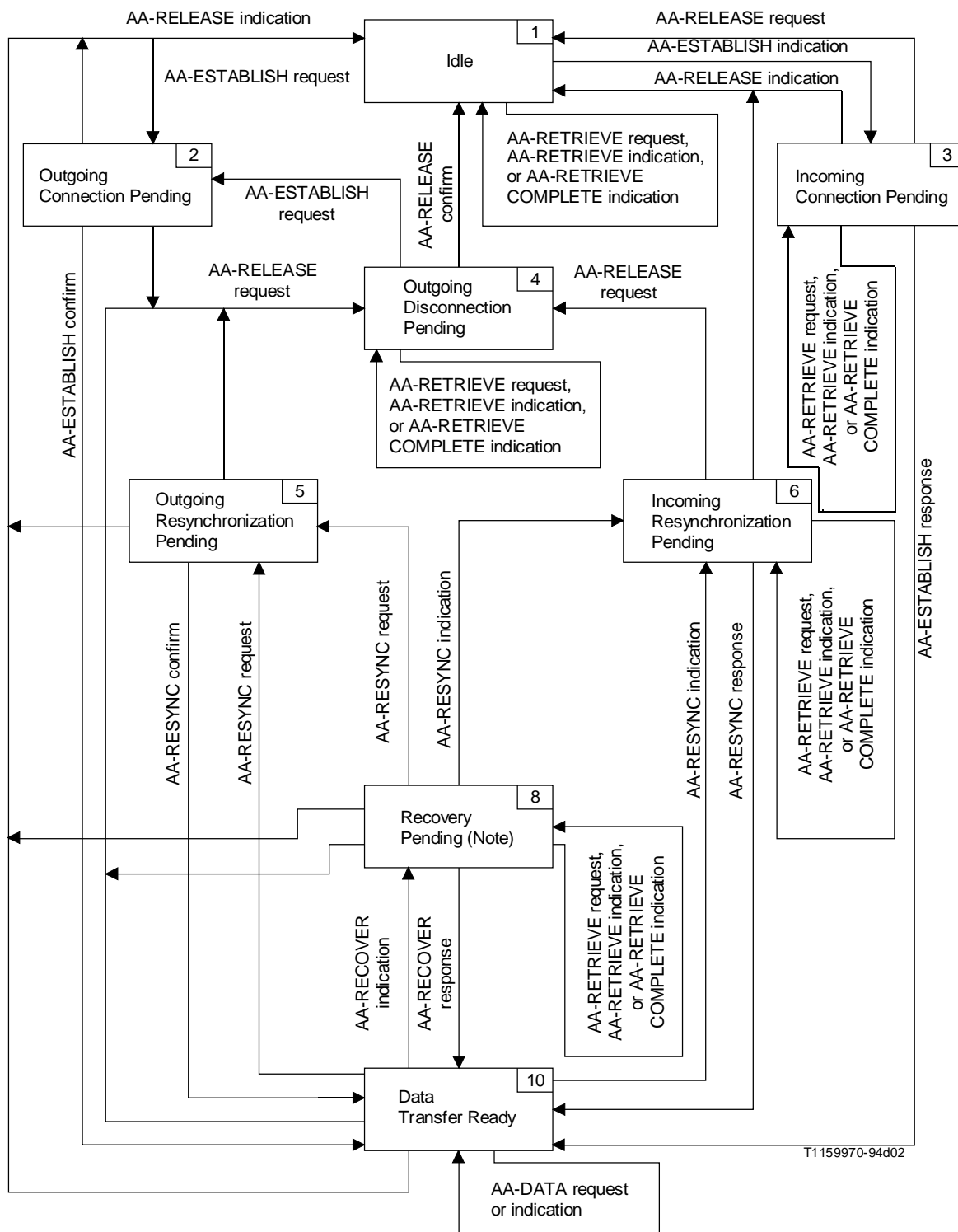

NOTE – The SSCOP connection state Recovery Pending (state 8) covers the SSCOP states Recovery Response Pending (state 8) and Incoming Recovery Pending (state 9). Which of these states applies not visible at the boundary between SSCF and SSCOP. The state Outgoing Recovery Pending (state 7) is never visible at the boundary between SSCF and SSCOP.

FIGURE 2/Q.2110

State transition diagram for sequences of signals between SSCF and SSCOP

7 Protocol elements for peer-to-peer communications

7.1 SSCOP PDUs

The Protocol Data Units (PDUs) are listed and described in Table 2.

TABLE 2/Q.2110

SSCOP PDU names and definitions

Functionality	PDU name	PDU type field	Description
Establishment	BGN	0001	Request Initialization
	BGAK	0010	Request Acknowledgement
	BGREJ	0111	Connection Reject
Release	END	0011	Disconnect Command
	ENDAK	0100	Disconnect Acknowledgement
Resynchronization	RS	0101	Resynchronization Command
	RSAK	0110	Resynchronization Acknowledgement
Recovery	ER	1001	Recovery Command
	ERAK	1111	Recovery Acknowledgement
Assured Data Transfer	SD	1000	Sequenced Connection-mode Data
	POLL	1010	Transmitter State Information with request for Receive State Information
	STAT	1011	Solicited Receiver State Information
	USTAT	1100	Unsolicited Receiver State Information
Unacknowledged Data Transfer	UD	1101	Unnumbered User Data
Management Data Transfer	MD	1110	Unnumbered Management Data

The SSCOP PDU definitions are:

a) BGN PDU (Begin)

The **BGN PDU** is used to establish an SSCOP connection between two peer entities. The BGN PDU requests the clearing of the peer's transmitter and receiver buffers, and the initialization of the peer's transmitter and receiver state variables.

b) BGAK PDU (Begin Acknowledge)

The **BGAK PDU** is used to acknowledge the acceptance of a connection request from the peer.

c) BGREJ PDU (Begin Reject)

The **BGREJ PDU** is used to reject the connection request of the peer SSCOP entity.

d) END PDU (End)

The **END PDU** is used to release an SSCOP connection between two peer entities.

- e) ENDAK PDU (End Acknowledge)

The **ENDAK PDU** is used to confirm the release of an SSCOP connection.

- f) RS PDU (Resynchronization)

The **RS PDU** is used to resynchronize the buffers and data transfer state variables.

- g) RSAK PDU (Resynchronization Acknowledge)

The **RSAK PDU** is used to acknowledge the acceptance of a resynchronization requested by the peer SSCOP entity.

- h) ER PDU (Error Recovery)

The **ER PDU** is used to recover from protocol errors.

- i) ERAK PDU (Error Recovery Acknowledge)

The **ERAK PDU** is used to acknowledge the recovery from protocol error.

- j) SD PDU (Sequenced Data)

The **SD PDU** is used to transfer, across an SSCOP connection, sequentially numbered PDUs containing information fields provided by the SSCOP user.

- k) POLL PDU (Status Request)

The **POLL PDU** is used to request, across an SSCOP connection, status information about the peer SSCOP entity.

- l) STAT PDU (Solicited Status Response)

The **STAT PDU** is used to respond to a status request (POLL PDU) received from a peer SSCOP entity. It contains information regarding the reception status of SD PDUs, credit information for the peer transmitter, and the sequence number [N(PS)] of the POLL PDU to which it is in response.

- m) USTAT PDU (Unsolicited Status Response)

The **USTAT PDU** is used to respond to a detection of one or more new missing SD PDUs, based on the examination of the sequence number of the SD PDU. It contains information regarding the reception status of SD PDUs and credit information for the peer transmitter.

- n) UD PDU (Unnumbered Data)

The **UD PDU** is used for unassured data transfer between two SSCOP users. When an SSCOP user requests unacknowledged information transfer, the UD PDU is used to send information to the peer without affecting SSCOP states or variables. UD PDUs do not carry a sequence number and therefore, the UD PDU may be lost without notification.

- o) MD PDU (Management Data)

The **MD PDU** is used for unassured management data transfer between two management entities. When a management entity requests unacknowledged information transfer, the MD PDU is used to send information to the peer management entity without affecting SSCOP states or variables. MD PDUs do not carry a sequence number and therefore, the MD PDU may be lost without notification.

An **invalid PDU** is a PDU which:

- a) has an unknown PDU type code, or
- b) is not 32 bit aligned, or
- c) is not the proper length for a PDU of the stated type.

Invalid PDUs shall be discarded without notification to the sender. No additional action is taken as a result of that PDU (length violations from items b) and c) above are reported to layer management).

7.2 SSCOP PDU formats

Figure 3 through Figure 16 illustrate the formats of the SSCOP PDUs. There are 15 defined PDU types listed in 7.1. SSCOP PDU fields are defined in section 7.5.

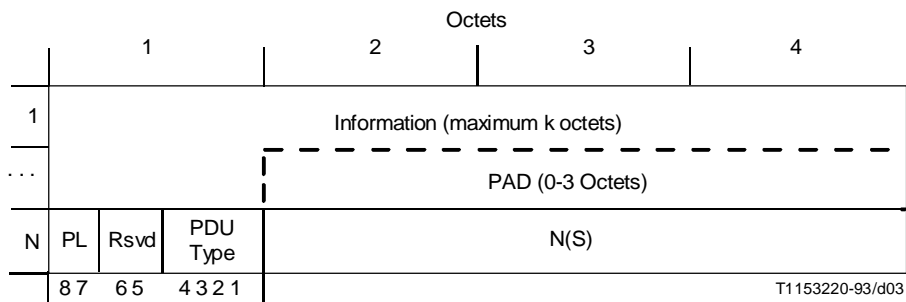

FIGURE 3/Q.2110
Sequenced Data PDU (SD PDU)

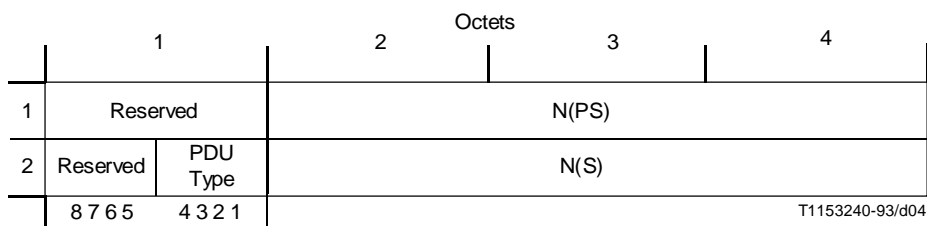

FIGURE 4/Q.2110
Poll PDU (POLL PDU)

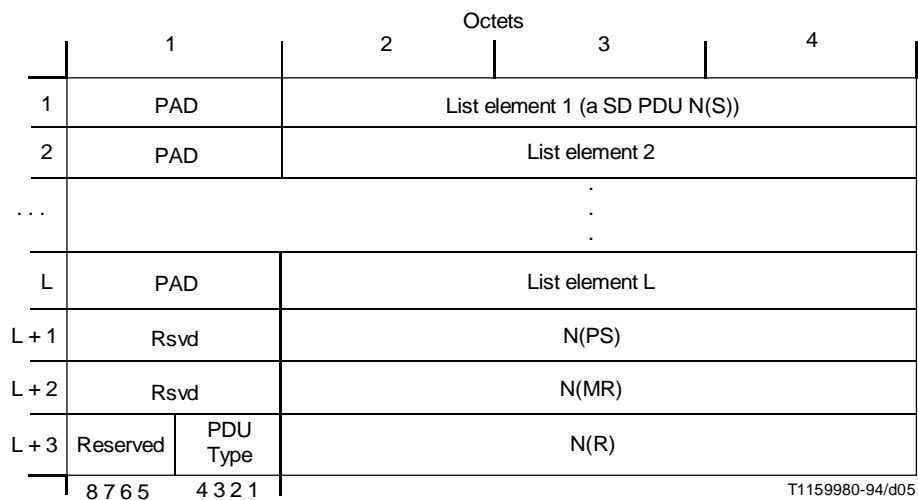

FIGURE 5/Q.2110
Solicited status PDU (STAT PDU)

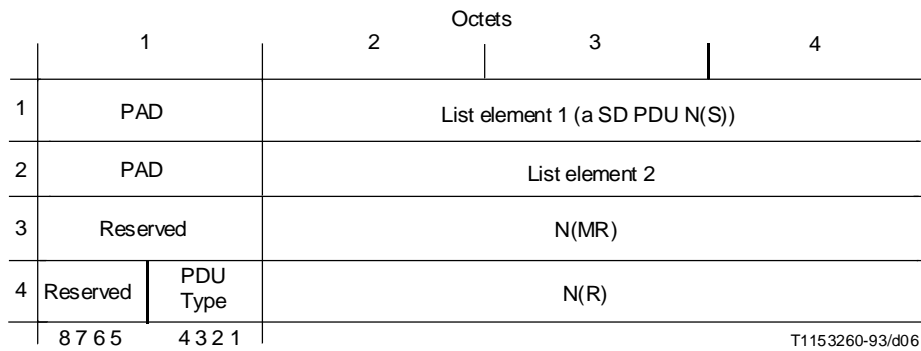

FIGURE 6/Q.2110
Unsolicited Status PDU (USTAT PDU)

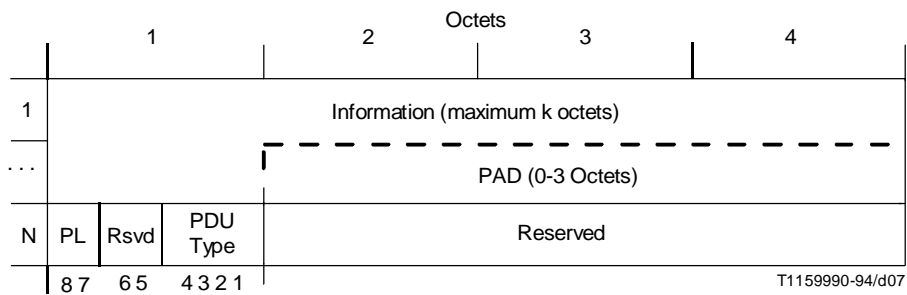

FIGURE 7/Q.2110
Unit data PDU (UD PDU) Management data PDU (MD PDU)

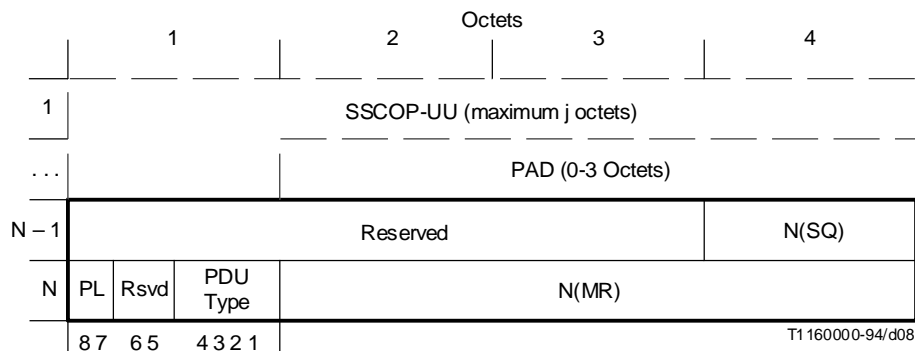

FIGURE 8/Q.2110
Begin PDU (BGN PDU)

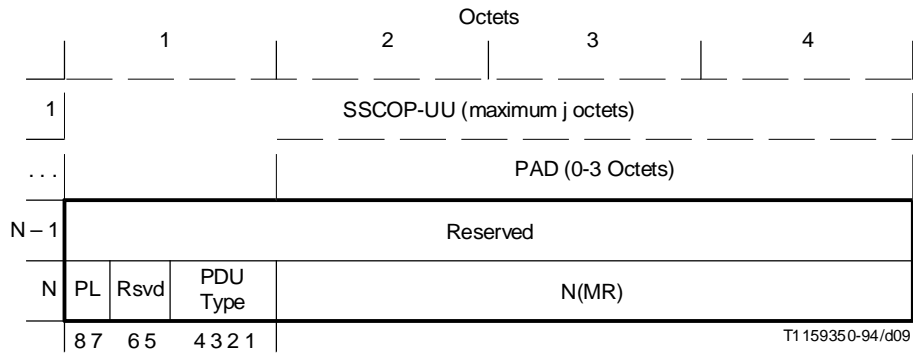

FIGURE 9/Q.2110
Begin acknowledge PDU (BGAK PDU)

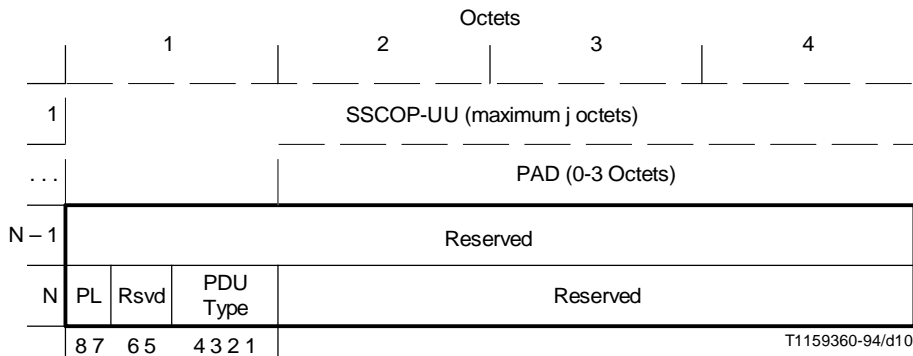

FIGURE 10/Q.2110
Begin reject PDU (BGREJ PDU)

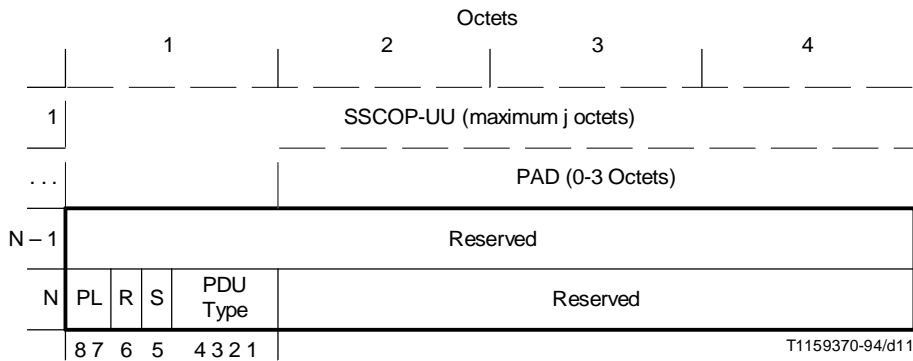

FIGURE 11/Q.2110
End PDU (END PDU)

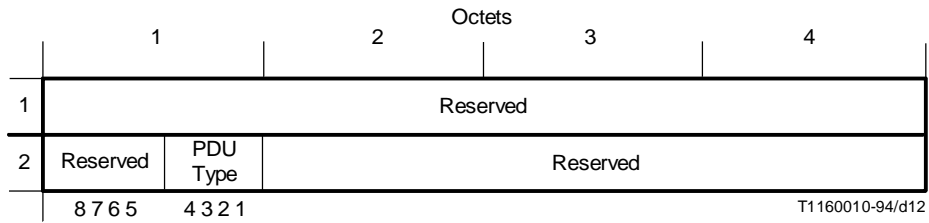

FIGURE 12/Q.2110
End acknowledge PDU (ENDAK PDU)

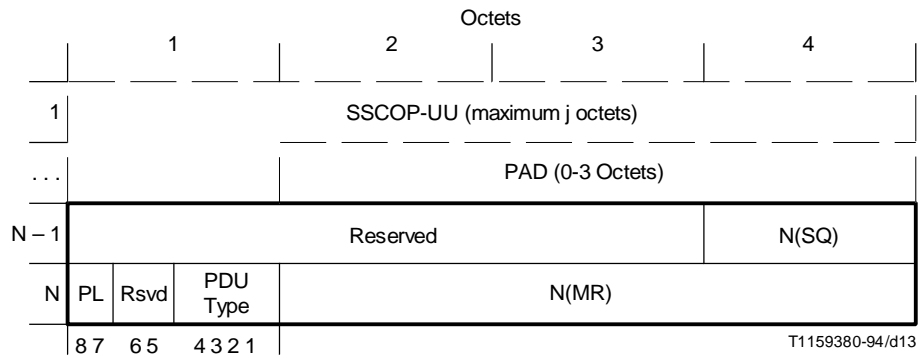

FIGURE 13/Q.2110
Resynchronization PDU (RS PDU)

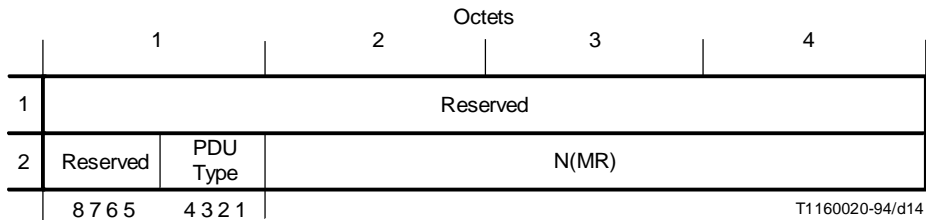

FIGURE 14/Q.2110
Resynchronization acknowledge PDU (RSAK PDU)

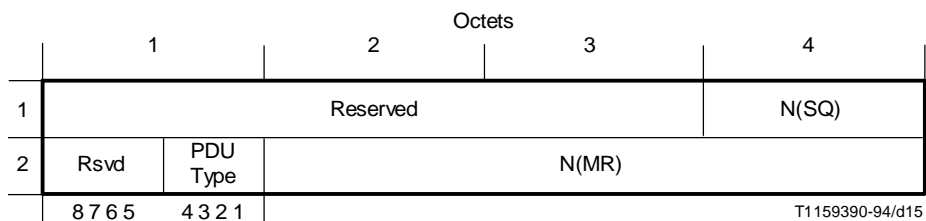

FIGURE 15/Q.2110
Error recovery PDU (ER PDU)

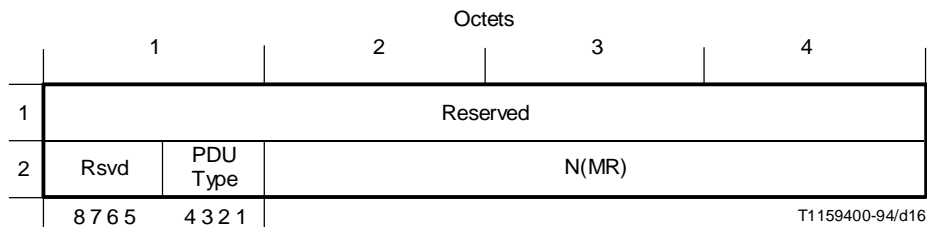

FIGURE 16/Q.2110
Error recovery acknowledge PDU (ERAK PDU)

The following features of these formats are noted.

7.2.1 Coding conventions

The coding of the SSCOP PDU conforms to the coding conventions specified in 2.1/I.361 [4].

NOTE – SSCOP is trailer oriented; i.e. the protocol control information is transmitted last.

7.2.2 Padding (PAD) field

a) *SD, MD, and UD PDUs*

Between the end of the SD, MD, or UD PDU information field and the trailer, there will be from 0 to 3 unused octets. These unused octets are called the Padding (PAD) field; they are strictly used as filler octets and do not convey any information. Any coding is acceptable. This padding field complements the PDU to an integral number of 4 octets.

The Pad Length (PL) field in each PDU indicates the number of PAD octets present in the PDU. It can take on any integer value from 0 to 3.

b) *BGN, BGAK, BGREJ, END, and RS PDUs*

The SSCOP may convey a variable length User-to-User information field (SSCOP-UU) in a BGN, BGAK, BGREJ, END, or RS PDU. If this field is present in a PDU, it is padded with 0 to 3 filler octets in order to complement the PDU length to an integral multiple of 4 octets. These unused octets are called the Padding (PAD) field; they are strictly used as filler octets and do not convey any information. Any coding is acceptable.

The Pad Length (PL) field in each PDU indicates the number of PAD octets present in the PDU. It can take on any integer value from 0 to 3. If no SSCOP-UU field is present in the PDU, the PL field is coded as zero.

c) *STAT and USTAT PDUs*

In any STAT or USTAT PDU containing list elements, a one octet PAD field precedes the 3 octet sequence number. These unused PAD octets are used to complement each list element field to four octets in length and do not convey any information. Any coding is acceptable.

7.2.3 Reserved field

There is a field of reserved bits (R, Rsvd, Reserved) in each PDU. One function of the reserved field is to achieve 32 bit alignment. Other functions are for further study. Where no functions other than 32 bit alignment are defined, this field shall be coded as zero. This field shall be ignored by the receiver.

7.2.4 PDU length

The maximum length of the information field in SD, UD, and MD PDUs is k octets. The maximum value of k is 65 528 octets. The value of k is established as part of size negotiation procedures outside SSCOP, upon bilateral agreement, may be specified by an SSCF Recommendation utilizing SSCOP, or may be derived from the maximum length PDU size for protocols using SSCOP. The minimum value of k is 0 octets.

The maximum length of a variable length SSCOP-UU field is j octets. The maximum value of j is 65 524 octets. The value of j is established upon bilateral agreement, may be specified by an SSCF Recommendation utilizing SSCOP, or may be derived from requirements of protocols utilizing SSCOP. The minimum value of j is 0 octets.

7.2.5 STAT and USTAT PDU codings

USTAT PDUs contain two list elements. STAT PDUs contain zero or more list elements. Transmitted STAT messages may be segmented into more than one STAT PDU.

The processing of a STAT PDU does not rely on information in other STAT PDUs. This is true even for the case when multiple STAT PDUs are generated in response to a single POLL PDU, and one or more of these STAT PDUs is lost.

The span list items in the STAT and USTAT PDUs are odd or even elements of a list used for selective retransmission requests. Every odd element represents the first PDU of a missing gap, and every even element represents the first PDU of a received sequence, except possibly the last one. Appendix II provides examples on how to code the span lists.

7.3 States of SSCOP protocol entity

This subclause describes the states of an SSCOP entity. These states are used in the specification of the peer-to-peer protocol. The states are conceptual and reflect general conditions of the SSCOP entity in the sequences of signals and PDU exchanges with its user and peer, respectively. In addition, other conditions are used in the description, in order to avoid identification of additional states, as detailed in the SDLs. The basic states are:

- *State 1 – Idle*

Each SSCOP entity is conceptually initiated in the Idle state (State 1) and returns to this state upon the release of a connection.

- *State 2 – Outgoing Connection Pending*

An SSCOP entity requesting a connection with its peer is in the Outgoing Connection Pending state (State 2) until it receives acknowledgement from its peer.

- *State 3 – Incoming Connection Pending*

An SSCOP entity that has received a connection request from its peer and is waiting for its user's response is in the Incoming Connection Pending state (State 3).

- *State 4 – Outgoing Disconnection Pending*

An SSCOP entity requesting release of the peer-to-peer connection goes to the Outgoing Disconnection Pending state (State 4) until it receives confirmation that the peer entity has released and transitioned to the Idle state (State 1), after which it does the same.

- *State 5 – Outgoing Resynchronization Pending*

An SSCOP entity requesting resynchronization of the connection with its peer is in the Outgoing Resynchronization Pending state (State 5).

- *State 6 – Incoming Resynchronization Pending*

An SSCOP entity that has received a resynchronization request from its peer and is waiting for its user's response is in the Incoming Resynchronization Pending state (State 6).

- *State 7 – Outgoing Recovery Pending*

An SSCOP entity requesting recovery with its peer of an existing connection is in the Outgoing Recovery Pending state (State 7).

– *State 8 – Recovery Response Pending*

An SSCOP entity which has completed recovery, notified its user, and is awaiting response is in the Recovery Response Pending state (State 8).

– *State 9 – Incoming Recovery Pending*

An SSCOP entity that has received a recovery request from its peer and is waiting for its user's response is in the Incoming Recovery Pending state (State 9).

– *State 10 – Data Transfer Ready*

Upon successful completion of the connection establishment, resynchronization, or error recovery procedures, both peer SSCOP entities will be in Data Transfer Ready state (State 10) and assured data transfer can take place.

7.4 SSCOP state variables

This subclause describes the state variables used in the specification of the peer-to-peer protocol.

SD and POLL PDUs are sequentially and independently numbered and may have the value 0 through n minus 1 (where n is the modulus of the sequence numbers). The modulus equals 2^{24} and the sequence numbers cycle through the entire range, 0 through $2^{24} - 1$. All arithmetic operations on the following state variables and sequence numbers contained in this Recommendation are affected by the modulus: VT(S), VT(PS), VT(A), VT(PA), VT(MS), VR(R), VR(H), and VR(MR). When performing arithmetic comparisons of transmitter variables, VT(A) is assumed to be the base. When performing arithmetic comparisons of receiver variables, VR(R) is assumed to be the base. In addition, the state variables VT(SQ) and VR(SQ) use modulo 256 arithmetic. The SSCOP maintains the following state variables at the transmitter.

a) VT(S) – Send state variable

The sequence number of the next SD PDU to be transmitted for the first time (i.e. excluding retransmissions). Incremented after transmission of a SD PDU for the first time (i.e. excluding retransmissions).

b) VT(PS) – Poll Send state variable

The current value of the poll sequence number. Incremented before transmission of the next POLL PDU.

c) VT(A) – Acknowledge state variable

The sequence number of the next in-sequence SD PDU expected to be acknowledged, which forms the lower edge of the window of acceptable acknowledgements. VT(A) is updated upon acknowledgement of in-sequence SD PDUs.

d) VT(PA) – Poll acknowledge state variable

The poll sequence number of the next STAT PDU expected to be received, which forms the lower edge of the acceptable N(PS) window for STAT PDUs. If a STAT PDU is received containing an invalid N(PS), a recovery is initiated or release is performed. If a STAT PDU is accepted, VT(PA) is set to STAT.N(PS).

e) VT(MS) – Maximum Send state variable

The sequence number of the first SD PDU not allowed by the peer receiver [i.e. the receiver will allow up to $VT(MS) - 1$]. This value represents the upper edge of the transmit window. The transmitter shall not transmit a new SD PDU if $VT(S) \geq VT(MS)$. VT(MS) is updated based on receipt of a USTAT PDU, STAT PDU, BGN PDU, BGAk PDU, RS PDU, RSAk PDU, ER PDU, or ERAk PDU.

f) VT(PD) – Poll Data state variable

When acknowledgements are outstanding, this state variable represents the number of SD PDUs transmitted between transmission of a POLL PDU, or the number of SD PDUs transmitted before the transmission of the first POLL PDU after Timer_POLL became active. VT(PD) is incremented upon transmission of an SD PDU, and reset to zero upon transmission of a POLL PDU.

- g) VT(CC) – Connection Control state variable

The number of unacknowledged BGN, END, ER, or RS PDUs. VT(CC) is incremented upon transmission of a BGN, END, ER, or RS PDU. If an END PDU is transmitted in response to a protocol error, SSCOP does not wait for an ENDAK PDU [i.e. SSCOP moves directly to state 1 (Idle)] and VT(CC) is not incremented.

- h) VT(SQ) – Transmitter Connection Sequence state variable

This state variable is used to allow the receiver to identify retransmitted BGN, ER, and RS PDUs. This state variable is initialized to 0 upon creation of the SSCOP process and incremented and then mapped into the N(SQ) field before the initial transmission of either a BGN, RS, or ER PDU.

The SSCOP maintains the following state variables at the receiver:

- a) VR(R) – Receive state variable

The sequence number of the next in-sequence SD PDU expected to be received. Incremented upon receipt of the next in-sequence SD PDU.

- b) VR(H) – Highest expected state variable

The sequence number of the next highest expected SD PDU. Updated in two ways:

- 1) reception of a new SD PDU; and
- 2) reception of a POLL PDU.

- c) VR(MR) – Maximum acceptable Receive state variable

The sequence number of the first SD PDU not allowed by the receiver [i.e. the receiver will allow up to $VR(MR) - 1$]. The receiver shall discard SD PDUs with $N(S) \geq VR(MR)$, (in one case, such an SD PDU may cause the transmission of a USTAT). Updating VR(MR) is implementation dependent, but VR(MR) should not be set to a value $< VR(H)$. An example of how VR(MR) may be determined is included in Appendix IV.

- d) VR(SQ) – Receiver Connection Sequence state variable

This state variable is used to identify retransmitted BGN, ER, and RS PDUs. Upon reception of a BGN, ER, or RS PDU, this state variable is compared to the value of N(SQ) and then assigned the value of N(SQ). If the values are different, the PDU is processed and VR(SQ) is set to N(SQ). If they are equal, the PDU is identified as a retransmission.

7.5 SSCOP PDU parameters

- a) $N(S)$

VT(S) is mapped to N(S) whenever a new SD or POLL PDU is generated.

- b) *Information field*

The information field of an SD, MD, or UD PDU is mapped from the “Message unit” parameter of an AA-DATA, MAA-UNITDATA, or AA-UNITDATA request, respectively. It is mapped to a “Message unit” parameter of an AA-DATA, MAA-UNITDATA, or AA-UNITDATA indication, respectively.

- c) $N(PS)$

VT(PS) (after VT(PS) has been incremented) is mapped to N(PS) whenever a POLL PDU is generated. The receiver of a POLL PDU maps the received POLL.N(PS) into the field STAT.N(PS). In addition, to facilitate error recovery procedures, the current value of VT(PS) is mapped into N(PS) and stored in the transmitter buffer with the corresponding SD PDU whenever a SD PDU is sent.

- d) $N(R)$

VR(R) is mapped to N(R) whenever a STAT or USTAT PDU is generated.

- e) $N(MR)$

VR(MR) is mapped to N(MR) whenever a STAT, USTAT, RS, RSAK, ER, ERAK, BGN, or BGAk PDU is generated. This is the basis for credit granting by the receiver.

f) *SSCOP-UU*

The SSCOP-UU in a BGN, BGAK, BGREJ, END or RS PDU is mapped to and from the “SSCOP-UU” parameter of the corresponding SSCOP signal.

g) *Source (S) bit*

In an END PDU this bit conveys whether the originator of the release was the SSCOP or the SSCOP user. When the transmission of an END PDU is stimulated by the user, this bit is set to 0. When the transmission of an END PDU is stimulated by the SSCOP, this bit is set to 1. This bit is mapped into the “Source” field of an AA-RELEASE.indication.

h) *N(SQ)*

This field carries the connection sequence value. VT(SQ) is mapped to N(SQ) whenever a new BGN, RS, or ER PDU is transmitted. This field is used by the receiver together with VR(SQ) to identify retransmitted BGN, RS, and ER PDUs.

i) *PDU Type field*

The type field codings are listed in Table 2.

7.6 SSCOP timers

With the timers, an SSCOP connection is partitioned into phases.

a) *The active phase*

In this phase, a Timer_POLL is running to assure that the peer receiver is polled often enough (via POLL PDUs) to return its status (STAT PDU); this in turn is needed for advancing the credit window and efficient recovery from transmission errors.

The SSCOP transmitter is always in the active phase if there are SD PDUs to be transmitted or if there are any acknowledgements outstanding.

The POLL and STAT PDUs are subject to transmission errors. SSCOP provides for an uninterrupted flow of information by not insisting on a reply to every POLL PDU. In order to detect a broken connection, a Timer_NO RESPONSE is running parallel to Timer_POLL; this timer indicates the maximum time interval during which at least one STAT PDU needs to be received. Failing this, the SSCOP connection is aborted.

Timer_POLL is optimized to maintain the flow of information and may be shorter or longer than the round-trip delay. Timer_NO-RESPONSE must be at least the sum of Timer_KEEP-ALIVE and one round-trip delay.

b) *The transient phase*

When Timer_POLL expires (and the POLL PDU has been sent) and there are no outstanding acknowledgements or new data pending receipt of credit, the transient phase is entered. Instead of Timer_POLL the Timer_KEEP-ALIVE is started. Also in this phase, POLL or STAT PDUs may be lost. Such loss is protected by Timer_NO RESPONSE determining the maximum time interval during which at least one STAT PDU needs to be received.

The transient phase reverts back to the active phase whenever a new SD PDU is transmitted or if at expiry of Timer_KEEP-ALIVE, new data is pending receipt of credit.

The Timer_KEEP-ALIVE is generally greater than Timer_POLL and greater than a round-trip delay; POLL PDUs are transmitted less often.

c) *The idle phase*

When upon receipt of a STAT PDU the Timer_KEEP-ALIVE is still running, both Timer_KEEP-ALIVE and Timer_NO RESPONSE are stopped and Timer_IDLE is started. In this phase, no POLL PDUs are sent. At the expiry of Timer_IDLE, the transient phase is entered again.

NOTES

1 Timer_KEEP-ALIVE only expires when a POLL or STAT PDU is lost due to transmission errors.

2 The absolute maximum tolerated interval between reception of STAT PDUs is the sum of Timer_IDLE and Timer_NO RESPONSE.

The idle phase reverts back to the active phase whenever a new SD PDU is transmitted or whenever new data is pending receipt of credit.

Timer_IDLE may be considerably greater than Timer_KEEP-ALIVE.

d) *Connection control phase*

During establishment and release of a connection and during resynchronization or recovery, transmission of PDUs is protected by the Timer_CC. It determines the time between transmission of BGN, END, RS, and ER PDUs as long as an acknowledgement to these PDUs has not been received.

At entry into the Data Transfer state, the active phase is entered.

Timer_CC should be somewhat greater than a round-trip delay.

The values of the SSCOP protocol timers are application specific and may be defined in the appropriate SSCF Recommendation which references this Recommendation. The tolerance of protocol timers is not addressed in this Recommendation. These timers should be configurable for different operational environments (e.g. signalling vs. data transfer environments, or environments including satellite links).

7.7 SSCOP parameters

The value of each SSCOP protocol parameter is application specific and may be defined in the appropriate SSCF Recommendation which references this Recommendation.

a) *MaxCC*

Maximum value for the state variable VT(CC), corresponding to the maximum number of transmissions of a BGN, END, ER, or RS PDU.

b) *MaxPD*

Maximum acceptable value for the state variable VT(PD) before sending a POLL PDU and resetting VT(PD) to zero. This parameter is an upper limit for counter VT(PD) that sends a POLL PDU after every (MaxPD) SD PDUs.

c) *MaxSTAT*

Maximum number of list elements placed in a STAT PDU. When the number of list items exceeds MaxSTAT, the STAT message shall be segmented. All of the PDUs carrying the segmented STAT message, except possibly the last one, contain MaxSTAT list items. This parameter is not used by the receiver of a STAT PDU for length checking, but is only used by the sender of the STAT message for segmentation purposes. This parameter should be an odd integer greater than or equal to 3.

The default value of MaxSTAT is 67. This parameter can be changed on an implementation basis.

NOTE – The default value causes the STAT PDU to fill 6 ATM cells using AAL type 5 common part. In addition, the total length of a STAT PDU should not exceed the maximum length of an SD PDU.

d) *Clear-buffers*

This parameter is set upon connection establishment. It holds one of two values: “Yes” or “No”. If this parameter is set to “Yes”, SSCOP can release its transmission buffer and transmission queue upon connection release. If this parameter is set to “No”, SSCOP can not release its transmission buffer and transmission queue upon connection release. Additionally, if this parameter is set to No, SSCOP cannot release selectively acknowledged messages from its transmission buffer if older ones are still outstanding.

e) *Credit*

This parameter is used to coordinate credit notifications to layer management. When SSCOP is blocked from transmitting a new SD PDU due to insufficient credit, “Credit” is assigned the value “No”. When SSCOP is permitted to transmit a new SD PDU, “Credit” is assigned the value of “Yes”. Credit is initially assigned “Yes”.

7.8 SSCOP credit and flow control

7.8.1 Credit and peer-to-peer flow control

Credit is granted by the SSCOP receiver to allow the peer SSCOP transmitter to transmit new SD PDUs. The process by which a receiver entity determines credit is not subject to standardization, but is related to the buffer availability and the bandwidth/delay of the connection. The credit value is conveyed to the transmitter in the N(MR) field of each BGN, BGAK, RS, RSAK, ER, ERAK, STAT and USTAT PDU sent by the receiver. N(MR) is mapped to the variable VT(MS) at the transmitter. The credit value sent to the transmitter is the sequence number of the first SD PDU that the receiver will not accept. The transmitter does not transmit any SD PDUs that exceed the credit allowed. The receiver discards any SD PDUs that exceed the credit allowed, (in one case, such an SD PDU may cause the transmission of a USTAT PDU).

Previously granted credit can be reduced in order for the receiver to perform flow control, but the receiver credit variable VR(MR) cannot be reduced below the value VR(H). In other words, if a receiver has accepted and acknowledged the receipt of the SD PDU numbered VR(H) – 1, the credit value VR(MR) must be greater than or equal to VR(H).

The operating window of the protocols at the transmitter is lower bounded by VT(A) and upper bounded by the credit available [VT(MS) – 1]. The modulus of the protocol limits the operating window to $2^{24} - 1$. Therefore, at the receiver, the credit granted, using modulo arithmetic, must be a value between VR(H) and VR(R) – 1. If VR(MR) = VR(R) = VR(H), the operating window is zero. If VR(MR) = VR(R) – 1, the operating window is maximum.

The SSCOP receiver allocates a buffer to support each connection. In principle, the receiver buffer available should match or exceed the credit granted to the transmitter, to avoid the discard of successfully transmitted data. However, if limited buffers are available for a connection, it is possible to grant credit in excess of the available buffer capacity. This method may obtain a higher throughput than can be achieved by limiting the credit to the available buffer, with the possibility that data may need to be discarded if errors occur. The receiver cannot discard previously received and acknowledged, but not yet delivered, SD PDUs. The receiver must also allocate sufficient buffer capacity to receive and deliver the SD PDU numbered VR(R), at all times unless VR(R) = VR(H) = VR(MR). The granting of credit in excess of buffer capacity should only be performed if limited buffers to support the connection are available and if the SSCOP receiver can still maintain the quality of service (QoS) required for the connection through this method.

7.8.2 Local flow control

SSCOP events, such as reception of PDUs and external and internal signals, are normally processed in the order in which they occurred. However, events pertaining to the exchange of SSCOP connection status information have priority over data transfer.

An implementation may detect congestion (for example, a long queuing delay) in its lower protocol layers. If so, data transfer should be temporarily suspended in order to give priority to connection control messages. The means by which an SSCOP entity decides whether or not it is congested depends on the protocol environment, including protocol timer values, and is not subject to standardization.

If an SSCOP entity detects local congestion (“lower layer busy” in the SDL specification), it can elect to suspend the servicing of AA-DATA.request signals, AA-UNITDATA.request signals, and MAA-UNITDATA.request signals. It can also suspend the retransmission of requested SD PDUs. The data transfer procedures allow this to occur without causing protocol errors.

Therefore, in terms of transmitting PDUs to the peer receiver, all types of PDUs except SD PDU, MD PDU, and UD PDU are given highest priority. The SD PDUs, MD PDUs, and UD PDUs have equal priority. Among the SD PDUs, retransmissions have priority over new transmission if both types are pending. These priorities are only internal to SSCOP.

The SSCOP's local flow control at its user's interface is implementation dependent.

8 Specification of SSCOP

This clause provides a set of SDL diagrams defining the procedures of the Service Specific Connection Oriented Protocol. These SDL diagrams are the definitive description of the procedures and in case of conflict with the text, the SDL diagrams take precedence.

8.1 Overview

Figure 17 gives an overview over the states of SSCOP and the major transitions between them. The states allow SSCOP a number of connection control services and their relation.

8.1.1 Idle

In this state (State 1: Idle), no connection is established. Only unassured and management data may be communicated.

8.1.2 Establishment and release

The states in this connection control service assist SSCOP in establishing and releasing connections for the assured data transfer service. Establishment and release takes precedence over all of the other connection control services (resynchronization and recovery). The following states are defined:

- *State 2 – Outgoing Connection Pending*

In this state, the local SSCOP instructed SSCOP to establish a new connection with its peer and awaits the peer's response.

- *State 3 – Incoming Connection Pending*

In this state, SSCOP received the indication that its peer wants to establish a new connection and has notified the SSCOP. It is awaiting the response of the SSCOP.

- *State 4 – Outgoing Disconnection Pending*

In this state, the SSCOP has instructed the SSCOP to, or the SSCOP itself has initiated, release the current connection. It awaits confirmation from its peer.

8.1.3 Bidirectional resynchronization

The states in this connection control service assist the SSCOP in a resynchronization of both data transfer directions. The bidirectional resynchronization takes precedence over the recovery service. The following states are defined:

- *State 5 – Outgoing Resynchronization Pending*

In this state, the local SSCOP initiated a resynchronization. SSCOP's peer has been informed and its response is awaited.

- *State 6 – Incoming Resynchronization Pending*

In this state, the peer SSCOP has requested a resynchronization. The SSCOP has been notified and its response is awaited.

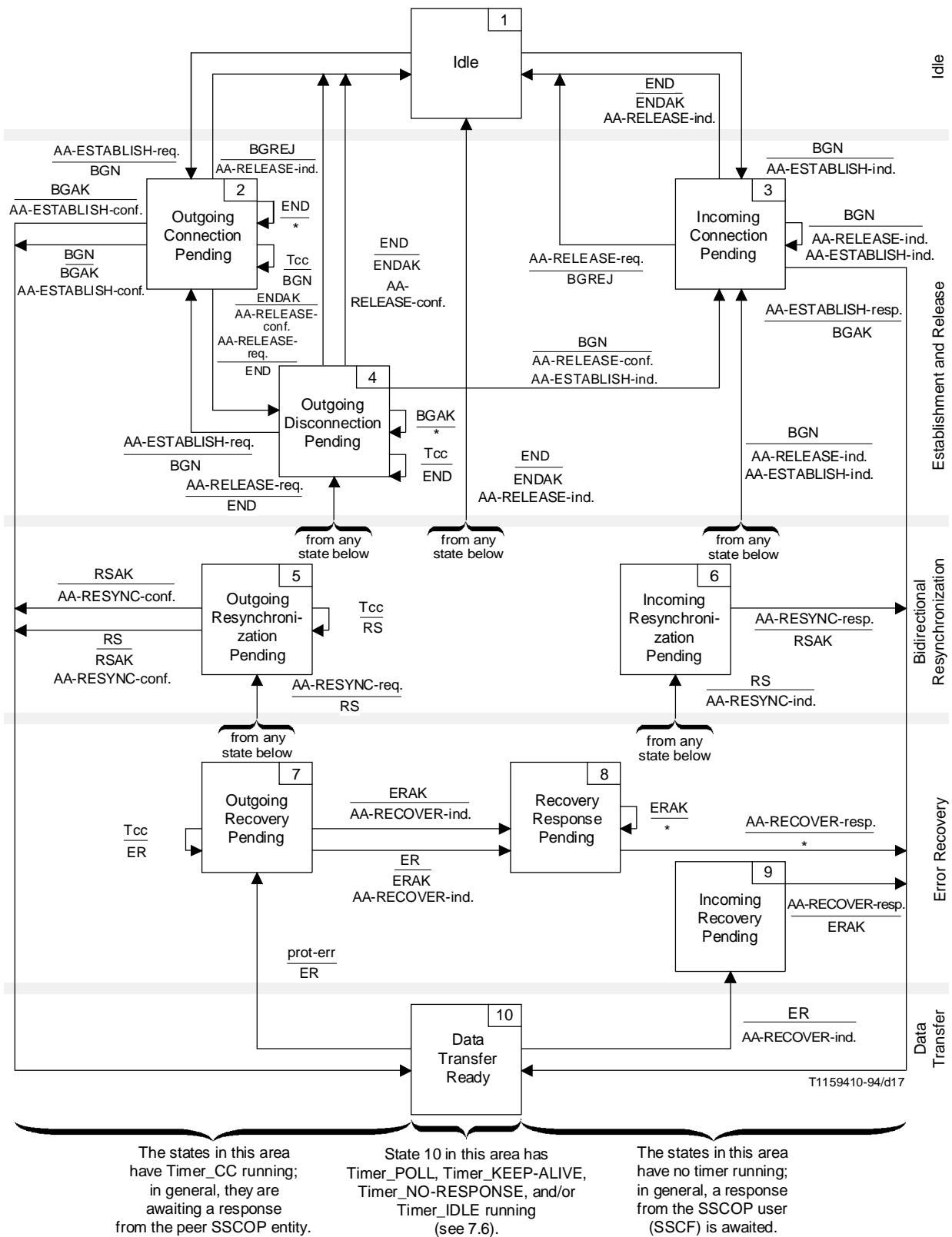

FIGURE 17/Q.2110
Overview of SSCOP states and major transactions between states

8.1.4 Recovery

The states in this connection control service assist SSCOP in recovering from protocol errors relating to the assured data transfer (sequence number problems). The following states are defined:

- *State 7 – Outgoing Recovery Pending*

In this state, the SSCOP has detected a sequence number problem and has instructed its peer to recover. The confirmation from its peer is awaited.

- *State 8 – Recovery Response Pending*

In this state, the SSCOP that detected the sequence number problem received the confirmation from its peer, informed its SSCF and is awaiting the response from its SSCF.

- *State 9 – Incoming Recovery Pending*

In this state, the peer SSCOP detected a sequence number problem and informed this SSCOP who in turn informed its SSCF. The response of the SSCF is awaited.

8.1.5 Data transfer

This state permits assured data transfer. Connection establishment, release, resynchronization, and recovery procedures will take the state machine out of this state.

- *State 10 – Data Transfer Ready*

In this state, assured data transfer takes place.

8.2 SDL diagrams

The SDL diagrams are represented in Figures 18 to 20. An equivalent software version of the SDLs has been produced using the SDT tool for SDL. This version may be purchased for verification purposes and is available in electronic form only from the ITU. If the alternate version conflicts with this Recommendation, this Recommendation takes precedence.

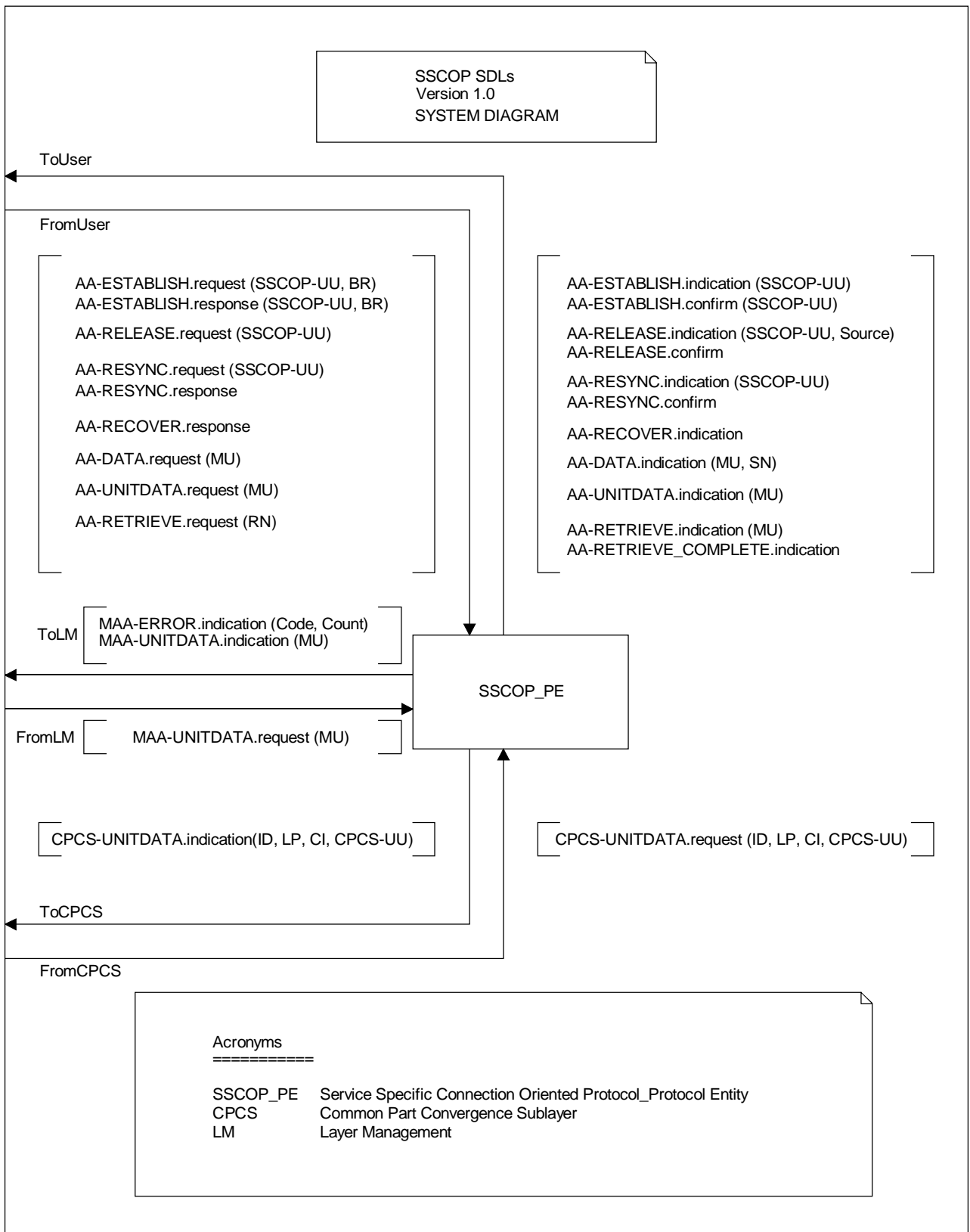

T1159430-94/d18

FIGURE 18
System SSCOP

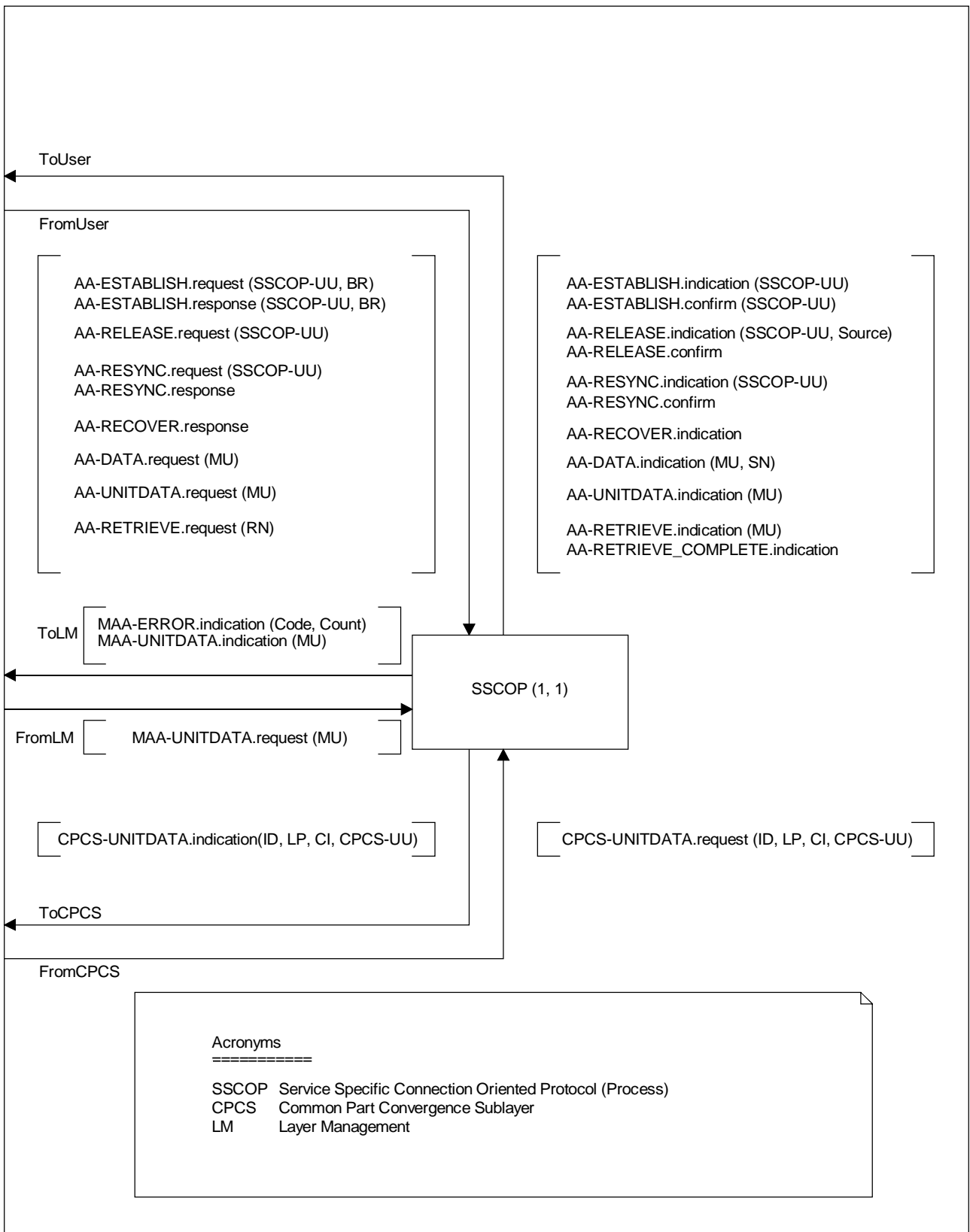

T1159440-94/d19

FIGURE 19
Block SSCOP

Messages to/from SSCOP (defined in 7.1; messages are placed in the ID parameter of CPCS-UNITDATA.invoke/signal)

=====
BGAK, BGN, BGREJ, END, ENDAK, ER, ERAK,
MD, POLL, SD, STAT, RS, RSAK, UD, USTAT

Signals to/from User (defined in 6.1; parameters are listed between parentheses)

=====
AA-ESTABLISH.request (SSCOP-UU, BR) AA-DATA.request (MU)
AA-ESTABLISH.indication (SSCOP-UU) AA-DATA.indication (MU, SN)
AA-ESTABLISH.response (SSCOP-UU, BR)
AA-ESTABLISH.confirm (SSCOP-UU) AA-UNITDATA.request (MU)
AA-RELEASE.request (SSCOP-UU) AA-UNITDATA.indication (MU)
AA-RELEASE.indication (SSCOP-UU, Source) AA-RETRIEVE.request (RN)
AA-RELEASE.confirm AA-RETRIEVE.indication (MU)
AA-RESYNC.request (SSCOP-UU) AA-RETRIEVE_COMPLETE.indication
AA-RESYNC.indication (SSCOP-UU) AA-RECOVER.indication
AA-RESYNC.response AA-RECOVER.response
AA-RESYNC.confirm

Signals to/from Layer Management (defined in 6.1, parameters are listed between parentheses)

=====
MAA-ERROR.indication (Code, Count)
MAA-UNITDATA.request (MU)
MAA-UNITDATA.indication (MU)

Signals to/from CPCS (defined in 6.3, parameters are listed between parentheses)

=====
CPCS-UNITDATA.invoke (ID, LP, CI, CPCS-UU)
CPCS-UNITDATA.signal (ID, LP, CI, CPCS-UU)

T1159450-94/d20

FIGURE 20 (sheet 1 of 51)

Process SSCOP

Default Parameter Values of SSCOP Signals

In order to simplify the SDL representation of SSCOP, the SDL diagrams assume default values for the parameters in SSCOP indication and confirm signals. Unless otherwise specified in the SDL diagrams, the parameters of the indication and confirm signals shall contain the default values specified here (described by the format "PDU.field").

NOTE: The following mapping of the Source parameter to/from the "S" bit ENDPDU field is used:
Source = User: S = 0, and Source = SSCOP: S = 1.

Signal	Parameter	default value
AA-ESTABLISH.indication	SSCOP-UU	BGN.SSCOP-UU
AA-ESTABLISH.confirm	SSCOP-UU	BGAK.SSCOP-UU
AA-RELEASE.indication	SSCOP-UU	END.SSCOP-UU
	Source	END.S
AA-DATA.indication	MU	SD.Information
	SN	SD.N(S)
AA-RESYNC.indication	SSCOP-UU	RS.SSCOP-UU
AA-UNITDATA.indication	MU	UD.Information
AA-RETRIEVE.indication	MU	Retrieved information
MAA-UNITDATA.indication	MU	MD.information

NOTES (on the use of queues):

1 – To enable a satisfactory representation of the SSCOP entity, conceptual queues for the SD, MD, and UD PDUs have been explicitly brought out. These conceptual queues are finite but unbounded and should in no way restrict the implementation of the point-to-point procedures. Three internal (local) signals have been provided in order to cause the servicing of these queues to be initiated: SD PDU queued up, MD PDU queued up, and UD PDU queued up. In the SDL diagrams, these signals are handled by the same "event queue" that handles other signals entering this process.

The SDL diagrams assume the following queues and buffers at the transmitter: Transmission queue (assured data not yet sent), Retransmission queue (SD PDUs that are waiting to be resent), Unassured queue (unassured data that has not yet been sent), Management queue (management data that has not yet been sent), and Transmission buffer (SD PDUs awaiting acknowledgement). At the receiver, a Receiver buffer is assumed for resequencing of SD PDUs.

2 – Signals which are ignored for a given state (inopportune signals) are not included in the SDL diagrams.

3 – The responses by SSCOP to the reception of an inappropriate PDU are described by these SDL diagrams.

4 – Modulo arithmetic is performed on the following state variables: VT(S), VT(PS), VT(A), VT(PA), VT(MS), VR(R), VR(H), VR(MR), VT(SQ), and VR(SQ). VT denotes a transmitter variable, and VR denotes a receiver variable. The modulus equals $2E24$ for the first eight variables listed, and the modulus equals 256 for VT(SQ) and VR(SQ). For modulo comparisons involving the state variables VT(S), VT(A), and VT(MS), the base for comparisons is VT(A). For modulo comparisons involving the state variables VR(R), VR(H), and VR(MR), the base for comparisons is VR(R). For modulo comparisons involving the state variables VT(PS) and VT(PA), the base for comparison is VT(PA).

5 – The variables "i", "seq1", "seq2", "Count", and "List_Length" are used in the SDL diagrams. These are loop variables used to illustrate the loop only, and do not constitute SSCOP state variables or parameters. The "retransmission" parameter is used only to return a value from a macro call, and does not constitute an SSCOP parameter.

6 – Where "null" codings of the SSCOP-UU PDU field are specified, this implies that the field is absent and the PL field is coded as zero.

7 – In the SDL diagrams, when a PDU containing the parameter N(MR) must be resent, it is possible for the N(MR) field to be updated even if the retransmitted PDU is otherwise identical.

T1 159460-94/d21

FIGURE 20 (sheet 2 of 51)

Process SSCOP

Default Field Values Assigned to SSCOP PDUs

In order to simplify the SDL representation of SSCOP, the SDLs assume default values for the fields in SSCOP PDUs. Unless otherwise specified in the SDLs, the fields (i.e. SSCOP PDU parameters) of the transmitted SSCOP PDUs shall be assigned the default values specified here (default values are either state variables, signal parameter values, or received PDU parameters).

PDU	Field	Default Value
SD	N(S) Information	VT(S) AA-DATA.request (MU)
POLL	N(PS) N(S)	VT(PS) VT(S)
STAT	N(R) N(MR) N(PS)	VR(R) VR(MR) POLL.N(PS)
USTAT	N(R) N(MR)	VR(R) VR(MR)
UD	Information	AA-UNITDATA.request (MU)
MD	Information	MAA-UNITDATA.request (MU)
BGN	N(MR) SSCOP-UU N(SQ)	VR(MR) AA-ESTABLISH.request (SSCOP-UU) VT(SQ)
BGAK	N(MR) SSCOP-UU	VR(MR) AA-ESTABLISH.response (SSCOP-UU)
BGREJ	SSCOP-UU	AA-RELEASE.request (SSCOP-UU)
ER	N(MR) N(SQ)	VR(MR) VT(SQ)
ERAK	N(MR)	VR(MR)
END	SSCOP-UU S	AA-RELEASE.request (SSCOP-UU) 0
RS	SSCOP-UU N(MR) N(SQ)	AA-RESYNC.request (SSCOP-UU) VR(MR) VT(SQ)
RSAK	N(MR)	VR(MR)

T1159470-94/d22

FIGURE 20 (sheet 3 of 51)

Process SSCOP

SDL Key

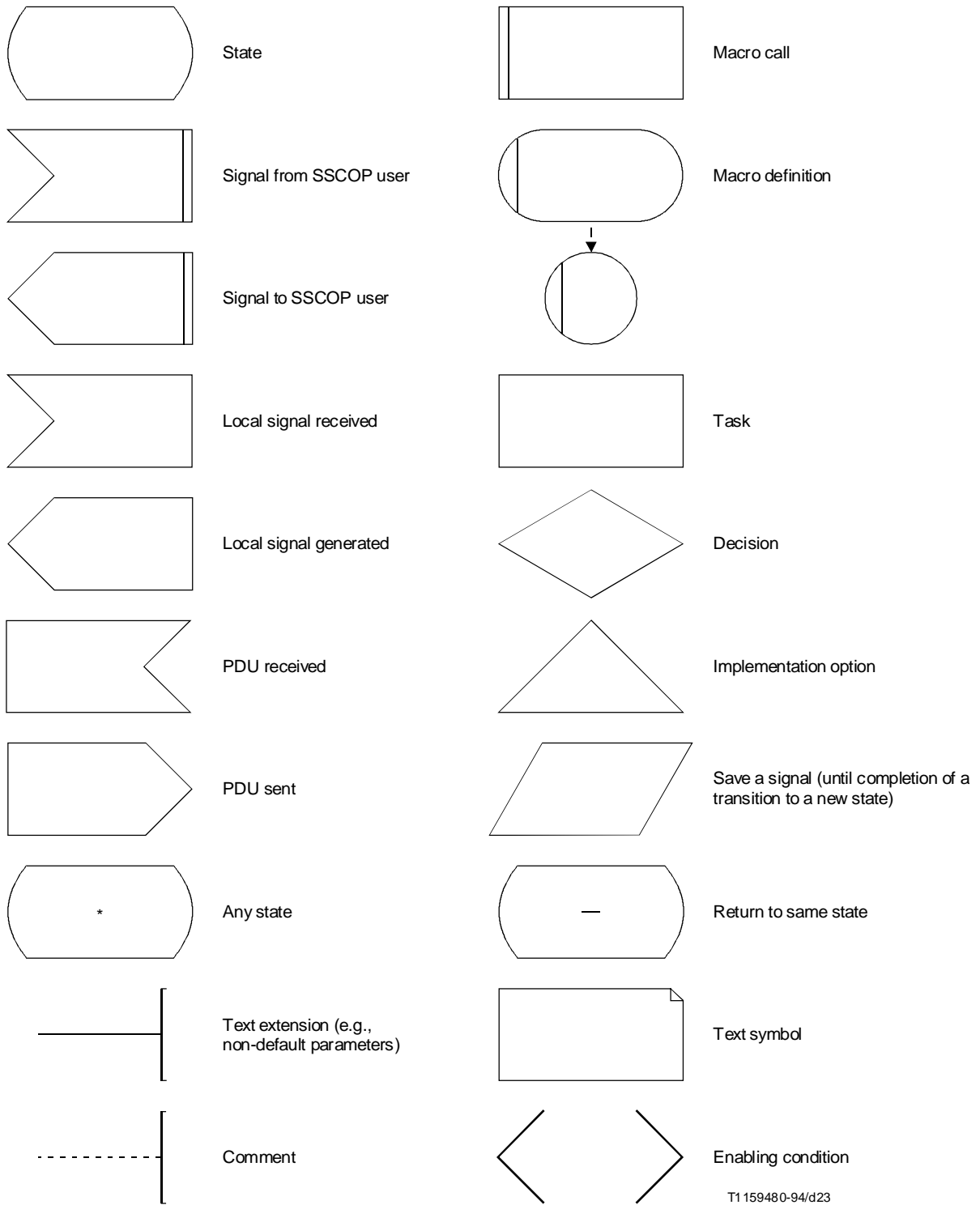

T1 159480-94/d23

NOTE – Three asterisks (***) are placed above a symbol to mark an event or signal required as a result of the representation approach adopted, which is local to the SSCOP entity.

FIGURE 20 (sheet 4 of 51)

Process SSCOP

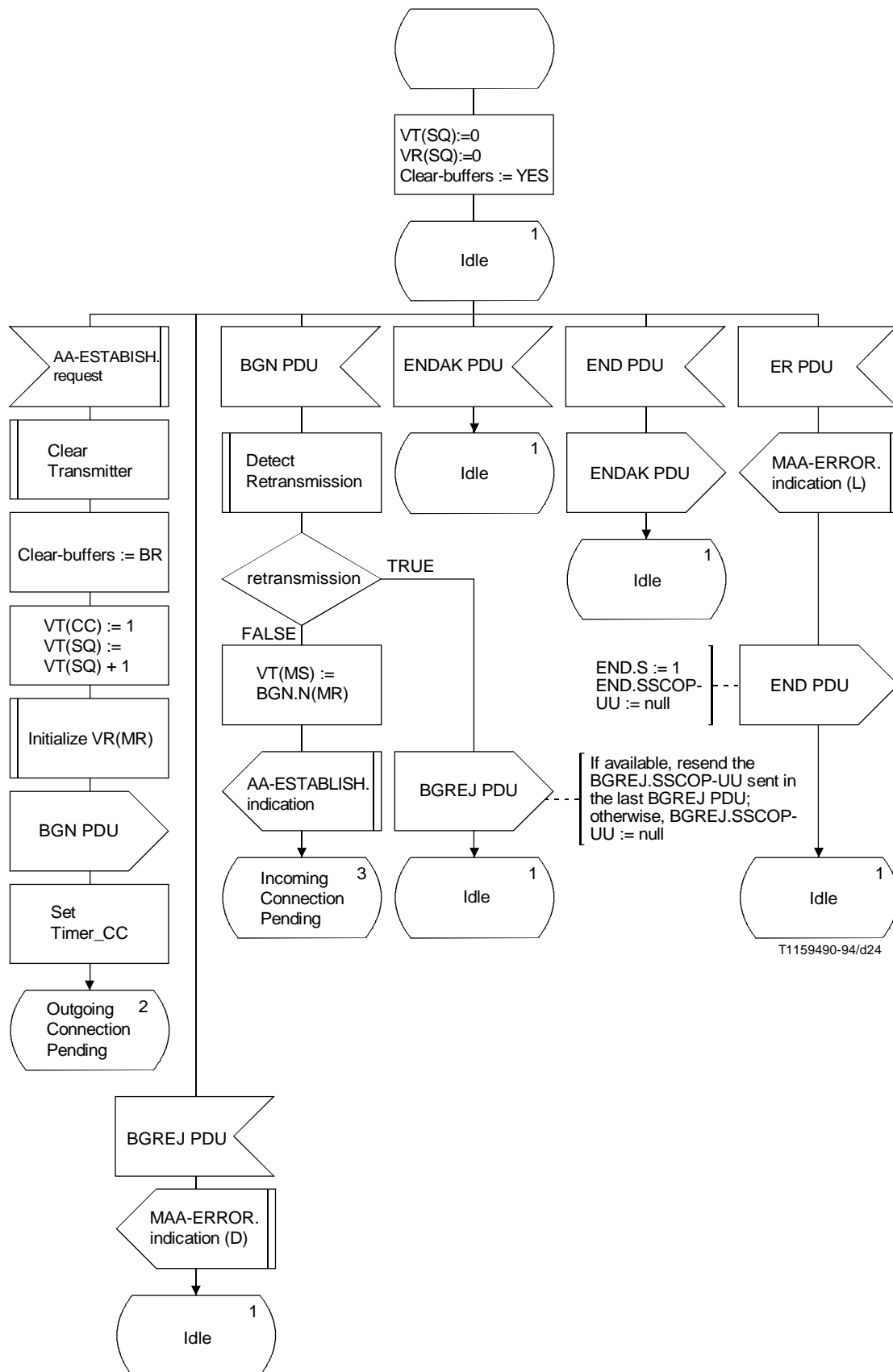

T1159490-94/d24

FIGURE 20 (sheet 5 of 51)
Process SSCOP

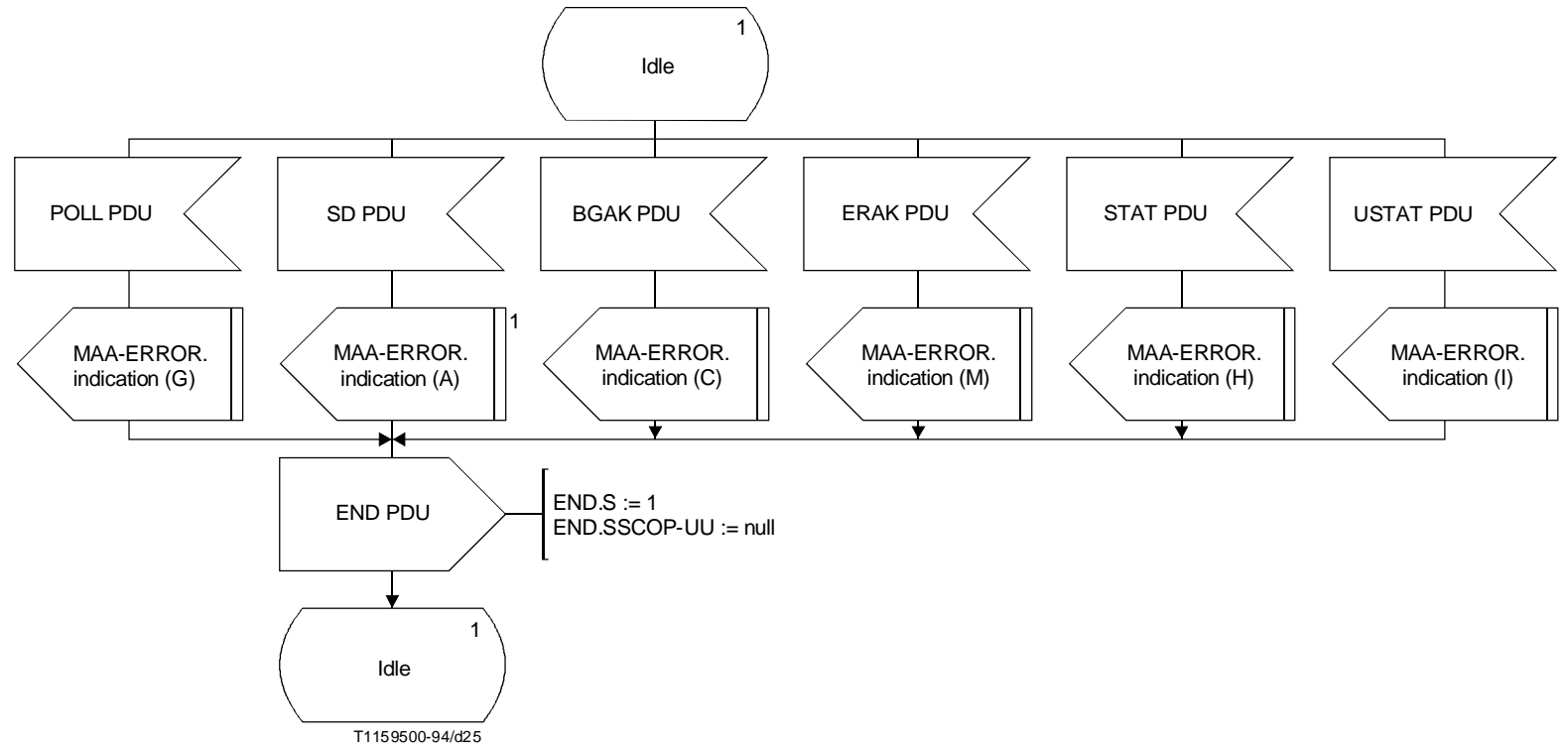
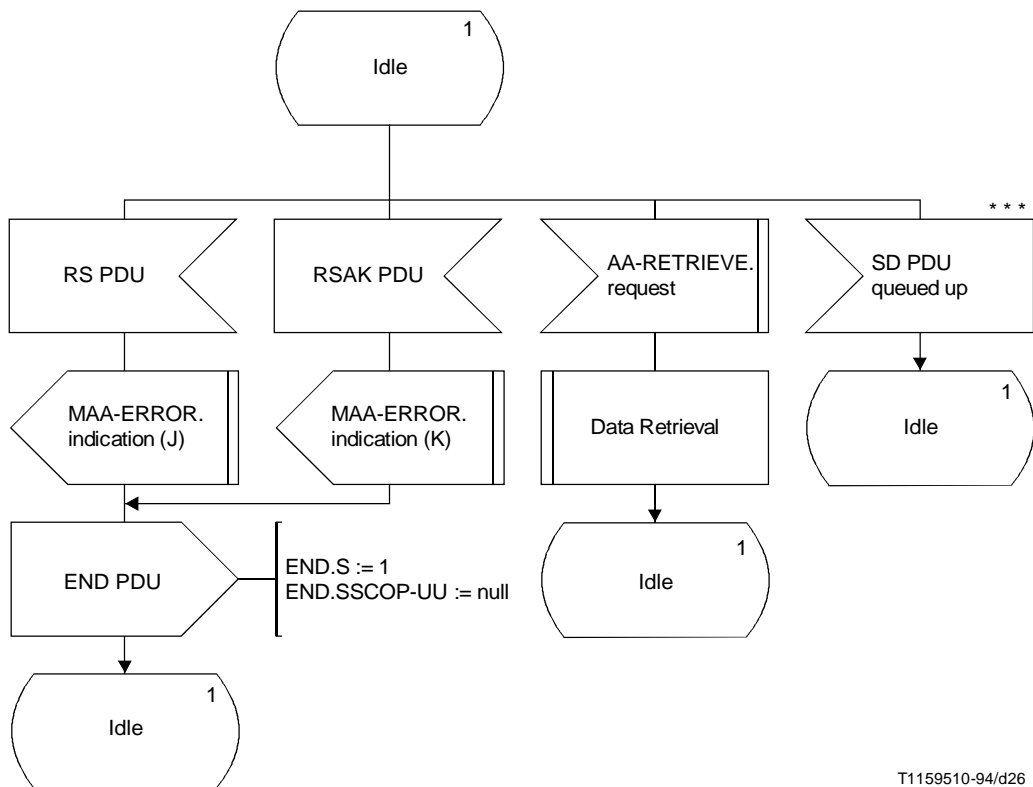

FIGURE 20 (sheet 6 of 51)
Process SSCOP



T1159510-94/d26

FIGURE 20 (sheet 7 of 51)

Process SSCOP

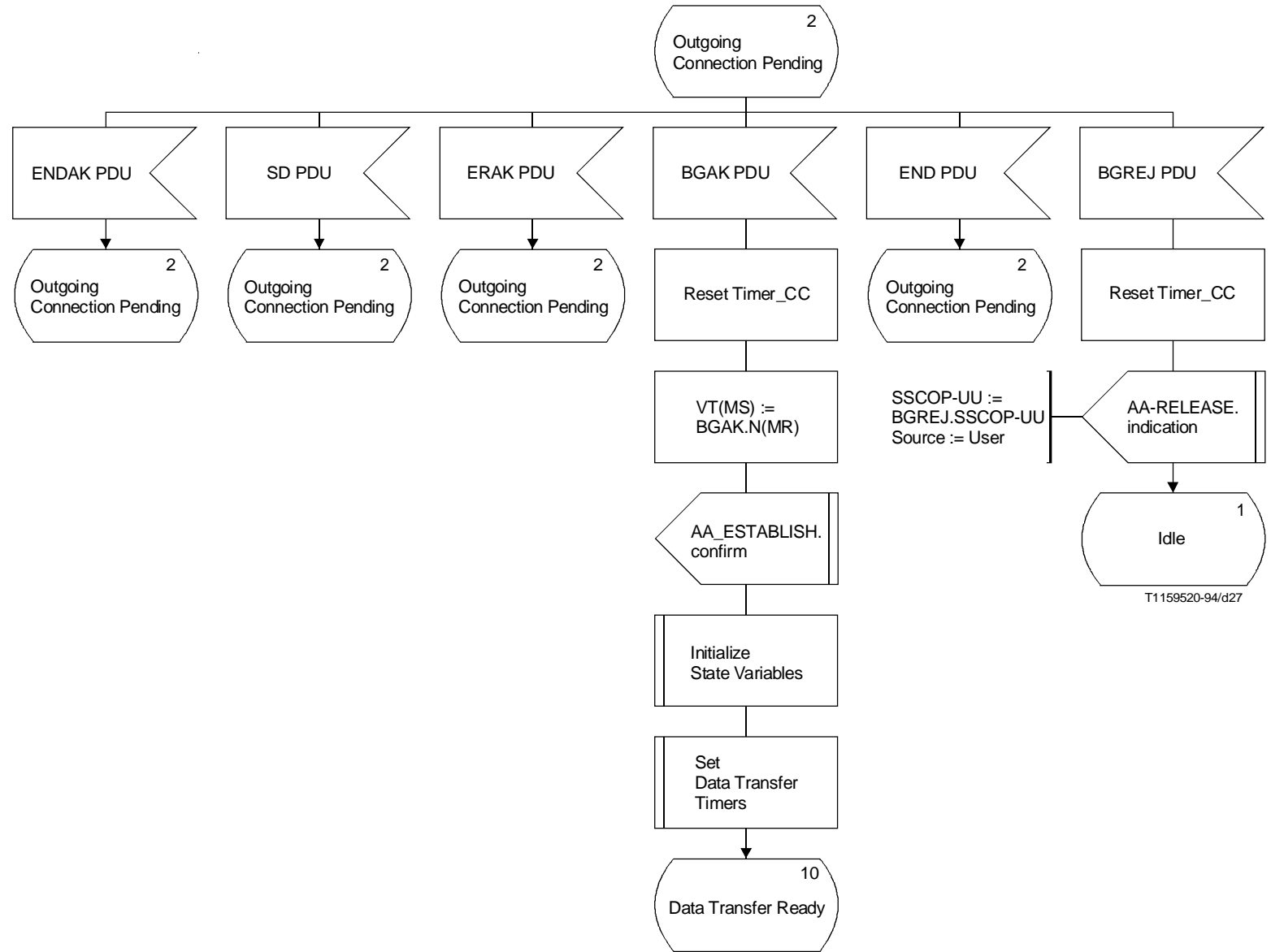

FIGURE 20 (sheet 8 of 5)

Process SSCOP

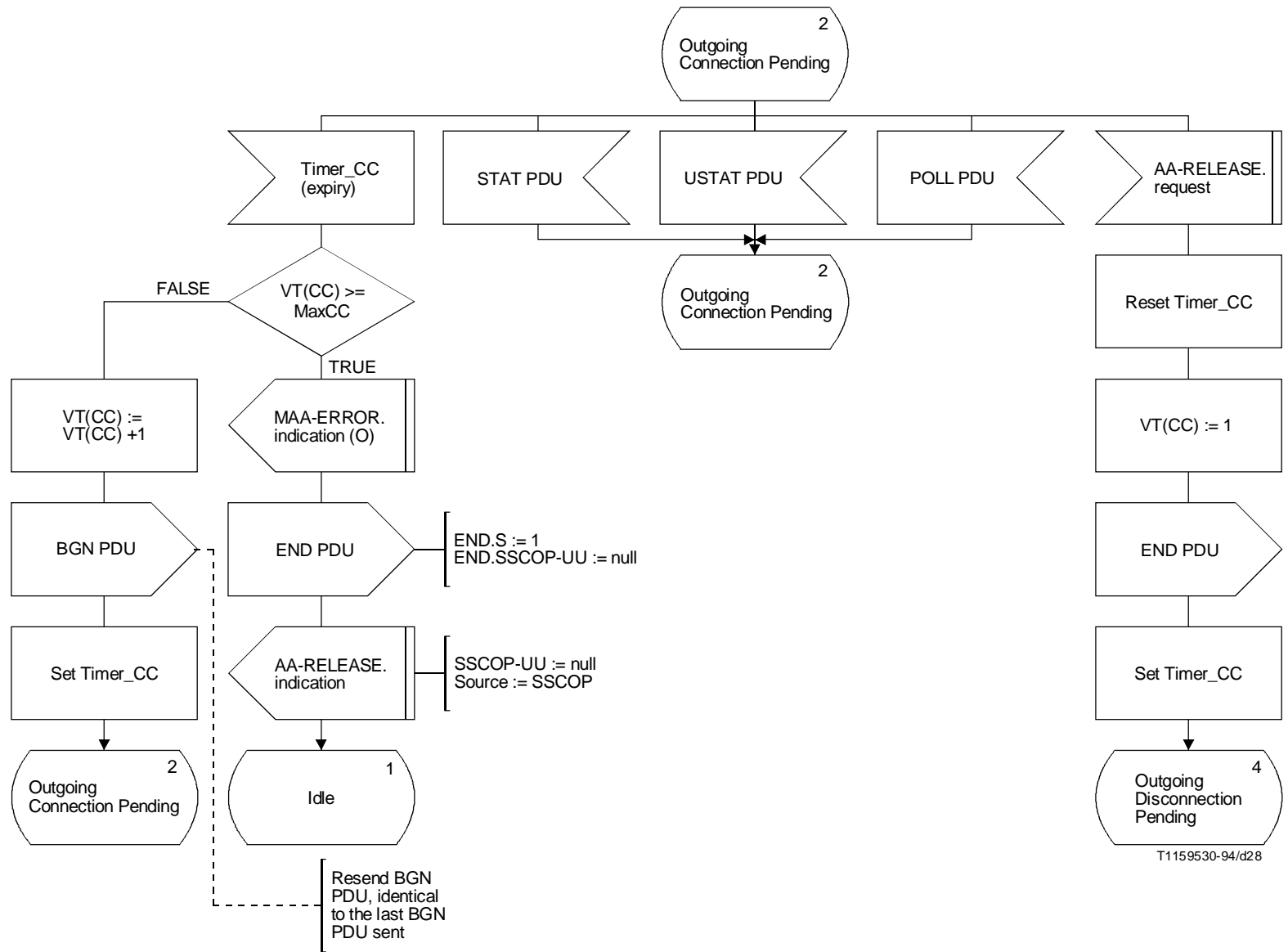

FIGURE 20 (sheet 9 of 51)

Process SSCOP

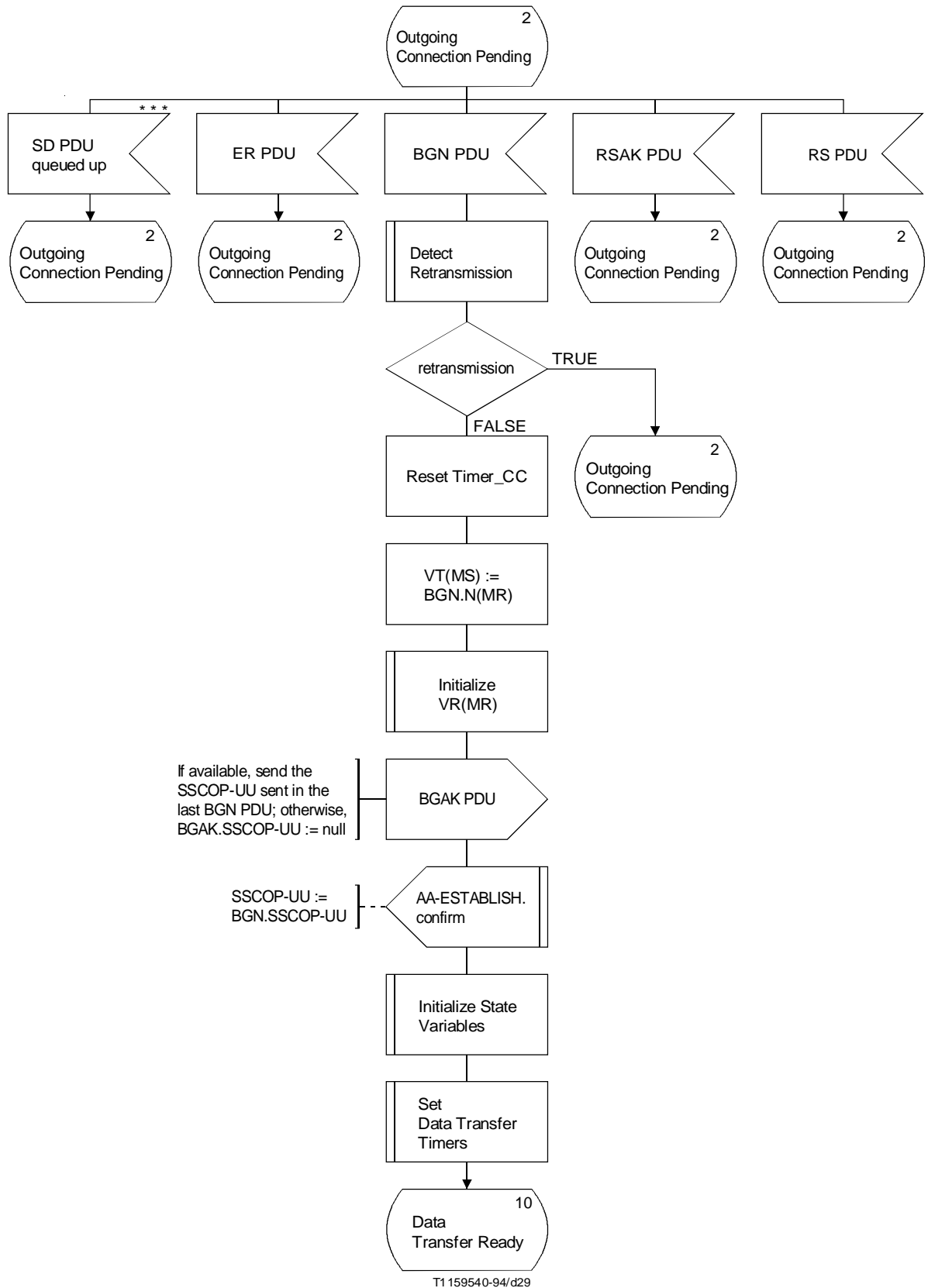
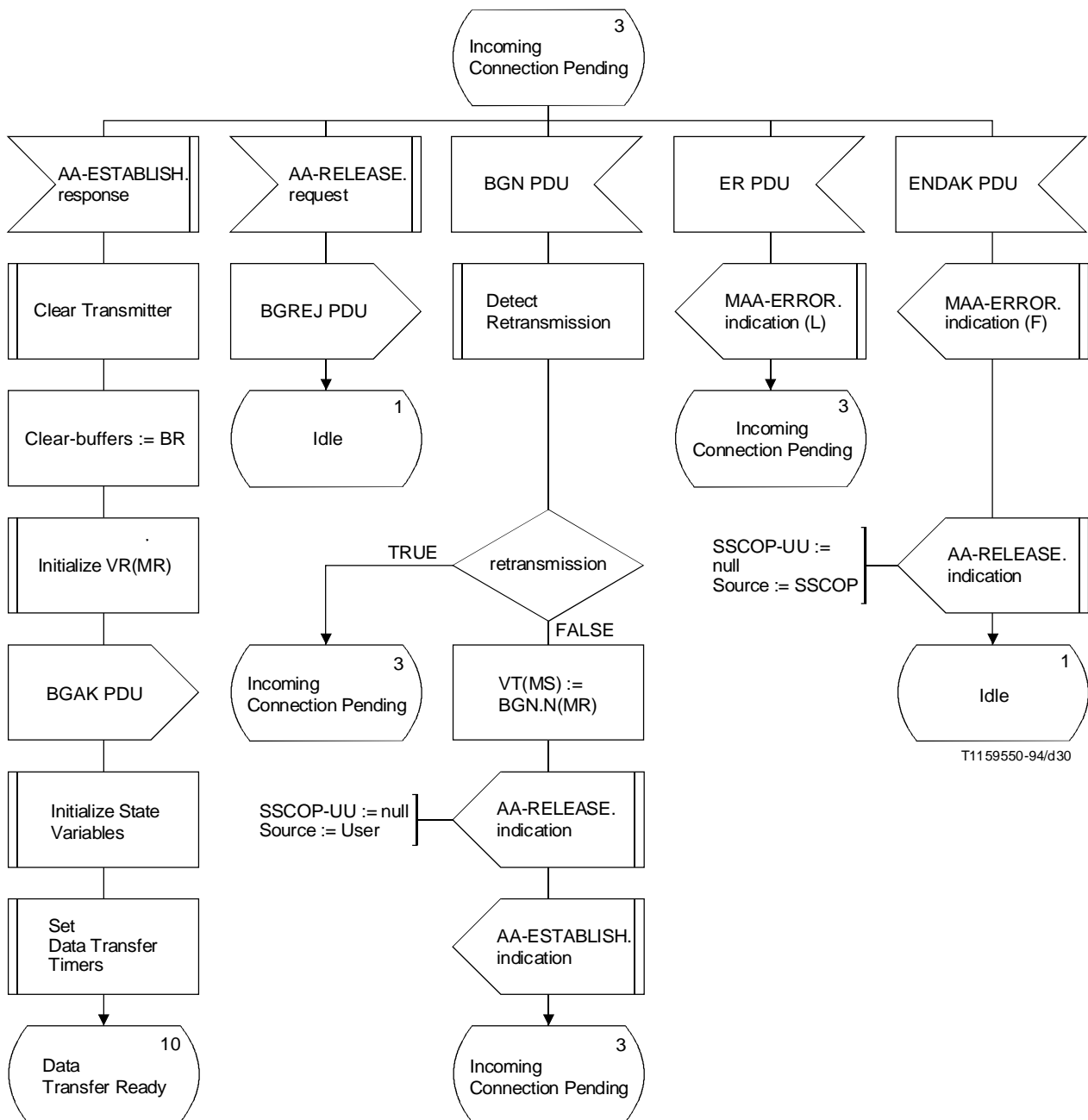

FIGURE 20 (sheet 10 of 51)
Process SSCOP



T1159550-94/d30

FIGURE 20 (sheet 11 of 51)
Process SSCOP

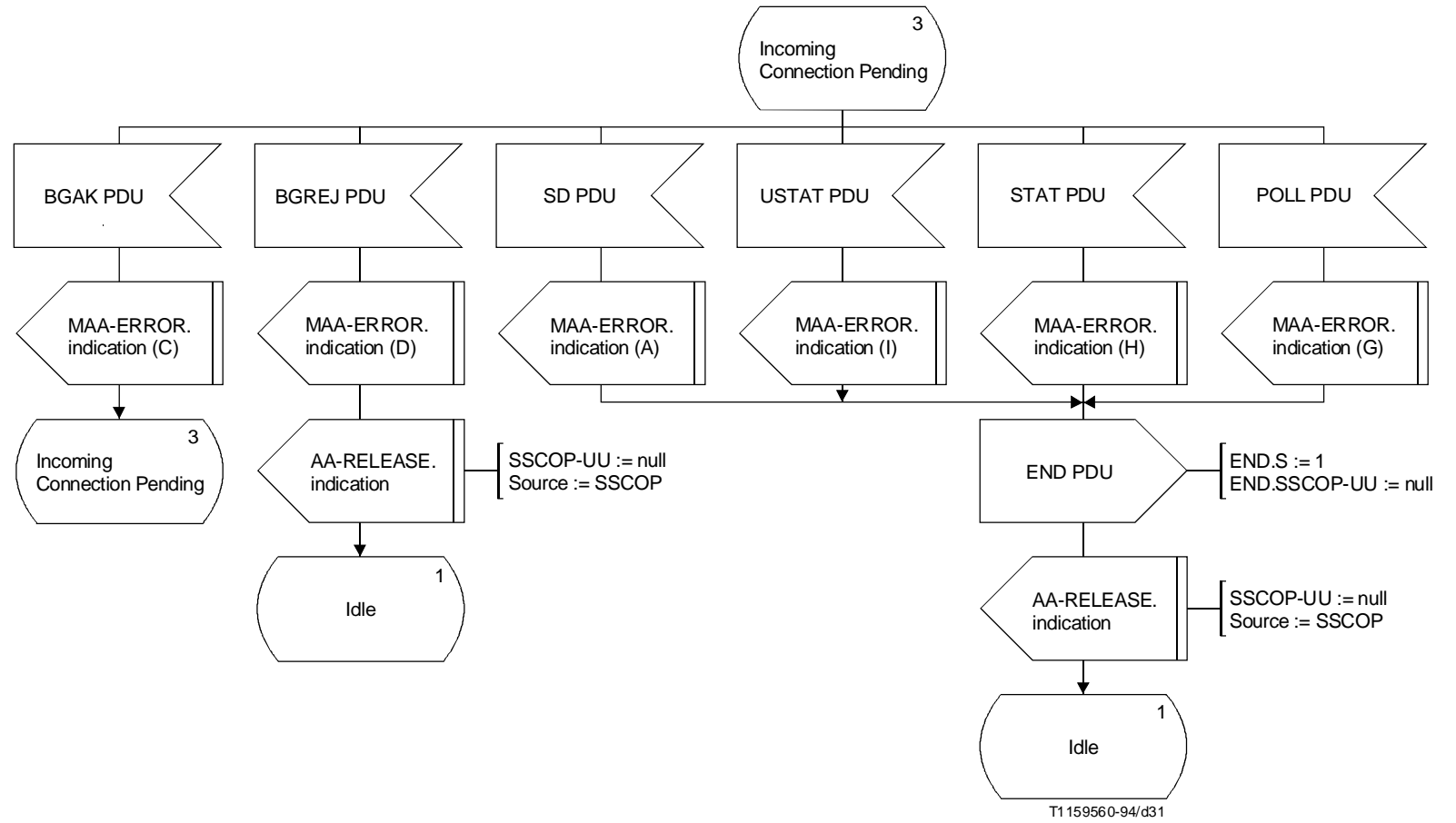

FIGURE 20 (sheet 12 of 51)
Process SSCOP

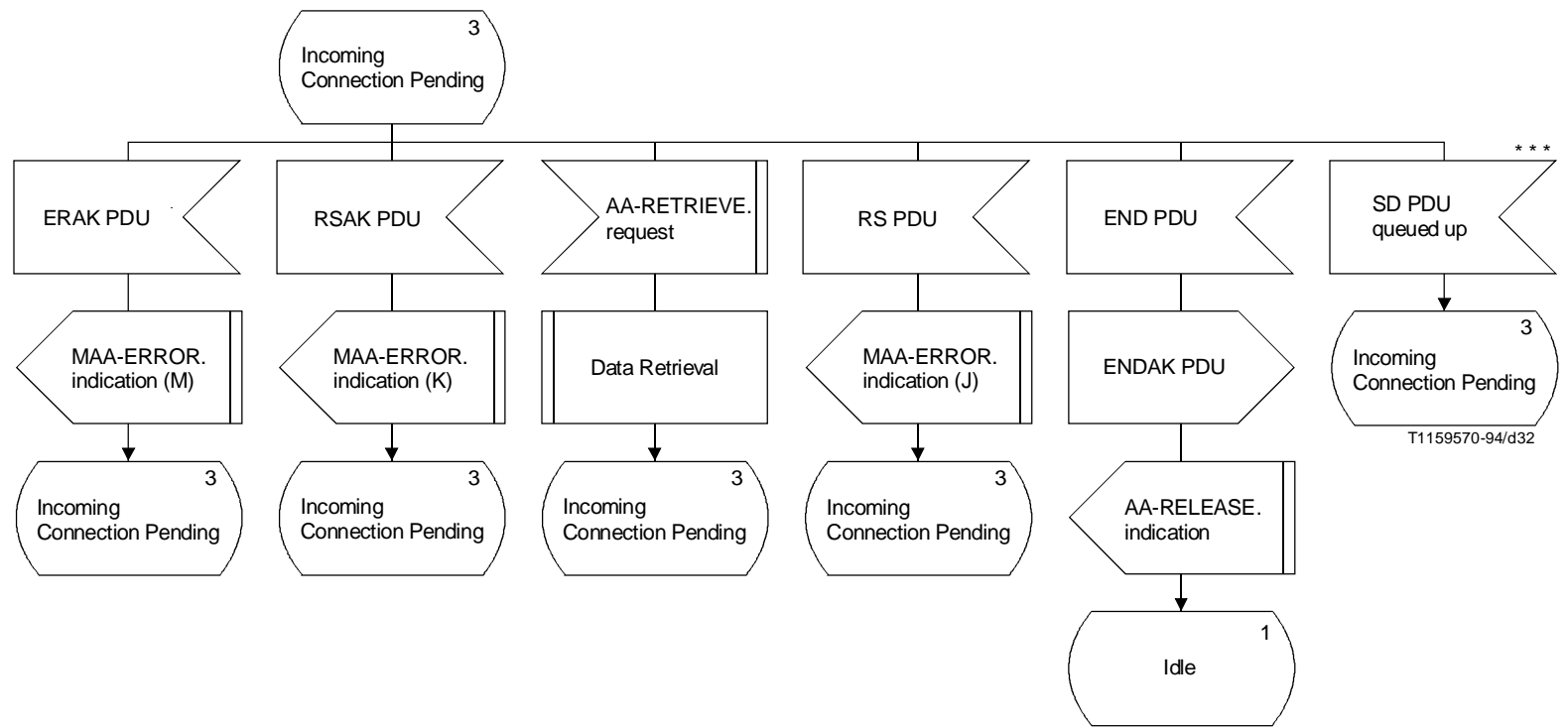

FIGURE 20 (sheet 13 of 51)
Process SSCOP

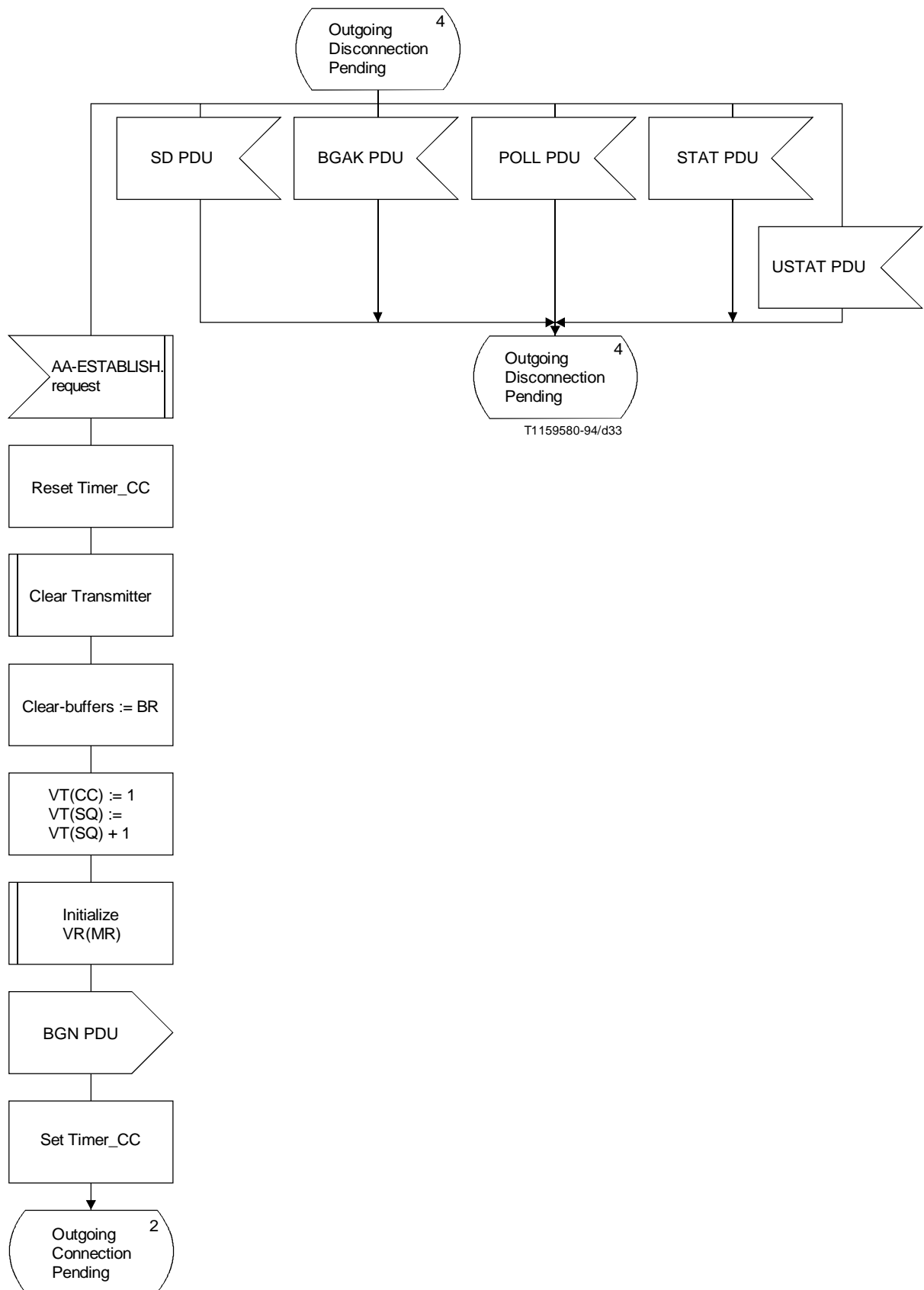

FIGURE 20 (sheet 14 of 51)
Process SSCOP

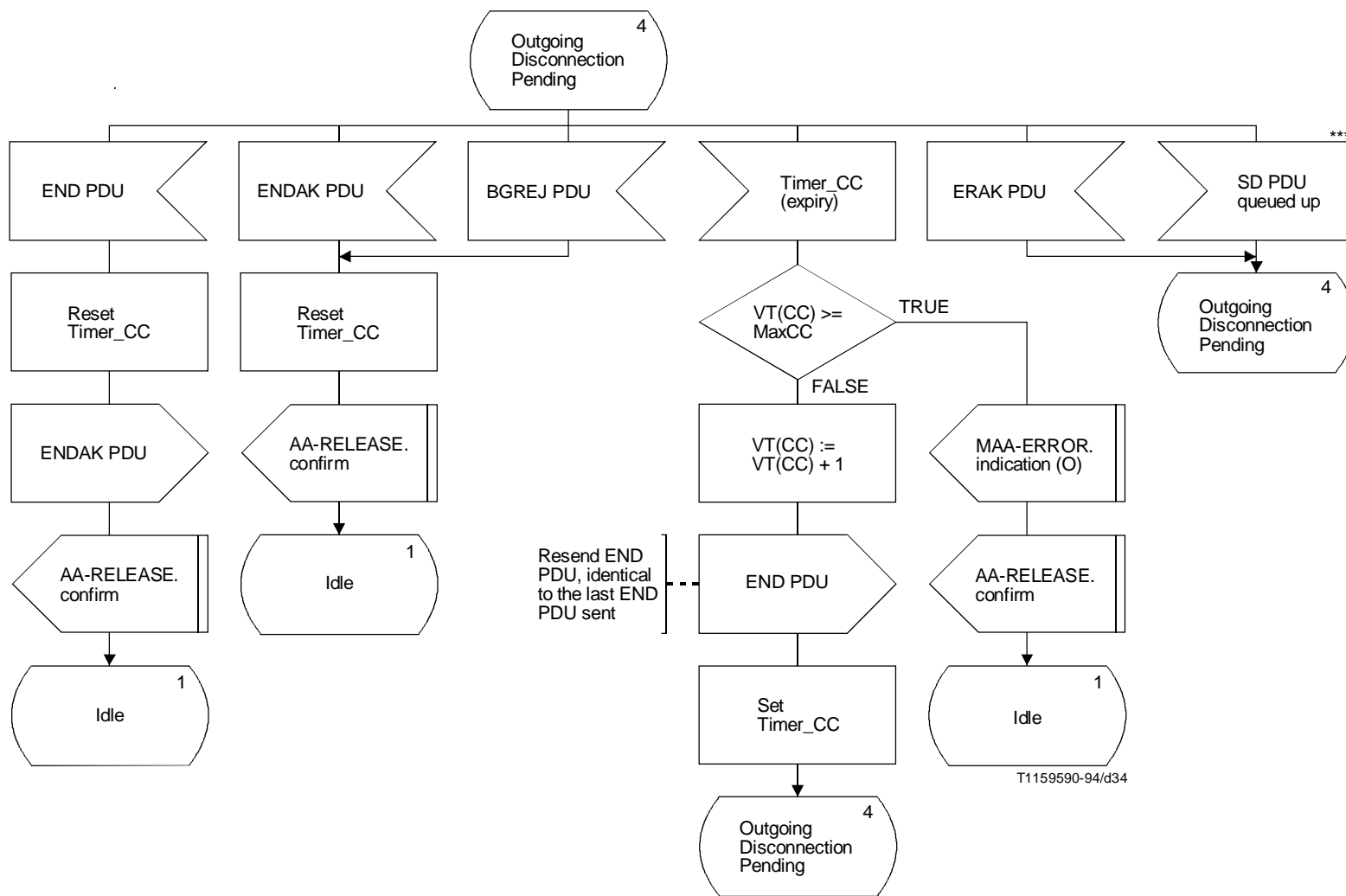

FIGURE 20 (sheet 15 of 51)

Process SSCOP

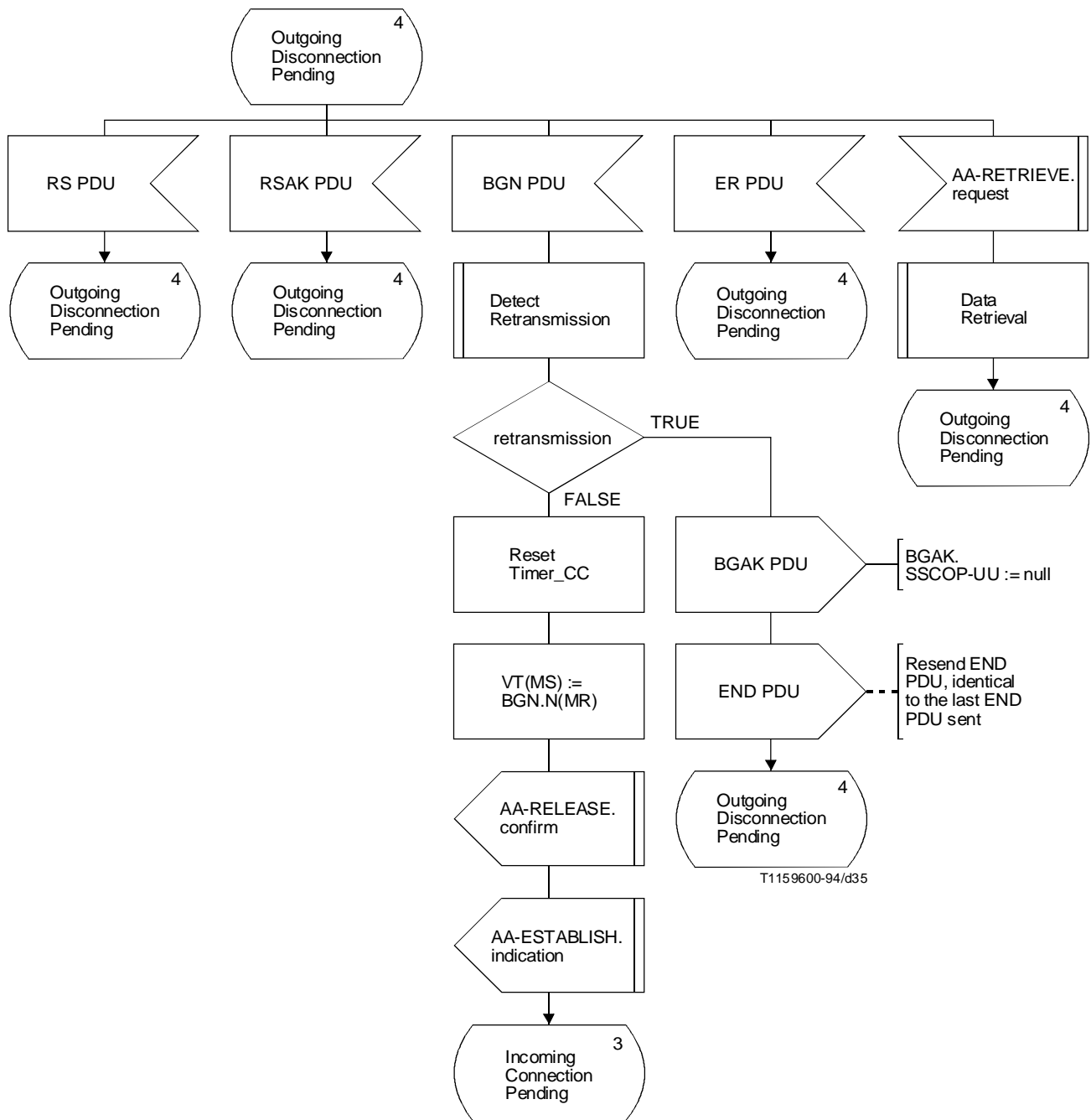

FIGURE 20 (sheet 16 of 51)
Process SSCOP

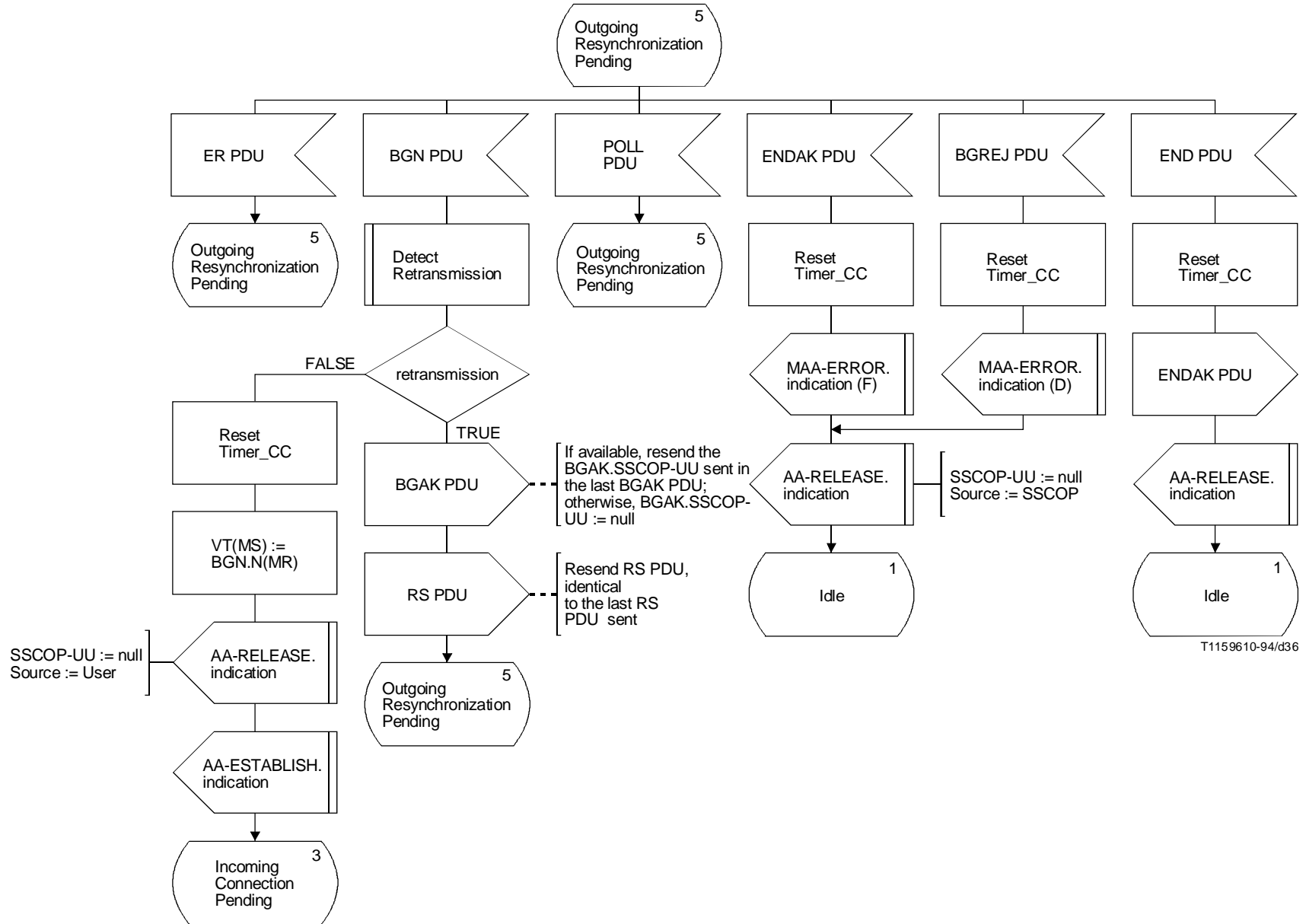
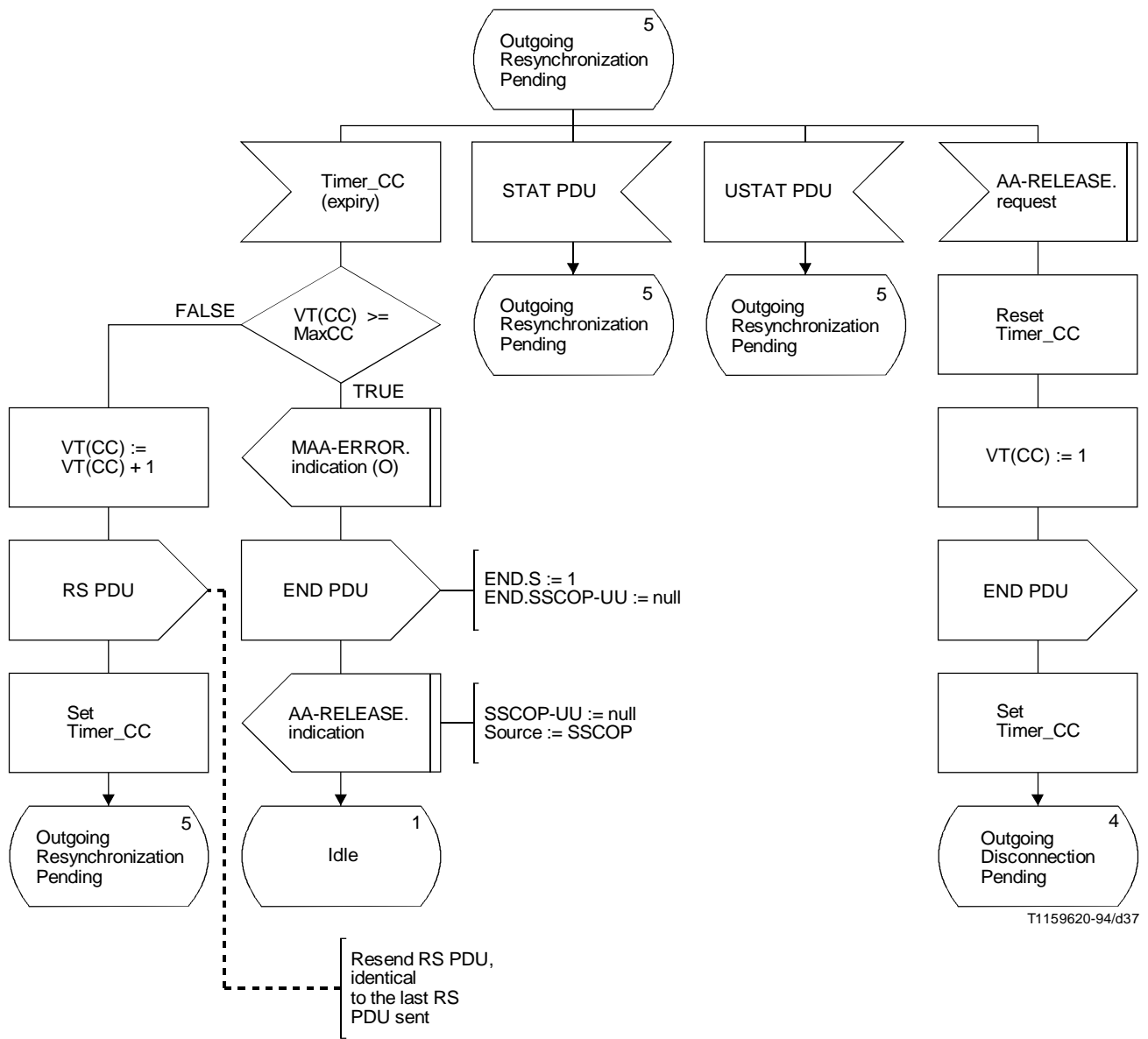
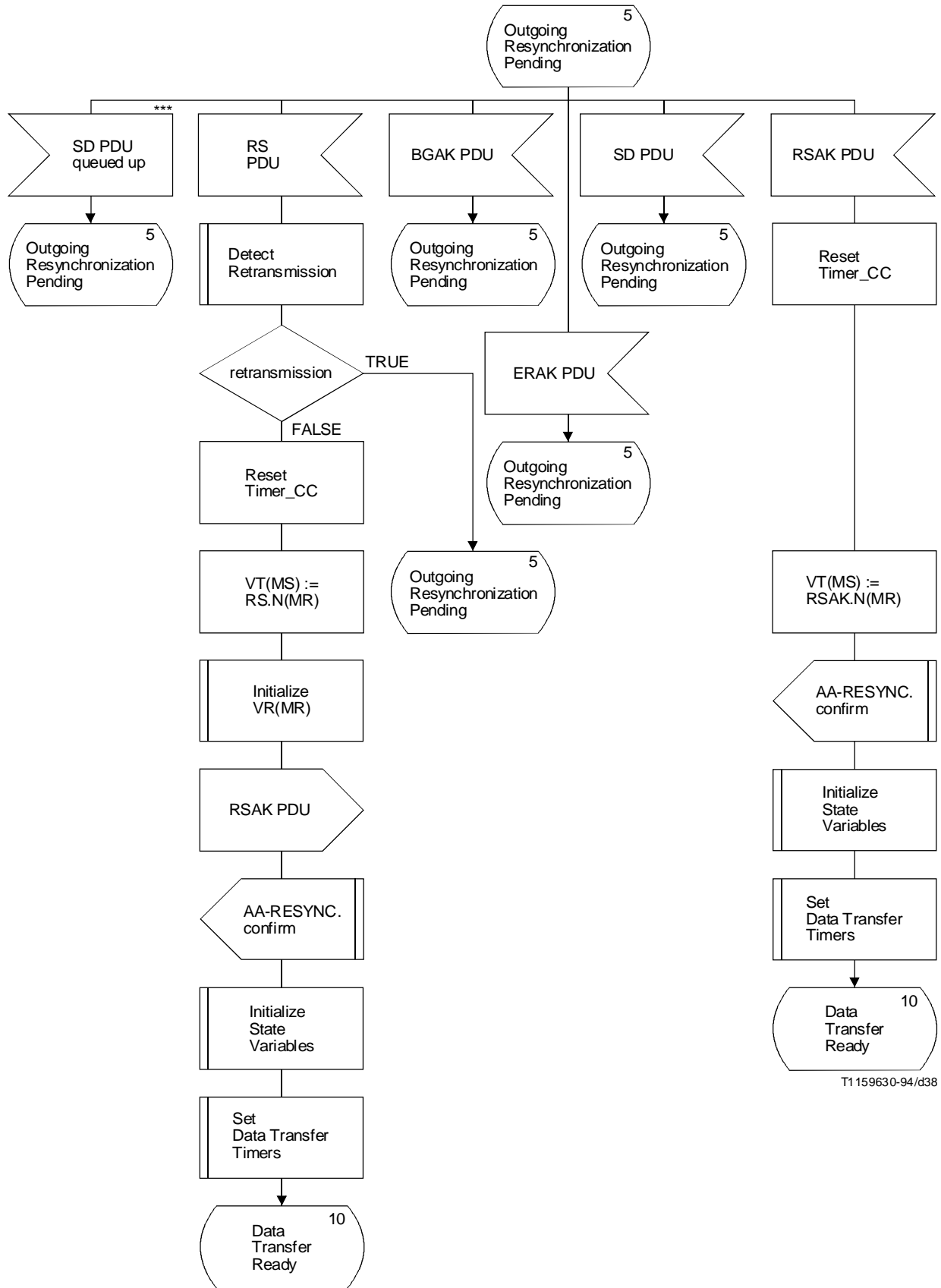

FIGURE 20 (sheet 17 of 51)
Process SSCOP



T1159620-94/d37

FIGURE 20 (sheet 18 of 51)
Process SSCOP



T1159630-94/d38

FIGURE 20 (sheet 19 of 51)

Process SSCOP

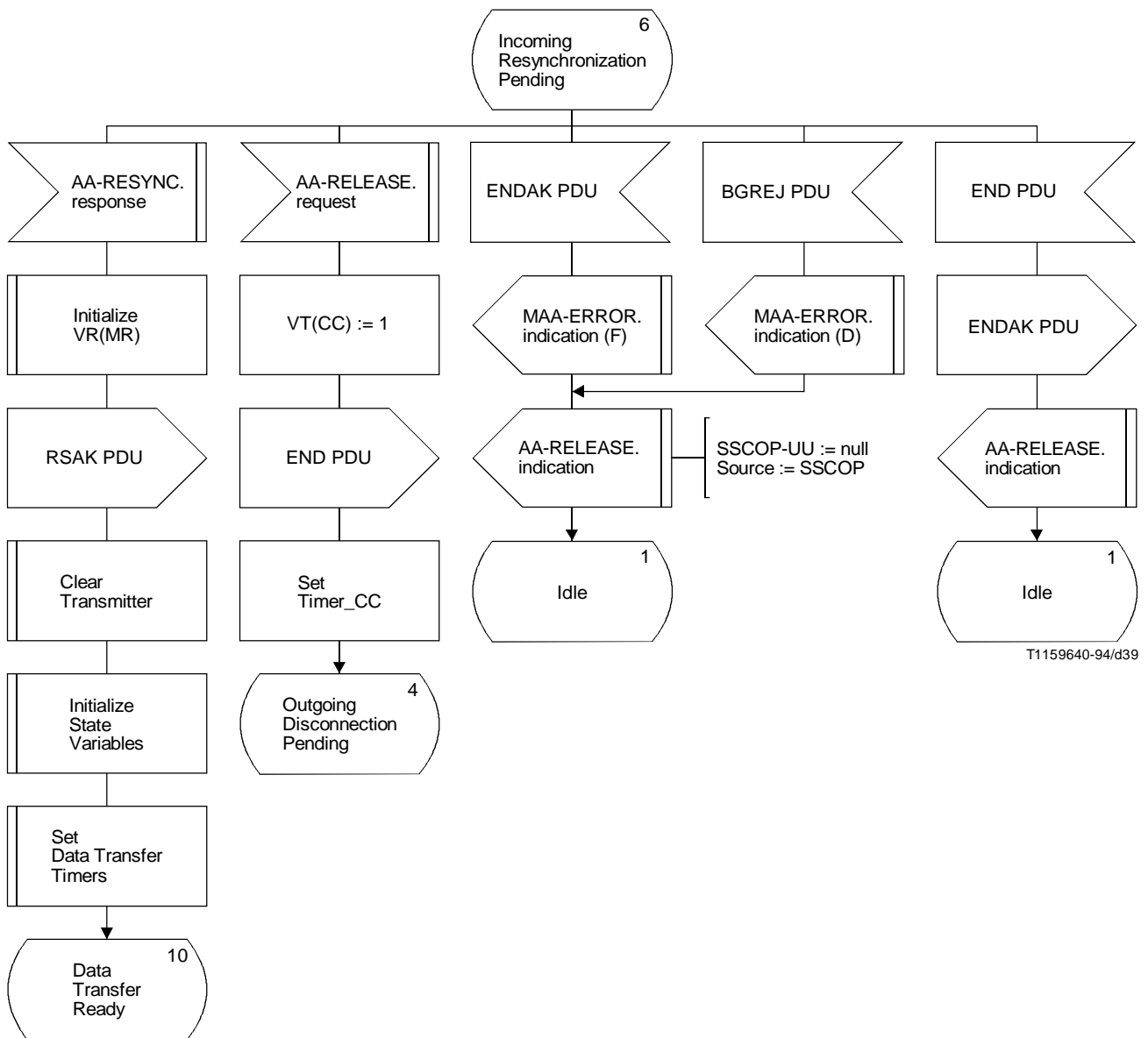

FIGURE 20 (sheet 20 of 51)
Process SSCOP

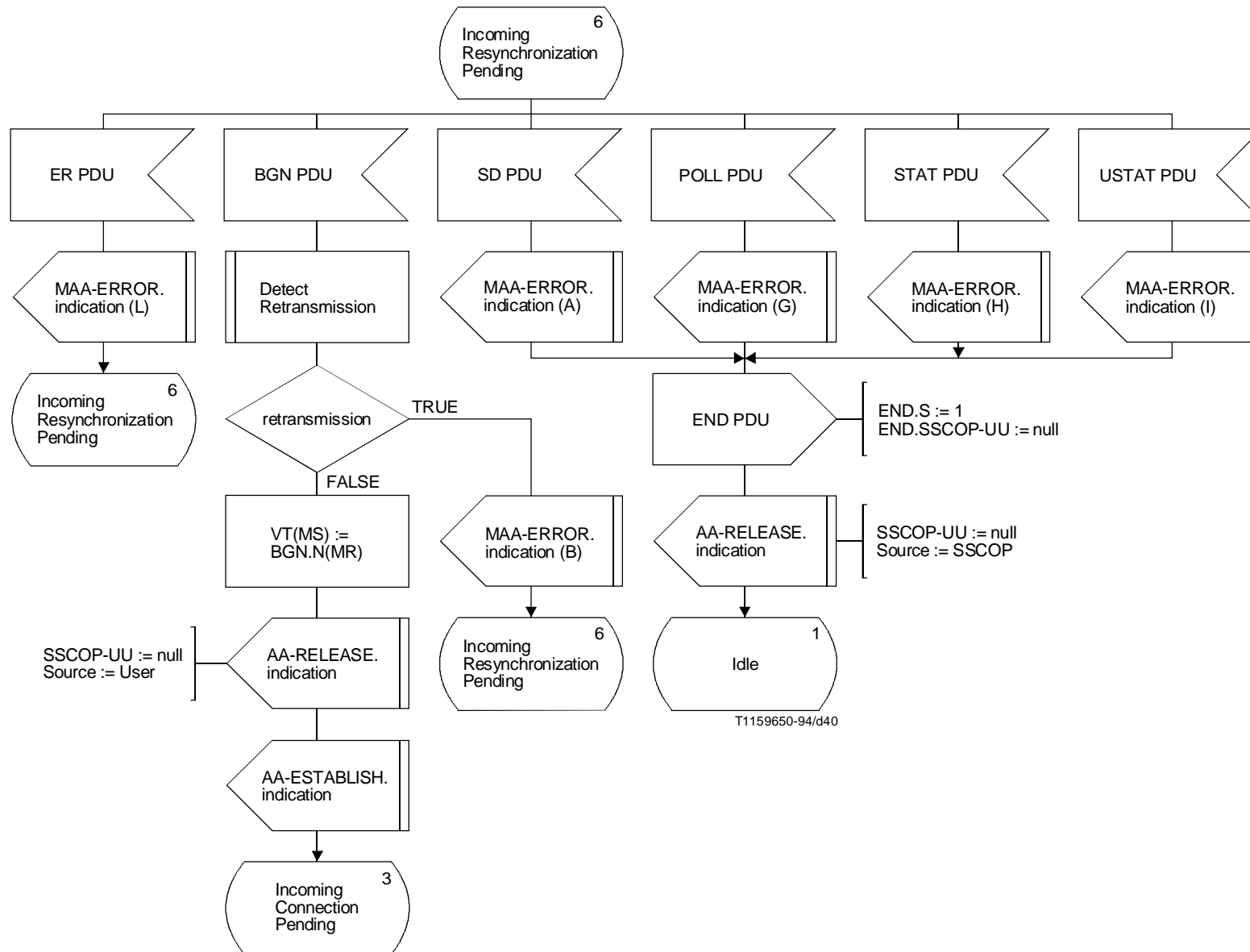

FIGURE 20 (sheet 21 of 51)

Process SSCOP

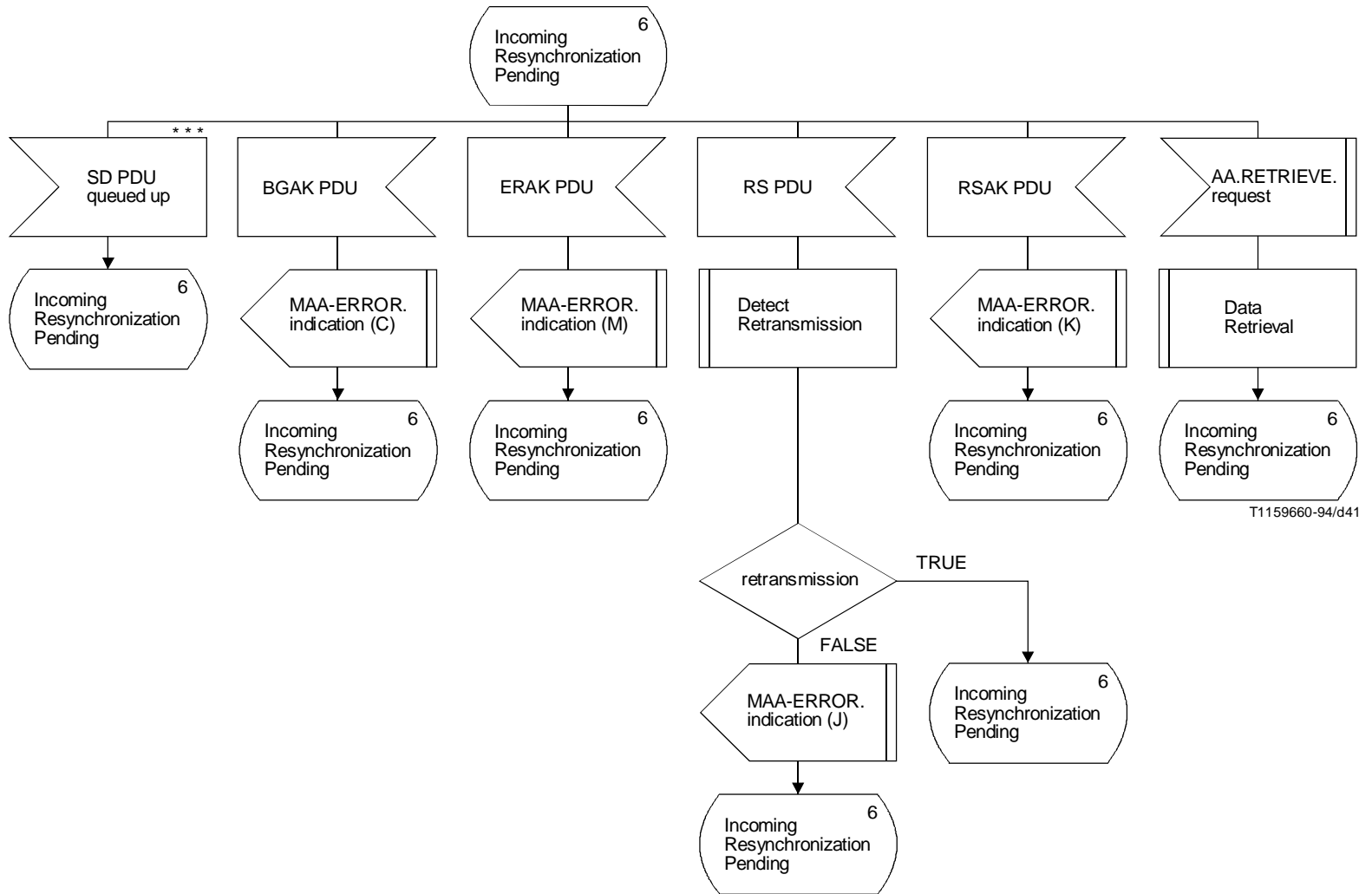
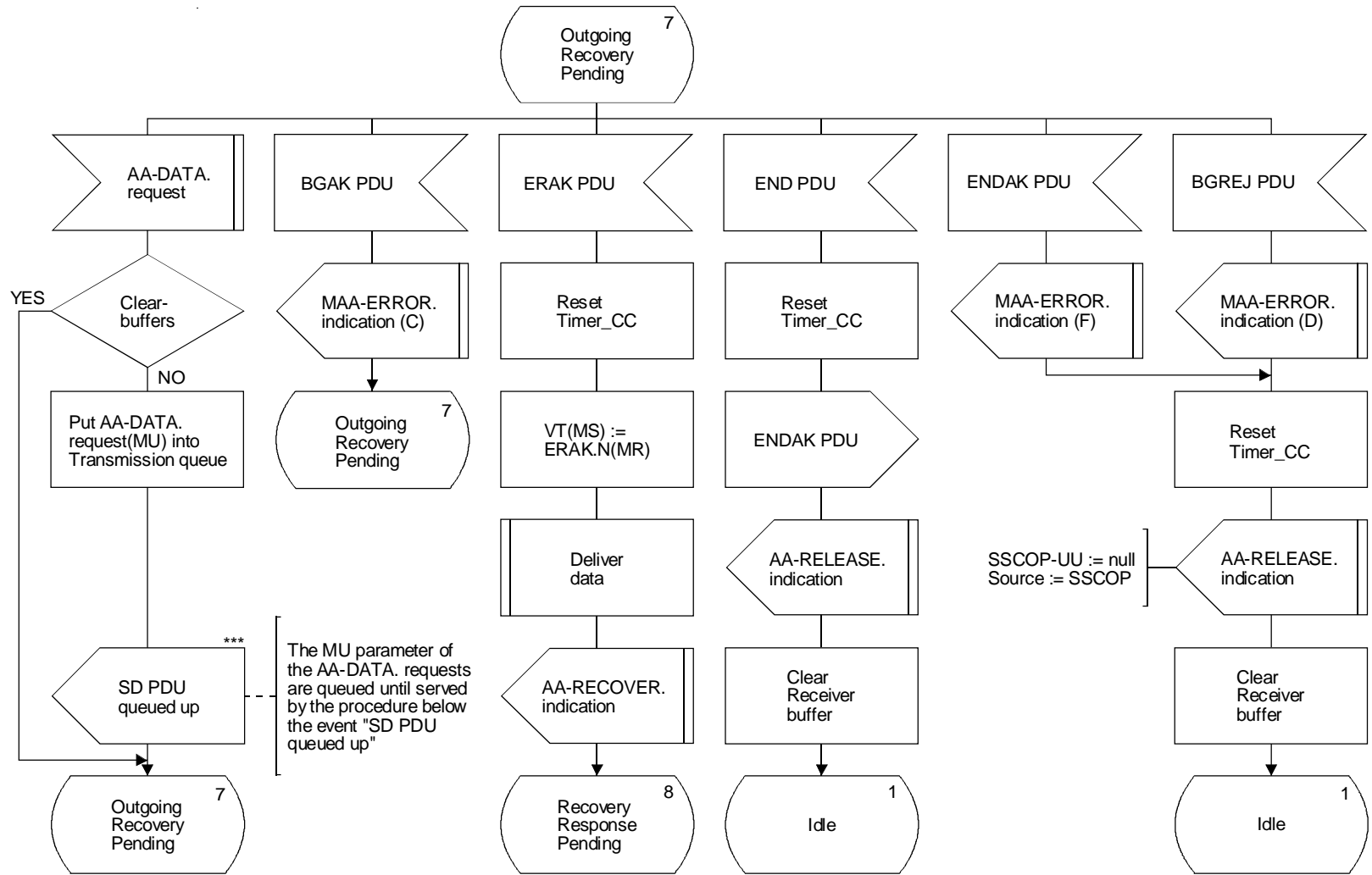

FIGURE 20 (sheet 22 of 51)

Process SSCOP



T1159670-94/d42

FIGURE 20 (sheet 23 of 51)
Process SSCOP

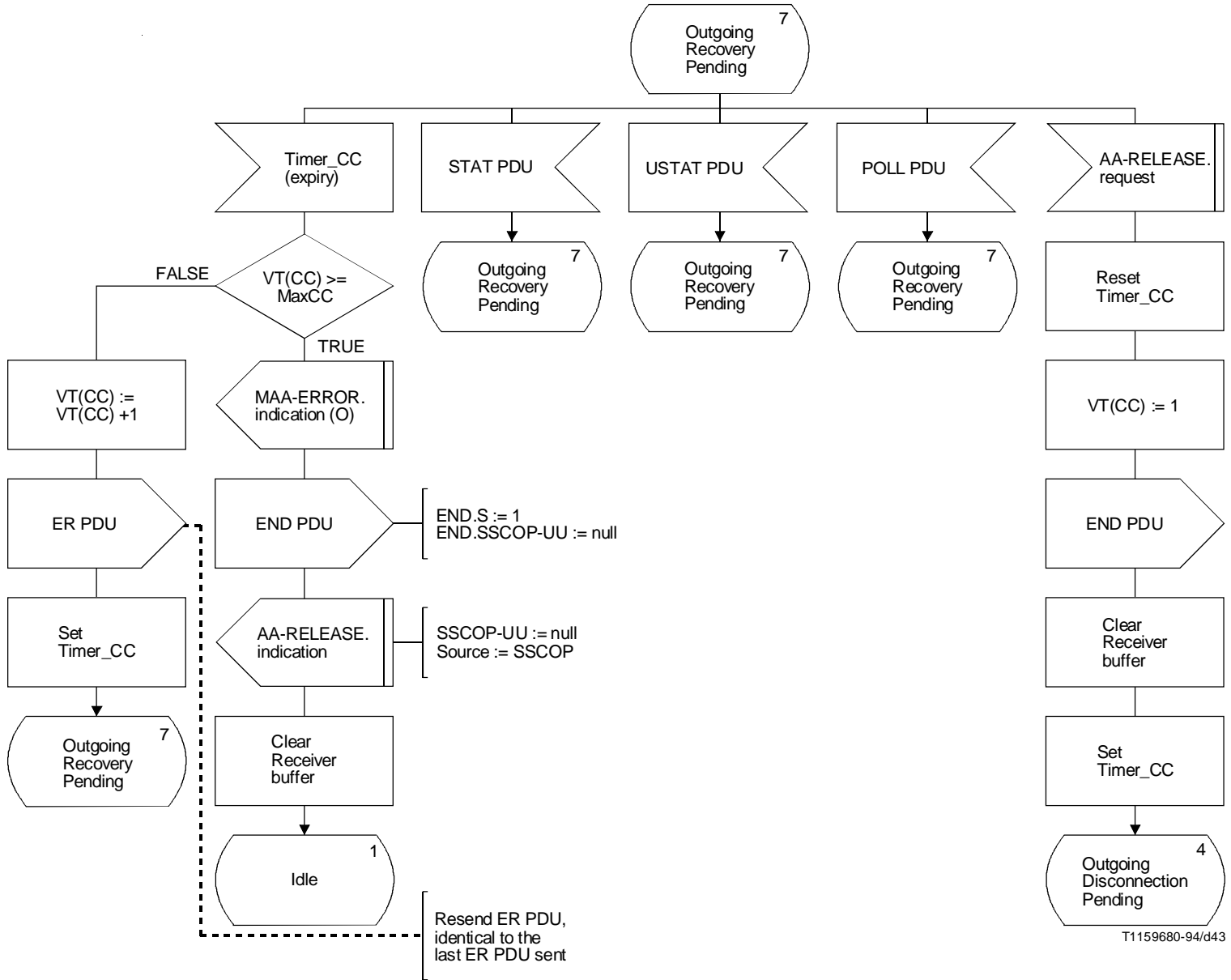
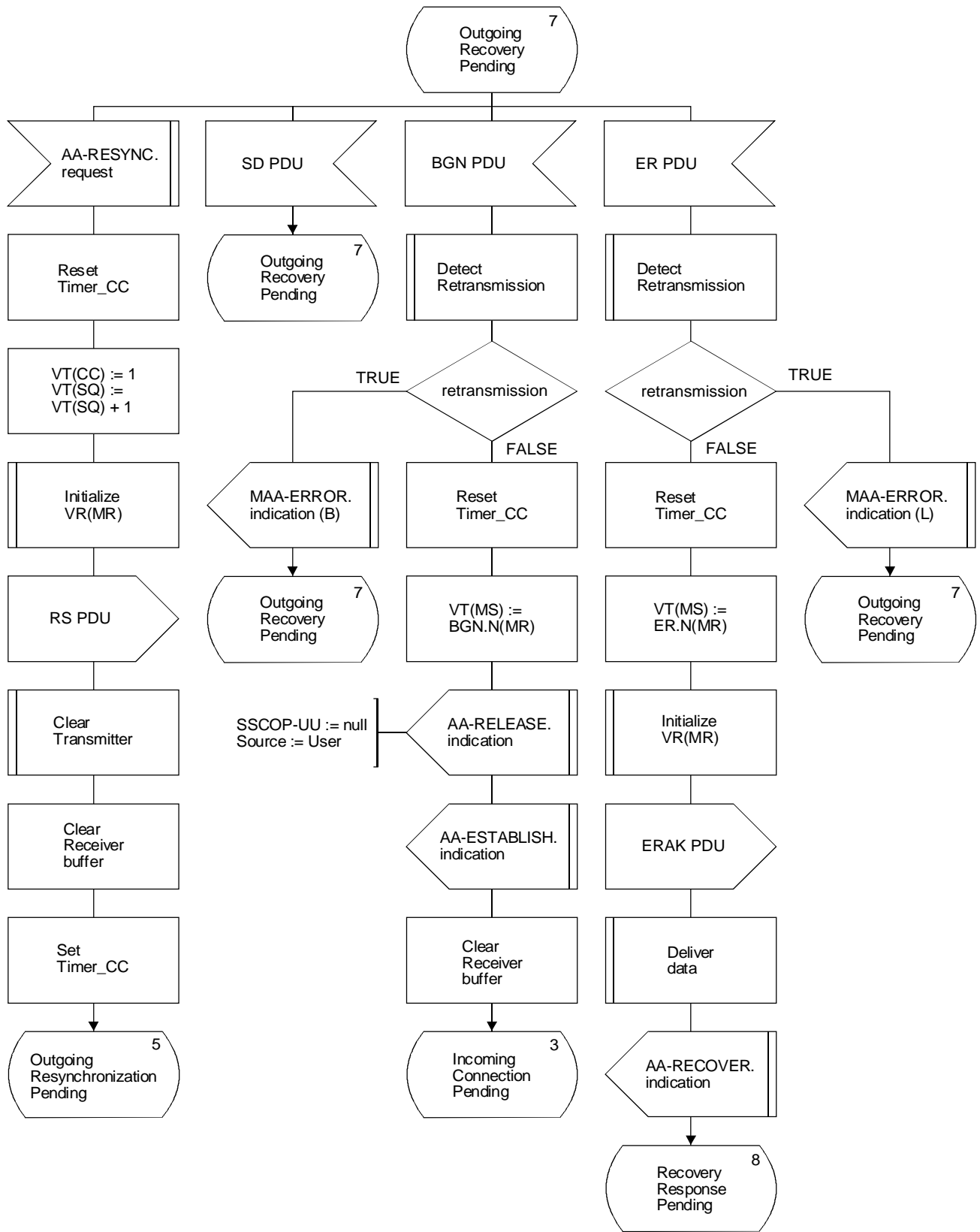

FIGURE 20 (sheet 24 of 51)

Process SSCOP

T1159680-94/d43



T1159690-94/d44

FIGURE 20 (sheet 25 of 51)
Process SSCOP

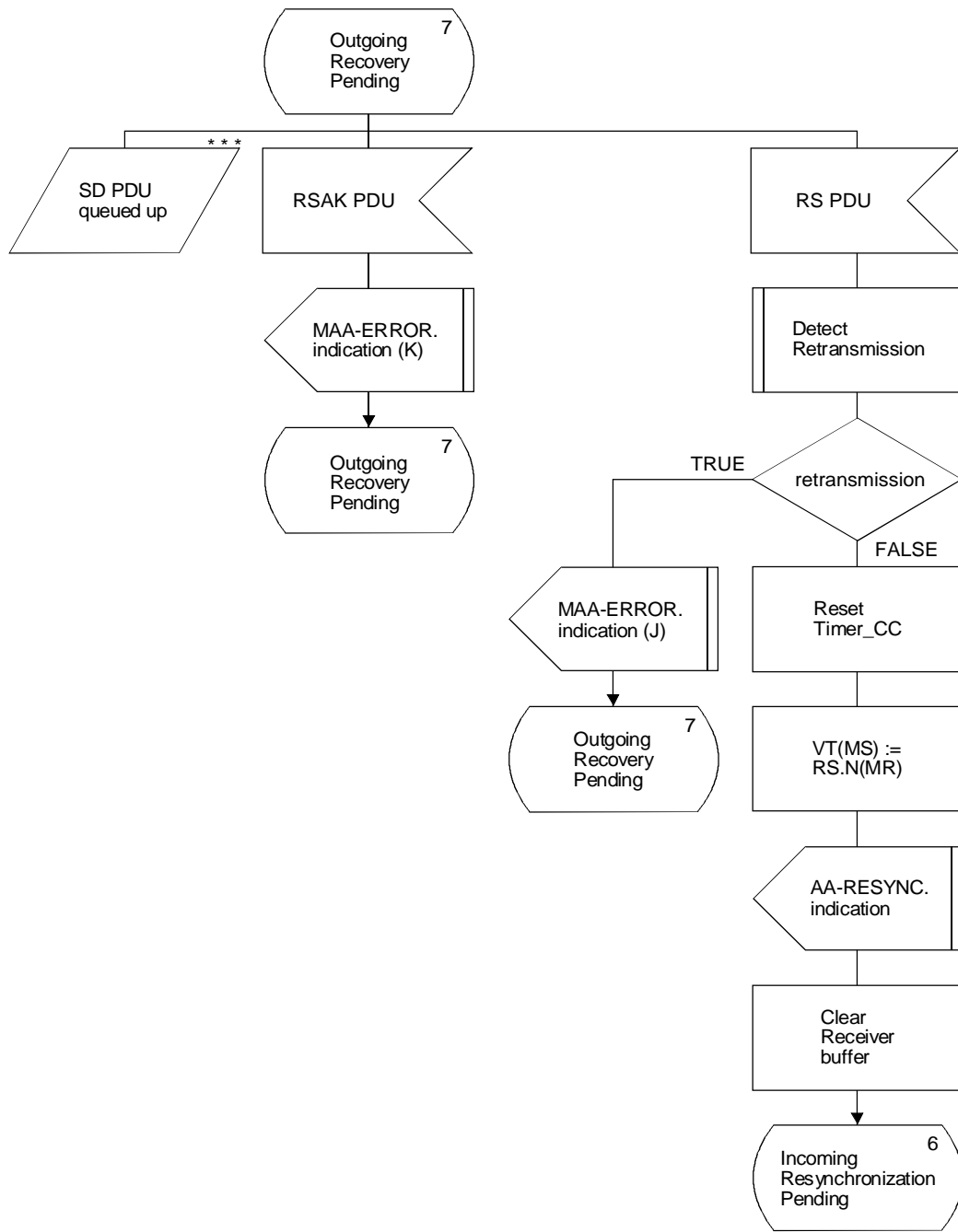

T1159700-94/d45

FIGURE 20 (sheet 26 of 51)

Process SSCOP

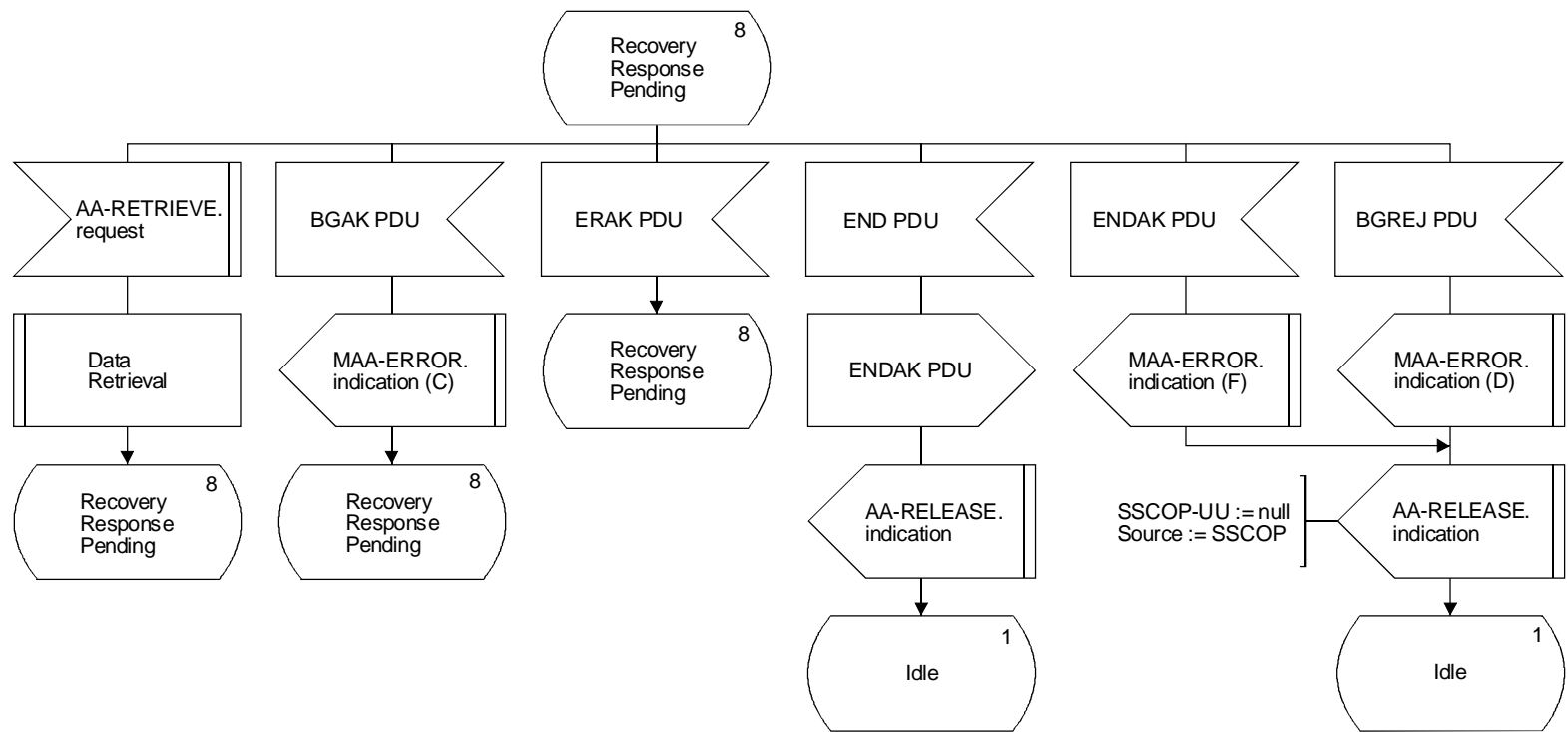

T1159710-94/d46

FIGURE 20 (sheet 27 of 51)
Process SSCOP

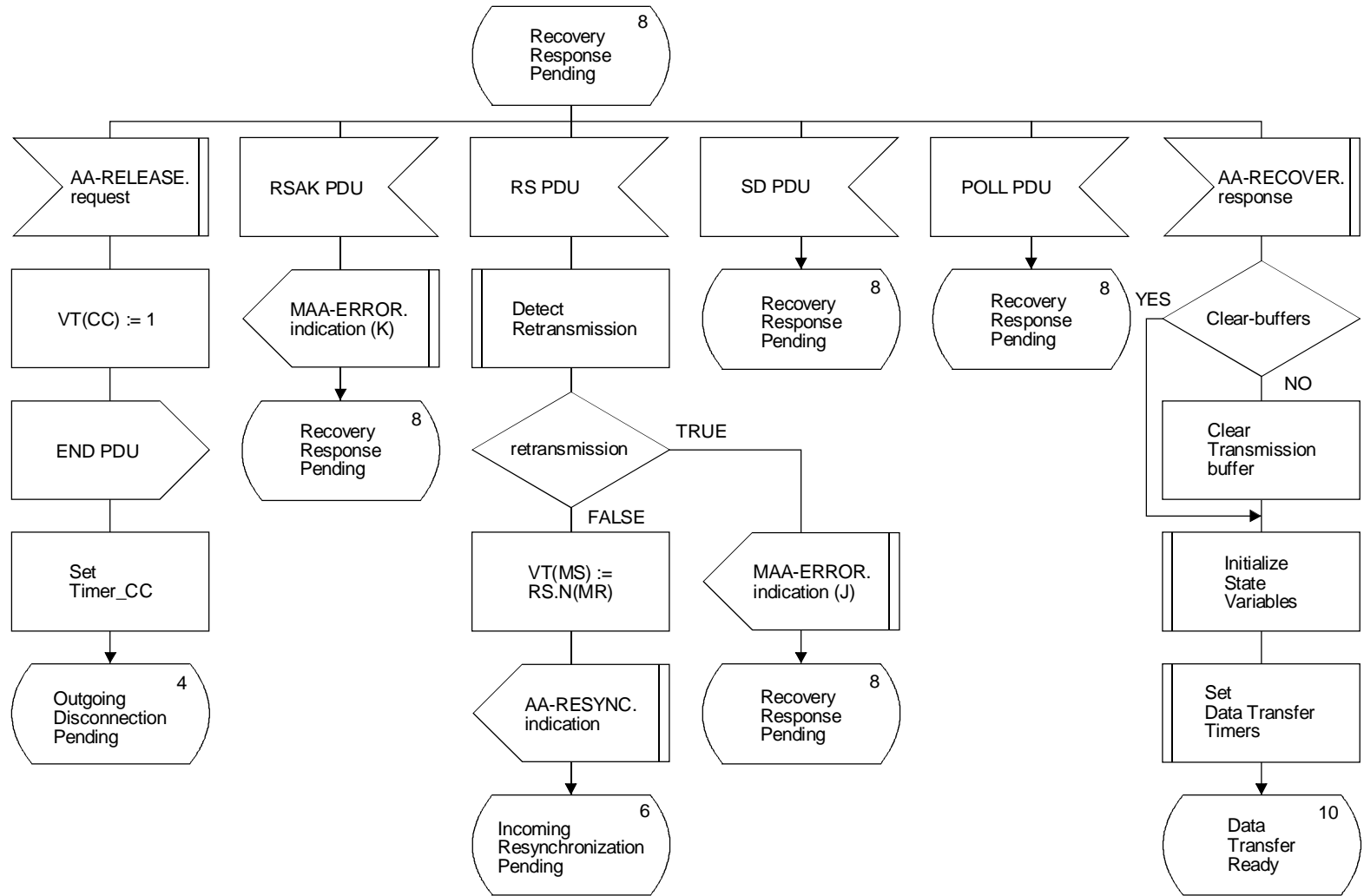

T1159720-94/d47

FIGURE 20 (sheet 28 of 51)

Process SSCOP

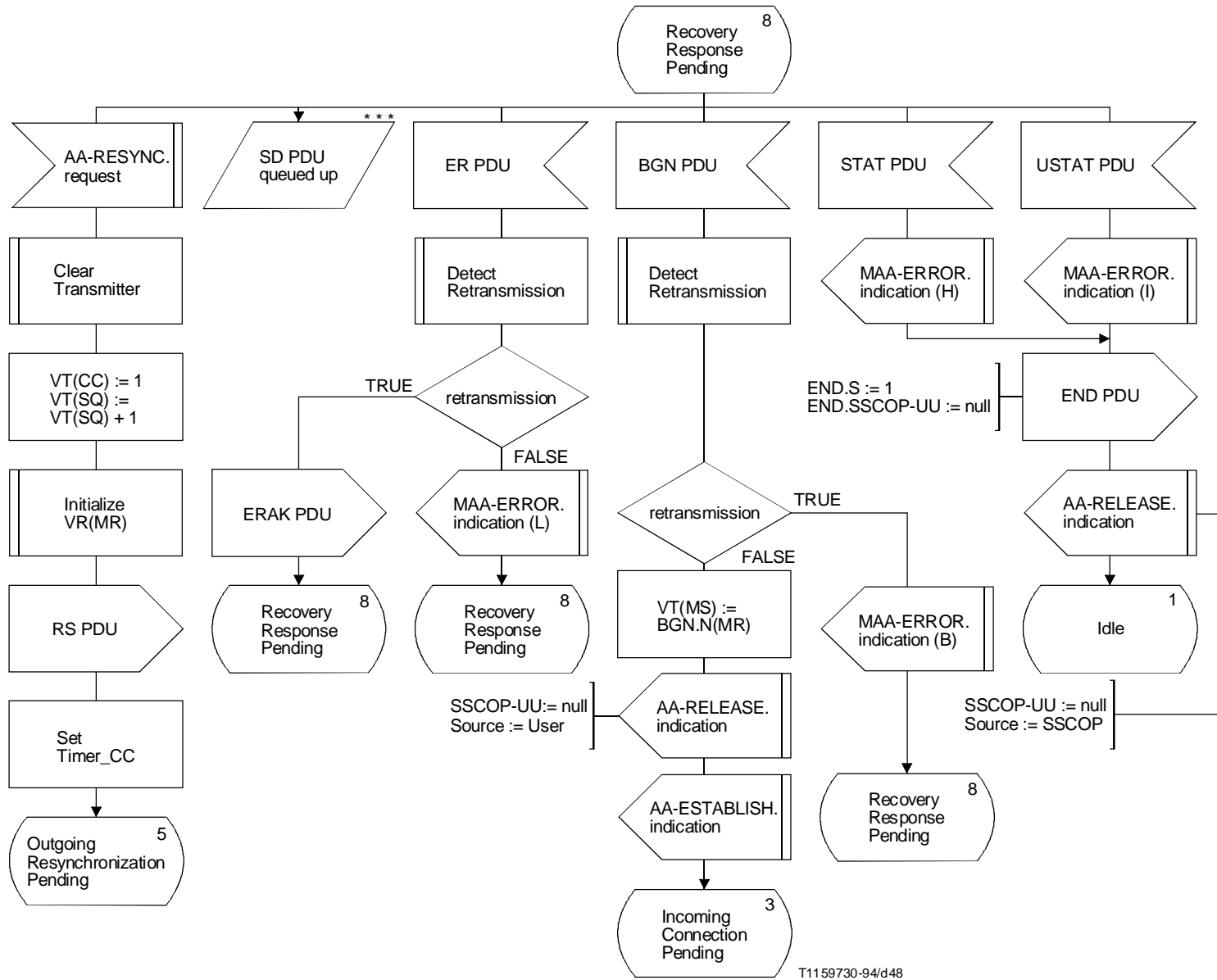

T1159730-94/d48

FIGURE 20 (sheet 29 of 51)

Process SSCOP

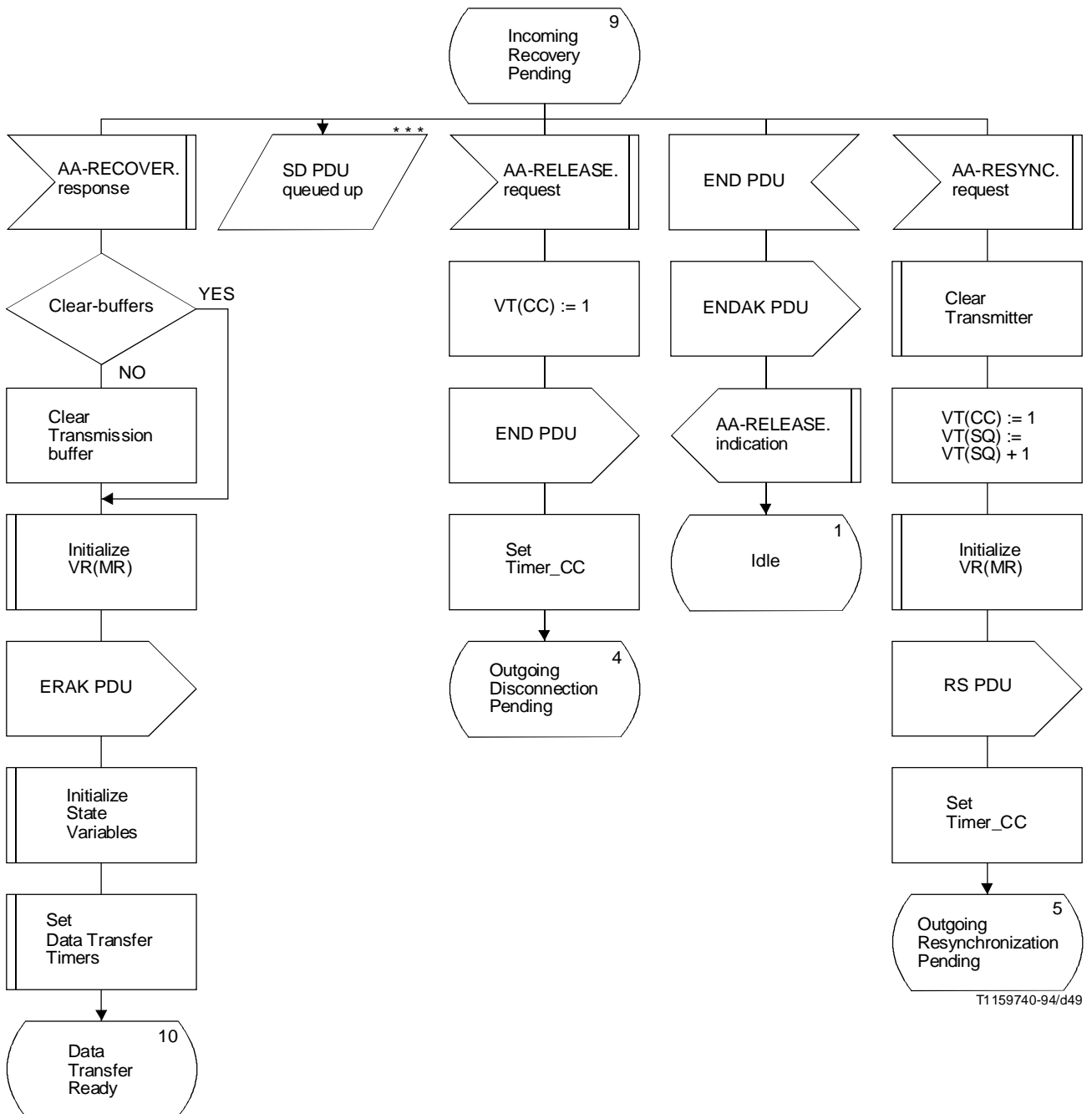

T1159740-94/d49

FIGURE 20 (sheet 30 of 51)
Process SSCOP

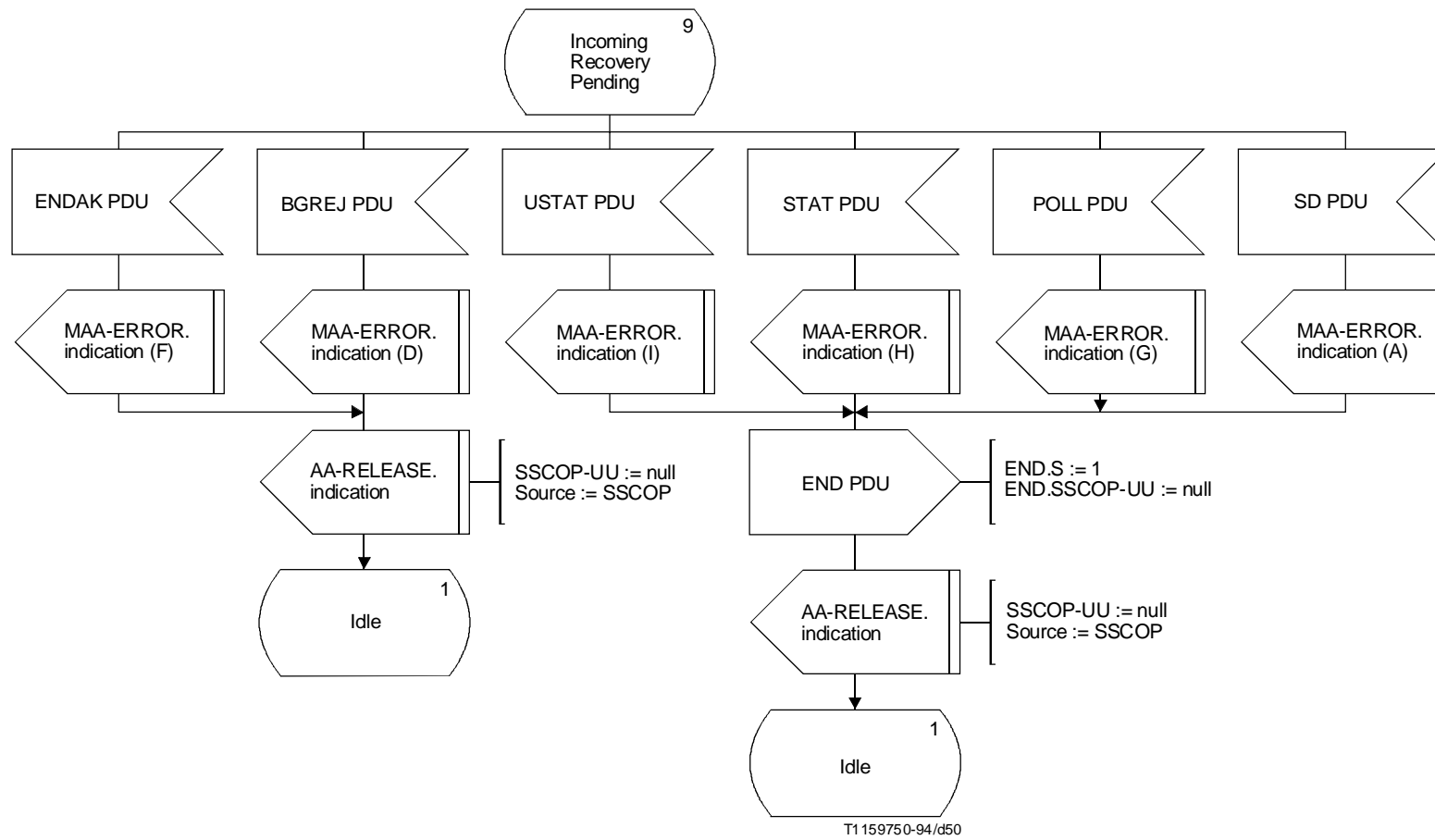

FIGURE 20 (sheet 31 of 51)
Process SSCOP

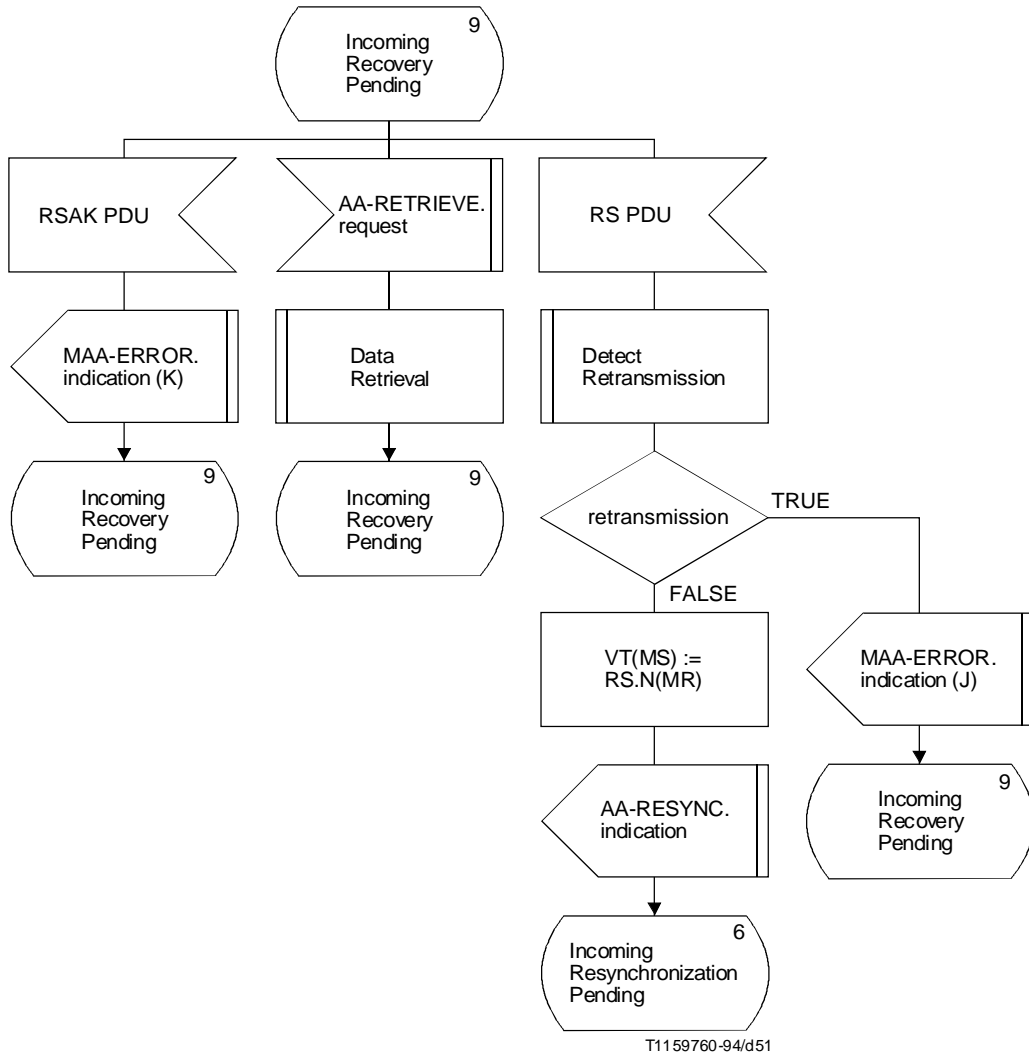

FIGURE 20 (sheet 32 of 51)
Process SSCOP

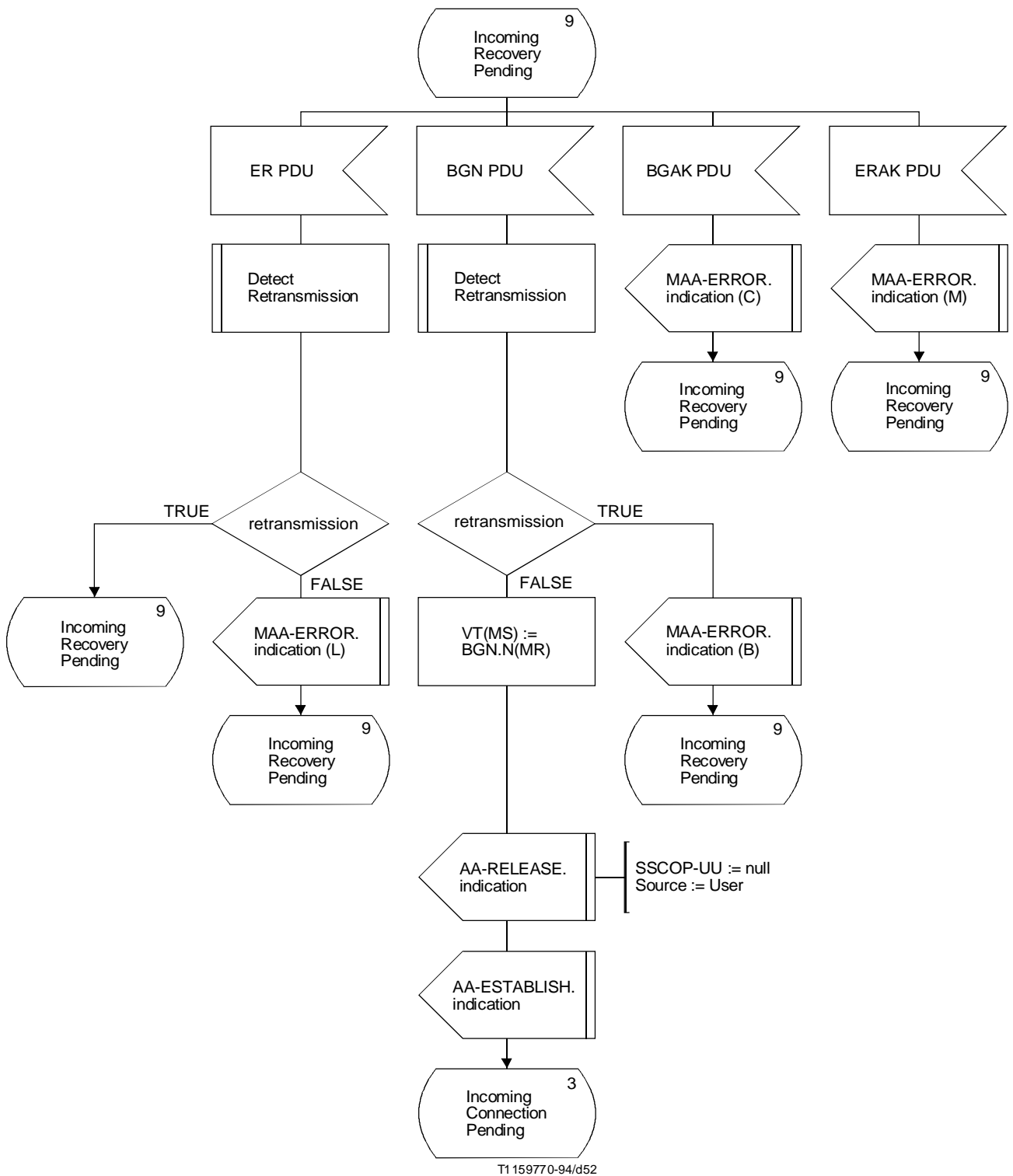

FIGURE 20 (sheet 33 of 51)
Process SSCOP

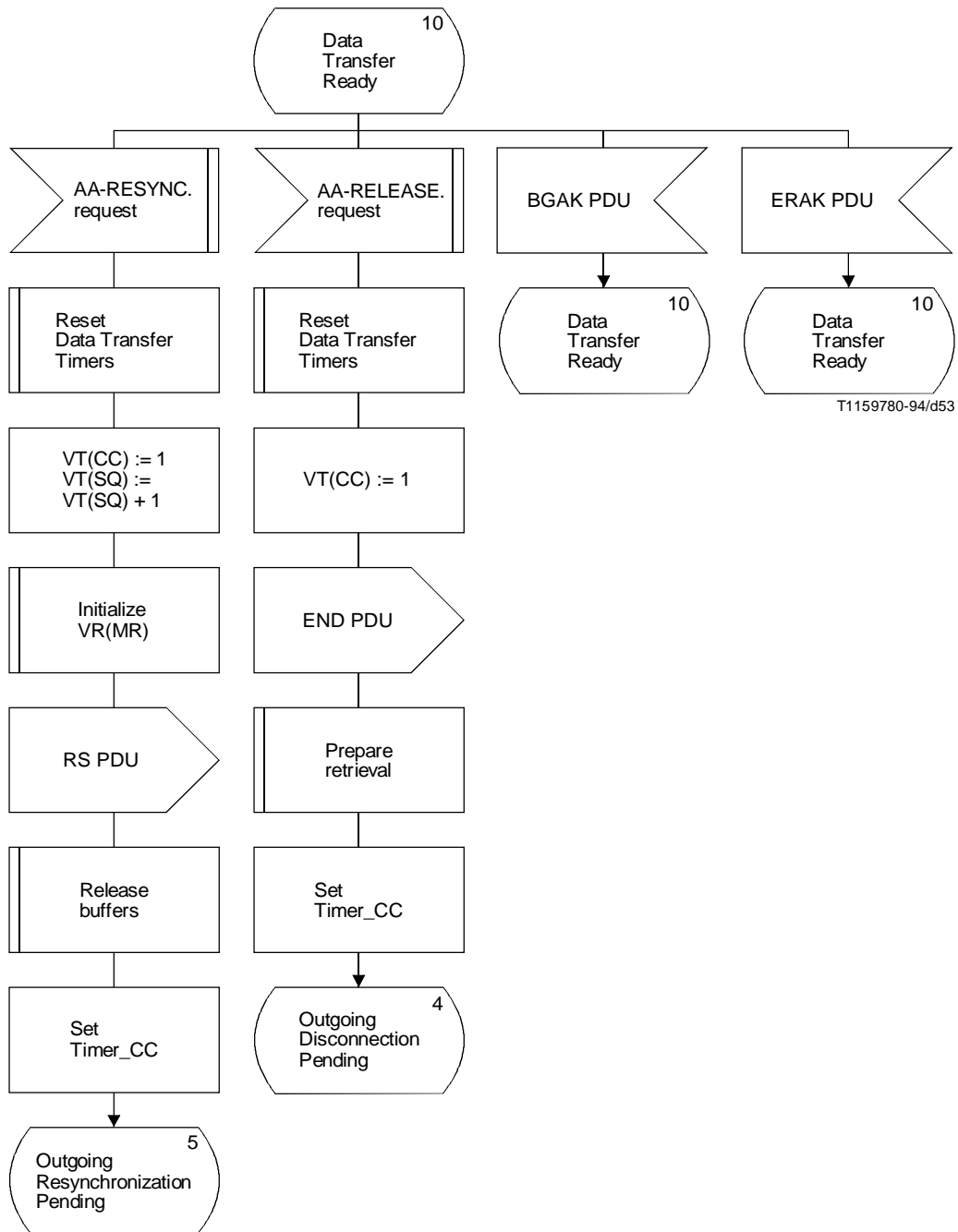

FIGURE 20 (sheet 34 of 51)

Process SSCOP

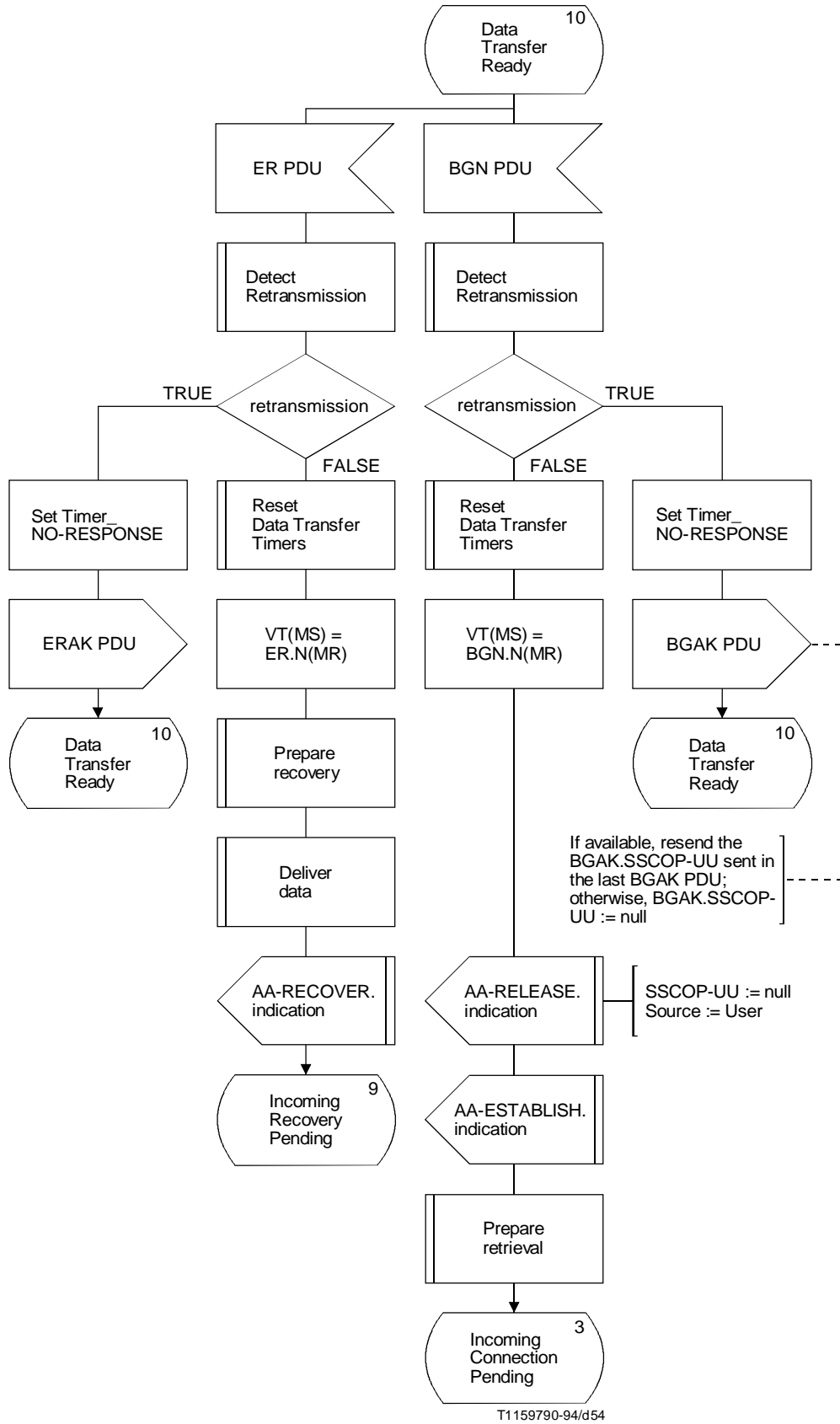

FIGURE 20 (sheet 35 of 51)
Process SSCOP

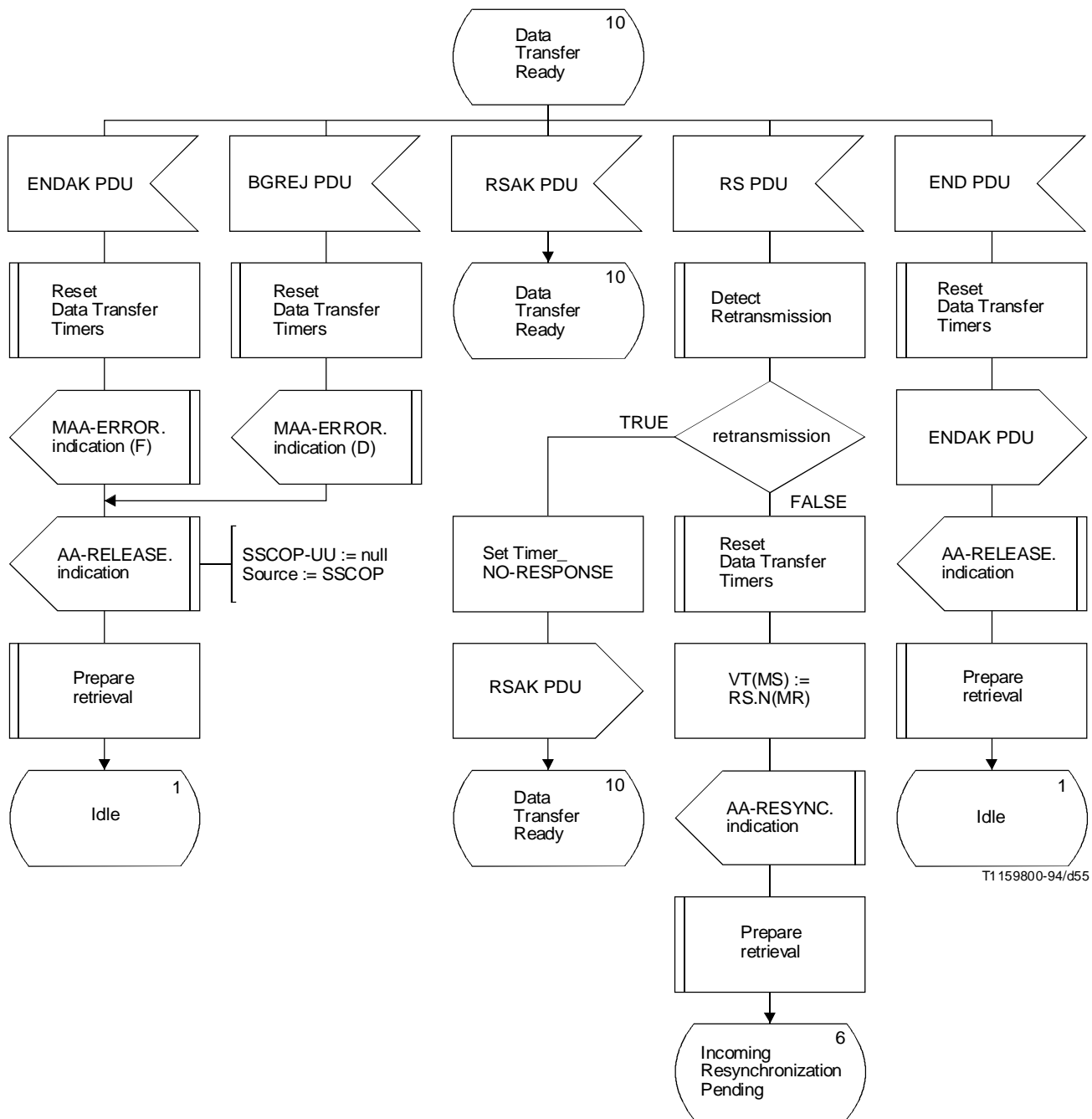

FIGURE 20 (sheet 36 of 51)

Process SSCOP

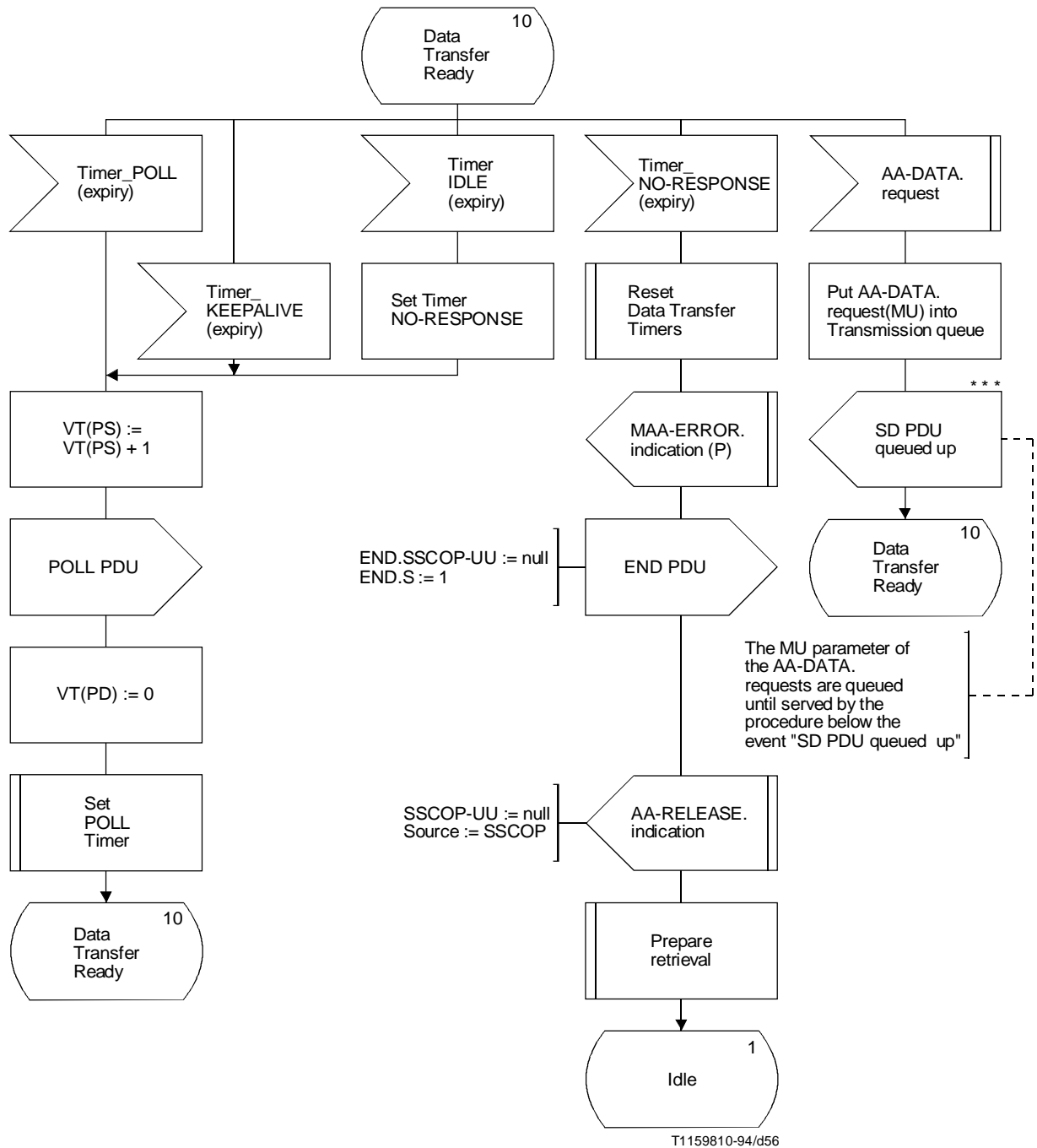

FIGURE 20 (sheet 37 of 51)
Process SSCOP

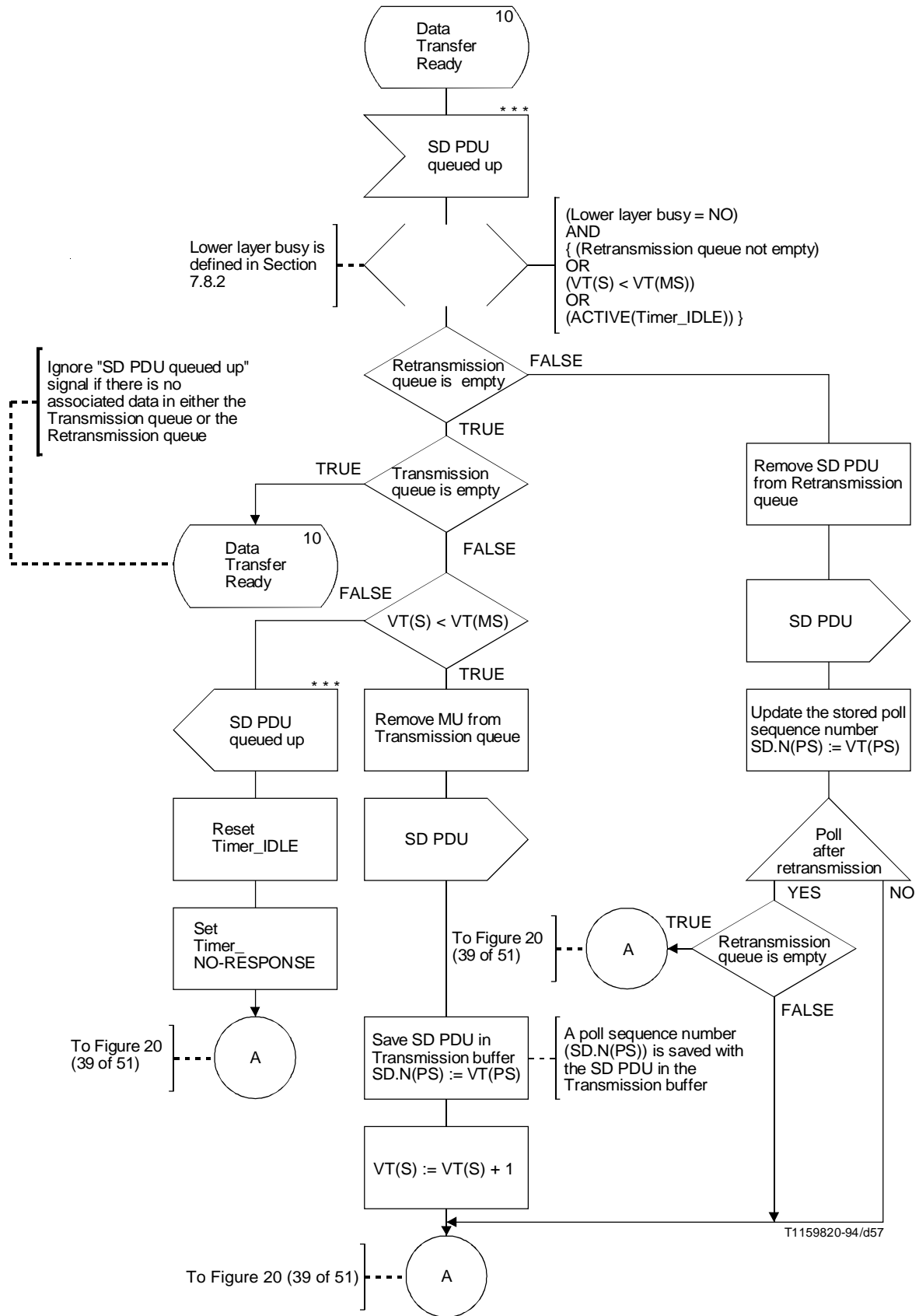
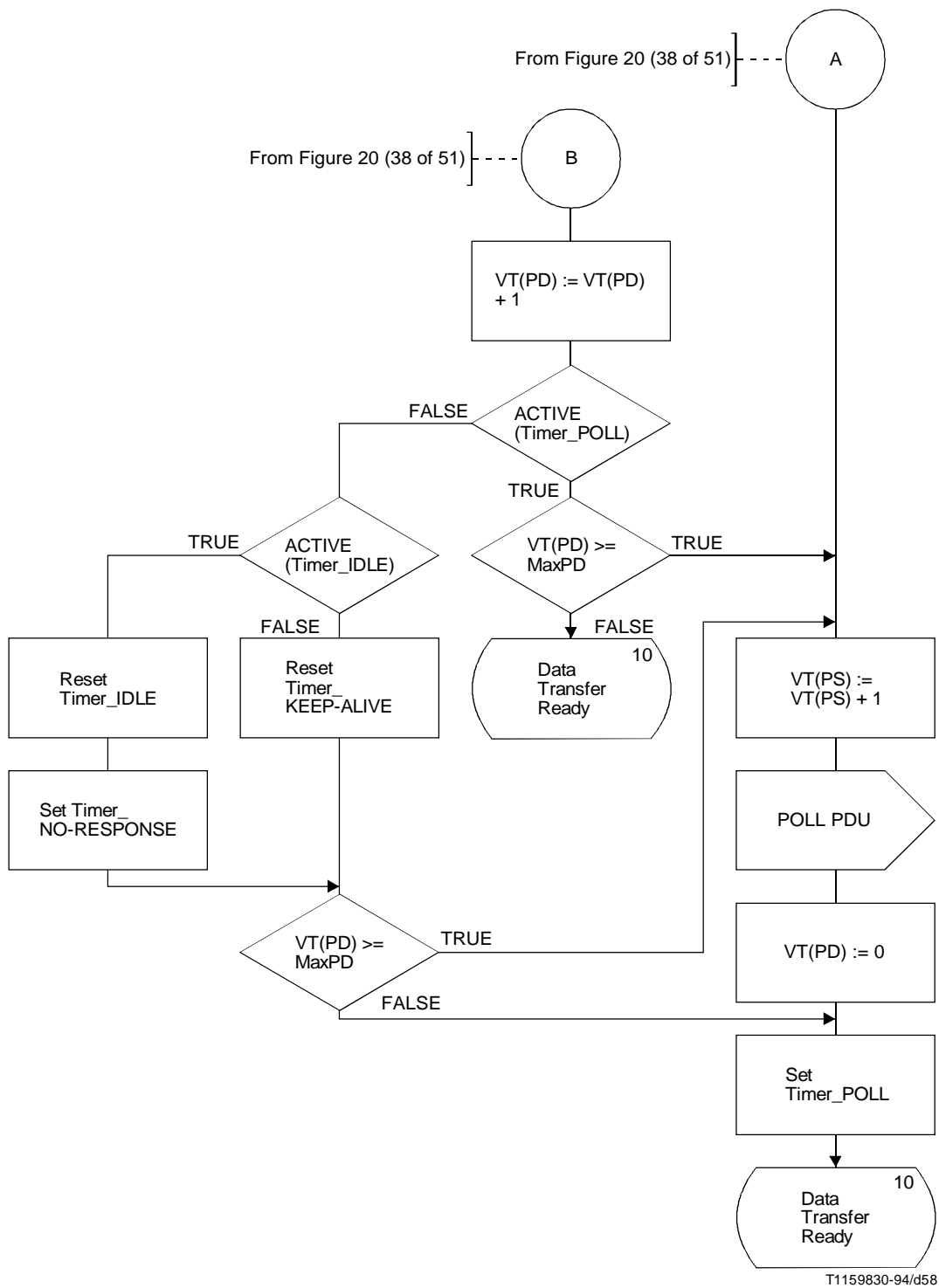

FIGURE 20 (sheet 38 of 51)

Process SSCOP



T1159830-94/d58

FIGURE 20 (sheet 39 of 51)
Process SSCOP

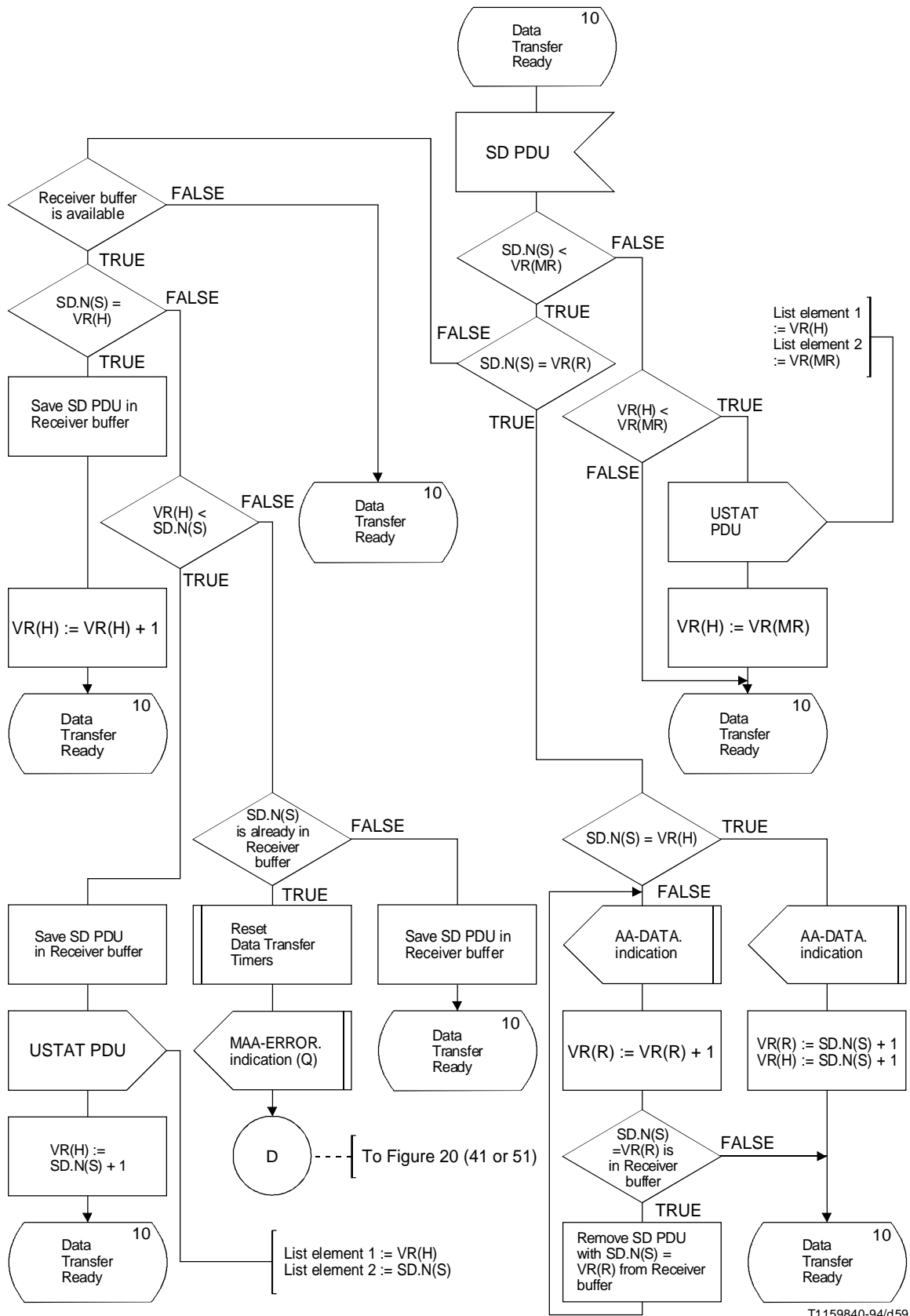

T1159840-94/d159

FIGURE 20 (sheet 40 of 51)

Process SSCOP

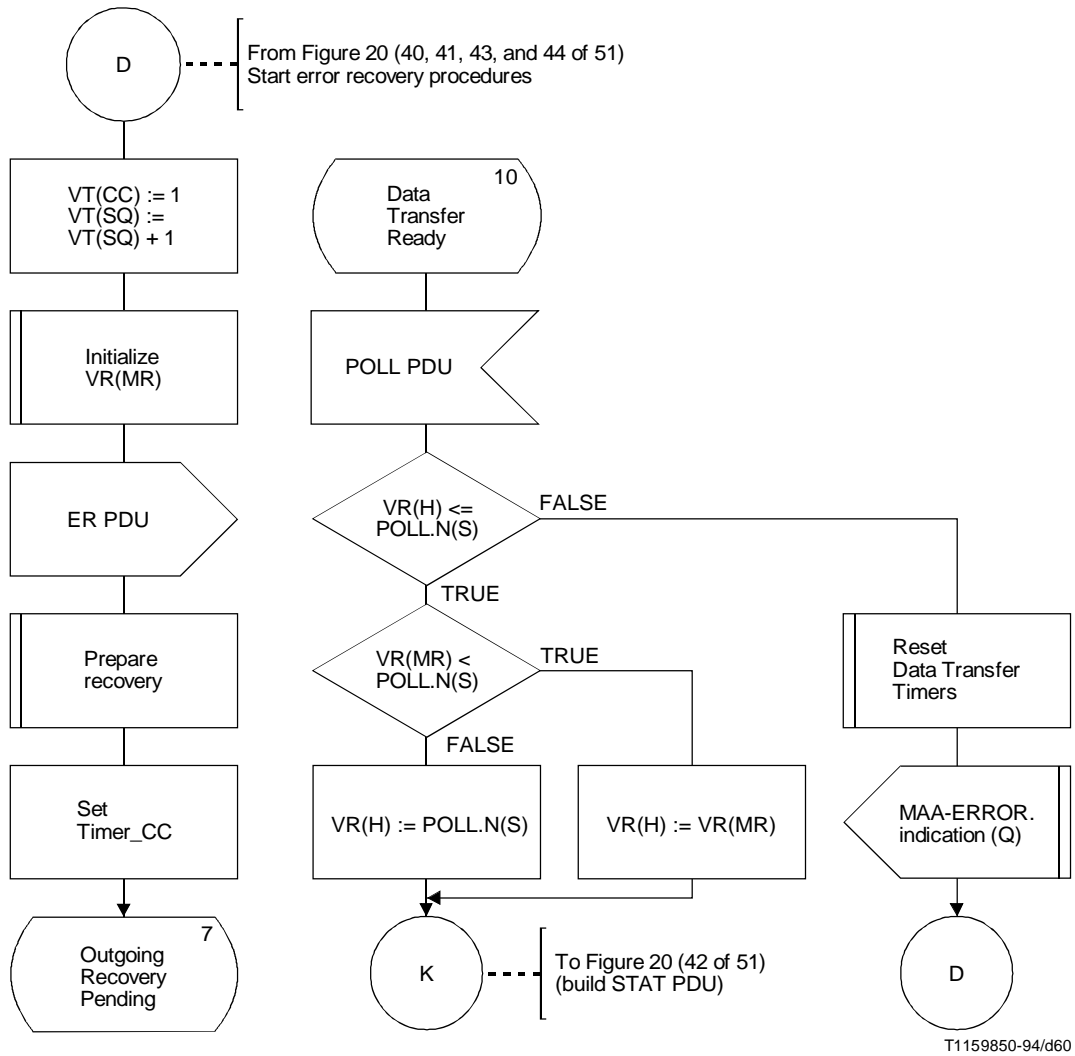

T1159850-94/d60

FIGURE 20 (sheet 41 of 51)

Process SSCOP

From Figure 20 (41 of 51)

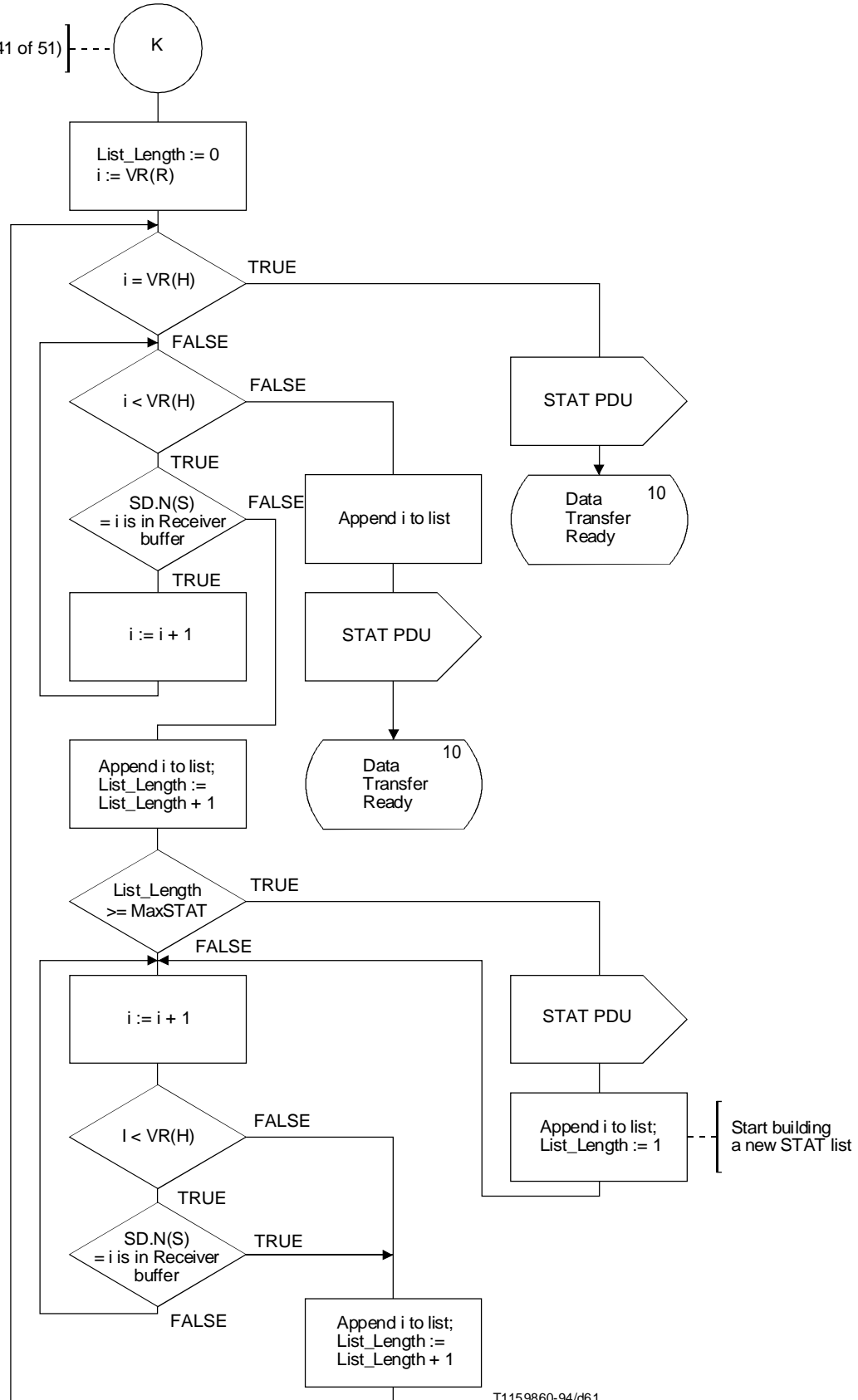

T1159860-94/d61

FIGURE 20 (sheet 42 of 51)
Process SSCOP

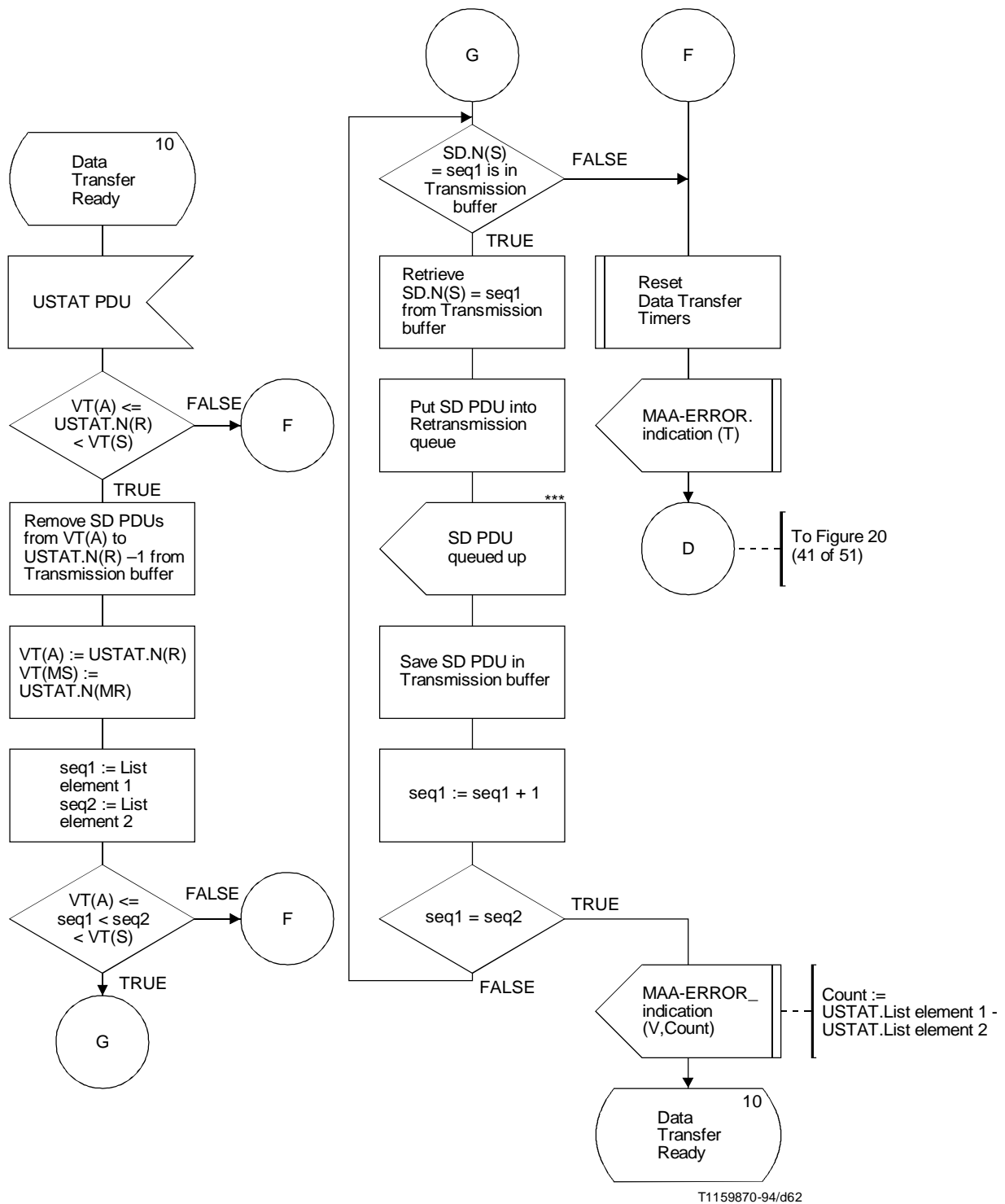

FIGURE 20 (sheet 43 of 51)
Process SSCOP

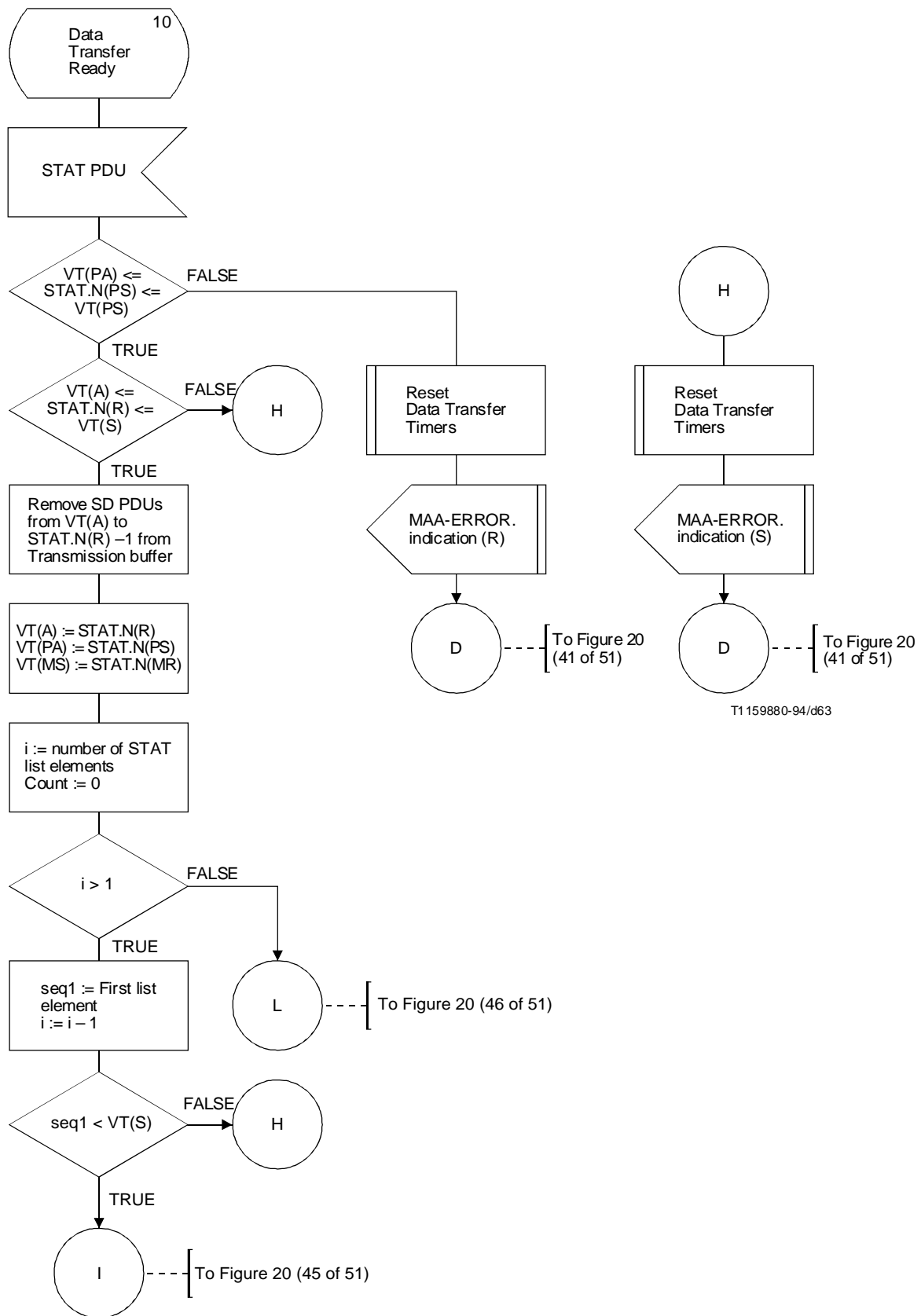

FIGURE 20 (sheet 44 of 51)
Process SSCOP

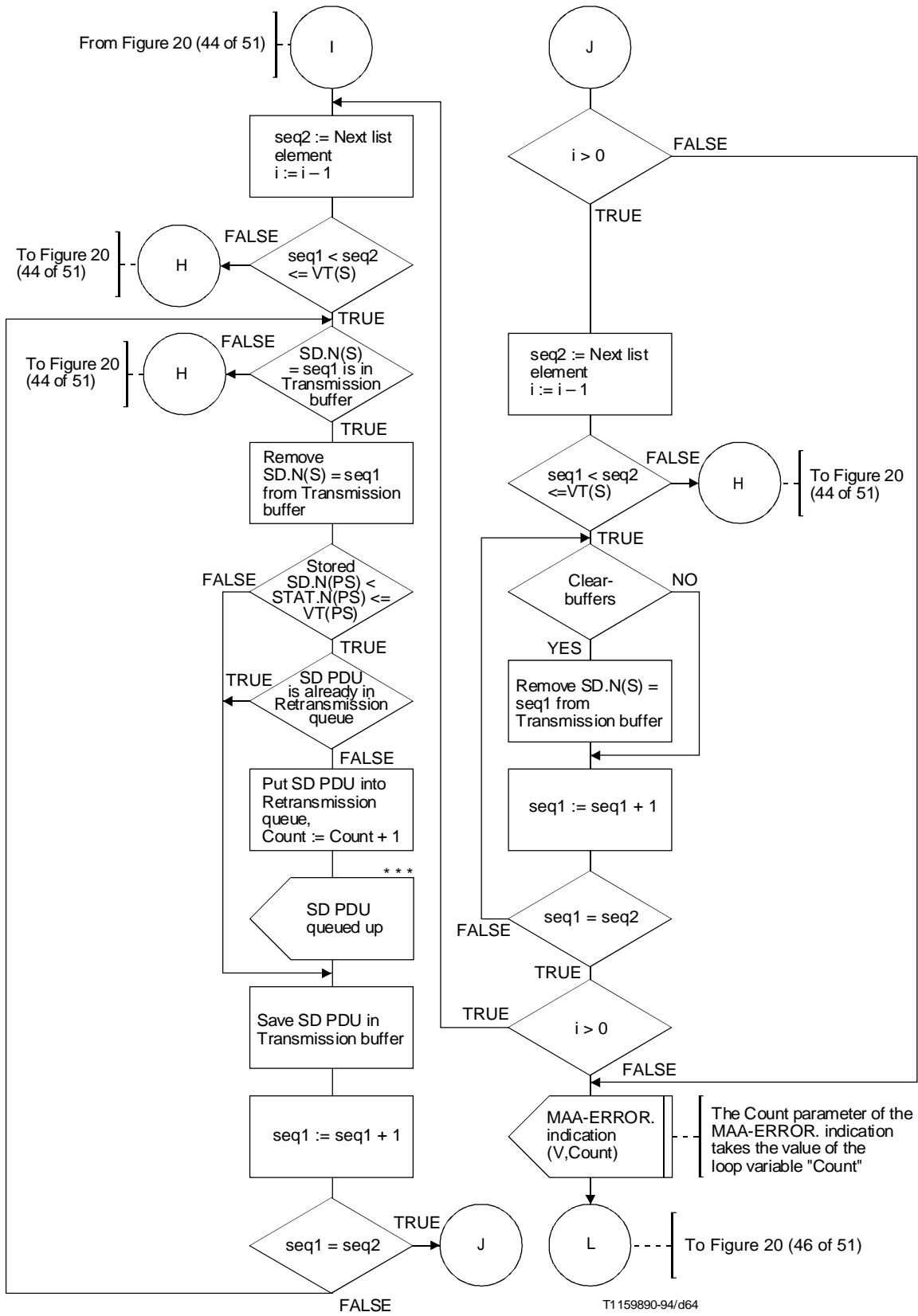
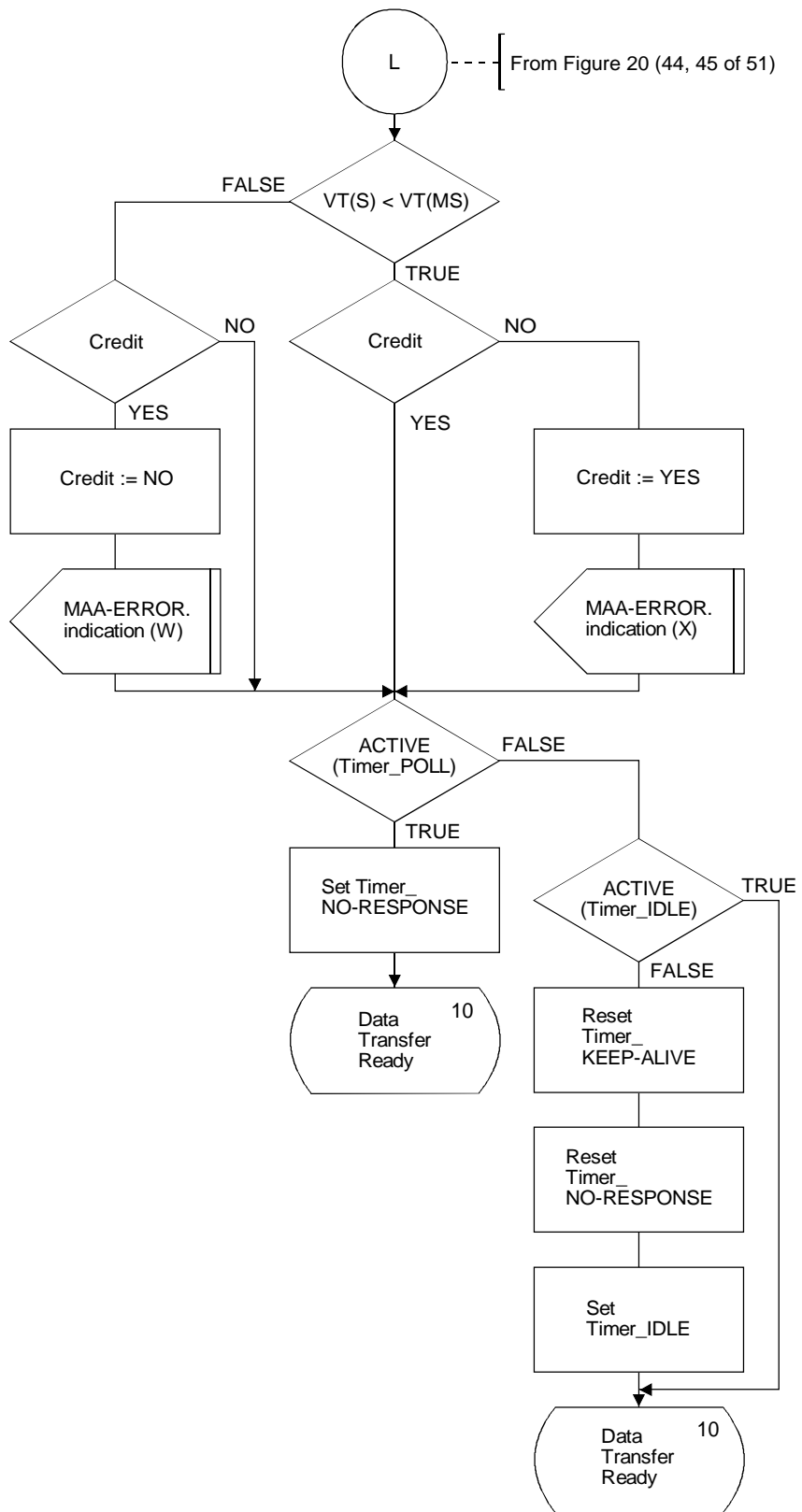

FIGURE 20 (sheet 45 of 51)

Process SSCOP



T1159900-94/d65

FIGURE 20 (sheet 46 of 51)

Process SSCOP

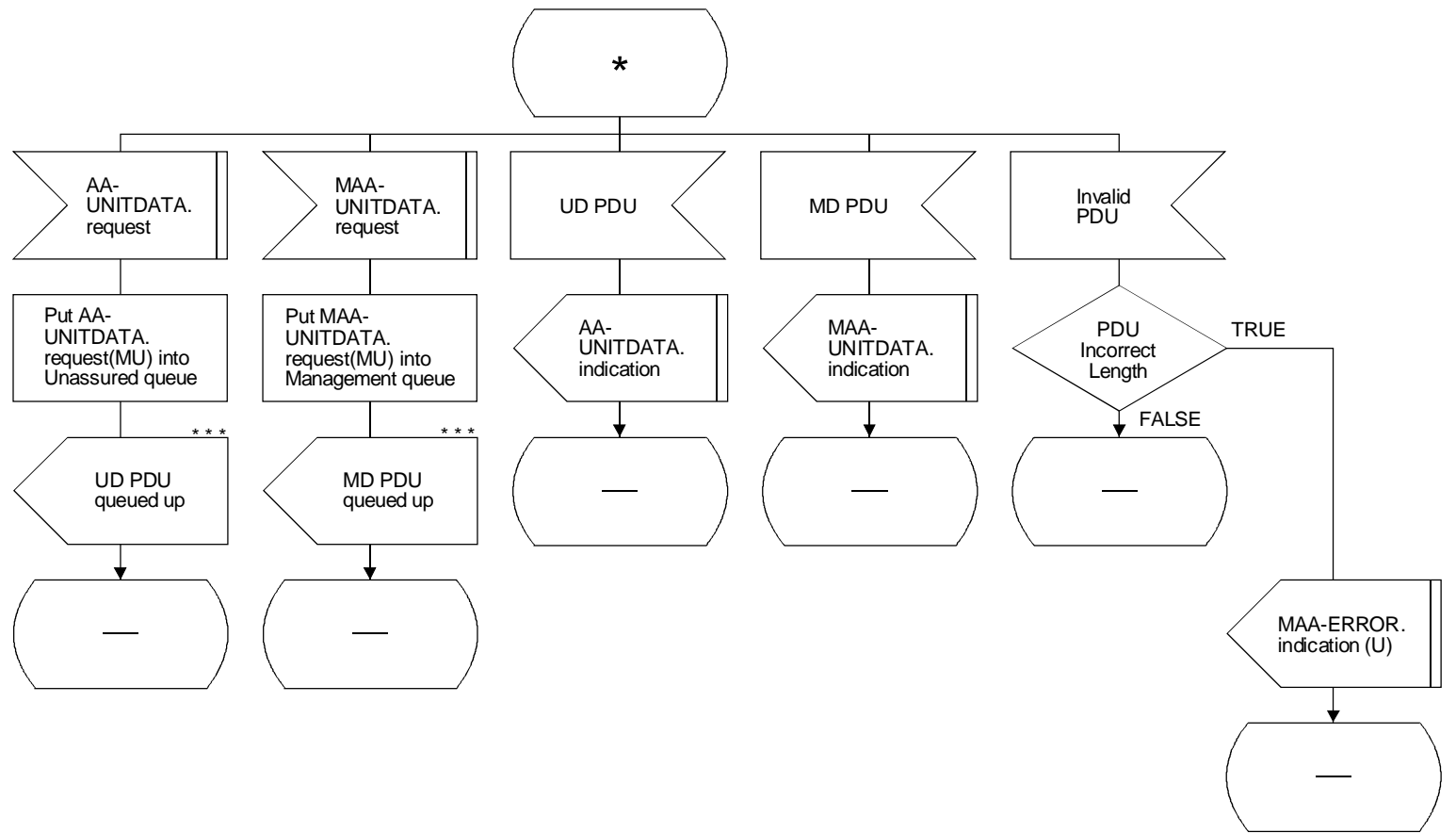

T1159910-94/d66

FIGURE 20 (sheet 47 of 51)

Process SSCOP

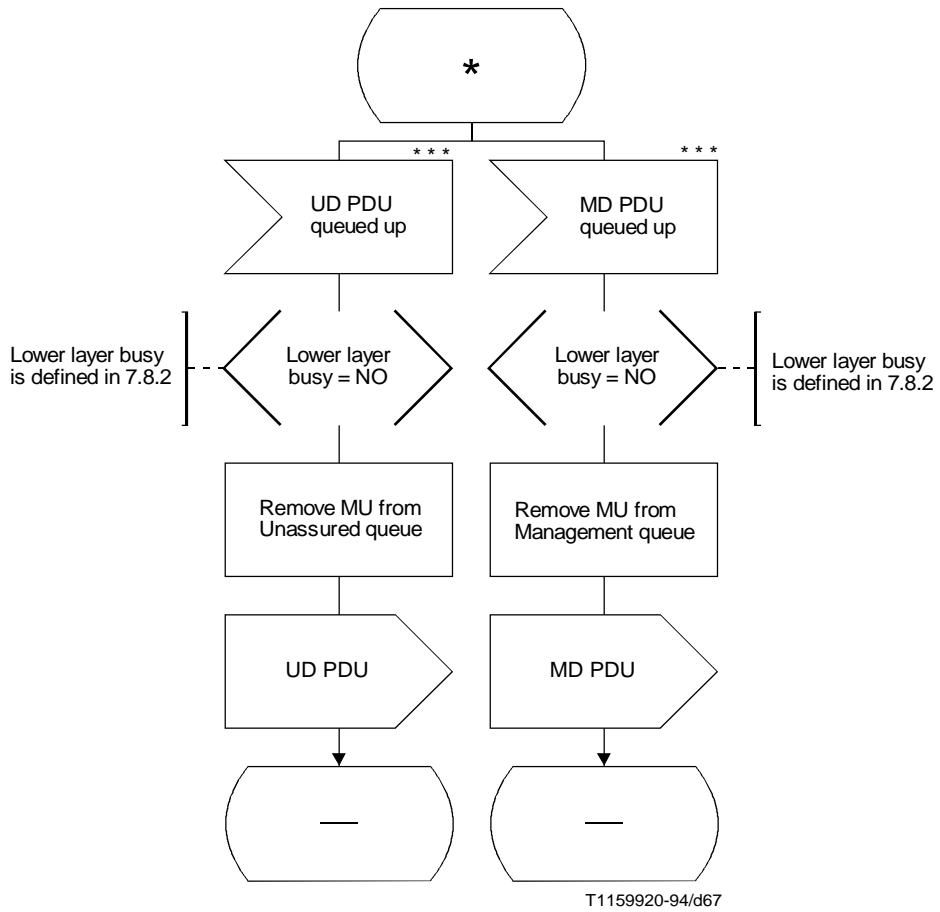
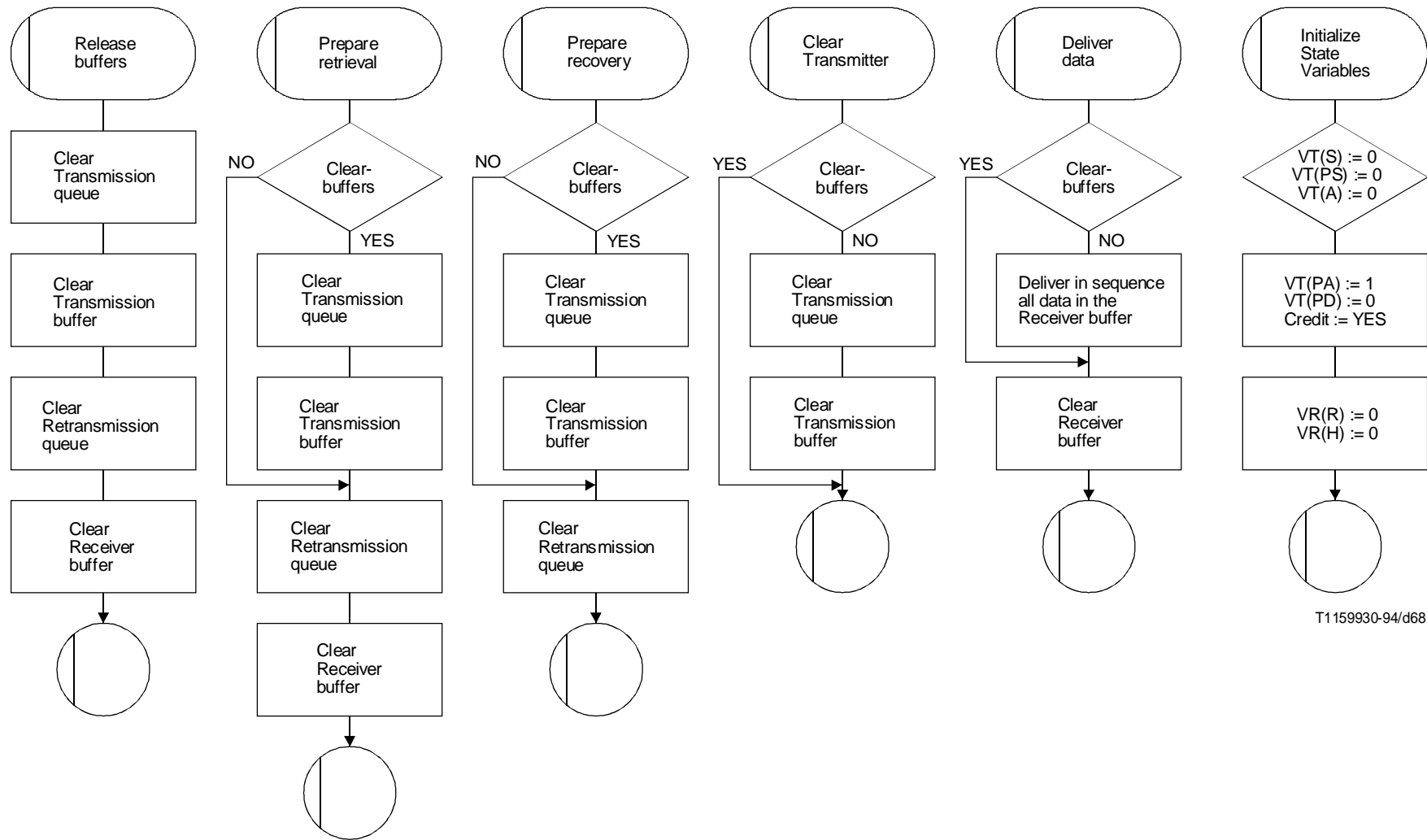

FIGURE 20 (sheet 48 of 51)

Process SSCOP



T1159930-94/d68

FIGURE 20 (sheet 49 of 51)
Process SSCOP

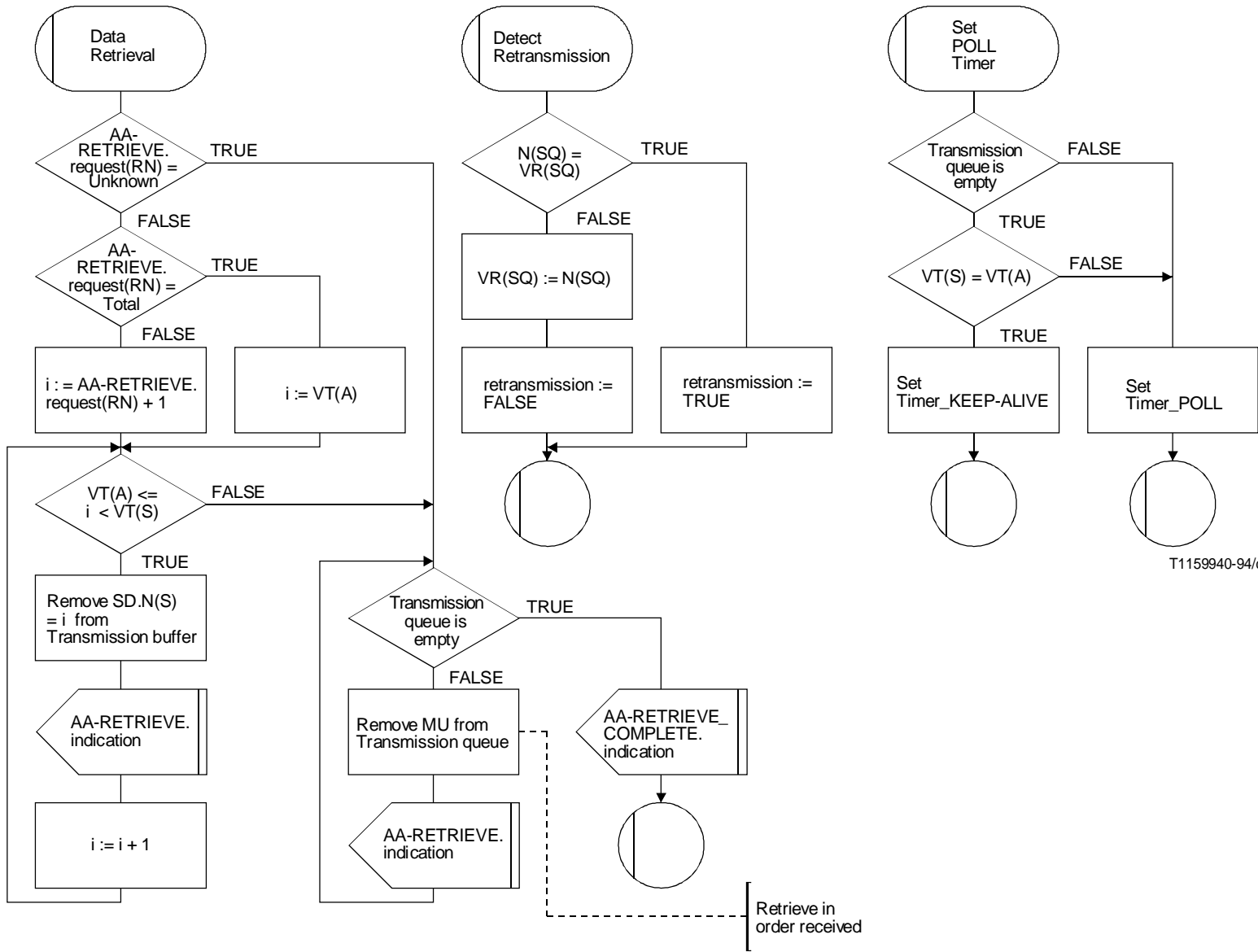

T1159940-94/d69

FIGURE 20 (sheet 50 of 51)

Process SSCOP

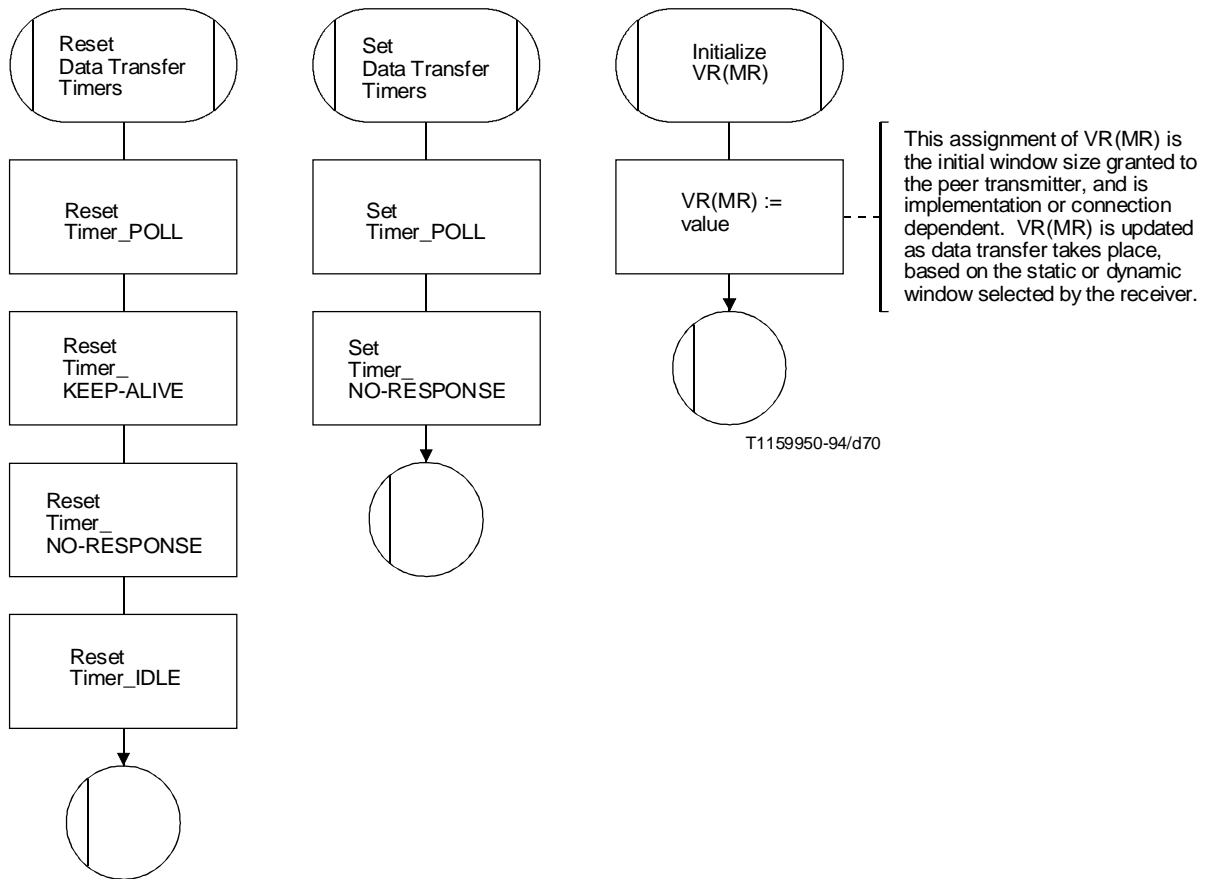

FIGURE 20 (sheet 51 of 51)

Process SSCOP

Annex A

Management error indications

(This annex forms an integral part of this Recommendation)

A number of events will cause errors to be indicated to the layer management entity. The associated error parameter contains the error code that describes the specific error conditions.

The column entitled “Error condition” together with the “Affected states” describes specific protocol error events and the basic state of the SSCOP entity at the point that the MAA-ERROR indication primitive is generated (see Table A.1).

TABLE A.1/Q.2110

Error Type	Error Code	Error Condition	Affected States
Receipt of unsolicited or inappropriate PDU	A	SD PDU	1, 3, 6, 9
	B	BGN PDU	6, 7, 8, 9
	C	BGAK PDU	1, 3, 6, 7, 8, 9
	D	BGREJ PDU	1, 3, 5, 6, 7, 8, 9, 10
	E	END PDU	None
	F	ENDAK PDU	3, 5, 6, 7, 8, 9, 10
	G	POLL PDU	1, 3, 6, 9
	H	STAT PDU	1, 3, 6, 8, 9
	I	USTAT PDU	1, 3, 6, 8, 9
	J	RS	1, 3, 6, 7, 8, 9
	K	RSAK PDU	1, 3, 6, 7, 8, 9
	L	ER	1, 3, 6, 7, 8, 9
	M	ERAK	1, 3, 6, 9
Unsuccessful retransmission	O	VT(CC) >= MaxCC	2, 4, 5, 7
	P	Timer_NO_RESPONSE expiry	10
Other list elements error type	Q	SD or POLL, N(S) error	10
	R	STAT N(PS) error	10
	S	STAT N(R) or list elements error	10
	T	USTAT N(R) or list elements error	10
	U	PDU length violation	ALL
SD loss	V	SD PDUs must be retransmitted	10
Credit Condition	W	Lack of credit	10
	X	Credit obtained	10

Annex B

Protocol implementation conformance statement (PICS) proforma to Recommendation Q.2110¹⁾

(This annex forms an integral part of this Recommendation)

B.1 General

The supplier of a protocol implementation claiming to conform to this Recommendation, shall complete the following Protocol Implementation Conformance Statement (PICS) proforma and accompany it by the information necessary to identify fully both the supplier and the implementation. This PICS proforma applies to the B-ISDN interfaces.

The PICS is a document specifying the capabilities and options which have been implemented, and any features which have been omitted, so that the implementation can be tested for conformance against relevant requirements, and against those requirements only.

This PICS has several uses, the most important are the static conformance review and test case selection in order to identify which conformance tests are applicable to this product.

The PICS proforma is a document, in the form of a questionnaire, normally designed by the protocol specifier or conformance test suite specifier which, when completed for an implementation or system, becomes the PICS.

Subclause B.5 covers the SSCOP Q.2110 Protocol Capabilities, Protocol Data Units, and System Parameters.

NOTE – The SSCOP can be combined with different Service Specific Coordination Functions (SSCFs) to offer different AAL services. As a result, the SSCOP specification defines mandatory functions for a general protocol. Some of these functions may not be needed by a particular service and may be masked from the AAL user by an SSCF. It is possible for an implementation not to implement a certain SSCOP function and still meet the mandatory requirements of certain AAL services (e.g. the SSCOP local data retrieval function is not needed to support B-ISDN UNI signalling). Implementors can refer to the PICS proforma for a particular SSCF, if they are only concerned about providing that service. However, the absence of a mandatory SSCOP function may preclude the possibility of combining the SSCOP implementation with other SSCFs to offer different AAL services.

B.2 Abbreviations and special symbols

CPE	Customer Premises Equipment
IUT	Implementation Under Test
M	Mandatory
N/A	Not Applicable
O	Optional
O.<n>	Optional, but, if chosen, support is required for either at least one or only one of the options in the group labelled by the same numeral <n>
P	Prohibited
PC	Prefix for the Index number of the Protocol Capabilities Group
PD	Prefix for the Index number of the Protocol Data Units Group
PICS	Protocol Implementation Conformance Statement
PIXIT	Protocol Implementation Extra Information for Testing
S.<i>	Supplementary Information number i
SP	Prefix for the Index number of the System Parameter Group
X.<i>	Exceptional Information number i

B.3 Instructions for completing the PICS proforma

The main part of the PICS proforma is a fixed-format questionnaire, divided into three sections. Answers to the questionnaire are to be provided in the right most column, either by simply marking an answer to indicate a restricted choice (such as Yes or No), or by entering a value or a set or range of values.

¹⁾ Copyright release for PICS proformas:

Users of this Recommendation may freely reproduce the PICS proforma in this Recommendation, so that it may be used for its intended purpose and may further publish the completed PICS.

A supplier may also provide additional information, categorized as either Exceptional Information or Supplementary Information (other than PIXIT). When present, each kind of additional information is to be provided as items labelled X.<i> or S.<i> respectively for cross-reference purposes, where <i> is any unambiguous identification for the item. An exception item should contain the appropriate rationale. The Supplementary Information is not mandatory and the PICS is complete without such information. The presence of optional supplementary or exceptional information should not affect test execution, and will in no way affect static conformance verification.

NOTE – Where an implementation is capable of being configured in more than one way, a single PICS may be able to describe all such configurations. However, the supplier has the choice of providing more than one PICS, each covering some subset of the implementation’s configuration capabilities, in case this makes for easier or clearer presentation of the information.

B.4 Global statement of conformance

Global statement: The implementation specified in this PICS meets all the mandatory requirements of the referenced standards:

Yes/No

NOTE – Answering “No” to this question indicates non-conformance to this Recommendation. Non-supported mandatory capabilities are to be listed in the PICS below, with an explanation for the abnormal status of the implementation.

The supplier will have fully complied with the requirements for a statement of conformance by completing the statement contained in this subclause. However, the supplier may find it helpful to continue to complete the detailed tabulations in the subclauses which follow.

B.5 SSCOP – Q.2110

B.5.1 Protocol Capabilities (PC) – SSCOP

See Table B.1.

TABLE B.1/Q.2110

ITEM #	Protocol Feature	Status	Reference	Support
PC1	Does IUT support Keep Alive function?	M	5.0 e)	Yes: __No: __X: __
PC2	Does IUT support the Local Data Retrieve function?	M	5.0 f)	Yes: __No: __X: __
PC3	Does the IUT support SSCOP initiated error recovery due to protocol error?	M	5.0 i)	Yes: __No: __X: __
PC4	Does the IUT recognize all of the Messages regardless of state?	M	Table 2	Yes: __No: __X: __
PC5.1	In the absence of protocol error, does the IUT support assured data transfer with sequence integrity?	M	5.0 a) h); 7.1 j)	Yes: __No: __X: __
PC5.2	Does IUT support the sending of the Unassured Data PDU?	M	5.0 h); 7.1 n)	Yes: __No: __X: __
PC5.3	Does IUT support the sending of the Management Data PDU?	M	7.1 o)	Yes: __No: __X: __
PC6	Does IUT support user invoked re-synchronization procedures?	M	5.0 g)	Yes: __No: __X: __
PC7	Does IUT support the establishment procedures for an SSCOP connection?	M	5.0 g)	Yes: __No: __X: __
PC8	Does IUT support release procedures for an SSCOP connection?	M	5.0 g)	Yes: __No: __X: __
PC9	Does IUT support polling after retransmission?	O	SDL	Yes: __No: __X: __
PC10	Does IUT support the segmenting of STAT PDUs?	M	7.2.5	Yes: __No: __X: __
PC11	Can the IUT initiate SSCOP connection?	M	5.0 g)	Yes: __No: __X: __
PC12	Can the IUT reject (BGREJ) the establishment of an SSCOP connection from its peer?	M	SDL	Yes: __No: __X: __
PC13	Does IUT support error reporting to layer management?	M	5.0 d)	Yes: __No: __X: __
PC14	Does IUT support the Protocol error detection function?	M	5.0 i)	Yes: __No: __X: __
PC15	When no SSCOP connection exists, is a connection established only upon receipt of a BGN or a request from the SSCOP user?	M	SDL	Yes: __No: __X: __
PC16	Does SSCOP permit the conveyance of SSCOP User-to-User Information between users of the SSCOP?	M	5.0 g); 6.1.2 b)	Yes: __No: __X: __

B.5.2 SSCOP PDUs – Protocol Data Units (PD)

See Table B.2.

TABLE B.2/Q.2110

ITEM #	Protocol Feature	Status	Reference	Support
Order of Octet Transmission				
PD1	Ascending numerical order	M	7.2.1	Yes: __No: __X: __
Field Mapping Convention				
PD2	Lowest bit number = Lowest order value	M	7.2.1	Yes: __No: __X: __
PD3	Are PDU formats 32 bit aligned?	M	7.2	Yes: __No: __X: __
PD4	Are all reserved bits coded as zeros?	M	7.2.3	Yes: __No: __X: __

B.5.3 SSCOP System Parameters (SP)

See Table B.3.

TABLE B.3/Q.2110

ITEM #	Protocol Feature	Status	Reference	Support
SP1	Maximum number of transmissions of a BGN, END, ER, or RS PDU (MaxCC)	M	7.7 a)	Yes: __No: __X: __ Value: _
SP2	Maximum number of SD PDUs before transmission of a POLL PDU (MaxPD)	M	7.7 b)	Yes: __No: __X: __ Value: _
SP3	Maximum number of List Elements in a STAT (MaxSTAT)?	M	7.7 c)	Yes: __No: __X: __ Value: _
SP4	Maximum PDU size	M	7.2.4	Yes: __No: __X: __ Value: _
SP5	Timer_POLL	M	7.6 a)	Yes: __No: __X: __ Value: _
SP6	Timer_KEEP-ALIVE	M	7.6 b)	Yes: __No: __X: __ Value: _
SP7	Timer_NO-RESPONSE	M	7.6 c)	Yes: __No: __X: __ Value: _
SP8	Timer_IDLE	M	7.6 c)	Yes: __No: __X: __ Value: _
SP9	Timer_CC	M	7.6 d)	Yes: __No: __X: __ Value: _
SP10	If PC16 is supported, what is the maximum size of the SSCOP-UU?	M	6.1.2 b); 7.2.4	Yes: __No: __X: __ Value: _

Appendix I

Concepts and terminology

(This appendix does not form an integral part of this Recommendation)

The basic structuring technique in the OSI reference model is layering. According to this technique, communication among application processes is viewed as being logically partitioned into an ordered set of layers represented in a vertical sequence as shown in Figure I.1.

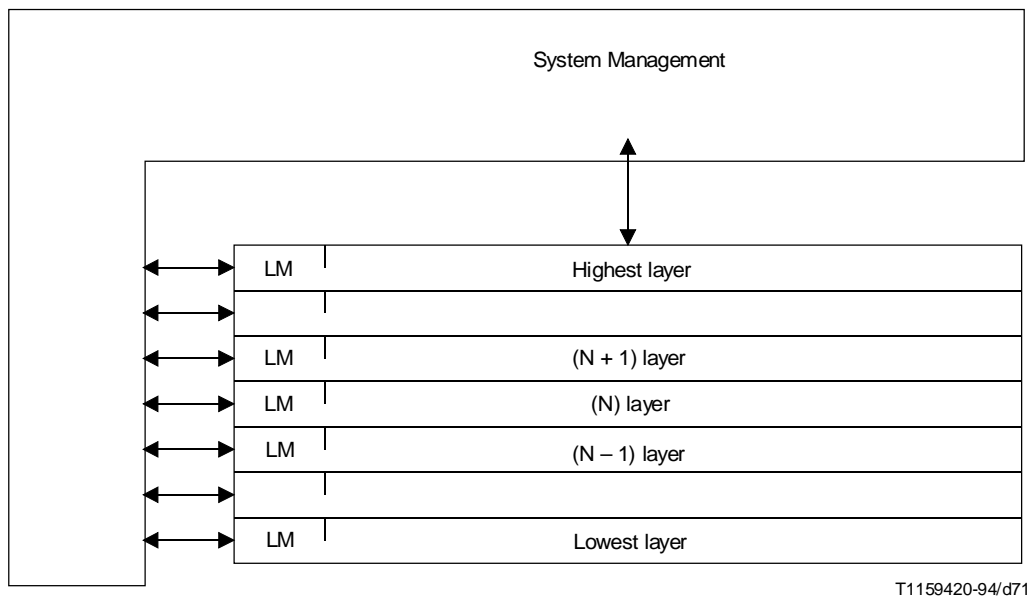

FIGURE I.1/Q.2110

Layering

An SAAL Service Access Point (SAP) is the point at which the SAAL provides services to layer 3. Associated with each SAAL SAP is one or more SAAL connection endpoints. See Figure I.2.

Entities exist in each layer. Entities in the same layer, but in different systems which must exchange information to achieve a common objective are called “peer entities”. Entities in adjacent layers interact through their common boundary. The services provided by the SAAL are the combination of the services and functions provided by the SAAL SSCS, SAAL common part, and the ATM layer.

Cooperation between SAAL entities is governed by a peer-to-peer protocol specific to the layer.

SAAL signaling data units (SDUs) are conveyed between SAAL entities by means of a physical connection.

Layer 3 requests service from the SAAL via service primitives. The same applies for the interaction between the SAAL and the ATM layer. The primitives represent, in an abstract way, the logical exchange of information and control between the SAAL and the adjacent layers and between the SAAL and the SAAL common part. They do not specify or constrain implementation.

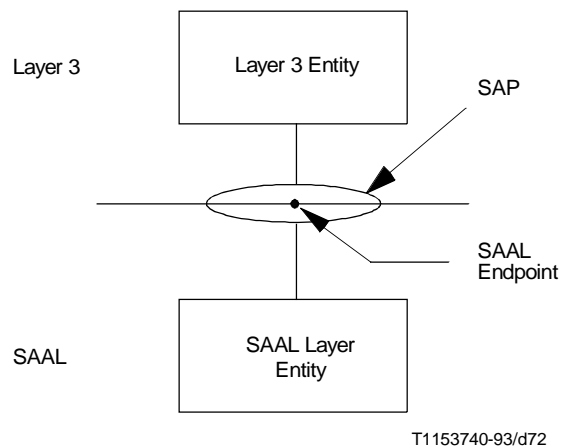
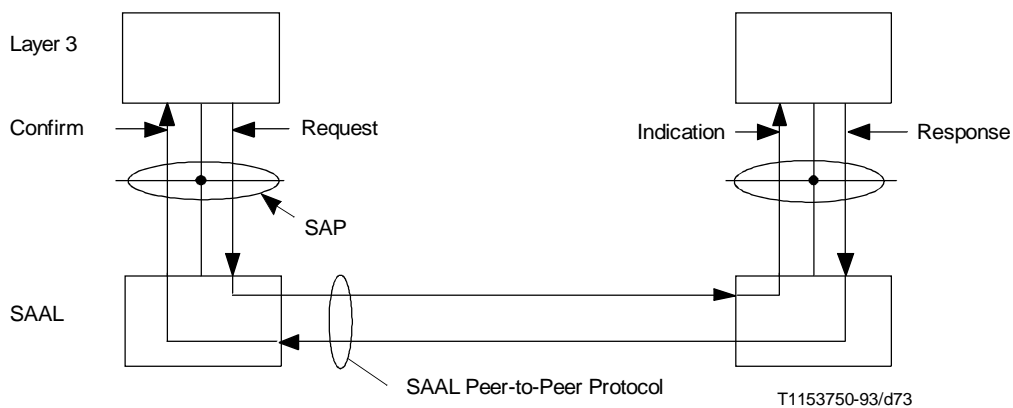

FIGURE I.2/Q.2110
Entities, service access points and endpoints

The primitives that are exchanged between the SAAL and adjacent layers are of the following types (see Figure I.3):

- a) request;
- b) indication;
- c) response;
- d) confirm.



NOTE – The same principle applies for SAAL-ATM.

FIGURE I.3/Q.2110
Primitive action sequence

The *request* primitive type is used when a higher layer is requesting a service from the next lower layer.

The *indication* primitive type is used by a layer providing a service to notify the next higher layer of any specific activity which is service related. The indication primitive may be the result of an activity of the lower layer related to the primitive type request at the peer entity.

The *response* primitive type is used by a layer to acknowledge receipt from a lower layer of the primitive type indication.

The *confirm* primitive type is used by the layer providing the requested service to confirm that the activity has been completed.

Information is transferred, in various types of SDUs, between peer entities and between entities in adjacent layers (and sublayers) that are attached to a specific SAP.

Appendix II

Examples of SSCOP operation

(This appendix does not form an integral part of this Recommendation)

Table II.1 demonstrates the semantics of the list elements within a STAT and USTAT PDU.

TABLE II.1/Q.2110

Examples of STAT and USTAT PDU semantics

RECEIVED SD PDUs	Received POLL PDU	Responding PDU
1,x,x,4	In case of USTAT	USTAT(N(R)=2,{2,4})
1,x,x,4	POLL(N(S)=5)	STAT(N(R)=2,{2,4,5})
1,x,x,x	POLL(N(S)=5)	STAT(N(R)=2,{2,5})
1,x,x,4,5	POLL(N(S)=6)	STAT(N(R)=2,{2,4,6})
1,x,x,4,5,x,x	POLL(N(S)=8)	STAT(N(R)=2,{2,4,6,8})
1,x,x,4,5,x,x,8,9	POLL(N(S)=10)	STAT(N(R)=2,{2,4,6,8,10})
NOTES 1 Elements in “{ }” are STAT list elements. 2 Only concerned fields are shown. 3 x represents PDUs lost during transmission.		

Figure II.1 through Figure II.3 show time flow diagrams of connection-establishment, data transfer, connection-release and resynchronization. All four time flow diagrams depict error-free operation, and are intended to provide a high-level appreciation of the protocol operation.

The following examples demonstrate the operation of the protocol under different scenarios. Each example illustrates a specific aspect of the protocol operation. The following conventions are used in the figures.

- The numbers shown at the transmitter represent SD sequence numbers, N(S), and the associated poll sequence numbers, N(PS), enclosed in parentheses.
- The numbers shown at the receiver represent the received SD PDU sequence numbers. An “X” in the delivered column indicates that an SD PDU has been delivered to the upper layer. An “X” in the Rx column represents a missing SD PDU.

- POLL PDU is represented as: POLL(N(S), N(PS)).
- STAT PDU is represented as: STAT(N(R), N(PS), N(MR), list elements).
- USTAT PDU is represented as: USTAT(N(R), N(MR), list elements).

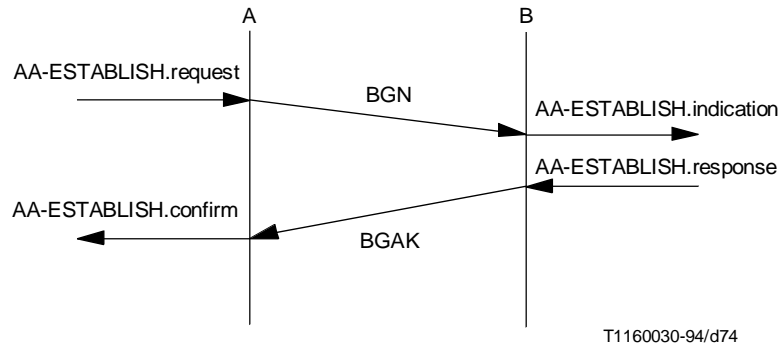

FIGURE II.1/Q.2110
Time flow diagram for SSCOP connection establishment supporting class C service (error-free operation)

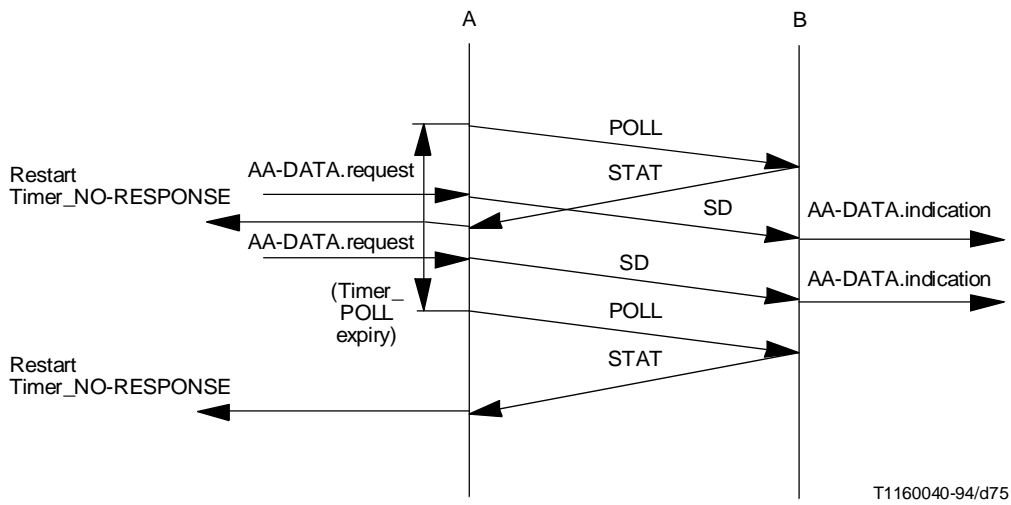

FIGURE II.2/Q.2110
Time flow diagram for SSCOP connection data transfer supporting class C service (error-free operation)

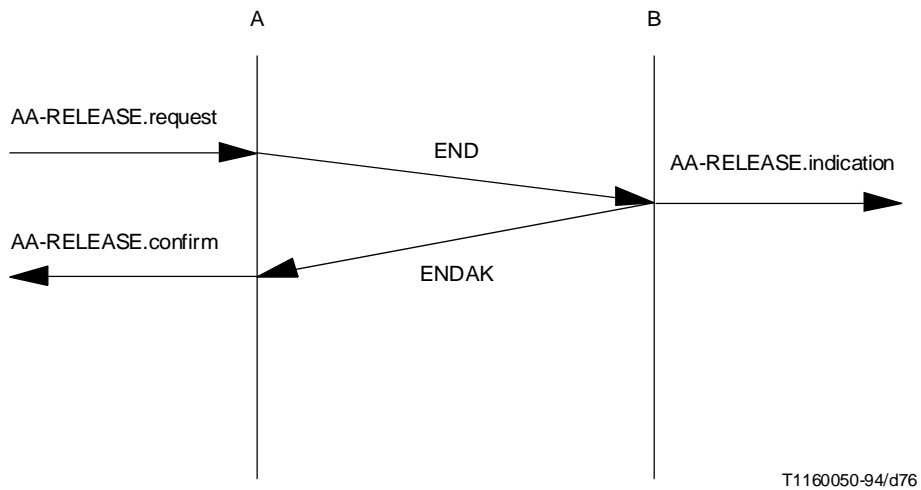

FIGURE II.3/Q.2110
**Time flow diagram for SSCOP connection release
 for supporting class C service (error-free operation)**

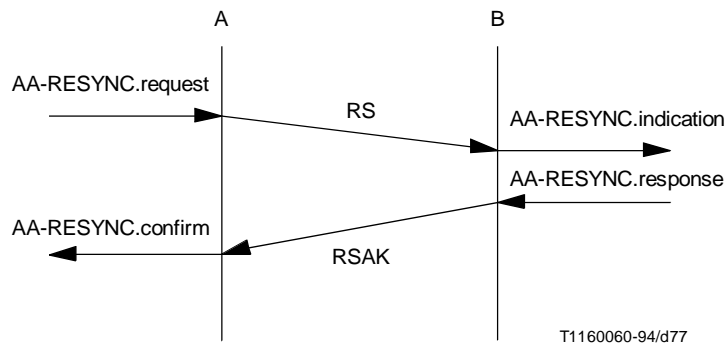

FIGURE II.4/Q.2110
**Time flow diagram for SSCOP connection resynchronization
 for supporting class C service (error-free operation)**

Figure II.5 shows the operation of the protocol in the error-free case. SD PDUs are received in-sequence and delivered to the upper layer. Each SD PDU is not acknowledged separately, but a group of SD PDUs is acknowledged via a STAT PDU in response to a POLL PDU.

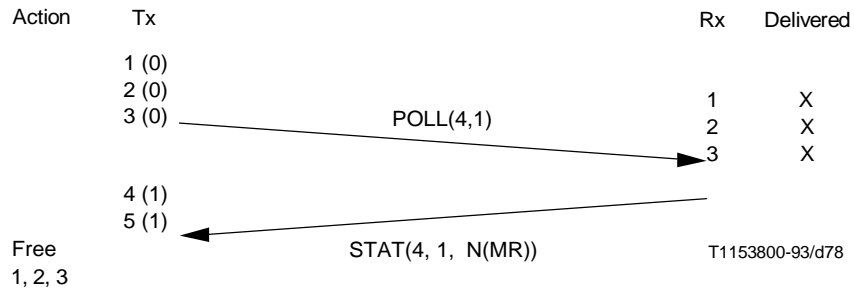

FIGURE II.5/Q.2110
Error-free operation

Figure II.6 shows error recovery via the USTAT PDU. Upon receiving SD PDU 3 and concluding that SD PDU 2 is missing, the receiver sends a USTAT PDU requesting retransmission of 2. Upon receiving this USTAT PDU, the transmitter retransmits SD PDU 2. Note that a subsequent STAT PDU is received, unnecessary retransmission is avoided due to the N(PS) comparison. The N(PS) associated with SD PDU 2 is 1, and it is not less than the N(PS) in the received STAT PDU(1), hence, 2 is not retransmitted. Upon receiving 2, the receiver delivers it and all subsequent in-sequence saved SD PDUs.

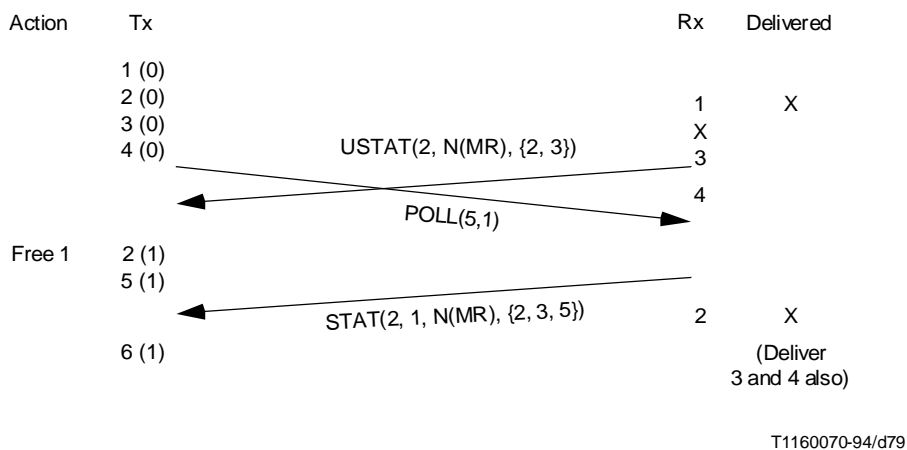

FIGURE II.6/Q.2110
Error recovery via unsolicited STAT PDU

Figure II.7 shows error recovery via STAT PDU. It demonstrates the case where an USTAT PDU is lost, however, recovery is still achieved via the STAT PDU.

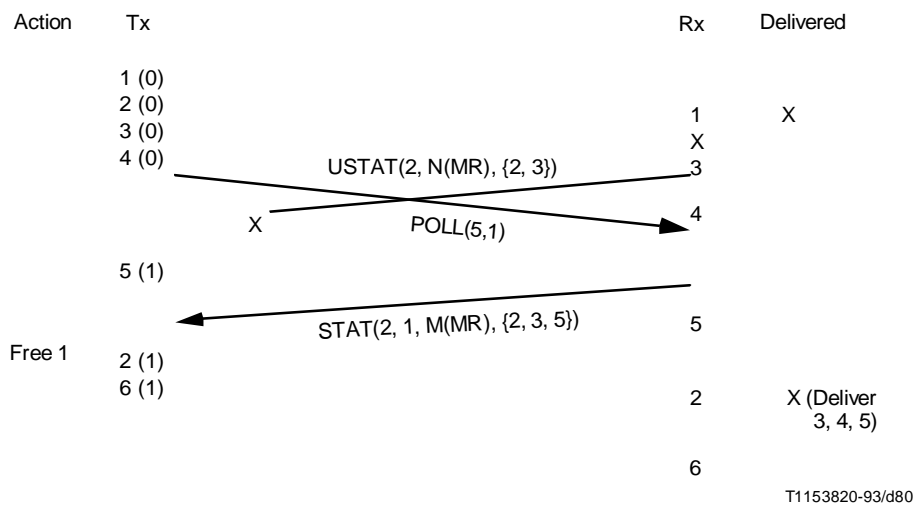

FIGURE II.7/Q.2110
Error recovery via STAT PDU

Figure II.8 shows error recovery via STAT PDU of the last transmitted SD PDUs. It demonstrates the case where the last transmitted SD PDUs are all lost. In this case, an USTAT PDU can not be generated, since the receiver has no knowledge that those SD PDUs have been transmitted and lost. However, error recovery is still achieved via the STAT PDU in response to the POLL PDU. Note that when SD PDU 5 is later on received, it does not cause a generation of a USTAT PDU.

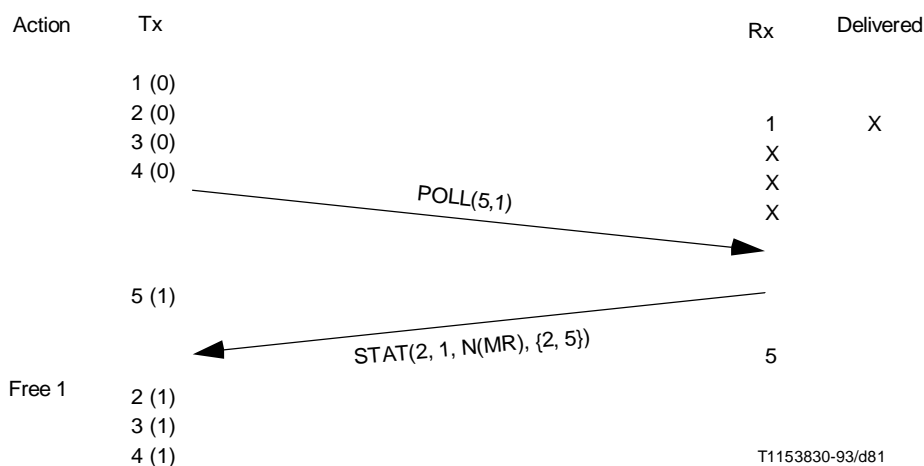

FIGURE II.8/2110
Error recovery via STAT of the last transmitted SD PDUs

Figure II.9 shows error recovery via STAT and USTAT PDU of the last transmitted SD PDUs. The STAT is generated similar to the example in Figure II.8. However, subsequent SD PDUs not reported in this STAT and detected as missing when SD PDU 7 is received later on, are recovered via the USTAT.

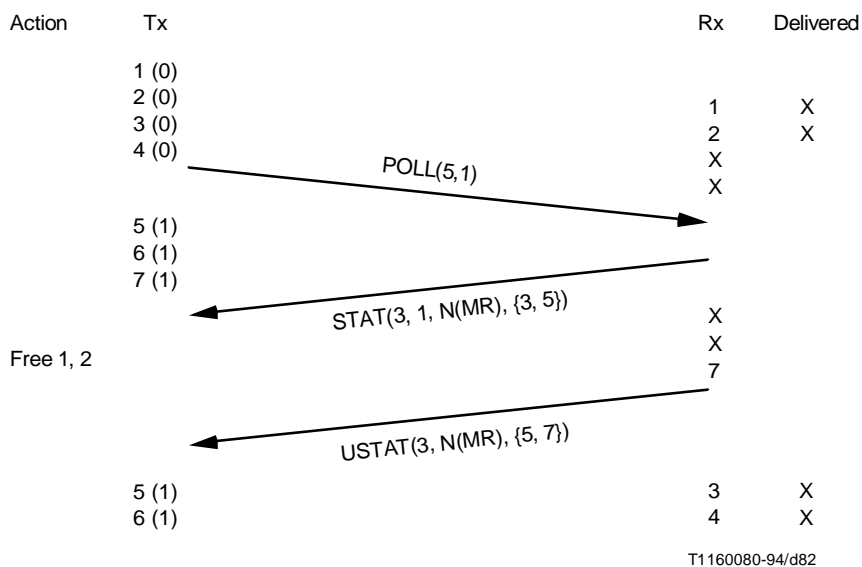

FIGURE II.9/Q.2110
**Error recovery via solicited and unsolicited STATs
of the last transmitted SD PDUs**

Figure II.10 is similar to Figure II.9, but in this case the STAT PDU is lost. The example shows that the subsequent STAT PDU completes the error recovery.

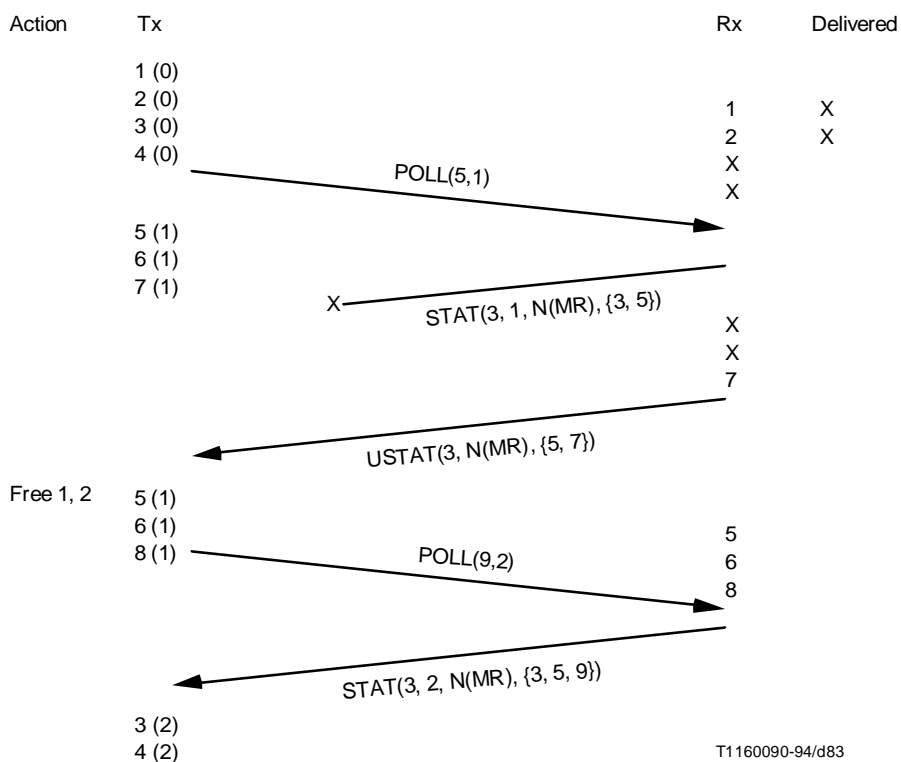

FIGURE II.10/Q.2110
Error recovery via STAT and USTAT with loss of the STAT

Figure II.11 is similar to Figure II.8, however, in this case two span lists are included in the STAT PDU.

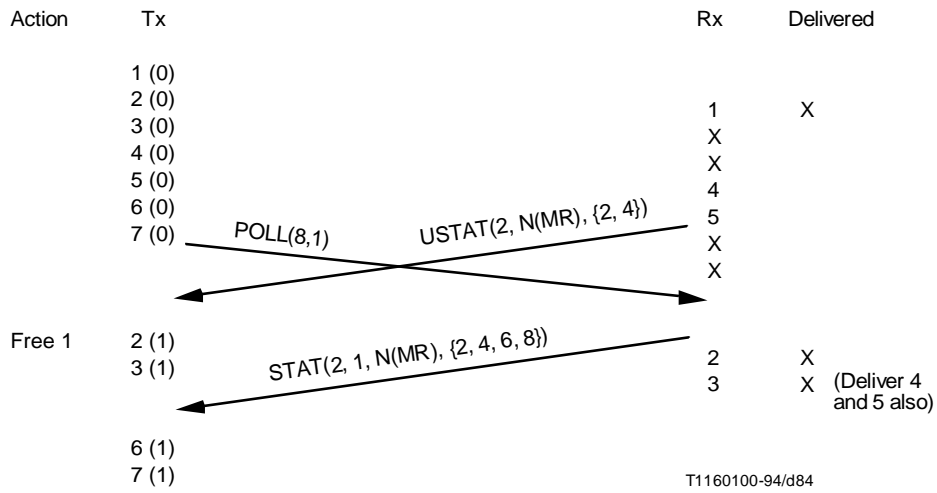

FIGURE II.11/Q.2110
Error recovery via STAT PDU

Figure II.12 is similar to Figure II.6, however, in this case two span lists are included in the STAT PDU.

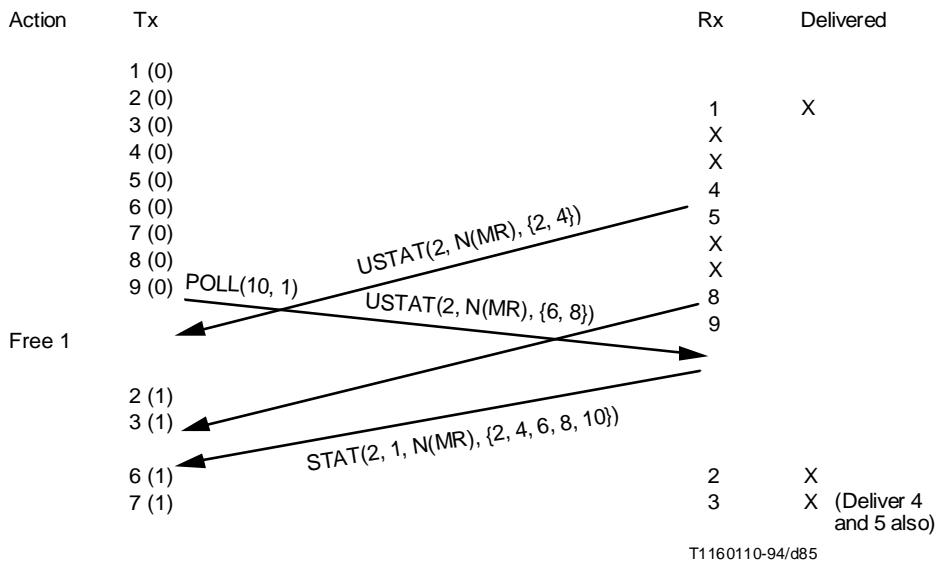

FIGURE II.12/Q.2110
Error recovery of two missing SD sequences

Appendix III

Summary of buffer and state variable management

(This appendix does not form an integral part of this Recommendation)

Table III.1 shows the status of the various buffers and the state variables at the time when a particular state is entered.

TABLE III.1/Q.2110

Buffer and state variable management

	Idle	Outgoing Connection Pending	Incoming Connection Pending	Outgoing Disconnection Pending	Outgoing Resynchronization Pending	Incoming Resynchronization Pending	Outgoing Recovery Pending	Recovery Response Pending	Incoming Recovery Pending	Data Transfer Ready
	1	2	3	4	5	6	7	8	9	10
Clear Transmission Queue	C	U	C	C	U	C	C	C	C	A
Clear Transmission Buffer	C	U	C	C	U	C	C	C	C	U
Clear Retransmission Queue	U	U	U	U	U	U	U	U	U	(Note 1)
Clear Receiver Buffer	U	U	U	U	U	U		D	D	(Note 2)
Reset Receiver State Variables										R
Reset Transmitter State Variables										R
Data Retrieval Allowed	Y		Y	Y		Y		Y	Y	

U Buffer/Queue is empty unconditionally upon entry into the state.

C Buffer/Queue is empty conditionally, i.e. if "Clear-Buffer = NO", upon entry into the state.

A The buffer is cleared unconditionally upon entry into the state, unless when entering from state 8 or 9 and if "Clear-Buffer = NO" (the data is subsequently transmitted).

D If "Clear-Buffer = NO", the content of the buffer is delivered with possible sequence gaps; if "Clear-Buffer = YES", the buffer is cleared upon entry into this state.

R Data transfer state variables are reset upon entry into the state.

Y Data retrieval allowed.

NOTES

1 Data can be inserted into the Retransmission queue only in state 10, "Data Transfer Ready". As this buffer is cleared unconditionally upon entering any other state, by default, it is empty upon entry into state 10.

2 Data can be inserted into the Receiver buffer only in state 10, "Data Transfer Ready". As this buffer is cleared unconditionally before state 10 is entered from any other possible state, the Receiver buffer is empty unconditionally when entering state 10, by default, also.

Appendix IV

Default window size for SSCOP

(This appendix does not form an integral part of this Recommendation)

This appendix may be used to set the window size parameter (conveyed in the SSCOP N(MR) field) of SSCOP. The following formula can be used to calculate a window size that is sufficient to keep the transmitter active. Alternatively, the window can be optimized to the particular connection or implementation. For example, the window size may be reduced to perform flow control or buffer management. During a connection, the window size can change dynamically based on local requirements.

$$k = 2 + (2 * \text{Timer_POLL} + 6 * \text{Ttd}) * \text{Ru} / (8 * \text{Ld})$$

where

- k is the window size
- Ttd is the end-to-end transit delay (seconds)
- Timer_POLL is the POLL timer value for the peer entity (seconds)
- Ru is the SSCOP throughput (bits/s)
- Ld is the data frame size in octets

Information regarding the end-to-end transit delay, throughput, and frame size should be available at the SSCOP endpoints, or may be derived from signaling messages. The Timer_POLL used by the peer can be identified based on the received POLL PDU frequency; alternatively, the selected Timer_POLL value used at the local transmitter can be used.

The values of the Timer_POLL and the round trip delay have implications on the size of buffers needed to support the connection. If the window size implies that excessive buffers are needed for the connection, an implementation may consider shortening the Timer_POLL value at the transmitter, or decoupling the receiver buffer from the offered window at the receiver.

The window passed to the transmitter is conveyed by a sequence number in the N(MR) field of certain SSCOP PDUs. The difference between this sequence number (VR(MR)) and the next in-sequence to be received (VR(R)) is the window at the receiver.