

International Telecommunication Union

ITU-T

TELECOMMUNICATION
STANDARDIZATION SECTOR
OF ITU

Series L
Supplement 11
(12/2014)

SERIES L: CONSTRUCTION, INSTALLATION AND
PROTECTION OF CABLES AND OTHER ELEMENTS
OF OUTSIDE PLANT

**ITU-T L.1300 – Supplement on a verification test
and feasibility study of energy and space
efficient cooling systems for data centres with
high density ICT devices**

ITU-T L-series Recommendations – Supplement 11

ITU-T



Supplement 11 to ITU-T L-series Recommendations

ITU-T L.1300 – Supplement on a verification test and feasibility study of energy and space efficient cooling systems for data centres with high density ICT devices

Summary

Supplement 11 to the ITU-T L series of Recommendations refers to the best practices defined in Recommendation ITU-T L.1300. More precisely, this Supplement provides firstly an introduction to a verification test and feasibility study of energy and space efficient cooling systems for data centres with high density ICT devices. Secondly, trial calculations of energy conservation benefits with respect to the application to a full-scale data centre are then reported.

History

Edition	Recommendation	Approval	Study Group	Unique ID*
1.0	ITU-T L Suppl. 11	2014-12-19	5	11.1002/1000/12439

Keywords

Best practice, data centre, energy efficient, information and communication technology and climate change (ICT & CC).

* To access the Recommendation, type the URL <http://handle.itu.int/> in the address field of your web browser, followed by the Recommendation's unique ID. For example, <http://handle.itu.int/11.1002/1000/11830-en>.

FOREWORD

The International Telecommunication Union (ITU) is the United Nations specialized agency in the field of telecommunications, information and communication technologies (ICTs). The ITU Telecommunication Standardization Sector (ITU-T) is a permanent organ of ITU. ITU-T is responsible for studying technical, operating and tariff questions and issuing Recommendations on them with a view to standardizing telecommunications on a worldwide basis.

The World Telecommunication Standardization Assembly (WTSA), which meets every four years, establishes the topics for study by the ITU-T study groups which, in turn, produce Recommendations on these topics.

The approval of ITU-T Recommendations is covered by the procedure laid down in WTSA Resolution 1.

In some areas of information technology which fall within ITU-T's purview, the necessary standards are prepared on a collaborative basis with ISO and IEC.

NOTE

In this publication, the expression "Administration" is used for conciseness to indicate both a telecommunication administration and a recognized operating agency.

Compliance with this publication is voluntary. However, the publication may contain certain mandatory provisions (to ensure, e.g., interoperability or applicability) and compliance with the publication is achieved when all of these mandatory provisions are met. The words "shall" or some other obligatory language such as "must" and the negative equivalents are used to express requirements. The use of such words does not suggest that compliance with the publication is required of any party.

INTELLECTUAL PROPERTY RIGHTS

ITU draws attention to the possibility that the practice or implementation of this publication may involve the use of a claimed Intellectual Property Right. ITU takes no position concerning the evidence, validity or applicability of claimed Intellectual Property Rights, whether asserted by ITU members or others outside of the publication development process.

As of the date of approval of this publication, ITU had not received notice of intellectual property, protected by patents, which may be required to implement this publication. However, implementers are cautioned that this may not represent the latest information and are therefore strongly urged to consult the TSB patent database at <http://www.itu.int/ITU-T/ipr/>.

© ITU 2015

All rights reserved. No part of this publication may be reproduced, by any means whatsoever, without the prior written permission of ITU.

Table of Contents

	Page
1 Scope.....	1
2 Definitions	1
3 Abbreviations and acronyms	1
4 Introduction.....	1
4.1 Background.....	1
4.2 Objective.....	2
5 Outline of verification and testing	2
5.1 Experimental equipment.....	2
5.2 Points investigated.....	5
6 Verification testing and results	5
6.1 Cooling characteristics of outdoor air cooling	5
6.2 Cooling characteristics of evaporative cooling	6
6.3 Cooling characteristics of spot cooling	7
6.4 Comparison of the cooling performance of various air conditioning methods.....	8
7 Trial calculations of energy conservation benefits calculations results in application to a full-scale data centre	9
7.1 Trial calculation model.....	9
7.2 Trial calculation method.....	10
7.3 Power density and space efficiency.....	11
7.4 Outdoor air conditions and air conditioning energy efficiency.....	12
7.5 Annual air conditioning power consumption calculated by city.....	14
Bibliography.....	20

Supplement 11 to ITU-T L-series Recommendations

ITU-T L.1300 – Supplement on a verification test and feasibility study of energy and space efficient cooling systems for data centres with high density ICT devices

1 Scope

This Supplement describes a verification test and feasibility study of energy and space efficient cooling systems for data centres with high density ICT devices based on Recommendation ITU-T L.1300. The scope of this Supplement includes:

- an introduction of a verification test and feasibility study of energy and space efficient cooling systems for data centres with high density ICT devices;
- an outline of verification and testing methodologies;
- verification test results; and
- trial calculations of energy conservation benefits calculations results when applied to a full-scale data centre.

2 Definitions

This Supplement defines the following terms:

2.1 power density: The energy consumption of ICT equipment per rack cabinet of floor area of a server room.

2.2 space efficiency: The ratio of floor area employed for ICT equipment in relation to the total floor area of the building.

3 Abbreviations and acronyms

This Supplement uses the following abbreviations and acronyms:

AHU Air Handling Unit

WB Wet-Bulb

4 Introduction

4.1 Background

In his speech to the General Assembly of the United Nations in September 2009, Prime Minister Hatoyama stated Japan's international pledge to reduce CO₂ emissions by 25% of 1990 levels by the year 2020 as a mid-term target. As a contribution to this target, a "world-leading reduction in environmental impact" was also proposed for the "Haraguchi Vision". At the same time, there is no method for measuring the reduction in CO₂ emissions within the internationally recognized field of ICT. With 2010 as the first target period, work on providing advice on methods of evaluating the effects of CO₂ reductions for ICT commenced at the International Telecommunication Union (ITU), and international standardization for ICT on climate change has been strengthened.

Within the context of information and communications, the importance of data centres, which form the foundation of information and communications, has increased with the development of cloud computing and the rapid progress in ICT. Furthermore, in business activities, in terms of improving the efficiency of operations, rapid progress has been achieved in ICT, and the demand for data centres, the foundation of the ICT infrastructure, is growing rapidly. Data centres house large numbers of ICT

devices (e.g., server storage network devices) for the processing and storage of a wide variety of data and have air conditioning equipment to cool the interiors of the buildings. Accordingly, the consumption of power, in association with this rapid expansion of demand for data centres, is itself growing rapidly.

The proportion of power required by air conditioning equipment for such cooling is high compared with the power consumed by the ICT devices, and a reduction in the power consumption of data centres is a matter of considerable importance in improving the efficiency of air conditioning equipment, and in improving energy conservation. Furthermore, in Japan, the majority of data centres of telecommunication operators are located on sites in the suburbs of the capital and other large cities, and construction of space-efficient data centres is therefore a matter of importance.

Equipment for the verification and testing of various cooling methods used for data centres was therefore constructed, and cooling efficiency measured and verified. Energy consumed with the various cooling methods was calculated, with usage of energy and space included, and a high-efficiency method of air conditioning determined.

4.2 Objective

Air conditioning used in data centres involves blowing chilled air from the server room floor to supply chilled air to the inlets of the server racks, and thus removing the heat generated by the ICT devices. This system is often referred to as "floor supply air conditioning". For data centres located in cold areas, power consumption for air conditioning can be reduced by using natural energy from exterior air and snow. This has considerable possibilities, and examples are in use, and planned, both in Japan and overseas.

In Japan, on the other hand, the majority of data centres of telecommunication operators are located on sites in the suburbs of the capital and other large cities, and efficient use of the limited space available at these sites, and the need for high energy efficiency data centre equipment, is of clear importance.

In existing server rooms with high-load and high-density racks, air conditioning power consumption of various cooling methods was therefore tested and verified to investigate the optimum specifications and energy conservation benefits for air conditioning equipment in high power density data centres.

5 Outline of verification and testing

5.1 Experimental equipment

Figure 1 shows an outline of the equipment employed in verification and testing. This testing was conducted at the Hitachi Plant Technologies Ltd., Matsudo Research Laboratories (Matsudo City, Chiba Prefecture), using a simulated server room and test air conditioning equipment.

The simulated server room contained simulated server equipment with built-in heaters, and was mounted on a free-access floor. The facilities comprised a cold aisle supplying chilled air from the air conditioning equipment, and a hot aisle facing the server rack exhaust.

Test air conditioning equipment comprised a floor supply air conditioner employing conventional air conditioning and outdoor air cooling, an evaporative cooling unit, and a spot cooling unit.

The test equipment comprised eight simulated servers generating 8 kW of heat per rack. The floor supply air conditioner had a cooling capacity of 64 kW with an airflow of 20 000 m³/hr, and the evaporative cooling unit had a cooling capacity of 32 kW with an airflow of 10 000 m³/hr. One of each was installed. Four spot cooling units, each with a cooling capacity of 15 kW/unit, were also installed.

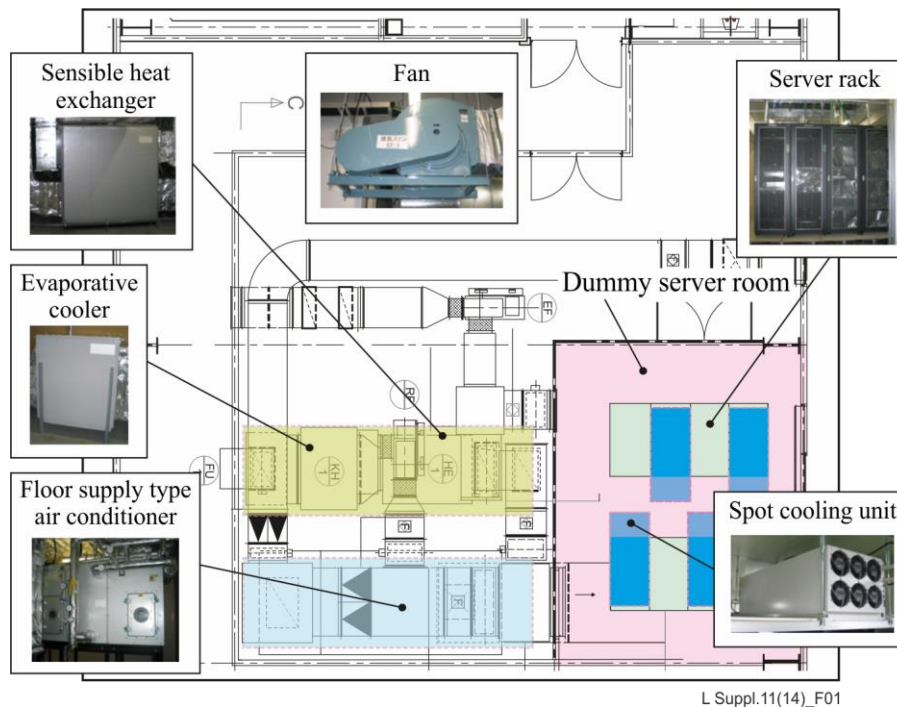

Figure 1 – Outline of a verification test facility

The typical floor supply air conditioning method was of the under-floor type in which cooling is achieved by supplying cooled air from multiple floor outlets. Hot interior air discharged from the hot aisle into the interior upper airspace is drawn from the top of the floor supply air conditioning equipment, dehumidified and cooled to the specified temperature with chilled water inside the air conditioning equipment. The cooled air is then supplied to an under-floor chamber. During testing, the temperature of the air supplied from the floor supply air conditioning equipment was maintained at $18^{\circ}\text{C} \pm 2^{\circ}\text{C}$.

Outdoor air cooling employs a floor supply air conditioner supplying cold air to the room, outdoor air is passed through ducts to the air conditioner, and an exhaust fan discharges this air to the outside. As with conventional air conditioning, this method cools by supplying air conditioned air from multiple perforated tiles on the floor in the room. When the temperature of the outdoor air is low, it is passed to an air conditioner, mixed with high-temperature return air from the room cooled and the humidity is adjusted as necessary, and supplied to the under-floor chamber. During testing, the temperature of the air supplied from the floor supply air conditioning equipment was maintained at $18^{\circ}\text{C} \pm 2^{\circ}\text{C}$.

In addition to floor supply air conditioning equipment which supplies cold air to the room, the evaporative cooling methods employs an evaporative cooling unit comprised of an evaporative cooler and direct sensible heat exchanger, an external fan to pass exterior air over the unit, and a circulating fan to circulate return air. This interior return air is cooled by humidified outdoor air that is cooled by humidification using an evaporative cooling unit, mixed directly with air circulated internally, and introduced into the air conditioning equipment. Chilled water is then used to dehumidify and cool the air to the specified temperature via cooling coils within the air conditioning equipment, and the air is then supplied to the room via the under-floor chamber. During testing, the temperature of the air supplied from the floor supply air conditioning equipment was maintained at $18^{\circ}\text{C} \pm 2^{\circ}\text{C}$.

In addition to floor supply air conditioning equipment to supply chilled air to the room, the spot cooling method employs a spot cooling unit using the natural circulation of a refrigerant for heat transport. A water-cooled condenser is used to condense the refrigerant evaporated in the spot cooling unit. The spot cooling unit, using the natural circulation of a refrigerant, is installed between the server racks and the ceiling, and draws in hot return air discharged from the hot aisle into the space below

the ceiling, evaporating the refrigerant in the cooling coils in the cooling unit, and cooling the return air to a specified temperature, and supplying it to the cold aisle. The refrigerant evaporated in the cooling coils employs the natural circulation of the refrigerant occurring with the difference in density at the vapour-liquid interface. Heat is transported outside the room by circulating the refrigerant through the water-cooled condenser. During testing, the temperature of air supplied to the floor supply air conditioning equipment was maintained at $18^{\circ}\text{C} \pm 2^{\circ}\text{C}$, and the temperature of the air from the spot cooling unit was maintained at $23^{\circ}\text{C} \pm 2^{\circ}\text{C}$. Testing was also conducted using only spot cooling, without floor supply air conditioning equipment.

Figure 2 shows an outline of measurement in verification and testing. Sensors to measure a range of data were installed in the test room and in the vicinity of the air conditioning equipment. The data was recorded with a data logger.

In order to evaluate the air conditioning efficiency of each type of air conditioning equipment, this testing measured power consumption not only of IT devices, but also of floor supply air conditioning equipment, refrigerators, chilled water pumps, blowers used in evaporative cooling systems, and spot cooling units. Furthermore, chilled water return temperature, temperature of the return air from the floor supply air conditioner, evaporative cooling unit return air temperature, outdoor air temperature and humidity, chilled water flow, and supply and discharge water flows, were also measured.

Furthermore, in order to evaluate the interior temperature and thermal environment, inlet and discharge temperature for the server racks, air conditioning equipment supply and discharge temperatures, and spot cooling unit supply and discharge temperatures, were measured with temperature and humidity sensors. This data was measured continuously at intervals of five minutes or less.

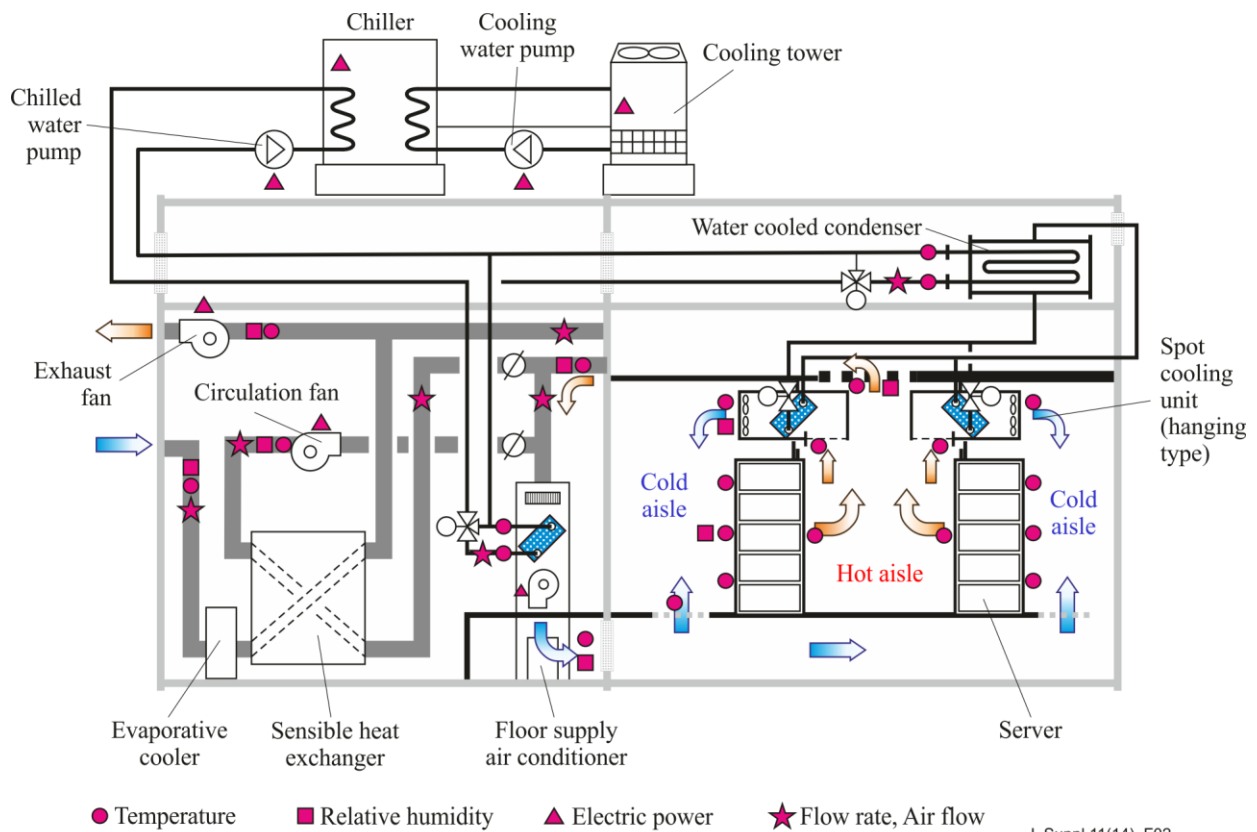

Figure 2 – Outline of measurement points

5.2 Points investigated

The following investigations of air conditioning energy efficiency were conducted for each air conditioning method to evaluate the characteristics and energy conservation properties of each.

- (1) Cooling characteristics of outdoor air cooling
- (2) Cooling characteristics of evaporative cooling
- (3) Cooling characteristics of spot cooling
- (4) Air conditioning methods and power consumption

To evaluate space efficiency and air conditioning efficiency when applied to an actual data centre, a data centre with 500 server racks was assumed when developing the basic equipment plan and calculating annual power consumption.

6 Verification testing and results

6.1 Cooling characteristics of outdoor air cooling

Figure 3 shows an example of trends in server rack intake temperature and air conditioner supply temperature under the average outdoor air conditions (outdoor air enthalpy approximately 13 kJ/kg) for Tokyo in January. It shows data measured at 64 kW (load ratio 100%) of heat generated by the ICT equipment with outdoor air cooling.

With combined outdoor air cooling and conventional air conditioning, low-temperature outdoor air is mixed with room return air, the mixture humidified to the specified humidity with the evaporative humidifier in the air conditioner, its temperature adjusted to the required supply temperature, and then supplied to the room. The air conditioner supply temperature status is controlled to a stable $18^{\circ}\text{C} \pm 0.5^{\circ}\text{C}$. Furthermore, the maximum server rack inlet temperature was verified to be approximately 20°C to maintain a similar environment to that of typical air conditioning.

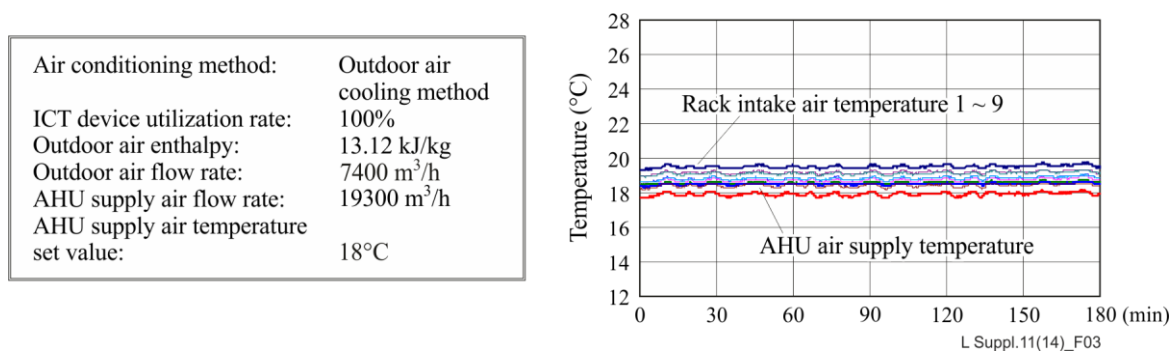

Figure 3 – Example of air conditioning in an outdoor air cooling system

Figure 4 shows outdoor air enthalpy and power consumption (single chilling system, chilling system, transport). When outdoor air enthalpy is increased, the amount of outdoor air required to handle the heat generated in the room increases. This is apparent in the trend towards increased transport power with increased outdoor air enthalpy. With this method, exhaust fans are installed to discharge the same amount of room air to the outside. In comparison with conventional air conditioning, power consumption of distribution equipment increases, however power consumption of a chilling system can be halted completely, thus saving large amounts of energy. Testing showed that, under the average outdoor air conditions prevailing in Tokyo in January (temperature 7.0°C , relative humidity 41%, enthalpy 13 kJ/kg), a 47% reduction in air conditioning power consumption is possible in comparison with conventional air conditioning.

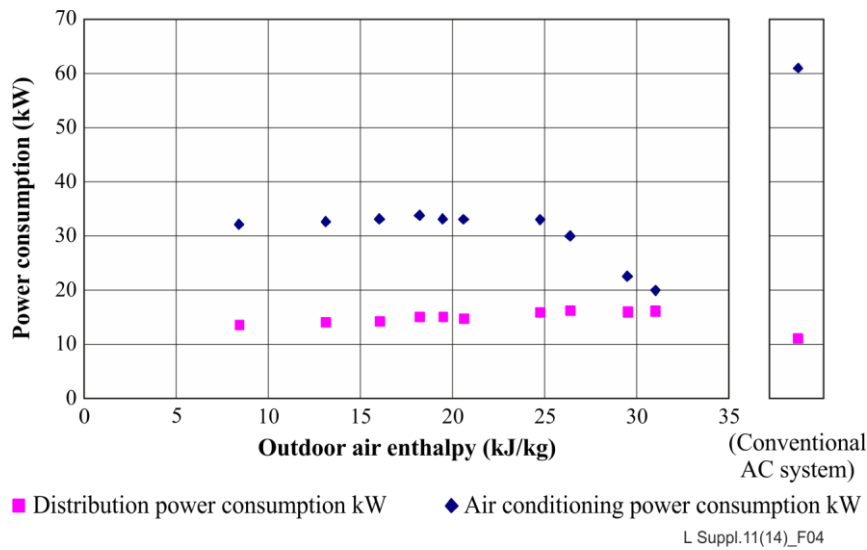

Figure 4 – Outdoor air enthalpy and distribution power consumption

6.2 Cooling characteristics of evaporative cooling

Figure 5 shows an example of trends for inlet temperature of an evaporative-cooled server rack, and air conditioning air supply temperature under outdoor air conditions prevailing in Tokyo in January (outdoor air enthalpy 13 kJ/kg). The graphs show actual data recorded for a combination of evaporative cooling and typical air conditioning, with 64 kW of heat generated by ICT devices.

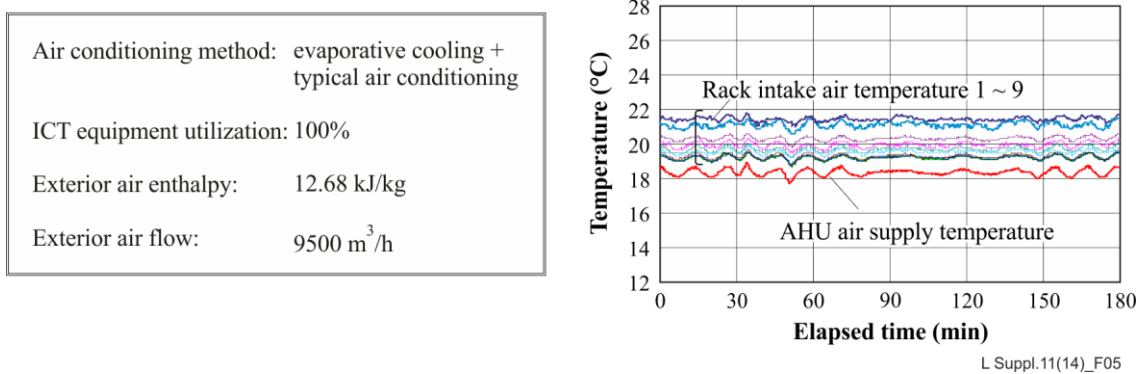

Figure 5 – Evaporative cooling operational state (example)

With the combination of evaporative cooling and typical air conditioning, air was cooled with exterior air, and further cooled to the necessary supply temperature with air conditioning equipment before its supply to the room. Temperature was controlled in a stable manner during testing, and the supply temperature was maintained at 18°C ±2°C. Furthermore, maximum server rack inlet temperature was verified to be approximately 22°C to maintain a similar environment to that of typical air conditioning.

Figure 6 shows outdoor air enthalpy and heat processed. It was confirmed that cooling performance improves as outdoor air enthalpy decreases, with cooling performance able to handle 38 kW, or approximately 60% of indoor heat generated, at outdoor air enthalpy of around 13 kJ/kg under average outdoor air conditions in Tokyo in January (temperature 7.0°C, relative humidity 41%).

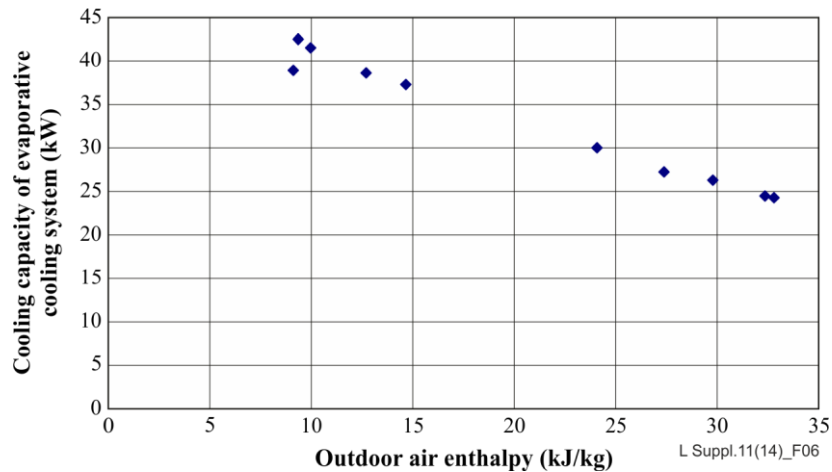

Figure 6 – Outdoor air enthalpy and cooling capacity of evaporative cooling system

6.3 Cooling characteristics of spot cooling

Figure 7 shows trends in server rack inlet temperature and air conditioning equipment temperature when using the spot cooling method. A combination of spot cooling and typical air conditioning was employed, with 64 kW of heat (100% load) generated by the ICT devices. With the combination of spot cooling and typical air conditioning, it was verified that the air supplied by the spot cooling unit was able to be maintained at a maximum stable temperature of $23^{\circ}\text{C} \pm 0.5^{\circ}\text{C}$, and rack inlet temperature was able to be maintained at a maximum of 22°C , approximately the temperature obtained with typical air conditioning.

Air conditioning method:	spot cooling + typical air conditioning
Typical air conditioning:	100%
Air conditioning air flow:	$10592 \text{ m}^3/\text{h}$

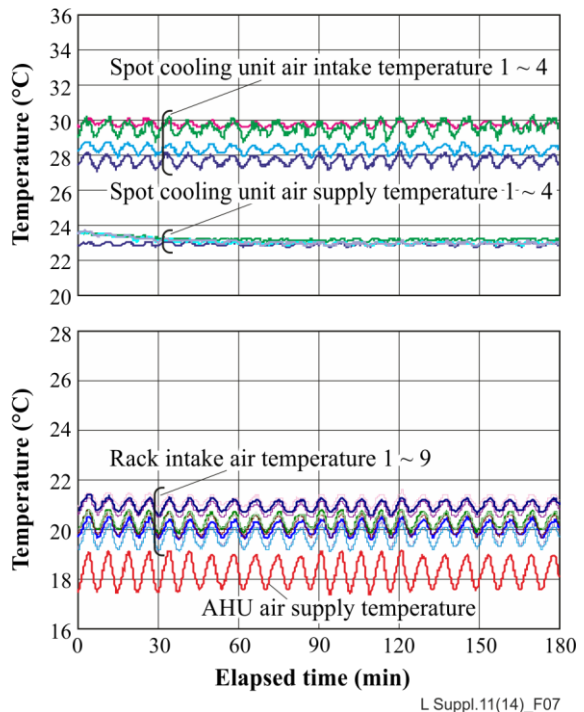

Figure 7 – Spot cooling method operational state (example)

Figure 8 shows the intake air temperature and spot cooling unit cooling performance. With the spot cooling unit, supply air was maintained at a constant temperature and, as intake air temperature increased, cooling performance increased, until at an intake temperature of 40°C , a cooling performance of 15 kW/unit was achieved.

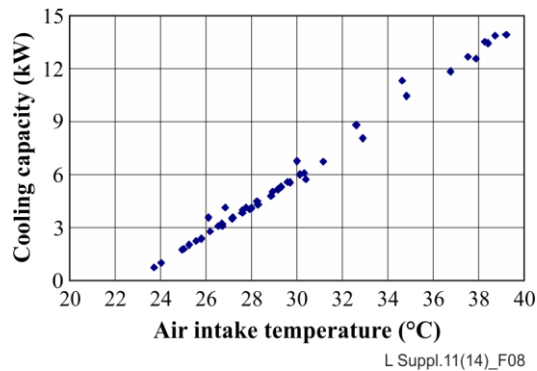

Figure 8 – Air intake temperature and cooling performance

6.4 Comparison of the cooling performance of various air conditioning methods

Figure 9 shows power consumption (single chilling system, chilling system, transport). While spot cooling consumes nearly the same chilling system power as the chilling system power in a conventional air conditioning system, no chilling system power was required for outdoor air cooling at 13 kJ/kg outdoor air enthalpy under average outdoor air conditions in January in Tokyo. It was also found that, with evaporative cooling, chilling system power could be reduced by 50% at 13 kJ/kg outdoor air enthalpy under average outdoor air conditions in January in Tokyo, and major reductions in chilling system power could be achieved by effectively exploiting outdoor air heat with outdoor air cooling and evaporative cooling.

Meanwhile, with outdoor air cooling, exhaust fan power increases with the introduction of outdoor air, increasing the distribution power by 25% over the distribution power in a conventional air conditioning system. In addition, blower power increased in an evaporative cooling system since outdoor air is indirectly used, increasing distribution power by 97%. On the other hand, with spot cooling, heat generated by the server devices can be handled by air circulation in the vicinity of the server racks, and thus the power required for air transport is much reduced. If all heat is handled with direct air conditioning, power required for transport can be reduced by 75% or more.

Testing showed that reductions of 46%, 5%, and 15% in total air conditioning power consumption, compared with the conventional air conditioning system, could be achieved with outdoor air cooling, evaporative cooling, and spot cooling systems respectively.

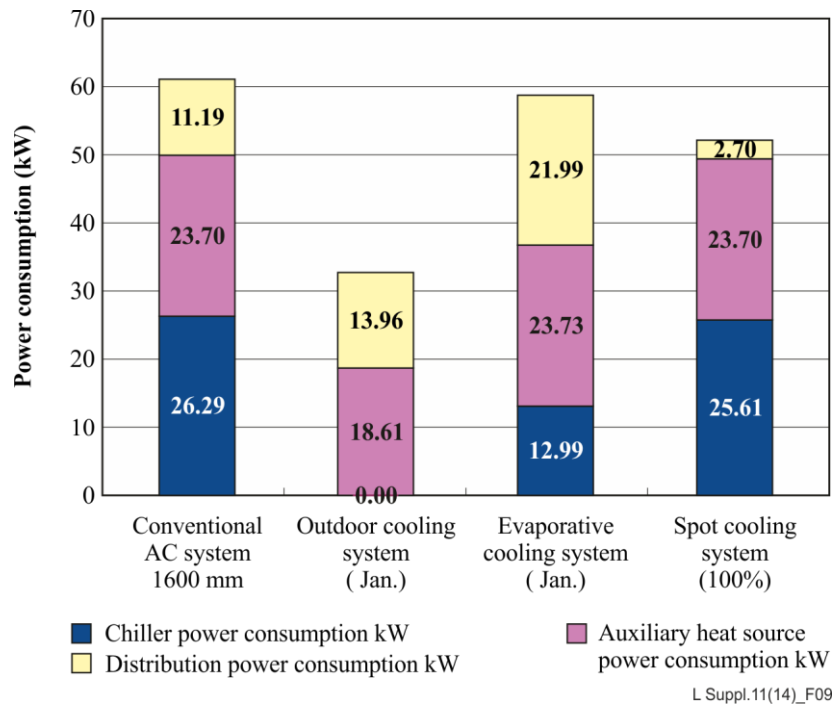

Figure 9 – Comparison of power consumption

7 Trial calculations of energy conservation benefits calculations results in application to a full-scale data centre

7.1 Trial calculation model

Figure 10 shows an outline of the trial calculation model, and trial calculation conditions. The trial calculation assumes a data centre comprised of 500 server racks, installed on two floors, with server racks spaced 1 600 mm apart.

Trial calculations covered air conditioner layout, air conditioning equipment room space, and annual power consumption for conventional air conditioning, as well as for outdoor air cooling, evaporative cooling (evaporative cooling and air conditioner, each handling 50% of the heat), and spot cooling. Calculations assumed all chilling systems as shared, and an air-cooled chiller with primary and secondary pump systems.

Calculations were made while varying the amount of heat generated by the server rack between 3 kW and 12 kW in order to evaluate the correlation between server room power density (power consumption by ICT equipment per unit floor space is same as heat generated by ICT equipment per unit floor space) and dedicated air conditioning area. In order to determine the effect on air conditioning power consumption in outdoor air wet-bulb temperature conditions, air conditioning power consumption was calculated in increments of 1°C between -10°C and 30°C for outdoor air wet-bulb temperature, and annual power consumption calculated for six representative cities (Tokyo, London, Singapore, Los Angeles, Dubai, and Moscow).

Outdoor air temperature and humidity data for 2010 was obtained from the NCDC National Climatic Data Centre) and used in the calculation of power consumption under the daily average representative air temperature and humidity conditions. Annual power consumption was calculated assuming a server load ratio of 100%.

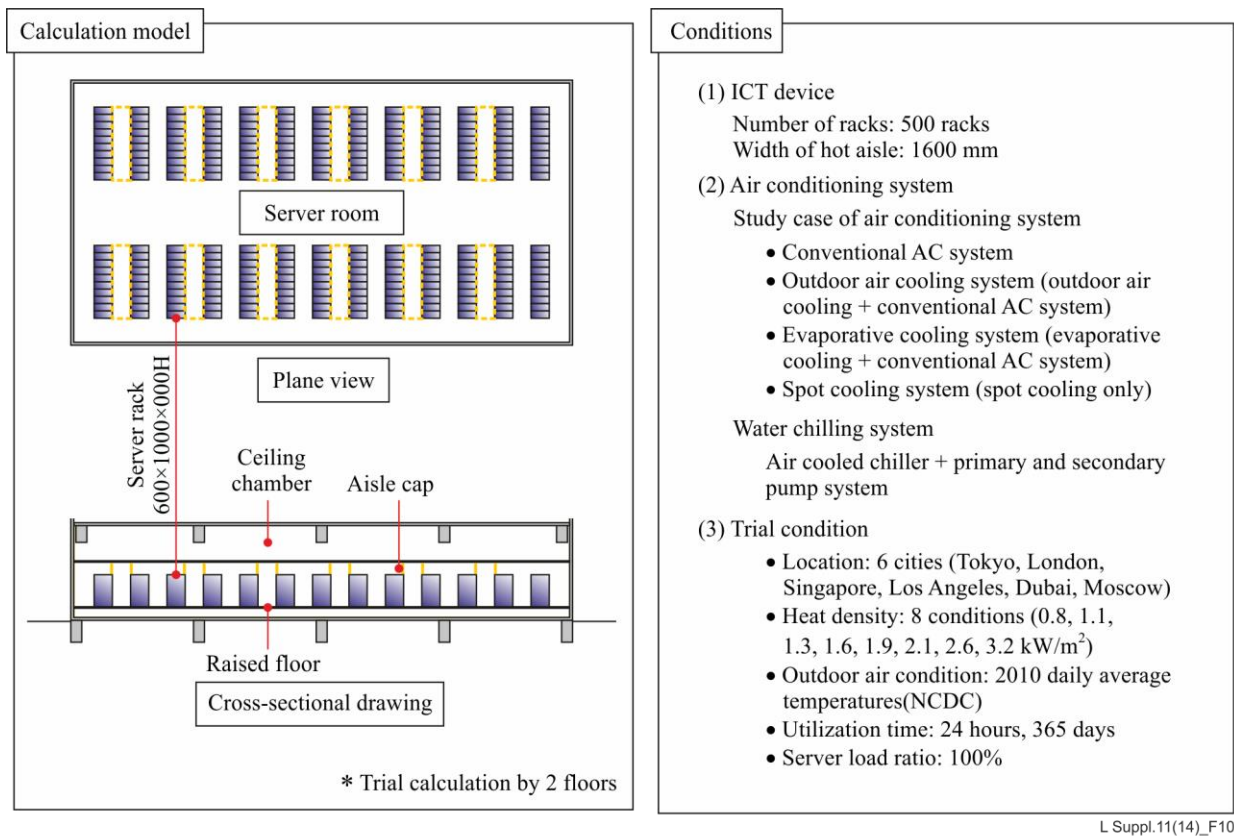

L Suppl.11(14)_F10

Figure 10 – Calculation model and condition

7.2 Trial calculation method

7.2.1 Conventional air conditioning method

An air conditioner was comprised of cooling coils, a humidifier, and a blower. The air conditioner controlled the flow of chilled water to ensure that the air supplied reached the specified temperature. The humidifier was assumed to be controlled so that humidity reached the specified value.

Static pressure for the air conditioner fan was set at 450 Pa, fan efficiency at 60%, and air temperature at 18°C, and chilled water flow was controlled with a two-way valve.

7.2.2 Outdoor air cooling method

An air conditioner for outdoor air cooling comprises a cooler coil, as well as an evaporative humidifier, electrical heater for heating, and a blower.

During the outdoor air cooling operation, a mixture of outdoor air and indoor return air is humidified by the evaporative humidifier, reducing its temperature adjusting its humidity to a specified value, then, after adjusting its temperature as needed with the electric heater, the air-conditioned air is supplied to the indoor space.

The chilling equipment was an air-cooled chiller, the air conditioner fan was set to a static pressure of 850 Pa, the fan was assumed to be running at 60% efficiency, and the evaporative humidifier was assumed to be running at 80% saturation efficiency. The exhaust fan was set to a static pressure of 300 Pa and was assumed to be running at 60% fan efficiency. In addition, the maximum outdoor air utilization during outdoor air cooling operation was set to one-half of the return air volume.

7.2.3 Evaporative cooling method

The air conditioner comprised cooling coils, a humidifier, and a blower. The evaporative cooling unit comprised an evaporative cooler, a sensible heat exchanger, a circulation fan, and an exhaust fan.

Static pressure for the air conditioner fan was set at 450 Pa, fan efficiency at 60%, circulation fan efficiency static pressure at 300 Pa, circulation fan efficiency at 60%, exhaust fan efficiency static pressure at 600 Pa, exhaust fan efficiency at 60%, and evaporative humidifier unit humidification efficiency at 80%. Chilled water flow was controlled with a two-way valve.

The volume of exterior air used by the evaporative cooling unit was half the air conditioning flow. The interior return air in this half of the air conditioning flow was cooled with exterior air and mixed with the remaining half of the return air for supply to the room. The rated cooling capacity for the evaporative cooling unit was equivalent to 50% of the interior heat load.

7.2.4 Spot cooling method

An air conditioner comprised of cooling coils, a humidifier, and a blower. The spot cooling system comprised a water-cooled condenser to condense the refrigerant and a spot cooling unit. The spot cooling method employed the natural circulation of the refrigerant. The flow of chilled water for the air conditioner was controlled to ensure that air was supplied to the room at the required temperature. The flow of refrigerant in the spot cooling unit is controlled to ensure that the temperature of the air supplied to the cold aisle reaches the specified value.

7.3 Power density and space efficiency

Figure 11 shows a comparison of space efficiency versus power (heat) density for the air conditioning methods described in clause 7.2 above. Power density is the amount of heat generated by the ICT equipment per m^2 of floor area. The greater this value, the greater the installed density of ICT equipment, ensuring a high density data centre. Space efficiency is the proportion of the total floor area occupied by ICT equipment. The greater this value, the more effectively the floor area is used for ICT equipment.

For conventional air-conditioning systems, the outdoor air cooling and evaporative cooling methods, the space efficiency is reduced as the power density is increased. This is because the required cooling capacity of the air-conditioning system increases as the power density increases, so the air conditioner size increases and the required area of the air conditioning equipment room increases. Also, the space efficiency is dramatically reduced when the power density exceeds 1.6 kW/m^2 for the outdoor air cooling method and 1.3 kW/m^2 for the evaporative cooling method, reducing to less than 0.5. This is because in both methods, the air conditioner is installed on the wall side, but as the heat generation increases the cooling capacity of air conditioners on one wall side only becomes insufficient, and it becomes necessary to increase the space to install air conditioners on both wall sides.

On the other hand, with the spot cooling method, the space efficiency is virtually unaffected by increases in the power density. Even at high heat densities, the space efficiency is at a very high value of 0.95 or higher. Also, for all the heat densities calculated, the spot cooling system had the highest space efficiency. This is because the cooling unit that processes the heat generated from the ICT equipment is installed in the space above the server rack, so the floor area occupied by the cooling unit is virtually zero, and it is possible to greatly reduce the floor area required for installation of the air conditioners.

This investigation has shown that, particularly at high power densities, the area of the air conditioning equipment room as required with spot cooling is the smallest, and that space efficiency is high.

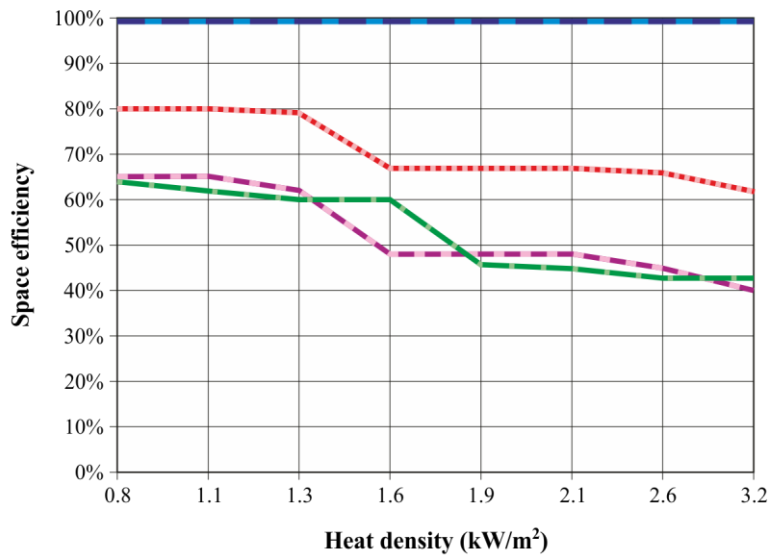

Calculation formula:

Server room floor area ÷ (Server room floor area + Machine room floor area)



L Suppl.11(14)_F11

Figure 11 – Heat density and space efficiency (location Tokyo)

7.4 Outdoor air conditions and air conditioning energy efficiency

Figure 12 shows the results of the calculation of outdoor air wet-bulb temperature conditions and power consumption for conventional air conditioning, outdoor air cooling, evaporative cooling, and spot cooling. This calculation shows the power consumption over a period of one hour at the required outdoor air wet-bulb temperature conditions.

When the outdoor air wet-bulb temperature is at -17°C WB or less, the evaporative cooling method has the lowest electrical power consumption, and when the outdoor air wet-bulb temperature is between -17°C WB and $+15^{\circ}\text{C}$ WB, the outdoor air cooling method has the lowest electrical power consumption. This is because in these temperature ranges, outdoor air can be used for indoor cooling, so in both methods it is possible to greatly reduce the electrical power consumption. However, when the outdoor air wet-bulb temperature is greater than $+15^{\circ}\text{C}$ WB, indoor cooling using outdoor air is not possible, and it has been found that the spot cooling method, which has a high reduction effect of transport power, has the lowest electrical power consumption.

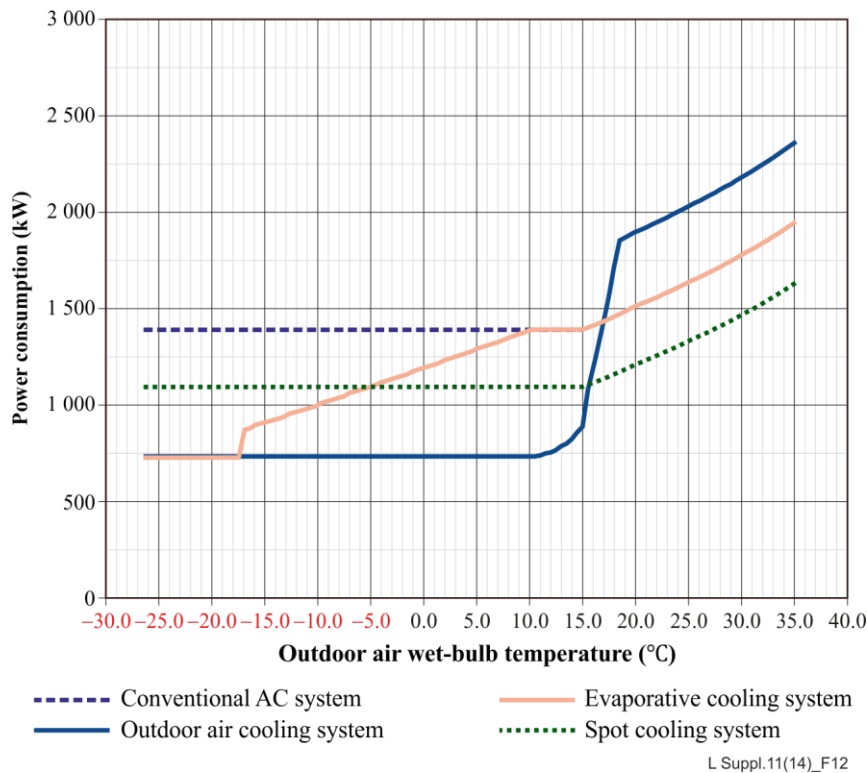

Figure 12 – Comparison of power consumption with outdoor air conditions (Heat density 2 kW/m²)

Figure 13 shows the results of the calculation of outdoor air wet-bulb temperature conditions and energy efficiency for conventional air conditioning, outdoor air cooling, evaporative cooling, and spot cooling. Energy efficiency indicates the amount of heat generated by the ICT equipment which can be handled with 1 kW of air conditioning power. The greater this value the greater the air conditioning energy efficiency.

When the outdoor air wet-bulb temperature is at -17 C WB or less, the energy efficiency of the evaporative cooling method is highest at about 5.5, and when the outdoor air wet-bulb temperature was between -17 C WB and +15 C WB, the energy efficiency of the outdoor air cooling method is highest at 5.0. This is because in these temperature ranges, external air can be used for indoor cooling, so in both methods it is possible to greatly reduce the electrical power consumption. However, when the outdoor air wet-bulb temperature is greater than +15C WB, indoor cooling using external air is not possible, and the spot cooling method, which has a high reduction in transport power effect, has the highest energy efficiency. Also, when the outdoor air wet-bulb temperature is greater than +15C WB, it is found that the chilling system efficiency is reduced with the external air temperature, so the energy efficiency is reduced with an increase in wet-bulb temperature.

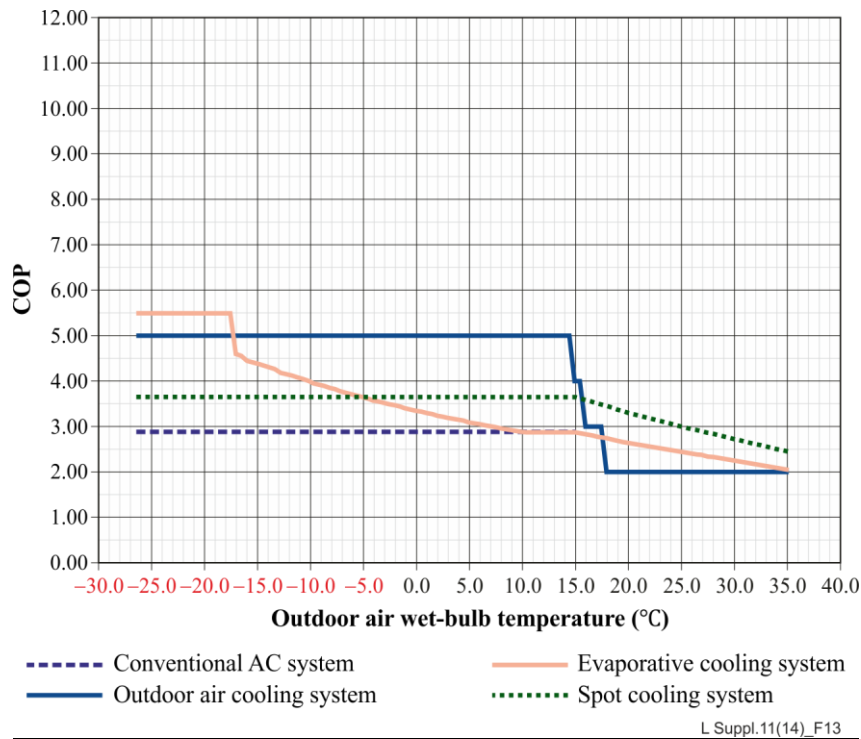

Figure 13 – Comparison of coefficient of performance (COP) with outdoor air conditions (Heat density 2 kW/m²)

7.5 Annual air conditioning power consumption calculated by city

Figure 14 shows a comparison of the annual cooling load ratio in conventional air conditioning, outdoor air cooling, evaporative cooling, and spot cooling.

With outdoor air cooling directly drawing in cold outdoor air, indoor air can be cooled with outdoor air even during the winter in Tokyo and the intermediate period. In comparison with conventional air conditioning, the amount of heat handled can therefore be reduced by 64%. Similarly, even with evaporative cooling using the direct cooling of cold outdoor air, indoor heat can be handled with exterior air cooling during the winter and the intermediate period. In comparison with conventional air conditioning, therefore, the amount of heat handled can be reduced by 13%.

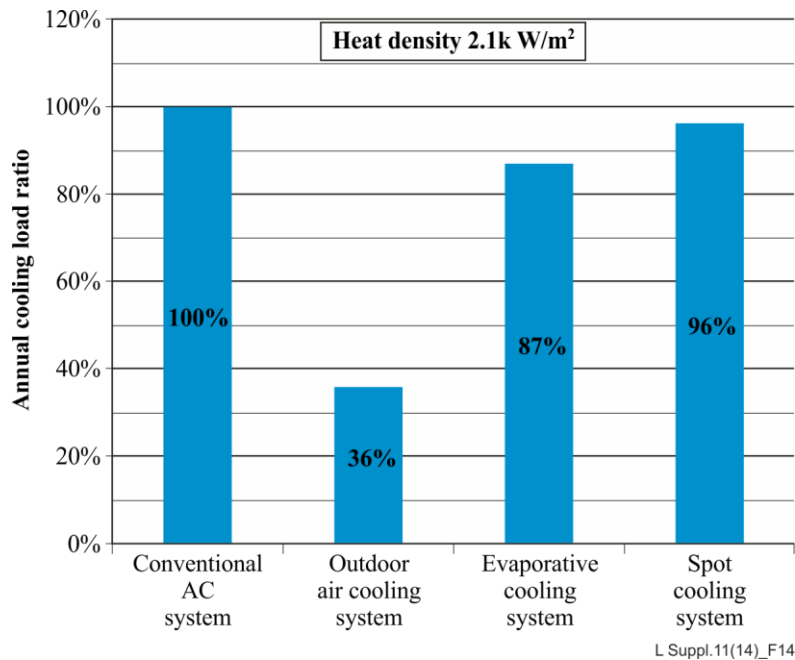

Figure 14 – Comparison of annual cooling load ratio with air conditioning methods in Tokyo

Figure 15 shows the results of the calculation of annual power consumption with conventional air conditioning, outdoor air cooling, evaporative cooling, and spot cooling. With the evaporative cooling method, cooling with outdoor air reduces chilling system power consumption by 57% in comparison with conventional air conditioning. However, the increased power required for the exhaust fan increases transport power, and total air conditioning power consumption is therefore reduced by 15% in comparison with conventional air conditioning. With the evaporative cooling method, the use of cooling with exterior air reduces chilling system power consumption by 11% in comparison with the typical air conditioning method, however the increased power required for the blower to pass air through the evaporative cooling unit greatly increases transport power, and total air conditioning power consumption is therefore reduced by 2% in comparison with the typical air conditioning method.

With the spot cooling method, the use of the natural circulation of refrigerant, and the localized handling of heat with a spot cooling unit, reduced the power necessary for heat transport by 54% in comparison with conventional air conditioning. With this method, the reduction in transport power is considerable, and total air conditioning power consumption can be reduced by 22%.

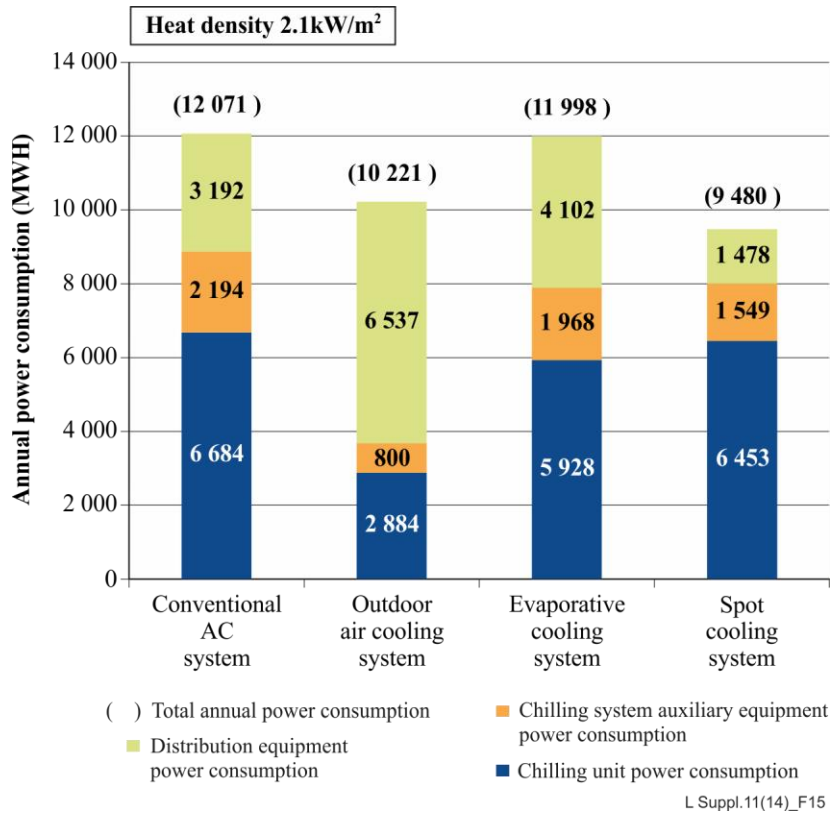

Figure 15 – Comparison of annual power consumption with air conditioning methods in Tokyo

Figure 17 shows the amount of heat handled in six cities with conventional air conditioning, outdoor air cooling, evaporative cooling, and spot cooling. A comparison of the chilling system handling load for each city and each system is shown with the chilling system handling load by a conventional air conditioning system in Tokyo as 100.

It was considered that it would be impossible for outdoor air cooling systems and evaporative cooling systems (which utilize chilled outdoor air), to use the outdoor air in places like Dubai and Singapore, etc., which are in the tropical zone, where air temperature (see Figure 16) and humidity are high year-round. The decrease in chilling system handling loads due to evaporative cooling, which directly uses outdoor air, was found to be considerably broader in outdoor air cooling systems, where the chilling system handling loads in temperate and frigid locations were decreased by 64% in Tokyo, 82% in Moscow, and 98% in London.

Location



Outdoor air temperature

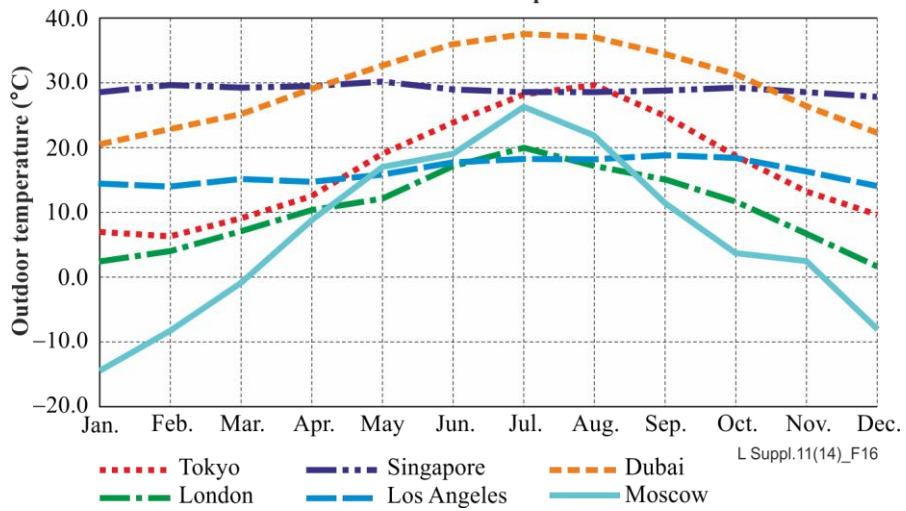

Figure 16 – Calculation of location and outdoor air temperature

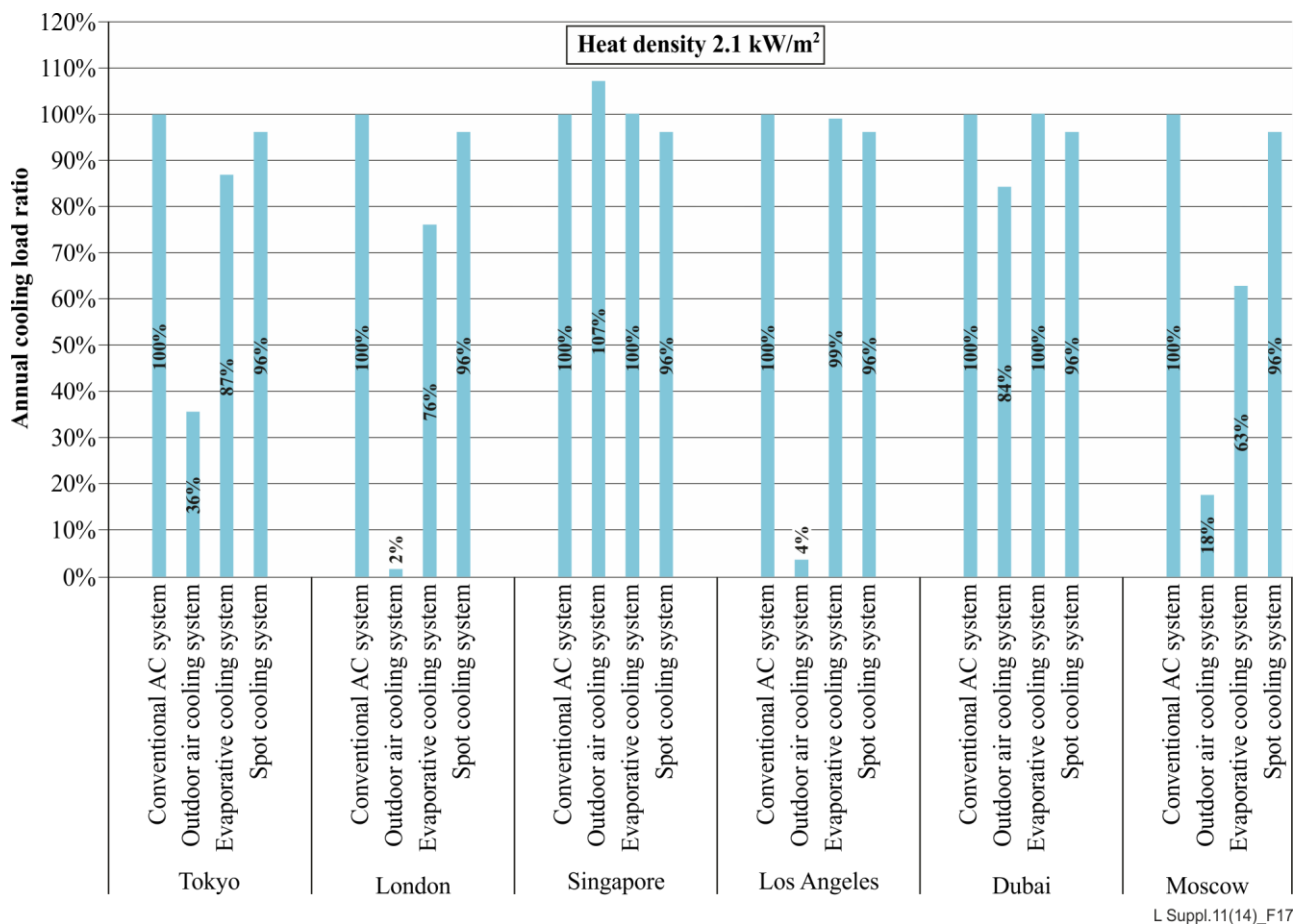

Figure 17 – Comparison of calculating results of annual cooling load ratio with air condition methods in six cities

Figure 18 shows the results of the calculation of annual power consumption for six cities with conventional air conditioning, outdoor air cooling, evaporative cooling, and spot cooling.

Results showed increased power consumption with outdoor air cooling systems and evaporative cooling systems, by chilling outdoor air, in tropical cities such as Dubai and Singapore, where air temperature and humidity are high throughout the year, and outdoor air cannot be used. On the other hand, chilling system power was greatly reduced by effective use of outdoor air with outdoor air cooling in temperate and cold regions, with a reduction in chilling system power of approximately 57% in Tokyo, 78% in Moscow, and 98% in London. However, with nearly double the transport power over conventional air conditioning due to increased air conditioner resistance and the installation of exhaust fans, the reduction in total conditioning power consumption was 28% in Moscow, and 39% in London.

Chilling system power was also reduced with the evaporative cooling system by effective use of outdoor air, and while energy conservation was slightly inferior to that with outdoor air cooling, since only indirect heat exchange is used, the reduction in chilling system power consumption was 35% for a cold location like Moscow and 23% in London. However, since the transport power of the ventilation fan in evaporative cooling units is greater than with conventional air conditioning, the reduction in total air conditioning power consumption was 3% in London, and 8% in Moscow.

With spot cooling, the use of the natural circulation of refrigerant, and the localized handling of heat with a spot cooling unit, reduced the transport power necessary for heat transport dramatically in comparison with conventional air conditioning, and power consumption was able to be reduced to a stable level without being affected by outdoor air conditions. With this method, considerable benefits were obtained through reduction of transport power, even where outdoor air is not effective

(e.g., temperate regions). Reductions of 22% were obtained in tropical Singapore, 21% in London, and 22% in Moscow.

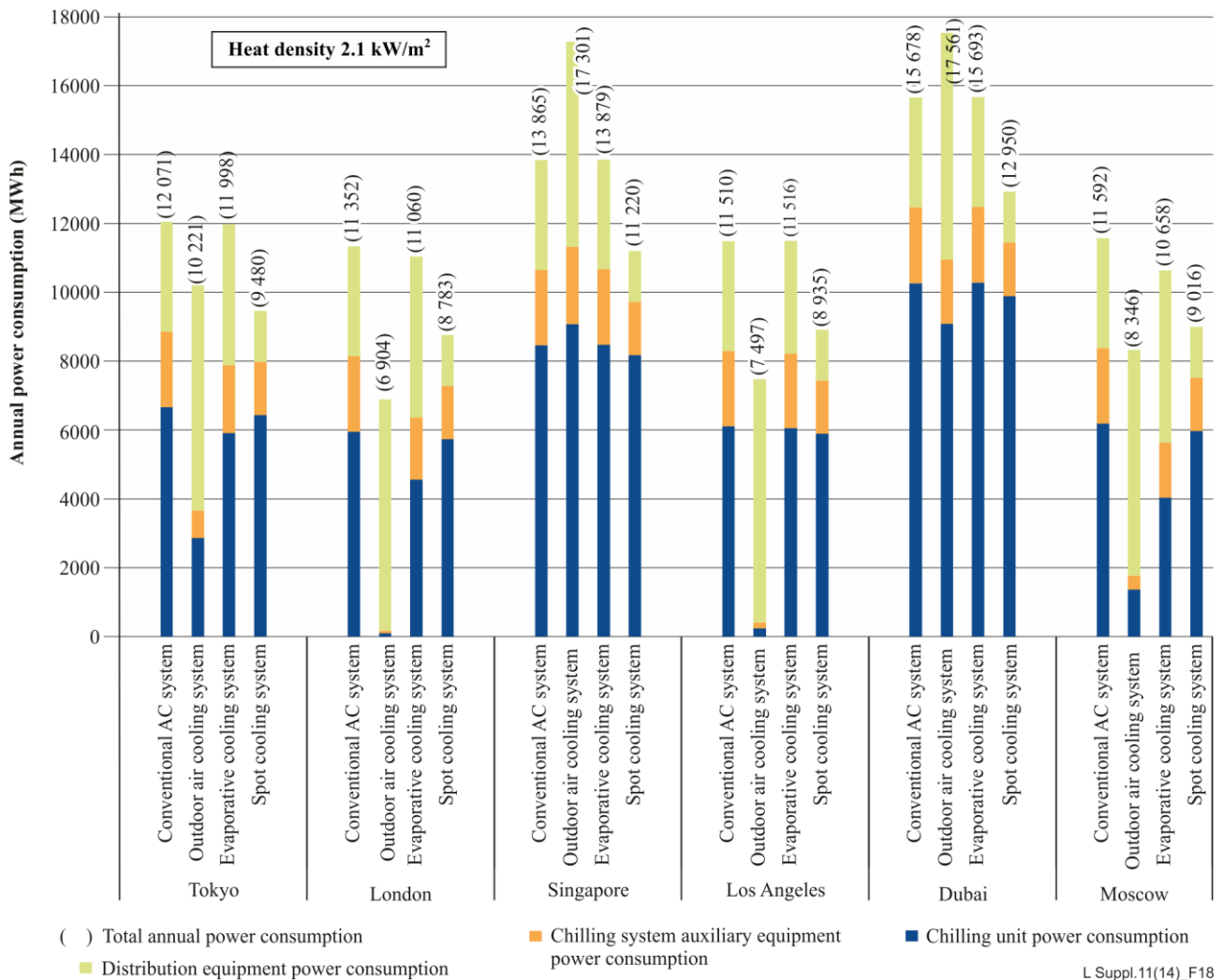

Figure 18 – Comparison of annual power consumption with air conditioning methods in six cities

In this test, it was found that the reduction in power consumption compared with the conventional air conditioning system could be realized with outdoor air cooling, evaporative cooling, and spot cooling.

With outdoor air cooling, benefits were demonstrated in cold regions with low outdoor temperatures, with the greatest energy conservation effects being achieved in London, Los Angeles, and Moscow.

Additionally, with spot cooling, energy conservation benefits were demonstrated irrespective of the region, and were greatest in Tokyo, Singapore, and Dubai.

Bibliography

- [b-ITU-T L.1300] Recommendation ITU-T L.1300 (2011), *Best practices for green data centres*.

SERIES OF ITU-T RECOMMENDATIONS

Series A	Organization of the work of ITU-T
Series D	General tariff principles
Series E	Overall network operation, telephone service, service operation and human factors
Series F	Non-telephone telecommunication services
Series G	Transmission systems and media, digital systems and networks
Series H	Audiovisual and multimedia systems
Series I	Integrated services digital network
Series J	Cable networks and transmission of television, sound programme and other multimedia signals
Series K	Protection against interference
Series L	Construction, installation and protection of cables and other elements of outside plant
Series M	Telecommunication management, including TMN and network maintenance
Series N	Maintenance: international sound programme and television transmission circuits
Series O	Specifications of measuring equipment
Series P	Terminals and subjective and objective assessment methods
Series Q	Switching and signalling
Series R	Telegraph transmission
Series S	Telegraph services terminal equipment
Series T	Terminals for telematic services
Series U	Telegraph switching
Series V	Data communication over the telephone network
Series X	Data networks, open system communications and security
Series Y	Global information infrastructure, Internet protocol aspects and next-generation networks
Series Z	Languages and general software aspects for telecommunication systems