



INTERNATIONAL TELECOMMUNICATION UNION

ITU-T

TELECOMMUNICATION
STANDARDIZATION SECTOR
OF ITU

J.114

(09/99)

SERIES J: TRANSMISSION OF TELEVISION, SOUND
PROGRAMME AND OTHER MULTIMEDIA SIGNALS

Interactive systems for digital television distribution

**Interaction channel using digital enhanced
cordless telecommunications**

ITU-T Recommendation J.114

(Previously CCITT Recommendation)

ITU-T J-SERIES RECOMMENDATIONS

TRANSMISSION OF TELEVISION, SOUND PROGRAMME AND OTHER MULTIMEDIA SIGNALS

General Recommendations	J.1–J.9
General specifications for analogue sound-programme transmission	J.10–J.19
Performance characteristics of analogue sound-programme circuits	J.20–J.29
Equipment and lines used for analogue sound-programme circuits	J.30–J.39
Digital encoders for analogue sound-programme signals	J.40–J.49
Digital transmission of sound-programme signals	J.50–J.59
Circuits for analogue television transmission	J.60–J.69
Analogue television transmission over metallic lines and interconnection with radio-relay links	J.70–J.79
Digital transmission of television signals	J.80–J.89
Ancillary digital services for television transmission	J.90–J.99
Operational requirements and methods for television transmission	J.100–J.109
Interactive systems for digital television distribution	J.110–J.129
Transport of MPEG-2 signals on packetised networks	J.130–J.139
Measurement of the quality of service	J.140–J.149
Digital television distribution through local subscriber networks	J.150–J.159

For further details, please refer to ITU-T List of Recommendations.

ITU-T RECOMMENDATION J.114

INTERACTION CHANNEL USING DIGITAL ENHANCED CORDLESS TELECOMMUNICATIONS

Summary

This Recommendation is the baseline specification for the provision of an interaction channel using the Digital Enhanced Cordless Telecommunications (DECT) Standard in conjunction with a digital broadcasting delivery medium. It is suitable for use with any broadcast transmission medium, such as cable, satellite, terrestrial, etc., thus ensuring the maximum degree of interoperability and economies of scale.

Source

ITU-T Recommendation J.114 was prepared by ITU-T Study Group 9 (1997-2000) and was approved under the WTSC Resolution No. 1 procedure on 16 September 1999.

FOREWORD

ITU (International Telecommunication Union) is the United Nations Specialized Agency in the field of telecommunications. The ITU Telecommunication Standardization Sector (ITU-T) is a permanent organ of the ITU. The ITU-T is responsible for studying technical, operating and tariff questions and issuing Recommendations on them with a view to standardizing telecommunications on a worldwide basis.

The World Telecommunication Standardization Conference (WTSC), which meets every four years, establishes the topics for study by the ITU-T Study Groups which, in their turn, produce Recommendations on these topics.

The approval of Recommendations by the Members of the ITU-T is covered by the procedure laid down in WTSC Resolution No. 1.

In some areas of information technology which fall within ITU-T's purview, the necessary standards are prepared on a collaborative basis with ISO and IEC.

NOTE

In this Recommendation, the expression "Administration" is used for conciseness to indicate both a telecommunication administration and a recognized operating agency.

INTELLECTUAL PROPERTY RIGHTS

The ITU draws attention to the possibility that the practice or implementation of this Recommendation may involve the use of a claimed Intellectual Property Right. The ITU takes no position concerning the evidence, validity or applicability of claimed Intellectual Property Rights, whether asserted by ITU members or others outside of the Recommendation development process.

As of the date of approval of this Recommendation, the ITU had not received notice of intellectual property, protected by patents, which may be required to implement this Recommendation. However, implementors are cautioned that this may not represent the latest information and are therefore strongly urged to consult the TSB patent database.

© ITU 2000

All rights reserved. No part of this publication may be reproduced or utilized in any form or by any means, electronic or mechanical, including photocopying and microfilm, without permission in writing from the ITU.

CONTENTS

	<i>Page</i>
1 Scope	1
2 References	1
2.1 Normative references	1
2.2 Informative references	1
3 Abbreviations.....	2
4 Reference model	3
4.1 Protocol stack model	3
4.2 System model	4
5 DVB interaction channel specification for DECT	4
5.1 System architecture	5
5.2 Physical interfaces.....	5
5.3 Calling procedures	5
5.4 DECT profiles	5
5.5 Forced disconnection	7
Appendix I – Basic characteristics of DECT	7
I.1 DECT introduction.....	7
I.2 DECT standard.....	8
I.3 Profiles	11
I.4 Wireless Relay Station (WRS).....	14
I.5 DECT Authentication Module (DAM)	14
Appendix II – DECT implementation alternatives.....	15

Introduction

This Recommendation, for the use of the DECT system to provide an interaction channel for a digital broadcasting service, is not transmission medium specific. It can be used with any of the broadcast transmission media currently standardized by the ITU. It is consistent with the generic reference model described in Recommendation J.110, and the network independent protocols in Recommendation J.111.

INTERACTION CHANNEL USING DIGITAL ENHANCED CORDLESS TELECOMMUNICATIONS

(Geneva, 1999)

1 Scope

This Recommendation is the baseline specification for the provision of an interaction channel based on the Digital Enhanced Cordless Telecommunications (DECT) to Digital Video Broadcasting (DVB) systems.

This Recommendation does not intend to specify an interaction channel solution associated to each broadcast system because the interoperability of different delivery media to transport the interaction channel is desirable. Therefore, the DECT solution for the interaction channel applies to satellite, cable, MATV, Satellite Master Antenna TeleVision (SMATV), terrestrial, microwave or any future DVB broadcasting or distribution system.

The solutions provided in this Recommendation for an interaction channel through the DECT are a part of a wider set of alternatives to implement interactive services for DVB systems.

2 References

The following ITU-T Recommendations and other references contain provisions which, through reference in this text, constitute provisions of this Recommendation. At the time of publication, the editions indicated were valid. All Recommendations and other references are subject to revision; all users of this Recommendation are therefore encouraged to investigate the possibility of applying the most recent edition of the Recommendations and other references listed below. A list of the currently valid ITU-T Recommendations is regularly published.

2.1 Normative references

- [1] ITU-T Recommendation J.110 (1997), *Basic principles for a worldwide common family of systems for the provision of interactive television services.*
- [2] ITU-T Recommendation J.111 (1998), *Network independent protocols for interactive systems.*
- [3] EN 50201:1998, *Interfaces for DVB-IRD*, CENELEC.
- [4] ETS 300 765-2 (1998), *Digital Enhanced Cordless Telecommunications (DECT); Radio in the Local Loop (RLL) Access Profile (RAP); Part 2: Advanced telephony services.*
- [5] EN 301 240 (1998), *Digital Enhanced Cordless Telecommunications (DECT); Data Services Profile (DSP); Point-to-Point Protocol (PPP) interworking for internet access and general multi-protocol datagram transport.*
- [6] ETS 300 700 (1997), *Digital Enhanced Cordless Telecommunications (DECT); Wireless Relay Station (WRS).*

2.2 Informative references

- [7] ETS 300 765-1 (1997), *Digital Enhanced Cordless Telecommunications (DECT); Radio in the Local Loop (RLL) Access Profile (RAP); Part 1: Basic telephony services.*
- [8] ETS 300 444 (1995), *Digital Enhanced Cordless Telecommunications (DECT); Generic Access Profile (GAP).*
- [9] ETS 300 822 (1998), *Digital Enhanced Cordless Telecommunications (DECT); Integrated Services Digital Network (ISDN); DECT/ISDN Interworking for intermediate system configuration; Interworking and profile specification.*

- [10] ETR 308 (1996), *Digital Enhanced Cordless Telecommunications (DECT); Services, facilities and configurations for DECT in the local loop.*
- [11] ETR 185 (1995), *Digital Enhanced Cordless Telecommunications (DECT); Data Services Profile (DSP); Profile overview.*
- [12] ETS 300 651 (1996), *Digital Enhanced Cordless Telecommunications (DECT); Data Services Profile (DSP); Generic data link service; (service type C, class 2).*
- [13] ETS 300 701 (1996), *Digital Enhanced Cordless Telecommunications (DECT); Data Services Profile (DSP); Generic frame relay service with mobility (service types A and B, class 2).*

3 Abbreviations

This Recommendation uses the following abbreviations:

A/V	Audio/Video
BC	Broadcast Channel
CI	Common Interface
CTA	Cordless Terminal Adapter
DAM	DECT Authentication Module
DECT	Digital Enhanced Cordless Telecommunications
DSP	Data Services Profile
EMC	Electromagnetic Compatibility
FP	Fixed Part
FT	Fixed Termination
GAP	Generic Access Profile
IC	Interaction Channel
IIM	Interactive Interface Module
IN	Interactive Network
INA	Interactive Network Adapter
IRD	Integrated Receiver Decoder
ISDN	Integrated Services Digital Network
IWU	Inter-Working Unit
LAP	Link Access Protocol
LLME	Lower Layer Management Entity
MAC	Medium Access Control
MATV	Master Antenna Television
NIU	Network Interface Unit
NTU	Network Termination Unit
NWK	Network
OSI	Open Systems Interconnection
PHL	Physical
PP	Portable Part
PPP	Point-to-Point Protocol
PSTN	Public Switched Telephone Network
RAP	Radio in the local loop Access Profile
RF	Radio Frequency

RLL	Radio in the Local Loop
SMATV	Satellite Master Antenna TeleVision
STB	Set-Top Box
STU	Set-Top Unit
WRS	Wireless Relay Station

4 Reference model

A reference model for the system architecture of narrow-band interaction channels in a broadband scenario (asymmetric interactive services) is presented in this clause. [1]

4.1 Protocol stack model

Within the Digital Video Broadcasting (DVB) commercial requirements for asymmetric interactive services supporting broadcast to the home with narrow-band return channel (see DVB-A008 [7]), a simple communications model has been used to identify the necessity and importance of each commercial requirement consisting of the following layers (the layers do not coincide exactly with the Open Systems Interconnection (OSI) layers):

- *Physical layer*: where all the physical (electrical) transmission parameters are defined.
- *Transport layer*: defines all the relevant data structures and communication protocols like data containers, etc.
- *Application layer*: is the interactive application software and runtime environment (e.g. home shopping application, script interpreter, etc.).

This Recommendation addresses the lower two layers (the physical and transport layers), leaving the application layer open to competitive market forces. A simplified model of the OSI layers was adopted to facilitate the production of specifications for these nodes. Figure 1 points out the lower layers of the simplified model and identifies some of the key parameters. Following the user requirements for interactive services, no attempt will be made to consider higher layers in this Recommendation.

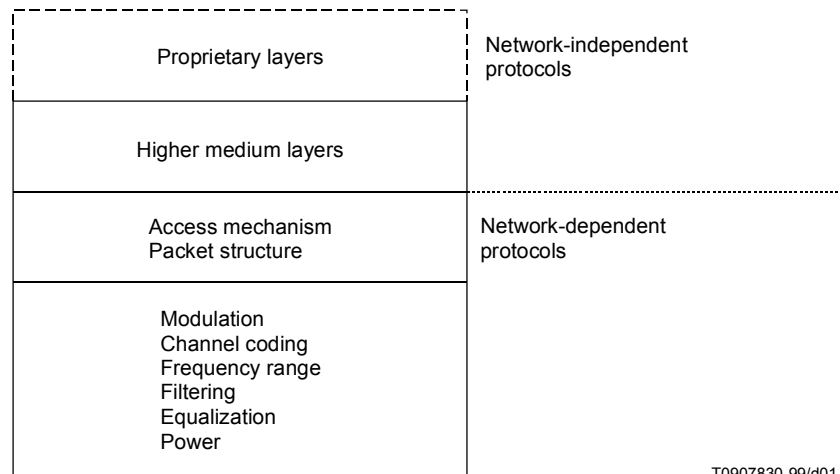

Figure 1/J.114 – Layer structure for generic system reference model

This Recommendation addresses the Digital Enhanced Cordless Telecommunications (DECT) specific aspects only. The network-independent protocols are specified separately in Recommendation J.111 [2].

4.2 System model

Figure 2 shows the system model which is to be used within DVB for interactive services. In the system model, two channels are established between the service provider and the user:

- a) *Broadcast Channel (BC)*: A unidirectional broadband BC including video, audio and data. BC is established from the service provider to the users. It may include the forward interaction path.
- b) *Interaction Channel (IC)*: A bidirectional interaction channel is established between the service provider and the user for interaction purposes. It is formed by:
 - *Return interaction path* (return channel): From the user to the service provider. It is used to make requests to the service provider or to answer questions. It is a narrow-band channel. Also commonly known as return channel.
 - *Forward interaction path*: From the service provider to the user. It is used to provide some sort of information by the service provider to the user and any other required communication for the interactive service provision. It may be embedded into the broadcast channel. It is possible that this channel is not required in some simple implementations which make use of the BC for the carriage of data to the user.

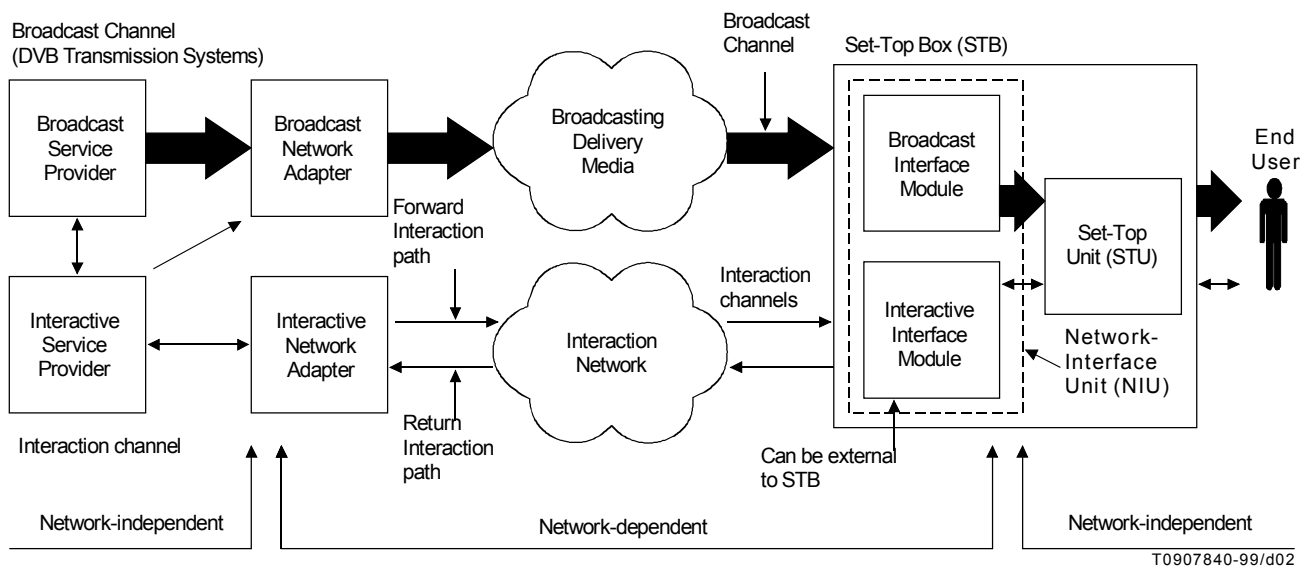

Figure 2/J.114 – A generic system reference model for interactive systems

The user terminal, here named Set-Top Box (STB), is formed by the:

- a) Network Interface Unit (NIU), consisting of the:
 - 1) Broadcast Interface Module (BIM);
 - 2) Interactive Interface Module (IIM); and
- b) Set-Top Unit (STU).

The user terminal provides interfaces for both broadcast and interaction channels. The interface between the user terminal and the interaction network is via the IIM.

5 DVB interaction channel specification for DECT

A DECT infrastructure can support the implementation of the interaction channel for DVB broadcasting systems by providing a wireless bidirectional communication path between the user terminal and an infrastructure connecting to the service provider.

The basic characteristics of DECT are described in Appendix I.

5.1 System architecture

The Interactive Interface Module (IIM) is implemented through a DECT Portable Part (PP) (see Figure 3). The DECT PP can be internal or external to the STB.

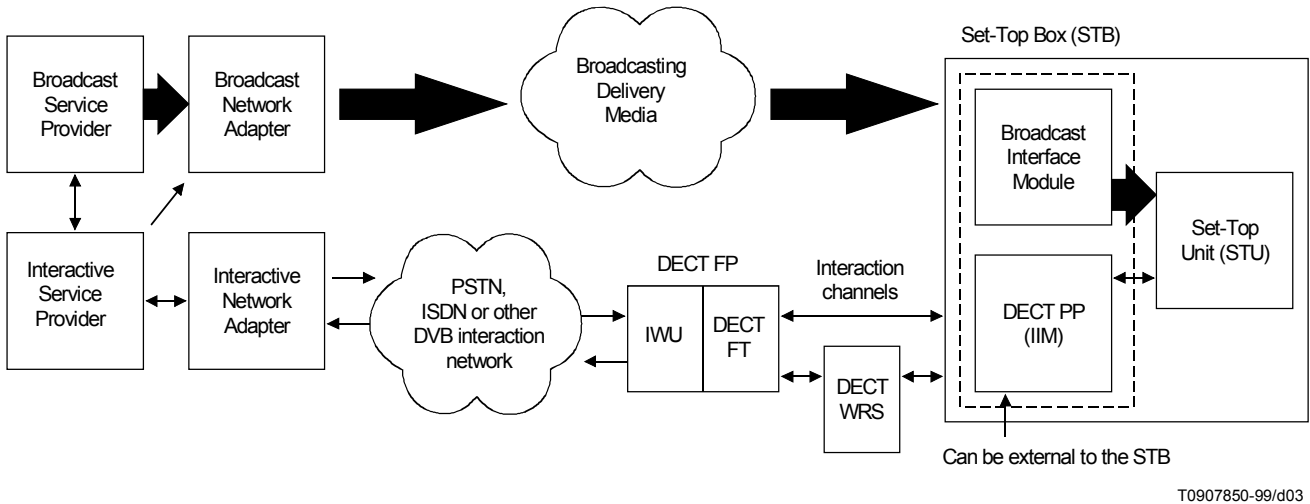

Figure 3/J.114 – System architecture when DECT is used as the interaction channel

DECT is a wireless access technology, not a complete network or system. Therefore, DECT Fixed Parts (FP) are part of the interaction network. A DECT FP includes an Inter-Working Unit (IWU) which handles the interconnection of DECT with the Interactive Network Adapter (INA) via another interaction network.

5.2 Physical interfaces

The physical interfaces relate to how the DECT PP is connected to the STU, how the DECT FP is connected to other interaction networks and the wireless physical interfaces between DECT PP, DECT FP and DECT Wireless Relay Stations (WRS). The DECT profiles specify the physical interfaces for different services and applications (see 5.4).

In the case of a DECT PP external to the STB, the DVB-IRD interfaces are described in EN 50201 [3].

5.3 Calling procedures

The signalling protocols are specified by the DECT profiles (see 5.4).

5.4 DECT profiles

The connection of DECT to different networks, the operation of the DECT air interface and the signalling protocols for specific services and applications are described in the DECT profiles. A DVB operator using DECT as the interaction channel should use DECT profiles. Several DECT profiles can be supported in a DECT system, which means that other profiles can be supported in parallel with the profile used to carry the DVB network-independent protocols for interactive services (see Recommendation J.111 [2]).

The default implementations described in 5.4.1 and 5.4.2 are based on the Radio in the local loop Access Profile (RAP) (see ETS 300 765-2 [4] and the Data Services Profile (DSP) PPP interworking (see EN 301 240 [5]). The RAP offers valuable operation and maintenance functions. DSP PPP interworking offers effective handling of data traffic and describes the interworking to different fixed networks. When accessing an external DECT infrastructure, RAP functions are used in combination with the DSP PPP interworking.

Due to the flexible nature of the DECT standard, several other implementation possibilities exist. Some of the implementation alternatives are described in Appendix II.

5.4.1 Recommended DECT profiles when the DECT infrastructure is external to the home

The RAP (see ETS 300 765-1 [7] and ETS 300 765-2 [4]) describe how DECT is used in Radio in the Local Loop (RLL) scenarios.

It is recommended that the IIM is represented by a DECT PP internal to the STB with a RAP Data service (see ETS 300 765-2 [4]) according to the DSP PPP interworking (see EN 301 240 [5]) implemented, when the interaction channel is through a DECT infrastructure, external to the home (see Figure 4).

The DECT PP (IIM) communicates with a DECT RAP data service (DSP PPP interworking) infrastructure comprised of FPs and possible WRSs (see ETS 300 700 [6]).

A WRS relays intelligently the DECT signals between DECT FPs and DECT PPs. This STB implementation should be the default implementation when DECT is used as the interaction channel in DVB.

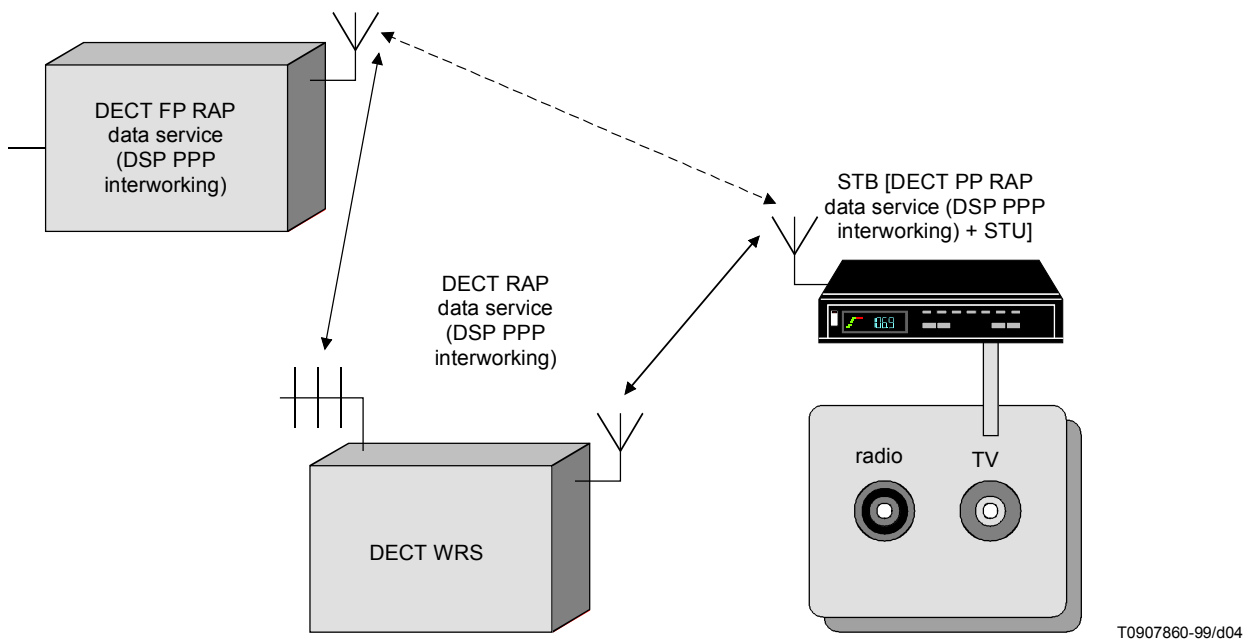

NOTE – A DECT PP, supporting a RAP data service (DSP PPP interworking), is implemented in the STB. The STB communicates either directly with an FP (dashed line) or via a WRS (unbroken line). The WRS can be located internal to the home.

Figure 4/J.114 – Default implementation of an interaction channel through a DECT infrastructure, external to the home

5.4.2 Recommended DECT profiles when the DECT infrastructure is internal to the home

DECT can be used in the home as a wireless interface to a network. In Figure 5, a home DECT FP is connected to a fixed network interface and provides the STB with a wireless interaction channel. The DECT STB implementation is the same as when the DECT FP is external to the home. The DECT PP RAP data service (DSP PPP interworking) terminal should notice that the home FP does not support RAP features, and therefore not use the RAP procedures. This STB implementation should be the default implementations when DECT is used as the interaction channel in DVB.

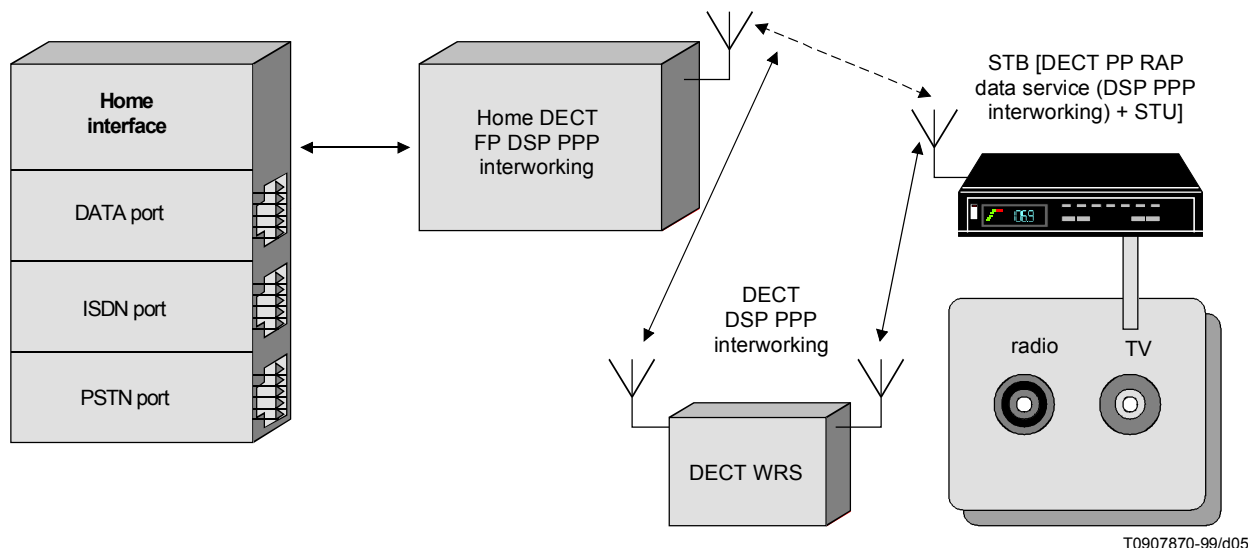

NOTE – A DECT PP, supporting a RAP data service (DSP PPP interworking), is implemented in the STB. The STB communicates either directly with an FP (dashed line) or via a WRS (unbroken line).

Figure 5/J.114 – Default implementation of an interaction channel through a DECT infrastructure, internal to the home

5.5 Forced disconnection

In an implementation incorporating connections to the Public Switched Telephone Network (PSTN), the communication on the interaction channel should not block an emergency call attempt. The DECT profiles allow this functionality in several ways. If not implemented, the application should allow a forced disconnection in the case of an emergency call.

Appendix I

Basic characteristics of DECT

I.1 DECT introduction

DECT is a general radio access technology that can be used by many different applications to connect to different telecommunication networks.

DECT offers both telephony and data communication services to users within the coverage area. The system is based on a micro-cellular concept that provides low-power radio access between portable parts and DECT fixed parts at ranges up to a few kilometres.

DECT equipment is commercially available.

The basic technical characteristics of DECT are as follows:

Frequency band:	1880 to 1900 MHz (extended frequency band is under investigation).	
Carriers:	10 × 1728 MHz.	
Carrier multiplex:	TDMA (Time Division Multiple Access), 24 full slots per frame (which can form 12 duplex channels).	
Peak transmit power:	250 mW.	
Modulation:	GFSK (Gaussian Frequency Shift Keying), BT (Bandwidth Time product) = 0.5.	
Frame length:	10 ms.	
Basic duplexing:	TDD (Time Division Duplex) using two slots on the same carrier.	
Gross bit rate:	1152 kbit/s per carrier.	
Net bit rates:	8 kbit/s	B-field (traffic) per half slot (unprotected mode);
	6.4 kbit/s	B-field (traffic) per half slot (protected mode);
	32 kbit/s	B-field (traffic) per full slot (unprotected mode);
	25.6 kbit/s	B-field (traffic) per full slot (protected mode);
	80 kbit/s	B-field (traffic) per double slot (unprotected mode);
	64 kbit/s	B-field (traffic) per double slot (protected mode);
	6.4 kbit/s	A-field (control/signalling) per half slot, slot and double slot.

DECT has features that could be suitable in an interactive DVB system.

DECT can handle a lot of users in a small area (urban and suburban situation) and support a broad range of services.

DECT has algorithms for authentication of both the base station and the terminal as well as a simple encryption scheme DECT Authentication Module [(DAM) card support].

A Wireless Relay Station (WRS) can be used to extend the coverage.

There is no need for traditional frequency planning as DECT uses dynamic channel selection.

In the rest of this appendix, more information is provided concerning the main functionality of the DECT standard.

I.2 DECT standard

The structure of the basic DECT standard (see ETS 300 175 parts 1 to 9) is based on the layered principles used in the ISO Open Systems Interconnection (OSI) model. The complete DECT Common Interface (CI) corresponds to the lower three layers of the ISO OSI model, but DECT defines four layers of protocol. These lower layers differ from the OSI model because the OSI model takes no account of either the uncertainties introduced by using radio transmissions at the physical layer or of the concept of handover.

A structure of four layers is used for the signalling protocols as shown in Figure I.1.

The top of the NWK layer corresponds to the top of the OSI layer 3. The intermediate boundaries have no OSI equivalent but for ease of understanding an approximate correspondence is given below:

- OSI Layer 1: all of the PHL layer plus part of the MAC layer;
- OSI Layer 2: most of the MAC layer plus all of the DLC;
- OSI Layer 3: all of the NWK layer.

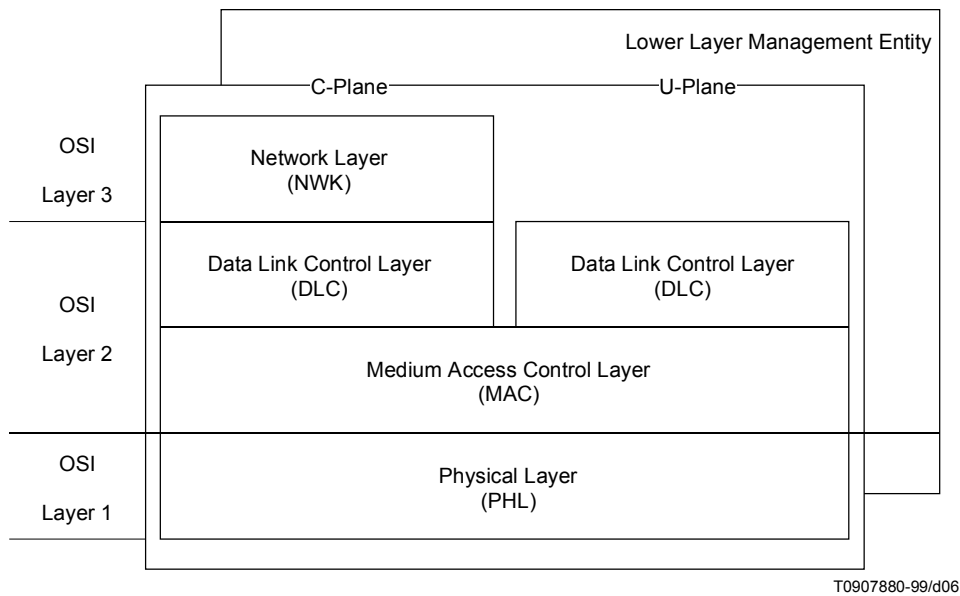

Figure I.1/J.114 – The DECT layered structure

I.2.1 Physical (PHL) layer

The physical layer divides the radio spectrum into the physical channels. This division occurs in two fixed dimensions, frequency and time. The frequency and time division uses Time Division Multiple Access (TDMA) operation on multiple RF carriers. Ten carriers are provided in the frequency band 1880 MHz to 1900 MHz.

DECT also provides for possible extensions of the band to meet future demand. On each carrier the TDMA structure defines 24 time slots (when full slots are used) in a 10 ms frame, where each time slot may be used to transmit one self contained packet of data (see Figure I.2).

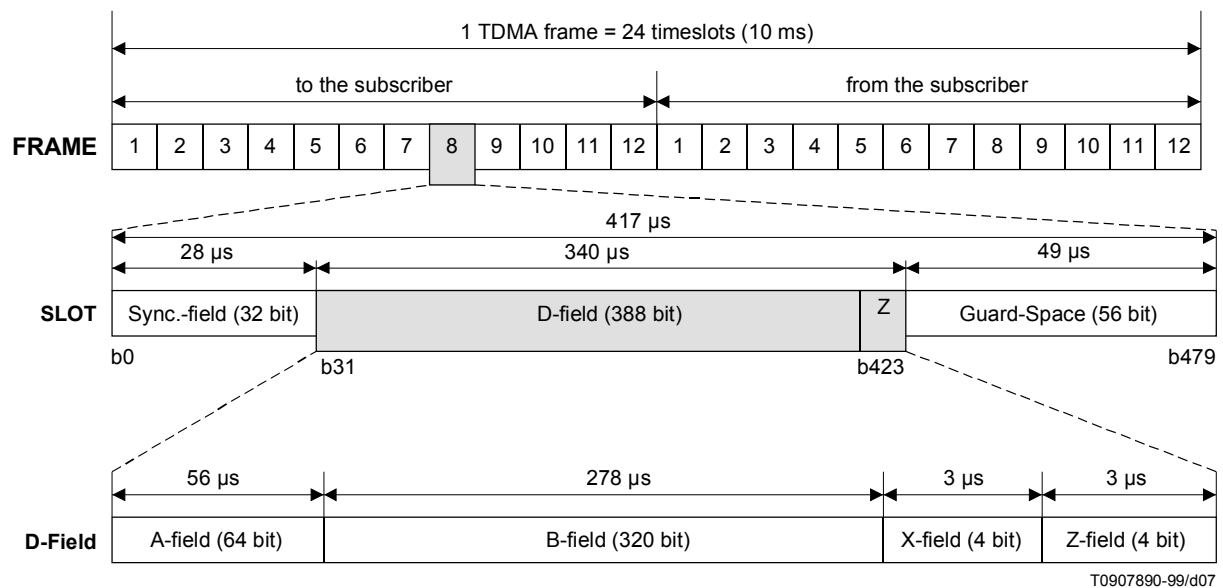

Figure I.2/J.114 – Example of the full slot framing structure

Each transmitted packet contains a synchronization field, together with control information, service information and error control.

Each FP radio end point operates according to a local timing reference and the PHL is the responsible for transmitting packets of data under direct control of the MAC layer. Adjacent FPs may be synchronized. This provides some advantages, particularly in high traffic situations.

I.2.2 Medium Access Control (MAC) layer

The MAC layer performs two main functions. Firstly, it selects physical channels, and then establishes and releases connections on those channels. Secondly, it multiplexes (and demultiplexes) control information, together with higher layer information and error control information, into slot-sized packets.

These functions are used to provide three independent services: a broadcast service, a connection oriented service and a connectionless service.

The broadcast service is a special DECT feature: it multiplexes a range of broadcast information into a reserved field (the A-field), and this field appears as part of all active transmissions. The broadcast service is always transmitted in every cell (even in the absence of user traffic) on at least one physical channel. These "beacon" transmissions allow PPs to quickly identify all FPs that are within range, to select one, and to lock to it without requiring any portable transmissions.

I.2.3 Data Link Control (DLC) layer

The DLC layer is concerned with the provision of very reliable data links to the NWK layer. Many of the imperfections of the radio transmissions are already removed by the efforts of the MAC layer, and the DLC layer is designed to work closely with the MAC layer to provide higher levels of data integrity than can be provided by the MAC layer alone.

The DECT layered model separates into two planes of operation at the DLC layer: the C-plane and the U-plane.

The C-plane is common to all applications, and provides very reliable links for the transmission of internal control signalling and limited quantities of user information traffic. Full error control is provided with a balanced Link Access Protocol (LAP).

The U-plane provides a family of alternative services, where each service is optimized to the particular need of a specific type of services. The simplest service is the transparent unprotected service used for speech transmission.

Other services support circuit mode and packet mode data transmission, with varying levels of protection.

I.2.4 Network (NWK) layer

The NWK layer is the main signalling layer of the protocol. It adopts a similar style to the ISDN layer 3 protocol and offers a similar level of functions. The NWK layer operates using an exchange of messages between peer entities.

The basic set of messages supports the establishment, maintenance and release of calls. Additional messages support a range of extended capabilities.

The basic Call Control (CC) provides a circuit switched service selected from one of the range of DLC options.

Other network layer services are Supplementary Services (SS), Connection-oriented Message Service (COMS), ConnectionLess Message Service (CLMS) and Mobility Management (MM). These services are arranged as independent entities, and a particular application can be realized using more than one.

The MM is a particularly important group of services. This group contains the procedures that support the special cordless mobility of PPs, for example authentication and location registration.

I.2.5 Lower Layer Management Entity (LLME)

The LLME contains defined procedures that concern more than one layer. Most of these procedures have only local significance, and they are defined in general terms to allow for alternative implementations. The location of some selected LLME procedures is as follows:

- MAC layer: Creation, maintenance and release of bearers, by activating and deactivating pairs of physical channels; physical channel management, including the choice of free physical channels and the assessment of the quality of received signals.
- DLC layer: Connection management, which includes the establishment and release of connections in response to NWK layer demands; routing of C-plane and U-plane data to suitable connections.
- NWK layer: Service negotiation and mapping.

I.2.6 Inter-Working Units (IWU)

Transport of the information to the end user requires additional layers of protocol. In general, an IWU will be required to provide the necessary interworking functions. This IWU plays a important role in defining the exact service that is provided, e.g. when interconnecting to other networks as the PSTN or the ISDN.

I.3 Profiles

The basic DECT standard defines the operation of the DECT air interface and is very general. To achieve interoperability for specific applications, different profiles have been defined or are in progress of being defined, e.g. the Generic Access Profile (GAP), the DECT/ISDN interworking profiles, the DECT data services profiles, the DECT/GSM (Global System for Mobile communications) interworking profile and the DECT radio in the local loop access profile.

A DECT profile standard is a chosen subset of the DECT CI standard for a specific application. It includes all requirements for interoperability for equipment from different manufacturers. If the CI standard has some ambiguity or lacks some provision, this is clarified or added in the profile standard. All defined features are process mandatory. This means that if a feature is used, it is used in a specified manner. Whether the provision of a feature is mandatory or optional is stated separately for FPs and PPs.

I.3.1 Radio in the local loop Access Profile (RAP)

Radio in the Local Loop (RLL) is also defined in the DECT standard. The RLL Access Profile (RAP) is standardized in two parts (see ETS 300 765-1 [7] and ETS 300 765-2 [4]).

ETS 300 765-1 [7] handles PSTN, analogue leased lines and 64 kbit/s bearer service. It also provides for optional mobility features by supporting GAP PP subscriber terminals and Cordless Terminal Adapter (CTAs) with WRS GAP functionality. For documents relating to RLL (basic telephony via PSTN), see Figure I.3.

The second part contains telecommunication services as offered by ISDN, contemporary non-voice band data services provided through for example a dedicated data port at the CTA, and support of digital leased lines. The provision of the mentioned services is not mandated by the second part of the standard, but if they are provided they shall be provided as defined. For documents relating to RLL (advanced telephony), see Figure I.4.

An objective is to use as much as possible for the RLL from existing profiles: the GAP profile (see ETS 300 444 [8] DECT-ISDN Intermediate System as defined in ETS 300 822 [9]) the data profiles, e.g. A/B.2 as defined in ETS 300 701 [13] and C.2. Therefore, most of the RAP features refer to features defined in other profiles and only the necessary additional features are listed and explained in the RAP document.

The DECT RLL services are examined in detail in ETR 308 [10]. This ETR identifies the basic wired analogue PSTN services that could be replaced by an RLL system, and also identifies that there are market opportunities for much more advanced services than are possible with today's standard telephones.

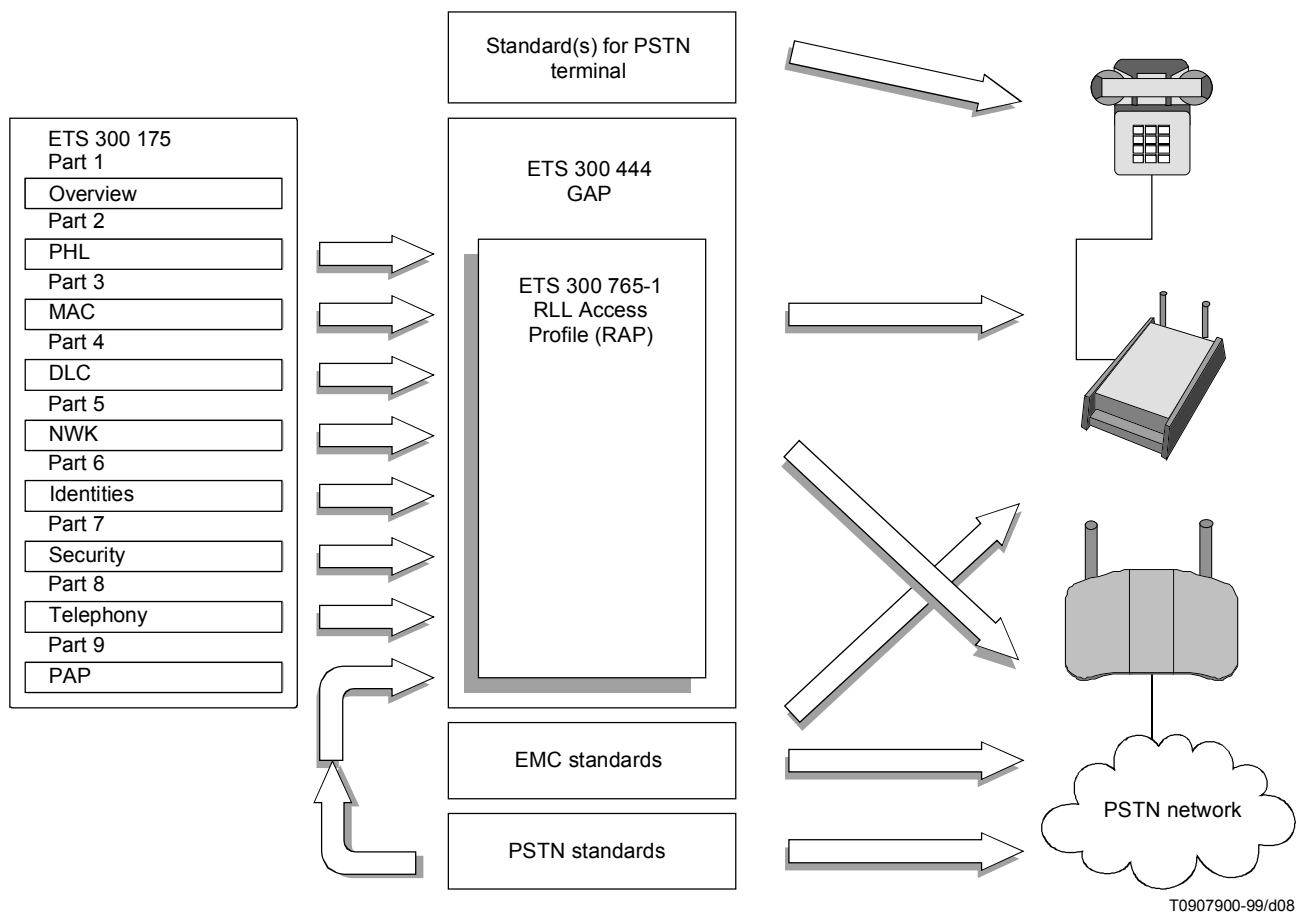

Figure I.3/J.114 – Documents relating to RLL (basic telephony via PSTN)

I.3.2 Data Services Profiles (DSP)

The DECT standard includes data services. The services and relationships of the different profiles are described in ETR 185 [11]. The DSP are a family of profiles which build upon and extend each other, aimed at the general connection of terminals supporting non-voice services to a fixed infrastructure, private and public. The application decides which type to use, due to parameters such as data rate, latency, reliability and power consumption. They all exploit the powerful lower-layer data services of DECT, which are specifically oriented towards LAN, multimedia and serial data capability, but each member of the profile family has been optimized for a different kind of user service. The DSP are divided into six service types and two mobility classes:

- Type A: Low-speed frame relay, with a net sustainable throughput of up to 24 kbit/s, optimized for bursty data, low power consumption and low complexity applications such as handportable equipment.
- Type B: High-performance frame relay, with a net sustainable throughput of up to 552 kbit/s asymmetrically or 288 kbit/s symmetrically, optimized for high speed and low latency with bursty data. Equipment implementing the type B profile shall interoperate with type A equipment.
- Type C: Non-transparent connection of data streams requiring Link Access Protocol (LAP) services, optimized for high reliability and low additional complexity. Type C builds upon the services offered by the type A/B profiles. Provision for a packet assembly/disassembly function for asynchronous data streams is also included.
- Type D: Transparent and isochronous connection of synchronous data streams optimized for interworking applications requiring continuous data streams.
- Type E: A short message transfer or paging service which may be unacknowledged or acknowledged.

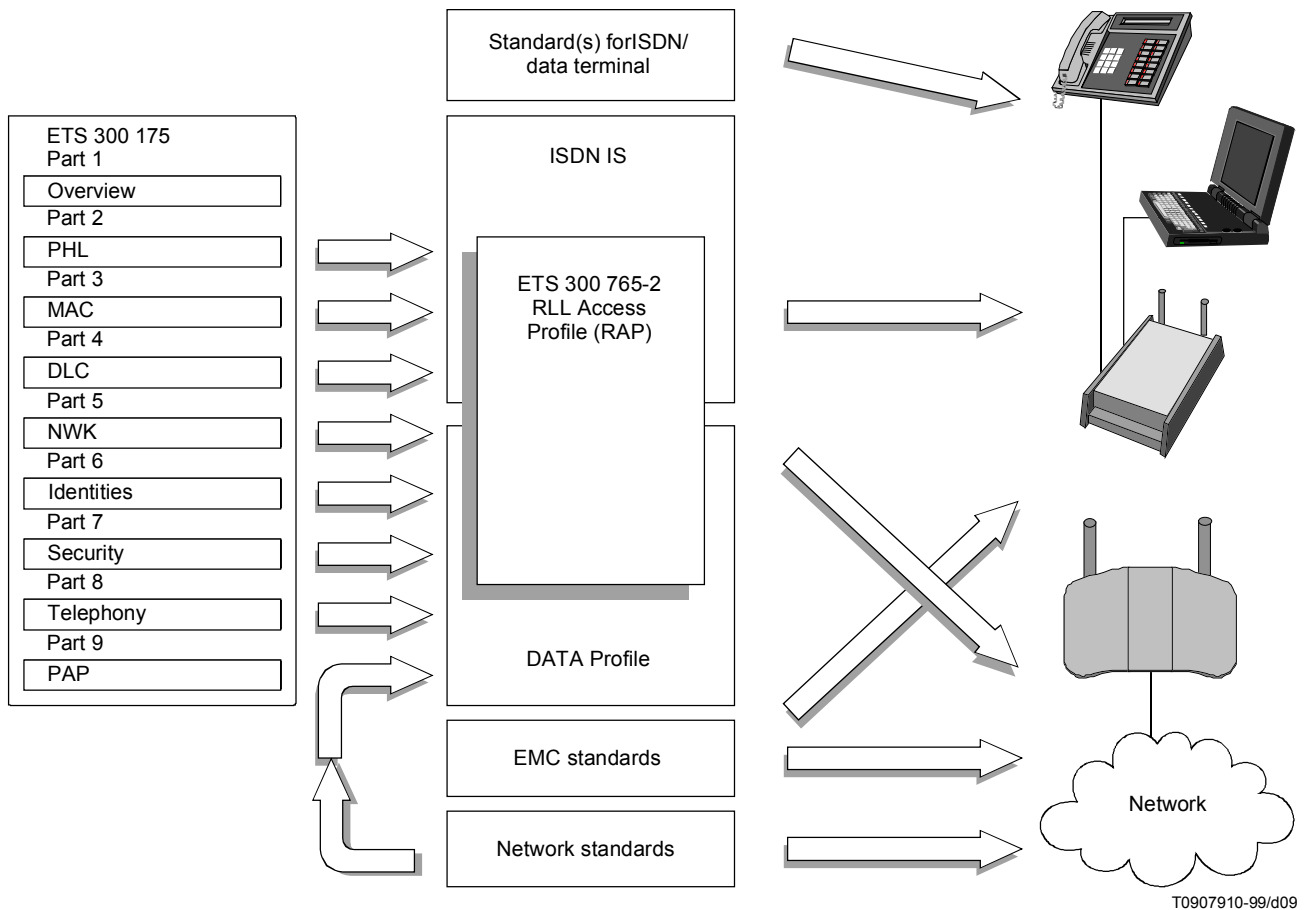

Figure I.4/J.114 – Documents relating to RLL (advanced telephony)

- Type F: An application profile specifically supporting teleservices, such as fax building upon the services offered by the type A/B and C profiles.
- Class 1: Local area applications with pre-registered terminals.
- Class 2: Roaming applications, both public and private.

I.3.2.1 PPP interworking DSP

The ETSI project DECT approved in June 1997 a DSP for PPP interworking for public enquiry (see EN 301 240 [5]), which builds upon ETS 300 651 [12] and ETS 300 701 [13].

The reasons for the choice of the PPP interworking DSP (see EN 301 240 [5] for DVB applications) are that it offers interworking to PPP, which the DVB network-independent protocols (see Recommendation J.111 [2]) makes use of, and a reliable and effective handling of data traffic over the air interface. The PPP interworking DSP and Recommendation J.111 [2] make references to the PPP specifications. This means that there is a harmonized overlap, but the PPP specifications should only be implemented once. A reliable and effective handling of data traffic is important for DVB applications and results from the fact that the PPP interworking DSP builds upon the C.2 profile (Type C, mobility Class 2).

The PPP interworking DSP specifies an interworking profile for non-voice equipment with roaming mobility, providing PPP transmission to allow dial-up Internet access and general multi-protocol datagram transport. PPP packet transfers on the DECT air interface are specified via a high efficient DECT packet transmission protocol. However, interworking to the fixed network may be via a number of interface protocols, including X.25, Frame Relay, ATM, and traditional circuit switched voiceband modem and ISDN connection.

The profile is intended for roaming applications and so specifies mobility Class 2. It thus specifies the requirements on the Network layer Call Control and Mobility Management entities to provide full public services. This profile defines the specific requirements on the Physical (PHL), Medium Access Control (MAC), Data Link Control (DLC) and Network (NWK) layers of DECT. The standard also specifies Management Entity (ME) requirements and generic interworking conventions which ensure the efficient use of the DECT spectrum.

I.4 Wireless Relay Station (WRS)

A WRS is a special DECT unit, combining elements of both PPs and FPs, that is capable of intelligently relaying DECT radio transmissions to extend the coverage area (see ETS 300 700 [6]). A PP does not distinguish between a WRS and an FP.

I.5 DECT Authentication Module (DAM)

Access rights and other subscription related information can be loaded into a PP over the air, via a connector, or by inserting a chip card. To use a DAM card, a PP has to be provided with the DAM interface.

DAM is a chip card that can be programmed with DECT identities and inserted into a DECT PP with an appropriate DAM card interface. It provides one method by which a DECT system operator can load user identities, access rights information, security parameters (authentication and cipher keys) into a PP.

A DAM card can be used in conjunction with different profiles, i.e. it is not restricted to any particular application.

The DAM card is compatible with the corresponding card in GSM [the Subscriber Identity Module (SIM)].

Appendix II

DECT implementation alternatives

Several implementation alternatives are possible when DECT is used as the interaction channel, which are based on the facts that DECT is a flexible solution that can be adapted to several networks and cope with several different services. The DECT standard supports e.g. combined telephony/data implementations. In the default configuration described in clause 5, the RAP data service (DSP PPP interworking) has been chosen. In certain scenarios, other DECT STB implementations can be used.

If a DECT STB is used as an access to the PSTN, the RAP (see ETS 300 765-1 [7]) or the GAP (see ETS 300 444 [8]) can be implemented in the IIM. The GAP implementation offers, however, a very limited data capability. If a DECT STB is used as an access to ISDN, the RAP (see ETS 300 765-2 [4]) or an ISDN profile can be implemented in the IIM.

In Figure II.1, a multi-service scenario is shown where the DVB platform is supported in combination with other platforms. This scenario includes a Network Termination Unit (NTU) in the home. An NTU is a unit which should be considered to be a part of the Interaction Network. An NTU can include a DECT WRS and/or a DECT CTA.

A DECT WRS offers the user mobility within the premises, which can be used to provide the STB with a wireless interface when a DECT PP is integrated in the STB.

DVB Interactive A/V services, e.g.:

- PPV (Pay Per View)
- Nvod (Near Video-On-Demand)
- VOD (Video-On-Demand)
- Teleshopping

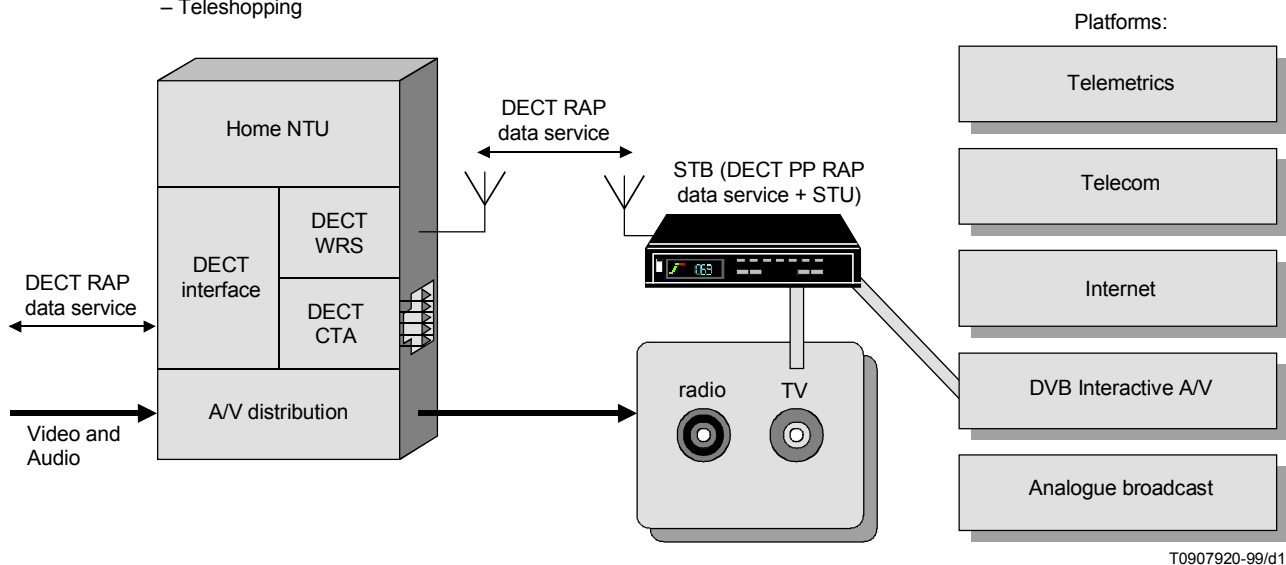

Figure II.1/J.114 – DECT scenario with multi-service support

A DECT Cordless Terminal Adapter (CTA) offers the possibility to connect different kinds of equipment to physical interface ports, e.g. a PSTN port, an ISDN port, a LAN (Ethernet, Token Ring) port or a serial link (RS-232, Universal Serial Bus) port. A DECT CTA port can be used to connect an STB using a physical interface supported by the DECT CTA and the STB. The DECT CTA includes a DECT PP and line interfaces. The IIM is in this case external to the STB and is represented by the DECT CTA.

ITU-T RECOMMENDATIONS SERIES

Series A	Organization of the work of the ITU-T
Series B	Means of expression: definitions, symbols, classification
Series C	General telecommunication statistics
Series D	General tariff principles
Series E	Overall network operation, telephone service, service operation and human factors
Series F	Non-telephone telecommunication services
Series G	Transmission systems and media, digital systems and networks
Series H	Audiovisual and multimedia systems
Series I	Integrated services digital network
Series J	Transmission of television, sound programme and other multimedia signals
Series K	Protection against interference
Series L	Construction, installation and protection of cables and other elements of outside plant
Series M	TMN and network maintenance: international transmission systems, telephone circuits, telegraphy, facsimile and leased circuits
Series N	Maintenance: international sound programme and television transmission circuits
Series O	Specifications of measuring equipment
Series P	Telephone transmission quality, telephone installations, local line networks
Series Q	Switching and signalling
Series R	Telegraph transmission
Series S	Telegraph services terminal equipment
Series T	Terminals for telematic services
Series U	Telegraph switching
Series V	Data communication over the telephone network
Series X	Data networks and open system communications
Series Y	Global information infrastructure
Series Z	Languages and general software aspects for telecommunication systems