



INTERNATIONAL TELECOMMUNICATION UNION

**ITU-T**

TELECOMMUNICATION  
STANDARDIZATION SECTOR  
OF ITU

**I.311**

(08/96)

SERIES I: INTEGRATED SERVICES DIGITAL  
NETWORK

Overall network aspects and functions – Network  
functional principles

---

**B-ISDN general network aspects**

ITU-T Recommendation I.311

(Previously CCITT Recommendation)

---

ITU-T I-SERIES RECOMMENDATIONS  
INTEGRATED SERVICES DIGITAL NETWORK

|   |                    |
|---|--------------------|
| GENERAL STRUCTURE   | I.100–I.199        |
| Terminology   | I.110–I.119        |
| Description of ISDNs  | I.120–I.129        |
| General modelling methods   | I.130–I.139        |
| Telecommunication network and service attributes                        | I.140–I.149        |
| General description of asynchronous transfer mode                       | I.150–I.199        |
| SERVICE CAPABILITIES  | I.200–I.299        |
| Scope   | I.200–I.209        |
| General aspects of services in ISDN                                     | I.210–I.219        |
| Common aspects of services in the ISDN                                  | I.220–I.229        |
| Bearer services supported by an ISDN                                    | I.230–I.239        |
| Teleservices supported by an ISDN                                       | I.240–I.249        |
| Supplementary services in ISDN  | I.250–I.299        |
| OVERALL NETWORK ASPECTS AND FUNCTIONS                                   | I.300–I.399        |
| <b>Network functional principles</b>                                    | <b>I.310–I.319</b> |
| Reference models  | I.320–I.329        |
| Numbering, addressing and routing                                       | I.330–I.339        |
| Connection types  | I.340–I.349        |
| Performance objectives  | I.350–I.359        |
| Protocol layer requirements   | I.360–I.369        |
| General network requirements and functions                              | I.370–I.399        |
| ISDN USER-NETWORK INTERFACES  | I.400–I.499        |
| Application of I-series Recommendations to ISDN user-network interfaces | I.420–I.429        |
| Layer 1 Recommendations   | I.430–I.439        |
| Layer 2 Recommendations   | I.440–I.449        |
| Layer 3 Recommendations   | I.450–I.459        |
| Multiplexing, rate adaption and support of existing interfaces          | I.460–I.469        |
| Aspects of ISDN affecting terminal requirements                         | I.470–I.499        |
| INTERNETWORK INTERFACES   | I.500–I.599        |
| MAINTENANCE PRINCIPLES  | I.600–I.699        |
| B-ISDN EQUIPMENT ASPECTS  | I.700–I.799        |
| ATM equipment   | I.730–I.749        |
| Management of ATM equipment   | I.750–I.799        |

*For further details, please refer to ITU-T List of Recommendations.*

## **ITU-T RECOMMENDATION I.311**

### **B-ISDN GENERAL NETWORK ASPECTS**

#### **Source**

ITU-T Recommendation I.311 was revised by ITU-T Study Group 13 (1993-1996) and was approved under the WTSC Resolution No. 1 procedure on the 27th of August 1996.

## FOREWORD

ITU (International Telecommunication Union) is the United Nations Specialized Agency in the field of telecommunications. The ITU Telecommunication Standardization Sector (ITU-T) is a permanent organ of the ITU. The ITU-T is responsible for studying technical, operating and tariff questions and issuing Recommendations on them with a view to standardizing telecommunications on a worldwide basis.

The World Telecommunication Standardization Conference (WTSC), which meets every four years, establishes the topics for study by the ITU-T Study Groups which, in their turn, produce Recommendations on these topics.

The approval of Recommendations by the Members of the ITU-T is covered by the procedure laid down in WTSC Resolution No. 1.

In some areas of information technology which fall within ITU-T's purview, the necessary standards are prepared on a collaborative basis with ISO and IEC.

## NOTE

In this Recommendation, the expression "Administration" is used for conciseness to indicate both a telecommunication administration and a recognized operating agency.

## INTELLECTUAL PROPERTY RIGHTS

The ITU draws attention to the possibility that the practice or implementation of this Recommendation may involve the use of a claimed Intellectual Property Right. The ITU takes no position concerning the evidence, validity or applicability of claimed Intellectual Property Rights, whether asserted by ITU members or others outside of the Recommendation development process.

As of the date of approval of this Recommendation, the ITU had/had not received notice of intellectual property, protected by patents, which may be required to implement this Recommendation. However, implementors are cautioned that this may not represent the latest information and are therefore strongly urged to consult the TSB patent database.

© ITU 1997

All rights reserved. No part of this publication may be reproduced or utilized in any form or by any means, electronic or mechanical, including photocopying and microfilm, without permission in writing from the ITU.

## CONTENTS

|   | <b>Page</b> |
|---|-------------|
| 1 Network Layering.....   | 1           |
| 1.1 General.....  | 1           |
| 1.2 Architectural components of an ATM transport network.....                               | 2           |
| 1.3 ATM Layer .....   | 2           |
| 1.3.1 Virtual channel level.....  | 2           |
| 1.3.2 Virtual path level .....  | 3           |
| 1.4 Physical Layer.....   | 4           |
| 1.4.1 Transmission path level.....  | 4           |
| 1.4.2 Digital section level.....  | 4           |
| 1.4.3 Regenerator section level.....  | 4           |
| 1.5 Hierarchical level-to-level relationship.....   | 4           |
| 1.6 Functional description of the layered network.....                                      | 4           |
| 1.6.1 Generic definitions of the connection endpoint and<br>connecting point functions..... | 5           |
| 1.6.2 Functions at the connection end-point.....  | 6           |
| 1.6.3 Functions at the connecting point.....  | 6           |
| 2 Application of virtual channel connections and virtual path connections .....             | 6           |
| 2.1 Applications of virtual channel connections.....  | 6           |
| 2.2 Applications of the virtual path connections .....                                      | 8           |
| 3 Control and management of VPC and/or VCC at user access.....                              | 9           |
| 3.1 Network elements involved in the transport of user plane information.....               | 9           |
| 3.2 Communications between user and network elements .....                                  | 10          |
| 3.3 Possible communication scenarios for typical configurations at the user access .....    | 12          |
| 4 B-ISDN control and management transport network.....                                      | 14          |
| 4.1 General objectives and requirements .....   | 15          |
| 4.2 Generic transport network structure.....  | 16          |
| 4.3 Possible network architectures.....   | 16          |
| 4.3.1 VP cross-connect backbone.....  | 16          |
| 4.3.2 VC cross-connect backbone .....   | 17          |
| 4.3.3 VP-VC cross-connect backbone with B-STP functionality.....                            | 18          |
| 4.4 Performance requirements .....  | 19          |
| 4.5 Network management of the control and management transport network.....                 | 19          |
| 4.6 Reliability requirements.....   | 19          |
| 5 B-ISDN signalling principles.....   | 19          |

|       | <b>Page</b>   |    |
|-------|---|----|
| 5.1   | Introduction.....   | 19 |
| 5.2   | Signalling capabilities.....  | 20 |
| 5.2.1 | Capabilities to control ATM virtual channel connections and virtual path connections for information transfer ..... | 20 |
| 5.2.2 | Capability to support multiparty and multiconnection calls.....   | 20 |
| 5.2.3 | Others.....   | 20 |
| 5.3   | Signalling transport function.....  | 21 |
| 5.3.1 | Signalling virtual channels .....   | 21 |
| 5.3.2 | Meta-signalling.....  | 22 |
| 5.3.3 | Signalling configurations.....  | 23 |
| 5.3.4 | Requirements for signalling procedures.....   | 24 |
| 6     | Network capabilities to support charging of B-ISDN services.....  | 25 |
|       | Annex A – Hierarchical structure for ATM transport network.....   | 27 |
|       | Annex B – Network element functions and VP/VC connections .....   | 30 |
|       | Annex C – Definition and scope of service profiles at user access.....  | 32 |
| C.1   | Definition .....  | 32 |
| C.2   | Scope.....  | 32 |
| C.3   | Service profile configuration .....   | 32 |
|       | Appendix I – Example of a path and protocol stacks of network elements within B-ISDN signalling network.....        | 33 |
|       | Appendix II – B-ISDN management functions.....  | 34 |

**Recommendation I.311**

**B-ISDN GENERAL NETWORK ASPECTS**

*(Geneva, 1991; revised Helsinki, 1993 and in 1996)*

**1 Network Layering**

**1.1 General**

ATM transport network is structured as two layers, namely the ATM Layer and the Physical Layer as shown in Figure 1.

|                       |                           |                     |                         |
|-----------------------|---------------------------|---------------------|-------------------------|
|                       |                           | <b>Higher layer</b> |                         |
|                       |                           | ATM Layer           | VC level                |
| ATM transport network |                           |                     | VP level                |
|                       |                           | Physical Layer      | Transmission path level |
|                       |                           |                     | Digital section level   |
|                       | Regenerator section level |                     |                         |

**Figure 1/I. 311 – Hierarchy of the ATM transport network**

The transport functions of the ATM layer are subdivided into two levels; the VC level and the VP level. The transport functions of the physical layer are subdivided into three levels, the transmission path level, the digital section level and the regenerator section level.

The transport functions of the ATM Layer are independent of the physical layer implementation.

Figure 2 shows the relationship between the virtual channel, the virtual path and the transmission path.

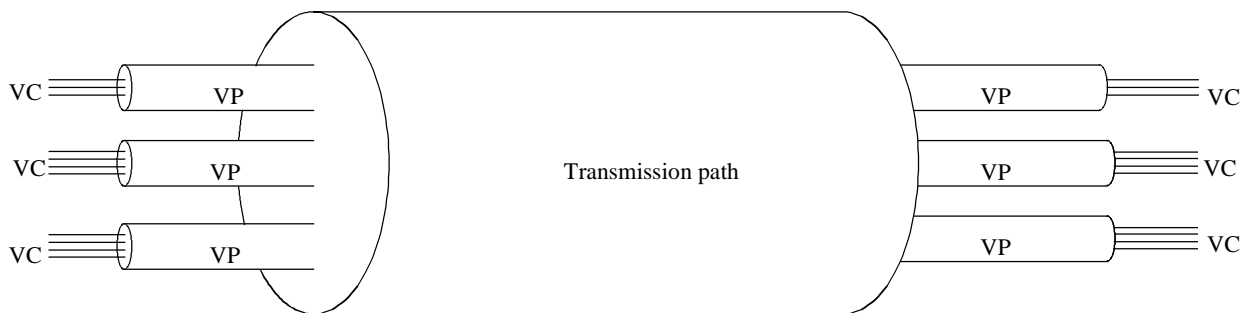

T1810330-90

**Figure 2/I.311 – Relationship between the VC, the VP and transmission path**

## 1.2 Architectural components of an ATM transport network

Figure 3 shows the hierarchical level-to-level relationship in the ATM transport network. Each level relationship includes four architectural components:

- *Connection end-point* – Connection end-point is located at the level boundary (e.g. between VC level and VP level), where a client is served. The client may be located in the next higher level or in the management plane. The connection end-point provides the connection termination function.
- *Connecting point* – Connecting point is inside a connection where two adjacent links come together. It is located in a level where information is routed transparently. It provides the connecting function.
- *Connection* – Connection provides capability of transferring information between endpoints. It represents the association between endpoints together with any additional information regarding the information transfer integrity.
- *Link* – Link provides capability of transferring information transparently. A link represents the association between contiguous connecting points or between an endpoint and its contiguous connecting point.

As shown in Figure 3, a connection in a specific level provides services to a link in the next higher level.

Annex A contains examples of a VCC supported by a cell-based (Figure A.1) and an SDH-based (Figure A.2) ATM transport network.

NOTE – The relationship and/or alignment of this Recommendation with Recommendation G.803 Architecture of transport networks based on the Synchronous Digital Hierarchy (SDH) is under study to determine the relationship between an ATM transport network and a layered model of the SDH-based transport network.

## 1.3 ATM Layer

Each ATM cell contains a label in its header to explicitly identify the VC to which the cell belongs. This label consists of two parts – a Virtual Channel Identifier (VCI) and a Virtual Path Identifier (VPI).

### 1.3.1 Virtual channel level

A Virtual Channel (VC) is a generic term used to describe a unidirectional communication capability for the transport of ATM cells.

A VCI identifies a particular VC link for a given Virtual Path Connection (VPC). A specific value of VCI is assigned each time a VC is switched in the network. A VC link is a unidirectional capability for the transport of ATM cells between two consecutive ATM entities where the VCI value is translated. A VC link is originated or terminated by the assignment or removal of the VCI value.

Routing functions of virtual channels are done at a VC switch/cross-connect<sup>1</sup>. This routing involves translation of the VCI values of the incoming VC links into the VCI values of the outgoing VC links.

Virtual channel links are concatenated to form a Virtual Channel Connection (VCC). A VCC extends between two VCC endpoints or, in the case of point-to-multipoint arrangements, more than two VCC endpoints. A VCC endpoint is the point where the cell information field is exchanged between the ATM Layer and the user of the ATM Layer service.

---

<sup>1</sup> See 3.1 for the definition of switch and cross-connect.



At the VC level, VCCs are provided for the purpose of user-user, user-network, or network-network information transfer. Cell sequence integrity is preserved as defined in clause 2/I.150 by the ATM Layer for cells belonging to the same VCC.

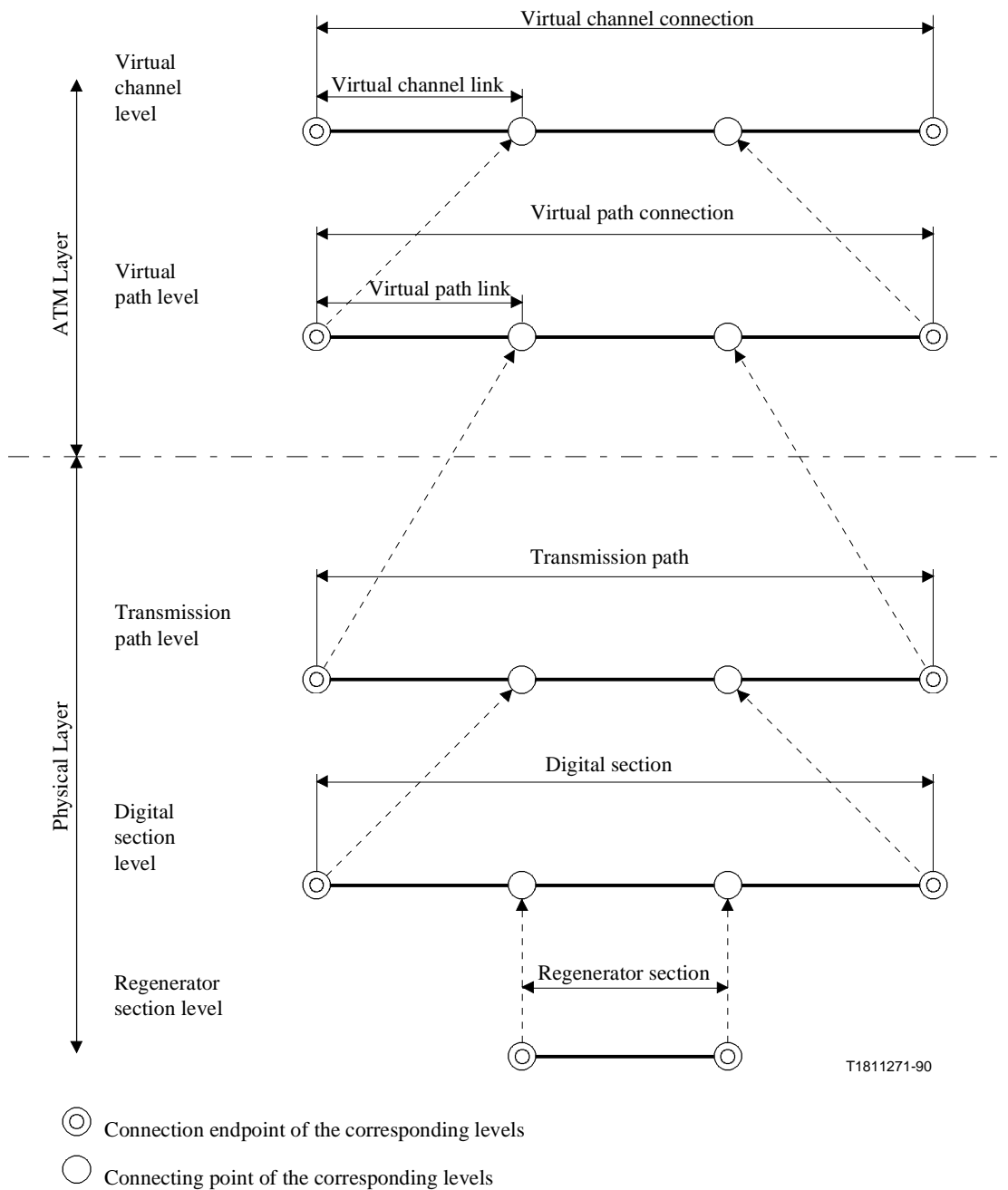

**Figure 3/I.311 – Hierarchical layer-to-layer relationship**

### 1.3.2 Virtual path level

A Virtual Path (VP) is a generic term for a bundle of virtual channel links; all the VC links in a bundle have the same endpoints.

A VPI identifies a group of VC links, at a given reference point, that share the same VPC. A specific value of VPI is assigned each time a VP is switched in the network. A VP link is a unidirectional capability for the transport of ATM cells between two consecutive ATM entities where the VPI

value is translated. A VP link is originated or terminated by the assignment or removal of the VPI value.

Routing functions for VPs are performed at a VP switch/cross-connect<sup>1</sup>. This routing involves translation of the VPI values of the incoming VP links into the VPI values of the outgoing VP links.

VP links are concatenated to form a VPC. A VPC extends between two VPC endpoints or, in the case of point-to multipoint arrangements, there are more than two VPC endpoints. A VPC endpoint is the point where the VCIs are originated, translated or terminated.

At the VP level, VPCs are provided for the purpose of user-user, user-network and network-network information transfer.

When VCs are switched, the VPC supporting the incoming VC links must be terminated first and a new outgoing VPC must be created. Cell sequence integrity is preserved as defined in clause 2/I.150 by the ATM layer for cells belonging to the same VPC. Thus cell sequence integrity is preserved for each VC link within a VPC.

Figure 4 contains a representation of the VP and VC switching hierarchy using the modelling of Figure 1. VPI values are modified in switching blocks for VPs and VCI values are modified in switching blocks for VCs.

## **1.4 Physical Layer**

### **1.4.1 Transmission path level**

The transmission path extends between network elements that assemble and disassemble the payload of a transmission system. Cell delineation and header error control functions are required at the end point of each transmission path.

### **1.4.2 Digital section level**

The digital section extends between network elements which assemble and disassemble a continuous bit or byte stream.

### **1.4.3 Regenerator section level**

The regenerator section is a portion of a digital section.

## **1.5 Hierarchical level-to-level relationship**

Figure 3 shows the generic hierarchical level-to-level relationship in an ATM transport network. More specific examples of this relationship are shown in Annex A for the two different physical layer options.

## **1.6 Functional description of the layered network**

Functions in the virtual channel level and the virtual path level to be provided at connection end-points and connecting points are defined below.

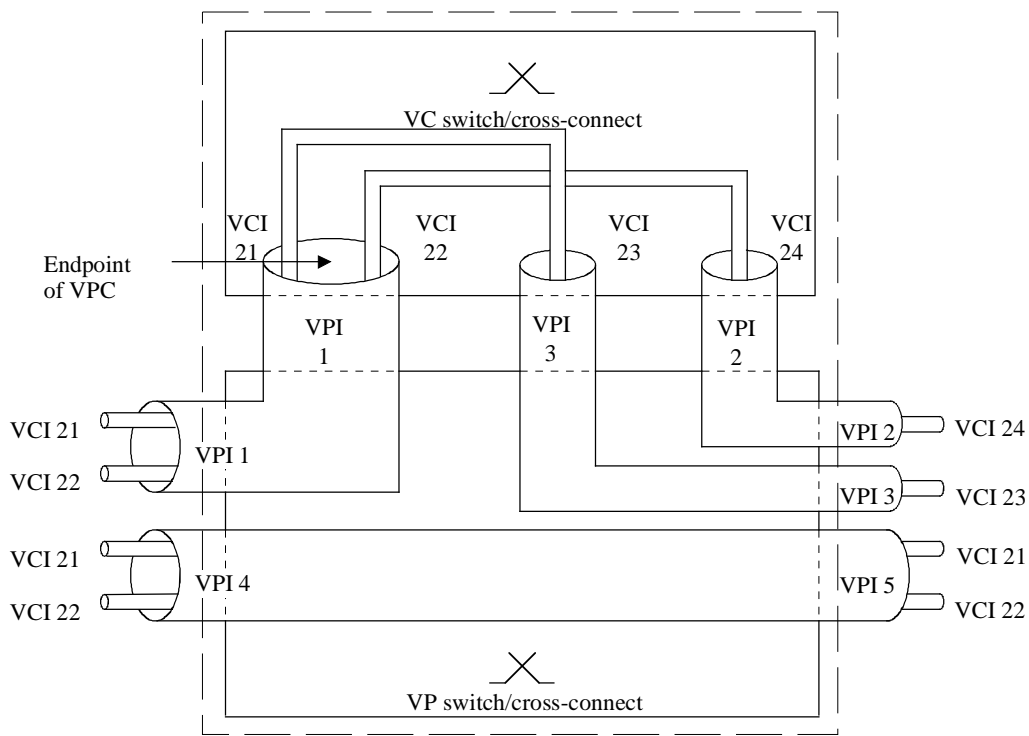

a) Representation of VC and VP switching

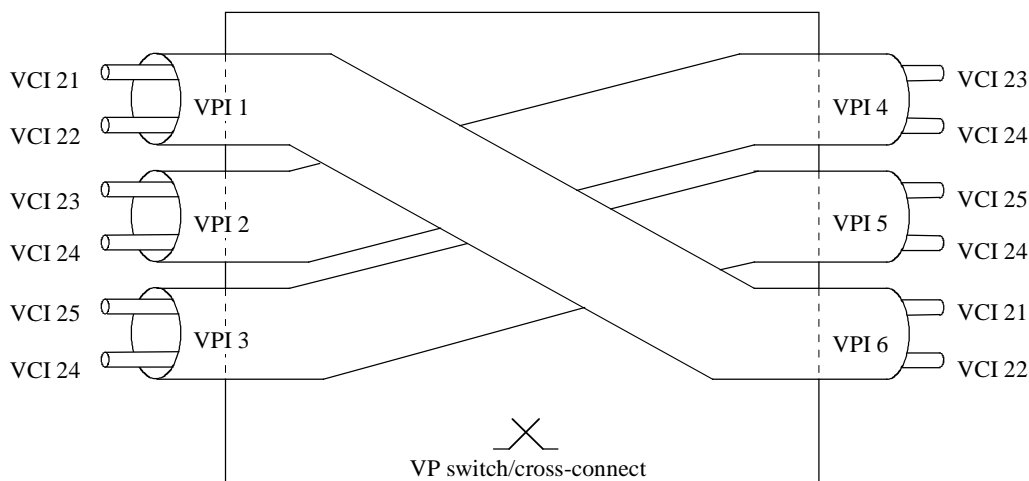

b) Representation of VP switching

T1811280-90

Figure 4/I.311 – Representation of the VP and VC switching hierarchy

### 1.6.1 Generic definitions of the connection endpoint and connecting point functions

Connection endpoint functions provide the capability of:

- i) adapting information suitable for the client layer; and
- ii) terminating the connection for providing information integrity at the connection endpoint.

A client could also be located in the management plane.

Connecting point functions provide the capability of connecting links at the connecting point.

## 1.6.2 Functions at the connection end-point

### *VP Connection Endpoint Functions (VP CEPF)*

VP CEPF of item i) in 1.6.1 is to exchange cell information field and the contents of cell header, except VPI and HEC fields, transparently between VP level and VC level.

VP CEPF of item ii) in 1.6.1 is to generate and extract VP related header functions (e.g. VPI values), to enforce VP related traffic parameters, to multiplex and demultiplex cells preserving VP cell sequence integrity, and to generate, insert and extract F4 OAM cells (see Recommendation I.610).

### *VC Connection Endpoint Functions (VC CEPF)*

VC CEPF of item i) in 1.6.1 is to exchange cell information field transparently between the ATM layer and the AAL. In addition, it also translates between the value of PT field in the cell header and an appropriate indication to the VC client.

VC CEPF of item ii) in 1.6.1 is to generate and extract generic flow control, to generate and extract VC related header function (e.g. VCI values), to enforce VC related traffic parameters, to multiplex and demultiplex cells preserving VC cell sequence integrity, and to generate, insert and extract F5 OAM cells (see Recommendation I.610).

## 1.6.3 Functions at the connecting point

### *VP Connecting Point Functions (VP CPF)*

VP CPF is to translate VPI value, to possibly provide VP related usage/network parameter control (UPC/NPC) depending on the location of the VP connecting point, to multiplex and demultiplex cells preserving VP cell sequence integrity and to generate, insert, monitor and extract F4 OAM cells.

### *VC Connecting Point Functions (VC CPF)*

VC CPF is to translate VCI value, to possibly provide VC related UPC/NPC depending on the location of the VC connecting point, to multiplex and demultiplex cells preserving VC cell sequence integrity, and to generate, insert, monitor and extract F5 OAM cells.

## 2 Application of virtual channel connections and virtual path connections

### 2.1 Applications of virtual channel connections

The following point-to-point applications of VCCs are identified. Point-to-multipoint applications need to be illustrated.

#### 1) *User-user application*

In this application, the VCC extends between  $T_B$  or  $S_B$  reference points. ATM network elements transport all the cells associated with the VCC along the same route. The VCI value may be translated at an ATM network element where a VPC endpoint is located. (See Figure 5a.)

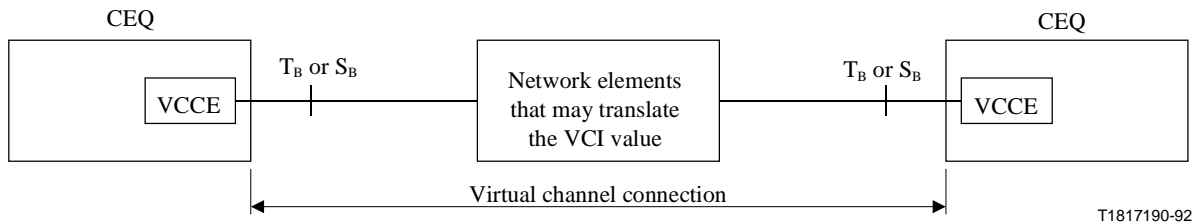

VCCE Virtual Channel Connection Endpoint  
 CEQ Customer equipment

**Figure 5a/I.311 – User-user application of the virtual channel connection**

2) *User-network application*

In this application, the VCC extends between a  $T_B$  or  $S_B$  reference point and a network node. The user-network application of a VCC can be used to provide customer equipment (CEQ) access to a network element [for example, local Connection Related Function (CRF)]. (See Figure 5b.)

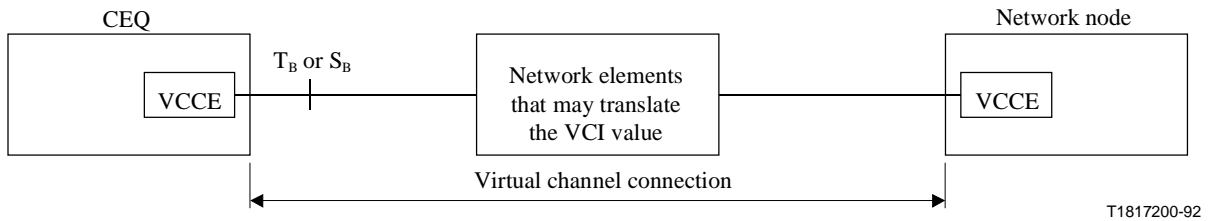

VCCE Virtual Channel Connection Endpoint  
 CEQ Customer equipment

**Figure 5b/I.311 – User-network application of the virtual channel connection**

3) *Network-network application*

In this application, the VCC extends between two network nodes. The network-network application of this VCC includes network traffic management and routing. (See Figure 5c.)

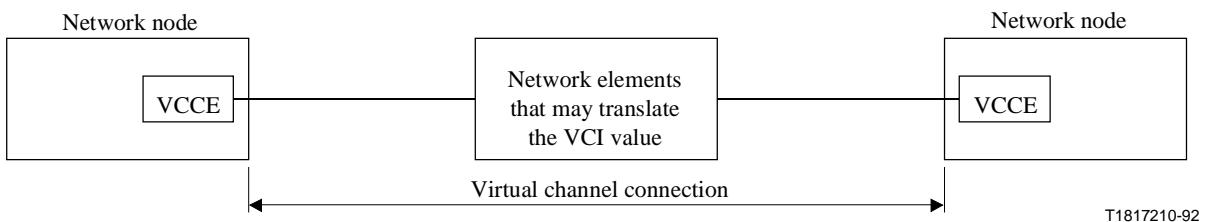

VCCE Virtual Channel Connection Endpoint

**Figure 5c/I.311 – Network-network application of the virtual channel connection**

## 2.2 Applications of the virtual path connections

The following applications of the VPCs are identified:

### 1) *User-user application*

In this application, the VPC extends between  $T_B$  or  $S_B$  reference points. The user-user application of the VPC, shown in Figure 6a, provides customers with virtual path connections. The ATM network elements transport all the cells associated with a VPC along the same route. The VPI values are translated at the ATM network elements that provide functions such as cross-connect or switching.

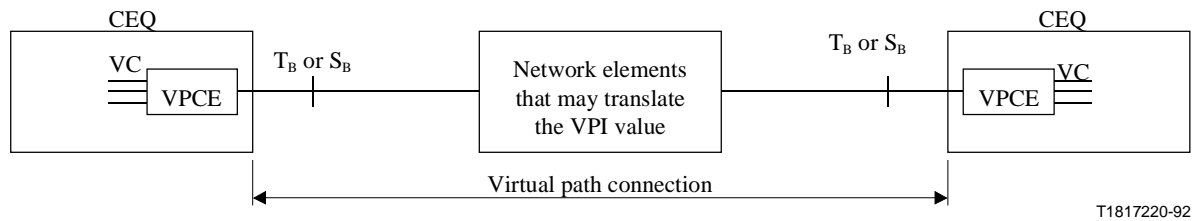

VPCE Virtual Path Connection Endpoint

CEQ Customer equipment

**Figure 6a/I.311 – User-user application of the virtual path connection**

### 2) *User-network application*

In this application, the VPC extends between a  $T_B$  or  $S_B$  reference point and a network node. The user-network application of VPC, shown in Figure 6b, can be used to aggregate CEQ access traffic to a network element (for example: local CRF).

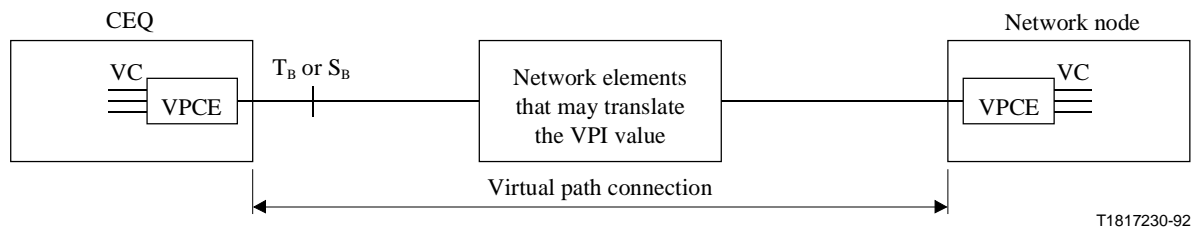

VPCE Virtual Path Connection Endpoint

CEQ Customer equipment

**Figure 6b/I.311 – User-network application of the virtual path connection**

### 3) *Network-network application*

In this application the VPC extends between two network nodes. The network-network application of the VPC, shown in Figure 6c, includes network traffic management and routing. At the network nodes where the VPC is terminated, the VCs within the VP are switched or cross-connected to VCs within other VPs.

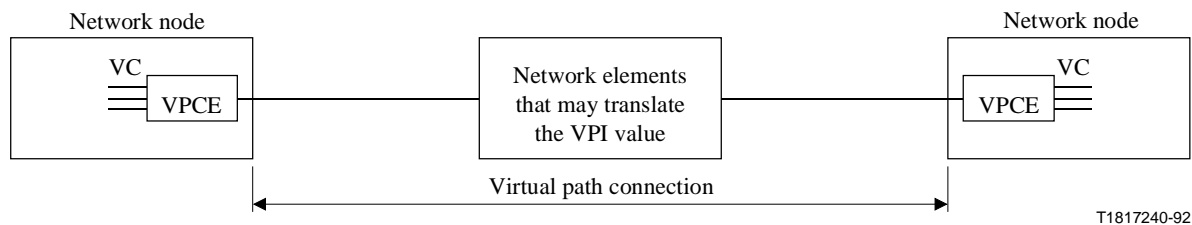

VPCE Virtual Path Connection Endpoint

**Figure 6c/I.311 – Network-network application of the virtual path connection**

### 3 Control and management of VPC and/or VCC at user access

This clause describes:

- the VP/VC network elements and their configurations involved in the transport of user plane information;
- control and management communications between user and network elements under typical VP/VC network element configurations at user access; and
- communication scenarios of above communications to establish and release VPCs/VCCs for the transport of user information.

#### 3.1 Network elements involved in the transport of user plane information

The following are the definitions of network elements which are involved in the transport of user plane information.

**3.1.1 VP cross-connect:** A VP cross-connect is a network element which connects VP links; it translates VPI (not VCI) values and is directed by management plane functions and not by control plane functions.

**3.1.2 VC cross-connect:** A VC cross-connect is a network element which connects VC links; it terminates VPCs and translates VCI values and is directed by management plane functions and not by control plane functions.

**3.1.3 VP-VC cross-connect:** A VP-VC cross-connect is a network element that acts both as a VP cross-connect and as a VC cross-connect. It is directed by management plane functions and not by control plane functions.

**3.1.4 VP switch:** A VP switch is a network element that connects VP links; it translates VPI (not VCI) values and is directed by control plane functions.

**3.1.5 VC switch:** A VC switch is a network element that connects VC links; it terminates VPCs and translates VCI values and is directed by control plane functions.

**3.1.6 VP-VC switch:** A VP-VC switch is a network element that acts both as a VP switch and as a VC switch. It is directed by control plane functions.

Other network elements which are combinations of the above defined network elements could be envisaged.

### 3.2 Communications between user and network elements

The following five types of communications are identified for control and management of VPC and/or VCC which provide user plane information transport. (See Figure 7.)

1) *Management plane communication type-1*

This is a communication taking place directly between the customer equipment (CEQ) and the Network Management Center (NMC) via two types of communication paths.

- a communication path connected with the NMC via an interface other than the interface through which the user plane information is transferred (using a remote entry terminal at the CEQ); or
- via pre-defined VPC or VCC between TE and the NMC through the same  $T_B$  interface as that for user information transfer (via the VP or VC cross-connect).

In principle, this communication comprises a request from the CEQ for a permanent or semi-permanent VPC or VCC for user information transfer, and the notification from the NMC to the CEQ of the VPI and VCI values to be used for this information transfer across  $T_B$  interface.

At the CEQ, the user can manually enter the request information either from the remote entry terminal or directly from the TE/NT2. In case of a remote entry terminal, Internal communication between this terminal and the TE/NT2 could be used.

2) *Management plane communication type-2*

The VPC/VCC are established/released/maintained by the VP- or VC-cross-connects using the management plane communication type-2.

Communicating entities of this communication are the NMC and VP- or VC-cross-connects. Communication between them could be ATM-based or non ATM-based.

3) *Control plane communication (access)*

In this communication, a user manages (establishes/releases/maintains) a VPC/VCC by sending control plane messages through a signalling VCC which is terminated at a VC-switch.

4) *Management plane communication type-3*

This communication is for a VC-switch which accepts a request for connection management using Control plane communication (access) to transfer the request information to the NMC by sending management plane messages.

5) *Control plane communication (network)*

This communication is for a VC-switch which accepts a request [for connection management using control plane communication (access)] to transfer that request to establish/release/maintain VP links via the VP-switch by sending control plane messages.

Figure 7 shows communicating entities of each communication without indicating any routes of communication paths.



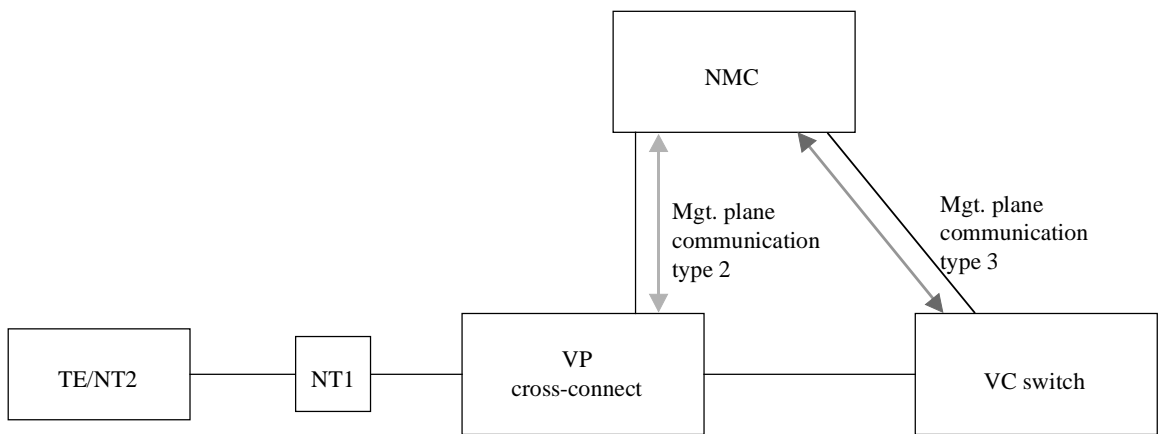
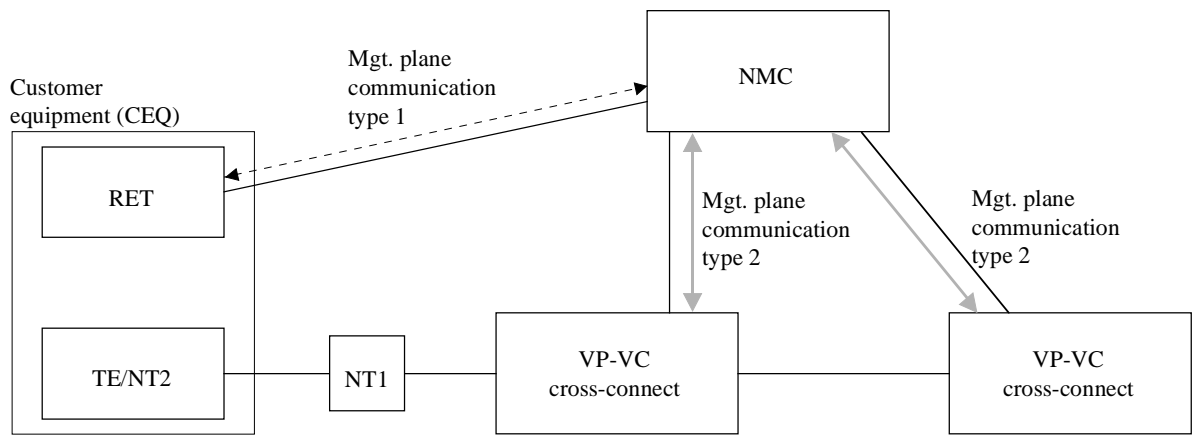

Control plane communication (access)

Control plane communication (network)

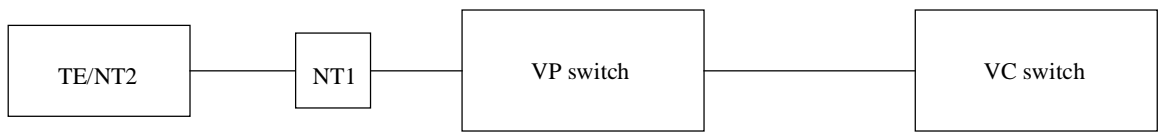

Control plane communication (access)

T1817250-92

NMC Network Management Center

RET Remote Entry Terminal

**Figure 7/I.311 – Communication used for VPC/VCC management**

### 3.3 Possible communication scenarios for typical configurations at the user access

This subclause describes possible communication scenarios for assignment of (semi-) permanent VPC/VCC and on-demand VPC/VCC under some typical configurations at the user access. These configurations address the specific situation in which there is a VP cross-connect or switch in the access network.

Figure 8 a) shows (semi-) permanent/reserved VPC/VCC assignments. ("Reserved" means a semi-permanent communication with a repetitive or not repetitive time factor.)

In this case, a customer requests the Network Management Center (NMC) to establish/release a VPC/VCC using the management plane communications type-1. Management plane communications type-1 is performed by a remote entry terminal which is connected to NMC via another interface than the one through which user plane information is transferred.

After an indication by the NMC of the VPI and/or VCI value to be used, the TE/NT2 will be connected to the semi-permanent/reserved VPC/VCC. The VPC/VCC are established/released at the cross-connects using the management plane communication type-2.

Figure 8 b) shows another kind of (semi-) permanent/reserved VPC/VCC assignment. In this case, management plane communication type-1 takes place via pre-defined VPC/VCC between TE/NT2 and NMC via a VP and/or VC cross-connect.

Figure 8 c) shows on-demand VPC/VCC assignment in which NMC is involved. In this case, a user sets up a signalling VCC using the meta-signalling VCC within the VPC whose VPI is zero at the UNI. The user establishes/releases a VPC/VCC by sending control plane messages through the signalling VCC.

The meta-signalling and signalling messages are conveyed transparently through VP cross-connect located between the user and the VC switch where the meta-signalling VCC and the signalling VCC are terminated.

The VC switch communicates with the NMC using management plane communication type-3, and then the NMC orders the VP cross-connect to establish/release the required VPC using management plane communication type-2.

Figure 8 d) is another kind of on-demand VPC/VCC assignment in which the NMC is not involved. The way a user sets up a signalling VCC and a VPC/VCC is the same as in Figure 8 c), which is referred to as control plane communication (access) in the figure.

The way meta-signalling and signalling messages are conveyed to the VC switch is also the same as in Figure 8 c).

The VC switch communicates back to the VP switch via control plane communication (network) to establish/release the required VPC/VCC.

Annex B contains examples of VP and VC network element functions.

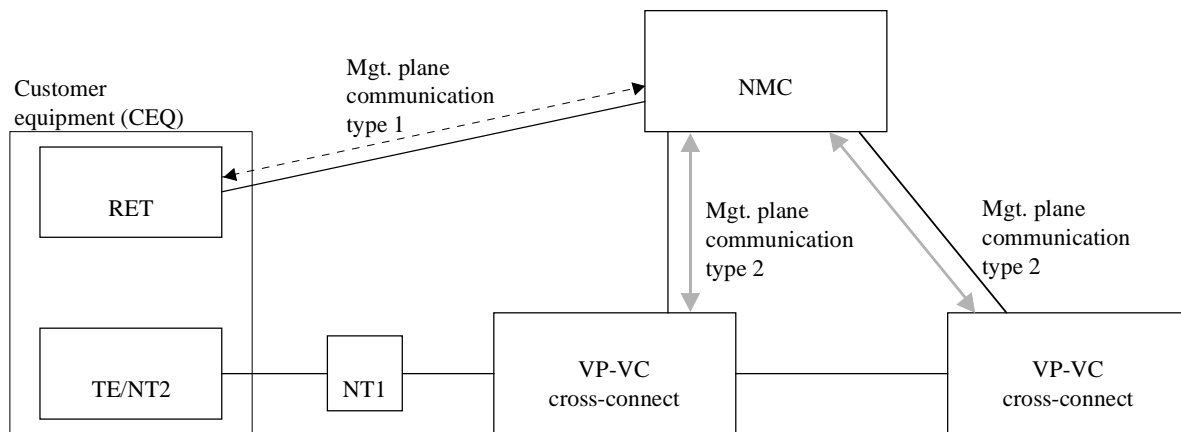

a) (Semi-) permanent/reserved VPC/VCC request

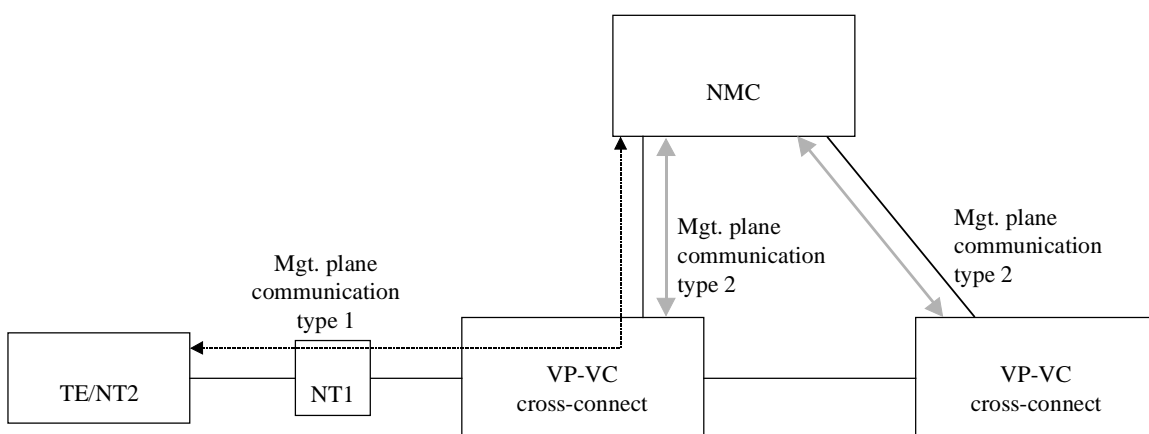

T1817260-92

b) (Semi-) permanent/reserved VPC/VCC request

Figure 8/I.311 (sheet 1 of 2) – Possible communication scenarios

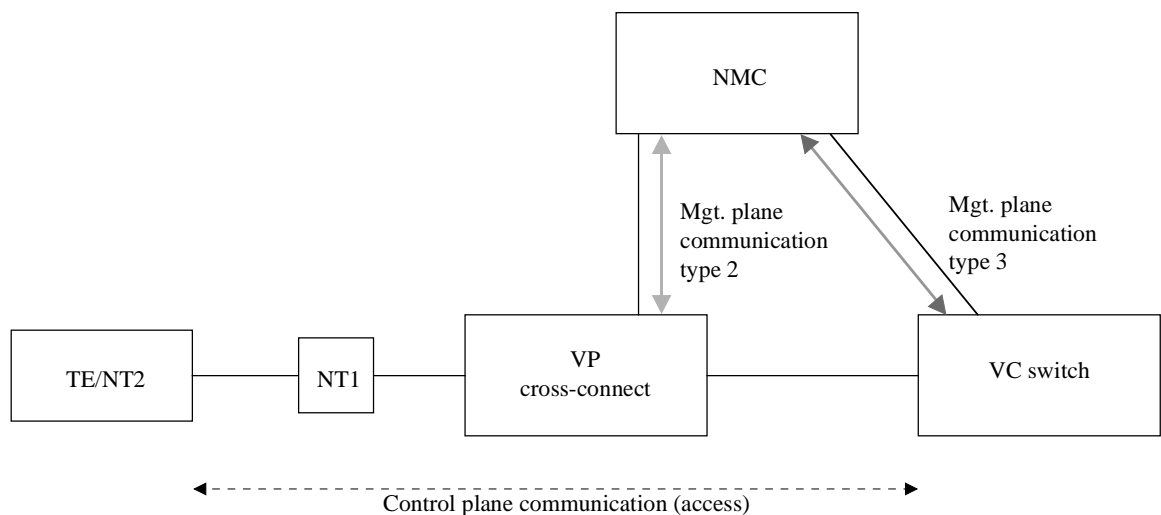

c) On-demand VPC/VCC request

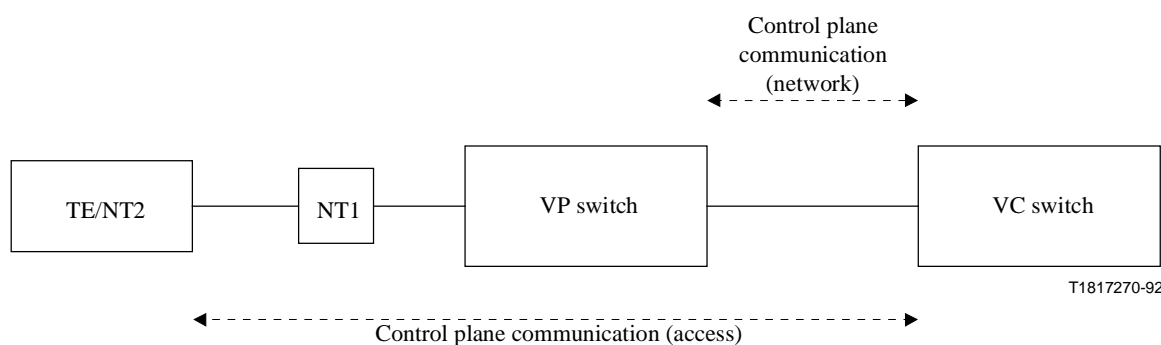

d) On-demand VPC-VCC request

NMC Network Management Centre  
 RET Remote Entry Terminal

NOTE – The above configurations are illustrations of some of the configurations possible.

**Figure 8/I.311 (sheet 2 of 2) – Possible communication scenarios**

#### 4 B-ISDN control and management transport network

B-ISDN control and management transport function in the network has to provide the capability to transfer the following information:

- Control information for U-plane VPC/VCC;
- Control information between Service Switching Points (SSPs) and Service Control Points (SCPs) in the context of IN;
- User-to-user signalling information (for further study);
- User-to-service management system signalling information;
- Management information for OAM.

This clause describes the requirements and possible network architectures for the B-ISDN control and management transport function. Although the use of ATM transport is outlined in this clause, this does not preclude the use of other transport networks (e.g. SS No. 7 transport, Recommendation X.25).

For the transport of control and management information, the B-ISDN transport network is used. For the higher protocol layers, the signalling and TMN protocol fulfil the requirements. No need of other protocols is seen at present.

#### **4.1 General objectives and requirements**

The B-ISDN control and management transport network should be an infrastructure for service control and OAM capabilities.

1) *Reliability*

High reliability of the transport function should be achieved to protect a network against failure and overload. Protection mechanism such as protection switching, self-healing and re-routing are envisaged.

2) *Flexibility*

The transport function should be flexible enough to allow frequent changes in service requirements associated with the introduction of new functions and data-bases for service control and OAM in the network. It should be suitable for the future distributed processing environment.

3) *Performance*

By using the ATM capabilities, it is expected that the performance of ATM transport networks will be at least as good as the performance of transport networks used to support SS No. 7 signalling.

4) *Commonality of interfaces*

It is desirable that the interfaces of the various nodes, including transport nodes, service control nodes and OAM nodes to the control and management information transport network should be common through the ATM layer.

5) *Interworking with N-ISDN signalling transport network*

The B-ISDN control and management transport function may provide access to existing SS No. 7 transport networks.

This interworking allows the B-ISDN to have access to resources on the N-ISDN environment, e.g. Service Control Points (SCPs), and on the other hand will also allow existing network nodes to have access to high speed capabilities provided by the ATM network.

The transport network should allow two modes of operation; associated mode and the quasi-associated mode.

The definition of associated and quasi-associated modes in Recommendation Q.700 is applicable in B-ISDN control and management transport network.

In associated mode, two possibilities are foreseen:

- a) carrying in the same VP the control and management and user information VCs;
- b) carrying in one VP the control and management information VCs and in other VPs user information VCs. The VPs may be on the same or on a separate physical interface.

In quasi-associated mode, messages relating to a particular signalling relation are conveyed over two or more ATM VPs in tandem, passing through one or more B-ISDN Signalling Transfer Points (B-STPs) operating in a connectionless messaging mode.

## 4.2 Generic transport network structure

Figure 9 shows a generic structure for the control and management information transport network.

NOTE – At the introductory stage, other transports, e.g. SS No. 7 or, Recommendation X.25, may be applicable.

It is assumed that this network is logically separated from the B-ISDN user information transport network.

The B-ISDN control and management information transport network may also be used by existing N-ISDN nodes, directly or through the SS No. 7 or X.25 network, enhancing the capability of N-ISDN.

The control and management information transport network shall provide access to the intelligent layer nodes.

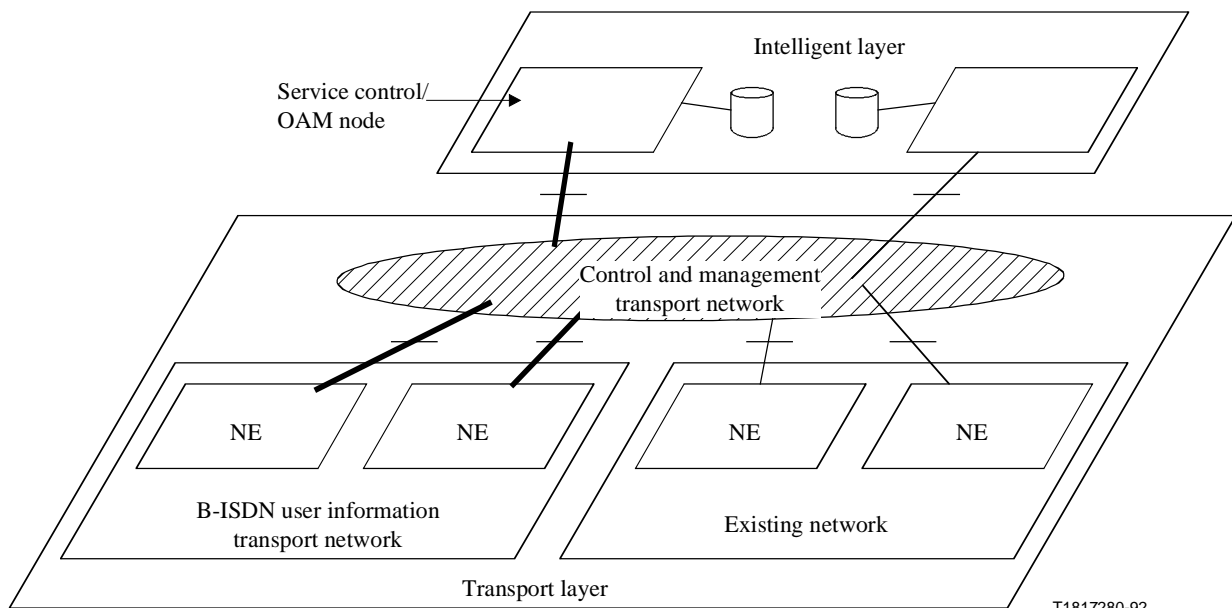

NE Network Element

**Figure 9/I.311 – Control and management information transport network**

## 4.3 Possible network architectures

Possible architectures of B-ISDN control and management transport network are described.

### 4.3.1 VP cross-connect backbone

Figure 10 illustrates a possible transport network architecture.

In this example, VPs are used for interconnecting various nodes in a pre-assigned basis.

A VP cross-connect backbone serves as a control and management transport network.

Different types of control or management flows within a VP are segregated by different VCs. This allows the distribution of functions at the ATM layer instead of at higher layers, increasing the speed of information transport.

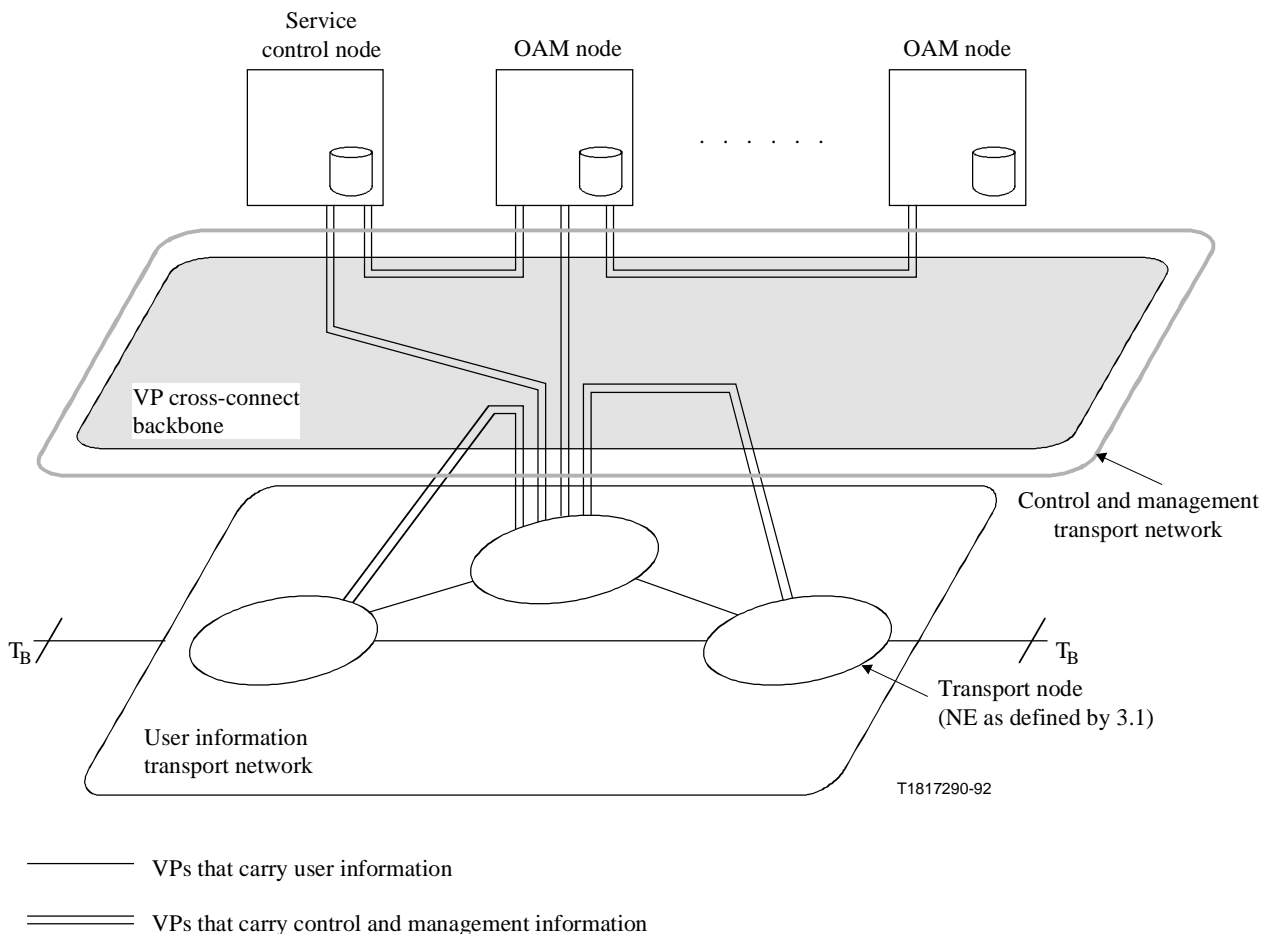

**Figure 10/I.311 – An example of control and management transport network architecture using VP cross-connect backbone**

In this configuration two options are foreseen:

- 1) Segregation of the control and management information from the user information at the VP level. In this case the total VP capacity in a transmission line can be dynamically re-allocated among the VPCs for signalling and the VPs for user information, according to the traffic variations and/or failure situations.
- 2) No segregation at the VP level. The VPs will carry control and management information and user information.

The support of the signalling in a VP cross-connect backbone structure could allow:

- simplification of the existing protocols for control and management transport;
- better performance, mainly by the reduction of the control and management messages delay;
- to take advantage of possible self-healing capability at the VP level.

#### 4.3.2 VC cross-connect backbone

Figure 11 gives an example of control and management transport network architecture using VC cross-connect backbone.

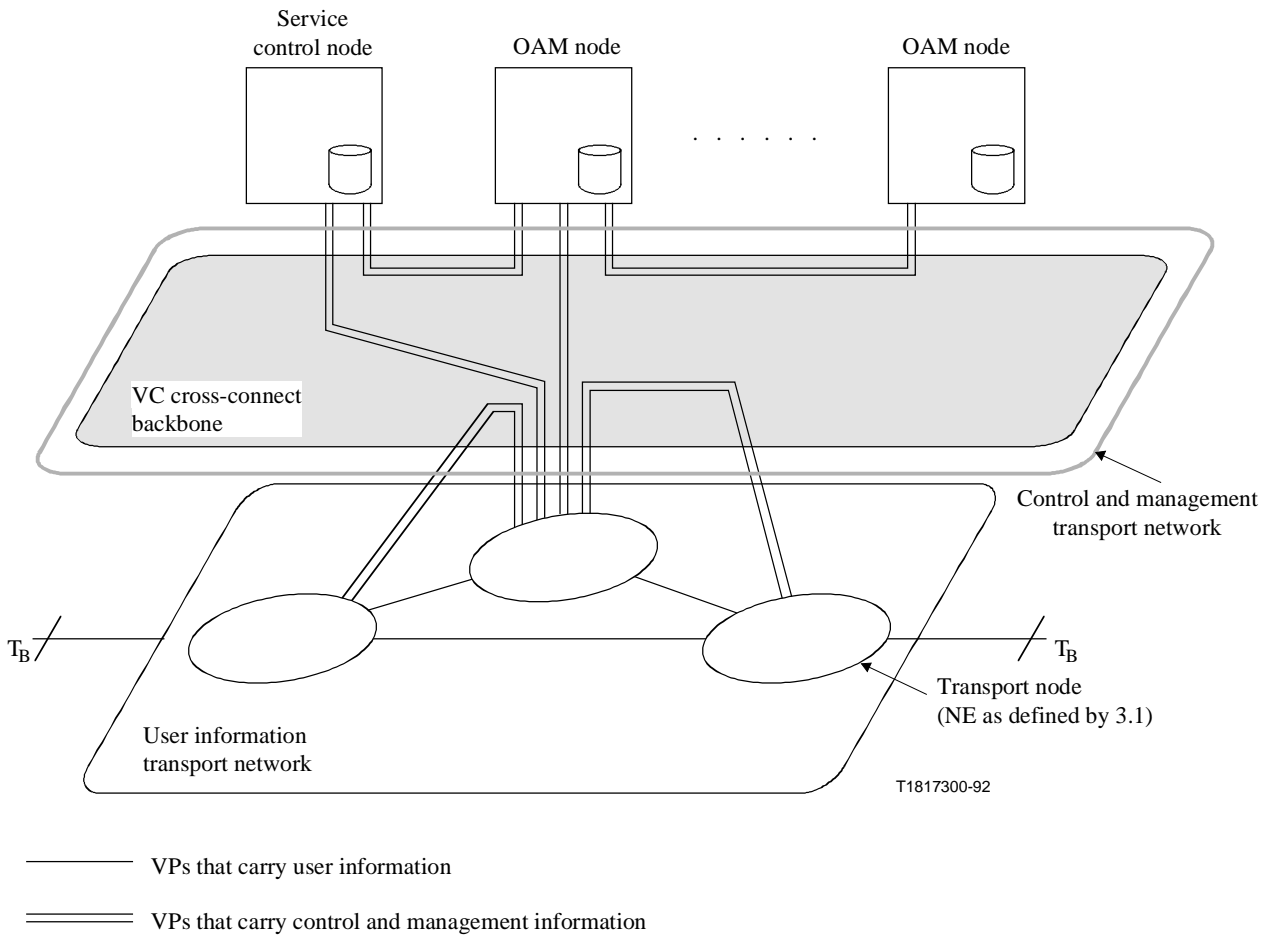

**Figure 11/I.311 – An example of control and management transport network architecture using VC cross-connect backbone**

In this example, VCs are used for interconnecting various nodes in a pre-assigned basis.

The difference from the previous example is that the management function of the network is at the VC level.

### 4.3.3 VP-VC cross-connect backbone with B-STP functionality

Figure 12 illustrates a similar structure, to the one of 3.1 but with a B-STP functionality.

The B-STP may be used in situations where the traffic volume is low between two signalling points or between Service Switching Points (SSPs) and Service Control Points (SCPs).

In this example, control and management network consists of VP-VC backbone and B-STP functions. Appendix I illustrates an example of this architecture.



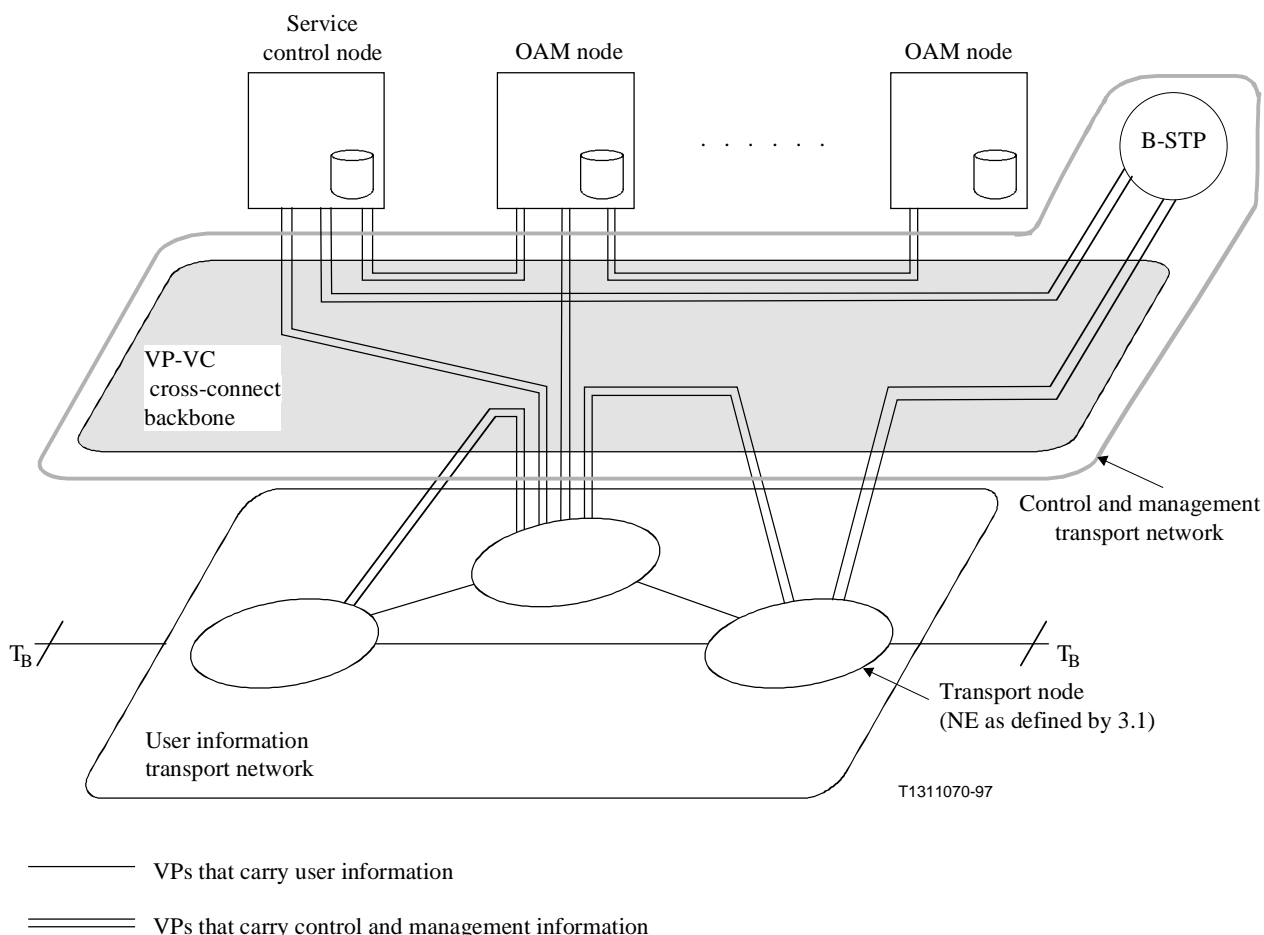

**Figure 12/I.311 – An example of control and management transport network architecture with B-STP functionality**

#### 4.4 Performance requirements

Performance parameters, e.g. the bandwidth for the control and management VPs/VCs, is for further study.

#### 4.5 Network management of the control and management transport network

For further study.

#### 4.6 Reliability requirements

Parameters are for further study.

### 5 B-ISDN signalling principles

#### 5.1 Introduction

In B-ISDN, the use of ATM allows for a multiplicity of service types/characteristics and for the logical separation of signalling from user information streams. A user may have multiple signalling entities connected to the network call control management via separate ATM virtual channel connections. The following subclauses identify the signalling capabilities needed in B-ISDN and the requirements for establishing signalling communication paths.

## **5.2 Signalling capabilities**

### **5.2.1 Capabilities to control ATM virtual channel connections and virtual path connections for information transfer**

- a) Establish, maintain and release ATM VCCs and VPCs for information transfer. The establishment can be on-demand, semi-permanent and should comply with the requested connection characteristic (e.g. bandwidth, quality of service).
- b) Support of communication configurations on a point-to-point, multipoint and broadcast basis.
- c) Negotiate the traffic characteristics of a connection at connection establishment.
- d) Ability to renegotiate source traffic characteristics of an already established connection.

### **5.2.2 Capability to support multiparty and multiconnection calls**

- a) Support of symmetric and asymmetric calls (e.g. low or zero bandwidths in one direction and high bandwidths in the other).
- b) Simultaneous establishment and release of multiple connections associated with a call.  
NOTE 1 – The simultaneous establishment of multiple connections should not be significantly slower than the establishment of a single connection.
- c) Two party/multiparty call establishment with or without any connections.
- d) Simultaneous establishment and release of call and connection(s) associated with a call.
- e) Add and release of one or more connections to and from an existing call by the calling party and called party.
- f) Release from the call by the called party.
- g) Add and release of one or more a party(ies) to and from a multiparty call by the calling party.
- h) Attachment/detachment of one or more parties to/from a connection.
- i) Detachment from connection(s) by the called party.
- j) Capability to correlate when requested, connections composing a multiconnection call.  
NOTE 2 – This correlation is handled by the origination and destination B-ISDN switches, which may be public or private.
- k) Reconfigure a multiparty call including an already existing call or splitting the original multiparty call into more calls.

### **5.2.3 Others**

- a) Capability to reconfigure an already established connection, for instance, to pass through some intermediate processing entity such as a conference bridge.
- b) Support interworking between different coding schemes.
- c) Support interworking with non B-ISDN services, e.g. services supported by PSTN or 64 kbit/s based ISDN.
- d) Support of interaction between IN and B-ISDN.
- e) Support of interaction between TMN and B-ISDN.
- f) Support of failure indication and automatic protection switching for semi-permanent and permanent connections.

Further signalling requirements may be possible and are for further study.

### 5.3 Signalling transport function

At the user access, multiple VPs may be used to carry Signalling VCs (SVCs). These VPs may connect the user to the local exchange, other users, and/or other networks. B-ISDN signalling configurations are classified as either point-to-multipoint or point-to-point.

A point-to-multipoint signalling configuration exists when a signalling entity ("point") interacts with multiple signalling entities ("multipoint"). In a point-to-multipoint signalling configuration, meta-signalling procedures shall be used **to** request allocation of individual point-to-point SVCs.

A point-to-point signalling configuration exists when a signalling entity interacts with another single signalling entity.

When the signalling configuration is unknown, a point-to-multipoint signalling configuration shall be assumed. A signalling configuration can become known either by subscription or by a dynamic procedure.

#### 5.3.1 Signalling virtual channels

##### 5.3.1.1 Requirements for signalling virtual channels

For a point-to-point signalling configuration, the requirements for signalling virtual channels are as follows:

###### *Point-to-point signalling virtual channels*

For point-to-point signalling, one virtual channel connection in each direction is allocated to each signalling entity. The same VPI/VCI value is used in both directions. A standardized VCI value is used for point-to-point signalling virtual channel.

In general, a signalling entity can control, by means of associated point-to-point SVCs, user-VCs belonging to any of the VPs terminated in the same network element or CEQ.

As a network option, the user-VCs controlled by a signalling entity can be constrained such that each controlled user-VC is in either upstream or downstream VPs containing the point-to-point SVCs of the signalling entity.

For point-to-multipoint signalling configuration, the requirements for signalling virtual channels are as follows:

###### a) *Point-to-point signalling virtual channels*

For point-to-point signalling, one virtual channel connection in each direction is allocated to each signalling entity. The same VPI/VCI value is used in both directions.

###### b) *General broadcast signalling virtual channel*

The General Broadcast Signalling Virtual Channel (GBSVC) may be used for call offering in all cases. In cases, where the "point" does not implement service profiles or where "the multipoints" do not support service profile identification, the GBSVC shall be used for call offering.

The specific VCI value for general broadcast signalling is reserved per VP at the UNI. Only when (see 5.3.2) meta-signalling is used in a VP will the GBSVC be activated in the VP.

###### c) *Selective broadcast signalling virtual channels*

Instead of the GBSVC, a virtual channel connection for Selective Broadcast Signalling (SBS) can be used for call offering, in cases where specific service profile is used. No other uses of the SBSVCs are foreseen.

The concept of service profiles is related to basic services as well as supplementary services. The definition and scope of service profiles for B-ISDN are given in Annex C.

NOTE – GBSVC and SBSVC connections will apply in the point-to-multipoint direction only.

d) *Transfer capability*

The selected transfer capability from Recommendation I.371 including the assigned traffic parameter values are for further study.

### **5.3.1.2 Signalling virtual channels at the user access**

Both the point-to-point and point-to-multipoint signalling configuration may be used at a user access.

### **5.3.1.3 User-to-user signalling virtual channels**

Both the point-to-point and point-to-multipoint signalling configuration may be used in a user-to-user configuration.

### **5.3.1.4 Signalling virtual channels in the network**

Only the point-to-point signalling configuration is used for network-to-network signalling. In case of network-network VP containing signalling VCs, additional VCI values for signalling in this VP are pre-established.

The method of pre-establishment is for further study.

## **5.3.2 Meta-signalling**

### **5.3.2.1 Meta-signalling requirements**

a) *Scope of meta-signalling*

A meta-signalling virtual channel is able to manage signalling virtual channels only within its own VP pair.

In VPI=0, the meta-signalling virtual channel is always present and has a standardized VCI value.

b) *Initiation of meta-signalling for SVCI assignment*

Meta-signalling VC may be activated at VP establishment. Other possibilities are for further study.

The Signalling Virtual Channel (SVC) should be assigned and removed when necessary.

c) *Meta-signalling VCI and VP*

A specific VCI value for meta-signalling is reserved per VP at the UNI. For a VP with point-to-multipoint signalling configuration, meta-signalling is required and the meta-signalling VC within this VP will be activated. For a VP in point-to-point signalling configuration, the use of meta-signalling is for further study.

d) *SVC bandwidth*

The user should have the possibility to negotiate the bandwidth parameter value.

The bandwidth parameter values are for further study.

e) *Meta-Signallings-Virtual Channel (MSVC) bandwidth*

MSVC has default bandwidth value. The bandwidth can be changed by mutual agreement between network operator and user. The default value is for further study.

### 5.3.2.2 Meta-signalling functions at the user access

In order to establish, check and release the point-to point and selective broadcast signalling virtual channel connections, meta-signalling procedures are provided. For each direction, meta-signalling is carried in a permanent virtual channel connection having a standardized VCI value (see 2.3.2/I.361). This channel is called the meta-signalling virtual channel. The meta-signalling protocol is terminated in the ATM layer management entity.

The meta-signalling function will be required to:

- manage the allocation of capacity to signalling channels;
- establish, release and check the status of signalling channels;
- provide a means to associate a signalling endpoint with a service profile if service profiles are supported;
- provide the means to distinguish between simultaneous requests.

It may be necessary to support meta-signalling on any VP. Meta-signalling can only control signalling VCs within its VP.

### 5.3.2.3 Relationship between meta-signalling and the user access signalling configuration

A point-to-multipoint signalling configuration exists when the network supports more than one signalling entity at the user side. In this configuration, terminals must use the meta-signalling protocol to request allocation of their individual point-to-point signalling virtual channels.

A point-to-point signalling configuration exists when the network supports only one signalling entity at the user side. When this configuration is known, terminals can use the specific VCI value (Table 2/I.361) reserved for the point-to-point signalling virtual channel. In this case no broadcast signalling virtual channel will be provided.

In a user-to-user signalling configuration, the meta-signalling protocol can optionally be used over a user-to-user VPC to manage a user-to-user signalling virtual channel. It is recommended (but it is a user choice) to use the standardized VCI value for the user-to-user meta-signalling channel. In this case meta-signalling shall not have an impact on the network.

The meta-signalling protocol can be used to manage signalling virtual channel between a user and another network over the same user access. In this case, VPIs other than VPI=0 are used and the VCI value is the standardized one.

Normally, the VPI value equal to zero will be used to manage signalling virtual channels to the local exchange. For the case where communication of a user to an alternative local exchange over the same user access is required, another VPI value different from zero will be used.

### 5.3.2.4 Meta-signalling functions in the network

Meta-signalling is not used to assign signalling channels between two network signalling endpoints. Therefore, every VP within the network has one VCI value reserved for point-point signalling and activated in case signalling is used on this VP (see 2.2.3/I.361).

### 5.3.3 Signalling configurations

Figure 13 illustrates three possible signalling configurations.

- *Case A:* The customer uses signalling procedures to establish virtual channel connections to other customers. The meta-signalling channel is used to establish a signalling channel (or channels) between the CEQ and the local CRF. The local CRF provides an interconnection function based on using the VPI and the VCI in the ATM cell header.

- *Case B:* The customer has VPCs through the local CRF to another CEQ. These VPCs could be established:
  - a) without using signalling procedures (e.g. by subscription);
  - b) using signalling procedures on a demand basis.

When a VP connection is established by using signalling procedures, the CEQ uses the meta-signalling channel to the local CRF to establish a signalling channel (or channels) which may be used to establish the VPCs (e.g. the CEQs). This possibility is for further study. Virtual channel links within a VPC are established by using signalling procedures between a CEQ and a node terminating the VPC. The procedures for establishing a signalling channel or channels between the nodes terminating the VPC are for further study. Optionally, the meta-signalling protocol can be used. The local CRF provides an interconnection function based on using only the VPI portion of the ATM cell header for those VPCs that do not terminate at the local CRF.

- *Case C:* The customer has VPCs through the local CRF to another CEQ and additional VPCs that terminate at the local CRF. In this case, the CEQ uses the meta-signalling channel to the local CRF to establish a signalling channel (or channels), which are then used to establish signalling VCCs to other nodes. The local CRF provides an interconnection function based on using only the VPI portion of the ATM cell header for those VPCs that do not terminate at the local CRF, and based on both the VPI and VCI for those VPCs that do terminate at the local CRF.

NOTE – The procedures for establishing a signalling channel(s) for CEQ to CEQ signalling communication are for further study. Optionally, the meta-signalling protocol can be used.

Figure 14 illustrates an example of a VCC and a VPC and the relationship of user-network and internodal signalling procedures. In this example, user-network signalling is carried on one VPC designated as the VPC for carrying meta-signalling. Other signalling channels on this VPC are established using procedures over the meta-signalling channel.

Internodal signalling messages may be carried between network nodes over virtual channel connections designated for internodal signalling. The procedures for allocating these VCCs are for further study.

In some cases, signalling may be required over VPCs established between the CEQ and another CEQ, as shown in Case B and in Case C, Figure 13, in order to establish user VCCs within those VPCs. The procedure for establishing these signalling channels is for further study. Optionally, the meta-signalling protocol can be used.

In the upper portion of Figure 14, a virtual channel connection is illustrated between the CEQ on the left and the CEQ on the right side. This VCC is established by using user-network and internodal signalling procedures.

Two VP connections are illustrated in the lower portion of Figure 14 between the CEQ on the left and the CEQ on the right. One VPC contains a meta-signalling channel, which is used to establish additional signalling channels within that VPC. This VPC between the two CEQs may carry other non-signalling traffic. After signalling channels are established, signalling procedures are used to establish VCCs within VPCs between the two CEQs.

#### **5.3.4 Requirements for signalling procedures**

For further study.

## 6 Network capabilities to support charging of B-ISDN services

Services to be taken into account in B-ISDN's based on ATM technique include connection oriented as well as connectionless services, in different communication configurations as, for example, point-to-point, multipoint, broadcast and other services/connections.

Network capability to support the charging of these B-ISDN services is for further study.

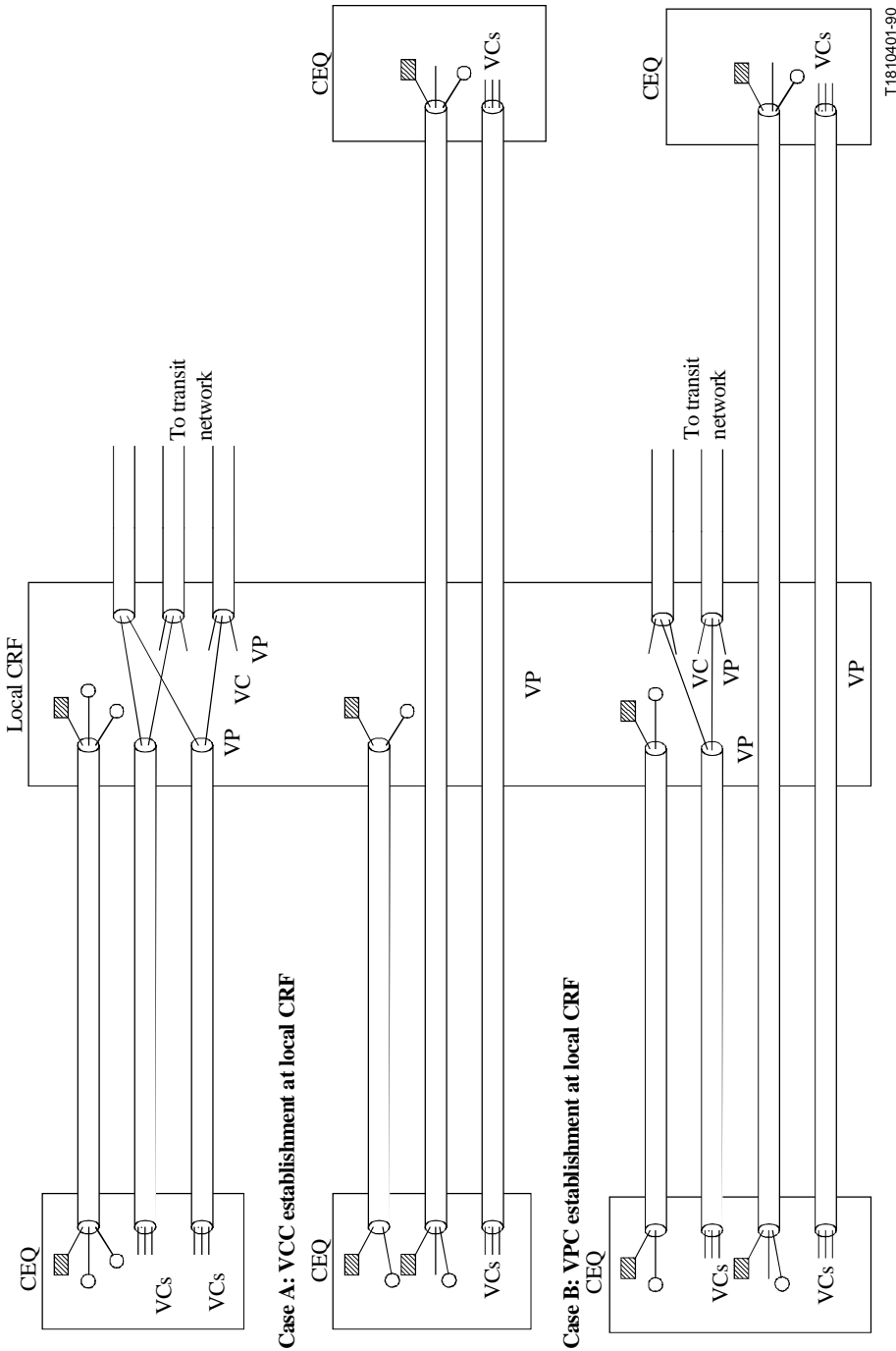
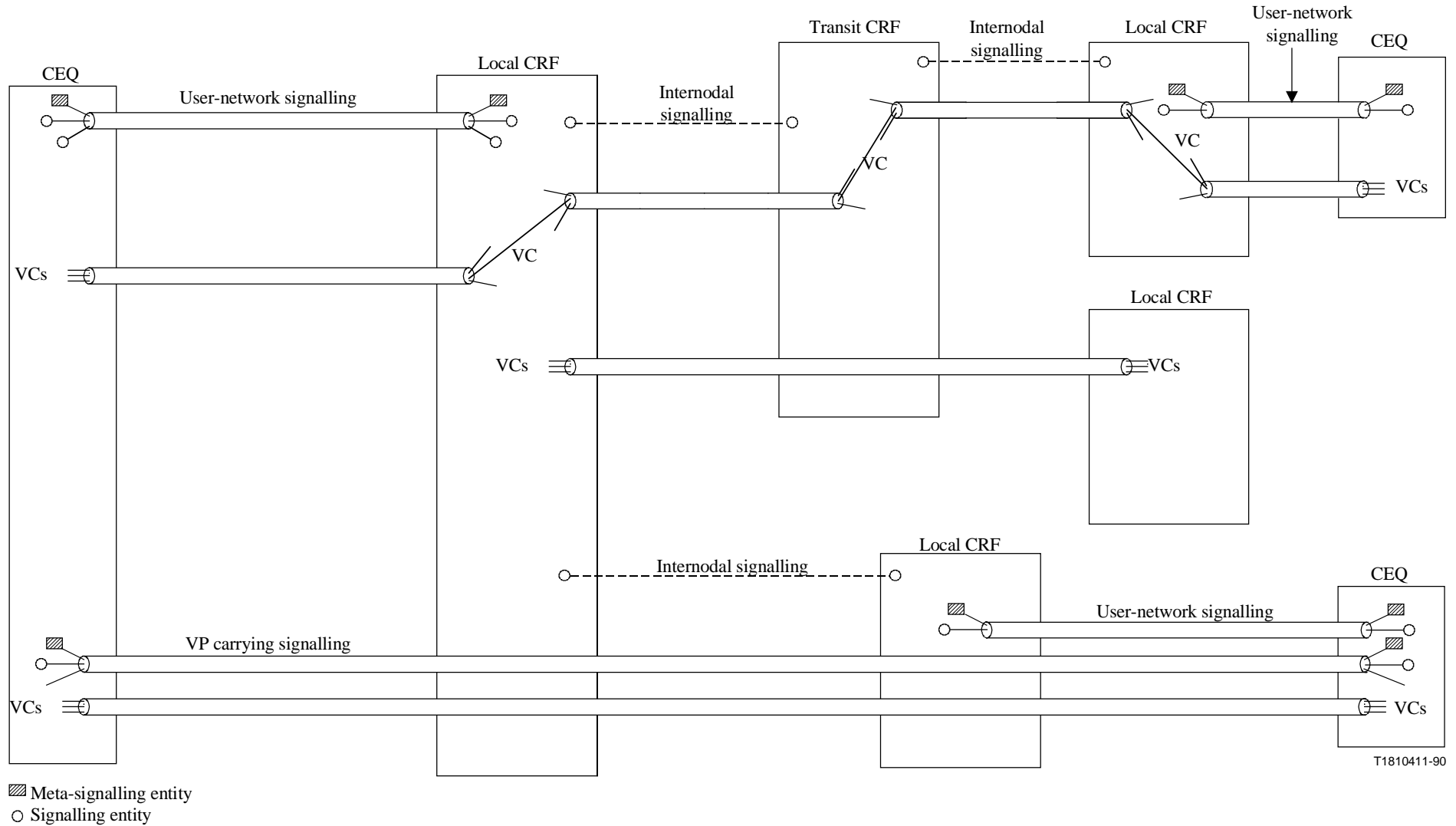

Figure 13/I.311 – Possible VPC/VCC establishment and signalling configurations



NOTE 1 – The implementation of local and transit CRF is not subject to ITU-T standardization. The CRF provides interconnection of ATM cells using routing information in the VPI and/or VCI.

NOTE 2 – The procedures for establishing channel(s) for CEQ to CEQ signalling communication are for further study. Optionally, the meta-signalling protocol can be used.

**Figure 14/I.311 – Relationship of VP/VC connections to user-network and internodal signalling**



## ANNEX A

### **Hierarchical structure for ATM transport network**

This Annex contains two examples of the hierarchical structure for the ATM transport network.

Figure A.1 shows the hierarchical structure for the cell-based ATM transport network and Figure A.2 shows the hierarchical structure for the SDH-based ATM transport network.

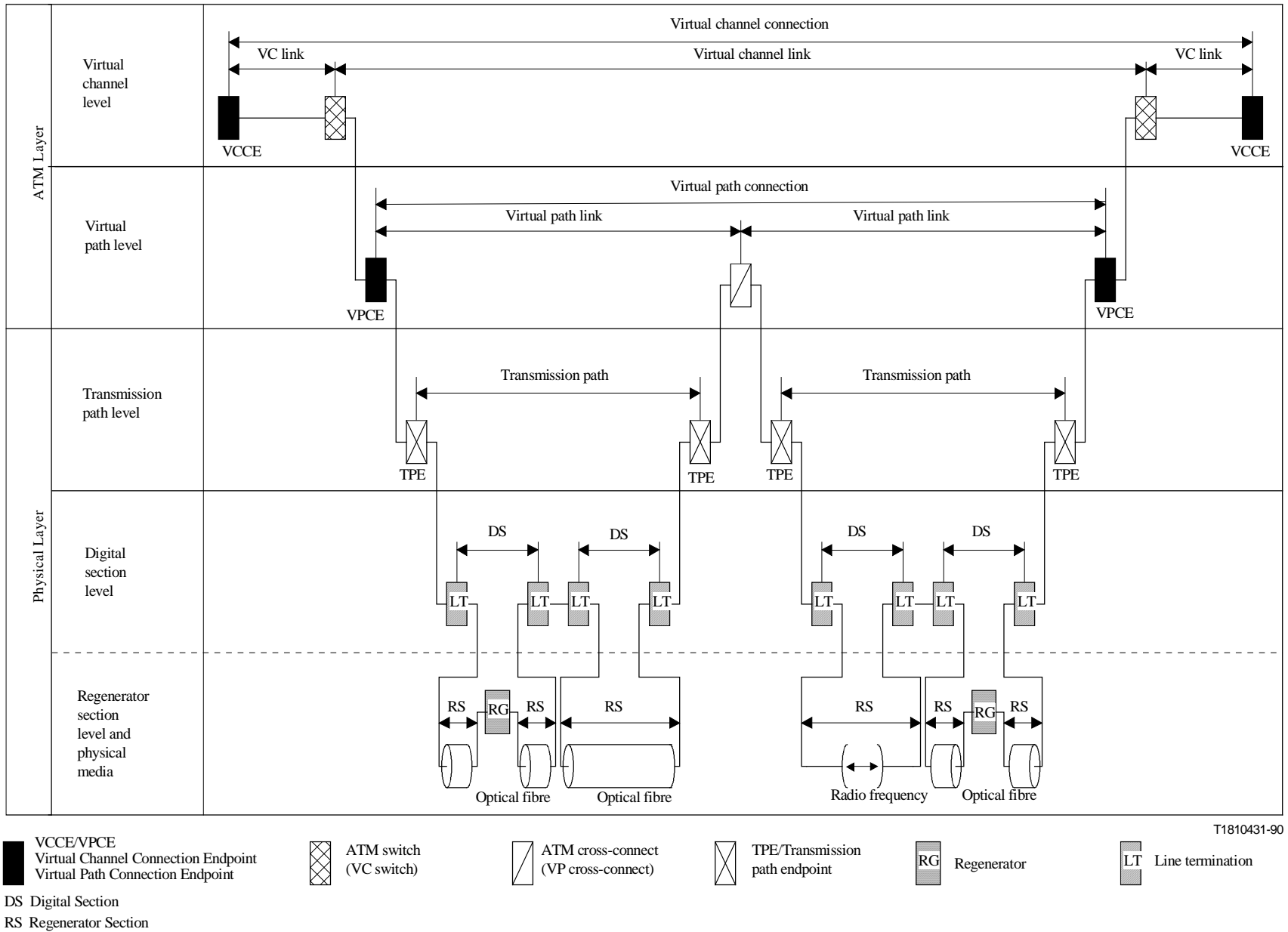
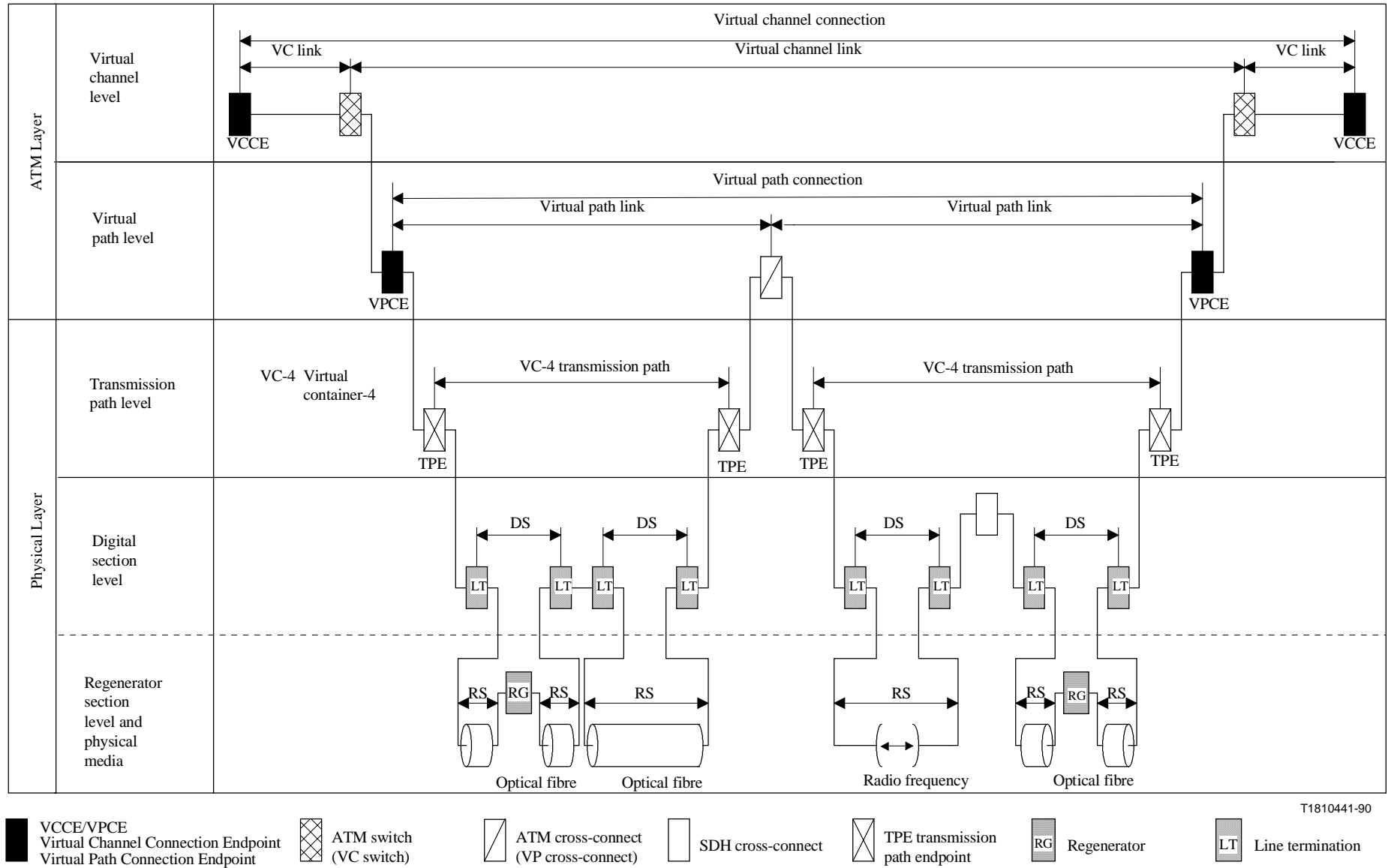

Figure A.1/I.311 – Hierarchical structure of a cell-based ATM transport network



**Figure A.2/I.311 – Hierarchical structure of a SDH-based ATM transport network**

## ANNEX B

### Network element functions and VP/VC connections

Figure B.1 shows the functions of VP/VC network elements through which various VPCs and VCCs are provided, by illustrating an example of VP/VC network element configuration at user access.

In this example, a customer equipment (CEQ) is connected to a VP-VC switch via VP cross-connect by three VPCs. These VPCs are provided by NMC through the communications with the VP-VC switch and the VP cross-connect.

In Figure B.1, there is a VPC whose VPI value is 0 before the translation in the VP cross-connect, extending from the CEQ to the VP-VC switch. It contains meta-signalling and signalling VCCs for user-to-network access as well as VCCs carrying user information.

There is another VPC whose VPI value is "a" before the translation in the VP cross-connect, extending from the CEQ to the VP-VC switch. This VPC contains some user information VCCs and signalling VCC but not meta-signalling VCC for the user-to-network access.

The user-to-user VPC extends from the CEQ to another remote CEQ which is not shown in the Figure. It contains meta-signalling and signalling VCCs for the user-to-user access, and user information VCCs as well.

In the right hand side of the Figure, there are two VPCs connecting the VP-VC switch to other (VP-)VC switches which are not shown. One of them contains only signalling VCCs, and the other user information VCCs as well as signalling VCCs.

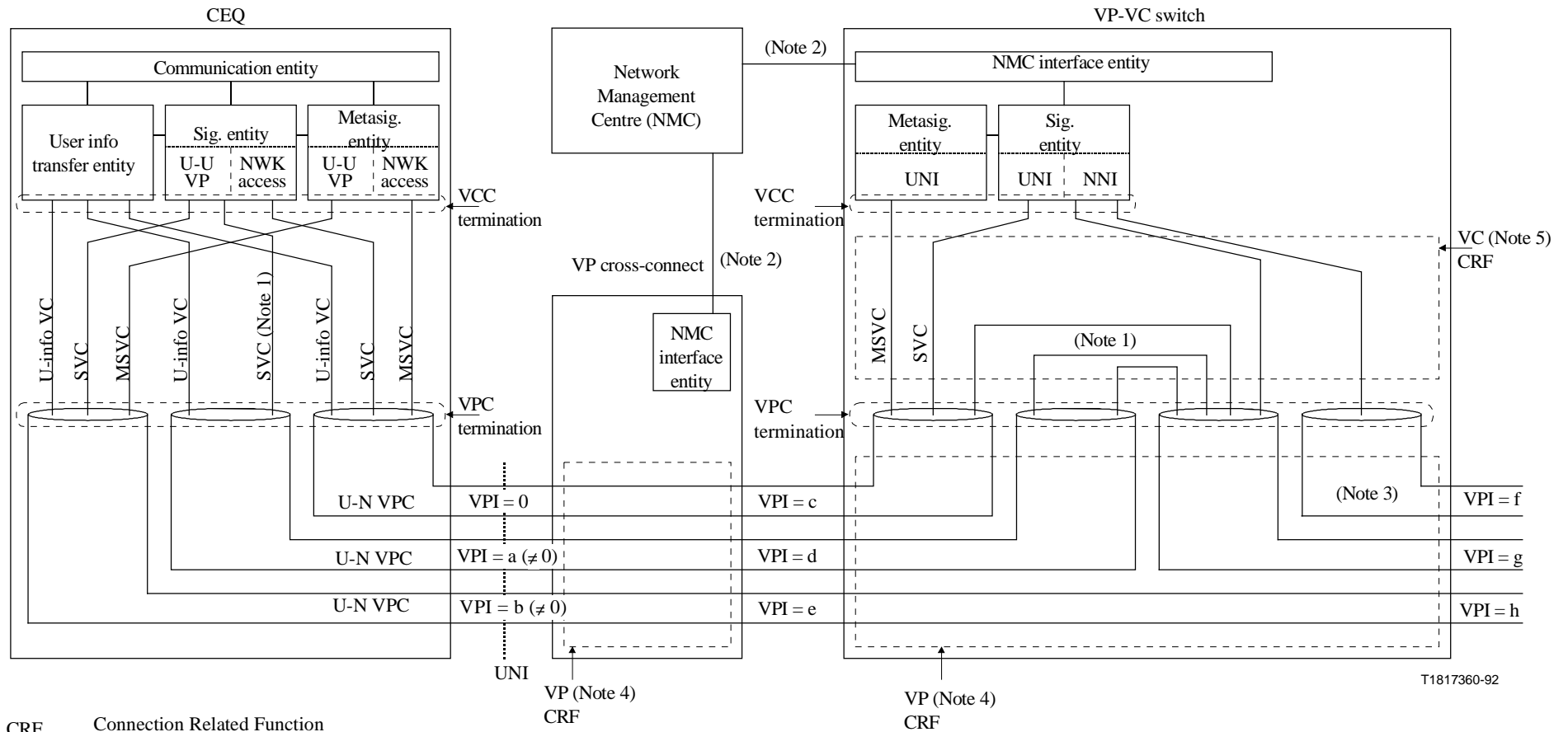

CRF Connection Related Function  
 SVC Signalling VC  
 MSVC Meta-Signalling VC

NOTE 1 – Sig. VCs for out-band control of user-to-user VPC are for further study.

NOTE 2 – Those links may also be ATM connections.

NOTE 3 – Network-network VP containing only signalling VCs.

Additional VCI values for signalling in this VP are pre-established. The method of pre-establishment is for further study.

NOTE 4 – VPI translation takes place in VP CRF.

NOTE 5 – VCI translation takes place in VC CRF.

Figure B.1/I.311 – Examples of VP and VC network element functions

## ANNEX C

### Definition and scope of service profiles at user access

NOTE – The network represents "point" and the terminals represent "multipoint". See 5.3.1.

#### C.1 Definition

A **service profile** is a collection of information maintained by the network, characterizing a set of services provided by the network to the user.

The provision of service profile is a network option.

A service profile contains information necessary to provide both basic services and supplementary services.

#### C.2 Scope

The support of service profile allows:

- A B-TE or a group of B-TE to identify a set of services as characterized by a specific service profile provided by the network.
- The use of selective broadcast signalling virtual channels for call offering.

The association between a signalling entity and a service profile is accomplished via the Service Profile Identifier (SPID), that is conveyed in the appropriate meta-signalling message(s).

The following cases are identified:

- *A terminal not implementing the SPID*  
The terminal shall indicate the default SPID value, in the meta-signalling assignment procedure and shall monitor the general broadcast SVC for incoming call offering.
- *A terminal implementing the SPID*  
Meta-signalling procedures must allow the user to indicate a SPID value to be carried in the assign request message and must be able to accept the broadcast (general or selective) SVCI value in the assignment response message.
- *A network not implementing the SPID*  
Meta-signalling procedures shall respond with a general broadcast SVCI value in the assignment response message as the incoming call offering channel, irrespective of the SPID value in the assignment request message.
- *A network implementing the SPID*  
Meta-signalling procedures must respond to the indicated SPID value with the associated broadcast (general or selective) SVCI value during the assignment procedures, allowing different standardized levels of service for user or an interface. If a terminal enters an unknown SPID, then the default value shall be assumed by the network and the general broadcast SVCI value shall be returned.

#### C.3 Service profile configuration

The following service profile configurations have been identified and require further study:

- only one service profile on an interface;
- only one service profile for all signalling endpoints using the same service on an interface;

- a default service profile to be used by all signalling endpoints that do not specify a service profile identifier as part of their signalling VCI request (i.e. the support of service profile could be optional for a signalling endpoint);
- one service profile per signalling endpoint;
- one service profile for all signalling endpoints of one terminal.

## APPENDIX I

### Example of a path and protocol stacks of network elements within B-ISDN signalling network

This example takes into consideration the following three network elements:

- B-SP B-ISDN signalling point. These nodes have signalling functions. They generate and process signalling messages.
- B-STP B-ISDN signalling transfer point. These nodes receive, route and forward signalling messages.
- VP-XC Virtual path cross connect.

In Figure I.1 there is an example of a path dedicated to signalling transport, which extends between two different TEs. This example can be regarded as a specific case of the general architecture of Figure 12.

The VPs in Figure I.1 (thick black lines) carry signalling VCs only. In this way, the signalling transport network is logically separated from the user data transport network at the NNI. Although logically separated from user data signalling information and user data could be transported by the same physical links.

Figure I.2 shows, in terms of protocol stacks, the path drawn in Figure I.1. Apart from the Physical Layer (PL), ATM layer and ATM Adaptation Layer (AAL), the stacks show a Network Layer (NL) and a "signalling higher layer".

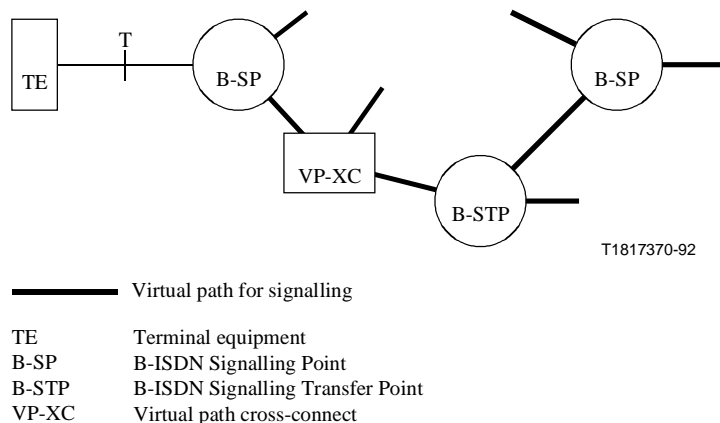

**Figure I.1/I.311 – Example of a path within the B-ISDN signalling network**

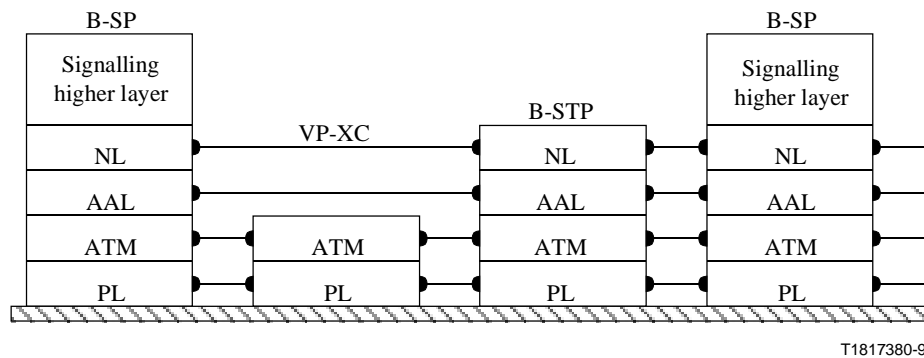

B-SP B-ISDN Signalling Point  
 B-STP B-ISDN Signalling Transfer Point  
 VP-XC Virtual path cross-connect  
 PL Physical Layer  
 ATM ATM Layer  
 AAL ATM Adaptation Layer  
 NL Network Layer

**Figure I.2/I.311 – Protocol stacks of network elements involved in the signalling transport**

## APPENDIX II

### B-ISDN management functions

Based on the two types of management functions, i.e. layer management and plane management as defined in Recommendation I.321, Figure II.1 shows the functional description of B-ISDN management which includes possible layer management functions and plane management functions.

NOTE – Definitions of protection switching, re-routing and self-healing in Figure II.1 are as follows:

- 1) **protection switching:** Protection switching is the establishment of a pre-assigned replacement connection by means of equipment without the NMC function. The equipment may either reside in the connecting and terminating points of related VP-level.
- 2) **re-routing:** Re-routing is the establishment of a replacement connection by the NMC function. When a connection failure occurs the replacement connection is routed depending on network resources available at that time.
- 3) **self-healing:** Self-healing is the establishment of a replacement connection by network without the NMC function. When a connection failure occurs the replacement connection is found by the network elements and rerouted depending on network resources available at that time.



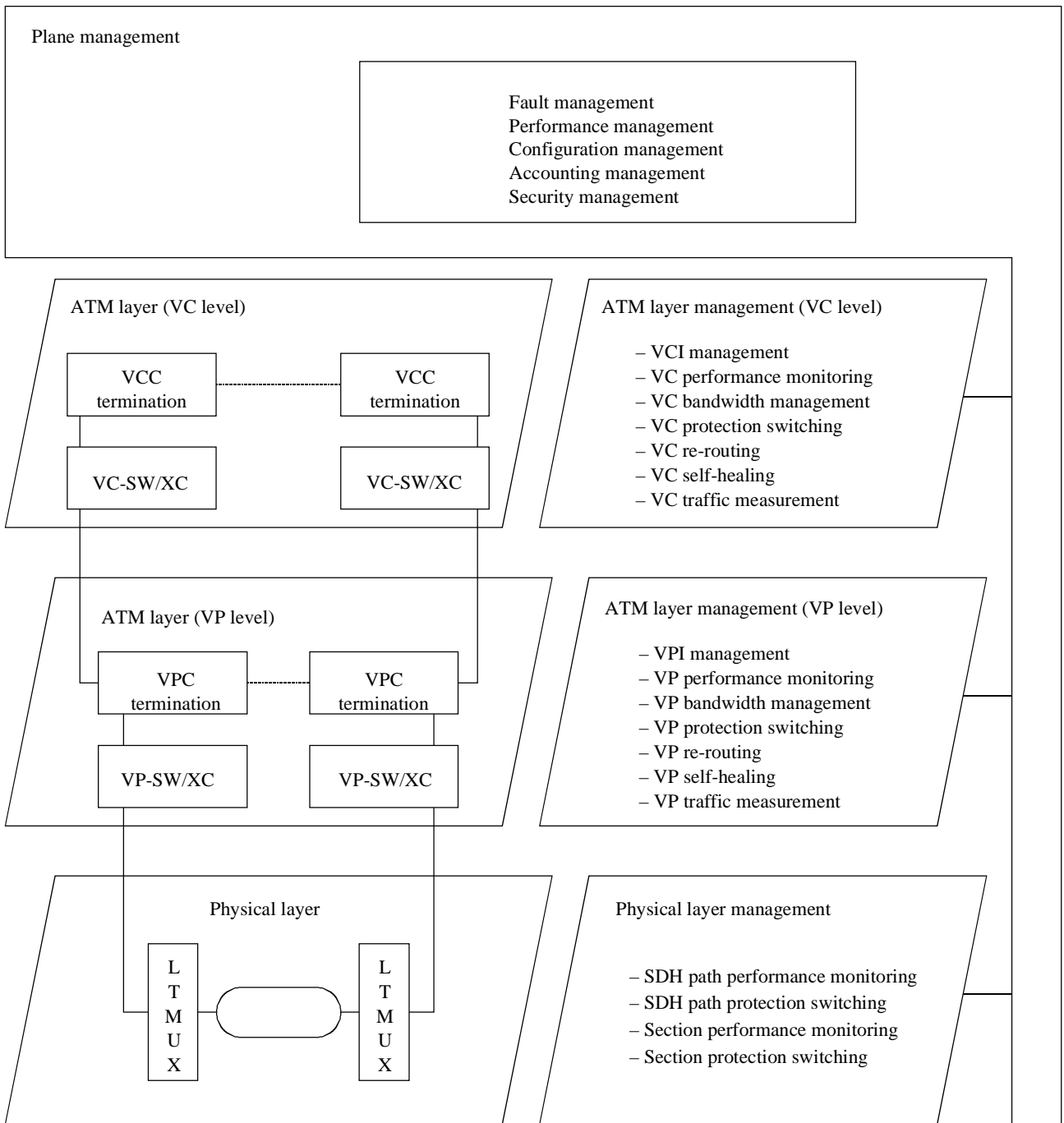

T1817390-92

**Figure II.1/I.311 – B-ISDN network management functional description**



## ITU-T RECOMMENDATIONS SERIES

|                 |  |
|-----------------|--|
| Series A        | Organization of the work of the ITU-T  |
| Series B        | Means of expression  |
| Series C        | General telecommunication statistics   |
| Series D        | General tariff principles  |
| Series E        | Telephone network and ISDN   |
| Series F        | Non-telephone telecommunication services   |
| Series G        | Transmission systems and media   |
| Series H        | Transmission of non-telephone signals  |
| <b>Series I</b> | <b>Integrated services digital network</b>   |
| Series J        | Transmission of sound-programme and television signals   |
| Series K        | Protection against interference  |
| Series L        | Construction, installation and protection of cables and other elements of outside plant                        |
| Series M        | Maintenance: international transmission systems, telephone circuits, telegraphy, facsimile and leased circuits |
| Series N        | Maintenance: international sound-programme and television transmission circuits                                |
| Series O        | Specifications of measuring equipment  |
| Series P        | Telephone transmission quality   |
| Series Q        | Switching and signalling   |
| Series R        | Telegraph transmission   |
| Series S        | Telegraph services terminal equipment  |
| Series T        | Terminal equipments and protocols for telematic services   |
| Series U        | Telegraph switching  |
| Series V        | Data communication over the telephone network  |
| Series X        | Data networks and open system communication  |
| Series Z        | Programming languages  |