

ITU-T

TELECOMMUNICATION
STANDARDIZATION SECTOR
OF ITU

G.8275/Y.1369

(11/2013)

SERIES G: TRANSMISSION SYSTEMS AND MEDIA,
DIGITAL SYSTEMS AND NETWORKS

Packet over Transport aspects – Quality and availability
targets

SERIES Y: GLOBAL INFORMATION
INFRASTRUCTURE, INTERNET PROTOCOL ASPECTS
AND NEXT-GENERATION NETWORKS

Internet protocol aspects – Transport

**Architecture and requirements for packet-based
time and phase distribution**

Recommendation ITU-T G.8275/Y.1369

ITU-T G-SERIES RECOMMENDATIONS

TRANSMISSION SYSTEMS AND MEDIA, DIGITAL SYSTEMS AND NETWORKS

INTERNATIONAL TELEPHONE CONNECTIONS AND CIRCUITS	G.100–G.199
GENERAL CHARACTERISTICS COMMON TO ALL ANALOGUE CARRIER-TRANSMISSION SYSTEMS	G.200–G.299
INDIVIDUAL CHARACTERISTICS OF INTERNATIONAL CARRIER TELEPHONE SYSTEMS ON METALLIC LINES	G.300–G.399
GENERAL CHARACTERISTICS OF INTERNATIONAL CARRIER TELEPHONE SYSTEMS ON RADIO-RELAY OR SATELLITE LINKS AND INTERCONNECTION WITH METALLIC LINES	G.400–G.449
COORDINATION OF RADIOTELEPHONY AND LINE TELEPHONY	G.450–G.499
TRANSMISSION MEDIA AND OPTICAL SYSTEMS CHARACTERISTICS	G.600–G.699
DIGITAL TERMINAL EQUIPMENTS	G.700–G.799
DIGITAL NETWORKS	G.800–G.899
DIGITAL SECTIONS AND DIGITAL LINE SYSTEM	G.900–G.999
MULTIMEDIA QUALITY OF SERVICE AND PERFORMANCE – GENERIC AND USER-RELATED ASPECTS	G.1000–G.1999
TRANSMISSION MEDIA CHARACTERISTICS	G.6000–G.6999
DATA OVER TRANSPORT – GENERIC ASPECTS	G.7000–G.7999
PACKET OVER TRANSPORT ASPECTS	G.8000–G.8999
Ethernet over Transport aspects	G.8000–G.8099
MPLS over Transport aspects	G.8100–G.8199
Quality and availability targets	G.8200–G.8299
Service Management	G.8600–G.8699
ACCESS NETWORKS	G.9000–G.9999

For further details, please refer to the list of ITU-T Recommendations.

Recommendation ITU-T G.8275/Y.1369

Architecture and requirements for packet-based time and phase distribution

Summary

Recommendation ITU-T G.8275/Y.1369 describes the architecture and requirements for packet-based time and phase distribution in telecom networks. The architecture described is mainly applicable to the use of IEEE 1588. Details necessary to utilize IEEE 1588 in a manner consistent with the architecture are defined in other Recommendations.

History

Edition	Recommendation	Approval	Study Group	Unique ID*
1.0	ITU-T G.8275/Y.1369	2013-11-22	15	11.1002/1000/12011-en

Keywords

IEEE1 588, packet synchronization, phase, time.

* To access the Recommendation, type the URL <http://handle.itu.int/> in the address field of your web browser, followed by the Recommendation's unique ID. For example, <http://handle.itu.int/11.1002/1000/11830-en>.

FOREWORD

The International Telecommunication Union (ITU) is the United Nations specialized agency in the field of telecommunications, information and communication technologies (ICTs). The ITU Telecommunication Standardization Sector (ITU-T) is a permanent organ of ITU. ITU-T is responsible for studying technical, operating and tariff questions and issuing Recommendations on them with a view to standardizing telecommunications on a worldwide basis.

The World Telecommunication Standardization Assembly (WTSA), which meets every four years, establishes the topics for study by the ITU-T study groups which, in turn, produce Recommendations on these topics.

The approval of ITU-T Recommendations is covered by the procedure laid down in WTSA Resolution 1.

In some areas of information technology which fall within ITU-T's purview, the necessary standards are prepared on a collaborative basis with ISO and IEC.

NOTE

In this Recommendation, the expression "Administration" is used for conciseness to indicate both a telecommunication administration and a recognized operating agency.

Compliance with this Recommendation is voluntary. However, the Recommendation may contain certain mandatory provisions (to ensure, e.g., interoperability or applicability) and compliance with the Recommendation is achieved when all of these mandatory provisions are met. The words "shall" or some other obligatory language such as "must" and the negative equivalents are used to express requirements. The use of such words does not suggest that compliance with the Recommendation is required of any party.

INTELLECTUAL PROPERTY RIGHTS

ITU draws attention to the possibility that the practice or implementation of this Recommendation may involve the use of a claimed Intellectual Property Right. ITU takes no position concerning the evidence, validity or applicability of claimed Intellectual Property Rights, whether asserted by ITU members or others outside of the Recommendation development process.

As of the date of approval of this Recommendation, ITU had not received notice of intellectual property, protected by patents, which may be required to implement this Recommendation. However, implementers are cautioned that this may not represent the latest information and are therefore strongly urged to consult the TSB patent database at <http://www.itu.int/ITU-T/ipr/>.

© ITU 2014

All rights reserved. No part of this publication may be reproduced, by any means whatsoever, without the prior written permission of ITU.

Table of Contents

	Page
1 Scope	1
2 References.....	1
3 Definitions	2
4 Abbreviations and acronyms	2
5 Conventions	2
6 General introduction to packet-based time/phase distribution	2
6.1 Requirements for packet-based time and phase distribution.....	3
7 Architecture of packet-based time/phase distribution	3
7.1 Packet-based time and phase distribution.....	3
7.2 Time/phase protection aspects.....	4
7.3 Packet network partitioning.....	13
8 Security aspects	14
9 Management aspects.....	14
Annex A – Time/phase models based on ITU-T G.805	15
Appendix I – Architecture for time and phase distribution over a packet network providing partial timing support at the protocol level	17
I.1 Architecture for partial timing support.....	17

Introduction

Recommendation ITU-T G.8275/Y.1369 describes the general architecture of time and phase distribution using packet-based methods. This Recommendation forms the base architecture for the development of telecom profiles for time and phase distribution. The architecture described covers the case where protocol interaction is at all nodes, between a packet master clock and a packet slave clock. Details of the necessary profiles are described in other Recommendations.

Recommendation ITU-T G.8275/Y.1369

Architecture and requirements for packet-based time and phase distribution

1 Scope

This Recommendation describes the general architecture of time and phase distribution using packet-based methods. This version of the Recommendation focuses on the distribution of time and phase using the standard for precision time protocol (PTP) [IEEE 1588]. The requirements and architecture form a base for the specification of other functionalities that are needed to achieve packet-based time and phase distribution in a carrier environment. The architecture described covers the case where protocol interaction is at all nodes, between a packet master clock and a packet slave clock. Details of the necessary profiles are described in other Recommendations.

2 References

The following ITU-T Recommendations and other references contain provisions which, through reference in this text, constitute provisions of this Recommendation. At the time of publication, the editions indicated were valid. All Recommendations and other references are subject to revision; users of this Recommendation are therefore encouraged to investigate the possibility of applying the most recent edition of the Recommendations and other references listed below. A list of the currently valid ITU-T Recommendations is regularly published. The reference to a document within this Recommendation does not give it, as a stand-alone document, the status of a Recommendation.

- [ITU-T G.805] Recommendation ITU-T G.805 (2000), *Generic functional architecture of transport networks*.
- [ITU-T G.810] Recommendation ITU-T G.810 (1996), *Definitions and terminology for synchronization networks*.
- [ITU-T G.8260] Recommendation ITU-T G.8260 (2012), *Definitions and terminology for synchronization in packet networks*.
- [ITU-T G.8261] Recommendation ITU-T G.8261/Y.1361 (2013), *Timing and synchronization aspects in packet networks*.
- [ITU-T G.8262] Recommendation ITU-T G.8262/Y.1362 (2010), *Timing characteristics of a synchronous Ethernet equipment slave clock*.
- [ITU-T G.8264] Recommendation ITU-T G.8264/Y.1364 (2008), *Distribution of timing information through packet networks*.
- [ITU-T G.8265] Recommendation ITU-T G.8265/Y.1365 (2010), *Architecture and requirements for packet-based frequency delivery*.
- [ITU-T G.8265.1] Recommendation ITU-T G.8265.1/Y.1365.1 (2010), *Precision time protocol telecom profile for frequency synchronization*.
- [ITU-T G.8271] Recommendation ITU-T G.8271/Y.1366 (2012), *Time and phase synchronization aspects of packet networks*.
- [ITU-T G.8271.1] Recommendation ITU-T G.8271.1/Y.1366.1 (2014), *Network limits for time synchronization in packet networks*.
- [ITU-T G.8272] Recommendation ITU-T G.8272/Y.1367 (2012), *Timing characteristics of primary reference time clocks*.
- [IEEE 1588] IEEE STD 1588 (2008), *Standard for a Precision Clock Synchronization Protocol for Networked Measurement and Control Systems*.

3 Definitions

The terms and definitions used in this Recommendation are contained in [ITU-T G.810] and [ITU-T G.8260].

4 Abbreviations and acronyms

This Recommendation uses the following abbreviations and acronyms:

BC	Boundary Clock
BMCA	Best Master Clock Algorithm
EEC	Synchronous Ethernet Equipment Clock
ESMC	Ethernet Synchronization Messaging Channel
GM	Grand Master
GNSS	Global Navigation Satellite System
LTE	Long Term Evolution
NTP	Network Time Protocol
OTN	Optical Transport Network
PDV	Packet Delay Variation
PRC	Primary Reference Clock
PRTC	Primary Reference Time Clock
PTP	Precision Time Protocol
QL	Quality Level
SEC	SDH Equipment Clock
SSM	Synchronization Status Message
SSU	Synchronization Supply Unit
T-BC	Telecom Boundary Clock
T-TC	Telecom Transparent Clock
T-TSC	Telecom Time Slave Clock
TC	Transparent Clock

5 Conventions

Within this Recommendation, the term PTP refers to the PTP version 2 protocol defined in [IEEE 1588].

6 General introduction to packet-based time/phase distribution

The distribution of accurate time and phase is necessary to support certain telecom-based services and in particular the underlying infrastructure. While traditional network synchronization has relied on the accurate distribution of frequency, evolving wireless networks require the distribution of accurate time and phase.

As the network evolves from a primarily TDM-based network infrastructure to one using packet-based technology, the ability to distribute synchronization is also changing.

In order to enable timing distribution in packet-based networks, the ITU-T developed specifications ([ITU-T G.8261], [ITU-T G.8262] and [ITU-T G.8264]) for synchronous Ethernet, which allowed the use of the Ethernet physical layer to be used as a mechanism to distribute frequency analogous to the methods used with SDH-based network synchronization. In this regard, synchronous Ethernet, by appropriate specification of network equipment clocks provided support for the existing frequency-based synchronization network over both existing TDM and new packet-based technology.

In the absence of the ability to utilize the physical layer, the ITU also developed Recommendations covering frequency distribution using packet-based methods such as precision time protocol (PTP) and network time protocol (NTP). The use of packet-based methods also enabled new frequency synchronization scenarios to be considered. These, as well as other aspects specific to packet-based frequency distribution, resulted in the development of an architectural specification [ITU-T G.8265].

This Recommendation describes the architecture for packet-based time and phase distribution.

6.1 Requirements for packet-based time and phase distribution

Packet-based mechanisms for time and phase distribution must meet the following requirements:

- 1) Mechanisms must be specified to allow interoperability between the various phase/time clocks defined in this architecture.
- 2) Mechanisms must permit consistent operation over managed wide area telecom networks.
- 3) Packet-based mechanisms must allow the synchronization network to be designed and configured in a fixed arrangement.
- 4) Protection schemes used by packet-based systems must be based on standard telecom operational practice and allow telecom time slave clocks (T-TSC) the ability to take phase and time from multiple geographically separate telecom grand master (T-GM) clocks.
- 5) Phase/time reference source selection based on received phase/time traceability and local priority should be permitted. Automatic establishment of the phase/time synchronization network topology may also be possible.

7 Architecture of packet-based time/phase distribution

In contrast to physical layer synchronization, where the significant edges of a data signal define the timing content of the signal, packet-based methods rely on the transmission of dedicated "event packets". These "event packets" form the significant instants of a packet timing signal. The timing of these significant instants is precisely measured relative to a master time source, and this timing information is encoded in the form of a time stamp, which is a machine-readable representation of a specific instance of time. The time stamp is generated via a packet master function and is carried over a packet network to a packet slave clock.

A protocol is used between the master and the slave clocks in order to adjust for transmission and other delays, resulting in both the master and slave clocks having the same time reference.

As time is the integral of frequency, the time stamps can also be used to derive frequency. This case is covered in [ITU-T G.8265] and [ITU-T G.8265.1].

7.1 Packet-based time and phase distribution

A time reference is initially obtained from a primary reference time clock (PRTC). If the time across the system is required to be referenced to UTC or to some other universal standard source of time, the PRTC itself may require a time reference input such as a GNSS signal.

For the purposes of time and phase synchronization transport, the packet master delivers its reference to the packet slave clocks using a packet timing signal (see [ITU-T G.8260]).

In order to achieve better accuracy, protocol-level timing support may be used at the various network nodes. Specifically for the IEEE 1588 PTP protocol, these intermediate devices are termed boundary clocks (BCs) or transparent clocks (TCs).

The architecture described in this Recommendation describes the case where all of the nodes in the transmission path will provide timing support by participating in the timing protocol. This is termed "full timing support to the protocol level" (see [ITU-T G.8260]).

The current version of this Recommendation describes an architecture for this case (full timing support to the protocol level), where all the intermediate nodes are T-BCs with physical layer frequency support. Transparent clocks are being studied and may be included in future versions of this Recommendation.

Other architectures where not all of the nodes need to provide timing support by participating in the timing protocol are for further study and may be included in future versions of this Recommendation. This is termed "partial timing support to the protocol level" (see [ITU-T G.8260]). These are for further study. Some initial considerations for this topic are documented in Appendix I.

In both types of architectures, physical layer frequency support may be available to stabilize the operation of the T-BCs or T-TCs.

The time-transfer protocol operating between the nodes allows the same time to be recovered or corrected at all nodes participating in the timing protocol, subject to some degradation (δ).

The general network topology for time/phase distribution from a packet master clock PRTC to a telecom time slave clock (T-TSC) is shown in Figure 1. The synchronization flow is from the master to slave, although the timing messages will flow in both directions. Individual nodes are telecom boundary clocks (T-BC) in the case of full support from the network.

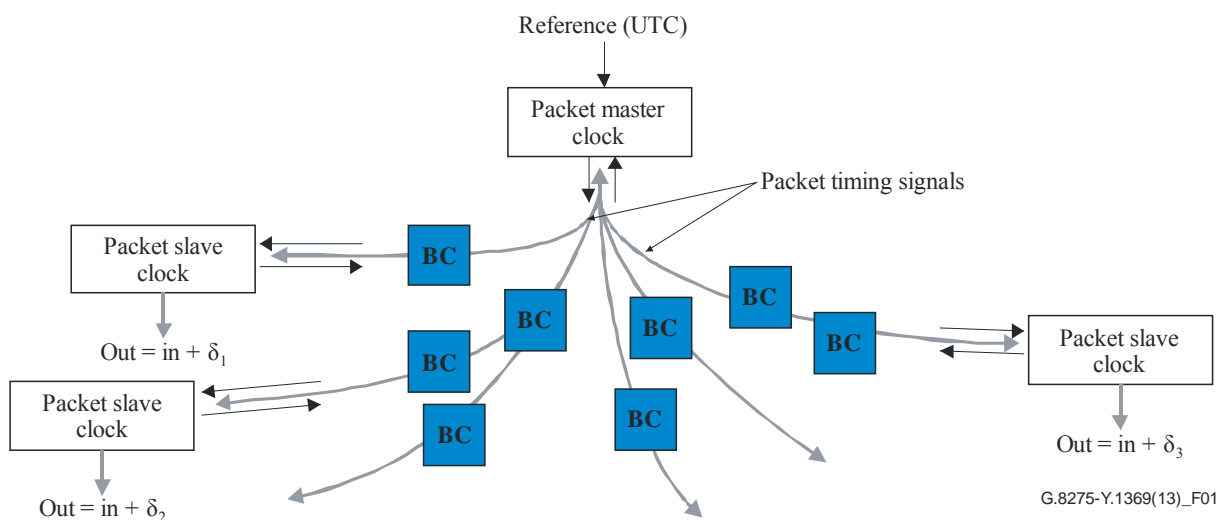

Figure 1 – Time distribution to slave clocks

Additional aspects related to performance are also covered in [ITU-T G.8271] and [ITU-T G.8271.1].

7.2 Time/phase protection aspects

Protection is required in order to optimize the performance of services. Protection is defined as mechanisms that allow maintaining the phase/time reference delivered to the end application (e.g., a

base station) to an acceptable level during failure events. It includes redundancy of the phase/time primary reference sources (time-plane rearrangement) and phase/time holdover (time-plane holdover). Protection is described in the next sections in terms of protection of the packet master/PRTC and protection of the packet slave.

7.2.1 Packet master protection

PRTC location

When considering phase/time distribution, the PRTC functions can be located at different positions, depending on the overall architecture that the network operator wishes to follow. However, these can be summarized into the four generic locations described in this clause.

These are the main scenarios, others may be considered.

Case A: centralized PRTC co-located with a primary reference clock (PRC)

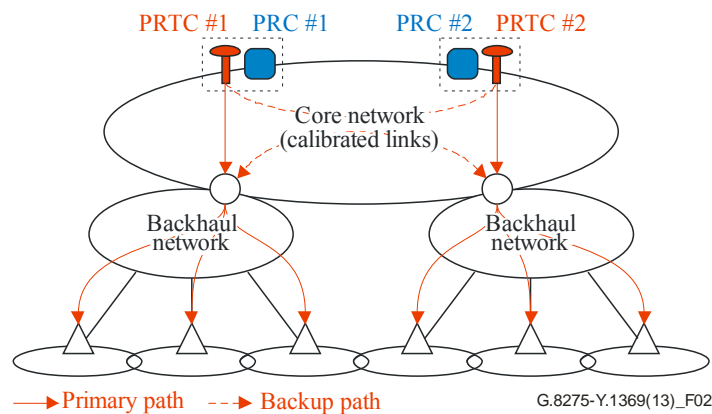

NOTE – T-GM are connected to the PRTC in this architecture

Figure 2 – Architecture with centralized PRTC functions co-located with PRC

Note, this only shows a primary path to the base stations, other protection mechanisms may be present, but are not shown. Some details may be hidden.

This architecture is compatible with PRTC redundancy (e.g., in order to protect against GNSS failures): in case one of the PRTCs fails, another PRTC would deliver the reference to the nodes that have previously been receiving the reference from the PRTC in failure.

Note that this architecture requires the links of the core network to be properly calibrated in order to avoid the accumulation of excessive time error due to link asymmetry.

Case B: centralized PRTC not co-located with PRC

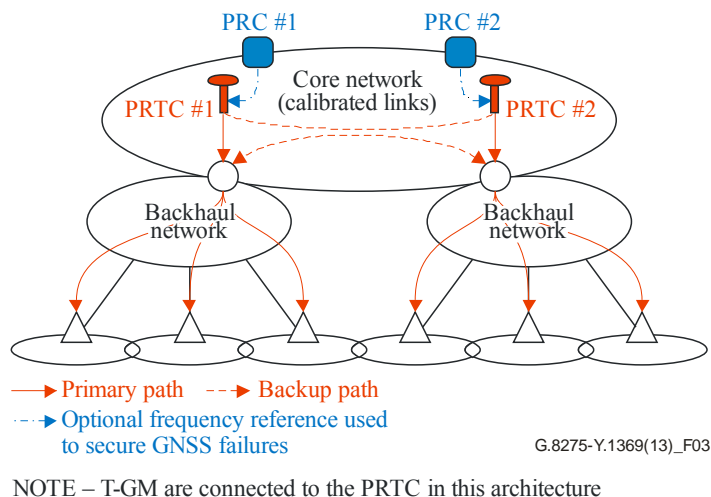

Figure 3 – Architecture with centralized PRTC functions not co-located with PRC

This architecture is also compatible with PRTC redundancy. In addition, the PRTC function may receive a PRC-traceable physical layer frequency reference (e.g., synchronous Ethernet) in order to provide additional protection against GNSS failures, or to participate in the generation of the reference provided by the PRTC under nominal conditions.

Note that this architecture also requires the links of the core network to be properly calibrated in order to avoid the accumulation of excessive time error due to link asymmetry.

Case C: distributed PRTC in aggregation sites

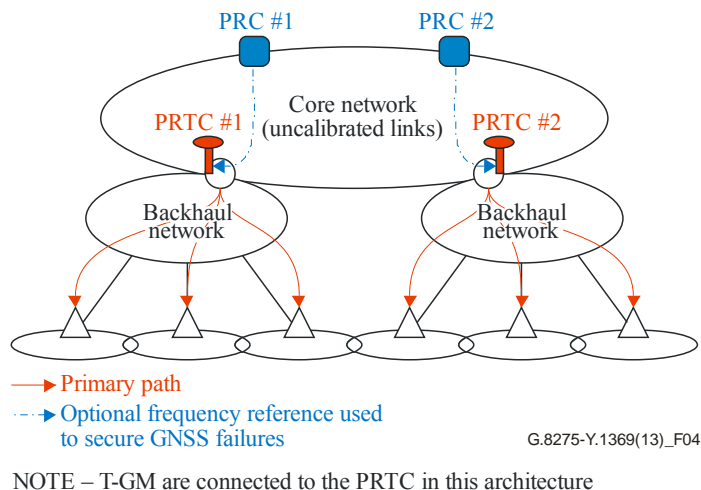

Figure 4 – Architecture with PRTC functions distributed in aggregation sites

In this architecture, the PRTC function is located in an aggregation site; typically, a GNSS receiver is added to one of the last synchronization supply units (SSUs) of the physical layer frequency chain. This implies the deployment of a higher number of GNSS receivers than in the centralized PRTC architecture. However, the advantage is that the links of the core network do not have to be calibrated to compensate for the link asymmetry.

PRTC redundancy schemes are not always compatible with this architecture, especially when considered between different aggregation sites; indeed, there is in general no direct connectivity between these aggregation sites.

When PRTC redundancy is considered between different aggregation sites, it implies that some nodes of the core network would support PTP clocks (e.g., T-BC to be supported by the nodes between the PRTC functions), as well as proper calibration of some of the links of the core network.

When PRTC redundancy is not used, it is recommended that GNSS failures would be secured by other means; typically, the use of a PRC-traceable physical layer frequency reference delivered to the PRTC function allows extending the phase/time holdover period during GNSS failures.

Case D: distributed PRTC at the cell sites

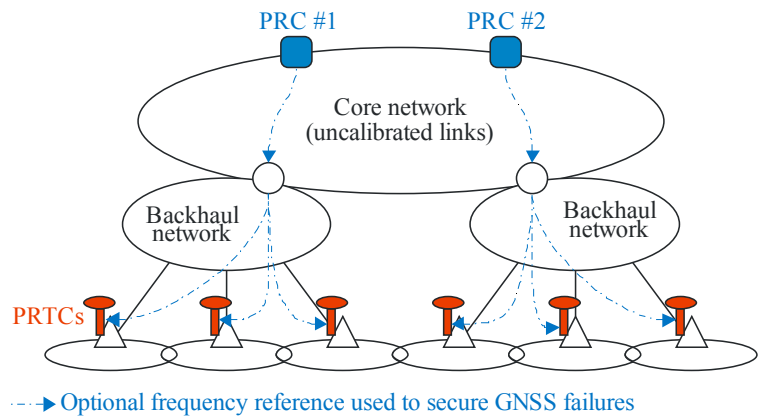

G.8275-Y.1369(13)_F05

NOTE – There is normally no T-GM connected to the PRTC in this architecture

Figure 5 – Architecture with PRTC functions distributed at cell sites

In this architecture, the PRTC function is now located directly at the cell site; typically, a GNSS receiver is directly connected to the base stations. This implies deployment of a higher number of GNSS receivers than in the "centralized PRTC" and "distributed PRTC in an aggregation site" architectures. However, the advantage is that the links of both the core and backhaul networks do not have to be calibrated to compensate for the link asymmetry.

PRTC redundancy schemes are not compatible with this architecture between different cell sites. It is therefore recommended that GNSS failures would be secured by other means; typically, the use of a PRC-traceable physical layer frequency reference delivered to the PRTC function allows extending the phase/time holdover period during GNSS failures.

The use of T-GM to distribute phase/time between different cell sites is for further study.

Applicable PRTC models depending on PRTC location

The first PRTC model, illustrated in Figure 6, where no physical layer frequency input is present, may be applicable to Case A introduced earlier. It corresponds to the case where PRTC and PRC functions are merged in the same equipment and coherency between the frequency and phase/time planes is therefore ensured.

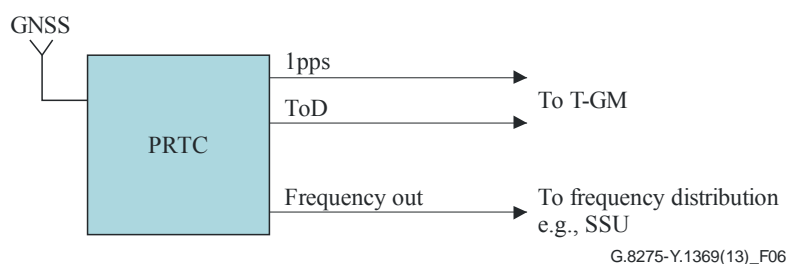

G.8275-Y.1369(13)_F06

Figure 6 – PRTC model with no physical layer frequency input

The second PRTC model, illustrated in Figure 7, where a physical layer frequency input is present and may be applicable to the Cases A, B, C, and D introduced earlier. It corresponds to the case where PRTC and PRC functions are implemented in separate equipment and coherency between the frequency and phase/time planes is not always ensured.

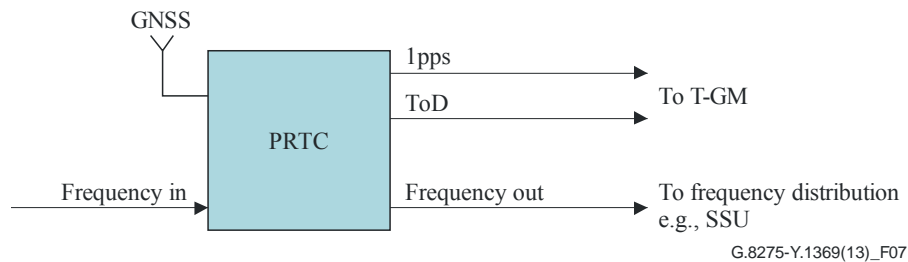

Figure 7 – PRTC model with a physical layer frequency input

The case where the PRTC and T-GM are combined is shown in Figure 8. Note that the Ethernet interface that supplies PTP may also supply frequency (i.e., it operates as a synchronous Ethernet interface).

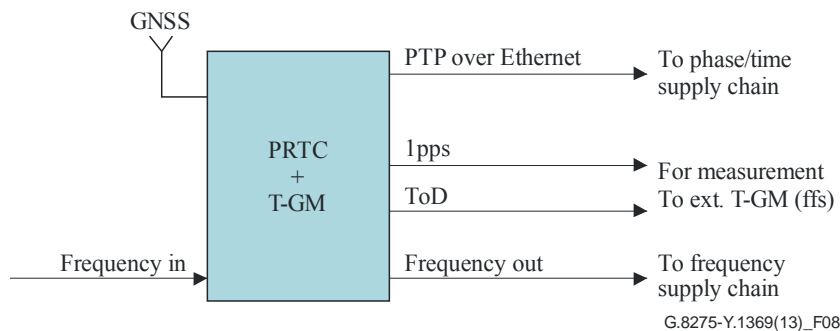

Figure 8 – Combined PRTC and T-GM

7.2.2 Packet slave protection

This clause deals with the various schemes that may be considered for providing redundancy in the distribution of a time synchronization reference.

Three protection scenarios for phase/time synchronization of the packet slave are described. The scenarios are:

- 1) phase/time long-term holdover with physical layer frequency synchronization support;
- 2) switching to a backup reference with physical layer frequency synchronization support;
- 3) switching to a backup reference without physical layer frequency synchronization support.

Protection scenarios 2 and 3 involve time-plane rearrangements, while protection scenario 1 involves time-plane holdover. In protection scenario 2, the frequency reference during the rearrangement is provided via physical layer support, i.e., synchronous Ethernet. In protection scenario 3, the frequency reference during the rearrangement is provided via the end application clock in holdover. In protection scenario 1, the phase/time holdover is provided by physical layer support.

The three scenarios are described in the following subclauses.

7.2.2.1 Protection scenario 1

Protection scenario 1 involves holdover with physical layer frequency support (i.e., synchronous Ethernet), where the period of holdover is generally much longer than the period of the

rearrangement of protection scenario 2 (see clause 7.2.2.2). Three sub-scenarios may be considered for protection scenario 1. It is assumed that there is no backup master in this case:

- a) Scenario 1.1: The synchronous Ethernet reference used during holdover is available at the end application.
- b) Scenario 1.2: The synchronous Ethernet reference used during holdover is available at the PRTC, and it is the PRTC that enters holdover by losing its GNSS reference. The end application receives its timing from the PRTC via PTP.
- c) Scenario 1.3: The synchronous Ethernet reference used during holdover is available at the PRTC, and it is the PRTC that enters holdover by losing its GNSS reference. The end application is collocated with and receives its timing directly from the PRTC.

Three holdover periods are of interest for protection scenarios 1.1, 1.2 and 1.3:

- 1) short holdover period, on the order of minutes (e.g., up to 5 minutes maximum);
- 2) long holdover period, on the order of hours (e.g., up to 8 hours);
- 3) very long holdover periods, on the order of days (e.g., up to 3 days).

The short holdover period is assumed to cover cases where the GNSS signals become unavailable for a short period of time. The long holdover period is assumed to cover cases where the GNSS signals remain unavailable for a longer period of time, possibly without the need for an on-site operator intervention. The very long holdover period cover the cases of very long failures, for which an on-site operator intervention is necessary.

Protection scenario 1.1 is illustrated in Figure 9. In this protection scenario, the phase/time synchronization path fails and the end application (e.g., the base station) is informed that the reference signal is no longer traceable to a PRTC so that it would switch to holdover. Note that relying on only a free-running local clock, even of good quality, may not allow addressing the long and very long holdover periods mentioned above. Instead, the local clock in the end application must be locked to an accurate and stable physical layer frequency reference, such as synchronous Ethernet.

The phase/time long term holdover function is assumed to be supported in a PTP clock capable of adequately filtering the noise that may be present on the synchronous Ethernet reference. The same function can be used in a base station receiving both a 1PPS input signal and a synchronous Ethernet reference. During the holdover period, any timing signal delivered to the application by PTP is not used.

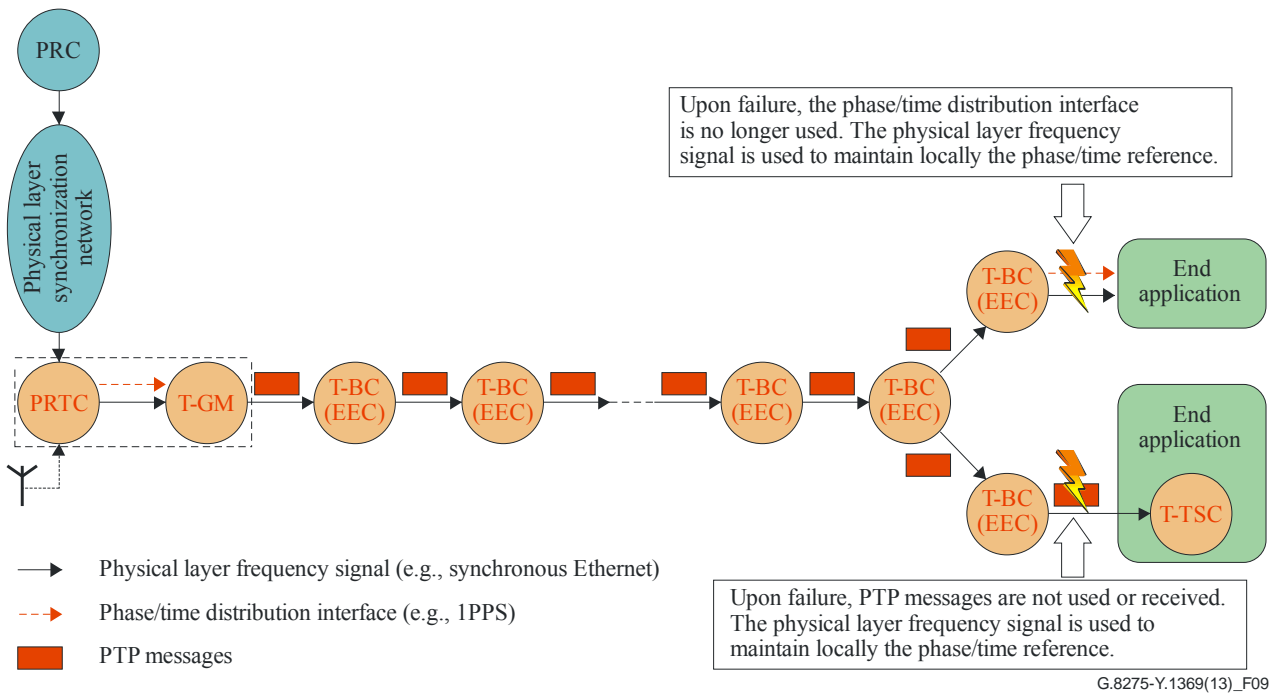

Figure 9 – Illustration of protection scenario 1.1 at the T-TSC (phase/time long-term holdover at the T-TSC embedded in the end application)

Protection scenario 1.2 is illustrated in Figure 10. In this case, the phase/time long-term holdover function is supported by the PRTC/T-GM. Like protection scenario 1.1, this holdover function includes a clock that is capable of providing a high quality frequency reference (e.g., high quality local oscillator or EEC). When the PRTC connected to the T-GM has lost its reference (e.g., GNSS signal is lost), the PRTC may continue to deliver time synchronization using this frequency reference.

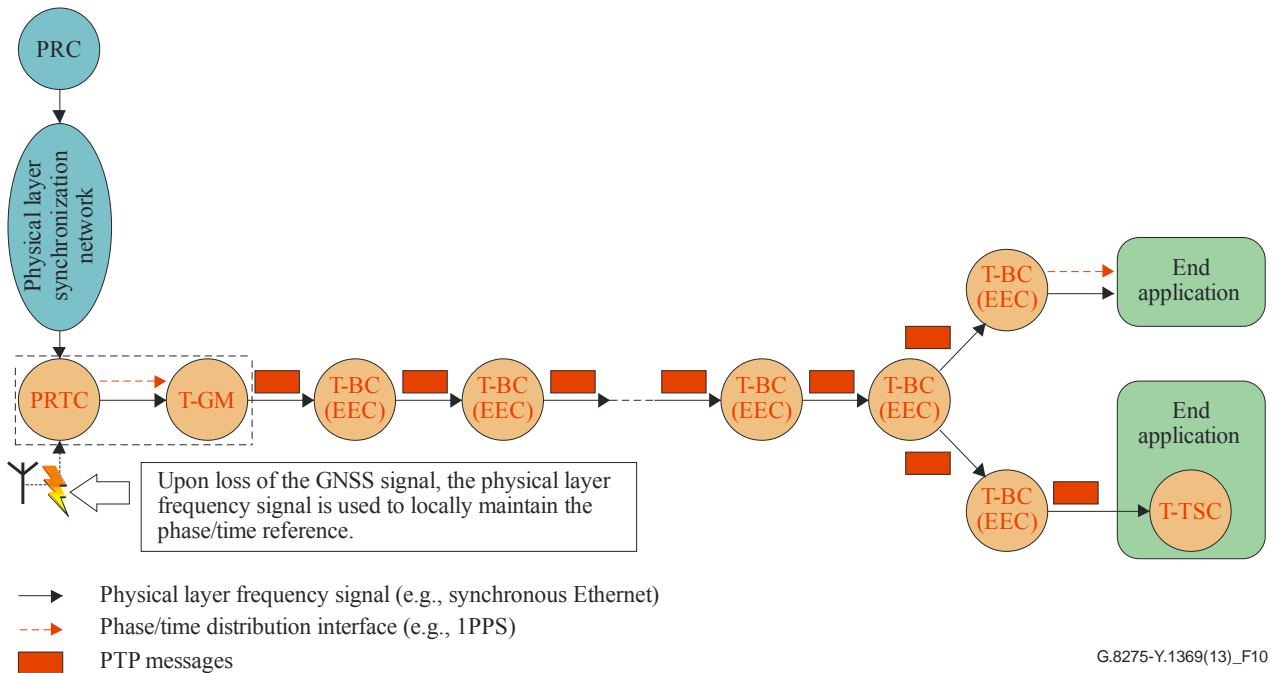

Figure 10 – Illustration of protection scenario 1.2 at the PRTC/GM, (phase/time long-term holdover at the PRTC/GM, with the PRTC/GM not collocated with the end application)

Protection scenario 1.3 is illustrated in Figure 11. In this case, as in protection scenario 1.2, the phase/time long-term holdover function is supported by the PRTC, which is also assumed to have a good oscillator embedded, for instance, in case of problems with the GNSS signals reception. When the PRTC has lost its reference (e.g., GNSS signal is lost), the PRTC may continue to deliver time synchronization either using the internal oscillator or using external frequency synchronization reference (e.g., synchronous Ethernet). However, now the PRTC is collocated with the end application.

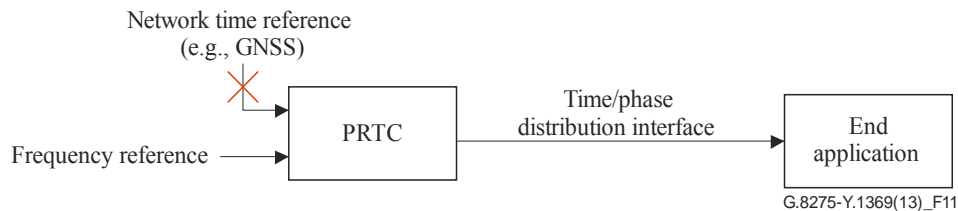

Figure 11 – Illustration of protection scenario 1.3 at the PRTC (phase/time long-term holdover at the PRTC, with the PRTC collocated with the end application)

7.2.2.2 Protection scenario 2

Protection scenario 2 is illustrated in Figure 12. In this protection scenario, a telecom boundary clock (T-BC) in the chain detects a failure in the primary PTP phase/time synchronization path, e.g., it stops receiving PTP time-stamp messages on its slave port or information on the signal indicates a degraded reference. This T-BC informs the downstream PTP clocks (T-BC, T-TSC) that the reference is no longer traceable to a PRTC. This triggers the BMCA and a new PTP path is determined.

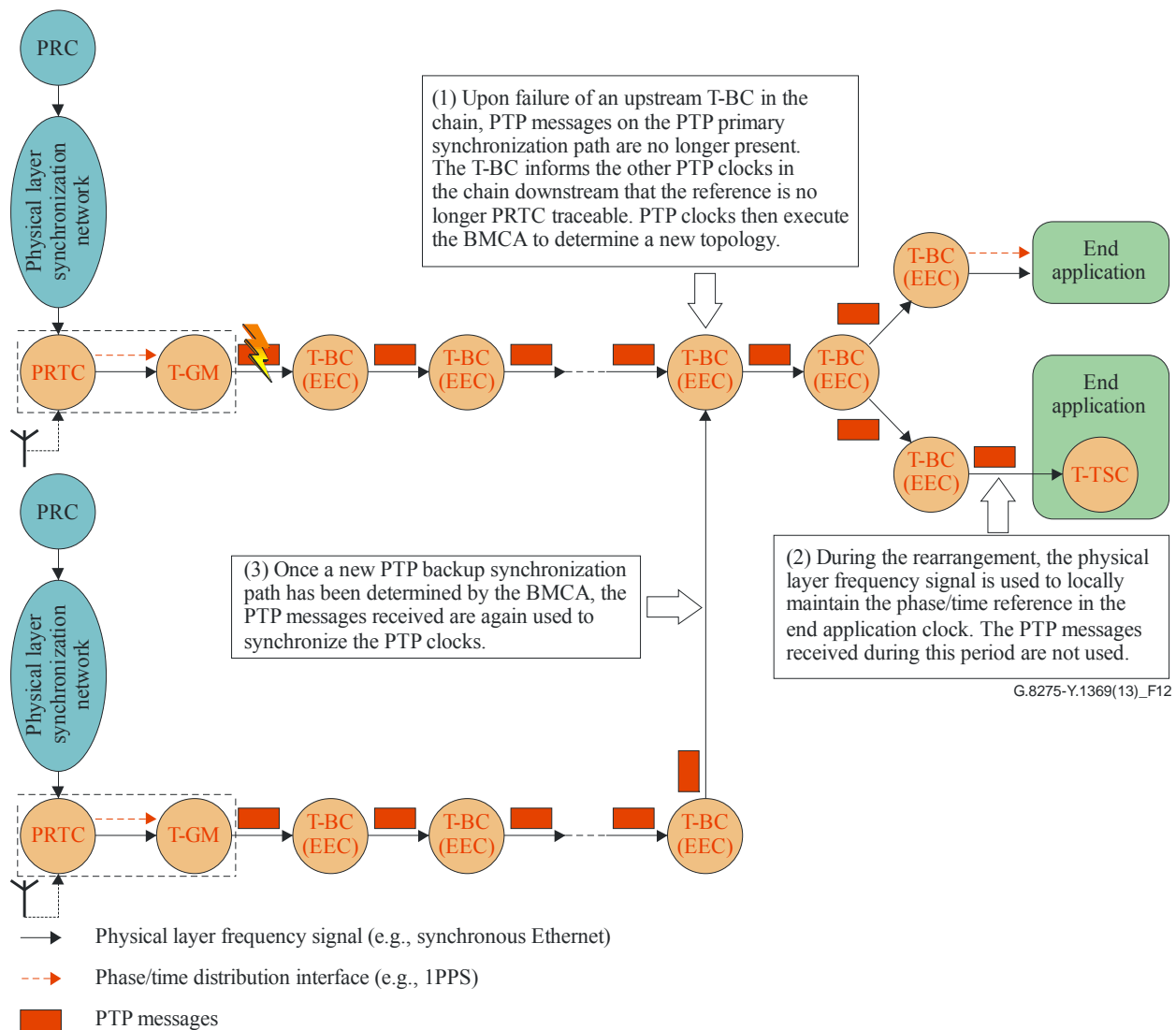

Figure 12 – Illustration of protection scenario 2 (switching to a backup reference with physical layer frequency synchronization support)

Just after the failure has been detected, the end application (e.g., a base station) is therefore informed that the reference signal is no longer traceable to a PRTC and switches to holdover. It may take some time to propagate this information down the chain, depending on the position of the T-BC which has detected the failure. The local clock in the end application is locked to an accurate and stable physical layer frequency reference, such as synchronous Ethernet, since this support is used.

The best master clock algorithm (BMCA) is run in order to determine a new PTP synchronization path.

The phase/time holdover function is assumed to be supported in the T-TSC embedded in the base station. The same function can be used in a base station receiving both a 1PPS input signal and a synchronous Ethernet reference (in this case, the 1PPS signal should be squelched during the failure).

The T-BC must be able to inform about the loss of PRTC traceability.

7.2.2.3 Protection scenario 3

Protection scenario 3 is illustrated in Figure 13. In this protection scenario, a T-BC in the chain detects a failure in the primary PTP phase/time synchronization path, e.g., it stops receiving PTP

time-stamp messages on its slave port or information on the signal indicates a degraded reference. This T-BC informs the other PTP clocks of the chain downstream (T-BC, T-TSC) that the reference is no longer traceable to a PRTC.

It may take some time for the information of the failure to propagate down the chain, depending on the position of the T-BC which detected the failure. Once the T-TSC is informed of the upstream failure, it enters holdover.

The holdover in the end application is based on a local clock of good quality not locked to an external reference, since the physical layer frequency synchronization support is not available. During the holdover period, any timing signals delivered to the end application by PTP are not used.

The best master clock algorithm (BMCA) is run in order to determine a new PTP synchronization path.

The holdover function is assumed to be supported in the T-TSC embedded in the base station. The same function can be used in a base station receiving a 1PPS input signal (in this case, the 1PPS signal should be squelched during the failure).

The T-BC must be able to inform about the loss of PRTC traceability.

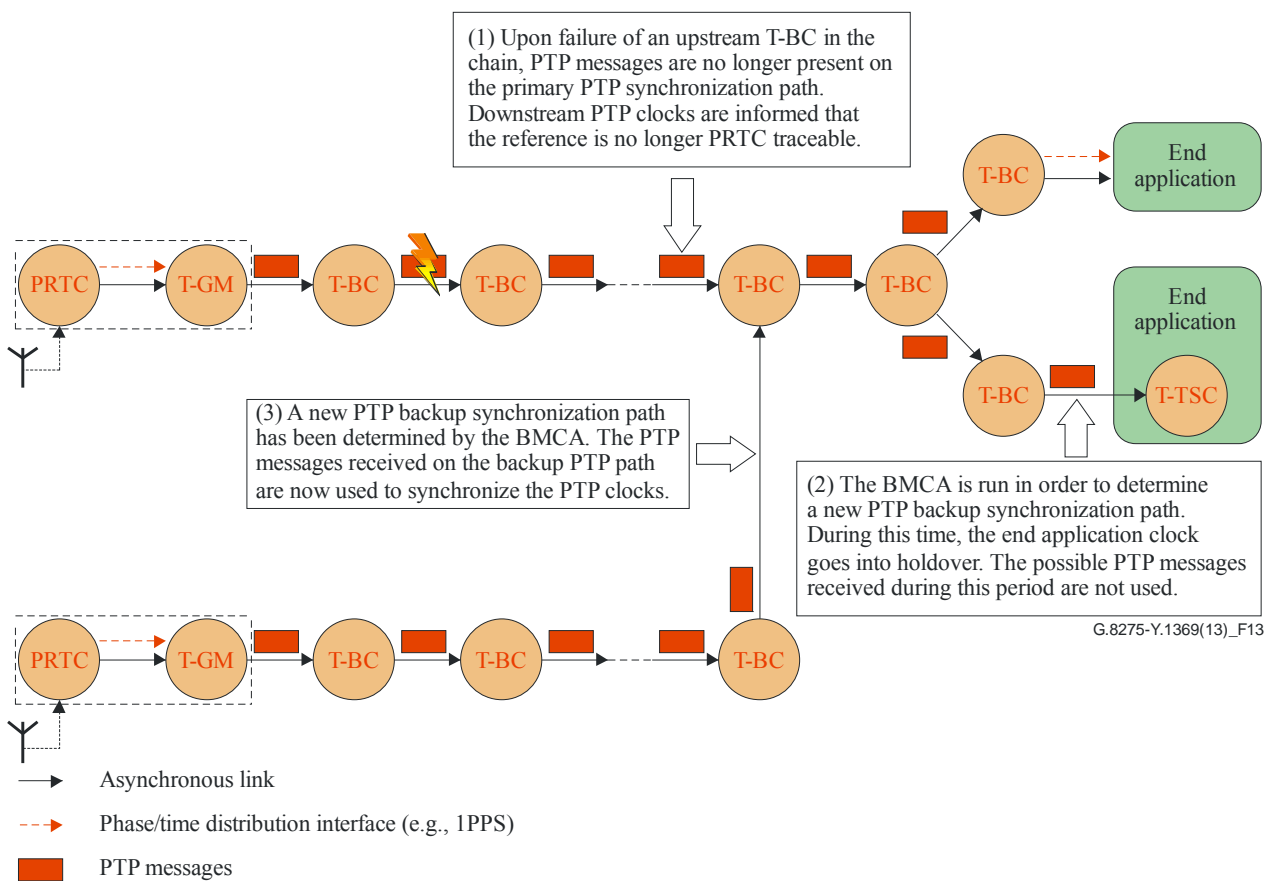

Figure 13 – Illustration of protection scenario 3 (switching to a backup reference without physical layer frequency synchronization)

7.3 Packet network partitioning

Operation over multiple domains may need to be considered, especially in the case of the mobile backhaul. This is for further study.

8 Security aspects

Unlike traditional timing streams where frequency is carried over the physical layer, packet-based timing streams may be observed at different points in the network. There may be cases where timing packets flow across multiple network domains which may introduce specific security requirements. There may also be aspects of security that may be related to both the network (e.g., authentication and/or authorization) and to the PTP protocol itself.

It is important to permit the operation with existing standards-based security techniques to help ensure the integrity of the synchronization. Examples may include encryption and/or authentication techniques, or network techniques for separating traffic, such as VLANs or LSPs.

It may not be possible to implement some of these requirements without actually degrading the overall level of timing or system performance.

Certain aspects of security are for further study; however some critical aspects are:

- Slaves should be prevented from connecting to rogue masters (this could be either by an authentication process or by using network separation to prevent rogue masters from accessing slaves).
- A BC port that is connected to a "customer" must never enter a slave state.
- Masters should be prevented from providing services to unauthorised slaves.

9 Management aspects

Network management aspects are for further study.

Annex A

Time/phase models based on ITU-T G.805

(This annex forms an integral part of this Recommendation.)

[ITU-T G.8264] provided descriptions of timing flows related to packet network synchronization. Specifically, timing flows were shown that cover the case of circuit emulation and physical layer frequency synchronization based on synchronous Ethernet.

This annex shows the timing flows appropriate to packet-based time mechanisms.

Network models help to ensure that interoperable systems can be developed. What follows is a discussion of [ITU-T G.805] as a modelling technique, as this is what was used in the initial development of [ITU-T G.8264]. [ITU-T G.805] has been used for many years to describe the behaviour of TDM systems. Since the development of [ITU-T G.8264], further work has been undertaken within ITU-T to extend the models to cover packet networks. However, for the purposes here, it is sufficient to refer to the ITU-T G.805 models.

[ITU-T G.805] provides the modelling "language" to describe transport networks and it describes at the high level, the functional blocks that form a transport network. These define the overall "architecture" in a manner that is implementation independent. A key aspect of the architecture is the concept of network layers. Typically, networks are managed on a per-layer basis, and interactions between the layers follow client/server relationships. For telecom applications, OAM is defined on a per-layer basis.

For a modelling construct such as [ITU-T G.805], a key aspect of the model is that there are well-defined interactions between functions. Common constructs in ITU-T G.805 models include trails (which support the end-to-end transfer of information and the various adaptation, termination and connection functions). Note that the newer ITU-T models to define packet networks describe "flows". The work in [ITU-T G.8264] had anticipated this and thus it described timing flows.

The major benefit of architectural modelling is that if properly specified and followed, functional interactions are fully understood from the network level and therefore a complete specification of equipment consistent with the capabilities of the network is possible. Additionally, this results in a network that has a high level of interoperability and is fully manageable.

The model to support time/phase

Extension of the ITU-T G.8264 models to cover time/phase becomes conceptually straightforward and is shown in Figure A.1. Here the output of the adaptation function is time/phase. The format of time/phase is not considered at this point. The important aspects are that the input to the source adaptation function must have additional information (time/phase), rather than simply a frequency reference. The information that is carried across the network remains, from the network perspective, the same as in the frequency only case. The network carries PTP packets. The adaptation functions would be responsible for producing the appropriate outputs. Note that this only shows the timing path and traverses multiple packet network elements. Note that this is illustrative of the model only.

Also note that in the case where frequency output is also required, this could be via the adaptation function. For simplicity, this is not shown in the figure, but it could be described (i.e., and additional frequency output could be provided).

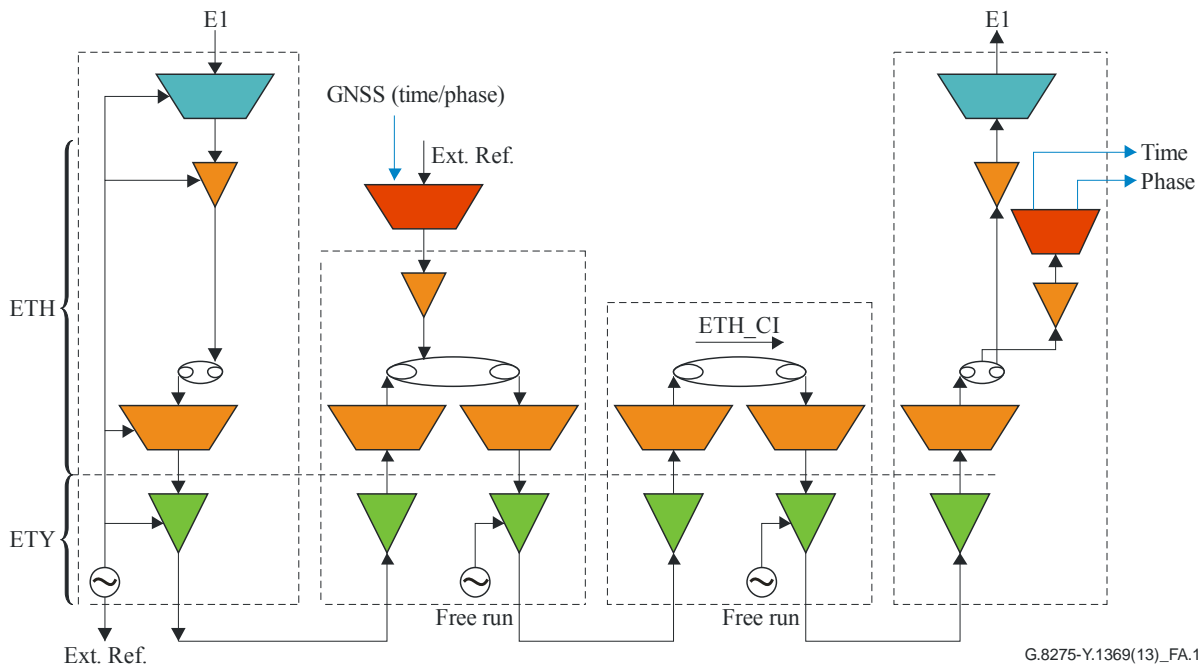

Figure A.1 – Extension of basic ITU-T G.8264 model to support time/phase

Packet time/phase with frequency support by the network

Figure A.2 shows how time/phase can be assisted with frequency. In this specific example, the frequency reference is provided via synchronous Ethernet. A similar model could be developed where the input is via an external interface. Note that this model begins to illustrate the independence of time/phase with frequency.

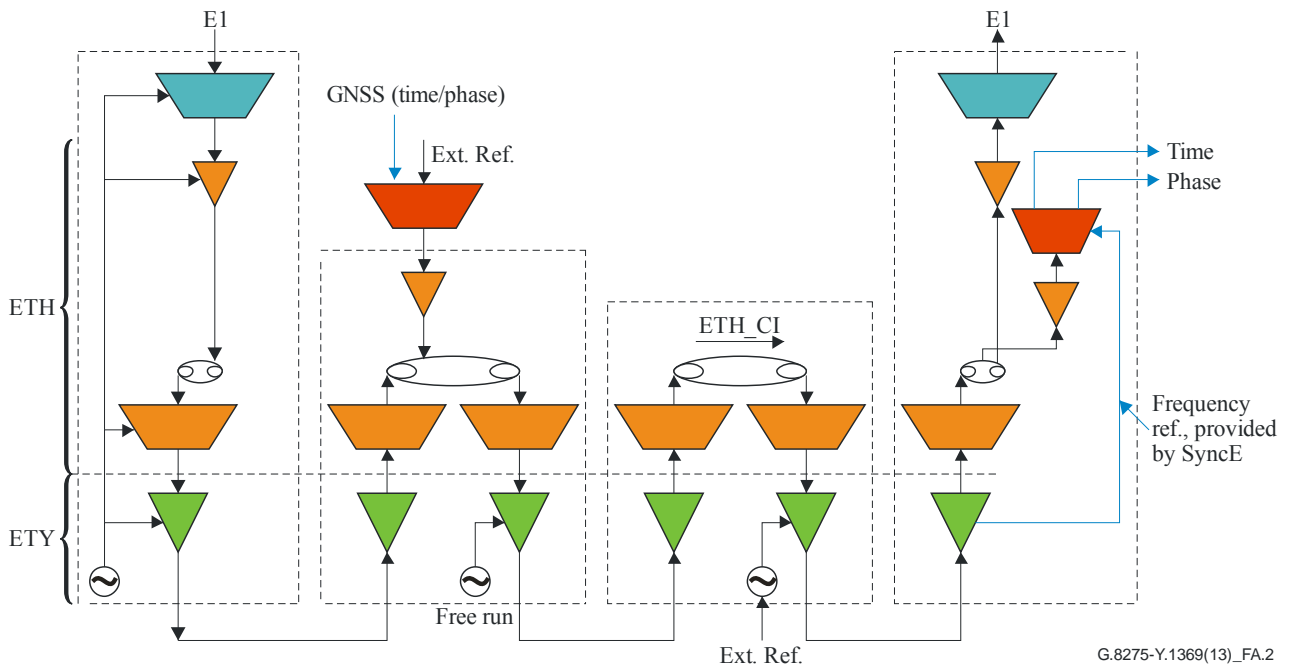

Figure A.2 – Time/phase with frequency support provided by the network (e.g., synchronous Ethernet)

Appendix I

Architecture for time and phase distribution over a packet network providing partial timing support at the protocol level

(This appendix does not form an integral part of this Recommendation.)

This appendix describes an alternative to the architecture for time and phase distribution using full timing support described in this Recommendation, where not every network element is required to provide timing support. It will operate over a unicast IP network, in a similar manner to the existing frequency distribution architecture, but adapted to carry time and phase, as well as frequency. The architecture and its associated PTP profile are still under development and the accuracy and stability of time and phase distribution using this architecture is not yet known.

This future architecture is expected to address use cases where the operator wants to distribute accurate time and phase over an existing network and cannot upgrade the network to provide timing support in every network node. Additionally, a portion of the network may be provided by a third party and outside the administrative scope of the primary operator. The performance aspects and impacts of these use cases are still under study.

This appendix presents the initial concepts.

I.1 Architecture for partial timing support

The following four architectural aspects are covered in this appendix:

- General packet-based timing distribution architecture
- Timing protection aspects and functions
- Partitioning across multiple administrative domains
- Use of multiple underlying technologies

I.1.1 Timing distribution architecture

[ITU-T G.8265] describes an architecture for frequency distribution using packet timing protocols. In this architecture a frequency reference is connected to a packet master clock and distributed to the packet slave clocks using packet timing signals. The packet network itself is "timing unaware", i.e., it does not contain any elements that provide assistance or correction to the packet timing signals.

The same method can be considered and adapted to distribute time and phase to the packet slave clocks. This requires changing the frequency reference to a time reference derived from a PRTC (primary reference time clock (PRTC), normally a GNSS receiver referencing time back to UTC). It also requires the timing protocol to operate in two-way mode, i.e., to send event messages in both directions. If the PTP protocol is used, this means using both *sync* and *delay_request* messages.

The applications requiring accurate time and phase distribution described in [ITU-T G.8271] place a much more stringent requirement on the network and packet slave clock performance than for frequency distribution. The objective is to address some of the classes described in [ITU-T G.8271]. To achieve this, it may be required to reduce the number and type of network elements that can be traversed compared to [ITU-T G.8265.1]/[b-ITU-T G.8261.1] while still meeting the performance requirements.

There are two main ways to accommodate this reduction:

- Use boundary clocks to break the network up into smaller segments (boundary clocks recover and filter the timing from the original packet timing signal and generate a new packet timing signal to forward the timing downstream).

- Move the PRTC and packet master clock closer to the packet slave clock (i.e., a more distributed architecture).

These approaches are shown in Figure I.1:

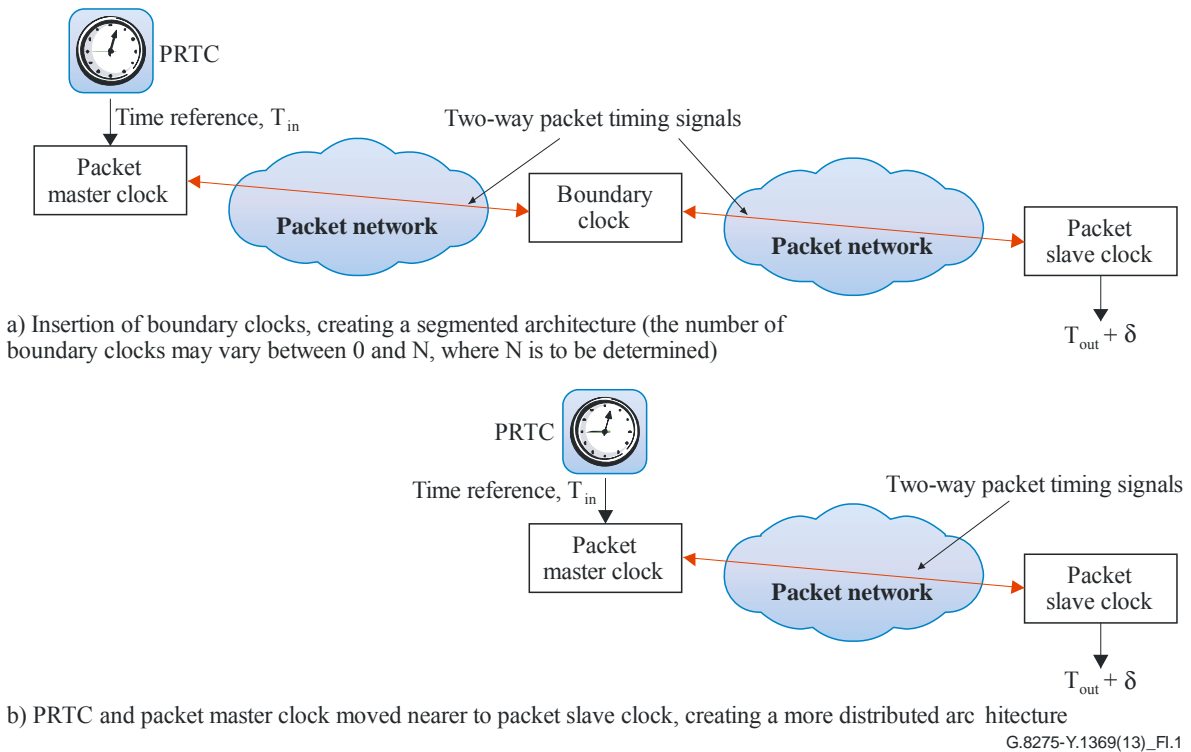

Figure I.1 – Modified architecture to support time and phase distribution

In both cases, the stability and performance of the boundary clocks and packet slave clocks may be enhanced by provision of a stable physical layer frequency reference, such as synchronous Ethernet, if available, as shown in Figure I.2:

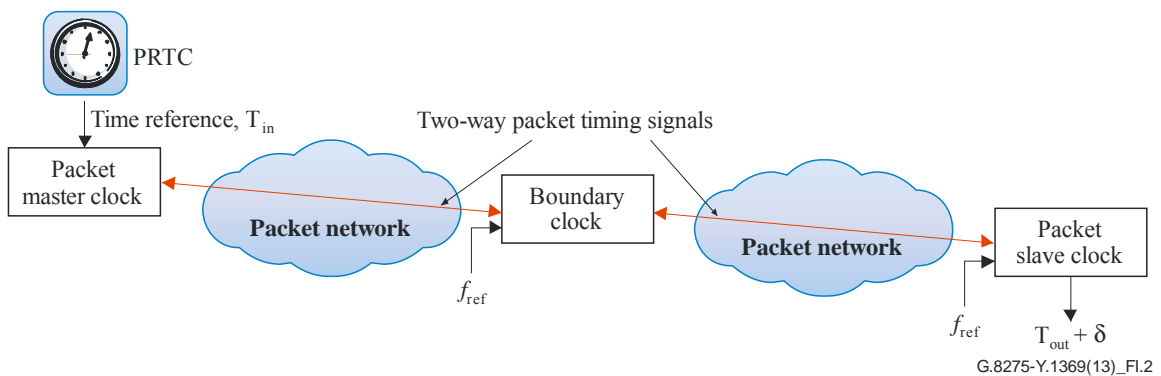

Figure I.2 – Use of physical layer frequency reference (if available)

It should be noted that the specification of the boundary clock in Figure I.2 is not identical to the boundary clock for full timing support. Similarly, the specification of the packet slave clock in Figure I.2 is not the same as the packet slave clock for full timing support or the packet slave clock for frequency described in [b-ITU-T G.8263].

Performance specifications for the clocks described in this appendix are for further study.

I.1.2 Timing protection aspects

One method of providing protection in case of network failure is to provide access to an alternative packet master clock or boundary clock. The details of the master selection mechanism are under study.

A second method of protection is based on the use of a frequency reference (if available) to maintain the time base of the various clocks. For example, [ITU-T G.8272] describes the use of a frequency reference (such as synchronous Ethernet) to maintain the PRTC output during periods when the GNSS signal is unavailable.

This method can be applied to both the boundary clock and the packet slave clock. A physical layer frequency reference, if available, can be used to maintain the time output of the boundary clock and/or packet slave clock during periods when the packet timing signal is either unavailable or unusable. This is shown in Figure I.3:

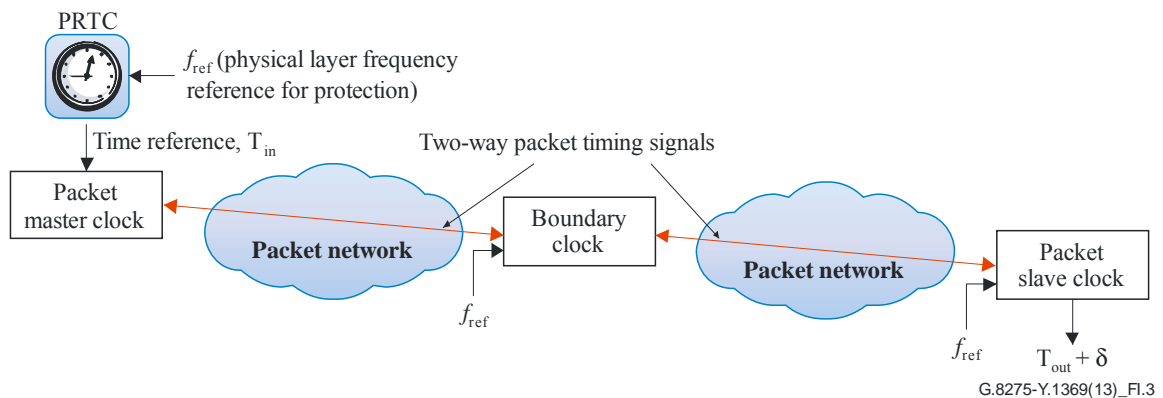

Figure I.3 – Protection using physical layer frequency references

I.1.3 Partitioning across multiple administrative domains

In some cases, operators purchase services from other operators in order to provide access to remote equipment or networks. The use of the partial timing support architecture permits the distribution of time and phase across such alternative access vendors, even where such vendors may not provide timing support, although the performance of such timing distribution schemes may be undefined.

For example, Figure I.4 shows an example of such an alternative access provision. In this example, a boundary clock is used to ensure a clean hand-off point to the second network operator.

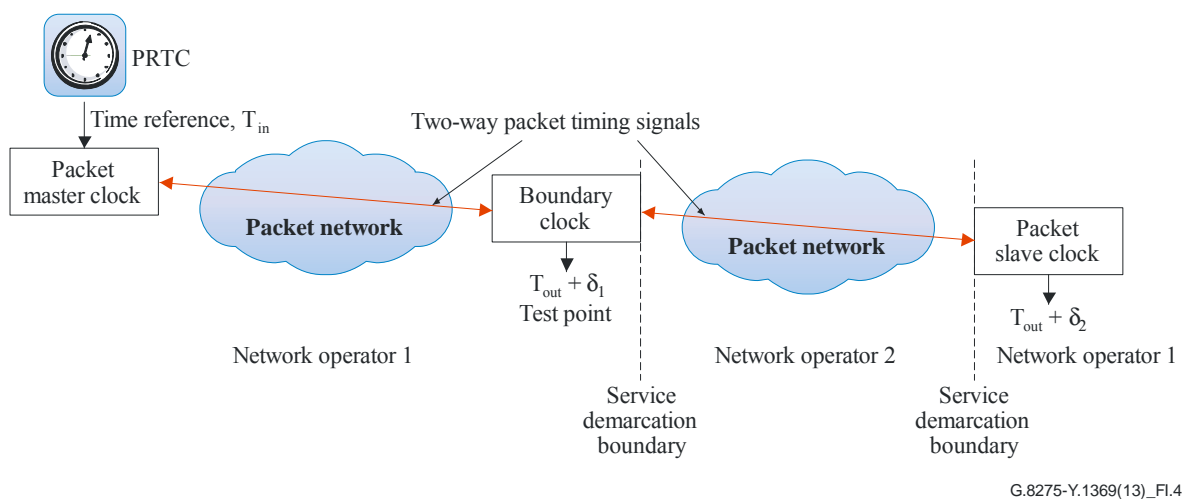

Figure I.4 – Timing transmission over a second operator's network

Passing accurate phase/time between administrative domains is for further study. Issues surrounding the demarcation of the packet timing flow and the transferred performance between operators may exist. It may be difficult to determine the location of performance problems especially if the packet timing is passing through multiple administrative domains.

When multiple administrative domains are involved, other methods may be required to deliver accurate phase/time reference to the mobile network operator. For instance, a carrier operator may provide a phase/time reference as a service. The details of these other methods are for further study.

I.1.4 Use of multiple underlying technologies

Packet networks are built on a number of different underlying technologies. Some technologies not only create packet delay variation (PDV), but also introduce significant asymmetry or difference in delay between the forward and reverse paths. If uncorrected, this asymmetry will cause an error in the packet slave clock's estimate of the correct time or phase.

Where such technologies are used, it will be necessary to verify that they are suitable for accurate time and phase transfer, or that appropriate timing support has been built into the equipment. Details of the PDV and asymmetry contributions of individual transport technologies and their suitability for accurate time and phase distribution are for further study.

Bibliography

- [b-ITU-T G.8261.1] Recommendation ITU-T G.8261.1/Y.1361.1 (2012), *Packet delay variation network limits applicable to packet-based methods (Frequency synchronization)*.
- [b-ITU-T G.8263] Recommendation ITU-T G.8263/Y.1363 (2012), *Timing characteristics of packet-based equipment clocks*.

ITU-T Y-SERIES RECOMMENDATIONS
**GLOBAL INFORMATION INFRASTRUCTURE, INTERNET PROTOCOL ASPECTS AND NEXT-
GENERATION NETWORKS**

GLOBAL INFORMATION INFRASTRUCTURE	
General	Y.100–Y.199
Services, applications and middleware	Y.200–Y.299
Network aspects	Y.300–Y.399
Interfaces and protocols	Y.400–Y.499
Numbering, addressing and naming	Y.500–Y.599
Operation, administration and maintenance	Y.600–Y.699
Security	Y.700–Y.799
Performances	Y.800–Y.899
INTERNET PROTOCOL ASPECTS	
General	Y.1000–Y.1099
Services and applications	Y.1100–Y.1199
Architecture, access, network capabilities and resource management	Y.1200–Y.1299
 Transport	Y.1300–Y.1399
Interworking	Y.1400–Y.1499
Quality of service and network performance	Y.1500–Y.1599
Signalling	Y.1600–Y.1699
Operation, administration and maintenance	Y.1700–Y.1799
Charging	Y.1800–Y.1899
IPTV over NGN	Y.1900–Y.1999
NEXT GENERATION NETWORKS	
Frameworks and functional architecture models	Y.2000–Y.2099
Quality of Service and performance	Y.2100–Y.2199
Service aspects: Service capabilities and service architecture	Y.2200–Y.2249
Service aspects: Interoperability of services and networks in NGN	Y.2250–Y.2299
Enhancements to NGN	Y.2300–Y.2399
Network management	Y.2400–Y.2499
Network control architectures and protocols	Y.2500–Y.2599
Packet-based Networks	Y.2600–Y.2699
Security	Y.2700–Y.2799
Generalized mobility	Y.2800–Y.2899
Carrier grade open environment	Y.2900–Y.2999
FUTURE NETWORKS	Y.3000–Y.3499
CLOUD COMPUTING	Y.3500–Y.3999

For further details, please refer to the list of ITU-T Recommendations.

SERIES OF ITU-T RECOMMENDATIONS

Series A	Organization of the work of ITU-T
Series D	General tariff principles
Series E	Overall network operation, telephone service, service operation and human factors
Series F	Non-telephone telecommunication services
Series G	Transmission systems and media, digital systems and networks
Series H	Audiovisual and multimedia systems
Series I	Integrated services digital network
Series J	Cable networks and transmission of television, sound programme and other multimedia signals
Series K	Protection against interference
Series L	Construction, installation and protection of cables and other elements of outside plant
Series M	Telecommunication management, including TMN and network maintenance
Series N	Maintenance: international sound programme and television transmission circuits
Series O	Specifications of measuring equipment
Series P	Terminals and subjective and objective assessment methods
Series Q	Switching and signalling
Series R	Telegraph transmission
Series S	Telegraph services terminal equipment
Series T	Terminals for telematic services
Series U	Telegraph switching
Series V	Data communication over the telephone network
Series X	Data networks, open system communications and security
Series Y	Global information infrastructure, Internet protocol aspects and next-generation networks
Series Z	Languages and general software aspects for telecommunication systems