

International Telecommunication Union

ITU-T

TELECOMMUNICATION
STANDARDIZATION SECTOR
OF ITU

G.8201

(04/2011)

SERIES G: TRANSMISSION SYSTEMS AND MEDIA,
DIGITAL SYSTEMS AND NETWORKS

Packet over Transport aspects – Quality and availability
targets

**Error performance parameters and objectives
for multi-operator international paths within
optical transport networks**

Recommendation ITU-T G.8201



ITU-T G-SERIES RECOMMENDATIONS

TRANSMISSION SYSTEMS AND MEDIA, DIGITAL SYSTEMS AND NETWORKS

INTERNATIONAL TELEPHONE CONNECTIONS AND CIRCUITS	G.100–G.199
GENERAL CHARACTERISTICS COMMON TO ALL ANALOGUE CARRIER-TRANSMISSION SYSTEMS	G.200–G.299
INDIVIDUAL CHARACTERISTICS OF INTERNATIONAL CARRIER TELEPHONE SYSTEMS ON METALLIC LINES	G.300–G.399
GENERAL CHARACTERISTICS OF INTERNATIONAL CARRIER TELEPHONE SYSTEMS ON RADIO-RELAY OR SATELLITE LINKS AND INTERCONNECTION WITH METALLIC LINES	G.400–G.449
COORDINATION OF RADIOTELEPHONY AND LINE TELEPHONY	G.450–G.499
TRANSMISSION MEDIA AND OPTICAL SYSTEMS CHARACTERISTICS	G.600–G.699
DIGITAL TERMINAL EQUIPMENTS	G.700–G.799
DIGITAL NETWORKS	G.800–G.899
DIGITAL SECTIONS AND DIGITAL LINE SYSTEM	G.900–G.999
MULTIMEDIA QUALITY OF SERVICE AND PERFORMANCE – GENERIC AND USER-RELATED ASPECTS	G.1000–G.1999
TRANSMISSION MEDIA CHARACTERISTICS	G.6000–G.6999
DATA OVER TRANSPORT – GENERIC ASPECTS	G.7000–G.7999
PACKET OVER TRANSPORT ASPECTS	G.8000–G.8999
Ethernet over Transport aspects	G.8000–G.8099
MPLS over Transport aspects	G.8100–G.8199
Quality and availability targets	G.8200–G.8299
Service Management	G.8600–G.8699
ACCESS NETWORKS	G.9000–G.9999

For further details, please refer to the list of ITU-T Recommendations.

Recommendation ITU-T G.8201

Error performance parameters and objectives for multi-operator international paths within optical transport networks

Summary

Recommendation ITU-T G.8201 defines error performance parameters and objectives for international ODUk paths transported by the optical transport network (OTN), as described in Recommendation ITU-T G.709/Y.1331. While this Recommendation specifically addresses objectives for international ODUk paths, the allocation principles can be applied to the design of error performance for national or private ODUk paths. This Recommendation is based upon a block-based measurement concept using error detection code (EDC) and EDC usage inherent to the path under test; the block repetition rate being in accordance with OTN technology in accordance with Recommendation ITU-T G.709/Y.1331. This simplifies in-service measurements. The events, parameters and objectives are defined accordingly. In addition to path performance assessment, tandem connection monitoring is covered.

History

Edition	Recommendation	Approval	Study Group
1.0	ITU-T G.8201	2003-09-13	13
2.0	ITU-T G.8201	2011-04-13	15

Keywords

Background block error (BBE), block-based concept, error detection code (EDC), EDC usage, error performance objectives, error performance parameters, hypothetical reference optical path (HROP), in-service monitoring (ISM), optical channel data unit-k (ODUk) path, severely errored second (SES), tandem connection monitoring (TCM).

FOREWORD

The International Telecommunication Union (ITU) is the United Nations specialized agency in the field of telecommunications, information and communication technologies (ICTs). The ITU Telecommunication Standardization Sector (ITU-T) is a permanent organ of ITU. ITU-T is responsible for studying technical, operating and tariff questions and issuing Recommendations on them with a view to standardizing telecommunications on a worldwide basis.

The World Telecommunication Standardization Assembly (WTSA), which meets every four years, establishes the topics for study by the ITU-T study groups which, in turn, produce Recommendations on these topics.

The approval of ITU-T Recommendations is covered by the procedure laid down in WTSA Resolution 1.

In some areas of information technology which fall within ITU-T's purview, the necessary standards are prepared on a collaborative basis with ISO and IEC.

NOTE

In this Recommendation, the expression "Administration" is used for conciseness to indicate both a telecommunication administration and a recognized operating agency.

Compliance with this Recommendation is voluntary. However, the Recommendation may contain certain mandatory provisions (to ensure, e.g., interoperability or applicability) and compliance with the Recommendation is achieved when all of these mandatory provisions are met. The words "shall" or some other obligatory language such as "must" and the negative equivalents are used to express requirements. The use of such words does not suggest that compliance with the Recommendation is required of any party.

INTELLECTUAL PROPERTY RIGHTS

ITU draws attention to the possibility that the practice or implementation of this Recommendation may involve the use of a claimed Intellectual Property Right. ITU takes no position concerning the evidence, validity or applicability of claimed Intellectual Property Rights, whether asserted by ITU members or others outside of the Recommendation development process.

As of the date of approval of this Recommendation, ITU had not received notice of intellectual property, protected by patents, which may be required to implement this Recommendation. However, implementers are cautioned that this may not represent the latest information and are therefore strongly urged to consult the TSB patent database at <http://www.itu.int/ITU-T/ipr/>.

© ITU 2012

All rights reserved. No part of this publication may be reproduced, by any means whatsoever, without the prior written permission of ITU.

Table of Contents

	Page
1 Scope	1
1.1 Application of this Recommendation	1
1.2 Transport network layers	1
1.3 Allocation of end-to-end performance	2
2 References.....	2
3 Terms and Definitions	3
4 Abbreviations.....	4
5 Measurement of the block	5
5.1 In-service monitoring	5
5.2 Out-of-service measurements	5
6 Performance monitoring at the near end and far end of a path.....	6
7 Relationship between path performance monitoring and the block-based parameters.....	6
7.1 General	6
7.2 Estimation of the performance parameters.....	7
7.3 Estimation of performance events at the far end of a path	7
8 Error performance objectives	7
8.1 End-to-end objectives.....	7
8.2 Hypothetical reference optical path.....	8
8.3 Allocation of end-to-end performance objectives	9
Annex A – Criteria for entry to and exit from the unavailable state.....	10
A.1 Criteria for a single direction.....	10
A.2 Criterion for a bidirectional path	10
A.3 Criterion for a unidirectional path	10
A.4 Consequences on error performance measurements	11
Appendix I – Flow chart illustrating the recognition of anomalies, defects, errored blocks, and SES.....	12
Appendix II – Example of OTN layer network trails	14
Bibliography.....	15

Recommendation ITU-T G.8201

Error performance parameters and objectives for multi-operator international paths within optical transport networks

1 Scope

This Recommendation specifies error performance events, parameters and objectives for ODUk paths¹ of the optical transport network (OTN), as specified in [ITU-T G.709]. Clauses 1.1 to 1.3 give further details.

1.1 Application of this Recommendation

This Recommendation is applicable to international paths of the optical transport network as described in [ITU-T G.709]. These paths are at the ODUk layer of the OTN, and are digital paths (see [ITU-T G.709] for a description of the ODUk layer). While this Recommendation specifically addresses objectives for international ODUk paths, the allocation principles can be applied to the design of error performance for national or private paths.

The quality of client services, as well as the performance of the network elements belonging to the service layer, is outside of the scope of this Recommendation. However, ITU-T G.8201-based paths can carry various clients (e.g., SDH, ATM, GFP (i.e., IP, Ethernet, etc., encapsulated in GFP), etc.; see [ITU-T G.709]). ODUk paths meeting the objectives of this Recommendation will enable client layer traffic to meet its respective performance objectives.

The error performance objectives are applicable to each direction of the ODUk path independently. The values apply end-to-end over a 27 500 km hypothetical reference path (see Figure 3). The performance of multiplex and cross-connect functions of client layers of the OTN (i.e., higher layers, above the OPUk, e.g., SDH, ATM, etc.; see [ITU-T G.709] for a description of the OPUk) are not included in these values.

The parameter definitions are block-based with the block repetition rate in accordance with OTN technology, making in-service measurement convenient. In addition to in-service measurements, compliance with this Recommendation can be assessed using out-of-service measurements or estimated by measures compatible with this Recommendation as those specified in clause 7.

The objectives given in this Recommendation are long-term objectives to be met over an evaluation period of typically 30 consecutive days (one month). Shorter measurement periods required for maintenance and bringing-into-service are covered in [b-ITU-T M.2401].

1.2 Transport network layers

This Recommendation specifies the error performance of ODUk paths in a given transport network layer. In the context of this Recommendation, an ODUk digital path is a trail carrying an OPUk payload and associated OPUk and ODUk overhead through the layered transport network between the path terminating equipment (see Figure 1).

¹ In this Recommendation, unless otherwise specified, the term *path* means *ODUk path* ($k = 1, 2, \text{ or } 3$). The nominal ODUk rates are approximately 2.5 Gbit/s for ODU1, 10 Gbit/s for ODU2, and 40 Gbit/s for ODU3.

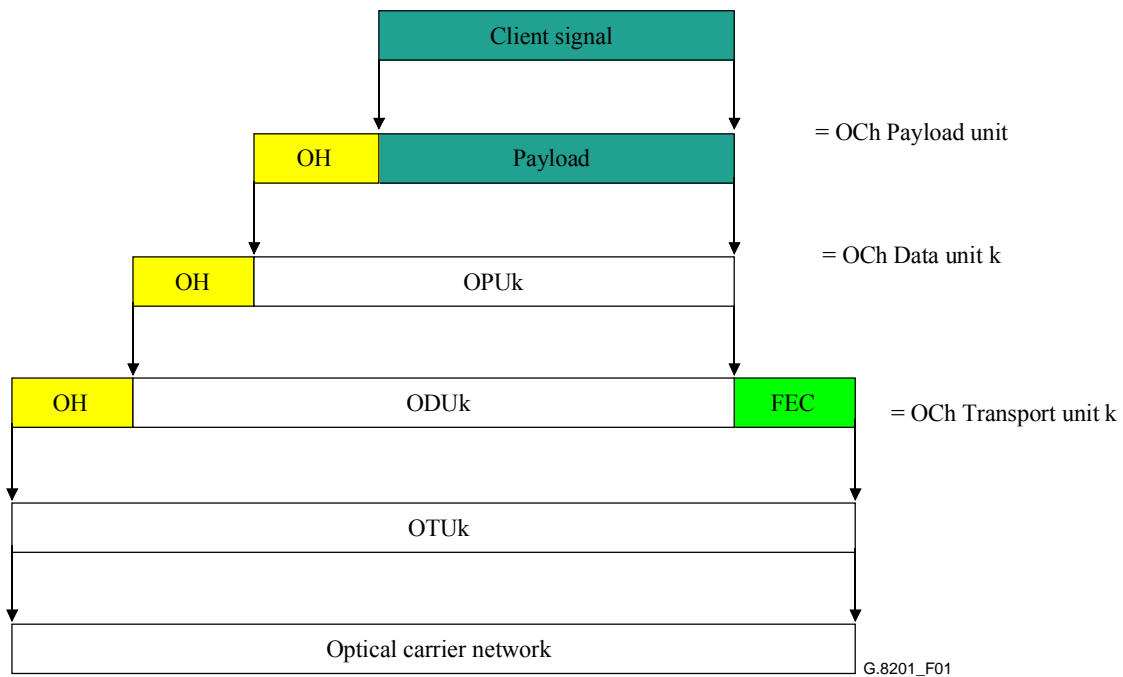
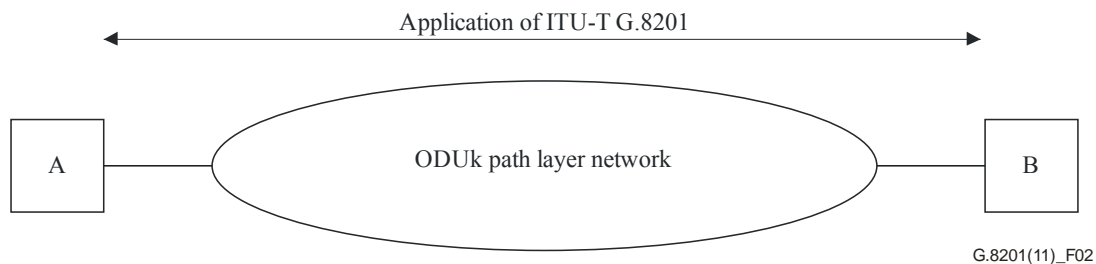

Figure 1 – OTN signal structure

The scope of application of this Recommendation is from path-end-point to path-end-point as illustrated in Figure 2.



NOTE – A and B are path end points located at the path terminations as defined in [ITU-T G.798].

Figure 2 – Application of ITU-T G.8201 for an end-to-end ODUk path

1.3 Allocation of end-to-end performance

Allocations of end-to-end performance of ODUk paths are derived using the rules laid out in clause 8.3, which are length and complexity based. Detailed allocations of ITU-T G.8201 performance to the individual components (sections, multiplexers and cross-connects, etc.) are outside the scope of this Recommendation but, when such allocations are performed, the requirements of clause 8.3 should be met.

2 References

The following ITU-T Recommendations and other references contain provisions which, through reference in this text, constitute provisions of this Recommendation. At the time of publication, the editions indicated were valid. All Recommendations and other references are subject to revision; users of this Recommendation are therefore encouraged to investigate the possibility of applying the most recent edition of the Recommendations and other references listed below. A list of the currently valid ITU-T Recommendations is regularly published. The reference to a document within this Recommendation does not give it, as a stand-alone document, the status of a Recommendation.

- [ITU-T G.709] Recommendation ITU-T G.709/Y.1331 (2009), *Interfaces for the Optical Transport Network (OTN)*.
- [ITU-T G.798] Recommendation ITU-T G.798 (2010), *Characteristics of optical transport network hierarchy equipment functional blocks*.
- [ITU-T G.826] Recommendation ITU-T G.826 (2002), *End-to-end error performance parameters and objectives for international, constant bit-rate digital paths and connections*.
- [ITU-T G.827] Recommendation ITU-T G.827 (2003), *Availability performance parameters and objectives for end-to-end international constant bit-rate digital paths*.
- [ITU-T G.828] Recommendation ITU-T G.828 (2000), *Error performance parameters and objectives for international, constant bit-rate synchronous digital paths*.
- [ITU-T G.872] Recommendation ITU-T G.872 (2010), *Architecture of optical transport networks*.
- [ITU-T G.874] Recommendation ITU-T G.874 (2001), *Management aspects of optical transport network elements*.
- [ITU-T I.356] Recommendation ITU-T I.356 (2000), *B-ISDN ATM layer cell transfer performance*.

3 Terms and Definitions

This Recommendation defines the following terms:

3.1 error performance events: In the following definitions, this Recommendation neither assumes nor requires that forward error correction (FEC) is used (see [ITU-T G.709]). However, if FEC is used, all the performance parameters and events are defined after FEC (i.e., post-FEC). In other words, the detection of the performance events (e.g., BBE, SES) is after any error correction.

3.1.1 errored block (EB): A block in which one or more bits are in error.

3.1.2 severely errored second (SES): A one-second period which contains $\geq 15\%$ errored blocks or at least one defect (see Notes 1 and 2).

NOTE 1 – The defects and related performance criteria are listed in clause 7.

NOTE 2 – To simplify measurement processes, the defect is used in the definition of SES instead of defining SES directly in terms of severe errors affecting the path. While this approach simplifies the measurement of SES, it should be noted that there may exist error patterns of severe intensity that would not trigger a defect as defined in clause 7. Thus, these would not be considered as an SES under this definition. If, in the future, such severe user-affecting events are found, this definition will have to be studied again.

3.1.3 background block error (BBE): An errored block not occurring as part of an SES.

3.2 error performance parameters: Error performance should only be evaluated whilst the path is in the available state. For a definition of the entry/exit criteria for the unavailable state, see [ITU-T G.827] and Annex A.

In the following definitions, this Recommendation neither assumes nor requires that forward error correction (FEC) is used (see [ITU-T G.709]). However, if FEC is used, all the performance parameters and events are defined after FEC (i.e., post-FEC). In other words, the detection of the performance events (e.g., BBE, SES) is after any error correction.

3.2.1 severely errored second ratio (SESR): The ratio of SES in available time to total seconds in available time during a fixed measurement interval.

3.2.2 background block error ratio (BBER): The ratio of BBE in available time to total blocks in available time during a fixed measurement interval. The count of total blocks excludes all blocks during SESs.

3.3 generic definition of the block: This Recommendation is based upon the error performance measurement of blocks consistent with an OTN hierarchy frame. This clause offers a generic definition of the term "block" as follows:

A block is a set of consecutive bits associated with the path; each bit belongs to one, and only one, block. Consecutive bits may not be contiguous in time.

3.4 hypothetical reference optical path (HROP): A hypothetical reference optical path is defined as the whole means of digital transmission of an ODUk digital signal (which is a digital signal of a specified rate given in [ITU-T G.709]), including the path overhead, between equipment at which the signal originates and terminates. An end-to-end hypothetical reference path spans a distance of 27'500 km.

3.5 ODUk path: An ODUk path is a trail carrying an OPUk payload and associated OPUk and ODUk overhead through the layered optical transport network between the ODUk path terminating equipment. An ODUk path may be bidirectional or unidirectional and may comprise both customer-owned portions and network operator-owned portions.

4 Abbreviations

This Recommendation uses the following abbreviations:

AIS	Alarm Indication Signal
ATM	Asynchronous Transfer Mode
BBE	Background Block Error
BBER	Background Block Error Ratio
BDI	Backward Defect Indication
BEI	Backward Error Indication
BIP	Bit Interleaved Parity
BIS	Bringing into Service
BOD	Backbone Operator Domain
CBR	Constant Bit Rate
CSES	Consecutive Severely Errored seconds
EB	Errored Block
EDC	Error Detection Code
ES	Errored Second
FEC	Forward Error Correction
GFP	Generic Framing Procedure
HROP	Hypothetical Reference Optical Path
IAE	Incoming Alignment Error
IP	Internet Protocol
ISM	In-Service Monitoring
LCK	Locked Defect

LOD	Local Operator Domain
LOF	Loss of Frame Alignment
LOM	Loss of Multiframe Alignment
LOS	Loss of Signal
LTC	Loss of Tandem Connection
OCI	Open Connection Indication
ODUk	Optical Channel Data Unit-k
OG	Operator Gateway
OOS	Out-of-Service
OPUk	Optical Channel Payload Unit-k
OTN	Optical Transport Network
PEP	Path End Point
PLM	Payload Label Mismatch
ROD	Regional Operator Domain
SDH	Synchronous Digital Hierarchy
SES	Severely Errored Second
SESR	Severely Errored Second Ratio
STM	Synchronous Transport Module
TC	Tandem Connection
TCM	Tandem Connection Monitoring
TIM	Trace Identifier Mismatch

5 Measurement of the block

5.1 In-service monitoring

Each block is monitored by means of an inherent bit interleaved parity (BIP) error detection code (EDC) with a specified EDC usage. The EDC bits are physically separated from the block to which they apply. It is not normally possible to determine whether a block or its controlling EDC bits are in error. If there is a discrepancy between the EDC and its controlled block, it is always assumed that the controlled block is in error.

The EDC for the ODUk path and ODUk TC is BIP-8. The block size for the ODUk path and ODUk TC is given in Table 8-1, and is equal to the number of bits in the ODUk frame (payload plus overhead). Note that the BIP-8 EDC is computed over the OPUk payload plus OPUk overhead bits, but not the ODUk overhead bits. The EDC Usage is $1 \times \text{BIP-8}$.

5.2 Out-of-service measurements

Out-of-service measurements shall also be block-based. It is expected that the out-of-service error detection capability will be superior to the in-service capability described in clause 5.1.

6 Performance monitoring at the near end and far end of a path

By monitoring SES events for both directions at a single path end point, a network provider is able to determine the unavailable state of the path (see Annex A). In some cases, it is also possible to monitor the full set of error performance parameters in both directions from one end of the path. Specific in-service indicators for deriving far end performance of a path are listed in clause 7.

7 Relationship between path performance monitoring and the block-based parameters

7.1 General

In addition to path performance monitoring, this clause covers tandem connection monitoring (TCM) as shown in Tables 7-1 to 7-3. ODUk path and ODUk tandem connection trails are equivalent from a performance perspective. The established rules for ODUk Path apply also to ODUk TC. Further details are given in [ITU-T G.709], [ITU-T G.798] and [ITU-T G.872].

7.1.1 Anomalies

In-service anomaly conditions are used to determine the error performance of an ODUk path when the path is not in a defect state. The following anomaly is defined:

- a1 an EB as indicated by an EDC with the respective EDC usage. (See clause 5.1.)

7.1.2 Defects

In-service defect conditions defined in [ITU-T G.798] are used to determine the change of performance state which may occur on a path. Tables 7-1 and 7-2 show the defects used in this Recommendation.

Table 7-1 – Defects resulting in a near-end severely errored second

Near-end defects (Notes 2, 3, 4)		
Path termination	Non-intrusive monitor	Tandem connection
OCI (Note 1)		OCI (Note 1)
AIS		AIS
		IAE
LCK		LCK
		LTC
PLM		
TIM		TIM

NOTE 1 – Paths not actually completed, e.g., during path set-up, will contain the ODUk-OCI (open connection indication) signal.

NOTE 2 – The above defects are path defects only. Section defects such as OCh LOS, OTUk LOF, OTUk AIS, OTUk TIM, and OTM LOS give rise to an AIS defect in the path layers.

NOTE 3 – When a near-end SES is caused by a near-end defect as defined above, the far-end performance event counters are not incremented, i.e., an error-free period is assumed. When a near-end SES results from $\geq 15\%$ errored blocks, the far-end performance evaluation continues during the near-end SES. This approach does not allow reliable evaluation of far-end data if the near-end SES is caused by a defect. It should be noted in particular that the evaluation of far-end events (such as SES or unavailability) can be inaccurate in the case where far-end SESs occur in coincidence with near-end SESs caused by a defect. Such inaccuracies cannot be avoided, but are negligible in practice because of the low probability of the occurrence of such phenomena.

NOTE 4 – Refer to [ITU-T G.798] for defects contributing to performance monitoring in each trail termination sink function.

Table 7-2 – Defects resulting in a far-end severely errored second

Far-end defects		
Path termination	Non-intrusive monitor	Tandem connection
BDI	BDI	BDI

7.2 Estimation of the performance parameters

For ODUk transmission paths, the full set of performance parameters shall be estimated using the following events:

SES An SES is observed when, during one second, at least 15% EBs, derived from anomaly a1, or one defect according to Tables 7-1 and 7-2, occur (see Table 7-3).

BBE A BBE is observed when an anomaly a1 occurs in a block not being part of an SES.

NOTE – The errored block threshold resulting in an SES is shown in Table 7-3 for each ODUk path type.

Table 7-3 – Threshold for the declaration of a severely errored second

Bit rate (kbit/s)	Path type	Threshold for SES (Number of errored blocks in one second)
1 244 160	ODU0	1 526
2 498 775	ODU1	3 064
10 037 273	ODU2	12 304
10 399 525	ODU2e	12 748
40 319 218	ODU3	49 424
104 794 445	ODU4	128 459
Any bit rate $X \geq 1\,244\,160$	ODUflex	ceiling($(150 \times X)/122\,368$)

7.3 Estimation of performance events at the far end of a path

The following indications available at the near end or at an intermediate point along the path/tandem connection are used to estimate the performance events (occurring at the far end) for the reverse direction:

- ODUk path/tandem connection BDI and BEI ([ITU-T G.709]).
- ODUk path/tandem connection BEIs are anomalies which are used to determine the occurrence of BBE and SES at the far end.
- ODUk path/tandem connection BDIs are defects which estimate the occurrence of SES at the far end.

8 Error performance objectives

8.1 End-to-end objectives

Table 8-1 specifies the end-to-end objectives for a 27'500 km HROP in terms of the parameters defined in clause 3.2. The SESR and BBER objectives assume that the standardized ITU-T G.709 FEC is used. The actual objectives applicable to a real path are derived from Table 8-1 using the allocation principles detailed in clause 8.3. Each direction of the path shall independently satisfy the allocated objectives for all parameters. In other words, a path fails to satisfy this Recommendation if any parameter exceeds the allocated objective in either direction at the end of the given evaluation

period. The objectives given in this Recommendation are understood to be long-term objectives to be met over an evaluation period of typically 30 consecutive days (1 month).

Table 8-1 – End-to-end error performance objectives for a 27'500 km international ODUk HROP

Nominal bit rate (kbit/s)	Path type (Notes 1 and 2)	Blocks/s (Note 3)	SESR	BBER
1 244 160	ODU0	10 168	0.002	2.5×10^{-6}
$239/238 \times 2\,488\,320$	ODU1	20 421	0.002	2.5×10^{-6}
$239/237 \times 9\,953\,280$	ODU2	82 026	0.002	2.5×10^{-6}
$239/237 \times 10\,312\,500$	ODU2e	84 986	0.002	2.5×10^{-6}
$239/236 \times 39\,813\,120$	ODU3	329 492	0.002	2.5×10^{-6}
$239/227 \times 99\,532\,800$	ODU4	856 388	0.002	2.5×10^{-6}
Any bit rate $X \geq 1\,244\,160$	ODUflex	$(1000 \times X)/122\,368$	0.002	2.5×10^{-6}

NOTE 1 – The block size for ODUk, k = 0, 1, 2, 2e, 3, 4, flex is equal to the ODUk frame size, which is $4 \times 3\,824 \times 8 = 122\,368$ bits.

NOTE 2 – The EDC is BIP-8, and is computed over the OPUk payload ($4 \times 3\,808 \times 8$ bits) plus OPUk overhead ($4 \times 2 \times 8$ bits), for a total of $4 \times 3\,810 \times 8 = 121\,920$ bits. The EDC usage is 1 × BIP-8.

NOTE 3 – These values are rounded to the nearest upper unit.

8.2 Hypothetical reference optical path

The reference model in this Recommendation uses the notion of operator domains rather than national and international portions. Three types of domains are identified, the local operator domain (LOD), the regional operator domain (ROD), and the backbone operator domain (BOD). The boundary between the domains is called an operator gateway (OG). For correspondence with [ITU-T G.826] and [ITU-T G.828], the LOD and ROD are associated with the national portion, while the BODs are associated with the international portion. For continued consistency with [ITU-T G.826] and [ITU-T G.828], four BODs (one for each transit country) and two pairs of LOD-ROD are used for a total of eight (8) operator domains. The HROP, therefore, originates and terminates in the domain of a local operator; it traverses the domains of regional operators and backbone operators.

The hypothetical reference optical path is a 27'500 km long path, spanning a total of 8 domains, as illustrated in Figure 3.

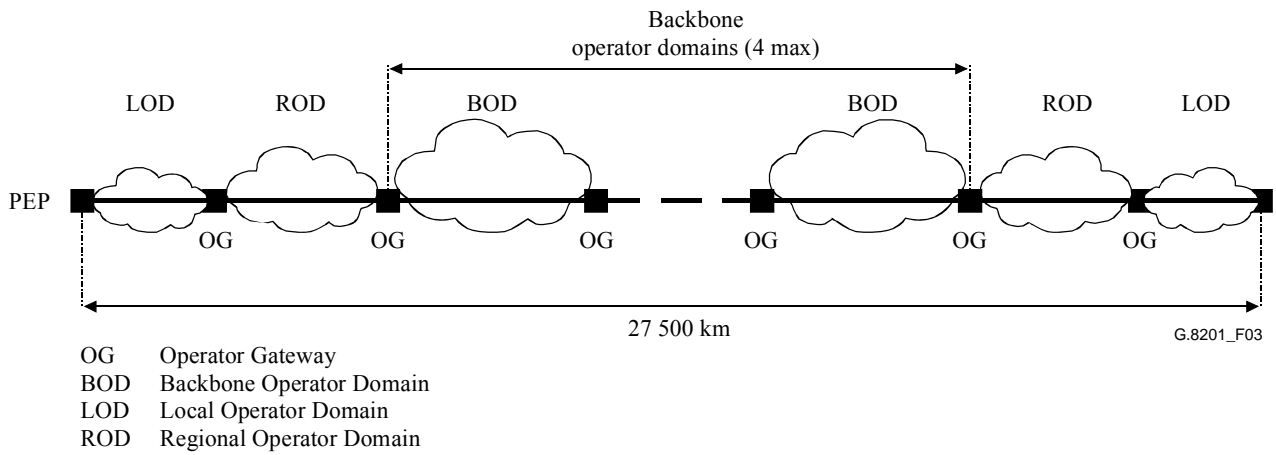

Figure 3 – Hypothetical reference optical path

8.3 Allocation of end-to-end performance objectives

For the three types of operator domains, the following block allocations apply:

- a block allocation of 5% for a backbone operator domain;
- a block allocation of 5% for a regional operator domain;
- a block allocation of 7.5% for a local operator domain.

An additional distance-based allocation is also given to each operator domain. This distance-based allocation is 0.2% per 100 km based on the product of the air route distance and a routing factor. The distance-based allocation is added to the block allocation to yield the total allocation for an operator domain.

The routing factor is specified as follows for each operator domain (between OGs):

- if the air route distance between two OGs is <1000 km, the routing factor is 1.5;
- if the air route distance is ≥ 1000 km and <1200 km, the calculated route length is taken to be 1500 km;
- if the air route distance between two OGs is ≥ 1200 km, the routing factor is 1.25.

NOTE – A single operator may span several domains, such as one LOD, one ROD and one BOD. In this case, the allocation to the operator is the sum of the various domain allocations.

Annex A

Criteria for entry to and exit from the unavailable state

(This annex forms an integral part of this Recommendation.)

A.1 Criteria for a single direction

A period of unavailable time begins at the onset of ten consecutive SES events. These ten seconds are considered to be part of unavailable time. A new period of available time begins at the onset of 10 consecutive non-SES events. These ten seconds are considered to be part of available time. Figure A.1 illustrates the definition of criteria for transition to/from the unavailable state.

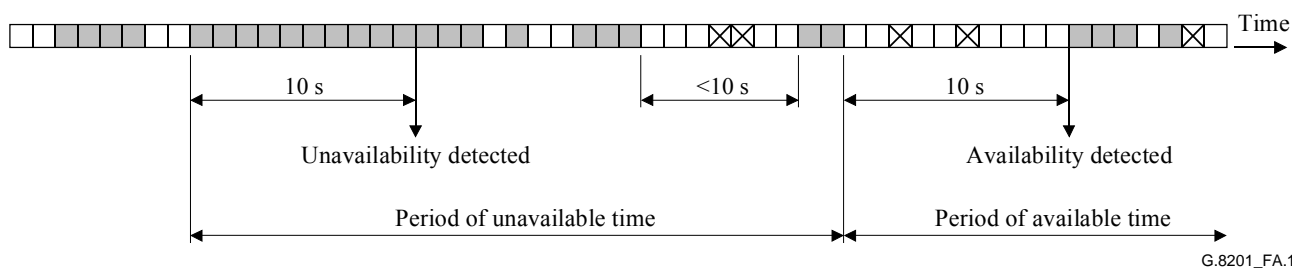

- Severely Errored Second (SES)
- ⊗ Errored Second (ES) (but not an SES)
- Error-free Second

Figure A.1 – Example of unavailability determination

NOTE – In the context of this annex, the term errored second (ES) is used not to denote a performance event but rather a one-second interval with at least one errored block.

A.2 Criterion for a bidirectional path

A bidirectional path is in the unavailable state if either one or both directions are in the unavailable state. This is shown in Figure A.2.

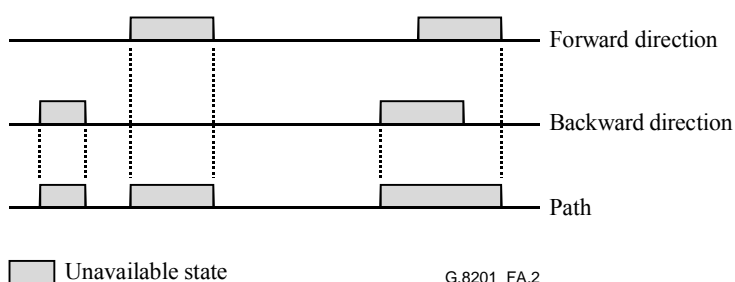

Figure A.2 – Example of the unavailable state of a path

A.3 Criterion for a unidirectional path

The criterion for a unidirectional path is defined in clause A.1 above.

A.4 Consequences on error performance measurements

When a bidirectional path is in the unavailable state, SES and BBE counts may be collected in both directions and may be helpful in the analysis of the trouble. However, it is recommended that these SES and BBE counts are not included in estimates of SESR and BBER performance.

Some existing systems may not support the above requirement. For these systems, the performance of a bidirectional path can be approximated by evaluating the parameters in each direction, independently of the state of availability of the other direction. It should be noted that this approximation method may result in a worse estimate of performance in the event that only one direction of a bidirectional path becomes unavailable.

NOTE – This is not an issue for unidirectional paths.

Appendix I

Flow chart illustrating the recognition of anomalies, defects, errored blocks, and SES

(This appendix does not form an integral part of this Recommendation.)

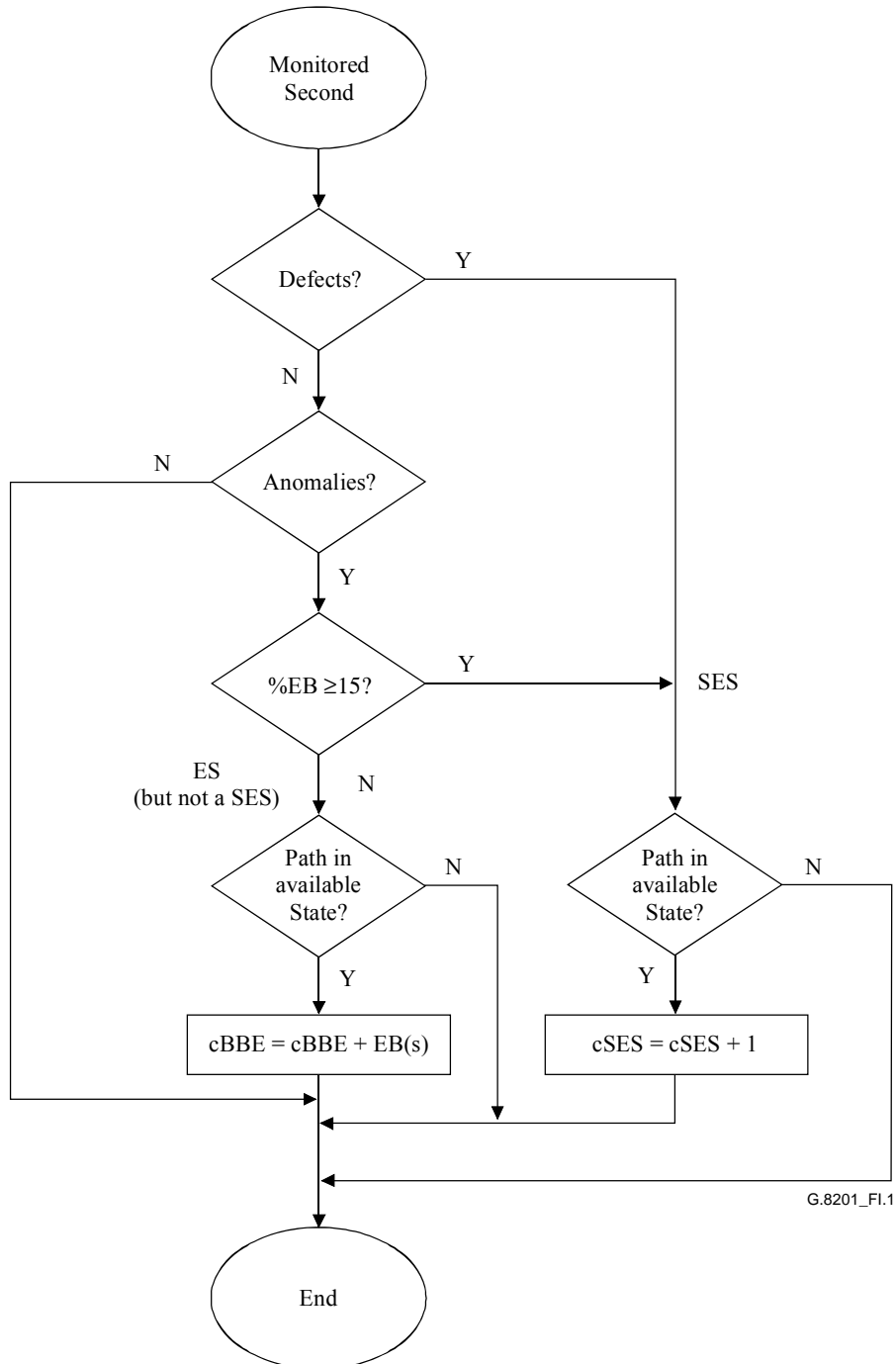

(See Notes)

Figure I.1 – Flow chart illustrating the recognition of anomalies, defects, errored blocks, SES and BBE

Notes to Figure I.1:

NOTE 1 – In the context of this appendix, the term errored second (ES) is used not to denote a performance event, but rather a one-second interval with at least one errored block.

NOTE 2 – The determination of unavailability time introduces a delay of 10 seconds. This delay should be considered when counting BBE and SES.

NOTE 3 – cSES and cBBE represent counts of SES and BBE respectively. These counts are reset at the start of a measurement period.

NOTE 4 – EB is the count of errored blocks within an ES whilst %EB represents the proportion of errored blocks within an ES compared to the number of blocks per second.

NOTE 5 – ITU-T G.8201 parameters can be evaluated during, or at the end of, a measurement period P as follows, taking into account unavailable seconds (UAS):

$$\text{BBER} = \text{cBBE} / [(\text{P} - \text{UAS}) \times \text{blocks per second}]$$

$$\text{SESR} = \text{cSES} / (\text{P} - \text{UAS})$$

NOTE 6 – In the simplified diagrams, no action is taken if the path is in the unavailable state. This is because the diagram does not consider the transition between availability states when, in fact, event counters must be modified. In practice, the status of a second (i.e., non-SES or SES) must always be determined before a test is made on the status of path availability. In other words, error events are always detected regardless of whether the path is available or not. Only the counting of events is inhibited during unavailability periods for the purposes of long-term performance monitoring. This process is reflected in the flow chart although consequent actions on changes of availability state are not.

Appendix II

Example of OTN layer network trails

(This appendix does not form an integral part of this Recommendation.)

Figure II.1 illustrates the role of the OTN in carrying various higher layer clients such as STM-N, and the supporting role of lower layer protocols such as the OTUk, OTSn, etc.

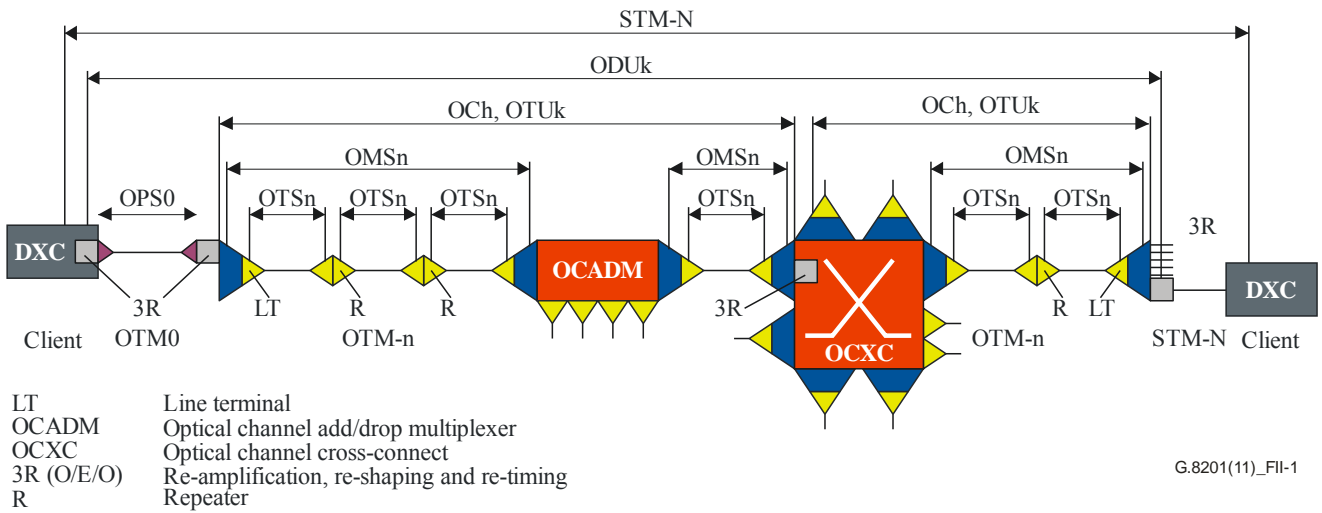

Figure II.1 – Example of the transport of an STM-N signal in OTN

Bibliography

- [b-ITU-T M.2401] Recommendation ITU-T M.2401 (2003), *Error performance limits and procedures for bringing-into-service and maintenance of multi-operator international paths and sections within an optical transport network.*

SERIES OF ITU-T RECOMMENDATIONS

Series A	Organization of the work of ITU-T
Series D	General tariff principles
Series E	Overall network operation, telephone service, service operation and human factors
Series F	Non-telephone telecommunication services
Series G	Transmission systems and media, digital systems and networks
Series H	Audiovisual and multimedia systems
Series I	Integrated services digital network
Series J	Cable networks and transmission of television, sound programme and other multimedia signals
Series K	Protection against interference
Series L	Construction, installation and protection of cables and other elements of outside plant
Series M	Telecommunication management, including TMN and network maintenance
Series N	Maintenance: international sound programme and television transmission circuits
Series O	Specifications of measuring equipment
Series P	Terminals and subjective and objective assessment methods
Series Q	Switching and signalling
Series R	Telegraph transmission
Series S	Telegraph services terminal equipment
Series T	Terminals for telematic services
Series U	Telegraph switching
Series V	Data communication over the telephone network
Series X	Data networks, open system communications and security
Series Y	Global information infrastructure, Internet protocol aspects and next-generation networks
Series Z	Languages and general software aspects for telecommunication systems