

International Telecommunication Union

ITU-T

TELECOMMUNICATION
STANDARDIZATION SECTOR
OF ITU

K.50

Amendment 1
(06/2020)

SERIES K: PROTECTION AGAINST INTERFERENCE

Safe limits for operating voltages and currents in
telecommunication systems powered over the
network

Amendment 1

Recommendation ITU-T K.50 (2018) – Amendment 1

ITU-T



Recommendation ITU-T K.50

Safe limits for operating voltages and currents in telecommunication systems powered over the network

Amendment 1

Summary

Recommendation ITU-T K.50 provides guidance on voltages and currents that may safely be used to power telecommunication systems that are part of the network of telecommunications service providers. These systems use the paired-conductor cables of the network or specific power feeding cables to provide power to equipment at remote locations. This equipment and the current-carrying conductors can be accessed in the energized state by service or skilled personnel without using insulated gloves or tools. For safety reasons, system types operating at hazardous voltages are not intended to pass beyond the public network interface (PNI) between the service provider and the end customer. These hazardous voltage systems are not intended to be part of the subscriber's installation, and are not accessible to users of the network. They are located in the networks between different telecommunication centres, between a telecommunication centre and a telecommunications access facility/node, and between a telecommunication centre and PNIs. Recommendation ITU-T K.50 only covers systems that use continuous d.c. powering.

Amendment 1 updates Figure 3 to make reference to ITU-T K.50 instead of IEC 60950-1.

History

Edition	Recommendation	Approval	Study Group	Unique ID*
1.0	ITU-T K.50	2000-02-25	5	11.1002/1000/4913
2.0	ITU-T K.50	2016-07-14	5	11.1002/1000/12871
3.0	ITU-T K.50	2016-12-14	5	11.1002/1000/13130
4.0	ITU-T K.50	2018-01-13	5	11.1002/1000/13445
4.1	ITU-T K.50 (2018) Amd. 1	2020-06-29	5	11.1002/1000/14292

Keywords

ATIS-0600337, IEC 60950-1, IEC 60950-21, IEC 62368-1, remote power feeding, RFT, RFT-C, RFT-V, safety, telecommunication systems.

* To access the Recommendation, type the URL <http://handle.itu.int/> in the address field of your web browser, followed by the Recommendation's unique ID. For example, <http://handle.itu.int/11.1002/1000/11830-en>.

FOREWORD

The International Telecommunication Union (ITU) is the United Nations specialized agency in the field of telecommunications, information and communication technologies (ICTs). The ITU Telecommunication Standardization Sector (ITU-T) is a permanent organ of ITU. ITU-T is responsible for studying technical, operating and tariff questions and issuing Recommendations on them with a view to standardizing telecommunications on a worldwide basis.

The World Telecommunication Standardization Assembly (WTSA), which meets every four years, establishes the topics for study by the ITU-T study groups which, in turn, produce Recommendations on these topics.

The approval of ITU-T Recommendations is covered by the procedure laid down in WTSA Resolution 1.

In some areas of information technology which fall within ITU-T's purview, the necessary standards are prepared on a collaborative basis with ISO and IEC.

NOTE

In this Recommendation, the expression "Administration" is used for conciseness to indicate both a telecommunication administration and a recognized operating agency.

Compliance with this Recommendation is voluntary. However, the Recommendation may contain certain mandatory provisions (to ensure, e.g., interoperability or applicability) and compliance with the Recommendation is achieved when all of these mandatory provisions are met. The words "shall" or some other obligatory language such as "must" and the negative equivalents are used to express requirements. The use of such words does not suggest that compliance with the Recommendation is required of any party.

INTELLECTUAL PROPERTY RIGHTS

ITU draws attention to the possibility that the practice or implementation of this Recommendation may involve the use of a claimed Intellectual Property Right. ITU takes no position concerning the evidence, validity or applicability of claimed Intellectual Property Rights, whether asserted by ITU members or others outside of the Recommendation development process.

As of the date of approval of this Recommendation, ITU had not received notice of intellectual property, protected by patents, which may be required to implement this Recommendation. However, implementers are cautioned that this may not represent the latest information and are therefore strongly urged to consult the TSB patent database at <http://www.itu.int/ITU-T/ipr/>.

© ITU 2020

All rights reserved. No part of this publication may be reproduced, by any means whatsoever, without the prior written permission of ITU.

Table of Contents

	Page
1 Scope	1
2 References.....	2
3 Definitions	2
3.1 Terms defined elsewhere	2
3.2 Terms defined in this Recommendation.....	5
4 Abbreviations and acronyms	6
5 Conventions	7
6 Voltage and current limits	7
6.1 General	7
6.2 Method 1: Voltage-limited RFT (RFT-V) circuits.....	8
6.3 Method 2: Current-limited RFT (RFT-C) circuits.....	12
7 Work practices	16
7.1 General work practices	16
7.2 Special work practices.....	17
Appendix I – Specialized remote powering at TNV (ES1 & ES2) voltages	18
I.1 Introduction	18
I.2 Fibre to the distribution point, FTT(dp), reverse power feeding (RPF).....	18
Bibliography.....	19

Introduction

Telecommunication networks sometimes use equipment that generates voltages and currents that exceed TNV-1, TNV-2, TNV-3 (defined in [IEC 60950-1]) and ES1, ES2 (defined in [IEC 62368-1]) to provide power to remote equipment over paired-conductor network telecommunications cables. Examples of this type of equipment are x-type digital subscriber line (xDSL) powering units, xDSL remote terminating units, line power up-converters, line power down-converters, repeaters, regenerators, or other remote cabinet or enclosure equipment. The voltages and currents that power these systems differ from those of telecommunication services provided to end users or subscribers. To help ensure that service or skilled personnel can safely work on these lines or equipment without de-energizing the circuits or using insulated gloves, this Recommendation provides guidance not only on the voltage and current limits for these systems, but also the associated work practices required.

Voltages and currents that may be applied to a telecommunication network by equipment forming part of a subscriber's installation are covered in [IEC 60950-1] and [IEC 62368-1].

This Recommendation includes the operating voltages and currents defined in [b-ATIS-0600337].

Recommendation ITU-T K.50

Safe limits for operating voltages and currents in telecommunication systems powered over the network

Amendment 1

Editorial note: This is a complete-text publication. Modifications introduced by this amendment are shown in revision marks relative to Recommendation ITU-T K.50 (2018).

1 Scope

This Recommendation provides guidance on voltages and currents that may safely be used to power telecommunication systems that are part of the telecommunications service provider's network. These systems use the paired-conductor cables of the network to provide power to communications-related equipment at remote locations. This equipment and the current-carrying conductors can be accessed in the energized state by service or skilled personnel without using insulated gloves or tools. These systems are not intended to extend a voltage-limited remote feeding telecommunication (RFT-V) or a current-limited RFT (RFT-C) circuit beyond the point of demarcation between the service provider and the end user or ordinary people. In addition, exposed RFT-V and RFT-C circuits are not allowed to be accessible to ordinary people or end users. The systems that use RFT-C and RFT-V are located in the network between different telecommunication centres, between a telecommunication centre and a telecommunications access facility or node, and between a telecommunication centre and public network interfaces (PNIs). This Recommendation covers only systems that use continuous direct current (d.c.) powering.

RFT circuits sometimes carry signalling or data on the conductors, as well as delivering power. However, in many cases the conductors are used to simply provide d.c. power and no signalling or data is present. This is becoming more commonplace, as fibre is used more and more to transmit broadband data and twisted pair copper cable pairs are used to power remote telecommunications equipment.

Figure 1-a shows the field of application in the network between different telecommunication centres. Figure 1-b shows the part of the access network where this Recommendation is applicable. If there is no access network equipment between the local exchange and the customer premises equipment to convert the RFT-V or RFT-C to telecommunication network voltage-1 (TNV-1), TNV-2, TNV-3, energy source class 1 (ES1) or energy source class 2 (ES2), this Recommendation does not apply.

Guidance on work practices, if these limits are exceeded, can be found in [b-ITU-T Directives Vol. VI] and [b-ITU-T Directives Vol. VII].

NOTE 1 – Limits on permissible voltages that may occur because of exposure to power or electrified railway lines are provided in [b-ITU-T Directives].

NOTE 2 – Requirements for the safety of equipment that is part of the telecommunications network infrastructure are provided in [b-ITU-T K.51], [IEC 60950-1] and [IEC 62368-1].

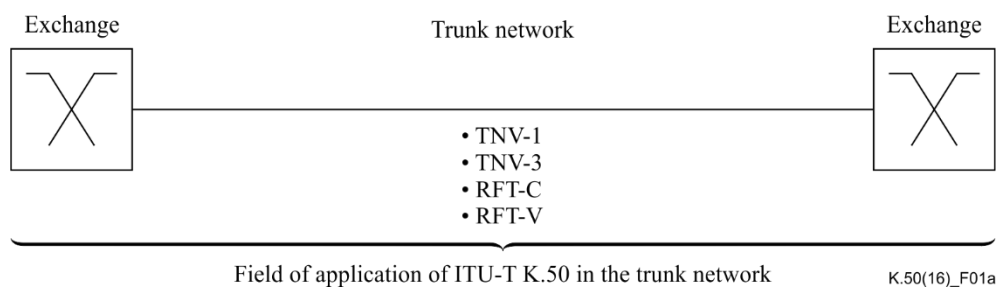

a)

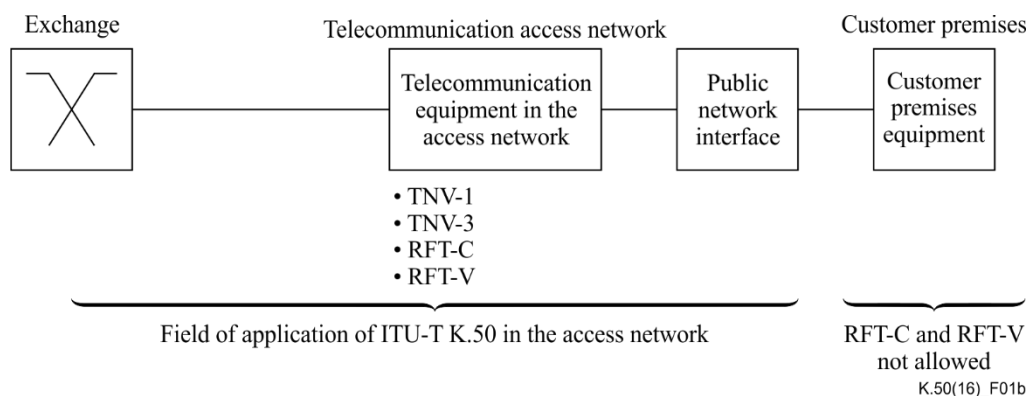

b)

NOTE 1 – ES1, power source class 1 (PS1) connected to ICT cabling exposed to overvoltages would be equivalent to TNV-1.
 NOTE 2 – ES2, power source class 2 (PS2) connected to ICT cabling exposed to overvoltages would be equivalent to TNV-3.

Figure 1 – Field of application of this Recommendation: a) in the trunk network; b) in the access network

2 References

The following ITU-T Recommendations and other references contain provisions which, through reference in this text, constitute provisions of this Recommendation. At the time of publication, the editions indicated were valid. All Recommendations and other references are subject to revision; users of this Recommendation are therefore encouraged to investigate the possibility of applying the most recent edition of the Recommendations and other references listed below. A list of the currently valid ITU-T Recommendations is regularly published. The reference to a document within this Recommendation does not give it, as a stand-alone document, the status of a Recommendation.

[IEC 60950-1] IEC 60950-1 (2013), *Information technology equipment – Safety – Part 1: General requirements*.

[IEC 62368-1] IEC 62368-1 (2014), *Audio/video, information and communication technology equipment – Part 1: Safety requirements*.

3 Definitions

3.1 Terms defined elsewhere

NOTE – The definition of circuits in [IEC 60950-1] is limited to circuits internal to equipment. In [IEC 62368-1] the definition of circuits is limited to circuits external to equipment, which are normally considered to be a telecommunication network. For this Recommendation, the definition of circuits is extended to include network cable conductors that carry the same voltages/currents.

This Recommendation uses the following terms defined elsewhere:

3.1.1 basic insulation [IEC 60950-1]: Insulation to provide basic protection against electric shock.

NOTE – [IEC 62368-1] refers to "basic safeguard" rather than "basic protection" and notes "This concept does not apply to insulation used exclusively for functional purposes".

3.1.2 double insulation [IEC 60950-1]: Insulation comprising both basic insulation and supplementary insulation.

3.1.3 ELV circuit [IEC 60950-1]: Secondary circuit with voltages between any two conductors of the circuit, and between any one such conductor and earth, not exceeding 42.4 V peak, or 60 V d.c., under normal operating conditions, which is separated from hazardous voltage by basic insulation, and which neither meets all of the requirements for an SELV circuit nor meets all of the requirements for a limited current circuit.

3.1.4 external circuit [IEC 62368-1]: Electrical circuit that is external to the equipment and is not mains.

NOTE – An external circuit is classified as ES1, ES2 or ES3, and PS1, PS2 or PS3.

3.1.5 functional insulation [IEC 62368-1]: Insulation between conductive parts which is necessary only for the proper functioning of the equipment.

NOTE – [IEC 60950-1] adds the informative note "functional insulation by definition does not protect against electric shock. It may, however, reduce the likelihood of ignition and fire".

3.1.6 hazardous voltage [IEC 60950-1]: Voltage exceeding 42.4 V peak, or 60 V d.c., existing in a circuit that does not meet the requirements for either a limited current circuit or a TNV circuit.

NOTE – The corresponding [IEC 62368-1] requirement would be voltages exceeding ES1.

3.1.7 instructed person [IEC 62368-1]: Person instructed or supervised by a skilled person as to energy sources and who can responsibly use equipment safeguards and precautionary safeguards with respect to those energy sources.

NOTE 1 – Supervised, as used in the definition, means having the direction and oversight of the performance of others.

NOTE 2 – In the context of this Recommendation, the term *instructed person* is synonymous with *user* [IEC 60950-1].

3.1.8 limited current circuit [IEC 60950-1]: Circuit that is so designed and protected that, under both normal operating conditions and single fault conditions, the current that can be drawn is not hazardous.

NOTE 1 – Simulated faults and abnormal conditions are defined in clause 1.4.14 of [IEC 60950-1].

NOTE 2 – The limit value of d.c. is defined as 2 mA d.c. through a 2 k Ω resistor connected between any two parts of a limited current circuit or between any such part and earth in clause 2.4 of [IEC 60950-1].

3.1.9 ordinary person [b-IEC 60050-826]: Person who is neither a skilled person nor an instructed person.

NOTE – In the context of this Recommendation, the term *ordinary person* is synonymous with *user* [IEC 60950-1].

3.1.10 overvoltage [b-IEC/TR 60664-2-1]: Any voltage having a peak value exceeding the corresponding peak value of maximum steady-state voltage at normal operating conditions.

3.1.11 primary circuit [IEC 60950-1]: Circuit that is directly connected to the a.c. mains supply.

3.1.12 prospective touch voltage [IEC 62368-1]: Voltage between simultaneously accessible conductive parts when those conductive parts are not being touched.

3.1.13 reinforced insulation [IEC 62368-1]: Single insulation system that provides a degree of protection against electric shock equivalent to double insulation.

NOTE – [IEC 60950-1] adds the informative note "The term "insulation system" does not imply that the insulation has to be in one homogeneous piece. It may comprise several layers that cannot be tested as basic insulation and supplementary insulation".

3.1.14 secondary circuit [IEC 60950-1]: Circuit that has no direct connection to a primary circuit and derives its power from a transformer, converter or equivalent isolation device, or from a battery.

NOTE 1 – In the context of this Recommendation, the definition of circuits is extended to include network cable conductors that carry the same voltages/currents.

NOTE 2 – [IEC 62368-1] does not define the term *secondary circuit*, but refers to it as *circuit within the equipment not connected to an a.c. mains*.

3.1.15 SELV circuit [IEC 60950-1]: Secondary circuit that is so designed and protected that under normal operating conditions and single fault conditions, its voltages do not exceed a safe value.

NOTE 1 – Simulated faults and abnormal conditions are defined in clause 1.4.14 of [IEC 60950].

NOTE 2 – Maximum safe d.c. voltages are defined as 60 V d.c., under normal operating conditions and 120 V d.c. for less than 200 ms, under single fault conditions in clause 2.2 of [IEC 60950].

3.1.16 service person [IEC 60950-1]: Person having appropriate technical training and experience necessary to be aware of hazards to which that person may be exposed in performing a task and of measures to minimize the danger to that person or other persons.

NOTE – In the context of this Recommendation, a service person must be authorized by the network operator.

3.1.17 skilled person [IEC 62368-1]: Person with relevant education or experience to enable him or her to identify hazards and to take appropriate actions to reduce the risks of injury to themselves and others.

NOTE – In the context of this Recommendation, the term *skilled person* is synonymous with *service person* [IEC 60950-1].

3.1.18 supplementary insulation [IEC 60950-1]: Independent insulation applied in addition to basic insulation in order to reduce the risk of electric shock in the event of a failure of the basic insulation.

NOTE – [IEC 62368-1] refers to "supplementary safeguard" rather than "in addition to basic insulation".

3.1.19 TNV circuit [IEC 60950-1]: Circuit that is in the equipment and to which the accessible area of contact is limited and that is so designed and protected that, under normal operating conditions and single fault conditions, the voltages do not exceed specified limit values.

NOTE 1 – Simulated faults and abnormal conditions are defined in [IEC 60950-1], clause 1.4.14.

NOTE 2 – TNV circuits are classified as TNV-1, TNV-2 and TNV-3 circuits.

3.1.20 TNV-1 circuit [IEC 60950-1]: TNV circuit whose normal operating voltages do not exceed the limits for an SELV circuit under normal operating conditions and on which overvoltages from telecommunication networks and cable distribution systems are possible.

3.1.21 TNV-2 circuit [IEC 60950-1]: TNV circuit whose normal operating voltages exceed the limits for an SELV circuit under normal operating conditions which is not subject to overvoltages from telecommunication networks.

NOTE – TNV-2 circuits operate at d.c. voltage levels above 60 V d.c., but not exceeding 120 V d.c.

3.1.22 TNV-3 circuit [IEC 60950-1]: TNV circuit whose normal operating voltages exceed the limits for an SELV circuit under normal operating conditions and on which overvoltages from telecommunication networks and cable distribution systems are possible.

NOTE – TNV-3 circuits operate at d.c. voltage levels above 60 V d.c., but not exceeding 120 V d.c.

3.1.23 touch current [IEC 62368-1]: Electric current through a human body when body parts touch two or more accessible parts or one accessible part and earth.

NOTE – [IEC 60950-1] has a similar, but less comprehensive, definition for the term *touch current*.

3.1.24 user [IEC 60950-1]: Any person other than a service person.

NOTE – [IEC 60950-1] states that the terms *user* and *operator* are synonymous.

3.2 Terms defined in this Recommendation

This Recommendation defines the following terms:

3.2.1 electrical energy source (ES): Capacitive source with defined capacitance and charge voltage or prospective touch voltage and the touch current source with defined values for normal operation, abnormal operation and single fault conditions or a pulsed source with defined values of voltage, current and pulse duration.

NOTE – [IEC 62368-1] does not have a formal term and definition entry for ES. This definition is based on clause 5.2 of [IEC 62368-1] clause 5.2.

3.2.2 electrical energy source class 1; ES1: Class 1 energy source with levels not exceeding ES1 limits under normal operating conditions, abnormal operating conditions, single fault conditions of a component, device or insulation not serving as a safeguard and not exceeding ES2 limits under single fault conditions of a basic safeguard.

NOTE 1 – [IEC 62368-1] does not have a formal term and definition entry for ES1. This definition is based on clause 5.2 of [IEC 62368-1].

NOTE 2 – ES1 may be accessible to an ordinary person, user, instructed person, service person or a skilled person. ES1 effects are not painful to the body, but may be detectable although ignition of combustible materials is not likely.

NOTE 3 – ES1 parameter values are given in clause 5.2 of [IEC 62368-1].

3.2.3 electrical energy source class 2; ES2: Class 2 energy source with levels not exceeding ES2 limits under normal operating conditions, abnormal operating conditions, and single fault conditions, but exceeding ES1 limits.

NOTE 1 – [IEC 62368-1] does not have a formal term and definition entry for ES2. This definition is based on clause 5.2 of [IEC 62368-1].

NOTE 2 – ES2 may be accessible to an instructed person, service person or a skilled person. ES2 effects are painful to the body, but do not cause injury, while ignition of combustible materials is possible, but there is limited growth and spread of fire.

NOTE 3 – ES2 parameter values are given in clause 5.2 of [IEC 62368-1].

3.2.4 electrical energy source class 3; ES3: Class 3 energy source with one or more parameters exceeding ES2 limits.

NOTE 1 – [IEC 62368-1] does not have a formal term and definition entry for ES3. This definition is based on clause 5.2 of [IEC 62368-1].

NOTE 2 – ES3 may be accessible to a service person or a skilled person. ES3 effects are injury to the body and ignition of combustible materials is likely with rapid growth and spread of fire.

NOTE 3 – ES3 parameter values are given in clause 5.2 of [IEC 62368-1].

3.2.5 electrical power source; PS: Power source classed by the maximum delivered power values for a power source operating with a worse-case load and for a power source fault operating with the specified normal load.

NOTE – [IEC 62368-1] does not have a formal term and definition entry for PS. This definition is based on clause 6.2 of [IEC 62368-1].

3.2.6 electrical power source class 1; PS1: Circuit where the power source does not exceed a defined limit values measured at specific times.

NOTE 1 – [IEC 62368-1] does not have a formal term and definition entry for PS1. This definition is based on clause 6.2 of [IEC 62368-1].

NOTE 2 – The power available from external circuits described in Table 14, ID numbers 1 and 2, of [IEC 62368-1] are considered to be PS1.

NOTE 3 – Clause 6.2 of [IEC 62368-1] has defined limit values of 500 W <3 s and 15 W >3 s.

3.2.7 electrical power source class 2; PS2: Circuit where the power source exceeds PS1 limits; and does not exceed a defined limit value measured after a specified time.

NOTE 1 – [IEC 62368-1] does not have a formal term and definition entry for PS2. This definition is based on clause 6.2 of [IEC 62368-1].

NOTE 2 – Clause 6.2 of [IEC 62368-1] has a defined limit value of 100 W >5 s.

3.2.8 electrical power source class 3; PS3: Circuit whose power source exceeds PS2 limits or any circuit whose power source has not been classified.

NOTE – [IEC 62368-1] does not have a formal term and definition entry for PS3. This definition is based on clause 6.2 of [IEC 62368-1].

3.2.9 hazardous voltage secondary circuit: Secondary circuit operating at a voltage exceeding 42.4 V peak, or 60 V d.c., existing in a circuit that does not meet the requirements for either a limited current circuit or a TNV circuit.

NOTE 1 – Definition is derived from the [IEC 60950-1] terms, *secondary circuit* and *hazardous voltage*.

NOTE 2 – The term combination *hazardous voltage secondary circuit* is used in [IEC 60950-1], but is not defined.

3.2.10 powered equipment; PDE: Telecommunications equipment that is powered by a power sourcing equipment (PSE) via a twisted pair telecommunications cabling.

3.2.11 power sourcing equipment; PSE: Telecommunications equipment supplying d.c. power to remote telecommunications equipment via twisted pair telecommunication cabling.

3.2.12 public network interface; PNI: A point of demarcation between public and private network. In many cases, the public network interface is the point of connection between the network provider's facilities and the customer premises cabling.

3.2.13 remote feeding telecommunication circuit; RFT circuit: Equipment circuit, without a direct mains connection or being a safety extra-low voltage (SELV) circuit or a TNV service or a limited current circuit or an ES1 PS1 and some ES2 PS2 circuits, intended to supply or receive d.c. power, at voltages, currents and powers that do not exceed defined values under specified operational conditions when connected to paired-conductor communications network on which overvoltages are possible.

NOTE 1 – A telecommunications signal is not required to be present on an RFT circuit, but the power delivered must be used to provide a telecommunication service.

NOTE 2 – Specified conditions include normal operating and single fault conditions and may include abnormal operating and safeguard failure conditions.

NOTE 3 – In the context of this Recommendation, RFT circuits can be regarded as hazardous voltage secondary circuits with defined voltages and currents.

4 Abbreviations and acronyms

This Recommendation uses the following abbreviations and acronyms:

a.c.	alternating current
d.c.	direct current
ES1	Energy Source class 1
ES2	Energy Source class 2
ES3	Energy Source class 3
ICT	Information and Communications Technology
MDF	Main Distribution Frame

OSP	Outside Plant
OVP	Oversvoltage Protection
PD	Powered Device
POTS	Plain Old Telephone Service
PS1	Power Source class 1 (<15 W – steady-state condition)
PS2	Power Source class 2 (greater than 15 W but less than 100 W – steady-state condition)
PNI	Public Network Interface
PSE	Power Sourcing Equipment
RCD	Residual Current Device
RFT	Remote Feeding Telecommunication
RFT-C	Remote Feeding Telecommunication – Current limited
RFT-V	Remote Feeding Telecommunication – Voltage limited
SELV	Safety Extra-Low Voltage
SPD	Surge Protective Device
TNV	Telecommunication Network Voltage
TNV-1	Telecommunication Network Voltage-1
TNV-2	Telecommunication Network Voltage-2
TNV-3	Telecommunication Network Voltage-3

5 Conventions

None.

6 Voltage and current limits

6.1 General

This Recommendation defines two methods for safe powering of telecommunication systems over the network. They are both based on [b-IEC TS 60479-1]. The first method, which is called RFT-V, which starts as 60 V d.c., limits the touch voltage (and above 80 V d.c. limits the current), so that the insulation or the resistance of the body limits the current conducted by service personnel to tolerable levels. The second method, called RFT-C, limits the current of the remote power feeding circuit, so that higher voltages can be allowed.

Both methods have been used and defined for many years by various operators. RFT-V is used in North America and is based on the US and Canadian Electrical codes and Electrical safety codes, in conjunction with [b-GR-1089], [b-UL 2391], [b-ATIS 0600337], and [IEC 60950-1]. [b-NFPA 70] is an example of an existing national standard. RFT-C is used outside North America and is based on [b-DIN VDE 0800-3].

Power sourcing equipment (PSE) and powered device (PD) hardware designed for RFT-V limits shall only be connected to PSE and PD hardware intended for RFT-V, unless the equipment meets both RFT-V and RFT-C requirements.

PSE and PD hardware designed for RFT-C limits shall only be connected to PSE and PD hardware intended for RFT-C, unless the equipment meets both RFT-C and RFT-V requirements.

RFT-C and RFT-V are typically >120 V d.c. levels in most countries, but could be as low as 60 V d.c. due to North American safety standard deviations.

Other d.c. voltage levels are characterized as follows:

- ≤60 V d.c. shall be treated like a TNV-1 or an ES1;
- >60 V d.c., but < 120 V shall be treated like a TNV-3 or an ES2/PS2, or as an RFT-V in North America;
- >120 V d.c. shall be treated like an energy source class 3 (ES3)/PS2, RFT

NOTE – Treating RFT-C and RFT-V similarly to TNV-1/3 or ES1/ES2 is considered to be acceptable, since the controls on RFT [residual current devices (RCDs), voltage or current limits] and its limited accessibility, and limitations on where it occurs in the network, substantially mitigate the safety hazard to customers of service providers as well as the general public if a fault were to occur in the PSE or PD.

6.2 Method 1: Voltage-limited RFT (RFT-V) circuits

RFT-Vs are traditionally used in North America and thus standards like [b-ATIS 0600337] apply.

6.2.1 Limits under normal operating conditions

Under normal operating conditions, an RFT-V circuit shall comply with all of the following requirements:

- a) The steady-state open circuit voltage and normal operating voltage between earth and each conductor that normally connects to a paired-conductor communication network with and without the intended load equipment connected shall:
 - not exceed 80 V d.c.; or
 - be greater than 80 V d.c. but less than or equal to 200 V d.c. and be current limited to earth to 5 mA d.c. with a monitoring and control device (i.e., an RCD circuit).

For new equipment that requires backwards compatibility but cannot meet the limits above due to functional compatibility, it shall:

- not exceed 140 V d.c.; or
- be greater than 140 V d.c. but less than or equal to 200 V d.c. and is current limited to earth to 10 mA d.c. with a monitoring and control device (i.e., an RCD circuit).

For the 200 V d.c. case, the peak voltage during an RCD induced transitional state may exceed 200 V, but shall not exceed that value for more than 10 ms. Additionally, [b-ATIS 0600337] specifies that no more than 2 J can be delivered into a 500 Ω resistive load with respect to earth for more than 10 ms (if the voltage still exceeds 80 V d.c. after 10 ms). This criterion is critical when evaluating the transition that occurs from a monitoring and control device (such as an RCD) or other situations where the powering voltage fluctuates. In many cases, the body shock charge, rather than the shock energy, is the most important safety consideration. The maximum delivered charge values for capacitors from [b-IEC TS 60479-1] can also be used to evaluate safe RCD operation, see Figure 6.

The [IEC 62368-1] safety standard does not allow instructed persons to access voltages above 120 V d.c. (ES2). Service and skilled persons may access any voltage provided that adequate safety precautions are taken.

- b) No more than 100 W (PS2) can continuously be delivered by any single powering circuit under normal operating conditions. A single powering circuit can use parallel multiple pairs of the cable to minimize cable I^2R losses (where I is current and R is resistance), but only 100 W can be delivered continuously to any single load circuit. Load equipment can have multiple 100 W rated input supplies in a single enclosure or shelf.

- c) PSE outputs on telecommunications wiring shall have a functional design rated output (power rating) not greater than 100 VA and a current rating not greater than $100/V_{\max}$, where V_{\max} is the maximum output voltage across two conductors regardless of load with rated input applied. The output power rating is the maximum power that the source is designed to supply over the communications wiring to any intended load circuit under normal operating conditions, including power dissipated in the cabling. Paralleling of power sources over multiple communications wires for the purpose of delivering power in excess of 100 VA to a "single load circuit" shall not be permitted.

The maximum continuous current that may be applied to communication wiring under normal conditions shall be consistent with its power rating, but shall not exceed 1.3 A unless the current capacity of the network wiring and current rating of network connectors and other network components is specified at a higher value and is controlled. The maximum continuous output current (I_{\max}) under overload and fault conditions shall not exceed $150/V_{\max}$ or 2.4 A, whichever is less. The maximum output voltage and current (V_{\max} and I_{\max}) are to be determined from the volt-ampere characteristics of the power source. The volt-ampere characteristics are determined by connecting a variable resistor (or a set of resistors) across the output terminals. Figure 2 illustrates the test circuit. Output voltage and current are measured for various resistance values between 1 M Ω and a short circuit. For each resistance, the voltage and current value are measured after 5 s of operation with any overcurrent protection bypassed.

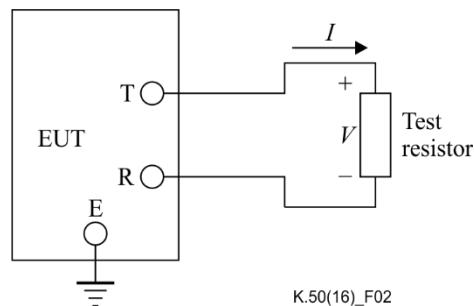

NOTE – These limits do not include states covered by [IEC 60950-1] TNV-2, TNV-3 or [IEC 62368-1] ES1 or ES2 that are duration limited, such as periodic signalling, ringing or message waiting.

Figure 2 – Characterization circuit

These limits shall be measured for each conductor under the following conditions:

- all other conductors are open circuited; and
- any individual conductor of the RFT-V circuit is earthed.

6.2.2 Limits under single fault conditions

In the event of a single fault (see description of single fault in [IEC 60950-1] or [IEC 62368-1]) in the PSE or PD hardware that supplies or receives power by its RFT-V circuit, the following limits apply:

- a) during the first 200 ms, the output voltage per conductor with respect to earth or between conductors does not exceed the limits of Figure 3; and
- b) after the first 200 ms the limits of clause 6.2.1 are met.

These limits shall be measured for each conductor under the following conditions:

- all other conductors are open circuited; and
- all conductors are connected to a representative system or simulated load and actual or simulated cable.

NOTE – A connection of a conductor of an RFT-V circuit to earth is not considered as a single fault condition.

Compliance is checked by inspection and measurement while simulating failure of components and insulation such as are likely to occur inside the PSE and PD hardware. Clause 6.2.2 a) is checked by using a resistor of $(5\ 000 \pm 100)\ \Omega$.

6.2.3 Limits with one conductor earthed

If one conductor of an RFT-V circuit that normally connects to a paired-conductor telecommunication network is earthed:

- the open circuit voltage between the other conductors and earth shall not exceed the maximum RFT-V circuit voltage after 10 ms; and
- with all the conductors that normally connect to a paired-conductor telecommunication network being connected as normally intended to representative load equipment and appropriate cable lengths (or simulated load equipment if unknown) the voltage between the other unearthed conductors and earth shall not exceed the maximum RFT-V circuit voltage after 10 ms; and
- for RFT-V circuits whose (open circuit or terminated) voltage exceeds 80 V d.c. under normal operating conditions, the current between the other conductors and earth, measured through any resistance value from $0\ \Omega$ to $40\ \text{k}\Omega$, under any external load condition, shall not exceed 5 mA d.c. after 10 ms. Additionally, [b-ATIS 0600337] specifies that no more than 2 J can be delivered into a $500\ \Omega$ load to ground within 10 ms if the normal operating voltage exceeds 80 V d.c. Note this is critical when evaluating the transition that occurs from a monitoring and control device such as an RCD or changes in operational states.

NOTE – These limits do not include states covered by [b-IEC 60950-21] TNV-2/TNV-3 or [IEC 62368-1] ES1/ES2 that are duration limited, such as periodic signalling, ringing or message waiting.

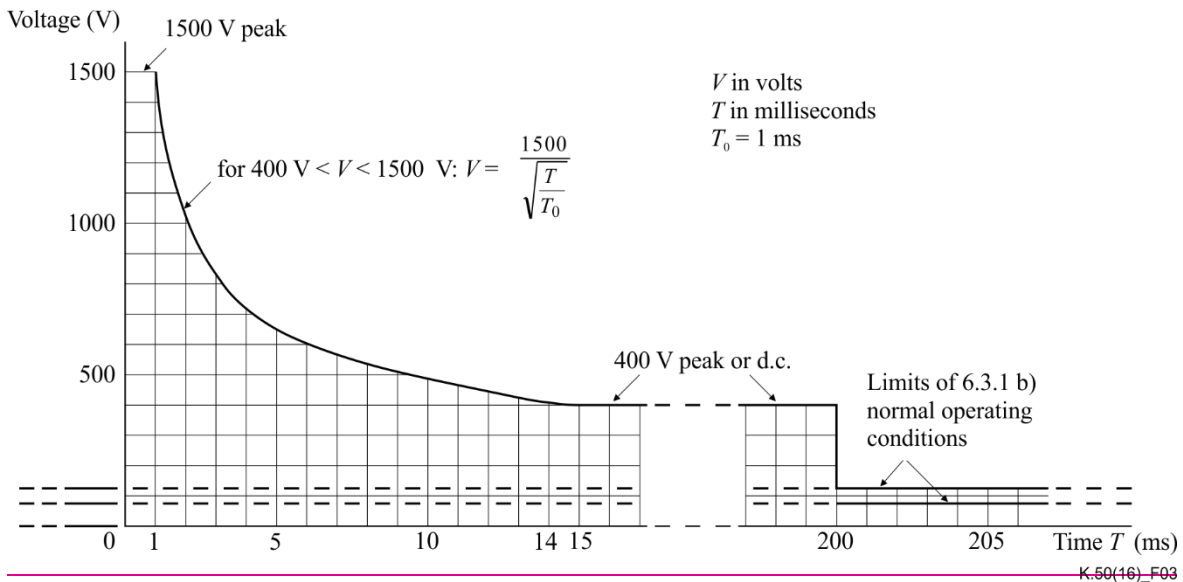
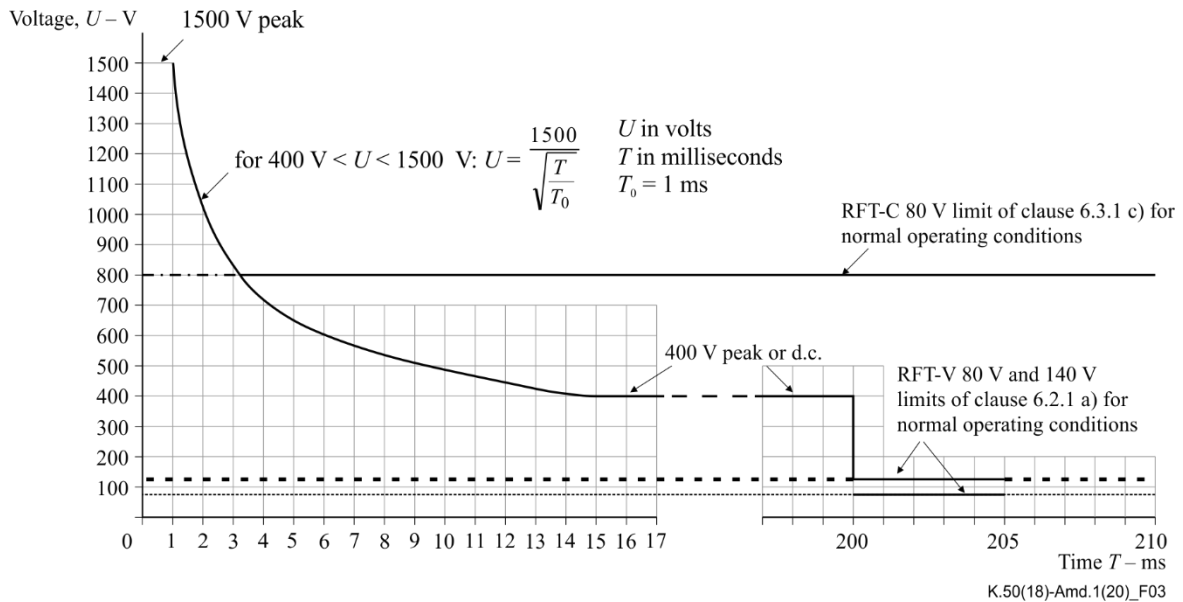

Figure 3 – Maximum RTF voltages permitted after a single fault
(After Figure 2F of [IEC 60950-1])

6.2.4 Installation instructions

For equipment using RFT-V circuits intended for interconnection with other equipment, the installation instructions shall specify all of the following:

- the effective capacitances of the equipment:
 - line to line between the connection terminals; and
 - line to earth between each connection terminal to earth;
- that a system assessment shall be carried out to ensure that the effective capacitances of the total system, including the capacitances of the equipment, do not exceed the values specified in Figure 4 (generally the capacitance of the cable can be neglected thus the total capacitance is equal to the sum of the PSE and PD effective capacitances);
- that the voltage rating of the telecommunication network must be adequate for the normal RFT-V circuit voltage, together with any superimposed transient;

NOTE 1 – Access network cabling and telecommunications cables suitable for plain old telephone service (POTS) are considered suitable for RFT-V. These cables often do not carry formal ratings, or

have a 300 V rating from a historical perspective, as ringing voltages can be up to 300V peak to peak. Because voltages above 280 V d.c. between conductors require a monitoring and control device, any breakdown or short between conductors does not create any additional safety hazard and only affects functionality. Verification of suitability of telecommunications cables and wiring is the responsibility of the telecommunications service provider.

- RFT-V rated circuit voltage; and
- RFT-V maximum voltage, which could be the RFT-V open circuit voltage or the RFT-V normal operating voltage.

NOTE 2 – Some RFT-V systems do not turn on at full voltage when an open circuit condition exists, thus the need for normal operation voltage if that is the case.

6.3 Method 2: Current-limited RFT (RFT-C) circuits

6.3.1 Limits under normal operating conditions

Under normal operating conditions, an RFT-C circuit shall comply with all of the following requirements:

- a) the steady-state current that can flow from the RFT-C circuit PSE into the telecommunication network shall not exceed 60 mA d.c. under any load condition;
- b) the steady-state current that can flow from one conductor of the RFT-C circuit PSE through the telecommunication network to earth shall not exceed 2 mA d.c;
- c) if the voltage rating of the wiring of the telecommunication network is specified, the supply voltage shall be limited to this value or to a maximum value of 1 500 V, whichever is lower;
or
if the voltage rating of the wiring of the telecommunication network is not specified, the supply voltage shall be limited to 800 V between conductors of the telecommunication network.

NOTE 1 – In practice the operating voltage of surge arrestors in the telecommunication network may limit the operating voltages to a lower clamped or switched voltage level.

NOTE 2 – RFT-C criteria are not intended to preclude the use of a single PSE with several individual 60 mA rated power sources, each of which feeds multiple telecommunications conductors and goes to a single or multiple remote PD load circuit, provided the PD prevents currents on other 60 mA powering pairs from being combined outside the PD equipment. It is also permissible to use multiple conductors to share the 60 mA from a PSE output to minimize I^2R cable losses.

Compliance is checked by inspection and measurement.

Clause 6.3.1 b) is checked by using a resistor of $(2\ 000 \pm 40)\ \Omega$.

6.3.2 Limits under single fault conditions

In the event of a single failure of insulation or of a component (excluding components with double or reinforced insulation) within RFT-C circuit PSE or PD hardware, or a failure of the insulation between one conductor of the telecommunication network and earth, the current in an RFT-C circuit shall not exceed the relevant limit given in Figure 4.

Compliance is checked by inspection and measurement while simulating failures of components and insulation such as are likely to occur in the equipment, and failure of insulation between each connection point for the telecommunication network and earth. A resistor of $(350 \pm 7)\ \Omega$ is used between conductors and $(2\ 000 \pm 40)\ \Omega$ is used between one conductor and earth. In Figure 4, the time is measured from the initiation of the failure.

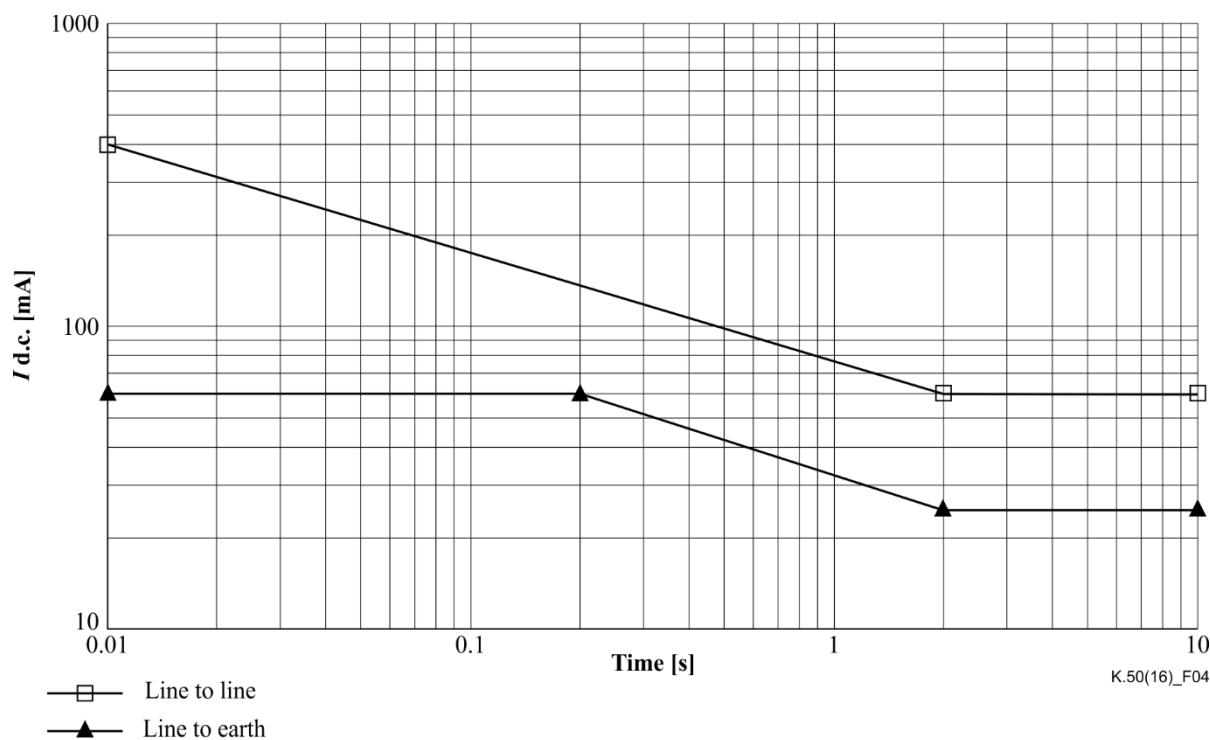

Figure 4 – Maximum current after a single fault

6.3.3 Limits with one conductor earthed

If one conductor of an RFT-C circuit that normally connects to a telecommunication network is earthed:

- the current from the other conductor to earth, under any external load condition, shall not exceed the relevant line-to-earth limit given in Figure 4; and
- the open circuit voltage to earth of the other conductor shall not exceed the maximum RFT-C circuit voltage determined in 6.2.1 c). The measurement is made after at least 2 s.

Compliance is checked by inspection and measurement. A resistor ($2\,000 \pm 40$) Ω is used between the other conductor and earth. The time is measured from the initiation of the contact of the conductor to earth.

NOTE – Unless the current limits in clauses 6.3.1, 6.3.2 and 6.3.3 are inherently met, the RFT-C circuit shall have a monitoring and control device (e.g., an RCD, balance control) that operates in such a way as to maintain the required current limits.

6.3.4 Installation instructions

For PSE and PD hardware using RFT-C circuits, the installation instructions shall specify all of the following:

- the effective capacitances of the PSE and PD hardware:
 - line to line between the connection terminals; and
 - line to earth between each connection terminal to earth.
- that a PSE/PD assessment should be carried out by the service provider to ensure the effective capacitances, does not exceed the values specified in Figure 5; (generally the capacitance of the cable can be neglected thus the total capacitance is equal to the sum of the PSE and PD effective capacitances);
- that the voltage rating of the telecommunication network must be adequate for the normal RFT-C circuit voltage, together with any superimposed transient; and
- RFT-C circuit voltage;

- RFT-C maximum or nominal continuous open circuit voltage, and maximum or nominal continuous normal operation circuit voltage, if it exceeds the open circuit voltage.

NOTE – Some RFT-C systems do not turn on at full voltage when open circuit conditions exist, thus the need for normal operation voltage if that is the case.

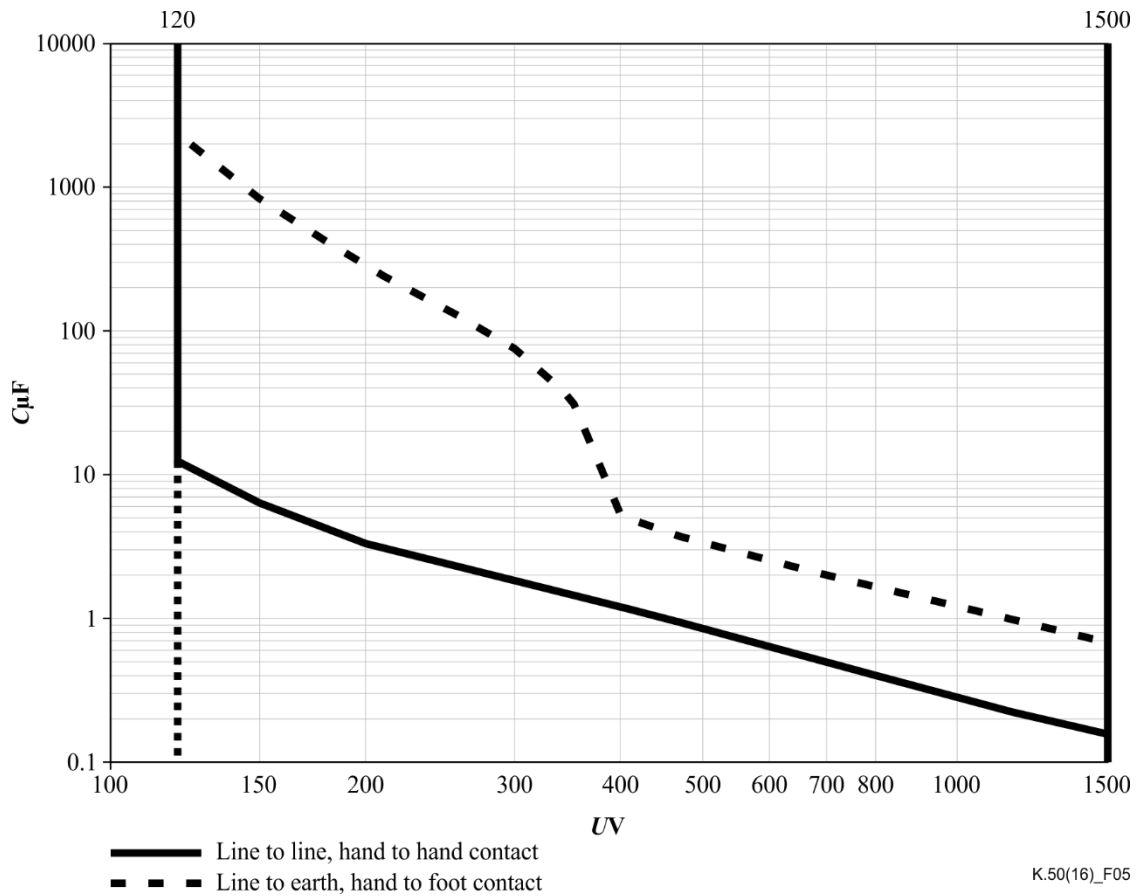

Figure 5 – RFT-C circuit capacitance limits

Previously capacitive discharge safety limits were specified as capacitance versus voltage value limits; however, the measurement of the capacitance value is difficult. For example, the remote powered equipment might have large capacitance values to maintain power during supply interruptions. Generally, the capacitance of the equipment is prevented from discharging into the telecommunications cable by use of a diode bridge. A capacitance meter might not cope with the non-linear diode bridge and provide a reading of the internal (but diode-isolated) capacitance value. In this and other cases, like RCD operation (see clause 6.2.1 a)), the appropriate method is to measure the charge delivered to a simulated body contact, as shown in Figures 6 and 7.

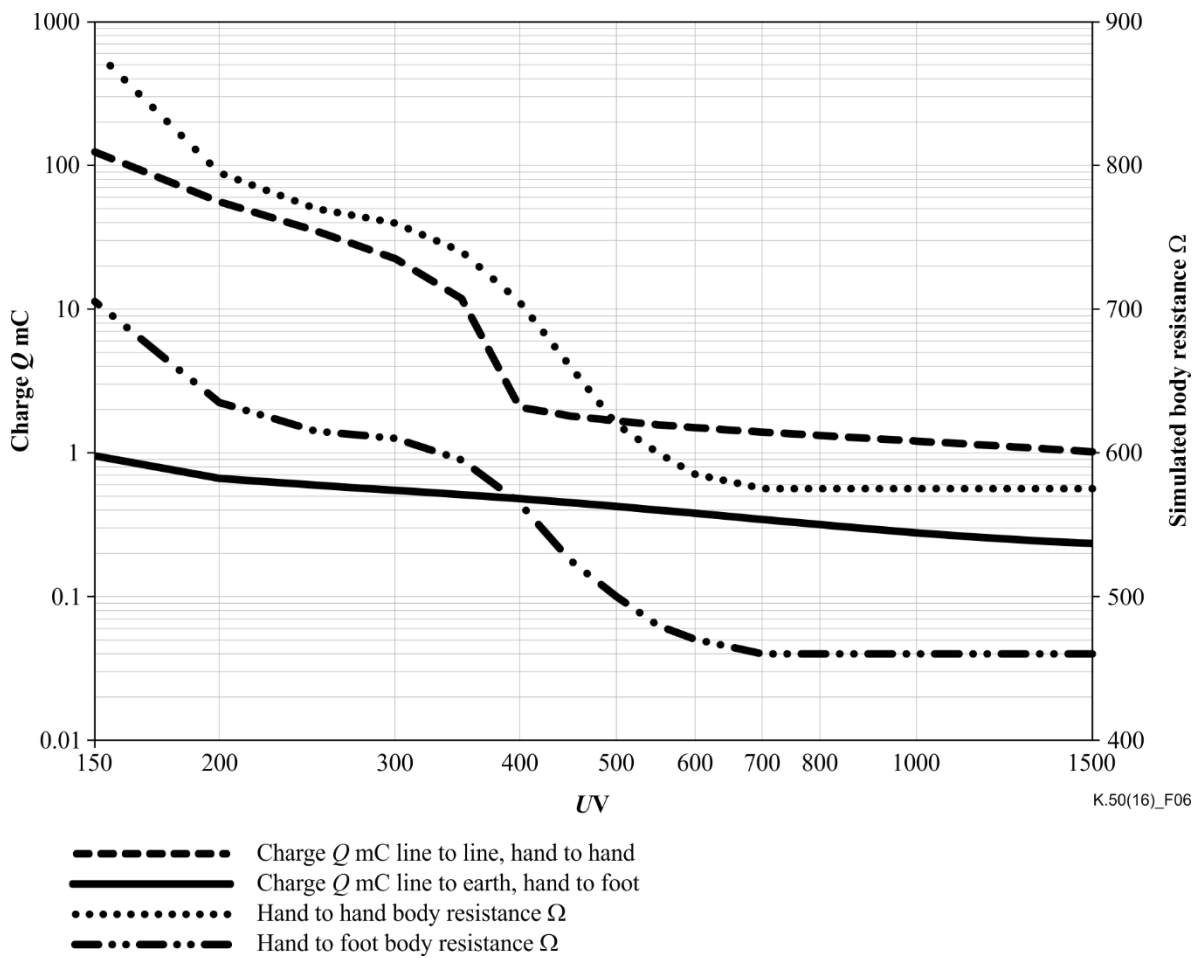

Figure 6 – Charge and body resistance versus touch voltage

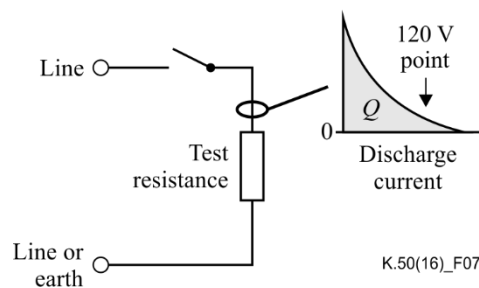

Figure 7 – Basic charge measuring circuit

Table 1 provides simplified values from Figure 6. Knowing the touch voltage, the appropriate values of line-to-earth and line-to-line test resistances can be selected. During the Figure 7 test, the charge in the test resistor is measured from the connection of the test resistor until the point when the discharge resistor voltage falls below 120 V.

Table 1 – Spot values from Figure 6

Touch voltage V	Line-to-line (hand-to-hand)		Line-to-earth (hand-to-foot)	
	Maximum charge mC	Test resistance Ω	Maximum charge mC	Test resistance Ω
1 500	1	600	0.23	500
1 200	1.1	600	0.25	500
1 000	1.2	600	0.28	500
700	1.4	600	0.34	500
500	1.7	600	0.42	500
400	2.1	700	0.48	600
300	22	750	0.55	600
200	56	800	0.66	600
150	125	900	0.95	700

6.3.5 Coordination with surge protective devices

Surge protective devices (SPDs) may be installed on pairs with RFT-V voltages. Characteristics of such SPDs can be found in [b-ITU-T K.12] and [b-ITU-T K.28].

When an SPD is activated, the RFT-V supply equipment may supply a current that prevents a switching SPD from resetting to its normal off-state after the transient condition has disappeared. This may occur for a longitudinally placed SPD or a differentially placed SPD.

Therefore RFT-V supply equipment shall appropriately control the supply current so that a switching SPD complying with [b-ITU-T K.12] and [b-ITU-T K.28] will automatically return to its high-impedance state after a transient condition has disappeared.

Likewise, RFT-C supply equipment shall appropriately control the supply current so that a switching SPD complying with [b-ITU-T K.12] and [b-ITU-T K.28] will automatically return to its high-impedance state after a transient condition has disappeared.

NOTE – The appropriate voltage/current levels that are suitable for switching-type SPDs using gas discharge tubes (GDTs) can be found in Tables 3 and 4 of [b-ITU-T K.12].

Likewise, for thyristor-type SPDs the same voltage/current levels can be found in Table 2 of [b-ITU-T K.28]. Table 1 provides the limits for available currents in these RFT circuits, therefore the minimum holding current of the SPDs are defined.

7 Work practices

7.1 General work practices

The RFT circuits have been defined so that the equipment and the current-carrying conductors can be accessed in the energized state by service and skilled personnel without de-energizing the circuits or using insulated gloves or tools. Therefore normal work practices are applicable for working on RFT circuits. When RFT circuits are used, it is recommended that service personnel be informed that RFT voltages and currents can be present on circuits in the network. For RFT-V circuits, service and skilled personnel should be advised of the shock hazard of hand-to-hand contact between conductors of opposite polarities as part of the training process, since low level current limitations between conductors are not present. Single handed work practices are highly recommended. For more information, please refer to [b-ITU-T K.64].

These requirements apply for all positions of the equipment when it is wired and operated as in normal use. Protection shall be achieved by insulation or by guarding or by the use of interlocks.

7.2 Special work practices

If service or skilled personnel working, for example, at the main distribution frame (MDF), can simultaneously contact several terminals that are connected to RFT-C circuits, these terminals shall be suitably labelled or appropriately marked to alert service personnel.

Appendix I

Specialized remote powering at TNV (ES1 & ES2) voltages

(This appendix does not form an integral part of this Recommendation.)

I.1 Introduction

Some telecommunications systems use d.c. voltage supplies of up to 60 V (TNV-1/ES1) and above 60 V to a maximum of 120 V (TNV-3/ES2) for specialised requirements. Maximum power levels are limited to the [IEC 60950-1] and [IEC 62368-1] levels of 15 W (PS1) or 100 W (PS2) with attendant safety requirements of maximum conductor current and hazard considerations.

I.2 Fibre to the distribution point, FTT(dp), reverse power feeding (RPF)

The reverse power feeding, (RPF), concept is for the subscriber to d.c. power that part of the fibre to the distribution point (FTT(dp)) distribution point unit (DPU) that provides that subscriber with an x-type digital subscriber line (xDSL) signal using the existing telecommunications cable to the customer premises. For cable lengths of up to 250 m the xDSL encoding is often G.fast and the maximum d.c. supply is 60 V (TNV-1/ES1) with maximum power levels of 15 W (PS1) or 100 W (PS2). For cable lengths over 250 m up to 1000 m the xDSL encoding is often VDSL 35b with the d.c. supply raised to a maximum of 120 V (TNV-3/ES2) with maximum power levels of 15 W (PS1) or 100 W (PS2).

Bibliography

- [b-ITU-T K.12] Recommendation ITU-T K.12 (2010), *Characteristics of gas discharge tubes for the protection of telecommunications installations.*
- [b-ITU-T K.28] Recommendation ITU-T K.28 (2012), *Parameters of thyristor-based surge protective devices for the protection of telecommunication installations.*
- [b-ITU-T K.51] Recommendation ITU-T K.51 (2016), *Safety criteria for telecommunication equipment.*
- [b-ITU-T K.64] Recommendation ITU-T K.64 (2016), *Safe working practices for outside equipment installed in particular environments.*
- [b-ITU-T, Directives] Directives ITU-T Volumes I-IX, *Directives concerning the protection of telecommunication lines against harmful effects from electric power and electrified railway lines.*
- [b-ITU-T, Directives Vol. VI] Directives ITU-T Volume VI (2008), *Directives concerning the protection of telecommunication lines against harmful effects from electric power and electrified railway lines – Volume VI: Danger, damage and disturbance*
- [b-ITU-T, Directives Vol. VII] Directives ITU-T Volume VII (1990), *Directives concerning the protection of telecommunication lines against harmful effects from electric power and electrified railway lines – Volume VII: Protective measures and safety precautions.*
- [b-ATIS 0600337] Alliance for Telecommunications Industry Solutions Standard ATIS 0600337 (2016), *Requirements for maximum voltage, current, and power levels used in communications transport circuits.*
- [b-CCITT, Volume VI] *Danger and disturbance, Directives of the CCITT, Volume VI, 1990.*
- [b-DIN VDE 0800-3] DIN VDE 0800-3 (2003-12): *Information Technology – Part 3: Safety of installations with remote power feeding.*
- [b-GR-1089] National Technical Systems (NTS) Standard GR-1089 (2011), *Electromagnetic compatibility and electrical safety – Generic criteria for network telecommunications equipment.*
- [b-IEC 60050-826] IEC 60050-826 (2004), *International Electrotechnical Vocabulary – Part 826: Electrical installations*
- [b-IEC TS 60479-1] IEC TS 60479-1 (2016), *Effects of current on human beings and livestock – Part 1: General aspects.*
- [b-IEC/TR 60664-2-1] IEC/TR 60664-2-1 (2011), *Insulation coordination for equipment within low-voltage systems – Part 2-1: Application guide – Explanation of the application of the IEC 60664 series, dimensioning examples and dielectric testing.*
- [b-IEC 60950-21] IEC 60950-21 (2002), *Information technology equipment – Safety – Part 21: Remote power feeding.*

[b-NFPA 70]

National Fire Protection Association Standard NFPA 70 (2017),
National Electric Code.

[b-UL 2391]

Underwriters Laboratories (UL) Standard UL 2391 (2002),
*Outline of investigation for equipment with remote feeding
telecommunication circuits intended for backwards
compatibility in legacy telecommunication equipment.*

SERIES OF ITU-T RECOMMENDATIONS

Series A	Organization of the work of ITU-T
Series D	Tariff and accounting principles and international telecommunication/ICT economic and policy issues
Series E	Overall network operation, telephone service, service operation and human factors
Series F	Non-telephone telecommunication services
Series G	Transmission systems and media, digital systems and networks
Series H	Audiovisual and multimedia systems
Series I	Integrated services digital network
Series J	Cable networks and transmission of television, sound programme and other multimedia signals
Series K	Protection against interference
Series L	Environment and ICTs, climate change, e-waste, energy efficiency; construction, installation and protection of cables and other elements of outside plant
Series M	Telecommunication management, including TMN and network maintenance
Series N	Maintenance: international sound programme and television transmission circuits
Series O	Specifications of measuring equipment
Series P	Telephone transmission quality, telephone installations, local line networks
Series Q	Switching and signalling, and associated measurements and tests
Series R	Telegraph transmission
Series S	Telegraph services terminal equipment
Series T	Terminals for telematic services
Series U	Telegraph switching
Series V	Data communication over the telephone network
Series X	Data networks, open system communications and security
Series Y	Global information infrastructure, Internet protocol aspects, next-generation networks, Internet of Things and smart cities
Series Z	Languages and general software aspects for telecommunication systems