

Digital Financial Services Security Clinic

Addressing security risks to digital finance ecosystem

Mobile Payment Application Security Tests

Arnold Kibuuka

Project Officer, TSB, ITU



Overview

1. USSD & STK App security tests
2. Android App security tests

USSD and STK App Security Tests

USSD and STK App Security Tests



a. **SIM Swap** and **SIM cloning**

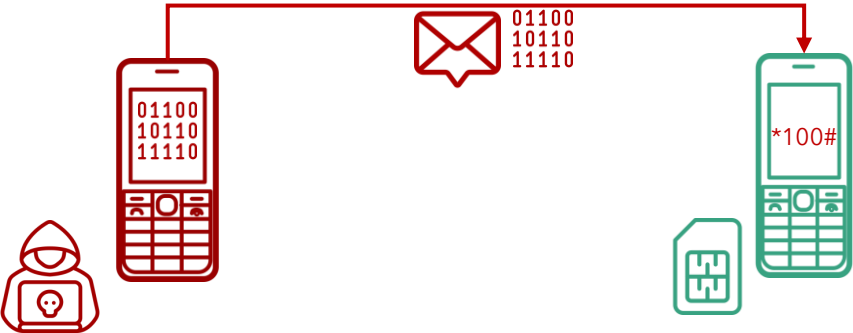

b. susceptibility to **binary OTA attacks**
(SIM jacker, WIB attacks)

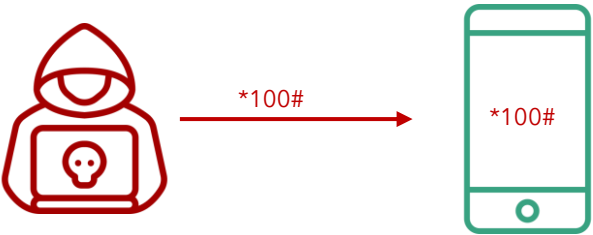

c. **remote USSD** execution attacks

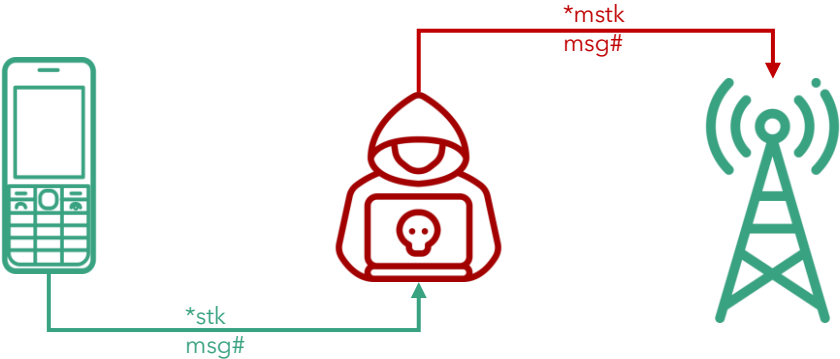

d. **man-in-the-middle attacks** on STK
based DFS applications

Man-in-the-Middle attacks on STK based DFS applications

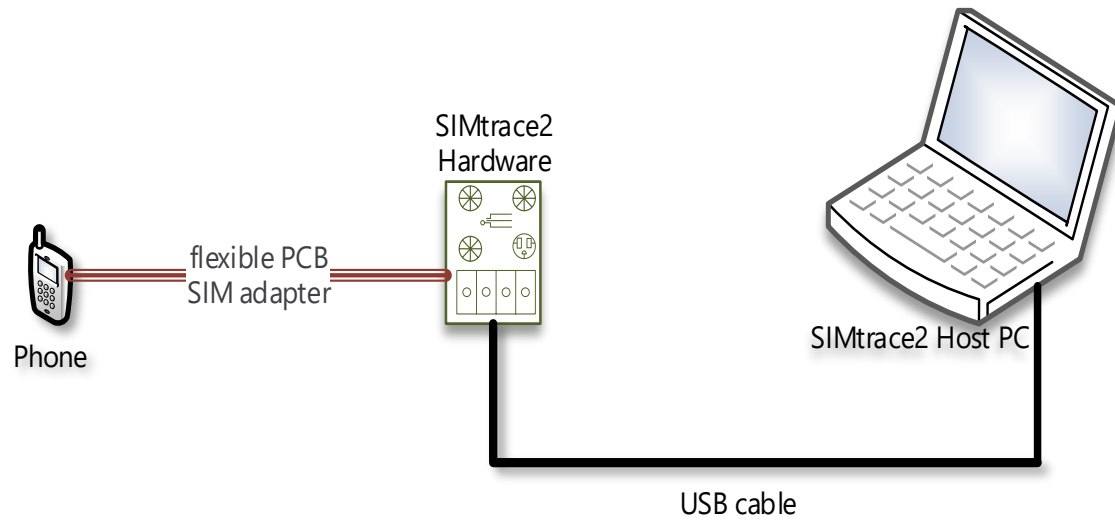

MiTM attack simulation on STK using a SIMtrace



Testing Man-in-the-Middle interception using SIMtrace

Man-in-the-Middle attacks on STK based DFS applications

```
405 125.... lo... lo... GSM ... 65 ETSI TS 102.221 STATUS : Terminal should repeat command, Leng... 38229 (38229),gsmtap (4729)
 54 32.8.... lo... lo... GSM ... 83 ETSI TS 102.221 TERMINAL PROFILE 38229 (38229),gsmtap (4729)
349 85.5.... lo... lo... GSM ... 77 ETSI TS 102.221 TERMINAL RESPONSE DISPLAY TEXT 38229 (38229),gsmtap (4729)
393 105.... lo... lo... GSM ... 77 ETSI TS 102.221 TERMINAL RESPONSE DISPLAY TEXT 38229 (38229),gsmtap (4729)
407 128.... lo... lo... GSM ... 77 ETSI TS 102.221 TERMINAL RESPONSE DISPLAY TEXT 38229 (38229),gsmtap (4729)
434 149.... lo... lo... GSM ... 77 ETSI TS 102.221 TERMINAL RESPONSE DISPLAY TEXT 38229 (38229),gsmtap (4729)
345 80.2.... lo... lo... GSM ... 84 ETSI TS 102.221 TERMINAL RESPONSE GET INPUT 38229 (38229),gsmtap (4729)
403 121.... lo... lo... GSM ... 84 ETSI TS 102.221 TERMINAL RESPONSE GET INPUT 38229 (38229),gsmtap (4729)
157 33.4.... lo... lo... GSM ... 81 ETSI TS 102.221 TERMINAL RESPONSE POLL INTERVAL 38229 (38229),gsmtap (4729)
351 86.0.... lo... lo... GSM ... 87 ETSI TS 102.221 TERMINAL RESPONSE PROVIDE LOCAL INFORMATION 38229 (38229),gsmtap (4729)
409 129.... lo... lo... GSM ... 87 ETSI TS 102.221 TERMINAL RESPONSE PROVIDE LOCAL INFORMATION 38229 (38229),gsmtap (4729)
332 62.8.... lo... lo... GSM ... 80 ETSI TS 102.221 TERMINAL RESPONSE SELECT ITEM 38229 (38229),gsmtap (4729)
336 65.0.... lo... lo... GSM ... 77 ETSI TS 102.221 TERMINAL RESPONSE SELECT ITEM 38229 (38229),gsmtap (4729)
338 68.3.... lo... lo... GSM ... 80 ETSI TS 102.221 TERMINAL RESPONSE SELECT ITEM 38229 (38229),gsmtap (4729)
340 71.5.... lo... lo... GSM ... 80 ETSI TS 102.221 TERMINAL RESPONSE SELECT ITEM 38229 (38229),gsmtap (4729)
396 111.... lo... lo... GSM ... 80 ETSI TS 102.221 TERMINAL RESPONSE SELECT ITEM 38229 (38229),gsmtap (4729)
401 116.... lo... lo... GSM ... 80 ETSI TS 102.221 TERMINAL RESPONSE SELECT ITEM 38229 (38229),gsmtap (4729)
370 89.9.... lo... lo... GSM ... 77 ETSI TS 102.221 TERMINAL RESPONSE SEND SHORT MESSAGE 38229 (38229),gsmtap (4729)
428 133.... lo... lo... GSM ... 77 ETSI TS 102.221 TERMINAL RESPONSE SEND SHORT MESSAGE 38229 (38229),gsmtap (4729)
121 33.2.... lo... lo... GSM ... 77 ETSI TS 102.221 TERMINAL RESPONSE SET UP EVENT LIST 38229 (38229),gsmtap (4729)

<
  Command details: 012304
    Command Number: 0x01
    Command Type: GET INPUT (0x23)
    Command Qualifier: 0x04
  Device identity: 8281
    Source Device ID: Terminal (Card Reader) (0x82)
    Destination Device ID: SIM / USIM / UICC (0x81)
  Result: 00
    Result: Command performed successfully (0x00)
  Text string: 0435343533
    Text String Encoding: GSM default alphabet, 8 bits (0x04)
    Text String: 5453
  Status Word: 911c Normal ... of command with info from proactive SIM
```

DFS PIN from captured data



Testing susceptibility to binary OTA attacks (SIMjacker, WIB attacks)

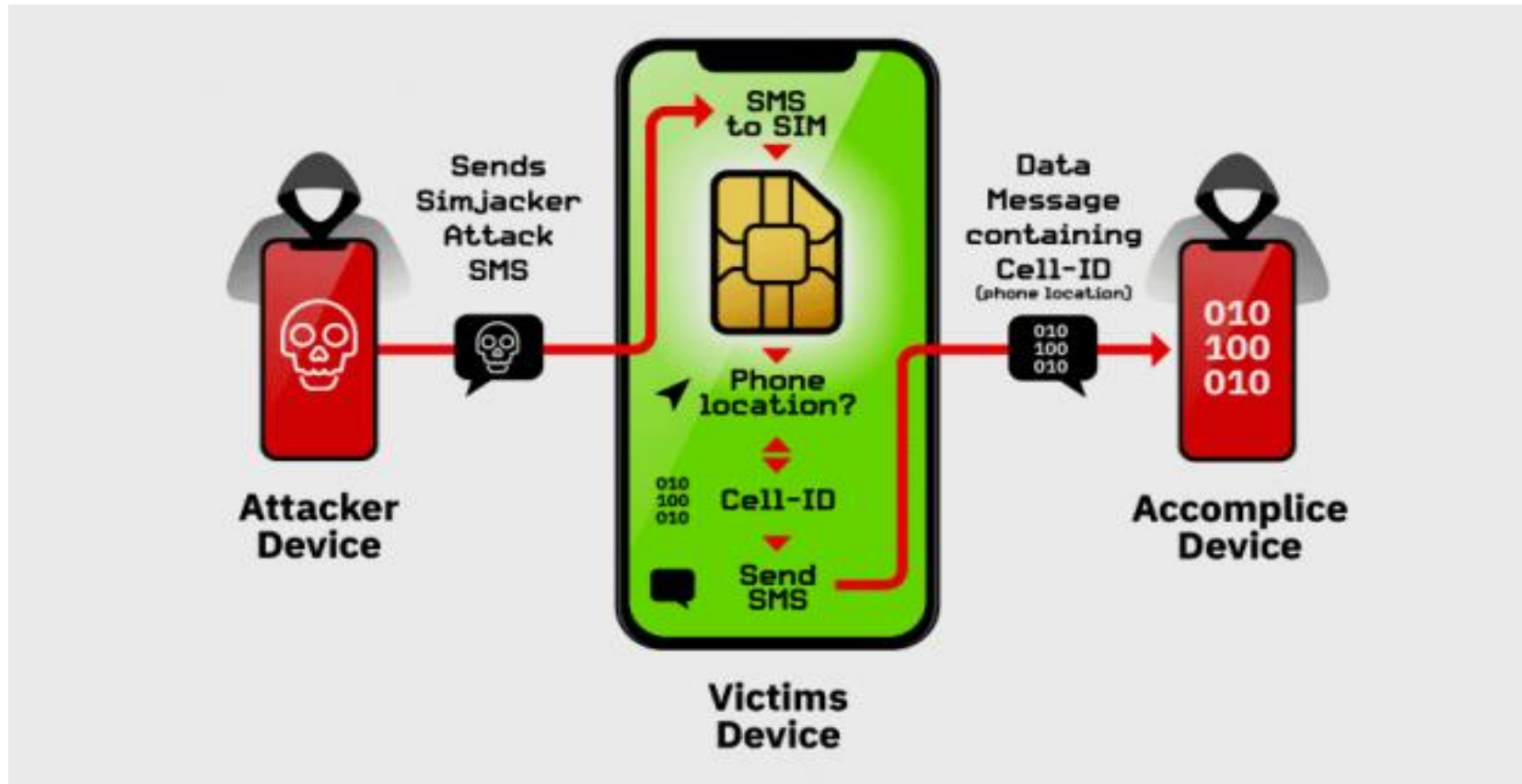

A binary OTA message can instruct the SIM to:

- initiate SS,
- Send SMS
- Initiate a phone call on a vulnerable SIM and will affect both USSD and STK apps.

(see [CVE-2019-16256](https://cve.mitre.org/cve/2019/16256))

Source: Adaptive Mobile

Testing remote USSD execution attacks

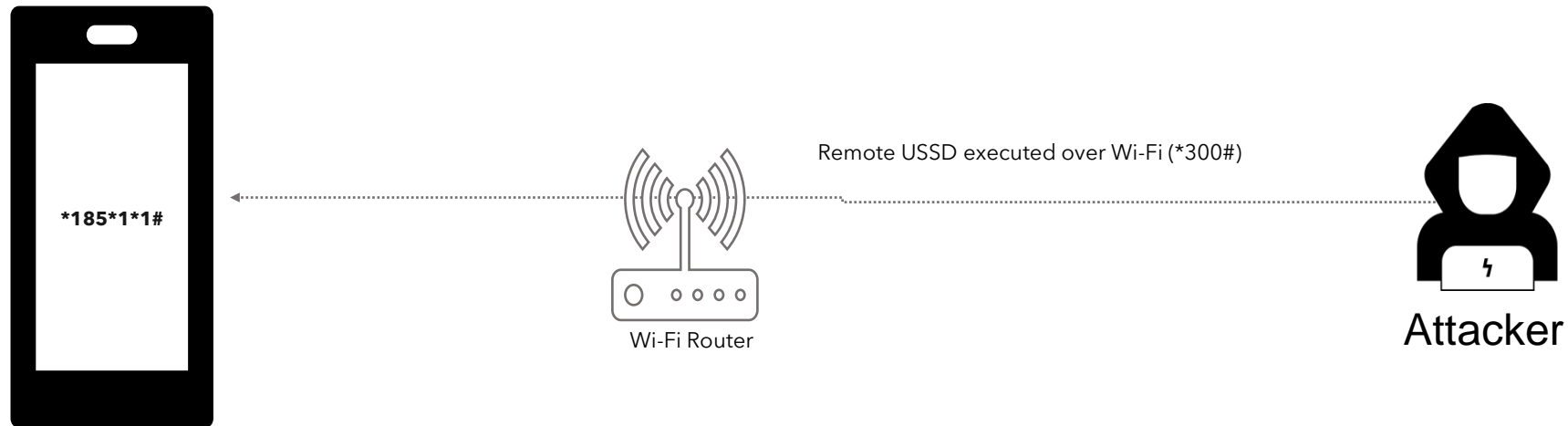

Setup for testing USSD remote attacks through open ADB ports

```
figisit@ubuntu: ~/LAB/platform-tools
figisit@ubuntu:~/LAB/platform-tools$ ./adb shell
HWEVA:/ $ am start -a android.intent.action.CALL -d tel:*185%23
Starting: Intent { act=android.intent.action.CALL dat=tel:xxxxx }
HWEVA:/ $ am start -a android.intent.action.CALL -d tel:*185*1*1%23
Starting: Intent { act=android.intent.action.CALL dat=tel:xxxxxxxxx }
HWEVA:/ $
```

USSD execution through a terminal for a device connected to Wi-Fi

Testing remote USSD execution attacks

SHODAN android debug bridge product:"Android Debug Bridge"

Exploits Maps Like 1 Download Results Create Report

TOTAL RESULTS
31,471

TOP COUNTRIES

Taiwan	7,611
Korea, Republic of	7,548
China	4,961
United States	2,864
Russian Federation	1,792

TOP ORGANIZATIONS

HiNet	5,568
Korea Telecom	4,805
SK Broadband	1,475
China Unicom FuJian	1,198
China Telecom jiangsu	300

TOP OPERATING SYSTEMS

Linux 3.x	99
Windows XP	44
FreeBSD 8.x-9.x	3
Windows 7 or 8	1

219.78.245.136
n219078245136.netvigator.com
Netvigator
Added on 2018-08-25 14:58:24 GMT
🇭🇰 Hong Kong, Kowloon
Details
scanner

Android Debug Bridge
Name: mars_a31s
Model: Q-BOX 02
Device: mars-a31s

211.193.83.5
Korea Telecom
Added on 2018-08-25 14:57:57 GMT
🇰🇷 Korea, Republic of, Changwon
Details

Android Debug Bridge
Name: ghost_retasia
Model: XT1052
Device: ghost

121.161.37.75
Korea Telecom
Added on 2018-08-25 14:57:27 GMT
🇰🇷 Korea, Republic of, Koyang
Details

Android Debug Bridge
Name: taimen
Model: PIXEL 2 XL
Device: taimen

62.152.25.229
cpe-405323.ip.primehome.com
Primetel PLC
Added on 2018-08-25 14:57:23 GMT
🇨🇾 Cyprus, Paphos
Details

Android Debug Bridge
Name: p212_8189
Model: p212_8189
Device: p212_8189

118.34.155.116
Korea Telecom
Added on 2018-08-25 14:57:20 GMT
🇰🇷 Korea, Republic of, Seoul
Details

Android Debug Bridge
Name: ghost_retasia
Model: XT1052
Device: ghost

Shodan report showing services with ADB open connected to the internet

adb can also be used to attack services on IoT devices

Recommendations

Remote USSD execution on devices

- Disable ADB
- User education
- Discourage use rooted devices

SIM exploitation using binary OTA

- Binary OTA SMS filtering & blocking.
- SMS home routing.
- SIM card security

Man-in-the-Middle attacks

- Use session timeout
- Secure radio channel communication
- SS7 controls and mitigations

SIM swap and SIM clone attacks

- SIM change detection. (ICCID, IMEI)
- Secure storage of SIM data like IMSI and secret key (KI values)

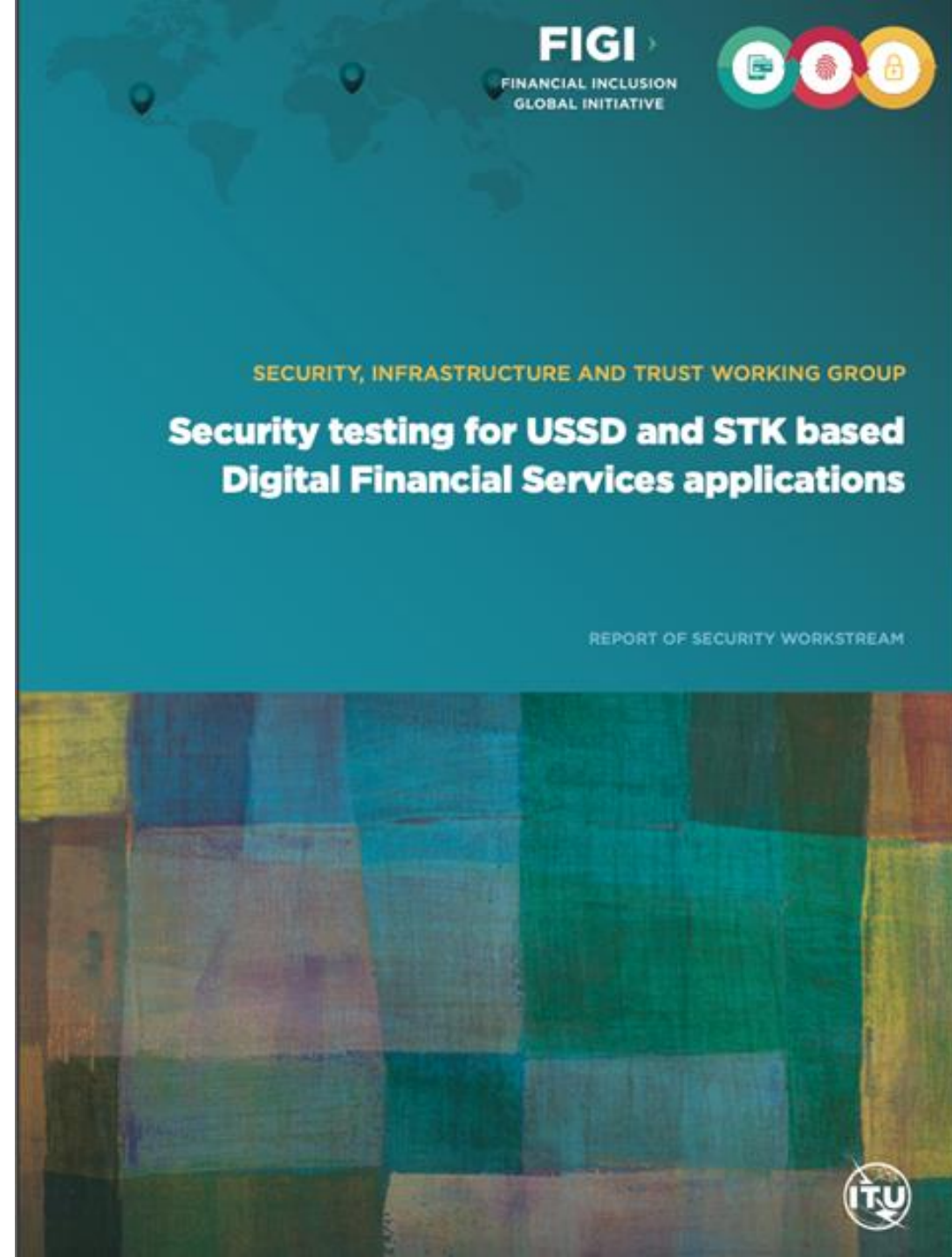

Hardware for security testing of USSD and STK based DFS

1. Laptop
2. Mobile Android smartphone, Samsung S4
3. Card reader
4. SIM card adapter
5. Mobile featurephone, Samsung 1200
6. Programmable/blank SIMs
7. SIMtrace microSIM & SIM (3FF) FPC Cab
8. SIMtrace2 Hardware Kit
9. Wi-Fi router - Synology RT2600AC



Software for USSD and STK based DFS security testing

- i. pySIM: - SIM cloning
- ii. SIMtrace: - Man-in-the-middle attacks
- iii. SIM tester: - Binary OTA attacks
- iv. ADB platform tools: - Remote USSD attack
- v. Wireshark: - STK analysis

Android App Security Tests

Introduction

The Open Web Application Security Project

A collaborative, non-for-profit foundation that works to improve the security of web applications

Also works on security of mobile applications.

OWASP Mobile Top Ten

OWASP project that aims to identify and document the top ten vulnerabilities of mobile applications

Lab methodology

18 tests organized according to OWASP mobile top ten

Android tests

- Our tests are organized according to the subjects of the OWASP Mobile Top Ten:
 - M1 Improper Platform Usage
 - M2 Insecure Data Storage
 - M3 Insecure Communication
 - M4 Insecure Authentication
 - M5 Insufficient Cryptography
 - M6 *Insecure Authorization*
 - M7 *Client Code Quality*
 - M8 Code Tampering
 - M9 Reverse Engineering
 - M10 *Extraneous Functionality*
- M6, M7, M10 out of scope because they would need access to the source code or require collaboration with the editor

M1 Improper Platform Usage

The application should make correct use of the features of the platform (phone's operating system)

T1.1 Android:allowBackup

- Backup of the application and its data into the cloud should be disabled

T1.2 Android:debuggable

- Debugging features of the application should be disabled

T1.3 Android:installLocation

- The application should be installed in the internal, more secure, memory

T1.4 Dangerous permissions

- The application should not require dangerous permissions, as defined by Android.

PERMISSION	STATUS	INFO	DESCRIPTION
android.permission.ACCESS_COARSE_LOCATION	dangerous	coarse (network-based) location	Access coarse location sources, such as the mobile network database, to determine an approximate phone location, where available. Malicious applications can use this to determine approximately where you are.
android.permission.ACCESS_FINE_LOCATION	dangerous	fine (GPS) location	Access fine location sources, such as the Global Positioning System on the phone, where available. Malicious applications can use this to determine where you are and may consume additional battery power.

M2 Insecure Data Storage

```
<uses-sdk android:minSdkVersion="16" android:targetSdkVersion="28" />
<uses-feature android:name="android.hardware.telephony" android:required="false" />
<uses-feature android:name="android.hardware.telephony.cdma" android:required="false" />
<uses-feature android:name="android.hardware.telephony.gsm" android:required="false" />
<uses-feature android:name="android.hardware.camera" android:required="false" />
<uses-feature android:name="android.hardware.camera.autofocus" android:required="false" />
<uses-feature android:name="android.hardware.camera.flash" android:required="false" />
<uses-feature android:name="android.hardware.camera.front" android:required="false" />
<uses-feature android:name="android.hardware.camera.any" android:required="false" />
<uses-feature android:name="android.hardware.bluetooth" android:required="false" />
<uses-feature android:name="android.hardware.location" android:required="false" />
<uses-feature android:name="android.hardware.location.network" android:required="false" />
<uses-feature android:name="android.hardware.location.gps" android:required="false" />
<uses-feature android:name="android.hardware.microphone" android:required="false" />
<uses-feature android:name="android.hardware.wifi" android:required="false" />
<uses-feature android:name="android.hardware.wifi.direct" android:required="false" />
<uses-feature android:name="android.hardware.screen.landscape" android:required="false" />
<uses-feature android:name="android.hardware.screen.portrait" android:required="false" />
<uses-feature android:glEsVersion="0x00020000" android:required="true" />
<uses-permission android:name="android.permission.INTERNET" />
<uses-permission android:name="android.permission.ACCESS_NETWORK_STATE" />
<uses-permission android:name="android.permission.ACCESS_WIFI_STATE" />
<uses-permission android:name="android.permission.VIBRATE" />
<uses-permission android:name="android.permission.WAKE_LOCK" />
<uses-permission android:name="android.permission.USE_FINGERPRINT" />
<uses-permission android:name="android.permission.ACCESS_FINE_LOCATION" />
<uses-permission android:name="android.permission.READ_PHONE_STATE" />
<uses-permission android:name="android.permission.READ_CONTACTS" />
<uses-permission android:name="android.permission.WRITE_CALENDAR" />
<uses-permission android:name="android.permission.CAMERA" />
<uses-permission android:name="android.permission.FLASHLIGHT" />
<uses-permission android:name="android.permission.WRITE_EXTERNAL_STORAGE" />
<supports-screens android:largeScreens="true" android:xlargeScreens="true" />
<uses-permission android:name="com.google.android.c2dm.permission.RECEIVE" />
```

Data should be stored in a way that limits the risks in case of loss or compromise of the phone

T2.1 Android.permission.WRITE_EXTERNAL_STORAGE

- No permission to write to a removable memory card

T2.2 Disabling screenshots

- If not disabled, screen shots are done automatically to generate thumbnails for task switching

M3 Insecure Communication

Protect against eavesdropping and manipulation of traffic

T3.1 Application should only use HTTPS connections

- Test by sniffing traffic

T3.2 Application should detect Machine-in-the-Middle attacks with untrusted Certificates

- Would allow anybody to intercept traffic
- Test by intercepting traffic with proxy

T3.3 Application should detect Machine-in-the-Middle attacks with trusted certificate

- Would allow authorities to intercept traffic
- Test by installing root certificate on phone, intercept with proxy

T3.4 App manifest should not allow clear text traffic

The screenshot displays the Burp Suite interface. The top menu includes 'Burp Project', 'Intruder', 'Repeater', 'Window', 'Help', 'Logger++', and 'Backslash'. Below the menu is a toolbar with various tools like 'Errors', 'Espresso', 'ExFTool', 'JSON Beautifier', 'Deserialization Scanner', 'Logger++', 'Paramalyzer', 'Versions', 'Software Vulnerability Scanner', and 'Additional Scanner Checks'. The main area shows a list of intercepted items with columns for '#', 'Host', 'Method', 'URL', 'Params', 'Edited', 'Status', 'Length', 'MIME type', 'Extension', 'Title', 'Comment', 'TLS', 'IP', 'Cookies', and 'Time'. A row is highlighted in orange, corresponding to a POST request to '/smartphone/service/v11/orders/p2p/send'. Below this, the 'Request' and 'Response' tabs are visible, with the 'Request' tab selected, showing the raw HTTP request details.

```
1 POST /smartphone/service/v11/orders/p2p/send HTTP/1.1
2 Accept-Encoding: gzip, deflate
3 Accept: application/json
4 Accept-Language: fr_CH
5 X-TWINT-WALLETAPP-LIB-VERSION: 15.3.0.18
6 Cookie: NavajonUNBjXYu02vvy2A1NYol+qgo/M3ThiBT8PhA94426Do/24f5NEDKahF2VohHy0z2NKx2UzUv0g-
7 Content-Type: application/json; charset=UTF-8
8 Content-Length: 764
9 Host: [REDACTED]
10 Connection: close
11 User-Agent: okhttp/3.12.0
12 ADDRUM_1: isMobile:true
13 ADDRUM: isAjax:true
14
15 {
  "amount": {
    "amount": 20,
    "currency": "CHF"
  },
  "certificateFingerprint": "ef[REDACTED]417b",
  "moneyReceiver": {
    "firstName": [REDACTED],
    "lastName": [REDACTED]
  },
  "moneyReceiverMobileNumber": "+4179[REDACTED]",
  "moneySender": {
    "firstName": [REDACTED],
    "lastName": [REDACTED]
  },
  "orderId": "13976b6e-a57c-448a-8535-51d97f01928d",
  "reservationDate": "2020-07-10T08:55:12",
  "sendMoneyEvenIfCustomerUnknown": true,
  "signature": "gqiDEx3p0x+0c6vQm0U4MmYqyb+R1HTe8124jHGou1/Jx81IW1m6W64058oJnnD8H9A:ld0mme61/bZE5J0EP3ERXR/2kfrAreQNhED0Uc18mJFxx91At3HEe3J6yHehB0q29zTKgUMZw0u8a3tzJNRpvRzic0QCx5X78Ih26A104KD047uFmKEP7Hc"
}
```

Burp Project Intruder Repeater Window Help Logger++ Backslas...

Errors EsPReSSO ExifTool JSON Beautifier Deserialization Scanner Logger++ Paramalyzer Versions Software Vulnerability Scanner Additional Scanner Checks
 Dashboard Target Proxy Intruder Repeater Sequencer Decoder Comparer Extender Project options User options AuthMatrix Bypass WAF CO2

Intercept HTTP history WebSockets history Options

Filter: Hiding out of scope items

#	Host	Method	URL	Params	Edited	Status	Length	MIME type	Extension	Title	Comment	TLS	IP	Cookies	Time
148	https://[REDACTED]	GET	/iizwlm?_=1594371899392		✓	200	491	JSON				✓	[REDACTED]		11:04:55
145	https://[REDACTED]	GET	/iizwlm?_=1594371717242		✓	200	491	JSON				✓	[REDACTED]		11:01:55
144	https://[REDACTED]	GET	/iizwlm?_=1594371530169		✓	200	491	JSON				✓	[REDACTED]		10:58:40
141	https://[REDACTED]	GET	/P2PPaymentSystem/P2PInterfaceP2PLogin/V4_...		✓	200	576	JSON				✓	[REDACTED]		10:55:40
139	https://[REDACTED]	POST	/smartphone/service/v11/privateCustomers/me...		✓	200	1480	JSON				✓	[REDACTED]		10:55:20
138	https://[REDACTED]	GET	/smartphone/service/v11/privateCustomers/me...		✓	200	870	JSON				✓	[REDACTED]		10:55:20
137	https://[REDACTED]	POST	/P2PPaymentSystem/P2PInterfaceP2PLogin/V4_...		✓	200	805	JSON				✓	[REDACTED]		10:55:10
136	https://[REDACTED]	POST	/smartphone/service/v11/orders/p2p/send		✓	200	777	JSON				✓	[REDACTED]		10:55:00
135	https://[REDACTED]	GET	/P2PPaymentSystem/P2PInterfaceP2PLogin/V4_...		✓	200	576	JSON				✓	[REDACTED]		10:55:00
134	https://[REDACTED]	GET	/P2PPaymentSystem/P2PInterfaceP2PLogin/V4_...		✓	200	576	JSON				✓	[REDACTED]		10:54:40
133	https://[REDACTED]	GET	/P2PPaymentSystem/P2PInterfaceP2PLogin/V4_...		✓	200	576	JSON				✓	[REDACTED]		10:54:10
132	https://[REDACTED]	GET	/smartphone/service/v11/orders?limit=100&pa...		✓	200	18539	JSON				✓	[REDACTED]		10:53:40
131	https://[REDACTED]	POST	/smartphone/service/v11/privateCustomers/me...		✓	200	1480	JSON				✓	[REDACTED]		10:53:40
130	https://[REDACTED]	GET	/smartphone/service/v11/privateCustomers/me...		✓	200	870	JSON				✓	[REDACTED]		10:53:40
129	https://[REDACTED]	GET	/smartphone/service/v11/orders?since=1970-0...		✓	200	50014	JSON				✓	[REDACTED]		10:53:40
128	https://[REDACTED]	POST	/P2PPaymentSystem/P2PInterfaceP2PLogin/V4_...		✓	200	1340	JSON				✓	[REDACTED]		10:53:40

Request Response

Raw Params Headers Hex JSON JSON Beautifier

```

1 POST /smartphone/service/v11/orders/p2p/send HTTP/1.1
2 Accept-Encoding: gzip, deflate
3 Accept: application/json
4 Accept-Language: fr_CH
5 X-TWINT-WALLETAPP-LIB-VERSION: 15.3.0.18
6 Cookie: Navajo=UNBjXYuG2vyu2A3NYol+qgo/M3ThiBT8PhA944Z6Do/24f5NEDkkahF2VEohHy0zNKx2UuZivUg-
7 Content-Type: application/json; charset=UTF-8
8 Content-Length: 764
9 Host: [REDACTED]
10 Connection: close
11 User-Agent: okhttp/3.12.0
12 ADRUM_1: isMobile:true
13 ADRUM: isAjax:true
14
15 {
  "amount": {
    "amount": 20,
    "currency": "CHF"
  },
  "certificateFingerprint": "ef[REDACTED]417b",
  "moneyReceiver": {
    "firstName": [REDACTED],
    "lastName": [REDACTED]
  },
  "moneyReceiverMobileNumber": "+4179[REDACTED]",
  "moneySender": {
    "firstName": [REDACTED],
    "lastName": [REDACTED]
  },
  "orderId": "13976b6e-a57c-448a-8535-51d97f01928d",
  "reservationDate": "2020-07-10T08:55:12",
  "sendMoneyEvenIfCustomerUnknown": true,
  "signature": "gu2DEXJ5pqGx+0c6vQm0cU04MmYqyb+RIHT8iZ4jHGcul/Jx8iIwV1m6WU64G58oJnnEGH8WArldOmmc61/bZEjOEF3fRXR/2kffAreQNhE01Uc18sJFxx96iAt3Hfe336yHehB0qZ9zTKgtMZwGu8s3tzJNRpvrSzio2QCk5X7SIh26Ai04KD047uFmKEPTh
  }
  
```

M4 Insecure Authentication

Prevent unauthorized access to the application

T4.1 Authentication required before accessing sensitive information

- Application must require PIN or fingerprint

T4.2 The application should have an inactivity timeout

T4.3 If a new fingerprint is added, authentication with fingerprints should be temporarily disabled

- User should provide PIN to enable fingerprints again
- Prevents attacks where an attacker adds their fingerprint to access the application

T4.4 It should not be possible to replay intercepted requests (e.g. a money transfer)

- An attacker intercepting a request for a money transfer could replay it to steal money from the victim.

M5: Insufficient Cryptography

```
..  
"moneyReceiverMobileNumber": "+4179 [REDACTED]  
"moneySender": {  
  "firstName": [REDACTED]  
  "lastName": [REDACTED]  
},
```

Cryptography can only protect confidentiality and integrity of data if correctly implemented

```
112. }  
113.  
114. @TargetApi(8)  
115. public static File b(Context context) {  
116.     if (bl.a()) {  
117.         return context.getExternalCacheDir();  
118.     }  
119.     return new File(Environment.getExternalStorageDirectory().getPath() + "  
120. }  
121.  
122. public static String b(String str) {  
123.     try {  
124.         MessageDigest instance = MessageDigest.getInstance("SHA-1");  
125.         instance.update(str.getBytes());  
126.         return a(instance.digest());  
127.     } catch (NoSuchAlgorithmException unused) {  
128.         return String.valueOf(str.hashCode());  
129.     }  
130. }  
131.  
132. @TargetApi(9)  
133. public static boolean b() {  
134.     if (bl.b()) {  
135.         return Environment.isExternalStorageRemovable();  
136.     }  
137. }
```

T5.1 The app should not use unsafe crypto primitives

- E.g., MD5, SHA-1, RC4, DES, 3DES, Blowfish, ECB
- Search for these in the code
- Detection of these primitives does not imply that they are used for protecting critical information!

T5.2 The HTTPS connections should be configured according to best practices

- Watch where the app connects to, use Qualys SSL labs to evaluate configuration, expect a grade of B or more

M8: Code Tampering

Prevent an attacker from tampering the code on the telephone

T8.1 The application should refuse to run on a rooted device

- On a rooted device, users can manipulate the code of the application

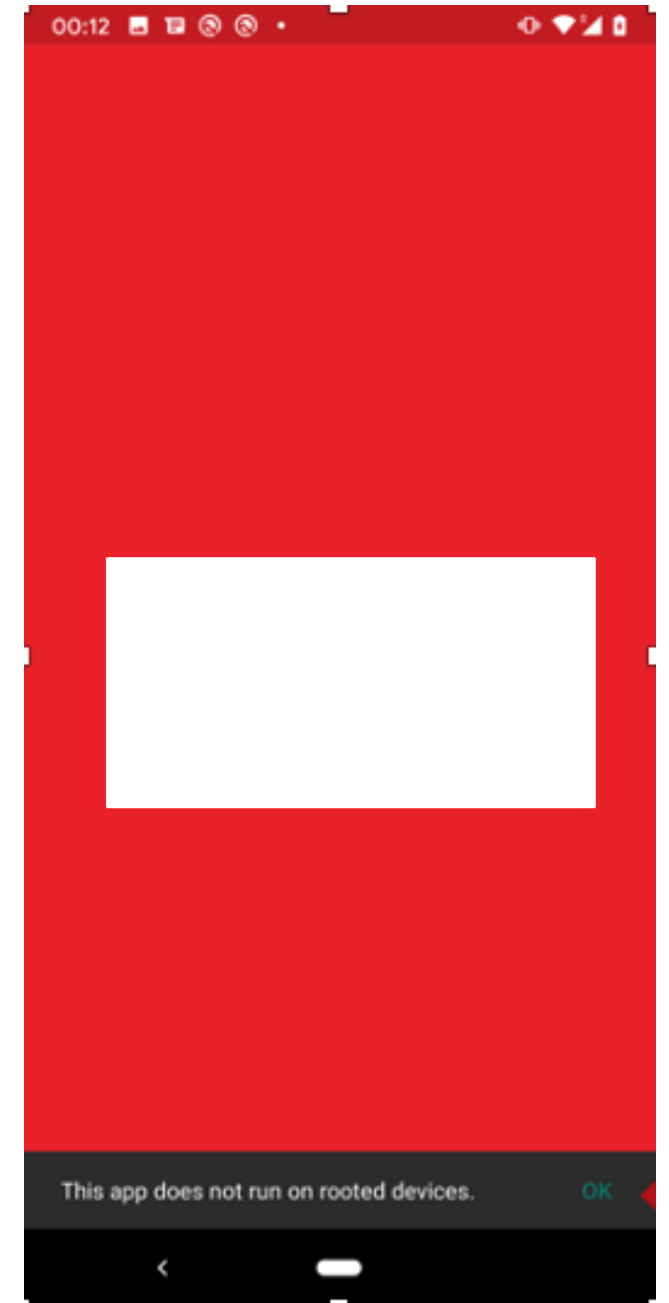

M9 Reverse engineering

```
125.         instance.update(str.getBytes());
126.         return a(instance.digest());
127.     } catch (NoSuchAlgorithmException unused) {
128.         return String.valueOf(str.hashCode());
129.     }
130. }
131.
132. @TargetApi(9)
133. public static boolean b() {
134.     if (bl.b()) {
135.         return Environment.isExternalStorageRemovable();
136.     }
137.     return true;
138. }
139.
140. public Bitmap a(String str) {
141.     dt<String, Bitmap> dtVar = this.d;
142.     if (dtVar != null) {
143.         return dtVar.a(str);
144.     }
145.     return null;
146. }
147.
148. public void a() {
149.     synchronized (this.g) {
150.         if (this.c == null || this.c.a()) {
151.             File file = this.f.c;
152.             if (this.f.g && file != null) {
153.                 if (!file.exists()) {
154.                     file.mkdirs();
155.                 }
156.             }
157.         }
158.     }
159. }
```

Prevent attackers from analyzing the logic of the application

T9.1 The code should be obfuscated

- When the code is obfuscated, it is much more difficult to understand the logic of the code
- This makes it more difficult to manipulate the code or to find potential vulnerabilities
- Decompile the code and assess its readability

Android apps tests summary

Best practices	Corresponding tests
9.1 Device integrity	T1.2 Android:debuggable T1.4 Dangerous permissions T8.1 The application should refuse to run on a rooted device
9.2 Communication Security and Certificate Handling	T3.1 Application should only use HTTPS connections T3.2 Application should detect Machine-in-the-Middle attacks with untrusted certificates T3.3 Application should detect Machine-in-the-Middle attacks with trusted certificates T3.4 App manifest should not allow clear text traffic T5.1 The app should not use unsafe crypto primitives T5.2 The HTTPS connections should be configured according to best practices T5.3 The app should encrypt sensitive data that is sent over HTTPS
9.3 User authentication	T4.1 Authentication required before accessing sensitive information T4.2 The application should have an inactivity timeout T4.3 If a fingerprint is added, authentication with fingerprints should be disabled T4.4 It should not be possible to replay intercepted requests
9.4 Secure Data Handling	T1.1 Android:allowBackup T1.3 Android:installLocation T2.1 Android.permission.WRITE_EXTERNAL_STORAGE T2.2 Disabling screenshots
9.5 Secure Application Development	T9.1 The code of the app should be obfuscated

What ITU needs to test DFS applications



USSD and STK Tests

- 2 SIM cards of the networks to be tested.
- Active DFS account on each SIM card.
- DFS Wallet PINs
- Prepaid mobile credit on SIM cards – SIM cards must have mobile roaming enabled for Switzerland
- Include USSD codes for each of the DFS providers.
- DFS Credit on DFS Wallets (approximately \$10 to be used for testing)

Android application tests

in addition to the above requirements, Android apps (apk file) must be shared, or links to download the apps from the Play Store.



Questions

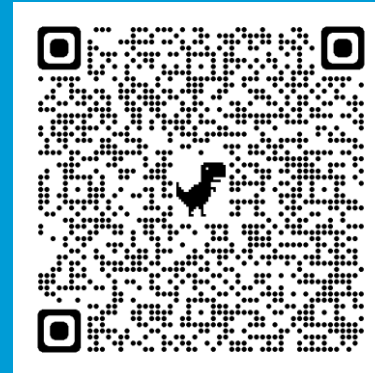

Contact: dfssecuritylab@itu.int

<https://figi.itu.int/figi-resources/dfs-security-lab/>





www.itu.int