



Recommendation ITU-R M.2012-4
(11/2019)

**Detailed specifications of the terrestrial
radio interfaces of International
Mobile Telecommunications-Advanced
(IMT-Advanced)**

M Series
**Mobile, radiodetermination, amateur
and related satellite services**

Foreword

The role of the Radiocommunication Sector is to ensure the rational, equitable, efficient and economical use of the radio-frequency spectrum by all radiocommunication services, including satellite services, and carry out studies without limit of frequency range on the basis of which Recommendations are adopted.

The regulatory and policy functions of the Radiocommunication Sector are performed by World and Regional Radiocommunication Conferences and Radiocommunication Assemblies supported by Study Groups.

Policy on Intellectual Property Right (IPR)

ITU-R policy on IPR is described in the Common Patent Policy for ITU-T/ITU-R/ISO/IEC referenced in Resolution ITU-R 1. Forms to be used for the submission of patent statements and licensing declarations by patent holders are available from <http://www.itu.int/ITU-R/go/patents/en> where the Guidelines for Implementation of the Common Patent Policy for ITU-T/ITU-R/ISO/IEC and the ITU-R patent information database can also be found.

Series of ITU-R Recommendations

(Also available online at <http://www.itu.int/publ/R-REC/en>)

Series	Title
BO	Satellite delivery
BR	Recording for production, archival and play-out; film for television
BS	Broadcasting service (sound)
BT	Broadcasting service (television)
F	Fixed service
M	Mobile, radiodetermination, amateur and related satellite services
P	Radiowave propagation
RA	Radio astronomy
RS	Remote sensing systems
S	Fixed-satellite service
SA	Space applications and meteorology
SF	Frequency sharing and coordination between fixed-satellite and fixed service systems
SM	Spectrum management
SNG	Satellite news gathering
TF	Time signals and frequency standards emissions
V	Vocabulary and related subjects

Note: This ITU-R Recommendation was approved in English under the procedure detailed in Resolution ITU-R 1.

Electronic Publication
Geneva, 2019

© ITU 2019

All rights reserved. No part of this publication may be reproduced, by any means whatsoever, without written permission of ITU.

RECOMMENDATION ITU-R M.2012-4

Detailed specifications of the terrestrial radio interfaces of International Mobile Telecommunications-Advanced (IMT-Advanced)

(2012-2014-2015-2017-2019)

Scope

This Recommendation identifies the terrestrial radio interface technologies of International Mobile Telecommunications-Advanced (IMT-Advanced) and provides the detailed radio interface specifications.

These radio interface specifications detail the features and parameters of IMT-Advanced. This Recommendation includes the capability to ensure worldwide compatibility, international roaming, and access to high-speed data services.

Keywords

IMT, IMT-Advanced, LTE-Advanced, LTE-Advanced Pro, WirelessMAN-Advanced, radio interface specifications

Related ITU-R Recommendations, Reports and Resolutions¹

Recommendation ITU-R M.1036	Frequency arrangements for implementation of the terrestrial component of International Mobile Telecommunications (IMT) in the bands identified for IMT in the Radio Regulations (RR)
Recommendation ITU-R M.1224	Vocabulary of Terms for International Mobile Telecommunications (IMT)
Recommendation ITU-R M.1579	Global circulation of IMT terrestrial terminals
Recommendation ITU-R M.1645	Framework and overall objectives of the future development of IMT-2000 and systems beyond IMT-2000
Recommendation ITU-R M.1822	Framework for services supported by IMT
Recommendation ITU-R M.2047	Detailed specifications of the satellite radio interface of International Mobile Telecommunications-Advanced (IMT-Advanced)
Recommendation ITU-R M.2070	Generic unwanted emission characteristics of base stations using the terrestrial radio interfaces of IMT-Advanced
Recommendation ITU-R M.2071	Generic unwanted emission characteristics of mobile stations using the terrestrial radio interfaces of IMT-Advanced
Recommendation ITU-R M.2090	Specific unwanted emission limit of IMT mobile stations operating in the frequency band 694-790 MHz to facilitate protection of existing services in Region 1 in the frequency band 470-694 MHz
Report ITU-R M.2072	World mobile telecommunication market forecast

¹ The latest edition of the Recommendation/Reports in force should be used.

Report ITU-R M.2074	Radio aspects for the terrestrial component of IMT-2000 and systems beyond IMT-2000
Report ITU-R M.2133	Requirements, evaluation criteria and submission templates for the development of IMT-Advanced
Report ITU-R M.2134	Requirements related to technical performance for IMT-Advanced radio interface(s)
Report ITU-R M.2135	Guidelines for evaluation of radio interface technologies for IMT-Advanced
Report ITU-R M.2198	The outcome of the evaluation, consensus building and decision of the IMT-Advanced process (steps 4-7), including characteristics of IMT-Advanced radio interfaces
Report ITU-R M.2291	The use of International Mobile Telecommunications for the broadband public protection and disaster relief applications
Report ITU-R M.2320	Future technology trends of terrestrial IMT systems
Report ITU-R M.2334	Passive and active antenna systems for base stations of IMT systems
Report ITU-R M.2370	IMT traffic estimates for the years 2020 to 2030
Report ITU-R M.2373	Audio-visual capabilities and applications supported by terrestrial IMT systems
Report ITU-R M.2375	Architecture and topology of IMT networks
Resolution ITU-R 56	Naming for International Mobile Telecommunications
Resolution ITU-R 57	Principles for the process of development of IMT-Advanced
Handbook on Global Trends in International Mobile Telecommunication.	

The ITU Radiocommunication Assembly,

considering

- a) that IMT systems are mobile broadband systems including IMT-2000, IMT-Advanced and IMT-2020;
- b) that IMT-Advanced systems include the new capabilities of IMT that go beyond those of IMT-2000²;
- c) that such systems provide access to a wide range of telecommunication services including advanced mobile services, supported by mobile and fixed networks, which are increasingly packet-based;
- d) that IMT-Advanced systems support low to high mobility applications and a wide range of data rates in accordance with user and service demands in multiple user environments;

² Recommendations ITU-R M.1457 and ITU-R M.2012 are two separate, independent, and self-contained Recommendations, each one with a specific scope. Both Recommendations will evolve independently, and there could be some overlap reflected by commonality in content between the two documents.

- e) that IMT-Advanced also has capabilities for high-quality multimedia applications within a wide range of services and platforms providing a significant improvement in performance and quality of service;
- f) that the key features of IMT-Advanced are:
- a high degree of commonality of functionality worldwide while retaining the flexibility to support a wide range of services and applications in a cost-efficient manner;
 - compatibility of services within IMT and with fixed networks;
 - capability of interworking with other radio access systems;
 - high-quality mobile services;
 - user equipment suitable for worldwide use;
 - user-friendly applications, services and equipment;
 - worldwide roaming capability;
 - enhanced peak data rates to support advanced services and applications (100 Mbit/s for high and 1 Gbit/s for low mobility were established as targets for research)³;
- g) that these features enable IMT-Advanced to address evolving user needs;
- h) that the capabilities of IMT-Advanced systems are being continuously enhanced in line with technology developments;
- i) the necessity of priority services (e.g. emergency calls shall be supported as higher priority than other commercial services);
- j) that due to the large effective bandwidths required to support the very high data rates needed for the various services offered, allowances must be made for either much larger single carrier bandwidths (even as spectral efficiencies increase) or aggregation of RF carriers;
- k) that the rapid development of information technology, including the Internet, has resulted in the aggregation and convergence of various networks and digital devices,

further considering

that Resolution ITU-R 57-2 on the “Principles for the process of development of IMT-Advanced” outlines the essential criteria and principles used in the process of developing the Recommendations and Reports for IMT-Advanced, including Recommendation(s) for the radio interface specification,

noting

that Report ITU-R M.2198 contains the outcome and conclusions of Steps 4 through 7 of the IMT-Advanced process, including the evaluation and consensus building, and provides the characteristics of the IMT-Advanced terrestrial radio interfaces for the first release of Recommendation ITU-R M.2012-0 (01-2012),

recommends

- 1** that the terrestrial radio interfaces for IMT-Advanced should be:
- “LTE-Advanced”⁴; and

³ Data rates sourced from Recommendation ITU-R M.1645.

⁴ Developed by 3GPP as LTE Release 10 and Beyond (Long Term Evolution-Advanced).

– “WirelessMAN-Advanced”⁵;

2 that the information provided or referenced in Annexes 1 and 2 should be used according to the terrestrial radio interfaces referred to in *recommends* 1 above as the complete set of standards for the detailed specifications of the terrestrial radio interfaces of IMT-Advanced.

Annex 1

Specification of the LTE-Advanced radio interface technology

Background

IMT-Advanced is a system with global development activity and the IMT-Advanced terrestrial radio interface specifications identified in this Recommendation have been developed by the ITU in collaboration with the GCS⁶ Proponents and the Transposing Organizations. It is noted from Document IMT-ADV/24(Rev.3), that:

- The GCS Proponent must be one of the RIT⁷/SRIT⁸ Proponents for the relevant technology, and must have legal authority to grant to ITU-R the relevant legal usage rights to the relevant specifications provided within a GCS corresponding to a technology in Recommendation ITU-R M.2012.
- A Transposing Organization must have been authorized by the relevant GCS Proponent to produce transposed standards for a particular technology, and must have the relevant legal usage rights.

It is further noted that GCS Proponents and Transposing Organizations must also qualify appropriately under the auspices of Resolution ITU-R 9-5 and the ITU-R “Guidelines for the contribution of material of other organizations to the work of the Study Groups and for inviting other organizations to take part in the study of specific matters (Resolution ITU-R 9-5)”.

The ITU has provided the global and overall framework and requirements, and has developed the Global Core Specification jointly with the GCS Proponent. The detailed standardization has been undertaken within the recognized Transposing Organizations which operate in concert with the GCS Proponent. This Recommendation therefore makes extensive use of references to externally developed specifications.

This approach was considered to be the most appropriate solution to enable completion of this Recommendation within the aggressive schedules set by the ITU and by the needs of administrations, operators and manufacturers.

This Recommendation has therefore been constructed to take full advantage of this method of work and to allow the global standardization time-scales to be maintained. The main body of this Recommendation has been developed by the ITU, with each Annex containing references pointing to the location of the more detailed information.

⁵ Developed by IEEE as the WirelessMAN-Advanced specification incorporated in IEEE Std 802.16 beginning with approval of IEEE Std 802.16m.

⁶ A “GCS” (Global Core Specification) is the set of specifications that defines a single RIT, an SRIT, or a RIT within an SRIT.

⁷ Radio Interface Technology.

⁸ Set of Radio Interface Technologies.

This Annex 1 contains the detailed information developed by the ITU and “ARIB, ATIS, CCSA, ETSI, TSDSI, TTA, and TTC on behalf of 3GPP” (the GCS Proponent) and ARIB, ATIS, CCSA, ETSI, TSDSI, TTA, and TTC (the Transposing Organizations).

Such use of referencing enables timely completion and update of the high-level elements of this Recommendation, with change control procedures, transposition, and public enquiry procedures being undertaken within the external organization. This information has generally been adopted unchanged, recognizing the need to minimize duplication of work, and the need to facilitate and support an ongoing maintenance and update process.

This general agreement, noting that the detailed information of the radio interface should to a large extent be achieved by reference to the work of external organizations, highlights not only the ITU’s significant role as a catalyst in stimulating, coordinating and facilitating the development of advanced telecommunications technologies, but also its forward-looking and flexible approach to the development of this and other telecommunications standards for the 21st century.

A more detailed understanding of the process for the development of the first release of this Recommendation may be found in Document IMT-ADV/24(Rev.3) whereas details on the process for the development of revisions of this Recommendation may be found in Document IMT-ADV/25(Rev.2).

1 Overview of the radio interface technology

1.1 Overview of the SRIT

The IMT-Advanced terrestrial radio interface specifications known as LTE-Advanced is based on LTE Release 10 and Beyond are developed by 3GPP. In 3GPP terminology, the term E-UTRA (Evolved-UTRA) is also used to indicate the LTE radio interface, and 3GPP LTE Release 13 and beyond is marked as “LTE-Advanced Pro”.

LTE-Advanced is a Set of RITs (Radio Interface Technologies) consisting of one FDD RIT and one TDD RIT designed for operation in paired and unpaired spectrum, respectively. The TDD RIT is also known as TD-LTE Release 10 and Beyond or *TD-LTE-Advanced*. The two RITs have been jointly developed, providing a high degree of commonality while, at the same time, allowing for optimization of each RIT with respect to its specific spectrum/duplex arrangement.

Both the FDD RIT and the TDD RIT individually, and consequently the Set of RITs (SRIT), meet all the ITU IMT-Advanced minimum requirements in all four test environments defined in all aspects of Services, Spectrum and Technical performance. Furthermore, both the FDD RIT and TDD RIT individually, and consequently the SRIT, meet the requirements of Resolution ITU-R 57-2, *resolves 6 e) and f)* in all four test environments.

The complete set of standards for the terrestrial radio interface of IMT-Advanced identified as *LTE-Advanced* includes not only the key characteristics of IMT-Advanced but also the additional capabilities of *LTE-Advanced* both of which are continuing to be enhanced.

The radio aspects of *LTE-Advanced* also include the capabilities of LTE Release 8 and LTE Release 9. Information on the Radio specifications Release 8 and Release 9 is provided in § 2.2.1. Furthermore, information on system and core network specifications is also provided for a complete system perspective. These system and core network specifications address the network, terminal, and service aspects required to provide an integrated mobility solution including aspects such as user services, connectivity, interoperability, mobility and roaming, security, codecs and media, operations and maintenance, charging, etc. Information on the System and core network specifications Release 8, Release 9, Release 10, Release 11, Release 12, Release 13, and Release 14 is provided in § 2.2.2.

1.2 Overview of the Radio Interface Technology (RIT)

1.2.1 Overview of the FDD RIT

The FDD RIT is the evolution of LTE FDD. The FDD RIT uses Frequency-Division Duplex operation and therefore is applicable for operation with paired spectrum. Both full-duplex and half-duplex FDD are supported.

1.2.2 Overview of the TDD RIT

The TDD RIT, also known as *TD-LTE-Advanced*, is the evolution of TD-LTE. The TDD RIT uses Time-Division Duplex operation and therefore is applicable for operation with unpaired spectrum. The TDD RIT provides flexibility in terms of downlink-uplink resource allocation by supporting multiple uplink-downlink resource-allocation configurations that can be used to match different traffic scenarios. The uplink-downlink resource-allocation configuration can be adapted to the varying instantaneous traffic and interference conditions even during operation.

It is also designed to exploit the more extensive channel reciprocity inherent in case of TDD operation, e.g. for beamforming, and facilitates coexistence with TD-SCDMA as well as other TDD-based IMT-2000 technologies.

1.3 Overview of the system aspects of the SRIT

The FDD and TDD RITs represent the evolution of the first releases of LTE FDD and TDD, respectively. The two RITs share many of the underlying structures to simplify implementation of dual-mode radio-access equipment. Transmission bandwidths up to 640 MHz are supported, yielding peak data rates up to roughly 25 Gbit/s in the downlink and 13.6 Gbit/s in the uplink.

The downlink transmission scheme is based on conventional OFDM to provide a high degree of robustness against channel frequency selectivity while still allowing for low-complexity receiver implementations also at very large bandwidths.

The uplink transmission scheme is based on Discrete Fourier Transform-spread OFDM (DFTS-OFDM). The use of DFTS-OFDM transmission for the uplink is motivated by the lower Peak-to-Average Power Ratio (PAPR) of the transmitted signal compared to conventional OFDM. This allows for more efficient usage of the power amplifier at the terminal, which translates into an increased coverage and/or reduced terminal power consumption. The uplink numerology is aligned with the downlink numerology. The Narrow-band Internet of Things (NB-IOT) UL allows allocating a single-tone in addition to multi-tone DFTS-OFDM with the possibility of a lower subcarrier spacing in addition to the normal subcarrier spacing.

Channel coding is based on rate-1/3 Turbo coding (Tail Biting Convolutional Code for NB-IOT DL) and is complemented by Hybrid-ARQ with soft combining to handle decoding errors at the receiver side. Data modulation supports QPSK, 16QAM, 64QAM, and 256QAM for both the downlink and the uplink. For NB-IOT, additionally $\pi/2$ -BPSK and $\pi/4$ -QPSK are supported in uplink when a single-tone is allocated.

The FDD and TDD RITs support bandwidths from approximately 1.4 MHz to 640 MHz. NB-IOT supports 200 kHz bandwidth. Carrier aggregation, i.e. the simultaneous transmission of multiple component carriers in parallel to/from the same terminal/eNB, is used to support bandwidths larger than 20 MHz. Component carriers do not have to be contiguous in frequency and can even be located in different frequency bands in order to enable exploitation of fragmented spectrum allocations by means of spectrum aggregation. Licensed-Assisted Access (LAA) allows secondary component carriers to operate in the unlicensed 5 GHz band. In order to fairly coexist, LAA uses a Listen-Before-Talk (LBT) medium access in the unlicensed frequency bands. Carrier Aggregation supports the functionality to aggregate TDD bands with different uplink and downlink allocations as well as the

functionality to support multiple timing advancements. Carrier Aggregation also supports to aggregate FDD and TDD component carriers. Dual Connectivity allows aggregating component carriers of different eNBs that are connected via a non-ideal backhaul over the X2 interface.

Channel-dependent scheduling in both the time and frequency domains is supported for both downlink and uplink with the base-station scheduler being responsible for (dynamically) selecting the transmission resource as well as the data rate. The basic operation is dynamic scheduling, where the base-station scheduler takes a decision for each 1 ms Transmission Time Interval (TTI), but there is also a possibility for semi-persistent scheduling. Semi-persistent scheduling (SPS) enables transmission resources and data rates to be semi-statically allocated to a given User Equipment (UE) for a longer time period than one TTI to reduce the control-signalling overhead. For low latency UL transmissions, the SPS periodicity can be as low as 1 ms and UEs are allowed to skip the UL grant. For better uplink coverage, TTI bundling allows UEs to transmit in four consecutive TTIs. NB-IOT and enhanced Machine-type Communication (eMTC) allows for widespread coverage extension by means of scheduling multiple TTIs (up to several thousands).

Multi-antenna transmission schemes are an integral part of both RITs. Multi-antenna precoding with dynamic rank adaptation supports both spatial multiplexing (single-user MIMO) and beam-forming. Beam-forming by means of two-dimensional antenna arrays can exploit the horizontal as well as the vertical domain. Spatial multiplexing with up to eight layers in the downlink and four layers in the uplink is supported. Multi-user MIMO, where multiple users (up to eight) are assigned the same time-frequency resources, is also supported. Coordinated MultiPoint (CoMP) operation is also supported, where multiple transmission points or reception points are coordinated in their transmission or reception respectively. The coordinated transmission points can belong to the same cell, to different cells of the same eNB or to different cells of different eNBs. A discovery reference signal can be used to identify transmission points or cells for CoMP and/or Carrier aggregation operation. Finally, transmit diversity based on Space-Frequency Block Coding (SFBC) or a combination of SFBC and Frequency Switched Transmit Diversity (FSTD) is supported. Large antenna arrays are efficiently supported, e.g. through codebook based channel state information (CSI) feedback for up to 32 eNB antenna ports or beamformed CSI reference signals.

Inter-cell interference coordination (ICIC), where neighbour cells exchange information aiding the scheduling in order to reduce interference, is supported for the RITs. ICIC can be used for homogenous deployments with non-overlapping cells of similar transmission power, as well as for heterogeneous deployments where a higher-power cell overlays one or several lower-power nodes. In order to increase the potential of cell range expansion, functionality for terminal-side interference mitigation of reference and synchronization signals as well as the broadcast channel exists. A terminal-side mitigation of inter-cell interference caused by the data channel is supported with network assistance. A network-side interference mitigation technique is supported, which is based on the ability to turn on and off secondary cells.

Relaying functionality is included in both the FDD and TDD RITs. The relay node appears as a conventional eNB to terminals but is wirelessly backhauled to the remaining part of the radio-access network using the LTE Release 10 radio-interface technology.

Both RITs support various types of machine-type communication. In order to better address the low-cost segment, a low-complexity terminal (Category 0) is supported, which approximately 50% has reduced modem complexity as compared to the least complex 'normal' UE (Category 1), e.g. by a single receive antenna, half-duplex operation and greatly reduced peak data rate support.

With the introduction of LTE-M, complexity is further reduced, e.g. by reducing the UE bandwidth down to 1.4 or 5 MHz and a low UE power class (20dBm). Two coverage extension modes have been added to LTE/LTE-M, one for moderate and another for large coverage extension basically using repetitions.

NB-IoT is introduced aiming at extreme low complexity, e.g. by reducing the UE bandwidth down to 200 kHz, by even further limiting the UE peak data rate, and by introducing low UE power classes (20 dBm/14 dBm). Coverage extension of ~20 dB is enabled also basically through repetitions. NB-IoT can operate inband in LTE, in the LTE guardband, or standalone.

In order to improve UE power consumption, a Power Saving State was introduced and extended Discontinuous Reception (eDRX) cycles range up to 10.24 s in connected mode and 43.69 min in idle mode. For LTE-M and NB-IOT, it is possible to configure an additional uplink and an additional downlink carrier for traffic which is dedicated to a particular User Equipment, whilst common transmissions such as synchronization signals, and uplink transmissions during cell access, occur on a the same carrier for all User Equipments.

In order to enhance data offloading, both RITs support LTE/Wi-Fi interworking functionality via RAN-assisted and RAN-controlled WLAN interworking. Based on configurable rules or eNB command, the UE steers its data traffic to the most appropriate radio access. Additionally, from Release 13 onwards, both RITs support LTE-WLAN aggregation (LWA) and LTE-WLAN Radio Level Integration with IPsec Tunnel (LWIP). LWA allows utilizing both LTE and WLAN in the unlicensed 2.4 GHz and 5 GHz bands simultaneously under the control of eNB.

From Release 12 onwards, sidelink transmissions are defined for Proximity based Services (ProSe) Direct Discovery and ProSe Direct Communication between terminals. ProSe Direct Communication is targeting only Public Safety applications and allows terminals to communicate with each other directly without routing the data via the eNB. ProSe Direct Discovery allows discovering other terminals in close proximity. Direct communication is also supported when a terminal is out of LTE coverage. The sidelink has been further enhanced in order to address direct vehicle-to-vehicle (V2V) communication.

1.3.1 Network architecture

The *LTE-Advanced* radio-access network has a flat architecture with a single type of node, the *eNodeB*, which is responsible for all radio-related functions in one or several cells. The *eNodeB* is connected to the core network by means of the S1 interface, more specifically to the *serving gateway* (S-GW) by means of the user-plane part, S1-u, and to the *Mobility Management Entity* (MME) by means of the control-plane part, S1-c. One *eNodeB* can interface to multiple MMEs/S-GWs for the purpose of load sharing and redundancy. MMEs/S-GWs can be (re)selected for support of separate dedicated core networks that are designed to meet the requirements of a certain group of devices/customers.

The X2 interface, connecting *eNodeBs* to each other, is mainly used to support active-mode mobility. This interface may also be used for multi-cell *Radio Resource Management* (RRM) functions such as ICIC or CoMP. The X2 interface is also used to support lossless mobility between neighbouring cells by means of packet forwarding.

FIGURE 1.1
Radio-access network interfaces

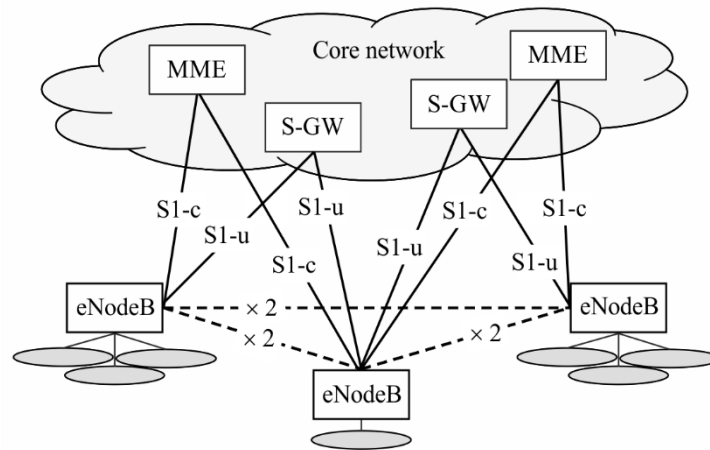

M.2012-01-01

1.3.2 Layer 2 protocol architecture

Layer 2 (L2) consists of several sub-layers: *Packet Data Convergence Protocol (PDCP)*, *Radio Link Control (RLC)* and *Medium Access Control (MAC)*. The downlink and uplink protocol structures are illustrated in Fig. 1.2 and Fig. 1.3, respectively. Layer 2 provides one or more Radio Bearers to higher layers to which IP packets are mapped according to their Quality-of-Service (QoS) requirements. L2/MAC PDUs, also referred to as transport blocks, are created according to instantaneous scheduling decisions and delivered to the physical layer on one or several transport channels (one transport channel of the same type per component carrier).

FIGURE 1.2
Downlink L2 protocol structure

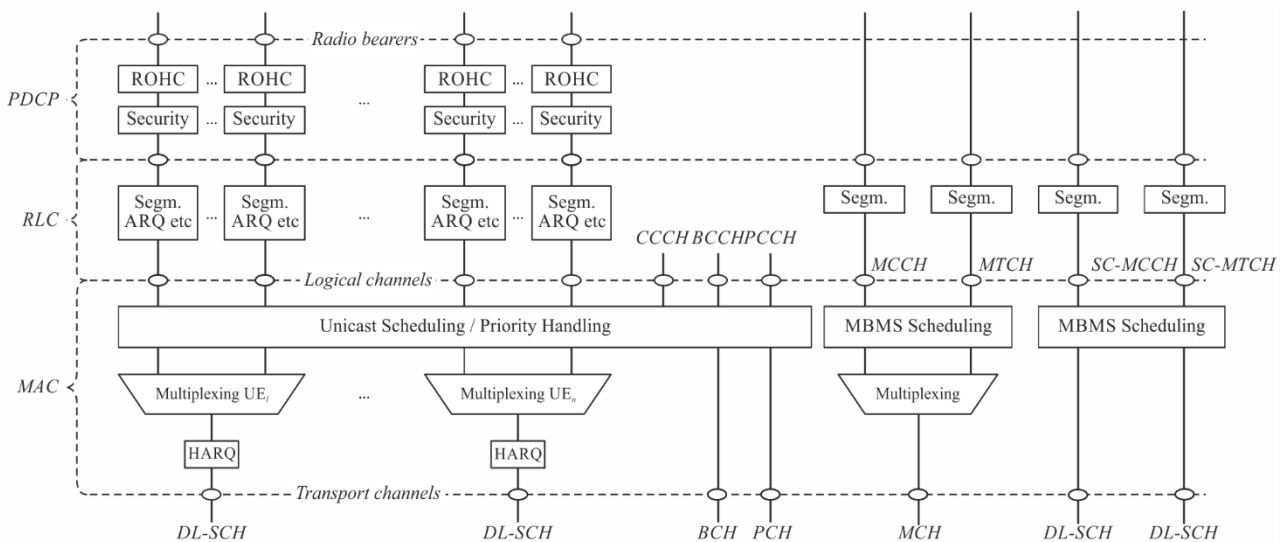

M.2012-01-02

FIGURE 1.3

Uplink L2 protocol structure

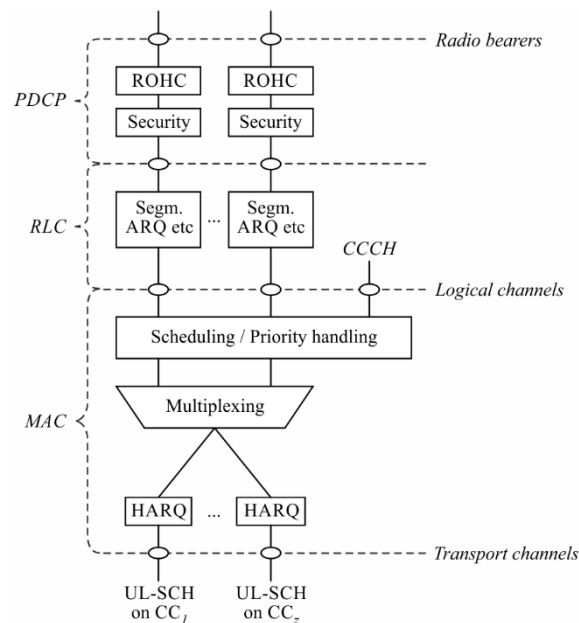

M.2012-01-03

In Dual Connectivity, a data radio bearer can be configured as Master Cell Group (MCG) bearer, Secondary Cell Group (SCG) bearer or a split bearer. The MCG bearer is served by the Master eNB (MeNB), SCG bearer by the Secondary eNB (SeNB) and the split bearer is served by both eNBs. For a split bearer, a common PDCP entity is located in the MeNB, but there are two RLC entities, one terminating in the MeNB and one in the SeNB.

1.3.2.1 Packet Data Convergence Protocol (PDCP)

Except for NB-IOT, the main services and functions of the PDCP sublayer for the user plane include:

- Header compression and decompression of IP data flows using ROHC.
- Transfer of user data.
- In-sequence delivery of upper layer PDUs at PDCP re-establishment procedure for RLC AM.
- For split bearers in Dual Connectivity (only support for RLC AM): PDCP PDU routing for transmission and PDCP PDU reordering for reception.
- Duplicate detection of lower layer SDUs at PDCP re-establishment procedure for RLC AM.
- Retransmission of PDCP SDUs at handover and, for split bearers in DC and LWA bearers, of PDCP PDUs at PDCP data-recovery procedure, for RLC AM.
- Ciphering and deciphering.
- Timer-based SDU discard in uplink.

For NB-IOT UE when AS security is activated, the main services and functions of the PDCP sublayer for the user plane include:

- Header compression and decompression: ROHC only;
- Transfer of user data;
- In-sequence delivery of upper layer PDUs at PDCP re-establishment procedure for RLC AM;
- Duplicate detection of lower layer SDUs at PDCP re-establishment procedure for RLC AM;
- Ciphering and deciphering;
- Timer-based SDU discard in uplink.

The main services and functions of the PDCP for the control plane include:

- Ciphering and Integrity Protection and Verification.
- Transfer of control plane data.

For a NB-IOT UE that supports Control Plane CIoT EPS optimizations only, PDCP is bypassed. For a NB-IOT UE that supports both Control Plane CIoT EPS optimizations and User Plane CIoT EPS optimizations PDCP is not used until AS security is activated.

PDCP uses the services provided by the RLC sub-layer. There is one PDCP entity per radio bearer configured for a UE.

1.3.2.2 Radio Link Control (RLC)

Radio Link Control (RLC) is responsible for:

- Transfer of upper layer PDUs.
- Error correction through ARQ (only for AM data transfer).
- Concatenation, segmentation and reassembly of RLC SDUs (only for UM and AM data transfer).
- Resegmentation of RLC data PDUs (only for AM data transfer).
- Reordering of RLC data PDUs (only for UM and AM data transfer).
- Duplicate detection (only for UM and AM data transfer).
- Protocol error detection (only for AM data transfer).
- RLC SDU discard (only for UM and AM data transfer).
- RLC re-establishment, except for a NB-IOT UE that only uses Control Plane CIoT EPS optimizations.

Depending on the mode-of-operation, an RLC entity may provide all, a subset of, or none of the services above. The RLC can operate in three different modes:

- *Transparent mode* (TM), where the RLC is completely transparent and is in essence bypassed. This configuration is used for control-plane broadcast channels such as Broadcast Control Channel (BCCH), Common Control Channel (CCCH) and Paging Control Channel (PCCH) only where the information should reach multiple users.
- *Unacknowledged mode* (UM), where the RLC provides all the functionality above except error correction, is used when error-free delivery is not required, for example for Multicast Control Channel (MCCH) and Multicast Traffic Channel (MTCH) using Multimedia Broadcast over a Single Frequency Network (MBSFN) and for Voice-over-IP (VoIP).
- For NB-IOT, RLC UM is not supported.
- *Acknowledged mode* (AM), where the RLC provides all the services above, is the main mode-of-operation for TCP/IP packet data transmission on the Downlink Shared Channel (DL-SCH). Segmentation/reassembly, in-sequence delivery and retransmissions of erroneous data are all supported.

The RLC offers services to the PDCP in the form of *radio bearers* and uses services from the MAC layer in the form of *logical channels*. There is one RLC entity per radio bearer configured for a terminal.

1.3.2.3 Medium access control (MAC)

The MAC layer is responsible for:

- Mapping between logical channels and transport channels.

- Multiplexing/demultiplexing of MAC SDUs belonging to one or different logical channels into/from transport blocks delivered to/from the physical layer on transport channels.
- Scheduling information reporting.
- Error correction through N-process stop-and-wait hybrid-ARQ (HARQ) with synchronous (for the uplink) and asynchronous (for the downlink) retransmissions.
- Priority handling between logical channels of one UE.
- Priority handling between UEs by means of dynamic scheduling.
- Multimedia Broadcast/Multicast Service (MBMS) identification.
- Transport format selection.
- Padding.

The ProSe specific services and functions of the MAC sublayer include:

- Radio resource selection;
- Packet filtering for ProSe Direct Communication.

In case of Dual Connectivity, the UE is configured with two independent MAC entities, one for MCG and one for SCG.

The MAC offers services to the RLC in the form of *logical channels*. A logical channel is defined by the *type* of information it carries and is generally classified as a *control channel*, used for transmission of control and configuration information necessary for operating an *LTE-Advanced* system, or as a *traffic channel*, used for the user data. The set of logical-channel types specified for *LTE-Advanced* includes:

- *Broadcast Control Channel (BCCH)*, used for broadcasting system control information.
- *Bandwidth Reduced Broadcast Control Channel (BR-BCCH)*, used for broadcasting system control information to bandwidth limited eMTC UEs.
- *Paging Control Channel (PCCH)*, a downlink channel used for paging when the network is not aware of the location of the UE and for system information change notifications.
- *Common Control Channel (CCCH)*, used for transmission of control information between UEs and network when the UE has no RRC connection.
- *Dedicated Control Channel (DCCH)*, used for transmission of control information to/from a mobile terminal when the UE has a RRC connection.
- *Multicast Control Channel (MCCH)*, used for transmission of control information required for reception of the MTCH.
- *Single-Cell Multicast Control Channel (SC-MCCH)*, used for transmission of control information required for reception of MBMS using single-cell point-to-multipoint (SC-PTM).
- *Sidelink Broadcast Channel (SBCH)* used for broadcasting sidelink system information from one UE to other UE(s). This channel is used only by ProSe Direct Communication capable UEs.
- *Dedicated Traffic Channel (DTCH)*, used for transmission of user data to/from a mobile terminal. This is the logical channel type used for transmission of all uplink and non-MBSFN downlink user data. DTCH is not supported for a NB-IOT UE that only uses Control Plane CIoT EPS optimizations.
- *Multicast Traffic Channel (MTCH)*, used for downlink transmission of MBMS services.
- *Single-Cell Multicast Traffic Channel (SC-MTCH)*, used for downlink transmission of MBMS services using SC-PTM.

- *Sidelink Traffic Channel (STCH)* is a point-to-multipoint channel, for transfer of user information from one UE to other UEs. This channel is used only by Prose Direct Communication capable UEs.

For a NB-IOT UE that only uses Control Plane CIoT EPS optimizations there is only one dedicated logical channel per UE.

From the physical layer, the MAC layer uses services in the form of *Transport Channels*. A transport channel is defined by *how* and *with what characteristics* the information is transmitted over the radio interface. Data on a transport channel is organized into *transport blocks*. In each *Transmission Time Interval (TTI)*, at most one or two (in case of spatial multiplexing) transport blocks are transmitted per component carrier.

Associated with each transport block is a *Transport Format (TF)*, specifying *how* the transport block is to be transmitted over the radio interface. The transport format includes information about the transport-block size, the modulation scheme, and the antenna mapping. The scheduler is responsible for (dynamically) determining the uplink as well as downlink transport format in each TTI.

The following transport-channel types are defined:

- *Broadcast Channel (BCH)* has a fixed transport format, provided by the specifications. It is used for transmission of parts of the BCCH system information, more specifically the so-called *Master Information Block (MIB)*.
- *Paging Channel (PCH)* is used for transmission of paging information from the PCCH logical channel. The PCH supports *discontinuous reception (DRX)* to allow the mobile terminal to save battery power by waking up to receive the PCH only at predefined time instants.
- *Downlink Shared Channel (DL-SCH)* is the main transport-channel type used for transmission of downlink data in *LTE-Advanced*. It supports dynamic rate adaptation and channel-dependent scheduling, hybrid-ARQ with soft combining, and spatial multiplexing. It also supports DRX to reduce mobile-terminal power consumption while still providing an always-on experience.
The DL-SCH is also used for transmission of the parts of the BCCH system information not mapped to the BCH. In case of transmission to a terminal using multiple component carriers the UE receives one DL-SCH per component carrier.
- *Multicast Channel (MCH)* is used to support MBMS. It is characterized by a semi-static transport format and semi-persistent scheduling. In case of multi-cell transmission using MBSFN, the scheduling and transport format configuration is coordinated among the cells involved in the MBSFN transmission.
- *Uplink Shared Channel (UL-SCH)* is the uplink counterpart to the DL-SCH, i.e. it is the uplink transport channel used for transmission of uplink data.
- *Random Access Channel (RACH)* is also defined as an uplink transport channel although it does not carry transport blocks. The RACH is used in the uplink to respond to the paging message or to initiate the move to the RRC_CONNECTED state according to terminal data transmission needs.
- *Sidelink broadcast channel (SL-BCH)* uses a pre-defined transport format.
- *Sidelink discovery channel (SL-DCH)* supports both UE autonomous resource selection and scheduled resource allocation by eNodeB; it uses a fixed size, pre-defined format periodic broadcast transmission.
- *Sidelink shared channel (SL-SCH)* supports both UE autonomous resource selection and scheduled resource allocation by eNodeB; it supports HARQ combining and dynamic link adaptation by varying the transmit power, modulation and coding.

The mapping between logical channels, transport channels and physical channels (described in § 1.1.3.3) is illustrated in Fig. 1.4 for the downlink, Fig. 1.5 for the uplink, Fig. 1.6 for the sidelink, Fig. 1.6A for the NB-IOT downlink and Fig. 1.6B for the NB-IOT uplink.

FIGURE 1.4
Downlink channel mapping

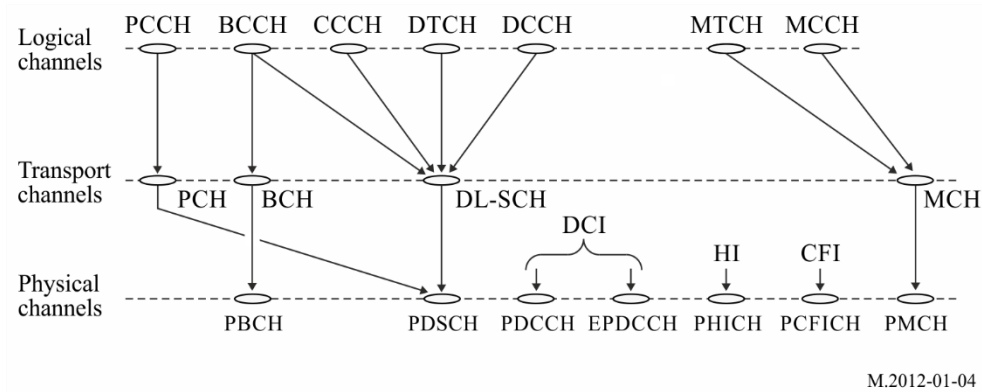

FIGURE 1.5
Uplink channel mapping

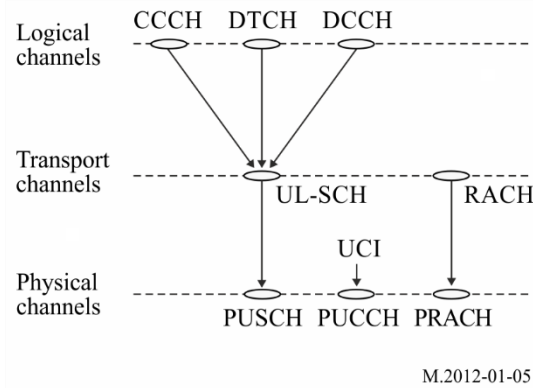

FIGURE 1.6
Sidelink channel mapping

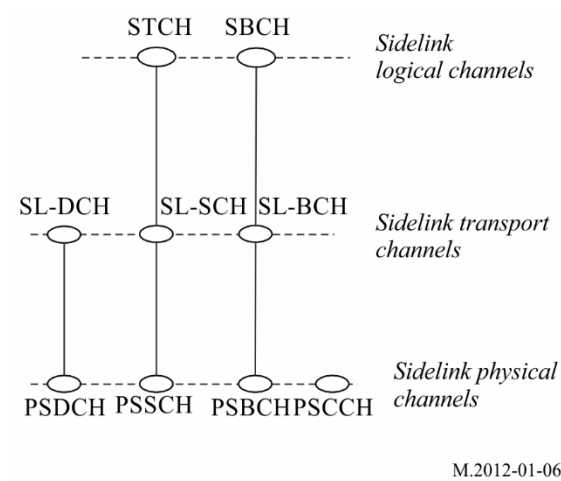

FIGURE 1.6A

NB-IOT DL channel mapping

FIGURE 1.6B

NB-IOT UL channel mapping**1.3.3 Physical layer**

The physical layer is responsible for:

- Modulation and demodulation of physical channels.
- Error detection on the transport channel and indication to higher layers.
- Forward Error Correction (FEC) encoding and decoding of transport channels.
- Rate matching of the coded transport channel to physical channels.
- Mapping of the coded transport channel onto physical channels according to Fig. 1.4 (downlink) and Fig. 1.5 (uplink).
- Hybrid ARQ soft-combining.
- Frequency and time synchronization.
- Power weighting of physical channels.
- Multi-antenna processing and beamforming.
- Characteristic measurements and indication to higher layers.
- RF processing.

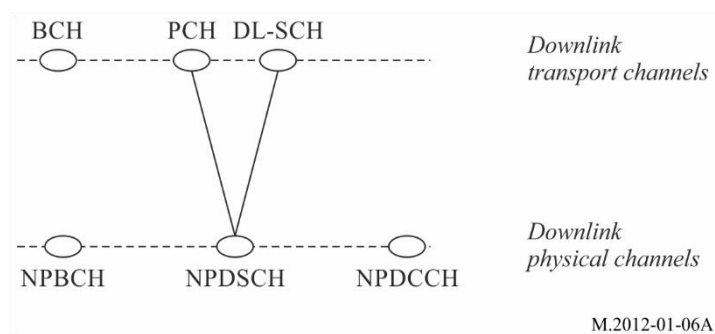
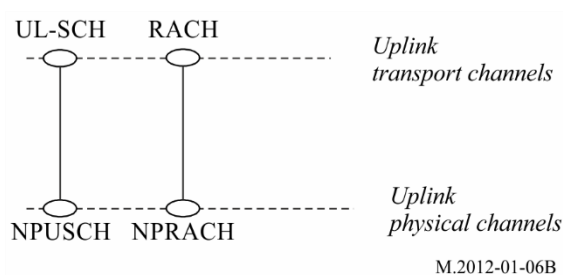
A simplified overview of the processing for the DL-SCH is given in Fig. 1.7.

FIGURE 1.7

Simplified physical-layer processing for DL-SCH on one component carrier

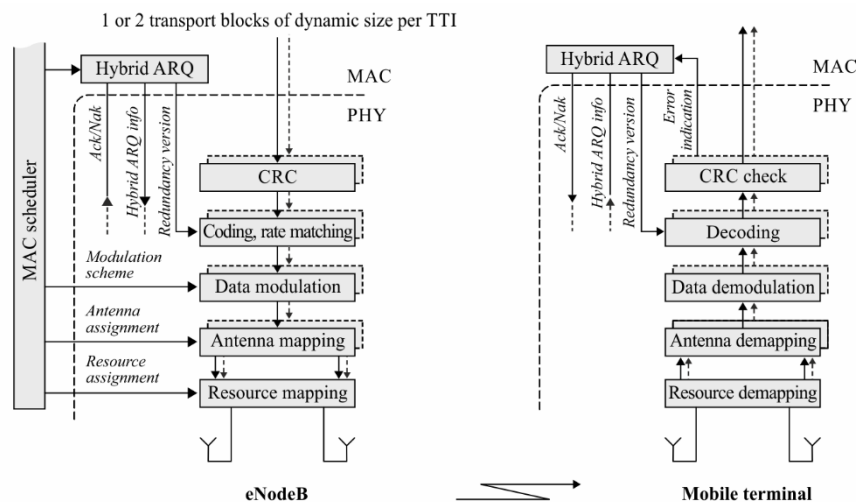

M.2012-01-07

1.3.3.1 Physical channels

The following different types of physical channels are defined for the downlink:

- Physical Downlink Shared Channel (PDSCH): Used for transmission of user and control plane data services.
- Physical Multicast Channel (PMCH): Used for transmission of control and user-plane broadcast services during MBSFN subframes.
- Physical Downlink Control Channel (PDCCH): Used for transmission of control information such as resource allocation, transport format and HARQ related information.
- Enhanced Physical Downlink Control Channel (EPDCCH): Used for transmission of control information such as resource allocation, transport format and HARQ related information.
- MTC physical downlink control channel (MPDCCH): Used for transmission of control information in bandwidth-reduced operation and/or using coverage extension mode.
- Physical Broadcast Channel (PBCH): Used for conveying cell and/or system specific information.
- Physical Control Format Indicator Channel (PCFICH): It indicates to the UE the control format (number of symbols comprising PDCCH, PHICH) of the current subframe.
- Physical Hybrid ARQ Indicator Channel (PHICH): It conveys the ACK/NAK information for UL (PUSCH) transmissions received at the eNodeB.

Three different types of physical channels are defined for the uplink:

- Physical Random Access Channel (PRACH): It conveys a preamble which is used to trigger a random-access procedure in the eNodeB.
- Physical Uplink Shared Channel (PUSCH): It conveys both user data and upper layer control information.
- Physical Uplink Control Channel (PUCCH): It conveys control information (scheduling requests, CQI, PMI, RI, HARQ ACK/NAK for PDSCH, etc.).

The following types of physical channels are defined for the sidelink:

- Physical sidelink broadcast channel (PSBCH): Carries system and synchronization related information, transmitted from the UE.

- Physical sidelink discovery channel (PSDCH): Carries ProSe Direct Discovery message from the UE.
- Physical sidelink control channel (PSCCH): Carries control from a UE for ProSe Direct Communication.
- Physical sidelink shared channel (PSSCH): Carries data from a UE for ProSe Direct Communication.

The following types of physical channels are defined for NB-IOT:

- Narrowband Physical broadcast channel (NPBCH): Carries the BCH for NB-IOT UEs. Used for conveying cell and/or system specific information using a transport block mapped to sixty four subframes within a 640 ms interval.
- Narrowband Physical downlink shared channel (NPDSCH): Carries the DL-SCH and PCH for NB-IOT UEs.
- Narrowband Physical downlink control channel (NPDCCH): Informs the NB-IOT UE about the resource allocation of PCH and DL-SCH. Carries the uplink scheduling grant for the NB-IOT UE. Carries the direct indication information.
- Narrowband Physical uplink shared channel (NPUSCH): Carries the UL-SCH and Hybrid ARQ ACK/NAKs in response to downlink transmission for the NB-IOT UE.
- Narrowband Physical random access channel (NPRACH): Carries the random access preamble for the NB-IOT UE.

1.3.3.2 Time-domain structure and duplex schemes

Figure 1.8 illustrates the high-level time-domain structure for transmission, with each (*radio*) *frame* of length 10 ms consisting of ten equally sized *subframes* of length 1 ms. Each subframe consists of two equally sized *slots* of length $T_{slot} = 0.5$ ms with each slot consisting of a number of OFDM symbols including cyclic prefix.

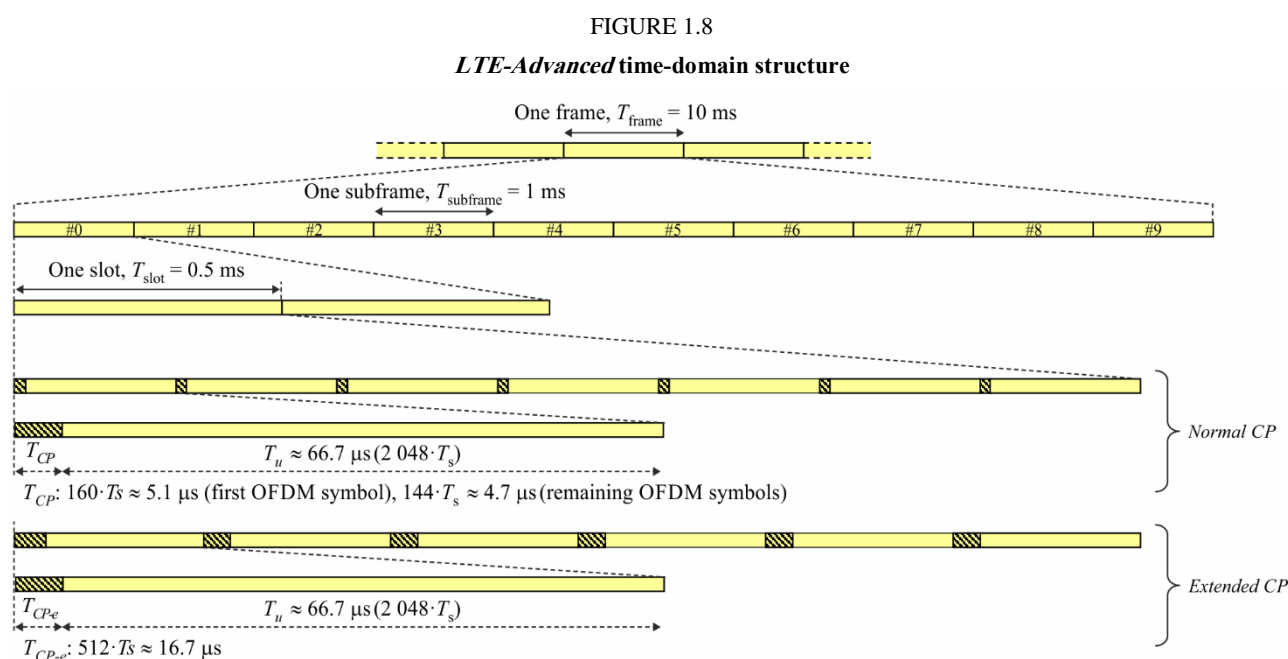

M.2012-01-08

LTE-Advanced can operate in both FDD and TDD as illustrated in Fig. 1.9. Although the time-domain structure is, in most respects, the same for FDD and TDD there are some differences between the two

duplex modes, most notably the presence of a *special subframe* in case of TDD. The special subframe is used to provide the necessary guard time for downlink-to-uplink switching.

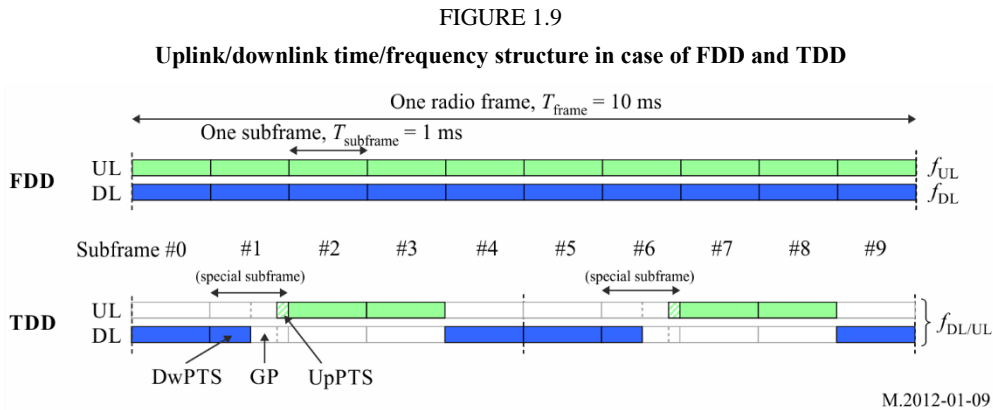

In case of FDD operation (upper part of Fig. 1.9), there are two carrier frequencies for each component carrier, one for uplink transmission (f_{UL}) and one for downlink transmission (f_{DL}). During each frame, there are thus ten uplink subframes and ten downlink subframes and uplink and downlink transmission can occur simultaneously within a cell. Half-duplex operation at the UE side is supported by the scheduler ensuring non-simultaneous reception and transmission at the UE.

In case of TDD operation (lower part of Fig. 1.9), there is only a single carrier frequency per component carrier and uplink and downlink transmissions are always separated in time also on a cell basis. As seen in the Figure, some subframes are allocated for uplink transmissions and some subframes for downlink transmission with the switch between downlink and uplink occurring in the *special subframe*. The special subframe is split into three parts: a downlink part (DwPTS), a guard period (GP) where the switch occurs, and an uplink part (UpPTS). The DwPTS is in essence treated as a normal downlink subframe, although the amount of data that it is possible to transmit is smaller due to the reduced length of the DwPTS. The UpPTS can be used for UL data transmission, channel sounding or random access. The DwPTS, GP, and UpPTS have configurable individual lengths to support different deployment scenarios, and a total length of 1 ms.

Different asymmetries in terms of the amount of resources allocated for uplink and downlink transmission, respectively, are provided through seven different downlink/uplink configurations as shown in Fig. 1.10. In case of carrier aggregation, the downlink/uplink configuration is identical across component carriers in the same band and may be the same or different across component carriers in different bands.

Coexistence between the TDD RIT and other (IMT-2000) TDD systems such as TD-SCDMA is catered for by aligning the switch points between the two systems and selecting the appropriate special subframe configuration and uplink-downlink asymmetry.

FIGURE 1.10
Uplink-downlink asymmetries supported by the TDD RIT

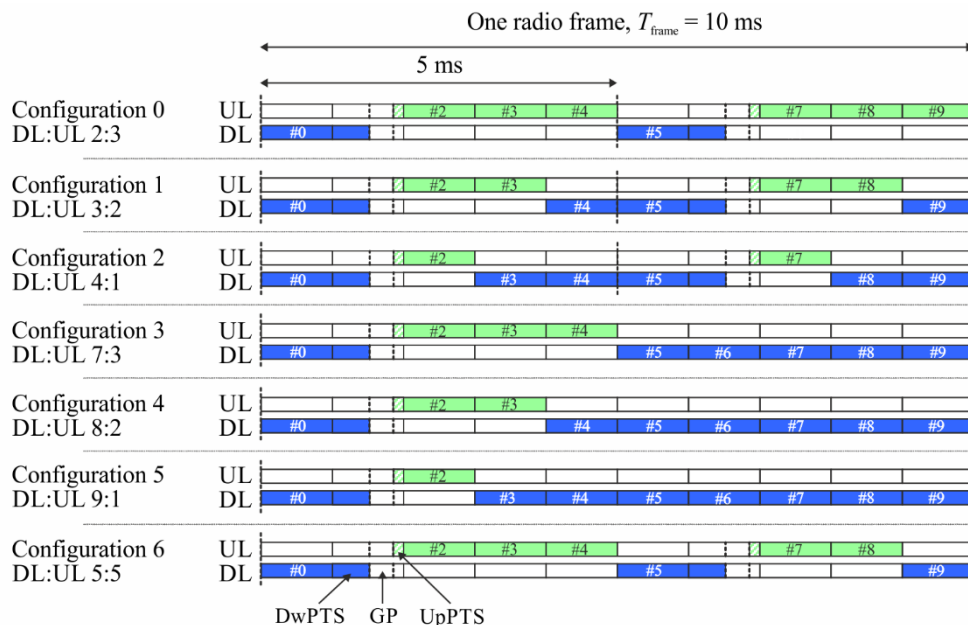

M.2012-01-10

Sidelink transmissions use the same frame structure as the frame structure that is defined for uplink and downlink when UEs are in network coverage. However, the sidelink transmissions are restricted to a sub-set of the uplink resources in time and frequency domain.

The physical channel structure is similar to uplink transmissions and the same basic transmission scheme as the UL transmission scheme is used. However, sidelink is limited to single cluster transmissions and it uses a 1 symbol gap at the end of each sidelink subframe.

1.3.3.3 Physical layer processing

To the transport block(s) to be transmitted on a DL-SCH or UL-SCH, a CRC is attached, followed by rate-1/3 Turbo coding for error correction (Tail Biting Convolutional Code for NPDSCH). Rate matching is used not only to match the number of coded bits to the amount of resources allocated for the DL-SCH/UL-SCH transmission, but also to generate the different redundancy versions as controlled by the hybrid-ARQ protocol. In case of spatial multiplexing, the processing is duplicated for the two transport blocks. After rate matching, the coded bits are modulated (QPSK, 16QAM, 64QAM, 256QAM). In case of multi-antenna transmission, the modulation symbols are mapped to multiple layers and precoded before being mapped to the different antenna ports. Alternatively, transmit diversity can be applied. Finally, the (precoded) modulation symbols are mapped to the time-frequency resources allocated for the transmission.

Downlink transmission is based on conventional OFDM with a cyclic prefix. The subcarrier spacing is $\Delta f = 15$ kHz and two cyclic prefix lengths are supported: normal cyclic prefix ≈ 4.7 μ s and extended cyclic prefix ≈ 16.7 μ s. In the frequency domain, the number of resource blocks can range from 6 to 100 per component carrier (for channel bandwidths ranging from 1.4 to 20 MHz respectively), where a resource block is 180 kHz in the frequency domain. There can be up to 32 component carriers transmitted in parallel implying an overall bandwidth up to 640 MHz. In inband mode NB-IOT allocates a single resource block. In standalone mode, NB-IOT uses a channel bandwidth of 200 kHz. MBSFN subframes can use subcarrier spacings of $\Delta f = 7.5$ kHz or $\Delta f = 1.25$ kHz with an extended cyclic prefix of ≈ 33.4 μ s and ≈ 200 μ s, respectively.

Uplink transmission is based on DFT-spread OFDM (DFTS-OFDM). DFTS-OFDM can be seen as a DFT precoder, followed by conventional OFDM with the same numerology as in the downlink. The NB-IOT UL allows allocating a single-tone with $\Delta f = 3.75$ kHz or $\Delta f = 15$ kHz subcarrier spacing. Multiple DFT precoding sizes, corresponding to transmission with different scheduled bandwidths, can be used.

The remaining downlink transport channels (PCH, BCH, MCH) are based on the same general physical-layer processing as DL-SCH, although with some restrictions in the set of features used.

1.3.3.4 Multi-antenna transmission

A wide range of multi-antenna transmission schemes are supported in the downlink:

- Single-antenna transmission using a single cell-specific reference signal.
- Closed-loop spatial multiplexing, also known as codebook-based beam-forming or precoding, of up to four layers using cell-specific reference signals. Feedback reports from the terminal are used to assist the eNodeB in selecting a suitable precoding matrix.
- Open-loop spatial multiplexing, also known as large-delay cyclic delay diversity, of up to four layers using cell-specific reference signals.
- Spatial multiplexing of up to eight layers using UE-specific reference signals. The eNodeB may use feedback reports or exploit channel reciprocity to set the beam-forming weights.
- Transmit diversity based on space-frequency block coding (SFBC) or a combination of SFBC and Frequency Switched Transmit Diversity (FSTD).
- Multi-user MIMO where multiple terminals are assigned overlapping time-frequency resources.
- Non-precoded CSI-RS operation is supported, which comprises schemes where different CSI-RS ports have the same wide beam width and direction and hence generally cell wide coverage.
- Beamformed CSI-RS operation is supported, which comprises schemes where (at least at a given time/frequency) CSI-RS ports have narrow beam widths and hence not cell wide coverage, and (at least from the eNB perspective) at least some CSI-RS port-resource combinations have different beam directions.
- Downlink Coordinated MultiPoint (DL-CoMP) operation where multiple transmission points are coordinated.

The following multi-antenna transmission schemes are supported in the uplink:

- Single-antenna transmission.
- Precoding supporting rank-adaptive spatial multiplexing with one up to four layers.
- Uplink Coordinated MultiPoint (UL-CoMP) operation where multiple reception points are coordinated.

1.3.3.5 Link adaptation and power control

According to the radio channel conditions, the Modulation and Coding Scheme (MCS) can be adapted flexibly. The same modulation and coding is applied to all resource units assigned to the same transport block within a TTI. Uplink power control determines the average power over a DFTS-OFDM symbol in which the physical channel is transmitted.

1.3.3.6 L1/L2 control signalling

Downlink control information (DCI) is transmitted on either a PDCCH or an EPDCCH. In bandwidth-reduced operation and/or when using coverage extension mode, a DCI is transmitted on an MPDCCH. For NB-IOT, a DCI is transmitted on NPDCCH.

The PDCCH is transmitted in the first one to three OFDM symbols of each downlink subframe in each component carrier with the number of OFDM symbols being indicated on the PCFICH. Downlink and uplink scheduling grants (consisting of UE identity, time-frequency resources and transport format) and hybrid-ARQ acknowledgements are transmitted on the PDCCH and PHICH, respectively. Each grant is transmitted on a separate PDCCH using QPSK modulation and cell-specific reference signals.

The EPDCCH/MPDCCH is transmitted in pairs of Physical Resource Blocks (PRBs) multiplexed in frequency with the PDSCH; it carries downlink and uplink scheduling grants (consisting of UE identity, time-frequency resources and transport format). The EPDCCH/MPDCCH uses QPSK modulation and demodulation reference signals, and it may use either frequency-localized or frequency-distributed transmission.

For NB-IOT, the NPDCCH is transmitted in all available OFDM symbols of pairs of PRBs, with no multiplexing with NPDSCH; it carries downlink and uplink scheduling grants (consisting of UE identity, time-frequency resources and transport format). The NPDCCH uses QPSK modulation and narrowband reference signals.

Sidelink resource allocation can be transmitted on the PDCCH/EPDCCH.

Uplink control information (UCI), consisting of channel-state information (CSI), scheduling requests and hybrid-ARQ acknowledgements, is transmitted at the band edges of the primary uplink component carrier. Alternatively, parts of the control signalling can be multiplexed with data on PUSCH. To support downlink CoMP transmission, a UE may be configured with multiple CSI processes.

1.3.3.7 MBSFN operation

Multicast/Broadcast over Single Frequency Network (MBSFN) transmission, where the same signal is transmitted from multiple, time-synchronized cells, is supported by the MCH transport channel. One component carrier can support simultaneous unicast and broadcast support through time-domain multiplexing of MCH and DL-SCH transmissions, where the MCH can be configured on up to 80% of the DL resources.

2 Detailed specification of the radio interface technology

Detailed specifications described in this Annex are developed around a Global Core Specification (GCS), which is related to externally developed materials incorporated by specific references for a specific technology. The process and use of the GCS, references, and related notifications and certifications are found as Document IMT-ADV/24(Rev.3).

The IMT-Advanced standards contained in this section are derived from the global core specification for LTE-Advanced contained at <http://ties.itu.int/u/itu-r/ede/rsg5/IMT-Advanced/GCS/M.2012-4/LTE-Advanced/>. The following notes apply to the sections below:

- 1) The identified Transposing Organizations⁹ should make their reference material available from their website.

⁹ The following identified Transposing Organizations have provided their transposed sets of standards information contained in this section:

- 2) This information was supplied by the Transposing Organizations and relates to their own deliverables of the transposed global core specification.

Section 2.1 contains titles and synopses of the Global Core Specification of IMT-Advanced radio interface technology entitled LTE-Advanced and the related hyperlinks to the transposed standards. Specifications listed in § 2.2 are not part of the LTE-Advanced GCS.

-
- Association of Radio Industries and Businesses (ARIB)
 - Alliance for Telecommunications Industry Solutions (ATIS)
 - China Communications Standards Association (CCSA)
 - European Telecommunications Standards Institute (ETSI)
 - Telecommunications Standards Development Society, India (TSDSI)
 - Telecommunications Technology Association (TTA)
 - Telecommunication Technology Committee (TTC).

The specific 3GPP specifications of the GCS for LTE-Advanced that are being transposed in § 2.1 are summarized in Table 1.1:

TABLE 1.1
3GPP specifications in § 2.1 that are to be transposed

36.100 Series	36.200 Series	36.300 Series	36.400 Series	36.500 series	37.xxx Series	25.400 Series
TS 36.101	TS 36.201	TS 36.300	TS 36.401	TS 36.508	TS 37.104	TS 25.460
TS 36.104	TS 36.211	TS 36.302	TS 36.410	TS 36.509	TS 37.105	TS 25.461
TS 36.106	TS 36.212	TS 36.304	TS 36.411	TS 36.521-1	TS 37.113	TS 25.462
TS 36.111	TS 36.213	TS 36.305	TS 36.412	TS 36.521-2	TS 37.114	TS 25.466
TS 36.112	TS 36.214	TS 36.306	TS 36.413	TS 36.521-3	TS 37.141	
TS 36.113	TS 36.216	TS 36.307	TS 36.414	TS 36.523-1	TS 37.144	
TS 36.116		TS 36.314	TS 36.420	TS 36.523-2	TS 37.145-1	
TS 36.117		TS 36.321	TS 36.421	TS 36.523-3	TS 37.145-2	
TS 36.124		TS 36.322	TS 36.422	TS 36.579-1	TS 37.171	
TS 36.133		TS 36.323	TS 36.423	TS 36.579-2	TS 37.320	
TS 36.141		TS 36.331	TS 36.424	TS 36.579-3	TS 37.544	
TS 36.143		TS 36.355	TS 36.425	TS 36.579-4	TS 37.571-1	
TS 36.171		TS 36.360	TS 36.440	TS 36.579-5	TS 37.571-2	
		TS 36.361	TS 36.441		TS 37.571-3	
			TS 36.442		TS 37.571-4	
			TS 36.443		TS 37.571-5	
			TS 36.444			
			TS 36.445			
			TS 36.455			
			TS 36.456			
			TS 36.457			
			TS 36.458			
			TS 36.459			
			TS 36.461			
			TS 36.462			
			TS 36.463			
			TS 36.464			
			TS 36.465			

2.1 Titles and synopses of the global core specification and the transposed standards

2.1.1 Introduction

The standards documents referenced below, as transposed from the relevant 3GPP specifications, are provided by the identified *Transposing Organizations* as the transposed sets of standards for the terrestrial radio interface of IMT-Advanced identified as *LTE-Advanced* and includes not only the key characteristics of IMT-Advanced but also the additional capabilities of *LTE-Advanced* both of which are continuing to be enhanced.

2.1.2 Radio Layer 1

2.1.2.1 TS 36.201

Evolved Universal Terrestrial Radio Access (E-UTRA); LTE physical layer; General description

This document provides a general description of the physical layer of the E-UTRA radio interface. This document also describes the document structure of the 3GPP E-UTRA physical layer specifications, i.e. TS 36.200 series. The TS 36.200 series specifies the Uu point for the LTE mobile system, and defines the minimum level of specifications required for basic connections in terms of mutual connectivity and compatibility.

SDO	Document No.	Version	Issued date	Location
Release 10				
ARIB	ARIB STD-T104-36.201		10.0.0	12.04.2018 http://www.arib.or.jp/english/html/overview/doc/STD-T104v5_20/2_T104/ARIB-STD-T104/Rel10/36/A36201-a00.pdf
ATIS	ATIS.3GPP.36.201V1000		10.0.0	02.05.2019 https://www.atis.org/docstore/
CCSA	CCSA TSD LTE 36.201		10.0.0	14.01.2011 http://www.ccsa.org.cn/ITU_spec/ITU-R/M.2012/M.2012-4/LTE/REL-10/CCSA-TSD-LTE-36201-a00.rar
ETSI	ETSI TS 136 201		10.0.0	14.01.2011 http://www.etsi.org/deliver/etsi_ts/136200_136299/136201/10.00.00_60/ts_136201v100000p.pdf
TSDSI	TSDSI STD T1.3GPP 36.201-10.0.0 V1.0.0		10.0.0	30.05.2019 https://members.tdsi.in/index.php/s/BxBT9C9F8KxobBg
TTA	TTAT.3G-36.201(R10-10.0.0)		10.0.0	26.08.2011 http://www.tta.or.kr/data/ttasDown.jsp?where=14688&pk_num=TTAT.3G-36.201(R10-10.0.0)
Release 11				
ARIB	ARIB STD-T104-36.201		11.1.0	12.04.2018 http://www.arib.or.jp/english/html/overview/doc/STD-T104v5_20/2_T104/ARIB-STD-T104/Rel11/36/A36201-b10.pdf
ATIS	ATIS.3GPP.36.201V1110		11.1.0	02.05.2019 https://www.atis.org/docstore/
CCSA	CCSA TSD LTE 36.201		11.1.0	06.02.2013 http://www.ccsa.org.cn/ITU_spec/ITU-R/M.2012/M.2012-4/LTE/REL-11/CCSA-TSD-LTE-36201-b10.rar
ETSI	ETSI TS 136 201		11.1.0	06.02.2013 http://www.etsi.org/deliver/etsi_ts/136200_136299/136201/11.01.00_60/ts_136201v110100p.pdf
TSDSI	TSDSI STD T1.3GPP 36.201-11.1.0 V1.0.0		11.1.0	30.05.2019 https://members.tdsi.in/index.php/s/BxBT9C9F8KxobBg
TTA	TTAT.3G-36.201(R11-11.1.0)		11.1.0	26.08.2013 http://www.tta.or.kr/data/ttasDown.jsp?where=14688&pk_num=TTAT.3G-36.201(R11-11.1.0)
Release 12				
ARIB	ARIB STD-T104-36.201		12.2.0	12.04.2018 http://www.arib.or.jp/english/html/overview/doc/STD-T104v5_20/2_T104/ARIB-STD-T104/Rel12/36/A36201-c20.pdf
ATIS	ATIS.3GPP.36.201V1220		12.2.0	02.05.2019 https://www.atis.org/docstore/
CCSA	CCSA TSD LTE 36.201		12.2.0	20.04.2015 http://www.ccsa.org.cn/ITU_spec/ITU-R/M.2012/M.2012-4/LTE/REL-12/CCSA-TSD-LTE-36201-c20.rar
ETSI	ETSI TS 136 201		12.2.0	20.04.2015 http://www.etsi.org/deliver/etsi_ts/136200_136299/136201/12.02.00_60/ts_136201v120200p.pdf
TSDSI	TSDSI STD T1.3GPP 36.201-12.2.0 V1.0.0		12.2.0	30.05.2019 https://members.tdsi.in/index.php/s/BxBT9C9F8KxobBg
TTA	TTAT.3G-36.201(R12-12.2.0)		12.2.0	06.07.2017 http://www.tta.or.kr/data/ttasDown.jsp?where=14688&pk_num=TTAT.3G-36.201(R12-12.2.0)
Release 13				
ARIB	ARIB STD-T104-36.201		13.3.0	12.04.2018 http://www.arib.or.jp/english/html/overview/doc/STD-T104v5_20/2_T104/ARIB-STD-T104/Rel13/36/A36201-d30.pdf

ATIS	ATIS.3GPP.36.201V1330	13.3.0	02.05.2019	https://www.atis.org/docstore/
CCSA	CCSA TSD LTE 36.201	13.3.0	11.04.2017	http://www.ccsa.org.cn/ITU_spec/ITU-R/M.2012/M.2012-4/LTE/REL-13/CCSA-TSD-LTE-36201-d30.rar
ETSI	ETSI TS 136 201	13.3.0	11.04.2017	http://www.etsi.org/deliver/etsi_ts/136200_136299/136201/13.03.00_60/ts_136201v130300p.pdf
TSDSI	TSDSI STD T1.3GPP 36.201-13.3.0 V1.0.0	13.3.0	30.05.2019	https://members.tdsi.in/index.php/s/BxBT9C9F8KxobBg
TTA	TTAT.3G-36.201(R13-13.3.0)	13.3.0	10.05.2018	http://www.tta.or.kr/data/ttasDown.jsp?where=14688&pk_num=TTAT.3G-36.201(R13-13.3.0)

Release 14

ARIB	ARIB STD-T104-36.201	14.1.0	12.04.2018	http://www.arib.or.jp/english/html/overview/doc/STD-T104v5_20/2_T104/ARIB-STD-T104/Rel14/36/A36201-e10.pdf
ATIS	ATIS.3GPP.36.201V1410	14.1.0	02.05.2019	https://www.atis.org/docstore/
CCSA	CCSA TSD LTE 36.201	14.1.0	11.01.2019	http://www.ccsa.org.cn/ITU_spec/ITU-R/M.2012/M.2012-4/LTE/REL-14/CCSA-TSD-LTE-36201-e10.zip
ETSI	ETSI TS 136 201	14.1.0	11.04.2017	http://www.etsi.org/deliver/etsi_ts/136200_136299/136201/14.01.00_60/ts_136201v140100p.pdf
TSDSI	TSDSI STD T1.3GPP 36.201-14.1.0 V1.0.0	14.1.0	30.05.2019	https://members.tdsi.in/index.php/s/BxBT9C9F8KxobBg
TTA	TTAT.3G-36.201(R14-14.1.0)	14.1.0	10.05.2018	http://www.tta.or.kr/data/ttasDown.jsp?where=14688&pk_num=TTAT.3G-36.201(R14-14.1.0)

2.1.2.2 TS 36.211**Evolved Universal Terrestrial Radio Access (E-UTRA); Physical channels and modulation**

This document describes the physical channels and modulation for E-UTRA.

SDO	Document No.	Version	Issued date	Location	
Release 10					
ARIB	ARIB STD-T104-36.211		10.7.0	12.04.2018	http://www.arib.or.jp/english/html/overview/doc/STD-T104v5_20/2_T104/ARIB-STD-T104/Rel10/36/A36211-a70.pdf
ATIS	ATIS.3GPP.36.211V1070		10.7.0	02.05.2019	https://www.atis.org/docstore/
CCSA	CCSA TSD LTE 36.211		10.7.0	19.04.2013	http://www.ccsa.org.cn/ITU_spec/ITU-R/M.2012/M.2012-4/LTE/REL-10/CCSA-TSD-LTE-36211-a70.rar
ETSI	ETSI TS 136 211		10.7.0	19.04.2013	http://www.etsi.org/deliver/etsi_ts/136200_136299/136211/10.07.00_60/ts_136211v100700p.pdf
TSDSI	TSDSI STD T1.3GPP 36.211-10.7.0 V1.0.0		10.7.0	30.05.2019	https://members.tdsi.in/index.php/s/BxBT9C9F8KxobBg
TTA	TTAT.3G-36.211(R10-10.7.0)		10.7.0	10.08.2016	http://www.tta.or.kr/data/ttasDown.jsp?where=14688&pk_num=TTAT.3G-36.211(R10-10.7.0)
Release 11					
ARIB	ARIB STD-T104-36.211		11.7.0	12.04.2018	http://www.arib.or.jp/english/html/overview/doc/STD-T104v5_20/2_T104/ARIB-STD-T104/Rel11/36/A36211-b70.pdf
ATIS	ATIS.3GPP.36.211V1170		11.7.0	02.05.2019	https://www.atis.org/docstore/
CCSA	CCSA TSD LTE 36.211		11.7.0	11.04.2017	http://www.ccsa.org.cn/ITU_spec/ITU-R/M.2012/M.2012-4/LTE/REL-11/CCSA-TSD-LTE-36211-b70.rar
ETSI	ETSI TS 136 211		11.7.0	11.04.2017	http://www.etsi.org/deliver/etsi_ts/136200_136299/136211/11.07.00_60/ts_136211v110700p.pdf
TSDSI	TSDSI STD T1.3GPP 36.211-11.7.0 V1.0.0		11.7.0	30.05.2019	https://members.tdsi.in/index.php/s/BxBT9C9F8KxobBg
TTA	TTAT.3G-36.211(R11-11.7.0)		11.7.0	10.05.2018	http://www.tta.or.kr/data/ttasDown.jsp?where=14688&pk_num=TTAT.3G-36.211(R11-11.7.0)
Release 12					
ARIB	ARIB STD-T104-36.211		12.9.0	12.04.2018	http://www.arib.or.jp/english/html/overview/doc/STD-T104v5_20/2_T104/ARIB-STD-T104/Rel12/36/A36211-c90.pdf
ATIS	ATIS.3GPP.36.211V1290		12.9.0	02.05.2019	https://www.atis.org/docstore/
CCSA	CCSA TSD LTE 36.211		12.9.0	11.04.2017	http://www.ccsa.org.cn/ITU_spec/ITU-R/M.2012/M.2012-4/LTE/REL-12/CCSA-TSD-LTE-36211-c90.rar
ETSI	ETSI TS 136 211		12.9.0	11.04.2017	http://www.etsi.org/deliver/etsi_ts/136200_136299/136211/12.09.00_60/ts_136211v120900p.pdf
TSDSI	TSDSI STD T1.3GPP 36.211-12.9.0 V1.0.0		12.9.0	30.05.2019	https://members.tdsi.in/index.php/s/BxBT9C9F8KxobBg
TTA	TTAT.3G-36.211(R12-12.9.0)		12.9.0	10.05.2018	http://www.tta.or.kr/data/ttasDown.jsp?where=14688&pk_num=TTAT.3G-36.211(R12-12.9.0)
Release 13					
ARIB	ARIB STD-T104-36.211		13.8.0	12.04.2018	http://www.arib.or.jp/english/html/overview/doc/STD-T104v5_20/2_T104/ARIB-STD-T104/Rel13/36/A36211-d80.pdf
ATIS	ATIS.3GPP.36.211V1380		13.8.0	02.05.2019	https://www.atis.org/docstore/
CCSA	CCSA TSD LTE 36.211		13.6.0	25.01.2018	http://www.ccsa.org.cn/ITU_spec/ITU-R/M.2012/M.2012-4/LTE/REL-13/CCSA-TSD-LTE-36211-d60.rar

26

ETSI	ETSI TS 136 211	13.8.0	25.01.2018	http://www.etsi.org/deliver/etsi_ts/136200_136299/136211/13.08.00_60/ts_136211v130800p.pdf
TSDSI	TSDSI STD T1.3GPP 36.211-13.8.0 V1.0.0	13.8.0	30.05.2019	https://members.tdsi.in/index.php/s/BxBT9C9F8KxobBg
TTA	TTAT.3G-36.211(R13-13.8.0)	13.8.0	09.05.2019	http://www.tta.or.kr/data/ttasDown.jsp?where=14688&pk_num=TTAT.3G-36.211(R13-13.8.0)

Release 14

ARIB	ARIB STD-T104-36.211	14.5.0	12.04.2018	http://www.arib.or.jp/english/html/overview/doc/STD-T104v5_20/2_T104/ARIB-STD-T104/Rel14/36/A36211-e50.pdf
ATIS	ATIS.3GPP.36.211V1450	14.5.0	02.05.2019	https://www.atis.org/docstore/
CCSA	CCSA TSD LTE 36.211	14.5.0	11.01.2019	http://www.ccsa.org.cn/ITU_spec/ITU-R/M.2012/M.2012-4/LTE/REL-14/CCSA-TSD-LTE-36211-e50.zip
ETSI	ETSI TS 136 211	14.5.0	25.01.2018	http://www.etsi.org/deliver/etsi_ts/136200_136299/136211/14.05.00_60/ts_136211v140500p.pdf
TSDSI	TSDSI STD T1.3GPP 36.211-14.5.0 V1.0.0	14.5.0	30.05.2019	https://members.tdsi.in/index.php/s/BxBT9C9F8KxobBg
TTA	TTAT.3G-36.211(R14-14.5.0)	14.5.0	09.05.2019	http://www.tta.or.kr/data/ttasDown.jsp?where=14688&pk_num=TTAT.3G-36.211(R14-14.5.0)

2.1.2.3 TS 36.212

Evolved Universal Terrestrial Radio Access (E-UTRA); Multiplexing and channel coding

This document specifies the coding, multiplexing and mapping to physical channels for E-UTRA.

SDO	Document No.	Version	Issued date	Location
Release 10				
ARIB	ARIB STD-T104-36.212	10.9.0	12.04.2018	http://www.arib.or.jp/english/html/overview/doc/STD-T104v5_20/2_T104/ARIB-STD-T104/Rel10/36/A36212-a90.pdf
ATIS	ATIS.3GPP.36.212V1090	10.9.0	02.05.2019	https://www.atis.org/docstore/
CCSA	CCSA TSD LTE 36.212	10.9.0	19.10.2015	http://www.ccsa.org.cn/ITU_spec/ITU-R/M.2012/M.2012-4/LTE/REL-10/CCSA-TSD-LTE-36212-a90.rar
ETSI	ETSI TS 136 212	10.9.0	19.10.2015	http://www.etsi.org/deliver/etsi_ts/136200_136299/136212/10.09.00_60/ts_136212v100900p.pdf
TSDSI	TSDSI STD T1.3GPP 36.212-10.9.0 V1.0.0	10.9.0	30.05.2019	https://members.tdsi.in/index.php/s/BxBT9C9F8KxobBg
TTA	TTAT.3G-36.212(R10-10.9.0)	10.9.0	06.07.2017	http://www.tta.or.kr/data/ttasDown.jsp?where=14688&pk_num=TTAT.3G-36.212(R10-10.9.0)
Release 11				
ARIB	ARIB STD-T104-36.212	11.7.0	12.04.2018	http://www.arib.or.jp/english/html/overview/doc/STD-T104v5_20/2_T104/ARIB-STD-T104/Rel11/36/A36212-b70.pdf
ATIS	ATIS.3GPP.36.212V1170	11.7.0	02.05.2019	https://www.atis.org/docstore/
CCSA	CCSA TSD LTE 36.212	11.7.0	22.04.2016	http://www.ccsa.org.cn/ITU_spec/ITU-R/M.2012/M.2012-4/LTE/REL-11/CCSA-TSD-LTE-36212-b70.rar
ETSI	ETSI TS 136 212	11.7.0	22.04.2016	http://www.etsi.org/deliver/etsi_ts/136200_136299/136212/11.07.00_60/ts_136212v110700p.pdf
TSDSI	TSDSI STD T1.3GPP 36.212-11.7.0 V1.0.0	11.7.0	30.05.2019	https://members.tdsi.in/index.php/s/BxBT9C9F8KxobBg
TTA	TTAT.3G-36.212(R11-11.7.0)	11.7.0	06.07.2017	http://www.tta.or.kr/data/ttasDown.jsp?where=14688&pk_num=TTAT.3G-36.212(R11-11.7.0)
Release 12				
ARIB	ARIB STD-T104-36.212	12.9.1	12.04.2018	http://www.arib.or.jp/english/html/overview/doc/STD-T104v5_20/2_T104/ARIB-STD-T104/Rel12/36/A36212-c91.pdf
ATIS	ATIS.3GPP.36.212V1291	12.9.1	02.05.2019	https://www.atis.org/docstore/
CCSA	CCSA TSD LTE 36.212	12.8.0	25.01.2018	http://www.ccsa.org.cn/ITU_spec/ITU-R/M.2012/M.2012-4/LTE/REL-12/CCSA-TSD-LTE-36212-c80.rar
ETSI	ETSI TS 136 212	12.9.1	25.01.2018	http://www.etsi.org/deliver/etsi_ts/136200_136299/136212/12.09.01_60/ts_136212v120901p.pdf
TSDSI	TSDSI STD T1.3GPP 36.212-12.9.1 V1.0.0	12.9.1	30.05.2019	https://members.tdsi.in/index.php/s/BxBT9C9F8KxobBg
TTA	TTAT.3G-36.212(R12-12.9.1)	12.9.1	09.05.2019	http://www.tta.or.kr/data/ttasDown.jsp?where=14688&pk_num=TTAT.3G-36.212(R12-12.9.1)
Release 13				
ARIB	ARIB STD-T104-36.212	13.7.1	12.04.2018	http://www.arib.or.jp/english/html/overview/doc/STD-T104v5_20/2_T104/ARIB-STD-T104/Rel13/36/A36212-d71.pdf
ATIS	ATIS.3GPP.36.212V1371	13.7.1	02.05.2019	https://www.atis.org/docstore/
CCSA	CCSA TSD LTE 36.212	13.6.0	26.01.2018	http://www.ccsa.org.cn/ITU_spec/ITU-R/M.2012/M.2012-4/LTE/REL-13/CCSA-TSD-LTE-36212-d60.rar
ETSI	ETSI TS 136 212	13.7.1	26.01.2018	http://www.etsi.org/deliver/etsi_ts/136200_136299/136212/13.07.01_60/ts_136212v130701p.pdf
TSDSI	TSDSI STD T1.3GPP 36.212-13.7.1 V1.0.0	13.7.1	30.05.2019	https://members.tdsi.in/index.php/s/BxBT9C9F8KxobBg

TTA	TTAT.3G-36.212(R13-13.7.1)	13.7.1	09.05.2019	http://www.tta.or.kr/data/ttasDown.jsp?where=14688&pk_num=TTAT.3G-36.212(R13-13.7.1)
Release 14				
ARIB	ARIB STD-T104-36.212	14.5.1	12.04.2018	http://www.arib.or.jp/english/html/overview/doc/STD-T104v5_20/2_T104/ARIB-STD-T104/Rel14/36/A36212-e51.pdf
ATIS	ATIS.3GPP.36.212V1451	14.5.1	02.05.2019	https://www.atis.org/docstore/
CCSA	CCSA TSD LTE 36.212	14.5.1	11.01.2019	http://www.ccsa.org.cn/ITU_spec/ITU-R/M.2012/M.2012-4/LTE/REL-14/CCSA-TSD-LTE-36212-e51.zip
ETSI	ETSI TS 136 212	14.5.1	25.01.2018	http://www.etsi.org/deliver/etsi_ts/136200_136299/136212/14.05.01_60/ts_136212v140501p.pdf
TSDSI	TSDSI STD T1.3GPP 36.212-14.5.1 V1.0.0	14.5.1	30.05.2019	https://members.tdsi.in/index.php/s/BxBT9C9F8KxobBg
TTA	TTAT.3G-36.212(R14-14.5.1)	14.5.1	09.05.2019	http://www.tta.or.kr/data/ttasDown.jsp?where=14688&pk_num=TTAT.3G-36.212(R14-14.5.1)

2.1.2.4 TS 36.213

Evolved Universal Terrestrial Radio Access (E-UTRA); Physical layer procedures

This document specifies and establishes the characteristics of the physical layer procedures for E-UTRA.

SDO	Document No.	Version	Issued date	Location
Release 10				
ARIB	ARIB STD-T104-36.213		10.13.0	12.04.2018 http://www.arib.or.jp/english/html/overview/doc/STD-T104v5_20/2_T104/ARIB-STD-T104/Rel10/36/A36213-ad0.pdf
ATIS	ATIS.3GPP.36.213V10130		10.13.0	02.05.2019 https://www.atis.org/docstore/
CCSA	CCSA TSD LTE 36.213		10.13.0	27.07.2015 http://www.ccsa.org.cn/ITU_spec/ITU-R/M.2012/M.2012-4/LTE/REL-10/CCSA-TSD-LTE-36213-ad0.rar
ETSI	ETSI TS 136 213		10.13.0	27.07.2015 http://www.etsi.org/deliver/etsi_ts/136200_136299/136213/10.13.00_60/ts_136213v101300p.pdf
TSDSI	TSDSI STD T1.3GPP 36.213-10.13.0 V1.0.0		10.13.0	30.05.2019 https://members.tdsi.in/index.php/s/BxBT9C9F8KxobBg
TTA	TTAT.3G-36.213(R10-10.13.0)		10.13.0	06.07.2017 http://www.tta.or.kr/data/ttasDown.jsp?where=14688&pk_num=TTAT.3G-36.213(R10-10.13.0)
Release 11				
ARIB	ARIB STD-T104-36.213		11.13.0	12.04.2018 http://www.arib.or.jp/english/html/overview/doc/STD-T104v5_20/2_T104/ARIB-STD-T104/Rel11/36/A36213-bd0.pdf
ATIS	ATIS.3GPP.36.213V11130		11.13.0	02.05.2019 https://www.atis.org/docstore/
CCSA	CCSA TSD LTE 36.213		11.12.0	10.10.2017 http://www.ccsa.org.cn/ITU_spec/ITU-R/M.2012/M.2012-4/LTE/REL-11/CCSA-TSD-LTE-36213-bc0.rar
ETSI	ETSI TS 136 213		11.13.0	10.10.2017 http://www.etsi.org/deliver/etsi_ts/136200_136299/136213/11.13.00_60/ts_136213v111300p.pdf
TSDSI	TSDSI STD T1.3GPP 36.213-11.13.0 V1.0.0		11.13.0	30.05.2019 https://members.tdsi.in/index.php/s/BxBT9C9F8KxobBg
TTA	TTAT.3G-36.213(R11-11.13.0)		11.13.0	10.05.2018 http://www.tta.or.kr/data/ttasDown.jsp?where=14688&pk_num=TTAT.3G-36.213(R11-11.13.0)
Release 12				
ARIB	ARIB STD-T104-36.213		12.12.0	12.04.2018 http://www.arib.or.jp/english/html/overview/doc/STD-T104v5_20/2_T104/ARIB-STD-T104/Rel12/36/A36213-cc0.pdf
ATIS	ATIS.3GPP.36.213V12120		12.12.0	02.05.2019 https://www.atis.org/docstore/
CCSA	CCSA TSD LTE 36.213		12.11.0	26.10.2017 http://www.ccsa.org.cn/ITU_spec/ITU-R/M.2012/M.2012-4/LTE/REL-12/CCSA-TSD-LTE-36213-cb0.rar
ETSI	ETSI TS 136 213		12.12.0	26.10.2017 http://www.etsi.org/deliver/etsi_ts/136200_136299/136213/12.12.00_60/ts_136213v121200p.pdf
TSDSI	TSDSI STD T1.3GPP 36.213-12.12.0 V1.0.0		12.12.0	30.05.2019 https://members.tdsi.in/index.php/s/BxBT9C9F8KxobBg
TTA	TTAT.3G-36.213(R12-12.12.0)		12.12.0	10.05.2018 http://www.tta.or.kr/data/ttasDown.jsp?where=14688&pk_num=TTAT.3G-36.213(R12-12.12.0)
Release 13				
ARIB	ARIB STD-T104-36.213		13.8.0	12.04.2018 http://www.arib.or.jp/english/html/overview/doc/STD-T104v5_20/2_T104/ARIB-STD-T104/Rel13/36/A36213-d80.pdf
ATIS	ATIS.3GPP.36.213V1380		13.8.0	02.05.2019 https://www.atis.org/docstore/
CCSA	CCSA TSD LTE 36.213		13.6.0	26.01.2018 http://www.ccsa.org.cn/ITU_spec/ITU-R/M.2012/M.2012-4/LTE/REL-13/CCSA-TSD-LTE-36213-d60.rar
ETSI	ETSI TS 136 213		13.8.0	26.01.2018 http://www.etsi.org/deliver/etsi_ts/136200_136299/136213/13.08.00_60/ts_136213v130800p.pdf
TSDSI	TSDSI STD T1.3GPP 36.213-13.8.0 V1.0.0		13.8.0	30.05.2019 https://members.tdsi.in/index.php/s/BxBT9C9F8KxobBg
TTA	TTAT.3G-36.213(R13-13.8.0)		13.8.0	09.05.2019 http://www.tta.or.kr/data/ttasDown.jsp?where=14688&pk_num=TTAT.3G-36.213(R13-13.8.0)

Release 14

ARIB	ARIB STD-T104-36.213	14.5.0	12.04.2018	http://www.arib.or.jp/english/html/overview/doc/STD-T104v5_20/2_T104/ARIB-STD-T104/Rel14/36/A36213-e50.pdf
ATIS	ATIS.3GPP.36.213V1450	14.5.0	02.05.2019	https://www.atis.org/docstore/
CCSA	CCSA TSD LTE 36.213	14.5.0	11.01.2019	http://www.ccsa.org.cn/ITU_spec/ITU-R/M.2012/M.2012-4/LTE/REL-14/CCSA-TSD-LTE-36213-e50.zip
ETSI	ETSI TS 136 213	14.5.0	26.01.2018	http://www.etsi.org/deliver/etsi_ts/136200_136299/136213/14.05.00_60/ts_136213v140500p.pdf
TSDSI	TSDSI STD T1.3GPP 36.213-14.5.0 V1.0.0	14.5.0	30.05.2019	https://members.tdsi.in/index.php/s/BxBT9C9F8KxobBg
TTA	TTAT.3G-36.213(R14-14.5.0)	14.5.0	09.05.2019	http://www.tta.or.kr/data/ttasDown.jsp?where=14688&pk_num=TTAT.3G-36.213(R14-14.5.0)

2.1.2.5 TS 36.214**Evolved Universal Terrestrial Radio Access (E-UTRA); Physical layer; Measurements**

This document contains the description and definition of the measurements done at the UE and network in order to support operation in idle mode and connected mode in E-UTRA.

SDO	Document No.	Version	Issued date	Location
Release 10				
ARIB	ARIB STD-T104-36.214	10.1.0	12.04.2018	http://www.arib.or.jp/english/html/overview/doc/STD-T104v5_20/2_T104/ARIB-STD-T104/Rel10/36/A36214-a10.pdf
ATIS	ATIS.3GPP.36.214V1010	10.1.0	02.05.2019	https://www.atis.org/docstore/
CCSA	CCSA TSD LTE 36.214	10.1.0	04.04.2011	http://www.ccsa.org.cn/ITU_spec/ITU-R/M.2012/M.2012-4/LTE/REL-10/CCSA-TSD-LTE-36214-a10.rar
ETSI	ETSI TS 136 214	10.1.0	04.04.2011	http://www.etsi.org/deliver/etsi_ts/136200_136299/136214/10.01.00_60/ts_136214v100100p.pdf
TSDSI	TSDSI STD T1.3GPP 36.214-10.1.0 V1.0.0	10.1.0	30.05.2019	https://members.tdsi.in/index.php/s/BxBT9C9F8KxobBg
TTA	TTAT.3G-36.214(R10-10.1.0)	10.1.0	26.08.2011	http://www.tta.or.kr/data/ttasDown.jsp?where=14688&pk_num=TTAT.3G-36.214(R10-10.1.0)
Release 11				
ARIB	ARIB STD-T104-36.214	11.1.0	12.04.2018	http://www.arib.or.jp/english/html/overview/doc/STD-T104v5_20/2_T104/ARIB-STD-T104/Rel11/36/A36214-b10.pdf
ATIS	ATIS.3GPP.36.214V1110	11.1.0	02.05.2019	https://www.atis.org/docstore/
CCSA	CCSA TSD LTE 36.214	11.1.0	06.02.2013	http://www.ccsa.org.cn/ITU_spec/ITU-R/M.2012/M.2012-4/LTE/REL-11/CCSA-TSD-LTE-36214-b10.rar
ETSI	ETSI TS 136 214	11.1.0	06.02.2013	http://www.etsi.org/deliver/etsi_ts/136200_136299/136214/11.01.00_60/ts_136214v110100p.pdf
TSDSI	TSDSI STD T1.3GPP 36.214-11.1.0 V1.0.0	11.1.0	30.05.2019	https://members.tdsi.in/index.php/s/BxBT9C9F8KxobBg
TTA	TTAT.3G-36.214(R11-11.1.0)	11.1.0	26.08.2013	http://www.tta.or.kr/data/ttasDown.jsp?where=14688&pk_num=TTAT.3G-36.214(R11-11.1.0)
Release 12				
ARIB	ARIB STD-T104-36.214	12.3.0	12.04.2018	http://www.arib.or.jp/english/html/overview/doc/STD-T104v5_20/2_T104/ARIB-STD-T104/Rel12/36/A36214-c30.pdf
ATIS	ATIS.3GPP.36.214V1230	12.3.0	02.05.2019	https://www.atis.org/docstore/
CCSA	CCSA TSD LTE 36.214	12.3.0	06.10.2016	http://www.ccsa.org.cn/ITU_spec/ITU-R/M.2012/M.2012-4/LTE/REL-12/CCSA-TSD-LTE-36214-c30.rar
ETSI	ETSI TS 136 214	12.3.0	06.10.2016	http://www.etsi.org/deliver/etsi_ts/136200_136299/136214/12.03.00_60/ts_136214v120300p.pdf
TSDSI	TSDSI STD T1.3GPP 36.214-12.3.0 V1.0.0	12.3.0	30.05.2019	https://members.tdsi.in/index.php/s/BxBT9C9F8KxobBg
TTA	TTAT.3G-36.214(R12-12.3.0)	12.3.0	06.07.2017	http://www.tta.or.kr/data/ttasDown.jsp?where=14688&pk_num=TTAT.3G-36.214(R12-12.3.0)
Release 13				
ARIB	ARIB STD-T104-36.214	13.5.0	12.04.2018	http://www.arib.or.jp/english/html/overview/doc/STD-T104v5_20/2_T104/ARIB-STD-T104/Rel13/36/A36214-d50.pdf
ATIS	ATIS.3GPP.36.214V1350	13.5.0	02.05.2019	https://www.atis.org/docstore/
CCSA	CCSA TSD LTE 36.214	13.4.0	09.10.2017	http://www.ccsa.org.cn/ITU_spec/ITU-R/M.2012/M.2012-4/LTE/REL-13/CCSA-TSD-LTE-36214-d40.rar
ETSI	ETSI TS 136 214	13.5.0	09.10.2017	http://www.etsi.org/deliver/etsi_ts/136200_136299/136214/13.05.00_60/ts_136214v130500p.pdf
TSDSI	TSDSI STD T1.3GPP 36.214-13.5.0 V1.0.0	13.5.0	30.05.2019	https://members.tdsi.in/index.php/s/BxBT9C9F8KxobBg
TTA	TTAT.3G-36.214(R13-13.5.0)	13.5.0	10.05.2018	http://www.tta.or.kr/data/ttasDown.jsp?where=14688&pk_num=TTAT.3G-36.214(R13-13.5.0)

Release 14

ARIB	ARIB STD-T104-36.214	14.4.0	12.04.2018	http://www.arib.or.jp/english/html/overview/doc/STD-T104v5_20/2_T104/ARIB-STD-T104/Rel14/36/A36214-e40.pdf
ATIS	ATIS.3GPP.36.214V1440	14.4.0	02.05.2019	https://www.atis.org/docstore/
CCSA	CCSA TSD LTE 36.214	14.4.0	11.01.2019	http://www.ccsa.org.cn/ITU_spec/ITU-R/M.2012/M.2012-4/LTE/REL-14/CCSA-TSD-LTE-36214-e40.zip
ETSI	ETSI TS 136 214	14.4.0	17.01.2018	http://www.etsi.org/deliver/etsi_ts/136200_136299/136214/14.04.00_60/ts_136214v140400p.pdf
TSDSI	TSDSI STD T1.3GPP 36.214-14.4.0 V1.0.0	14.4.0	30.05.2019	https://members.tdsi.in/index.php/s/BxBT9C9F8KxobBg
TTA	TTAT.3G-36.214(R14-14.4.0)	14.4.0	09.05.2019	http://www.tta.or.kr/data/ttasDown.jsp?where=14688&pk_num=TTAT.3G-36.214(R14-14.4.0)

2.1.2.6 TS 36.216**Evolved Universal Terrestrial Radio Access (E-UTRA); Physical layer for relaying operation**

This document describes the characteristics of eNodeB – relay node transmissions.

SDO	Document No.	Version	Issued date	Location	
Release 10					
ARIB	ARIB STD-T104-36.216		10.3.1	12.04.2018	http://www.arib.or.jp/english/html/overview/doc/STD-T104v5_20/2_T104/ARIB-STD-T104/Rel10/36/A36216-a31.pdf
ATIS	ATIS.3GPP.36.216V1031		10.3.1	02.05.2019	https://www.atis.org/docstore/
CCSA	CCSA TSD LTE 36.216		10.3.1	21.10.2011	http://www.ccsa.org.cn/ITU_spec/ITU-R/M.2012/M.2012-4/LTE/REL-10/CCSA-TSD-LTE-36216-a31.rar
ETSI	ETSI TS 136 216		10.3.1	21.10.2011	http://www.etsi.org/deliver/etsi_ts/136200_136299/136216/10.03.01_60/ts_136216v100301p.pdf
TSDSI	TSDSI STD T1.3GPP 36.216-10.3.1 V1.0.0		10.3.1	30.05.2019	https://members.tdsi.in/index.php/s/BxBT9C9F8KxobBg
TTA	TTAT.3G-36.216(R10-10.3.1)		10.3.1	22.08.2012	http://www.tta.or.kr/data/ttasDown.jsp?where=14688&pk_num=TTAT.3G-36.216(R10-10.3.1)
Release 11					
ARIB	ARIB STD-T104-36.216		11.0.0	12.04.2018	http://www.arib.or.jp/english/html/overview/doc/STD-T104v5_20/2_T104/ARIB-STD-T104/Rel11/36/A36216-b00.pdf
ATIS	ATIS.3GPP.36.216V1100		11.0.0	02.05.2019	https://www.atis.org/docstore/
CCSA	CCSA TSD LTE 36.216		11.0.0	02.10.2012	http://www.ccsa.org.cn/ITU_spec/ITU-R/M.2012/M.2012-4/LTE/REL-11/CCSA-TSD-LTE-36216-b00.rar
ETSI	ETSI TS 136 216		11.0.0	02.10.2012	http://www.etsi.org/deliver/etsi_ts/136200_136299/136216/11.00.00_60/ts_136216v110000p.pdf
TSDSI	TSDSI STD T1.3GPP 36.216-11.0.0 V1.0.0		11.0.0	30.05.2019	https://members.tdsi.in/index.php/s/BxBT9C9F8KxobBg
TTA	TTAT.3G-36.216(R11-11.0.0)		11.0.0	26.08.2013	http://www.tta.or.kr/data/ttasDown.jsp?where=14688&pk_num=TTAT.3G-36.216(R11-11.0.0)
Release 12					
ARIB	ARIB STD-T104-36.216		12.0.0	12.04.2018	http://www.arib.or.jp/english/html/overview/doc/STD-T104v5_20/2_T104/ARIB-STD-T104/Rel12/36/A36216-c00.pdf
ATIS	ATIS.3GPP.36.216V1200		12.0.0	02.05.2019	https://www.atis.org/docstore/
CCSA	CCSA TSD LTE 36.216		12.0.0	02.10.2014	http://www.ccsa.org.cn/ITU_spec/ITU-R/M.2012/M.2012-4/LTE/REL-12/CCSA-TSD-LTE-36216-c00.rar
ETSI	ETSI TS 136 216		12.0.0	02.10.2014	http://www.etsi.org/deliver/etsi_ts/136200_136299/136216/12.00.00_60/ts_136216v120000p.pdf
TSDSI	TSDSI STD T1.3GPP 36.216-12.0.0 V1.0.0		12.0.0	30.05.2019	https://members.tdsi.in/index.php/s/BxBT9C9F8KxobBg
TTA	TTAT.3G-36.216(R12-12.0.0)		12.0.0	09.04.2015	http://www.tta.or.kr/data/ttasDown.jsp?where=14688&pk_num=TTAT.3G-36.216(R12-12.0.0)
Release 13					
ARIB	ARIB STD-T104-36.216		13.0.0	12.04.2018	http://www.arib.or.jp/english/html/overview/doc/STD-T104v5_20/2_T104/ARIB-STD-T104/Rel13/36/A36216-d00.pdf
ATIS	ATIS.3GPP.36.216V1300		13.0.0	02.05.2019	https://www.atis.org/docstore/
CCSA	CCSA TSD LTE 36.216		13.0.0	26.01.2016	http://www.ccsa.org.cn/ITU_spec/ITU-R/M.2012/M.2012-4/LTE/REL-13/CCSA-TSD-LTE-36216-d00.rar
ETSI	ETSI TS 136 216		13.0.0	26.01.2016	http://www.etsi.org/deliver/etsi_ts/136200_136299/136216/13.00.00_60/ts_136216v130000p.pdf
TSDSI	TSDSI STD T1.3GPP 36.216-13.0.0 V1.0.0		13.0.0	30.05.2019	https://members.tdsi.in/index.php/s/BxBT9C9F8KxobBg
TTA	TTAT.3G-36.216(R13-13.0.0)		13.0.0	06.07.2017	http://www.tta.or.kr/data/ttasDown.jsp?where=14688&pk_num=TTAT.3G-36.216(R13-13.0.0)

Release 14

ARIB	ARIB STD-T104-36.216	14.0.0	12.04.2018	http://www.arib.or.jp/english/html/overview/doc/STD-T104v5_20/2_T104/ARIB-STD-T104/Rel14/36/A36216-e00.pdf
ATIS	ATIS.3GPP.36.216V1400	14.0.0	02.05.2019	https://www.atis.org/docstore/
CCSA	CCSA TSD LTE 36.216	14.0.0	11.01.2019	http://www.ccsa.org.cn/ITU_spec/ITU-R/M.2012/M.2012-4/LTE/REL-14/CCSA-TSD-LTE-36216-e00.zip
ETSI	ETSI TS 136 216	14.0.0	11.04.2017	http://www.etsi.org/deliver/etsi_ts/136200_136299/136216/14.00.00_60/ts_136216v140000p.pdf
TSDSI	TSDSI STD T1.3GPP 36.216-14.0.0 V1.0.0	14.0.0	30.05.2019	https://members.tdsi.in/index.php/s/BxBT9C9F8KxobBg
TTA	TTAT.3G-36.216(R14-14.0.0)	14.0.0	10.05.2018	http://www.tta.or.kr/data/ttasDown.jsp?where=14688&pk_num=TTAT.3G-36.216(R14-14.0.0)

2.1.3 Radio Layers 2 & 3**2.1.3.1 TS 36.300****Evolved Universal Terrestrial Radio Access (E-UTRA) and Evolved Universal Terrestrial Radio Access Network (E-UTRAN); Overall description; Stage 2**

This document provides an overview and overall description of the E-UTRAN radio interface protocol architecture. Details of the radio interface protocols are specified in companion specifications of the 36 series.

SDO	Document No.	Version	Issued date	Location	
Release 10					
ARIB	ARIB STD-T104-36.300		10.12.0	12.04.2018	http://www.arib.or.jp/english/html/overview/doc/STD-T104v5_20/2_T104/ARIB-STD-T104/Rel10/36/A36300-ac0.pdf
ATIS	ATIS.3GPP.36.300V10120		10.12.0	02.05.2019	https://www.atis.org/docstore/
CCSA	CCSA TSD LTE 36.300		10.12.0	04.02.2015	http://www.ccsa.org.cn/ITU_spec/ITU-R/M.2012/M.2012-4/LTE/REL-10/CCSA-TSD-LTE-36300-ac0.rar
ETSI	ETSI TS 136 300		10.12.0	04.02.2015	http://www.etsi.org/deliver/etsi_ts/136300_136399/136300/10.12.00_60/ts_136300v101200p.pdf
TSDSI	TSDSI STD T1.3GPP 36.300-10.12.0 V1.0.0		10.12.0	30.05.2019	https://members.tdsi.in/index.php/s/BxBT9C9F8KxobBg
TTA	TTAT.3G-36.300(R10-10.12.0)		10.12.0	10.08.2016	http://www.tta.or.kr/data/ttasDown.jsp?where=14688&pk_num=TTAT.3G-36.300(R10-10.12.0)
Release 11					
ARIB	ARIB STD-T104-36.300		11.14.0	12.04.2018	http://www.arib.or.jp/english/html/overview/doc/STD-T104v5_20/2_T104/ARIB-STD-T104/Rel11/36/A36300-be0.pdf
ATIS	ATIS.3GPP.36.300V11140		11.14.0	02.05.2019	https://www.atis.org/docstore/
CCSA	CCSA TSD LTE 36.300		11.14.0	18.01.2016	http://www.ccsa.org.cn/ITU_spec/ITU-R/M.2012/M.2012-4/LTE/REL-11/CCSA-TSD-LTE-36300-be0.rar
ETSI	ETSI TS 136 300		11.14.0	18.01.2016	http://www.etsi.org/deliver/etsi_ts/136300_136399/136300/11.14.00_60/ts_136300v111400p.pdf
TSDSI	TSDSI STD T1.3GPP 36.300-11.14.0 V1.0.0		11.14.0	30.05.2019	https://members.tdsi.in/index.php/s/BxBT9C9F8KxobBg
TTA	TTAT.3G-36.300(R11-11.14.0)		11.14.0	06.07.2017	http://www.tta.or.kr/data/ttasDown.jsp?where=14688&pk_num=TTAT.3G-36.300(R11-11.14.0)
Release 12					
ARIB	ARIB STD-T104-36.300		12.10.0	12.04.2018	http://www.arib.or.jp/english/html/overview/doc/STD-T104v5_20/2_T104/ARIB-STD-T104/Rel12/36/A36300-ca0.pdf
ATIS	ATIS.3GPP.36.300V12100		12.10.0	02.05.2019	https://www.atis.org/docstore/
CCSA	CCSA TSD LTE 36.300		12.10.0	24.08.2016	http://www.ccsa.org.cn/ITU_spec/ITU-R/M.2012/M.2012-4/LTE/REL-12/CCSA-TSD-LTE-36300-ca0.rar
ETSI	ETSI TS 136 300		12.10.0	24.08.2016	http://www.etsi.org/deliver/etsi_ts/136300_136399/136300/12.10.00_60/ts_136300v121000p.pdf
TSDSI	TSDSI STD T1.3GPP 36.300-12.10.0 V1.0.0		12.10.0	30.05.2019	https://members.tdsi.in/index.php/s/BxBT9C9F8KxobBg
TTA	TTAT.3G-36.300(R12-12.10.0)		12.10.0	06.07.2017	http://www.tta.or.kr/data/ttasDown.jsp?where=14688&pk_num=TTAT.3G-36.300(R12-12.10.0)
Release 13					
ARIB	ARIB STD-T104-36.300		13.10.0	12.04.2018	http://www.arib.or.jp/english/html/overview/doc/STD-T104v5_20/2_T104/ARIB-STD-T104/Rel13/36/A36300-da0.pdf
ATIS	ATIS.3GPP.36.300V13100		13.10.0	02.05.2019	https://www.atis.org/docstore/
CCSA	CCSA TSD LTE 36.300		13.8.0	17.01.2018	http://www.ccsa.org.cn/ITU_spec/ITU-R/M.2012/M.2012-4/LTE/REL-13/CCSA-TSD-LTE-36300-d80.rar
ETSI	ETSI TS 136 300		13.10.0	17.01.2018	http://www.etsi.org/deliver/etsi_ts/136300_136399/136300/13.10.00_60/ts_136300v131000p.pdf

TSDSI	TSDSI STD T1.3GPP 36.300-13.10.0 V1.0.0	13.10.0	30.05.2019	https://members.tdsi.in/index.php/s/BxBT9C9F8KxobBg
TTA	TTAT.3G-36.300(R13-13.10.0)	13.10.0	09.05.2019	http://www.tta.or.kr/data/ttasDown.jsp?where=14688&pk_num=TTAT.3G-36.300(R13-13.10.0)

Release 14

ARIB	ARIB STD-T104-36.300	14.5.0	12.04.2018	http://www.arib.or.jp/english/html/overview/doc/STD-T104v5_20/2_T104/ARIB-STD-T104/Rel14/36/A36300-e50.pdf
ATIS	ATIS.3GPP.36.300V1450	14.5.0	02.05.2019	https://www.atis.org/docstore/
CCSA	CCSA TSD LTE 36.300	14.5.0	11.01.2019	http://www.ccsa.org.cn/ITU_spec/ITU-R/M.2012/M.2012-4/LTE/REL-14/CCSA-TSD-LTE-36300-e50.zip
ETSI	ETSI TS 136 300	14.5.0	17.01.2018	http://www.etsi.org/deliver/etsi_ts/136300_136399/136300/14.05.00_60/ts_136300v140500p.pdf
TSDSI	TSDSI STD T1.3GPP 36.300-14.5.0 V1.0.0	14.5.0	30.05.2019	https://members.tdsi.in/index.php/s/BxBT9C9F8KxobBg
TTA	TTAT.3G-36.300(R14-14.5.0)	14.5.0	09.05.2019	http://www.tta.or.kr/data/ttasDown.jsp?where=14688&pk_num=TTAT.3G-36.300(R14-14.5.0)

2.1.3.2 TS 36.302**Evolved Universal Terrestrial Radio Access (E-UTRA); Services provided by the physical layer**

This document is a technical specification of the services provided by the physical layer of E-UTRA to upper layers.

SDO	Document No.	Version	Issued date	Location
Release 10				
ARIB	ARIB STD-T104-36.302	10.6.0	12.04.2018	http://www.arib.or.jp/english/html/overview/doc/STD-T104v5_20/2_T104/ARIB-STD-T104/Rel10/36/A36302-a60.pdf
ATIS	ATIS.3GPP.36.302V1060	10.6.0	02.05.2019	https://www.atis.org/docstore/
CCSA	CCSA TSD LTE 36.302	10.6.0	25.09.2013	http://www.ccsa.org.cn/ITU_spec/ITU-R/M.2012/M.2012-4/LTE/REL-10/CCSA-TSD-LTE-36302-a60.rar
ETSI	ETSI TS 136 302	10.6.0	25.09.2013	http://www.etsi.org/deliver/etsi_ts/136300_136399/136302/10.06.00_60/ts_136302v100600p.pdf
TSDSI	TSDSI STD T1.3GPP 36.302-10.6.0 V1.0.0	10.6.0	30.05.2019	https://members.tdsi.in/index.php/s/BxBT9C9F8KxobBg
TTA	TTAT.3G-36.302(R10-10.6.0)	10.6.0	10.08.2016	http://www.tta.or.kr/data/ttasDown.jsp?where=14688&pk_num=TTAT.3G-36.302(R10-10.6.0)
Release 11				
ARIB	ARIB STD-T104-36.302	11.5.0	12.04.2018	http://www.arib.or.jp/english/html/overview/doc/STD-T104v5_20/2_T104/ARIB-STD-T104/Rel11/36/A36302-b50.pdf
ATIS	ATIS.3GPP.36.302V1150	11.5.0	02.05.2019	https://www.atis.org/docstore/
CCSA	CCSA TSD LTE 36.302	11.5.0	26.03.2014	http://www.ccsa.org.cn/ITU_spec/ITU-R/M.2012/M.2012-4/LTE/REL-11/CCSA-TSD-LTE-36302-b50.rar
ETSI	ETSI TS 136 302	11.5.0	26.03.2014	http://www.etsi.org/deliver/etsi_ts/136300_136399/136302/11.05.00_60/ts_136302v110500p.pdf
TSDSI	TSDSI STD T1.3GPP 36.302-11.5.0 V1.0.0	11.5.0	30.05.2019	https://members.tdsi.in/index.php/s/BxBT9C9F8KxobBg
TTA	TTAT.3G-36.302(R11-11.5.0)	11.5.0	10.08.2016	http://www.tta.or.kr/data/ttasDown.jsp?where=14688&pk_num=TTAT.3G-36.302(R11-11.5.0)
Release 12				
ARIB	ARIB STD-T104-36.302	12.8.0	12.04.2018	http://www.arib.or.jp/english/html/overview/doc/STD-T104v5_20/2_T104/ARIB-STD-T104/Rel12/36/A36302-c80.pdf
ATIS	ATIS.3GPP.36.302V1280	12.8.0	02.05.2019	https://www.atis.org/docstore/
CCSA	CCSA TSD LTE 36.302	12.8.0	05.10.2016	http://www.ccsa.org.cn/ITU_spec/ITU-R/M.2012/M.2012-4/LTE/REL-12/CCSA-TSD-LTE-36302-c80.rar
ETSI	ETSI TS 136 302	12.8.0	05.10.2016	http://www.etsi.org/deliver/etsi_ts/136300_136399/136302/12.08.00_60/ts_136302v120800p.pdf
TSDSI	TSDSI STD T1.3GPP 36.302-12.8.0 V1.0.0	12.8.0	30.05.2019	https://members.tdsi.in/index.php/s/BxBT9C9F8KxobBg
TTA	TTAT.3G-36.302(R12-12.8.0)	12.8.0	06.07.2017	http://www.tta.or.kr/data/ttasDown.jsp?where=14688&pk_num=TTAT.3G-36.302(R12-12.8.0)
Release 13				
ARIB	ARIB STD-T104-36.302	13.7.0	12.04.2018	http://www.arib.or.jp/english/html/overview/doc/STD-T104v5_20/2_T104/ARIB-STD-T104/Rel13/36/A36302-d70.pdf
ATIS	ATIS.3GPP.36.302V1370	13.7.0	02.05.2019	https://www.atis.org/docstore/
CCSA	CCSA TSD LTE 36.302	13.6.0	17.01.2018	http://www.ccsa.org.cn/ITU_spec/ITU-R/M.2012/M.2012-4/LTE/REL-13/CCSA-TSD-LTE-36302-d60.rar
ETSI	ETSI TS 136 302	13.7.0	17.01.2018	http://www.etsi.org/deliver/etsi_ts/136300_136399/136302/13.07.00_60/ts_136302v130700p.pdf
TSDSI	TSDSI STD T1.3GPP 36.302-13.7.0 V1.0.0	13.7.0	30.05.2019	https://members.tdsi.in/index.php/s/BxBT9C9F8KxobBg
TTA	TTAT.3G-36.302(R13-13.7.0)	13.7.0	09.05.2019	http://www.tta.or.kr/data/ttasDown.jsp?where=14688&pk_num=TTAT.3G-36.302(R13-13.7.0)

Release 14

ARIB	ARIB STD-T104-36.302	14.4.0	12.04.2018	http://www.arib.or.jp/english/html/overview/doc/STD-T104v5_20/2_T104/ARIB-STD-T104/Rel14/36/A36302-e40.pdf
ATIS	ATIS.3GPP.36.302V1440	14.4.0	02.05.2019	https://www.atis.org/docstore/
CCSA	CCSA TSD LTE 36.302	14.4.0	11.01.2019	http://www.ccsa.org.cn/ITU_spec/ITU-R/M.2012/M.2012-4/LTE/REL-14/CCSA-TSD-LTE-36302-e40.zip
ETSI	ETSI TS 136 302	14.4.0	17.01.2018	http://www.etsi.org/deliver/etsi_ts/136300_136399/136302/14.04.00_60/ts_136302v140400p.pdf
TSDSI	TSDSI STD T1.3GPP 36.302-14.4.0 V1.0.0	14.4.0	30.05.2019	https://members.tdsi.in/index.php/s/BxBT9C9F8KxobBg
TTA	TTAT.3G-36.302(R14-14.4.0)	14.4.0	09.05.2019	http://www.tta.or.kr/data/ttasDown.jsp?where=14688&pk_num=TTAT.3G-36.302(R14-14.4.0)

2.1.3.3 TS 36.304**Evolved Universal Terrestrial Radio Access (E-UTRA); User Equipment (UE) procedures in idle mode**

This document specifies the Access Stratum (AS) part of the Idle Mode procedures applicable to a UE. This document specifies the model for the functional division between the NAS and AS in a UE. This document applies to all UEs that support at least E-UTRA, including multi-RAT UEs as described in 3GPP specifications, in the following cases: (i) When the UE is camped on an E-UTRA cell; (ii) When the UE is searching for a cell to camp on.

SDO	Document No.	Version	Issued date	Location
Release 10				
ARIB	ARIB STD-T104-36.304		10.9.0	12.04.2018 http://www.arib.or.jp/english/html/overview/doc/STD-T104v5_20/2_T104/ARIB-STD-T104/Rel10/36/A36304-a90.pdf
ATIS	ATIS.3GPP.36.304V1090		10.9.0	02.05.2019 https://www.atis.org/docstore/
CCSA	CCSA TSD LTE 36.304		10.9.0	18.01.2016 http://www.ccsa.org.cn/ITU_spec/ITU-R/M.2012/M.2012-4/LTE/REL-10/CCSA-TSD-LTE-36304-a90.rar
ETSI	ETSI TS 136 304		10.9.0	18.01.2016 http://www.etsi.org/deliver/etsi_ts/136300_136399/136304/10.09.00_60/ts_136304v100900p.pdf
TSDSI	TSDSI STD T1.3GPP 36.304-10.9.0 V1.0.0		10.9.0	30.05.2019 https://members.tdsi.in/index.php/s/BxBT9C9F8KxobBg
TTA	TTAT.3G-36.304(R10-10.9.0)		10.9.0	06.07.2017 http://www.tta.or.kr/data/ttasDown.jsp?where=14688&pk_num=TTAT.3G-36.304(R10-10.9.0)
Release 11				
ARIB	ARIB STD-T104-36.304		11.7.0	12.04.2018 http://www.arib.or.jp/english/html/overview/doc/STD-T104v5_20/2_T104/ARIB-STD-T104/Rel11/36/A36304-b70.pdf
ATIS	ATIS.3GPP.36.304V1170		11.7.0	02.05.2019 https://www.atis.org/docstore/
CCSA	CCSA TSD LTE 36.304		11.7.0	18.01.2016 http://www.ccsa.org.cn/ITU_spec/ITU-R/M.2012/M.2012-4/LTE/REL-11/CCSA-TSD-LTE-36304-b70.rar
ETSI	ETSI TS 136 304		11.7.0	18.01.2016 http://www.etsi.org/deliver/etsi_ts/136300_136399/136304/11.07.00_60/ts_136304v110700p.pdf
TSDSI	TSDSI STD T1.3GPP 36.304-11.7.0 V1.0.0		11.7.0	30.05.2019 https://members.tdsi.in/index.php/s/BxBT9C9F8KxobBg
TTA	TTAT.3G-36.304(R11-11.7.0)		11.7.0	06.07.2017 http://www.tta.or.kr/data/ttasDown.jsp?where=14688&pk_num=TTAT.3G-36.304(R11-11.7.0)
Release 12				
ARIB	ARIB STD-T104-36.304		12.8.0	12.04.2018 http://www.arib.or.jp/english/html/overview/doc/STD-T104v5_20/2_T104/ARIB-STD-T104/Rel12/36/A36304-c80.pdf
ATIS	ATIS.3GPP.36.304V1280		12.8.0	02.05.2019 https://www.atis.org/docstore/
CCSA	CCSA TSD LTE 36.304		12.8.0	25.08.2016 http://www.ccsa.org.cn/ITU_spec/ITU-R/M.2012/M.2012-4/LTE/REL-12/CCSA-TSD-LTE-36304-c80.rar
ETSI	ETSI TS 136 304		12.8.0	25.08.2016 http://www.etsi.org/deliver/etsi_ts/136300_136399/136304/12.08.00_60/ts_136304v120800p.pdf
TSDSI	TSDSI STD T1.3GPP 36.304-12.8.0 V1.0.0		12.8.0	30.05.2019 https://members.tdsi.in/index.php/s/BxBT9C9F8KxobBg
TTA	TTAT.3G-36.304(R12-12.8.0)		12.8.0	06.07.2017 http://www.tta.or.kr/data/ttasDown.jsp?where=14688&pk_num=TTAT.3G-36.304(R12-12.8.0)
Release 13				
ARIB	ARIB STD-T104-36.304		13.8.0	12.04.2018 http://www.arib.or.jp/english/html/overview/doc/STD-T104v5_20/2_T104/ARIB-STD-T104/Rel13/36/A36304-d80.pdf
ATIS	ATIS.3GPP.36.304V1380		13.8.0	02.05.2019 https://www.atis.org/docstore/
CCSA	CCSA TSD LTE 36.304		13.6.0	17.01.2018 http://www.ccsa.org.cn/ITU_spec/ITU-R/M.2012/M.2012-4/LTE/REL-13/CCSA-TSD-LTE-36304-d60.rar
ETSI	ETSI TS 136 304		13.8.0	17.01.2018 http://www.etsi.org/deliver/etsi_ts/136300_136399/136304/13.08.00_60/ts_136304v130800p.pdf

TSDSI	TSDSI STD T1.3GPP 36.304-13.8.0 V1.0.0	13.8.0	30.05.2019	https://members.tdsi.in/index.php/s/BxBT9C9F8KxobBg
TTA	TTAT.3G-36.304(R13-13.8.0)	13.8.0	09.05.2019	http://www.tta.or.kr/data/ttasDown.jsp?where=14688&pk_num=TTAT.3G-36.304(R13-13.8.0)

Release 14

ARIB	ARIB STD-T104-36.304	14.5.0	12.04.2018	http://www.arib.or.jp/english/html/overview/doc/STD-T104v5_202_T104/ARIB-STD-T104/Rel14/36/A36304-e50.pdf
ATIS	ATIS.3GPP.36.304V1450	14.5.0	02.05.2019	https://www.atis.org/docstore/
CCSA	CCSA TSD LTE 36.304	14.5.0	11.01.2019	http://www.ccsa.org.cn/ITU_spec/ITU-R/M.2012/M.2012-4/LTE/REL-14/CCSA-TSD-LTE-36304-e50.zip
ETSI	ETSI TS 136 304	14.5.0	17.01.2018	http://www.etsi.org/deliver/etsi_ts/136300_136399/136304/14.05.00_60/ts_136304v140500p.pdf
TSDSI	TSDSI STD T1.3GPP 36.304-14.5.0 V1.0.0	14.5.0	30.05.2019	https://members.tdsi.in/index.php/s/BxBT9C9F8KxobBg
TTA	TTAT.3G-36.304(R14-14.5.0)	14.5.0	09.05.2019	http://www.tta.or.kr/data/ttasDown.jsp?where=14688&pk_num=TTAT.3G-36.304(R14-14.5.0)

2.1.3.4 TS 36.305**Evolved Universal Terrestrial Radio Access Network (E-UTRAN); Stage 2 functional specification of User Equipment (UE) positioning in E-UTRAN**

This document specifies the stage 2 of the UE positioning function of E-UTRAN, which provides the mechanisms to support or assist the calculation of the geographical position of a UE. The purpose of this stage 2 specification is to define the E-UTRAN UE Positioning architecture, functional entities and operations to support positioning methods. This description is confined to the E-UTRAN Access Stratum. This stage 2 specification covers the E-UTRAN positioning methods, state descriptions, and message flows to support UE positioning.

SDO	Document No.	Version	Issued date	Location	
Release 10					
ARIB	ARIB STD-T104-36.305		10.5.0	12.04.2018	http://www.arib.or.jp/english/html/overview/doc/STD-T104v5_202_T104/ARIB-STD-T104/Rel10/36/A36305-a50.pdf
ATIS	ATIS.3GPP.36.305V1050		10.5.0	02.05.2019	https://www.atis.org/docstore/
CCSA	CCSA TSD LTE 36.305		10.5.0	07.02.2013	http://www.ccsa.org.cn/ITU_spec/ITU-R/M.2012/M.2012-4/LTE/REL-10/CCSA-TSD-LTE-36305-a50.rar
ETSI	ETSI TS 136 305		10.5.0	07.02.2013	http://www.etsi.org/deliver/etsi_ts/136300_136399/136305/10.05.00_60/ts_136305v100500p.pdf
TSDSI	TSDSI STD T1.3GPP 36.305-10.5.0 V1.0.0		10.5.0	30.05.2019	https://members.tdsi.in/index.php/s/BxBT9C9F8KxobBg
TTA	TTAT.3G-36.305(R10-10.5.0)		10.5.0	10.08.2016	http://www.tta.or.kr/data/ttasDown.jsp?where=14688&pk_num=TTAT.3G-36.305(R10-10.5.0)
Release 11					
ARIB	ARIB STD-T104-36.305		11.3.0	12.04.2018	http://www.arib.or.jp/english/html/overview/doc/STD-T104v5_202_T104/ARIB-STD-T104/Rel11/36/A36305-b30.pdf
ATIS	ATIS.3GPP.36.305V1130		11.3.0	02.05.2019	https://www.atis.org/docstore/
CCSA	CCSA TSD LTE 36.305		11.3.0	19.04.2013	http://www.ccsa.org.cn/ITU_spec/ITU-R/M.2012/M.2012-4/LTE/REL-11/CCSA-TSD-LTE-36305-b30.rar
ETSI	ETSI TS 136 305		11.3.0	19.04.2013	http://www.etsi.org/deliver/etsi_ts/136300_136399/136305/11.03.00_60/ts_136305v110300p.pdf
TSDSI	TSDSI STD T1.3GPP 36.305-11.3.0 V1.0.0		11.3.0	30.05.2019	https://members.tdsi.in/index.php/s/BxBT9C9F8KxobBg
TTA	TTAT.3G-36.305(R11-11.3.0)		11.3.0	26.08.2013	http://www.tta.or.kr/data/ttasDown.jsp?where=14688&pk_num=TTAT.3G-36.305(R11-11.3.0)
Release 12					
ARIB	ARIB STD-T104-36.305		12.2.0	12.04.2018	http://www.arib.or.jp/english/html/overview/doc/STD-T104v5_202_T104/ARIB-STD-T104/Rel12/36/A36305-c20.pdf
ATIS	ATIS.3GPP.36.305V1220		12.2.0	02.05.2019	https://www.atis.org/docstore/
CCSA	CCSA TSD LTE 36.305		12.2.0	04.02.2015	http://www.ccsa.org.cn/ITU_spec/ITU-R/M.2012/M.2012-4/LTE/REL-12/CCSA-TSD-LTE-36305-c20.rar
ETSI	ETSI TS 136 305		12.2.0	04.02.2015	http://www.etsi.org/deliver/etsi_ts/136300_136399/136305/12.02.00_60/ts_136305v120200p.pdf
TSDSI	TSDSI STD T1.3GPP 36.305-12.2.0 V1.0.0		12.2.0	30.05.2019	https://members.tdsi.in/index.php/s/BxBT9C9F8KxobBg
TTA	TTAT.3G-36.305(R12-12.2.0)		12.2.0	09.04.2015	http://www.tta.or.kr/data/ttasDown.jsp?where=14688&pk_num=TTAT.3G-36.305(R12-12.2.0)

Release 13

34

ARIB	ARIB STD-T104-36.305	13.0.0	12.04.2018	http://www.arib.or.jp/english/html/overview/doc/STD-T104v5_20/2_T104/ARIB-STD-T104/Rel13/36/A36305-d00.pdf
ATIS	ATIS.3GPP.36.305V1300	13.0.0	02.05.2019	https://www.atis.org/docstore/
CCSA	CCSA TSD LTE 36.305	13.0.0	27.01.2016	http://www.ccsa.org.cn/ITU_spec/ITU-R/M.2012/M.2012-4/LTE/REL-13/CCSA-TSD-LTE-36305-d00.rar
ETSI	ETSI TS 136 305	13.0.0	27.01.2016	http://www.etsi.org/deliver/etsi_ts/136300_136399/136305/13.00.00_60/ts_136305v130000p.pdf
TSDSI	TSDSI STD T1.3GPP 36.305-13.0.0 V1.0.0	13.0.0	30.05.2019	https://members.tdsi.in/index.php/s/BxBT9C9F8KxobBg
TTA	TTAT.3G-36.305(R13-13.0.0)	13.0.0	06.07.2017	http://www.tta.or.kr/data/ttasDown.jsp?where=14688&pk_num=TTAT.3G-36.305(R13-13.0.0)

Release 14

ARIB	ARIB STD-T104-36.305	14.3.0	12.04.2018	http://www.arib.or.jp/english/html/overview/doc/STD-T104v5_20/2_T104/ARIB-STD-T104/Rel14/36/A36305-e30.pdf
ATIS	ATIS.3GPP.36.305V1430	14.3.0	02.05.2019	https://www.atis.org/docstore/
CCSA	CCSA TSD LTE 36.305	14.3.0	11.01.2019	http://www.ccsa.org.cn/ITU_spec/ITU-R/M.2012/M.2012-4/LTE/REL-14/CCSA-TSD-LTE-36305-e30.zip
ETSI	ETSI TS 136 305	14.3.0	09.10.2017	http://www.etsi.org/deliver/etsi_ts/136300_136399/136305/14.03.00_60/ts_136305v140300p.pdf
TSDSI	TSDSI STD T1.3GPP 36.305-14.3.0 V1.0.0	14.3.0	30.05.2019	https://members.tdsi.in/index.php/s/BxBT9C9F8KxobBg
TTA	TTAT.3G-36.305(R14-14.3.0)	14.3.0	10.05.2018	http://www.tta.or.kr/data/ttasDown.jsp?where=14688&pk_num=TTAT.3G-36.305(R14-14.3.0)

2.1.3.5 TS 36.306

Evolved Universal Terrestrial Radio Access (E-UTRA); User Equipment (UE) radio access capabilities

This document defines the E-UTRA UE Radio Access Capability Parameters.

SDO	Document No.	Version	Issued date	Location
Release 10				
ARIB	ARIB STD-T104-36.306	10.15.0	12.04.2018	http://www.arib.or.jp/english/html/overview/doc/STD-T104v5_20/2_T104/ARIB-STD-T104/Rel10/36/A36306-af0.pdf
ATIS	ATIS.3GPP.36.306V10150	10.15.0	02.05.2019	https://www.atis.org/docstore/
CCSA	CCSA TSD LTE 36.306	10.15.0	28.01.2016	http://www.ccsa.org.cn/ITU_spec/ITU-R/M.2012/M.2012-4/LTE/REL-10/CCSA-TSD-LTE-36306-af0.rar
ETSI	ETSI TS 136 306	10.15.0	28.01.2016	http://www.etsi.org/deliver/etsi_ts/136300_136399/136306/10.15.00_60/ts_136306v101500p.pdf
TSDSI	TSDSI STD T1.3GPP 36.306-10.15.0 V1.0.0	10.15.0	30.05.2019	https://members.tdsi.in/index.php/s/BxBT9C9F8KxobBg
TTA	TTAT.3G-36.306(R10-10.15.0)	10.15.0	06.07.2017	http://www.tta.or.kr/data/ttasDown.jsp?where=14688&pk_num=TTAT.3G-36.306(R10-10.15.0)
Release 11				
ARIB	ARIB STD-T104-36.306	11.14.0	12.04.2018	http://www.arib.or.jp/english/html/overview/doc/STD-T104v5_20/2_T104/ARIB-STD-T104/Rel11/36/A36306-be0.pdf
ATIS	ATIS.3GPP.36.306V11140	11.14.0	02.05.2019	https://www.atis.org/docstore/
CCSA	CCSA TSD LTE 36.306	11.14.0	16.02.2017	http://www.ccsa.org.cn/ITU_spec/ITU-R/M.2012/M.2012-4/LTE/REL-11/CCSA-TSD-LTE-36306-be0.rar
ETSI	ETSI TS 136 306	11.14.0	16.02.2017	http://www.etsi.org/deliver/etsi_ts/136300_136399/136306/11.14.00_60/ts_136306v111400p.pdf
TSDSI	TSDSI STD T1.3GPP 36.306-11.14.0 V1.0.0	11.14.0	30.05.2019	https://members.tdsi.in/index.php/s/BxBT9C9F8KxobBg
TTA	TTAT.3G-36.306(R11-11.14.0)	11.14.0	10.05.2018	http://www.tta.or.kr/data/ttasDown.jsp?where=14688&pk_num=TTAT.3G-36.306(R11-11.14.0)
Release 12				
ARIB	ARIB STD-T104-36.306	12.13.0	12.04.2018	http://www.arib.or.jp/english/html/overview/doc/STD-T104v5_20/2_T104/ARIB-STD-T104/Rel12/36/A36306-cd0.pdf
ATIS	ATIS.3GPP.36.306V12130	12.13.0	02.05.2019	https://www.atis.org/docstore/
CCSA	CCSA TSD LTE 36.306	12.12.0	09.10.2017	http://www.ccsa.org.cn/ITU_spec/ITU-R/M.2012/M.2012-4/LTE/REL-12/CCSA-TSD-LTE-36306-cc0.rar
ETSI	ETSI TS 136 306	12.13.0	09.10.2017	http://www.etsi.org/deliver/etsi_ts/136300_136399/136306/12.13.00_60/ts_136306v121300p.pdf
TSDSI	TSDSI STD T1.3GPP 36.306-12.13.0 V1.0.0	12.13.0	30.05.2019	https://members.tdsi.in/index.php/s/BxBT9C9F8KxobBg
TTA	TTAT.3G-36.306(R12-12.13.0)	12.13.0	10.05.2018	http://www.tta.or.kr/data/ttasDown.jsp?where=14688&pk_num=TTAT.3G-36.306(R12-12.13.0)
Release 13				
ARIB	ARIB STD-T104-36.306	13.8.0	12.04.2018	http://www.arib.or.jp/english/html/overview/doc/STD-T104v5_20/2_T104/ARIB-STD-T104/Rel13/36/A36306-d80.pdf
ATIS	ATIS.3GPP.36.306V1380	13.8.0	02.05.2019	https://www.atis.org/docstore/

CCSA	CCSA TSD LTE 36.306	13.6.0	17.01.2018	http://www.ccsa.org.cn/ITU_spec/ITU-R/M.2012/M.2012-4/LTE/REL-13/CCSA-TSD-LTE-36306-d60.rar
ETSI	ETSI TS 136 306	13.8.0	17.01.2018	http://www.etsi.org/deliver/etsi_ts/136300_136399/136306/13.08.00_60/ts_136306v130800p.pdf
TSDSI	TSDSI STD T1.3GPP 36.306-13.8.0 V1.0.0	13.8.0	30.05.2019	https://members.tdsi.in/index.php/s/BxBT9C9F8KxobBg
TTA	TTAT.3G-36.306(R13-13.8.0)	13.8.0	09.05.2019	http://www.tta.or.kr/data/ttasDown.jsp?where=14688&pk_num=TTAT.3G-36.306(R13-13.8.0)

Release 14

ARIB	ARIB STD-T104-36.306	14.5.0	12.04.2018	http://www.arib.or.jp/english/html/overview/doc/STD-T104v5_20/2_T104/ARIB-STD-T104/Rel14/36/A36306-e50.pdf
ATIS	ATIS.3GPP.36.306V1450	14.5.0	02.05.2019	https://www.atis.org/docstore/
CCSA	CCSA TSD LTE 36.306	14.5.0	11.01.2019	http://www.ccsa.org.cn/ITU_spec/ITU-R/M.2012/M.2012-4/LTE/REL-14/CCSA-TSD-LTE-36306-e50.zip
ETSI	ETSI TS 136 306	14.5.0	17.01.2018	http://www.etsi.org/deliver/etsi_ts/136300_136399/136306/14.05.00_60/ts_136306v140500p.pdf
TSDSI	TSDSI STD T1.3GPP 36.306-14.5.0 V1.0.0	14.5.0	30.05.2019	https://members.tdsi.in/index.php/s/BxBT9C9F8KxobBg
TTA	TTAT.3G-36.306(R14-14.5.0)	14.5.0	09.05.2019	http://www.tta.or.kr/data/ttasDown.jsp?where=14688&pk_num=TTAT.3G-36.306(R14-14.5.0)

2.1.3.6 TS 36.314**Evolved Universal Terrestrial Radio Access (E-UTRA); Layer 2 – Measurements**

This document contains the description and definition of the measurements performed by E-UTRAN that are transferred over the standardized interfaces in order to support E-UTRA radio link operations, radio resource management (RRM), network operations and maintenance (OAM), and self-organizing networks (SON).

SDO	Document No.	Version	Issued date	Location
Release 10				
ARIB	ARIB STD-T104-36.314	10.2.0	12.04.2018	http://www.arib.or.jp/english/html/overview/doc/STD-T104v5_20/2_T104/ARIB-STD-T104/Rel10/36/A36314-a20.pdf
ATIS	ATIS.3GPP.36.314V1020	10.2.0	02.05.2019	https://www.atis.org/docstore/
CCSA	CCSA TSD LTE 36.314	10.2.0	04.11.2011	http://www.ccsa.org.cn/ITU_spec/ITU-R/M.2012/M.2012-4/LTE/REL-10/CCSA-TSD-LTE-36314-a20.rar
ETSI	ETSI TS 136 314	10.2.0	04.11.2011	http://www.etsi.org/deliver/etsi_ts/136300_136399/136314/10.02.00_60/ts_136314v100200p.pdf
TSDSI	TSDSI STD T1.3GPP 36.314-10.2.0 V1.0.0	10.2.0	30.05.2019	https://members.tdsi.in/index.php/s/BxBT9C9F8KxobBg
TTA	TTAT.3G-36.314(R10-10.2.0)	10.2.0	22.08.2012	http://www.tta.or.kr/data/ttasDown.jsp?where=14688&pk_num=TTAT.3G-36.314(R10-10.2.0)
Release 11				
ARIB	ARIB STD-T104-36.314	11.1.0	12.04.2018	http://www.arib.or.jp/english/html/overview/doc/STD-T104v5_20/2_T104/ARIB-STD-T104/Rel11/36/A36314-b10.pdf
ATIS	ATIS.3GPP.36.314V1110	11.1.0	02.05.2019	https://www.atis.org/docstore/
CCSA	CCSA TSD LTE 36.314	11.1.0	12.02.2013	http://www.ccsa.org.cn/ITU_spec/ITU-R/M.2012/M.2012-4/LTE/REL-11/CCSA-TSD-LTE-36314-b10.rar
ETSI	ETSI TS 136 314	11.1.0	12.02.2013	http://www.etsi.org/deliver/etsi_ts/136300_136399/136314/11.01.00_60/ts_136314v110100p.pdf
TSDSI	TSDSI STD T1.3GPP 36.314-11.1.0 V1.0.0	11.1.0	30.05.2019	https://members.tdsi.in/index.php/s/BxBT9C9F8KxobBg
TTA	TTAT.3G-36.314(R11-11.1.0)	11.1.0	26.08.2013	http://www.tta.or.kr/data/ttasDown.jsp?where=14688&pk_num=TTAT.3G-36.314(R11-11.1.0)
Release 12				
ARIB	ARIB STD-T104-36.314	12.0.0	12.04.2018	http://www.arib.or.jp/english/html/overview/doc/STD-T104v5_20/2_T104/ARIB-STD-T104/Rel12/36/A36314-c00.pdf
ATIS	ATIS.3GPP.36.314V1200	12.0.0	02.05.2019	https://www.atis.org/docstore/
CCSA	CCSA TSD LTE 36.314	12.0.0	29.09.2014	http://www.ccsa.org.cn/ITU_spec/ITU-R/M.2012/M.2012-4/LTE/REL-12/CCSA-TSD-LTE-36314-c00.rar
ETSI	ETSI TS 136 314	12.0.0	29.09.2014	http://www.etsi.org/deliver/etsi_ts/136300_136399/136314/12.00.00_60/ts_136314v120000p.pdf
TSDSI	TSDSI STD T1.3GPP 36.314-12.0.0 V1.0.0	12.0.0	30.05.2019	https://members.tdsi.in/index.php/s/BxBT9C9F8KxobBg
TTA	TTAT.3G-36.314(R12-12.0.0)	12.0.0	09.04.2015	http://www.tta.or.kr/data/ttasDown.jsp?where=14688&pk_num=TTAT.3G-36.314(R12-12.0.0)
Release 13				
ARIB	ARIB STD-T104-36.314	13.1.0	12.04.2018	http://www.arib.or.jp/english/html/overview/doc/STD-T104v5_20/2_T104/ARIB-STD-T104/Rel13/36/A36314-d10.pdf

36

ATIS	ATIS.3GPP.36.314V1310	13.1.0	02.05.2019	https://www.atis.org/docstore/
CCSA	CCSA TSD LTE 36.314	13.1.0	27.04.2016	http://www.ccsa.org.cn/ITU_spec/ITU-R/M.2012/M.2012-4/LTE/REL-13/CCSA-TSD-LTE-36314-d10.rar
ETSI	ETSI TS 136 314	13.1.0	27.04.2016	http://www.etsi.org/deliver/etsi_ts/136300_136399/136314/13.01.00_60/ts_136314v130100p.pdf
TSDSI	TSDSI STD T1.3GPP 36.314-13.1.0 V1.0.0	13.1.0	30.05.2019	https://members.tdsi.in/index.php/s/BxBT9C9F8KxobBg
TTA	TTAT.3G-36.314(R13-13.1.0)	13.1.0	06.07.2017	http://www.tta.or.kr/data/ttasDown.jsp?where=14688&pk_num=TTAT.3G-36.314(R13-13.1.0)

Release 14

ARIB	ARIB STD-T104-36.314	14.0.0	12.04.2018	http://www.arib.or.jp/english/html/overview/doc/STD-T104v5_20/2_T104/ARIB-STD-T104/Rel14/36/A36314-e00.pdf
ATIS	ATIS.3GPP.36.314V1400	14.0.0	02.05.2019	https://www.atis.org/docstore/
CCSA	CCSA TSD LTE 36.314	14.0.0	11.01.2019	http://www.ccsa.org.cn/ITU_spec/ITU-R/M.2012/M.2012-4/LTE/REL-14/CCSA-TSD-LTE-36314-e00.zip
ETSI	ETSI TS 136 314	14.0.0	11.04.2017	http://www.etsi.org/deliver/etsi_ts/136300_136399/136314/14.00.00_60/ts_136314v140000p.pdf
TSDSI	TSDSI STD T1.3GPP 36.314-14.0.0 V1.0.0	14.0.0	30.05.2019	https://members.tdsi.in/index.php/s/BxBT9C9F8KxobBg
TTA	TTAT.3G-36.314(R14-14.0.0)	14.0.0	10.05.2018	http://www.tta.or.kr/data/ttasDown.jsp?where=14688&pk_num=TTAT.3G-36.314(R14-14.0.0)

2.1.3.7 TS 36.321

Evolved Universal Terrestrial Radio Access (E-UTRA); Medium Access Control (MAC) protocol specification

This document specifies the E-UTRA Medium Access Control (MAC) protocol.

SDO	Document No.	Version	Issued date	Location
Release 10				
ARIB	ARIB STD-T104-36.321	10.10.0	12.04.2018	http://www.arib.or.jp/english/html/overview/doc/STD-T104v5_20/2_T104/ARIB-STD-T104/Rel10/36/A36321-aa0.pdf
ATIS	ATIS.3GPP.36.321V10100	10.10.0	02.05.2019	https://www.atis.org/docstore/
CCSA	CCSA TSD LTE 36.321	10.10.0	28.01.2014	http://www.ccsa.org.cn/ITU_spec/ITU-R/M.2012/M.2012-4/LTE/REL-10/CCSA-TSD-LTE-36321-aa0.rar
ETSI	ETSI TS 136 321	10.10.0	28.01.2014	http://www.etsi.org/deliver/etsi_ts/136300_136399/136321/10.10.00_60/ts_136321v101000p.pdf
TSDSI	TSDSI STD T1.3GPP 36.321-10.10.0 V1.0.0	10.10.0	30.05.2019	https://members.tdsi.in/index.php/s/BxBT9C9F8KxobBg
TTA	TTAT.3G-36.321(R10-10.10.0)	10.10.0	10.08.2016	http://www.tta.or.kr/data/ttasDown.jsp?where=14688&pk_num=TTAT.3G-36.321(R10-10.10.0)
Release 11				
ARIB	ARIB STD-T104-36.321	11.6.0	12.04.2018	http://www.arib.or.jp/english/html/overview/doc/STD-T104v5_20/2_T104/ARIB-STD-T104/Rel11/36/A36321-b60.pdf
ATIS	ATIS.3GPP.36.321V1160	11.6.0	02.05.2019	https://www.atis.org/docstore/
CCSA	CCSA TSD LTE 36.321	11.6.0	21.04.2015	http://www.ccsa.org.cn/ITU_spec/ITU-R/M.2012/M.2012-4/LTE/REL-11/CCSA-TSD-LTE-36321-b60.rar
ETSI	ETSI TS 136 321	11.6.0	21.04.2015	http://www.etsi.org/deliver/etsi_ts/136300_136399/136321/11.06.00_60/ts_136321v110600p.pdf
TSDSI	TSDSI STD T1.3GPP 36.321-11.6.0 V1.0.0	11.6.0	30.05.2019	https://members.tdsi.in/index.php/s/BxBT9C9F8KxobBg
TTA	TTAT.3G-36.321(R11-11.6.0)	11.6.0	06.07.2017	http://www.tta.or.kr/data/ttasDown.jsp?where=14688&pk_num=TTAT.3G-36.321(R11-11.6.0)
Release 12				
ARIB	ARIB STD-T104-36.321	12.10.0	12.04.2018	http://www.arib.or.jp/english/html/overview/doc/STD-T104v5_20/2_T104/ARIB-STD-T104/Rel12/36/A36321-ca0.pdf
ATIS	ATIS.3GPP.36.321V12100	12.10.0	02.05.2019	https://www.atis.org/docstore/
CCSA	CCSA TSD LTE 36.321	12.9.0	09.10.2017	http://www.ccsa.org.cn/ITU_spec/ITU-R/M.2012/M.2012-4/LTE/REL-12/CCSA-TSD-LTE-36321-c90.rar
ETSI	ETSI TS 136 321	12.10.0	09.10.2017	http://www.etsi.org/deliver/etsi_ts/136300_136399/136321/12.10.00_60/ts_136321v121000p.pdf
TSDSI	TSDSI STD T1.3GPP 36.321-12.10.0 V1.0.0	12.10.0	30.05.2019	https://members.tdsi.in/index.php/s/BxBT9C9F8KxobBg
TTA	TTAT.3G-36.321(R12-12.10.0)	12.10.0	10.05.2018	http://www.tta.or.kr/data/ttasDown.jsp?where=14688&pk_num=TTAT.3G-36.321(R12-12.10.0)
Release 13				
ARIB	ARIB STD-T104-36.321	13.7.0	12.04.2018	http://www.arib.or.jp/english/html/overview/doc/STD-T104v5_20/2_T104/ARIB-STD-T104/Rel13/36/A36321-d70.pdf
ATIS	ATIS.3GPP.36.321V1370	13.7.0	02.05.2019	https://www.atis.org/docstore/
CCSA	CCSA TSD LTE 36.321	13.6.0	09.10.2017	http://www.ccsa.org.cn/ITU_spec/ITU-R/M.2012/M.2012-4/LTE/REL-13/CCSA-TSD-LTE-36321-d60.rar

ETSI	ETSI TS 136 321	13.7.0	09.10.2017	http://www.etsi.org/deliver/etsi_ts/136300_136399/136321/13.07.00_60/ts_136321v130700p.pdf
TSDSI	TSDSI STD T1.3GPP 36.321-13.7.0 V1.0.0	13.7.0	30.05.2019	https://members.tdsi.in/index.php/s/BxBT9C9F8KxobBg
TTA	TTAT.3G-36.321(R13-13.7.0)	13.7.0	10.05.2018	http://www.tta.or.kr/data/ttasDown.jsp?where=14688&pk_num=TTAT.3G-36.321(R13-13.7.0)

Release 14

ARIB	ARIB STD-T104-36.321	14.5.0	12.04.2018	http://www.arib.or.jp/english/html/overview/doc/STD-T104v5_20/2_T104/ARIB-STD-T104/Rel14/36/A36321-e50.pdf
ATIS	ATIS.3GPP.36.321V1450	14.5.0	02.05.2019	https://www.atis.org/docstore/
CCSA	CCSA TSD LTE 36.321	14.5.0	11.01.2019	http://www.ccsa.org.cn/ITU_spec/ITU-R/M.2012/M.2012-4/LTE/REL-14/CCSA-TSD-LTE-36321-e50.zip
ETSI	ETSI TS 136 321	14.5.0	19.01.2018	http://www.etsi.org/deliver/etsi_ts/136300_136399/136321/14.05.00_60/ts_136321v140500p.pdf
TSDSI	TSDSI STD T1.3GPP 36.321-14.5.0 V1.0.0	14.5.0	30.05.2019	https://members.tdsi.in/index.php/s/BxBT9C9F8KxobBg
TTA	TTAT.3G-36.321(R14-14.5.0)	14.5.0	09.05.2019	http://www.tta.or.kr/data/ttasDown.jsp?where=14688&pk_num=TTAT.3G-36.321(R14-14.5.0)

2.1.3.8 TS 36.322**Evolved Universal Terrestrial Radio Access (E-UTRA); Radio Link Control (RLC) protocol specification**

This document specifies the E-UTRA Radio Link Control (RLC) protocol.

SDO	Document No.	Version	Issued date	Location
Release 10				
ARIB	ARIB STD-T104-36.322	10.0.0	12.04.2018	http://www.arib.or.jp/english/html/overview/doc/STD-T104v5_20/2_T104/ARIB-STD-T104/Rel10/36/A36322-a00.pdf
ATIS	ATIS.3GPP.36.322V1000	10.0.0	02.05.2019	https://www.atis.org/docstore/
CCSA	CCSA TSD LTE 36.322	10.0.0	14.01.2011	http://www.ccsa.org.cn/ITU_spec/ITU-R/M.2012/M.2012-4/LTE/REL-10/CCSA-TSD-LTE-36322-a00.rar
ETSI	ETSI TS 136 322	10.0.0	14.01.2011	http://www.etsi.org/deliver/etsi_ts/136300_136399/136322/10.00.00_60/ts_136322v100000p.pdf
TSDSI	TSDSI STD T1.3GPP 36.322-10.0.0 V1.0.0	10.0.0	30.05.2019	https://members.tdsi.in/index.php/s/BxBT9C9F8KxobBg
TTA	TTAT.3G-36.322(R10-10.0.0)	10.0.0	26.08.2011	http://www.tta.or.kr/data/ttasDown.jsp?where=14688&pk_num=TTAT.3G-36.322(R10-10.0.0)
Release 11				
ARIB	ARIB STD-T104-36.322	11.0.0	12.04.2018	http://www.arib.or.jp/english/html/overview/doc/STD-T104v5_20/2_T104/ARIB-STD-T104/Rel11/36/A36322-b00.pdf
ATIS	ATIS.3GPP.36.322V1100	11.0.0	02.05.2019	https://www.atis.org/docstore/
CCSA	CCSA TSD LTE 36.322	11.0.0	02.10.2012	http://www.ccsa.org.cn/ITU_spec/ITU-R/M.2012/M.2012-4/LTE/REL-11/CCSA-TSD-LTE-36322-b00.rar
ETSI	ETSI TS 136 322	11.0.0	02.10.2012	http://www.etsi.org/deliver/etsi_ts/136300_136399/136322/11.00.00_60/ts_136322v110000p.pdf
TSDSI	TSDSI STD T1.3GPP 36.322-11.0.0 V1.0.0	11.0.0	30.05.2019	https://members.tdsi.in/index.php/s/BxBT9C9F8KxobBg
TTA	TTAT.3G-36.322(R11-11.0.0)	11.0.0	26.08.2013	http://www.tta.or.kr/data/ttasDown.jsp?where=14688&pk_num=TTAT.3G-36.322(R11-11.0.0)
Release 12				
ARIB	ARIB STD-T104-36.322	12.4.0	12.04.2018	http://www.arib.or.jp/english/html/overview/doc/STD-T104v5_20/2_T104/ARIB-STD-T104/Rel12/36/A36322-c40.pdf
ATIS	ATIS.3GPP.36.322V1240	12.4.0	02.05.2019	https://www.atis.org/docstore/
CCSA	CCSA TSD LTE 36.322	12.4.0	25.08.2016	http://www.ccsa.org.cn/ITU_spec/ITU-R/M.2012/M.2012-4/LTE/REL-12/CCSA-TSD-LTE-36322-c40.rar
ETSI	ETSI TS 136 322	12.4.0	25.08.2016	http://www.etsi.org/deliver/etsi_ts/136300_136399/136322/12.04.00_60/ts_136322v120400p.pdf
TSDSI	TSDSI STD T1.3GPP 36.322-12.4.0 V1.0.0	12.4.0	30.05.2019	https://members.tdsi.in/index.php/s/BxBT9C9F8KxobBg
TTA	TTAT.3G-36.322(R12-12.4.0)	12.4.0	06.07.2017	http://www.tta.or.kr/data/ttasDown.jsp?where=14688&pk_num=TTAT.3G-36.322(R12-12.4.0)
Release 13				
ARIB	ARIB STD-T104-36.322	13.4.0	12.04.2018	http://www.arib.or.jp/english/html/overview/doc/STD-T104v5_20/2_T104/ARIB-STD-T104/Rel13/36/A36322-d40.pdf
ATIS	ATIS.3GPP.36.322V1340	13.4.0	02.05.2019	https://www.atis.org/docstore/
CCSA	CCSA TSD LTE 36.322	13.3.0	09.10.2017	http://www.ccsa.org.cn/ITU_spec/ITU-R/M.2012/M.2012-4/LTE/REL-13/CCSA-TSD-LTE-36322-d30.rar
ETSI	ETSI TS 136 322	13.4.0	09.10.2017	http://www.etsi.org/deliver/etsi_ts/136300_136399/136322/13.04.00_60/ts_136322v130400p.pdf
TSDSI	TSDSI STD T1.3GPP 36.322-13.4.0 V1.0.0	13.4.0	30.05.2019	https://members.tdsi.in/index.php/s/BxBT9C9F8KxobBg

38

TTA TTAT.3G-36.322(R13-13.4.0) 13.4.0 10.05.2018 [http://www.tta.or.kr/data/ttasDown.jsp?where=14688&pk_num=TTAT.3G-36.322\(R13-13.4.0\)](http://www.tta.or.kr/data/ttasDown.jsp?where=14688&pk_num=TTAT.3G-36.322(R13-13.4.0))

Release 14

ARIB ARIB STD-T104-36.322 14.1.0 12.04.2018 http://www.arib.or.jp/english/html/overview/doc/STD-T104v5_20/2_T104/ARIB-STD-T104/Rel14/36/A36322-e10.pdf
ATIS ATIS.3GPP.36.322V1410 14.1.0 02.05.2019 <https://www.atis.org/docstore/>
CCSA CCSA TSD LTE 36.322 14.1.0 11.01.2019 http://www.ccsa.org.cn/ITU_spec/ITU-R/M.2012/M.2012-4/LTE/REL-14/CCSA-TSD-LTE-36322-e10.zip
ETSI ETSI TS 136 322 14.1.0 09.10.2017 http://www.etsi.org/deliver/etsi_ts/136300_136399/136322/14.01.00_60/ts_136322v140100p.pdf
TSDSI TSDSI STD T1.3GPP 36.322-14.1.0 V1.0.0 14.1.0 30.05.2019 <https://members.tdsi.in/index.php/s/BxBT9C9F8KxobBg>
TTA TTAT.3G-36.322(R14-14.1.0) 14.1.0 10.05.2018 [http://www.tta.or.kr/data/ttasDown.jsp?where=14688&pk_num=TTAT.3G-36.322\(R14-14.1.0\)](http://www.tta.or.kr/data/ttasDown.jsp?where=14688&pk_num=TTAT.3G-36.322(R14-14.1.0))

2.1.3.9 TS 36.323

Evolved Universal Terrestrial Radio Access (E-UTRA); Packet Data Convergence Protocol (PDCP) specification

This document specifies the E-UTRA Packet Data Convergence Protocol (PDCP).

SDO	Document No.	Version	Issued date	Location
Release 10				
ARIB	ARIB STD-T104-36.323		10.3.0 12.04.2018	http://www.arib.or.jp/english/html/overview/doc/STD-T104v5_20/2_T104/ARIB-STD-T104/Rel10/36/A36323-a30.pdf
ATIS	ATIS.3GPP.36.323V1030		10.3.0 02.05.2019	https://www.atis.org/docstore/
CCSA	CCSA TSD LTE 36.323		10.3.0 22.07.2014	http://www.ccsa.org.cn/ITU_spec/ITU-R/M.2012/M.2012-4/LTE/REL-10/CCSA-TSD-LTE-36323-a30.rar
ETSI	ETSI TS 136 323		10.3.0 22.07.2014	http://www.etsi.org/deliver/etsi_ts/136300_136399/136323/10.03.00_60/ts_136323v100300p.pdf
TSDSI	TSDSI STD T1.3GPP 36.323-10.3.0 V1.0.0		10.3.0 30.05.2019	https://members.tdsi.in/index.php/s/BxBT9C9F8KxobBg
TTA	TTAT.3G-36.323(R10-10.3.0)		10.3.0 10.08.2016	http://www.tta.or.kr/data/ttasDown.jsp?where=14688&pk_num=TTAT.3G-36.323(R10-10.3.0)
Release 11				
ARIB	ARIB STD-T104-36.323		11.4.0 12.04.2018	http://www.arib.or.jp/english/html/overview/doc/STD-T104v5_20/2_T104/ARIB-STD-T104/Rel11/36/A36323-b40.pdf
ATIS	ATIS.3GPP.36.323V1140		11.4.0 02.05.2019	https://www.atis.org/docstore/
CCSA	CCSA TSD LTE 36.323		11.4.0 29.09.2014	http://www.ccsa.org.cn/ITU_spec/ITU-R/M.2012/M.2012-4/LTE/REL-11/CCSA-TSD-LTE-36323-b40.rar
ETSI	ETSI TS 136 323		11.4.0 29.09.2014	http://www.etsi.org/deliver/etsi_ts/136300_136399/136323/11.04.00_60/ts_136323v110400p.pdf
TSDSI	TSDSI STD T1.3GPP 36.323-11.4.0 V1.0.0		11.4.0 30.05.2019	https://members.tdsi.in/index.php/s/BxBT9C9F8KxobBg
TTA	TTAT.3G-36.323(R11-11.4.0)		11.4.0 10.08.2016	http://www.tta.or.kr/data/ttasDown.jsp?where=14688&pk_num=TTAT.3G-36.323(R11-11.4.0)
Release 12				
ARIB	ARIB STD-T104-36.323		12.6.0 12.04.2018	http://www.arib.or.jp/english/html/overview/doc/STD-T104v5_20/2_T104/ARIB-STD-T104/Rel12/36/A36323-c60.pdf
ATIS	ATIS.3GPP.36.323V1260		12.6.0 02.05.2019	https://www.atis.org/docstore/
CCSA	CCSA TSD LTE 36.323		12.6.0 25.08.2016	http://www.ccsa.org.cn/ITU_spec/ITU-R/M.2012/M.2012-4/LTE/REL-12/CCSA-TSD-LTE-36323-c60.rar
ETSI	ETSI TS 136 323		12.6.0 25.08.2016	http://www.etsi.org/deliver/etsi_ts/136300_136399/136323/12.06.00_60/ts_136323v120600p.pdf
TSDSI	TSDSI STD T1.3GPP 36.323-12.6.0 V1.0.0		12.6.0 30.05.2019	https://members.tdsi.in/index.php/s/BxBT9C9F8KxobBg
TTA	TTAT.3G-36.323(R12-12.6.0)		12.6.0 06.07.2017	http://www.tta.or.kr/data/ttasDown.jsp?where=14688&pk_num=TTAT.3G-36.323(R12-12.6.0)
Release 13				
ARIB	ARIB STD-T104-36.323		13.6.0 12.04.2018	http://www.arib.or.jp/english/html/overview/doc/STD-T104v5_20/2_T104/ARIB-STD-T104/Rel13/36/A36323-d60.pdf
ATIS	ATIS.3GPP.36.323V1360		13.6.0 02.05.2019	https://www.atis.org/docstore/
CCSA	CCSA TSD LTE 36.323		13.6.0 27.07.2017	http://www.ccsa.org.cn/ITU_spec/ITU-R/M.2012/M.2012-4/LTE/REL-13/CCSA-TSD-LTE-36323-d60.rar
ETSI	ETSI TS 136 323		13.6.0 27.07.2017	http://www.etsi.org/deliver/etsi_ts/136300_136399/136323/13.06.00_60/ts_136323v130600p.pdf
TSDSI	TSDSI STD T1.3GPP 36.323-13.6.0 V1.0.0		13.6.0 30.05.2019	https://members.tdsi.in/index.php/s/BxBT9C9F8KxobBg
TTA	TTAT.3G-36.323(R13-13.6.0)		13.6.0 10.05.2018	http://www.tta.or.kr/data/ttasDown.jsp?where=14688&pk_num=TTAT.3G-36.323(R13-13.6.0)

Release 14

ARIB	ARIB STD-T104-36.323	14.5.0	12.04.2018	http://www.arib.or.jp/english/html/overview/doc/STD-T104v5_20/2_T104/ARIB-STD-T104/Rel14/36/A36323-e50.pdf
ATIS	ATIS.3GPP.36.323V1450	14.5.0	02.05.2019	https://www.atis.org/docstore/
CCSA	CCSA TSD LTE 36.323	14.5.0	11.01.2019	http://www.ccsa.org.cn/ITU_spec/ITU-R/M.2012/M.2012-4/LTE/REL-14/CCSA-TSD-LTE-36323-e50.zip
ETSI	ETSI TS 136 323	14.5.0	19.01.2018	http://www.etsi.org/deliver/etsi_ts/136300_136399/136323/14.05.00_60/ts_136323v140500p.pdf
TSDSI	TSDSI STD T1.3GPP 36.323-14.5.0 V1.0.0	14.5.0	30.05.2019	https://members.tdsi.in/index.php/s/BxBT9C9F8KxobBg
TTA	TTAT.3G-36.323(R14-14.5.0)	14.5.0	09.05.2019	http://www.tta.or.kr/data/ttasDown.jsp?where=14688&pk_num=TTAT.3G-36.323(R14-14.5.0)

2.1.3.10 TS 36.331**Evolved Universal Terrestrial Radio Access (E-UTRA); Radio Resource Control (RRC); Protocol specification**

This document specifies the Radio Resource Control protocol for the radio interface between UE and E-UTRAN as well as for the radio interface between RN and E-UTRAN. The scope of this document also includes: (i) the radio related information transported in a transparent container between source eNodeB and target eNodeB upon inter eNodeB handover; (ii) the radio related information transported in a transparent container between a source or target eNodeB and another system upon inter RAT handover.

SDO	Document No.	Version	Issued date	Location
-----	--------------	---------	-------------	----------

Release 10

ARIB	ARIB STD-T104-36.331	10.21.0	12.04.2018	http://www.arib.or.jp/english/html/overview/doc/STD-T104v5_20/2_T104/ARIB-STD-T104/Rel10/36/A36331-al0.pdf
ATIS	ATIS.3GPP.36.331V10210	10.21.0	02.05.2019	https://www.atis.org/docstore/
CCSA	CCSA TSD LTE 36.331	10.20.0	10.10.2017	http://www.ccsa.org.cn/ITU_spec/ITU-R/M.2012/M.2012-4/LTE/REL-10/CCSA-TSD-LTE-36331-ak0.rar
ETSI	ETSI TS 136 331	10.21.0	10.10.2017	http://www.etsi.org/deliver/etsi_ts/136300_136399/136331/10.21.00_60/ts_136331v102100p.pdf
TSDSI	TSDSI STD T1.3GPP 36.331-10.21.0 V1.0.0	10.21.0	30.05.2019	https://members.tdsi.in/index.php/s/BxBT9C9F8KxobBg
TTA	TTAT.3G-36.331(R10-10.21.0)	10.21.0	10.05.2018	http://www.tta.or.kr/data/ttasDown.jsp?where=14688&pk_num=TTAT.3G-36.331(R10-10.21.0)

Release 11

ARIB	ARIB STD-T104-36.331	11.18.0	12.04.2018	http://www.arib.or.jp/english/html/overview/doc/STD-T104v5_20/2_T104/ARIB-STD-T104/Rel11/36/A36331-bi0.pdf
ATIS	ATIS.3GPP.36.331V11180	11.18.0	02.05.2019	https://www.atis.org/docstore/
CCSA	CCSA TSD LTE 36.331	11.17.0	10.10.2017	http://www.ccsa.org.cn/ITU_spec/ITU-R/M.2012/M.2012-4/LTE/REL-11/CCSA-TSD-LTE-36331-bh0.rar
ETSI	ETSI TS 136 331	11.18.0	10.10.2017	http://www.etsi.org/deliver/etsi_ts/136300_136399/136331/11.18.00_60/ts_136331v111800p.pdf
TSDSI	TSDSI STD T1.3GPP 36.331-11.18.0 V1.0.0	11.18.0	30.05.2019	https://members.tdsi.in/index.php/s/BxBT9C9F8KxobBg
TTA	TTAT.3G-36.331(R11-11.18.0)	11.18.0	10.05.2018	http://www.tta.or.kr/data/ttasDown.jsp?where=14688&pk_num=TTAT.3G-36.331(R11-11.18.0)

Release 12

ARIB	ARIB STD-T104-36.331	12.16.0	12.04.2018	http://www.arib.or.jp/english/html/overview/doc/STD-T104v5_20/2_T104/ARIB-STD-T104/Rel12/36/A36331-cg0.pdf
ATIS	ATIS.3GPP.36.331V12160	12.16.0	02.05.2019	https://www.atis.org/docstore/
CCSA	CCSA TSD LTE 36.331	12.14.0	19.01.2018	http://www.ccsa.org.cn/ITU_spec/ITU-R/M.2012/M.2012-4/LTE/REL-12/CCSA-TSD-LTE-36331-ce0.rar
ETSI	ETSI TS 136 331	12.16.0	19.01.2018	http://www.etsi.org/deliver/etsi_ts/136300_136399/136331/12.16.00_60/ts_136331v121600p.pdf
TSDSI	TSDSI STD T1.3GPP 36.331-12.16.0 V1.0.0	12.16.0	30.05.2019	https://members.tdsi.in/index.php/s/BxBT9C9F8KxobBg
TTA	TTAT.3G-36.331(R12-12.16.0)	12.16.0	09.05.2019	http://www.tta.or.kr/data/ttasDown.jsp?where=14688&pk_num=TTAT.3G-36.331(R12-12.16.0)

Release 13

ARIB	ARIB STD-T104-36.331	13.8.1	12.04.2018	http://www.arib.or.jp/english/html/overview/doc/STD-T104v5_20/2_T104/ARIB-STD-T104/Rel13/36/A36331-d81.pdf
ATIS	ATIS.3GPP.36.331V1381	13.8.1	02.05.2019	https://www.atis.org/docstore/
CCSA	CCSA TSD LTE 36.331	13.6.1	19.01.2018	http://www.ccsa.org.cn/ITU_spec/ITU-R/M.2012/M.2012-4/LTE/REL-13/CCSA-TSD-LTE-36331-d61.rar
ETSI	ETSI TS 136 331	13.8.1	19.01.2018	http://www.etsi.org/deliver/etsi_ts/136300_136399/136331/13.08.01_60/ts_136331v130801p.pdf

40

TSDSI	TSDSI STD T1.3GPP 36.331-13.8.1 V1.0.0	13.8.1	30.05.2019	https://members.tdsi.in/index.php/s/BxBT9C9F8KxobBg
TTA	TTAT.3G-36.331(R13-13.8.1)	13.8.1	09.05.2019	http://www.tta.or.kr/data/ttasDown.jsp?where=14688&pk_num=TTAT.3G-36.331(R13-13.8.1)

Release 14

ARIB	ARIB STD-T104-36.331	14.5.1	12.04.2018	http://www.arib.or.jp/english/html/overview/doc/STD-T104v5_20/2_T104/ARIB-STD-T104/Rel14/36/A36331-e51.pdf
ATIS	ATIS.3GPP.36.331V1451	14.5.1	02.05.2019	https://www.atis.org/docstore/
CCSA	CCSA TSD LTE 36.331	14.5.1	11.01.2019	http://www.ccsa.org.cn/ITU_spec/ITU-R/M.2012/M.2012-4/LTE/REL-14/CCSA-TSD-LTE-36331-e51.zip
ETSI	ETSI TS 136 331	14.5.1	19.01.2018	http://www.etsi.org/deliver/etsi_ts/136300_136399/136331/14.05.01_60/ts_136331v140501p.pdf
TSDSI	TSDSI STD T1.3GPP 36.331-14.5.1 V1.0.0	14.5.1	30.05.2019	https://members.tdsi.in/index.php/s/BxBT9C9F8KxobBg
TTA	TTAT.3G-36.331(R14-14.5.1)	14.5.1	09.05.2019	http://www.tta.or.kr/data/ttasDown.jsp?where=14688&pk_num=TTAT.3G-36.331(R14-14.5.1)

2.1.3.11 TS 36.355

Evolved Universal Terrestrial Radio Access (E-UTRA); LTE Positioning Protocol (LPP)

This document contains the definition of the LTE Positioning Protocol (LPP).

SDO	Document No.	Version	Issued date	Location
Release 10				
ARIB	ARIB STD-T104-36.355	10.12.0	12.04.2018	http://www.arib.or.jp/english/html/overview/doc/STD-T104v5_20/2_T104/ARIB-STD-T104/Rel10/36/A36355-ac0.pdf
ATIS	ATIS.3GPP.36.355V10120	10.12.0	02.05.2019	https://www.atis.org/docstore/
CCSA	CCSA TSD LTE 36.355	10.12.0	18.07.2014	http://www.ccsa.org.cn/ITU_spec/ITU-R/M.2012/M.2012-4/LTE/REL-10/CCSA-TSD-LTE-36355-ac0.rar
ETSI	ETSI TS 136 355	10.12.0	18.07.2014	http://www.etsi.org/deliver/etsi_ts/136300_136399/136355/10.12.00_60/ts_136355v101200p.pdf
TSDSI	TSDSI STD T1.3GPP 36.355-10.12.0 V1.0.0	10.12.0	30.05.2019	https://members.tdsi.in/index.php/s/BxBT9C9F8KxobBg
TTA	TTAT.3G-36.355(R10-10.12.0)	10.12.0	10.08.2016	http://www.tta.or.kr/data/ttasDown.jsp?where=14688&pk_num=TTAT.3G-36.355(R10-10.12.0)
Release 11				
ARIB	ARIB STD-T104-36.355	11.6.0	12.04.2018	http://www.arib.or.jp/english/html/overview/doc/STD-T104v5_20/2_T104/ARIB-STD-T104/Rel11/36/A36355-b60.pdf
ATIS	ATIS.3GPP.36.355V1160	11.6.0	02.05.2019	https://www.atis.org/docstore/
CCSA	CCSA TSD LTE 36.355	11.6.0	22.07.2014	http://www.ccsa.org.cn/ITU_spec/ITU-R/M.2012/M.2012-4/LTE/REL-11/CCSA-TSD-LTE-36355-b60.rar
ETSI	ETSI TS 136 355	11.6.0	22.07.2014	http://www.etsi.org/deliver/etsi_ts/136300_136399/136355/11.06.00_60/ts_136355v110600p.pdf
TSDSI	TSDSI STD T1.3GPP 36.355-11.6.0 V1.0.0	11.6.0	30.05.2019	https://members.tdsi.in/index.php/s/BxBT9C9F8KxobBg
TTA	TTAT.3G-36.355(R11-11.6.0)	11.6.0	10.08.2016	http://www.tta.or.kr/data/ttasDown.jsp?where=14688&pk_num=TTAT.3G-36.355(R11-11.6.0)
Release 12				
ARIB	ARIB STD-T104-36.355	12.5.0	12.04.2018	http://www.arib.or.jp/english/html/overview/doc/STD-T104v5_20/2_T104/ARIB-STD-T104/Rel12/36/A36355-c50.pdf
ATIS	ATIS.3GPP.36.355V1250	12.5.0	02.05.2019	https://www.atis.org/docstore/
CCSA	CCSA TSD LTE 36.355	12.5.0	18.01.2016	http://www.ccsa.org.cn/ITU_spec/ITU-R/M.2012/M.2012-4/LTE/REL-12/CCSA-TSD-LTE-36355-c50.rar
ETSI	ETSI TS 136 355	12.5.0	18.01.2016	http://www.etsi.org/deliver/etsi_ts/136300_136399/136355/12.05.00_60/ts_136355v120500p.pdf
TSDSI	TSDSI STD T1.3GPP 36.355-12.5.0 V1.0.0	12.5.0	30.05.2019	https://members.tdsi.in/index.php/s/BxBT9C9F8KxobBg
TTA	TTAT.3G-36.355(R12-12.5.0)	12.5.0	06.07.2017	http://www.tta.or.kr/data/ttasDown.jsp?where=14688&pk_num=TTAT.3G-36.355(R12-12.5.0)
Release 13				
ARIB	ARIB STD-T104-36.355	13.3.0	12.04.2018	http://www.arib.or.jp/english/html/overview/doc/STD-T104v5_20/2_T104/ARIB-STD-T104/Rel13/36/A36355-d30.pdf
ATIS	ATIS.3GPP.36.355V1330	13.3.0	02.05.2019	https://www.atis.org/docstore/
CCSA	CCSA TSD LTE 36.355	13.3.0	16.02.2017	http://www.ccsa.org.cn/ITU_spec/ITU-R/M.2012/M.2012-4/LTE/REL-13/CCSA-TSD-LTE-36355-d30.rar
ETSI	ETSI TS 136 355	13.3.0	16.02.2017	http://www.etsi.org/deliver/etsi_ts/136300_136399/136355/13.03.00_60/ts_136355v130300p.pdf
TSDSI	TSDSI STD T1.3GPP 36.355-13.3.0 V1.0.0	13.3.0	30.05.2019	https://members.tdsi.in/index.php/s/BxBT9C9F8KxobBg
TTA	TTAT.3G-36.355(R13-13.3.0)	13.3.0	10.05.2018	http://www.tta.or.kr/data/ttasDown.jsp?where=14688&pk_num=TTAT.3G-36.355(R13-13.3.0)

Release 14

ARIB	ARIB STD-T104-36.355	14.4.0	12.04.2018	http://www.arib.or.jp/english/html/overview/doc/STD-T104v5_20/2_T104/ARIB-STD-T104/Rel14/36/A36355-e40.pdf
ATIS	ATIS.3GPP.36.355V1440	14.4.0	02.05.2019	https://www.atis.org/docstore/
CCSA	CCSA TSD LTE 36.355	14.4.0	11.01.2019	http://www.ccsa.org.cn/ITU_spec/ITU-R/M.2012/M.2012-4/LTE/REL-14/CCSA-TSD-LTE-36355-e40.zip
ETSI	ETSI TS 136 355	14.4.0	19.01.2018	http://www.etsi.org/deliver/etsi_ts/136300_136399/136355/14.04.00_60/ts_136355v140400p.pdf
TSDSI	TSDSI STD T1.3GPP 36.355-14.4.0 V1.0.0	14.4.0	30.05.2019	https://members.tdsi.in/index.php/s/BxBT9C9F8KxobBg
TTA	TTAT.3G-36.355(R14-14.4.0)	14.4.0	09.05.2019	http://www.tta.or.kr/data/ttasDown.jsp?where=14688&pk_num=TTAT.3G-36.355(R14-14.4.0)

2.1.3.12 TS 36.360**Evolved Universal Terrestrial Radio Access (E-UTRA); LTE-WLAN Aggregation Adaptation Protocol (LWAAP) specification**

This document specifies the E-UTRA LTE-WLAN Aggregation Adaptation Protocol (LWAAP).

SDO	Document No.	Version	Issued date	Location
Release 13				
ARIB	ARIB STD-T104-36.360	13.1.0	12.04.2018	http://www.arib.or.jp/english/html/overview/doc/STD-T104v5_20/2_T104/ARIB-STD-T104/Rel13/36/A36360-d10.pdf
ATIS	ATIS.3GPP.36.360V1310	13.1.0	02.05.2019	https://www.atis.org/docstore/
CCSA	CCSA TSD LTE 36.360	13.1.0	11.04.2017	http://www.ccsa.org.cn/ITU_spec/ITU-R/M.2012/M.2012-4/LTE/REL-13/CCSA-TSD-LTE-36360-d10.rar
ETSI	ETSI TS 136 360	13.1.0	11.04.2017	http://www.etsi.org/deliver/etsi_ts/136300_136399/136360/13.01.00_60/ts_136360v130100p.pdf
TSDSI	TSDSI STD T1.3GPP 36.360-13.1.0 V1.0.0	13.1.0	30.05.2019	https://members.tdsi.in/index.php/s/BxBT9C9F8KxobBg
TTA	TTAT.3G-36.360(R13-13.1.0)	13.1.0	10.05.2018	http://www.tta.or.kr/data/ttasDown.jsp?where=14688&pk_num=TTAT.3G-36.360(R13-13.1.0)
TTC	TS-3GA-36.360(Rel13)v13.1.0	13.1.0	13.04.2018	https://www.ttc.or.jp/st/docs/3gpps2018/TS/TS-3GA-36.360(Rel13)v13.1.0.pdf
Release 14				
ARIB	ARIB STD-T104-36.360	14.0.0	12.04.2018	http://www.arib.or.jp/english/html/overview/doc/STD-T104v5_20/2_T104/ARIB-STD-T104/Rel14/36/A36360-e00.pdf
ATIS	ATIS.3GPP.36.360V1400	14.0.0	02.05.2019	https://www.atis.org/docstore/
CCSA	CCSA TSD LTE 36.360	14.0.0	11.01.2019	http://www.ccsa.org.cn/ITU_spec/ITU-R/M.2012/M.2012-4/LTE/REL-14/CCSA-TSD-LTE-36360-e00.zip
ETSI	ETSI TS 136 360	14.0.0	11.04.2017	http://www.etsi.org/deliver/etsi_ts/136300_136399/136360/14.00.00_60/ts_136360v140000p.pdf
TSDSI	TSDSI STD T1.3GPP 36.360-14.0.0 V1.0.0	14.0.0	30.05.2019	https://members.tdsi.in/index.php/s/BxBT9C9F8KxobBg
TTA	TTAT.3G-36.360(R14-14.0.0)	14.0.0	10.05.2018	http://www.tta.or.kr/data/ttasDown.jsp?where=14688&pk_num=TTAT.3G-36.360(R14-14.0.0)
TTC	TS-3GA-36.360(Rel14)v14.0.0	14.0.0	13.04.2018	https://www.ttc.or.jp/st/docs/3gpps2018/TS/TS-3GA-36.360(Rel14)v14.0.0.pdf

2.1.3.13 TS 36.361**Evolved Universal Terrestrial Radio Access (E-UTRA); LTE/WLAN Radio Level Integration Using IPsec Tunnel (LWIP) encapsulation; Protocol specification**

This document specifies the LWIP Encapsulation Protocol.

SDO	Document No.	Version	Issued date	Location
Release 13				
ARIB	ARIB STD-T104-36.361	13.2.0	12.04.2018	http://www.arib.or.jp/english/html/overview/doc/STD-T104v4_20/2_T104/ARIB-STD-T104/Rel13/36/A36361-d20.pdf
ATIS	ATIS.3GPP.36.361V1320	13.2.0	02.05.2019	https://www.atis.org/docstore/
CCSA	CCSA TSD LTE 36.361	13.2.0	06.10.2016	http://www.ccsa.org.cn/ITU_spec/ITU-R/M.2012/M.2012-4/LTE/REL-13/CCSA-TSD-LTE-36361-d20.rar
ETSI	ETSI TS 136 361	13.2.0	06.10.2016	http://www.etsi.org/deliver/etsi_ts/136300_136399/136361/13.02.00_60/ts_136361v130200p.pdf
TSDSI	TSDSI STD T1.3GPP 36.361-13.2.0 V1.0.0	13.2.0	30.05.2019	https://members.tdsi.in/index.php/s/BxBT9C9F8KxobBg

42

TTA	TTAT.3G-36.361(R13-13.2.0)	13.2.0	06.07.2017	http://www.tta.or.kr/data/ttasDown.jsp?where=14688&pk_num=TTAT.3G-36.361(R13-13.2.0)
TTC	TS-3GA-36.361(Rel13)v13.2.0	13.2.0	13.04.2018	https://www.ttc.or.jp/st/docs/3gpps2018/TS/TS-3GA-36.361(Rel13)v13.2.0.pdf

Release 14

ARIB	ARIB STD-T104-36.361	14.1.0	12.04.2018	http://www.arib.or.jp/english/html/overview/doc/STD-T104v5_202_T104/ARIB-STD-T104/Rel14/36/A36361-e10.pdf
ATIS	ATIS.3GPP.36.361V1410	14.1.0	02.05.2019	https://www.atis.org/docstore/
CCSA	CCSA TSD LTE 36.361	14.1.0	11.01.2019	http://www.ccsa.org.cn/ITU_spec/ITU-R/M.2012/M.2012-4/LTE/REL-14/CCSA-TSD-LTE-36361-e10.zip
ETSI	ETSI TS 136 361	14.1.0	24.08.2017	http://www.etsi.org/deliver/etsi_ts/136300_136399/136361/14.01.00_60/ts_136361v140100p.pdf
TSDSI	TSDSI STD T1.3GPP 36.361-14.1.0 V1.0.0	14.1.0	30.05.2019	https://members.tdsi.in/index.php/s/BxBT9C9F8KxobBg
TTA	TTAT.3G-36.361(R14-14.1.0)	14.1.0	10.05.2018	http://www.tta.or.kr/data/ttasDown.jsp?where=14688&pk_num=TTAT.3G-36.361(R14-14.1.0)
TTC	TS-3GA-36.361(Rel14)v14.1.0	14.1.0	13.04.2018	https://www.ttc.or.jp/st/docs/3gpps2018/TS/TS-3GA-36.361(Rel14)v14.1.0.pdf

2.1.4 Architecture

2.1.4.1 TS 36.401

Evolved Universal Terrestrial Radio Access Network (E-UTRAN); Architecture description

This document describes the overall architecture of the E-UTRAN, including internal interfaces and assumptions on the radio, S1 and X2 interfaces.

SDO	Document No.	Version	Issued date	Location	
Release 10					
ATIS	ATIS.3GPP.36.401V1040		10.4.0	02.05.2019	https://www.atis.org/docstore/
CCSA	CCSA TSD LTE 36.401		10.4.0	18.07.2012	http://www.ccsa.org.cn/ITU_spec/ITU-R/M.2012/M.2012-4/LTE/REL-10/CCSA-TSD-LTE-36401-a40.rar
ETSI	ETSI TS 136 401		10.4.0	18.07.2012	http://www.etsi.org/deliver/etsi_ts/136400_136499/136401/10.04.00_60/ts_136401v100400p.pdf
TSDSI	TSDSI STD T1.3GPP 36.401-10.4.0 V1.0.0		10.4.0	30.05.2019	https://members.tdsi.in/index.php/s/BxBT9C9F8KxobBg
TTA	TTAT.3G-36.401(R10-10.4.0)		10.4.0	10.08.2016	http://www.tta.or.kr/data/ttasDown.jsp?where=14688&pk_num=TTAT.3G-36.401(R10-10.4.0)
TTC	TS-3GA-36.401(Rel10)v10.4.0		10.4.0	19.09.2012	https://www.ttc.or.jp/st/docs/3gpps2012/TS/TS-3GA-36.401(Rel10)v10.4.0.pdf
Release 11					
ATIS	ATIS.3GPP.36.401V1120		11.2.0	02.05.2019	https://www.atis.org/docstore/
CCSA	CCSA TSD LTE 36.401		11.2.0	26.09.2013	http://www.ccsa.org.cn/ITU_spec/ITU-R/M.2012/M.2012-4/LTE/REL-11/CCSA-TSD-LTE-36401-b20.rar
ETSI	ETSI TS 136 401		11.2.0	26.09.2013	http://www.etsi.org/deliver/etsi_ts/136400_136499/136401/11.02.00_60/ts_136401v110200p.pdf
TSDSI	TSDSI STD T1.3GPP 36.401-11.2.0 V1.0.0		11.2.0	30.05.2019	https://members.tdsi.in/index.php/s/BxBT9C9F8KxobBg
TTA	TTAT.3G-36.401(R11-11.2.0)		11.2.0	10.08.2016	http://www.tta.or.kr/data/ttasDown.jsp?where=14688&pk_num=TTAT.3G-36.401(R11-11.2.0)
TTC	TS-3GA-36.401(Rel11)v11.2.0		11.2.0	22.11.2013	https://www.ttc.or.jp/st/docs/3gpps2013/TS/TS-3GA-36.401(Rel11)v11.2.0.pdf
Release 12					
ATIS	ATIS.3GPP.36.401V1230		12.3.0	02.05.2019	https://www.atis.org/docstore/
CCSA	CCSA TSD LTE 36.401		12.3.0	15.01.2016	http://www.ccsa.org.cn/ITU_spec/ITU-R/M.2012/M.2012-4/LTE/REL-12/CCSA-TSD-LTE-36401-c30.rar
ETSI	ETSI TS 136 401		12.3.0	15.01.2016	http://www.etsi.org/deliver/etsi_ts/136400_136499/136401/12.03.00_60/ts_136401v120300p.pdf
TSDSI	TSDSI STD T1.3GPP 36.401-12.3.0 V1.0.0		12.3.0	30.05.2019	https://members.tdsi.in/index.php/s/BxBT9C9F8KxobBg
TTA	TTAT.3G-36.401(R12-12.3.0)		12.3.0	06.07.2017	http://www.tta.or.kr/data/ttasDown.jsp?where=14688&pk_num=TTAT.3G-36.401(R12-12.3.0)
TTC	TS-3GA-36.401(Rel12)v12.3.0		12.3.0	25.03.2016	https://www.ttc.or.jp/st/docs/3gpps2016/TS/TS-3GA-36.401(Rel12)v12.3.0.pdf
Release 13					
ATIS	ATIS.3GPP.36.401V1320		13.2.0	02.05.2019	https://www.atis.org/docstore/
CCSA	CCSA TSD LTE 36.401		13.2.0	25.08.2016	http://www.ccsa.org.cn/ITU_spec/ITU-R/M.2012/M.2012-4/LTE/REL-13/CCSA-TSD-LTE-36401-d20.rar

ETSI	ETSI TS 136 401	13.2.0	25.08.2016	http://www.etsi.org/deliver/etsi_ts/136400_136499/136401/13.02.00_60/ts_136401v130200p.pdf
TSDSI	TSDSI STD T1.3GPP 36.401-13.2.0 V1.0.0	13.2.0	30.05.2019	https://members.tdsi.in/index.php/s/BxBT9C9F8KxobBg
TTA	TTAT.3G-36.401(R13-13.2.0)	13.2.0	06.07.2017	http://www.tta.or.kr/data/ttasDown.jsp?where=14688&pk_num=TTAT.3G-36.401(R13-13.2.0)
TTC	TS-3GA-36.401(Rel13)v13.2.0	13.2.0	31.03.2017	https://www.ttc.or.jp/st/docs/3gpps2017/TS/TS-3GA-36.401(Rel13)v13.2.0.pdf

Release 14

ATIS	ATIS.3GPP.36.401V1400	14.0.0	02.05.2019	https://www.atis.org/docstore/
CCSA	CCSA TSD LTE 36.401	14.0.0	11.01.2019	http://www.ccsa.org.cn/ITU_spec/ITU-R/M.2012/M.2012-4/LTE/REL-14/CCSA-TSD-LTE-36401-e00.zip
ETSI	ETSI TS 136 401	14.0.0	11.04.2017	http://www.etsi.org/deliver/etsi_ts/136400_136499/136401/14.00.00_60/ts_136401v140000p.pdf
TSDSI	TSDSI STD T1.3GPP 36.401-14.0.0 V1.0.0	14.0.0	30.05.2019	https://members.tdsi.in/index.php/s/BxBT9C9F8KxobBg
TTA	TTAT.3G-36.401(R14-14.0.0)	14.0.0	10.05.2018	http://www.tta.or.kr/data/ttasDown.jsp?where=14688&pk_num=TTAT.3G-36.401(R14-14.0.0)
TTC	TS-3GA-36.401(Rel14)v14.0.0	14.0.0	13.04.2018	https://www.ttc.or.jp/st/docs/3gpps2018/TS/TS-3GA-36.401(Rel14)v14.0.0.pdf

2.1.4.2 TS 36.410**Evolved Universal Terrestrial Radio Access Network (E-UTRAN); S1 layer 1 general aspects and principles**

This document is an introduction to the 3GPP TS 36.41x series of technical specifications that define the S1 interface for the interconnection of the eNodeB component of the Evolved Universal Terrestrial Radio Access Network (E-UTRAN) to the Core Network of the EPS system.

SDO	Document No.	Version	Issued date	Location
Release 10				
ATIS	ATIS.3GPP.36.410V1030	10.3.0	02.05.2019	https://www.atis.org/docstore/
CCSA	CCSA TSD LTE 36.410	10.3.0	18.07.2012	http://www.ccsa.org.cn/ITU_spec/ITU-R/M.2012/M.2012-4/LTE/REL-10/CCSA-TSD-LTE-36410-a30.rar
ETSI	ETSI TS 136 410	10.3.0	18.07.2012	http://www.etsi.org/deliver/etsi_ts/136400_136499/136410/10.03.00_60/ts_136410v100300p.pdf
TSDSI	TSDSI STD T1.3GPP 36.410-10.3.0 V1.0.0	10.3.0	30.05.2019	https://members.tdsi.in/index.php/s/BxBT9C9F8KxobBg
TTA	TTAT.3G-36.410(R10-10.3.0)	10.3.0	10.08.2016	http://www.tta.or.kr/data/ttasDown.jsp?where=14688&pk_num=TTAT.3G-36.410(R10-10.3.0)
TTC	TS-3GA-36.410(Rel10)v10.3.0	10.3.0	19.09.2012	https://www.ttc.or.jp/st/docs/3gpps2012/TS/TS-3GA-36.410(Rel10)v10.3.0.pdf
Release 11				
ATIS	ATIS.3GPP.36.410V1110	11.1.0	02.05.2019	https://www.atis.org/docstore/
CCSA	CCSA TSD LTE 36.410	11.1.0	26.09.2013	http://www.ccsa.org.cn/ITU_spec/ITU-R/M.2012/M.2012-4/LTE/REL-11/CCSA-TSD-LTE-36410-b10.rar
ETSI	ETSI TS 136 410	11.1.0	26.09.2013	http://www.etsi.org/deliver/etsi_ts/136400_136499/136410/11.01.00_60/ts_136410v110100p.pdf
TSDSI	TSDSI STD T1.3GPP 36.410-11.1.0 V1.0.0	11.1.0	30.05.2019	https://members.tdsi.in/index.php/s/BxBT9C9F8KxobBg
TTA	TTAT.3G-36.410(R11-11.1.0)	11.1.0	10.08.2016	http://www.tta.or.kr/data/ttasDown.jsp?where=14688&pk_num=TTAT.3G-36.410(R11-11.1.0)
TTC	TS-3GA-36.410(Rel11)v11.1.0	11.1.0	22.11.2013	https://www.ttc.or.jp/st/docs/3gpps2013/TS/TS-3GA-36.410(Rel11)v11.1.0.pdf
Release 12				
ATIS	ATIS.3GPP.36.410V1210	12.1.0	02.05.2019	https://www.atis.org/docstore/
CCSA	CCSA TSD LTE 36.410	12.1.0	04.02.2015	http://www.ccsa.org.cn/ITU_spec/ITU-R/M.2012/M.2012-4/LTE/REL-12/CCSA-TSD-LTE-36410-c10.rar
ETSI	ETSI TS 136 410	12.1.0	04.02.2015	http://www.etsi.org/deliver/etsi_ts/136400_136499/136410/12.01.00_60/ts_136410v120100p.pdf
TSDSI	TSDSI STD T1.3GPP 36.410-12.1.0 V1.0.0	12.1.0	30.05.2019	https://members.tdsi.in/index.php/s/BxBT9C9F8KxobBg
TTA	TTAT.3G-36.410(R12-12.1.0)	12.1.0	09.04.2015	http://www.tta.or.kr/data/ttasDown.jsp?where=14688&pk_num=TTAT.3G-36.410(R12-12.1.0)
TTC	TS-3GA-36.410(Rel12)v12.1.0	12.1.0	05.03.2015	https://www.ttc.or.jp/st/docs/3gpps2015/TS/TS-3GA-36.410(Rel12)v12.1.0.pdf
Release 13				
ATIS	ATIS.3GPP.36.410V1300	13.0.0	02.05.2019	https://www.atis.org/docstore/
CCSA	CCSA TSD LTE 36.410	13.0.0	21.01.2016	http://www.ccsa.org.cn/ITU_spec/ITU-R/M.2012/M.2012-4/LTE/REL-13/CCSA-TSD-LTE-36410-d00.rar

44

ETSI	ETSI TS 136 410	13.0.0	21.01.2016	http://www.etsi.org/deliver/etsi_ts/136400_136499/136410/13.00.00_60/ts_136410v130000p.pdf
TSDSI	TSDSI STD T1.3GPP 36.410-13.0.0 V1.0.0	13.0.0	30.05.2019	https://members.tdsi.in/index.php/s/BxBT9C9F8KxobBg
TTA	TTAT.3G-36.410(R13-13.0.0)	13.0.0	06.07.2017	http://www.tta.or.kr/data/ttasDown.jsp?where=14688&pk_num=TTAT.3G-36.410(R13-13.0.0)
TTC	TS-3GA-36.410(Rel13)v13.0.0	13.0.0	31.03.2017	https://www.ttc.or.jp/st/docs/3gpps2017/TS/TS-3GA-36.410(Rel13)v13.0.0.pdf

Release 14

ATIS	ATIS.3GPP.36.410V1400	14.0.0	02.05.2019	https://www.atis.org/docstore/
CCSA	CCSA TSD LTE 36.410	14.0.0	11.01.2019	http://www.ccsa.org.cn/ITU_spec/ITU-R/M.2012/M.2012-4/LTE/REL-14/CCSA-TSD-LTE-36410-e00.zip
ETSI	ETSI TS 136 410	14.0.0	11.04.2017	http://www.etsi.org/deliver/etsi_ts/136400_136499/136410/14.00.00_60/ts_136410v140000p.pdf
TSDSI	TSDSI STD T1.3GPP 36.410-14.0.0 V1.0.0	14.0.0	30.05.2019	https://members.tdsi.in/index.php/s/BxBT9C9F8KxobBg
TTA	TTAT.3G-36.410(R14-14.0.0)	14.0.0	10.05.2018	http://www.tta.or.kr/data/ttasDown.jsp?where=14688&pk_num=TTAT.3G-36.410(R14-14.0.0)
TTC	TS-3GA-36.410(Rel14)v14.0.0	14.0.0	13.04.2018	https://www.ttc.or.jp/st/docs/3gpps2018/TS/TS-3GA-36.410(Rel14)v14.0.0.pdf

2.1.4.3 TS 36.411

Evolved Universal Terrestrial Radio Access Network (E-UTRAN); S1 layer 1

This document specifies the standards allowed to implement layer 1 on the S1 interface. The specification of transmission delay requirements and O&M requirements are not in the scope of this document. In the following, “layer 1” and “physical layer” are assumed to be synonymous.

SDO	Document No.	Version	Issued date	Location
Release 10				
ATIS	ATIS.3GPP.36.411V1010	10.1.0	02.05.2019	https://www.atis.org/docstore/
CCSA	CCSA TSD LTE 36.411	10.1.0	30.06.2011	http://www.ccsa.org.cn/ITU_spec/ITU-R/M.2012/M.2012-4/LTE/REL-10/CCSA-TSD-LTE-36411-a10.rar
ETSI	ETSI TS 136 411	10.1.0	30.06.2011	http://www.etsi.org/deliver/etsi_ts/136400_136499/136411/10.01.00_60/ts_136411v100100p.pdf
TSDSI	TSDSI STD T1.3GPP 36.411-10.1.0 V1.0.0	10.1.0	30.05.2019	https://members.tdsi.in/index.php/s/BxBT9C9F8KxobBg
TTA	TTAT.3G-36.411(R10-10.1.0)	10.1.0	26.08.2011	http://www.tta.or.kr/data/ttasDown.jsp?where=14688&pk_num=TTAT.3G-36.411(R10-10.1.0)
TTC	TS-3GA-36.411(Rel10)v10.1.0	10.1.0	31.08.2011	https://www.ttc.or.jp/st/docs/3gpps2011/TS/TS-3GA-36.411(Rel10)v10.1.0.pdf
Release 11				
ATIS	ATIS.3GPP.36.411V1100	11.0.0	02.05.2019	https://www.atis.org/docstore/
CCSA	CCSA TSD LTE 36.411	11.0.0	18.10.2012	http://www.ccsa.org.cn/ITU_spec/ITU-R/M.2012/M.2012-4/LTE/REL-11/CCSA-TSD-LTE-36411-b00.rar
ETSI	ETSI TS 136 411	11.0.0	18.10.2012	http://www.etsi.org/deliver/etsi_ts/136400_136499/136411/11.00.00_60/ts_136411v110000p.pdf
TSDSI	TSDSI STD T1.3GPP 36.411-11.0.0 V1.0.0	11.0.0	30.05.2019	https://members.tdsi.in/index.php/s/BxBT9C9F8KxobBg
TTA	TTAT.3G-36.411(R11-11.0.0)	11.0.0	26.08.2013	http://www.tta.or.kr/data/ttasDown.jsp?where=14688&pk_num=TTAT.3G-36.411(R11-11.0.0)
TTC	TS-3GA-36.411(Rel11)v11.0.0	11.0.0	25.06.2013	https://www.ttc.or.jp/st/docs/3gpps2013/TS/TS-3GA-36.411(Rel11)v11.0.0.pdf
Release 12				
ATIS	ATIS.3GPP.36.411V1200	12.0.0	02.05.2019	https://www.atis.org/docstore/
CCSA	CCSA TSD LTE 36.411	12.0.0	25.09.2014	http://www.ccsa.org.cn/ITU_spec/ITU-R/M.2012/M.2012-4/LTE/REL-12/CCSA-TSD-LTE-36411-c00.rar
ETSI	ETSI TS 136 411	12.0.0	25.09.2014	http://www.etsi.org/deliver/etsi_ts/136400_136499/136411/12.00.00_60/ts_136411v120000p.pdf
TSDSI	TSDSI STD T1.3GPP 36.411-12.0.0 V1.0.0	12.0.0	30.05.2019	https://members.tdsi.in/index.php/s/BxBT9C9F8KxobBg
TTA	TTAT.3G-36.411(R12-12.0.0)	12.0.0	09.04.2015	http://www.tta.or.kr/data/ttasDown.jsp?where=14688&pk_num=TTAT.3G-36.411(R12-12.0.0)
TTC	TS-3GA-36.411(Rel12)v12.0.0	12.0.0	05.03.2015	https://www.ttc.or.jp/st/docs/3gpps2015/TS/TS-3GA-36.411(Rel12)v12.0.0.pdf
Release 13				
ATIS	ATIS.3GPP.36.411V1300	13.0.0	02.05.2019	https://www.atis.org/docstore/
CCSA	CCSA TSD LTE 36.411	13.0.0	21.01.2016	http://www.ccsa.org.cn/ITU_spec/ITU-R/M.2012/M.2012-4/LTE/REL-13/CCSA-TSD-LTE-36411-d00.rar

ETSI	ETSI TS 136 411	13.0.0	21.01.2016	http://www.etsi.org/deliver/etsi_ts/136400_136499/136411/13.00.00_60/ts_136411v130000p.pdf
TSDSI	TSDSI STD T1.3GPP 36.411-13.0.0 V1.0.0	13.0.0	30.05.2019	https://members.tdsi.in/index.php/s/BxBT9C9F8KxobBg
TTA	TTAT.3G-36.411(R13-13.0.0)	13.0.0	06.07.2017	http://www.tta.or.kr/data/ttasDown.jsp?where=14688&pk_num=TTAT.3G-36.411(R13-13.0.0)
TTC	TS-3GA-36.411(Rel13)v13.0.0	13.0.0	31.03.2017	https://www.ttc.or.jp/st/docs/3gpps2017/TS/TS-3GA-36.411(Rel13)v13.0.0.pdf

Release 14

ATIS	ATIS.3GPP.36.411V1400	14.0.0	02.05.2019	https://www.atis.org/docstore/
CCSA	CCSA TSD LTE 36.411	14.0.0	11.01.2019	http://www.ccsa.org.cn/ITU_spec/ITU-R/M.2012/M.2012-4/LTE/REL-14/CCSA-TSD-LTE-36411-e00.zip
ETSI	ETSI TS 136 411	14.0.0	11.04.2017	http://www.etsi.org/deliver/etsi_ts/136400_136499/136411/14.00.00_60/ts_136411v140000p.pdf
TSDSI	TSDSI STD T1.3GPP 36.411-14.0.0 V1.0.0	14.0.0	30.05.2019	https://members.tdsi.in/index.php/s/BxBT9C9F8KxobBg
TTA	TTAT.3G-36.411(R14-14.0.0)	14.0.0	10.05.2018	http://www.tta.or.kr/data/ttasDown.jsp?where=14688&pk_num=TTAT.3G-36.411(R14-14.0.0)
TTC	TS-3GA-36.411(Rel14)v14.0.0	14.0.0	13.04.2018	https://www.ttc.or.jp/st/docs/3gpps2018/TS/TS-3GA-36.411(Rel14)v14.0.0.pdf

2.1.4.4 TS 36.412**Evolved Universal Terrestrial Radio Access Network (E-UTRAN); S1 signalling transport**

This document specifies the standards for signalling transport to be used across S1 interface. S1 interface is a logical interface between the eNodeB and the E-UTRAN core network. This document describes how the S1-AP signalling messages are transported over S1.

SDO	Document No.	Version	Issued date	Location
Release 10				
ATIS	ATIS.3GPP.36.412V1010	10.1.0	02.05.2019	https://www.atis.org/docstore/
CCSA	CCSA TSD LTE 36.412	10.1.0	30.06.2011	http://www.ccsa.org.cn/ITU_spec/ITU-R/M.2012/M.2012-4/LTE/REL-10/CCSA-TSD-LTE-36412-a10.rar
ETSI	ETSI TS 136 412	10.1.0	30.06.2011	http://www.etsi.org/deliver/etsi_ts/136400_136499/136412/10.01.00_60/ts_136412v100100p.pdf
TSDSI	TSDSI STD T1.3GPP 36.412-10.1.0 V1.0.0	10.1.0	30.05.2019	https://members.tdsi.in/index.php/s/BxBT9C9F8KxobBg
TTA	TTAT.3G-36.412(R10-10.1.0)	10.1.0	26.08.2011	http://www.tta.or.kr/data/ttasDown.jsp?where=14688&pk_num=TTAT.3G-36.412(R10-10.1.0)
TTC	TS-3GA-36.412(Rel10)v10.1.0	10.1.0	31.08.2011	https://www.ttc.or.jp/st/docs/3gpps2011/TS/TS-3GA-36.412(Rel10)v10.1.0.pdf
Release 11				
ATIS	ATIS.3GPP.36.412V1100	11.0.0	02.05.2019	https://www.atis.org/docstore/
CCSA	CCSA TSD LTE 36.412	11.0.0	18.10.2012	http://www.ccsa.org.cn/ITU_spec/ITU-R/M.2012/M.2012-4/LTE/REL-11/CCSA-TSD-LTE-36412-b00.rar
ETSI	ETSI TS 136 412	11.0.0	18.10.2012	http://www.etsi.org/deliver/etsi_ts/136400_136499/136412/11.00.00_60/ts_136412v110000p.pdf
TSDSI	TSDSI STD T1.3GPP 36.412-11.0.0 V1.0.0	11.0.0	30.05.2019	https://members.tdsi.in/index.php/s/BxBT9C9F8KxobBg
TTA	TTAT.3G-36.412(R11-11.0.0)	11.0.0	26.08.2013	http://www.tta.or.kr/data/ttasDown.jsp?where=14688&pk_num=TTAT.3G-36.412(R11-11.0.0)
TTC	TS-3GA-36.412(Rel11)v11.0.0	11.0.0	25.06.2013	https://www.ttc.or.jp/st/docs/3gpps2013/TS/TS-3GA-36.412(Rel11)v11.0.0.pdf
Release 12				
ATIS	ATIS.3GPP.36.412V1200	12.0.0	02.05.2019	https://www.atis.org/docstore/
CCSA	CCSA TSD LTE 36.412	12.0.0	25.09.2014	http://www.ccsa.org.cn/ITU_spec/ITU-R/M.2012/M.2012-4/LTE/REL-12/CCSA-TSD-LTE-36412-c00.rar
ETSI	ETSI TS 136 412	12.0.0	25.09.2014	http://www.etsi.org/deliver/etsi_ts/136400_136499/136412/12.00.00_60/ts_136412v120000p.pdf
TSDSI	TSDSI STD T1.3GPP 36.412-12.0.0 V1.0.0	12.0.0	30.05.2019	https://members.tdsi.in/index.php/s/BxBT9C9F8KxobBg
TTA	TTAT.3G-36.412(R12-12.0.0)	12.0.0	09.04.2015	http://www.tta.or.kr/data/ttasDown.jsp?where=14688&pk_num=TTAT.3G-36.412(R12-12.0.0)
TTC	TS-3GA-36.412(Rel12)v12.0.0	12.0.0	05.03.2015	https://www.ttc.or.jp/st/docs/3gpps2015/TS/TS-3GA-36.412(Rel12)v12.0.0.pdf
Release 13				
ATIS	ATIS.3GPP.36.412V1300	13.0.0	02.05.2019	https://www.atis.org/docstore/
CCSA	CCSA TSD LTE 36.412	13.0.0	21.01.2016	http://www.ccsa.org.cn/ITU_spec/ITU-R/M.2012/M.2012-4/LTE/REL-13/CCSA-TSD-LTE-36412-d00.rar

				Rec. ITU-R M.2012-4	
ETSI	ETSI TS 136 412	13.0.0	21.01.2016	http://www.etsi.org/deliver/etsi_ts/136400_136499/136412/13.00.00_60/ts_136412v130000p.pdf	
TSDSI	TSDSI STD T1.3GPP 36.412-13.0.0 V1.0.0	13.0.0	30.05.2019	https://members.tdsi.in/index.php/s/BxBT9C9F8KxobBg	
TTA	TTAT.3G-36.412(R13-13.0.0)	13.0.0	06.07.2017	http://www.tta.or.kr/data/ttasDown.jsp?where=14688&pk_num=TTAT.3G-36.412(R13-13.0.0)	
TTC	TS-3GA-36.412(Rel13)v13.0.0	13.0.0	31.03.2017	https://www.ttc.or.jp/st/docs/3gpps2017/TS/TS-3GA-36.412(Rel13)v13.0.0.pdf	

Release 14

ATIS	ATIS.3GPP.36.412V1400	14.0.0	02.05.2019	https://www.atis.org/docstore/
CCSA	CCSA TSD LTE 36.412	14.0.0	11.01.2019	http://www.ccsa.org.cn/ITU_spec/ITU-R/M.2012/M.2012-4/LTE/REL-14/CCSA-TSD-LTE-36412-e00.zip
ETSI	ETSI TS 136 412	14.0.0	11.04.2017	http://www.etsi.org/deliver/etsi_ts/136400_136499/136412/14.00.00_60/ts_136412v140000p.pdf
TSDSI	TSDSI STD T1.3GPP 36.412-14.0.0 V1.0.0	14.0.0	30.05.2019	https://members.tdsi.in/index.php/s/BxBT9C9F8KxobBg
TTA	TTAT.3G-36.412(R14-14.0.0)	14.0.0	10.05.2018	http://www.tta.or.kr/data/ttasDown.jsp?where=14688&pk_num=TTAT.3G-36.412(R14-14.0.0)
TTC	TS-3GA-36.412(Rel14)v14.0.0	14.0.0	13.04.2018	https://www.ttc.or.jp/st/docs/3gpps2018/TS/TS-3GA-36.412(Rel14)v14.0.0.pdf

2.1.4.5 TS 36.413

Evolved Universal Terrestrial Radio Access Network (E-UTRAN); S1 Application Protocol (S1AP)

This document specifies the E-UTRAN radio network layer signalling protocol for the S1 interface. The S1 Application Protocol (S1AP) supports the functions of S1 interface by signalling procedures defined in this document.

SDO	Document No.	Version	Issued date	Location
Release 10				
ATIS	ATIS.3GPP.36.413V1090	10.9.0	02.05.2019	https://www.atis.org/docstore/
CCSA	CCSA TSD LTE 36.413	10.9.0	26.09.2014	http://www.ccsa.org.cn/ITU_spec/ITU-R/M.2012/M.2012-4/LTE/REL-10/CCSA-TSD-LTE-36413-a90.rar
ETSI	ETSI TS 136 413	10.9.0	26.09.2014	http://www.etsi.org/deliver/etsi_ts/136400_136499/136413/10.09.00_60/ts_136413v100900p.pdf
TSDSI	TSDSI STD T1.3GPP 36.413-10.9.0 V1.0.0	10.9.0	30.05.2019	https://members.tdsi.in/index.php/s/BxBT9C9F8KxobBg
TTA	TTAT.3G-36.413(R10-10.9.0)	10.9.0	10.08.2016	http://www.tta.or.kr/data/ttasDown.jsp?where=14688&pk_num=TTAT.3G-36.413(R10-10.9.0)
TTC	TS-3GA-36.413(Rel10)v10.9.0	10.9.0	18.12.2014	https://www.ttc.or.jp/st/docs/3gpps2014/TS/TS-3GA-36.413(Rel10)v10.9.0.pdf
Release 11				
ATIS	ATIS.3GPP.36.413V1180	11.8.0	02.05.2019	https://www.atis.org/docstore/
CCSA	CCSA TSD LTE 36.413	11.8.0	26.09.2014	http://www.ccsa.org.cn/ITU_spec/ITU-R/M.2012/M.2012-4/LTE/REL-11/CCSA-TSD-LTE-36413-b80.rar
ETSI	ETSI TS 136 413	11.8.0	26.09.2014	http://www.etsi.org/deliver/etsi_ts/136400_136499/136413/11.08.00_60/ts_136413v110800p.pdf
TSDSI	TSDSI STD T1.3GPP 36.413-11.8.0 V1.0.0	11.8.0	30.05.2019	https://members.tdsi.in/index.php/s/BxBT9C9F8KxobBg
TTA	TTAT.3G-36.413(R11-11.8.0)	11.8.0	10.08.2016	http://www.tta.or.kr/data/ttasDown.jsp?where=14688&pk_num=TTAT.3G-36.413(R11-11.8.0)
TTC	TS-3GA-36.413(Rel11)v11.8.0	11.8.0	18.12.2014	https://www.ttc.or.jp/st/docs/3gpps2014/TS/TS-3GA-36.413(Rel11)v11.8.0.pdf
Release 12				
ATIS	ATIS.3GPP.36.413V1270	12.7.0	02.05.2019	https://www.atis.org/docstore/
CCSA	CCSA TSD LTE 36.413	12.7.0	20.05.2016	http://www.ccsa.org.cn/ITU_spec/ITU-R/M.2012/M.2012-4/LTE/REL-12/CCSA-TSD-LTE-36413-c70.rar
ETSI	ETSI TS 136 413	12.7.0	20.05.2016	http://www.etsi.org/deliver/etsi_ts/136400_136499/136413/12.07.00_60/ts_136413v120700p.pdf
TSDSI	TSDSI STD T1.3GPP 36.413-12.7.0 V1.0.0	12.7.0	30.05.2019	https://members.tdsi.in/index.php/s/BxBT9C9F8KxobBg
TTA	TTAT.3G-36.413(R12-12.7.0)	12.7.0	06.07.2017	http://www.tta.or.kr/data/ttasDown.jsp?where=14688&pk_num=TTAT.3G-36.413(R12-12.7.0)
TTC	TS-3GA-36.413(Rel12)v12.7.0	12.7.0	30.06.2016	https://www.ttc.or.jp/st/docs/3gpps2016/TS/TS-3GA-36.413(Rel12)v12.7.0.pdf
Release 13				
ATIS	ATIS.3GPP.36.413V1360	13.6.0	02.05.2019	https://www.atis.org/docstore/
CCSA	CCSA TSD LTE 36.413	13.6.0	24.08.2017	http://www.ccsa.org.cn/ITU_spec/ITU-R/M.2012/M.2012-4/LTE/REL-13/CCSA-TSD-LTE-36413-d60.rar

ETSI	ETSI TS 136 413	13.6.0	24.08.2017	http://www.etsi.org/deliver/etsi_ts/136400_136499/136413/13.06.00_60/ts_136413v130600p.pdf
TSDSI	TSDSI STD T1.3GPP 36.413-13.6.0 V1.0.0	13.6.0	30.05.2019	https://members.tdsi.in/index.php/s/BxBT9C9F8KxobBg
TTA	TTAT.3G-36.413(R13-13.6.0)	13.6.0	10.05.2018	http://www.tta.or.kr/data/ttasDown.jsp?where=14688&pk_num=TTAT.3G-36.413(R13-13.6.0)
TTC	TS-3GA-36.413(Rel13)v13.6.0	13.6.0	22.09.2017	https://www.ttc.or.jp/st/docs/3gpps2017/TS/TS-3GA-36.413(Rel13)v13.6.0.pdf

Release 14

ATIS	ATIS.3GPP.36.413V1441	14.4.1	02.05.2019	https://www.atis.org/docstore/
CCSA	CCSA TSD LTE 36.413	14.4.1	11.01.2019	http://www.ccsa.org.cn/ITU_spec/ITU-R/M.2012/M.2012-4/LTE/REL-14/CCSA-TSD-LTE-36413-e41.zip
ETSI	ETSI TS 136 413	14.4.1	25.01.2018	http://www.etsi.org/deliver/etsi_ts/136400_136499/136413/14.04.01_60/ts_136413v140401p.pdf
TSDSI	TSDSI STD T1.3GPP 36.413-14.4.1 V1.0.0	14.4.1	30.05.2019	https://members.tdsi.in/index.php/s/BxBT9C9F8KxobBg
TTA	TTAT.3G-36.413(R14-14.4.1)	14.4.1	09.05.2019	http://www.tta.or.kr/data/ttasDown.jsp?where=14688&pk_num=TTAT.3G-36.413(R14-14.4.1)
TTC	TS-3GA-36.413(Rel14)v14.4.1	14.4.1	13.04.2018	https://www.ttc.or.jp/st/docs/3gpps2018/TS/TS-3GA-36.413(Rel14)v14.4.1.pdf

2.1.4.6 TS 36.414**Evolved Universal Terrestrial Radio Access Network (E-UTRAN); S1 data transport**

This document specifies the standards for user data transport protocols and related signalling protocols to establish user plane transport bearers over the S1 interface.

SDO	Document No.	Version	Issued date	Location
Release 10				
ATIS	ATIS.3GPP.36.414V1010	10.1.0	02.05.2019	https://www.atis.org/docstore/
CCSA	CCSA TSD LTE 36.414	10.1.0	30.06.2011	http://www.ccsa.org.cn/ITU_spec/ITU-R/M.2012/M.2012-4/LTE/REL-10/CCSA-TSD-LTE-36414-a10.rar
ETSI	ETSI TS 136 414	10.1.0	30.06.2011	http://www.etsi.org/deliver/etsi_ts/136400_136499/136414/10.01.00_60/ts_136414v100100p.pdf
TSDSI	TSDSI STD T1.3GPP 36.414-10.1.0 V1.0.0	10.1.0	30.05.2019	https://members.tdsi.in/index.php/s/BxBT9C9F8KxobBg
TTA	TTAT.3G-36.414(R10-10.1.0)	10.1.0	26.08.2011	http://www.tta.or.kr/data/ttasDown.jsp?where=14688&pk_num=TTAT.3G-36.414(R10-10.1.0)
TTC	TS-3GA-36.414(Rel10)v10.1.0	10.1.0	31.08.2011	https://www.ttc.or.jp/st/docs/3gpps2011/TS/TS-3GA-36.414(Rel10)v10.1.0.pdf
Release 11				
ATIS	ATIS.3GPP.36.414V1100	11.0.0	02.05.2019	https://www.atis.org/docstore/
CCSA	CCSA TSD LTE 36.414	11.0.0	18.10.2012	http://www.ccsa.org.cn/ITU_spec/ITU-R/M.2012/M.2012-4/LTE/REL-11/CCSA-TSD-LTE-36414-b00.rar
ETSI	ETSI TS 136 414	11.0.0	18.10.2012	http://www.etsi.org/deliver/etsi_ts/136400_136499/136414/11.00.00_60/ts_136414v110000p.pdf
TSDSI	TSDSI STD T1.3GPP 36.414-11.0.0 V1.0.0	11.0.0	30.05.2019	https://members.tdsi.in/index.php/s/BxBT9C9F8KxobBg
TTA	TTAT.3G-36.414(R11-11.0.0)	11.0.0	26.08.2013	http://www.tta.or.kr/data/ttasDown.jsp?where=14688&pk_num=TTAT.3G-36.414(R11-11.0.0)
TTC	TS-3GA-36.414(Rel11)v11.0.0	11.0.0	25.06.2013	https://www.ttc.or.jp/st/docs/3gpps2013/TS/TS-3GA-36.414(Rel11)v11.0.0.pdf
Release 12				
ATIS	ATIS.3GPP.36.414V1210	12.1.0	02.05.2019	https://www.atis.org/docstore/
CCSA	CCSA TSD LTE 36.414	12.1.0	04.02.2015	http://www.ccsa.org.cn/ITU_spec/ITU-R/M.2012/M.2012-4/LTE/REL-12/CCSA-TSD-LTE-36414-c10.rar
ETSI	ETSI TS 136 414	12.1.0	04.02.2015	http://www.etsi.org/deliver/etsi_ts/136400_136499/136414/12.01.00_60/ts_136414v120100p.pdf
TSDSI	TSDSI STD T1.3GPP 36.414-12.1.0 V1.0.0	12.1.0	30.05.2019	https://members.tdsi.in/index.php/s/BxBT9C9F8KxobBg
TTA	TTAT.3G-36.414(R12-12.1.0)	12.1.0	09.04.2015	http://www.tta.or.kr/data/ttasDown.jsp?where=14688&pk_num=TTAT.3G-36.414(R12-12.1.0)
TTC	TS-3GA-36.414(Rel12)v12.1.0	12.1.0	05.03.2015	https://www.ttc.or.jp/st/docs/3gpps2015/TS/TS-3GA-36.414(Rel12)v12.1.0.pdf
Release 13				
ATIS	ATIS.3GPP.36.414V1300	13.0.0	02.05.2019	https://www.atis.org/docstore/
CCSA	CCSA TSD LTE 36.414	13.0.0	21.01.2016	http://www.ccsa.org.cn/ITU_spec/ITU-R/M.2012/M.2012-4/LTE/REL-13/CCSA-TSD-LTE-36414-d00.rar

48

ETSI	ETSI TS 136 414	13.0.0	21.01.2016	http://www.etsi.org/deliver/etsi_ts/136400_136499/136414/13.00.00_60/ts_136414v130000p.pdf
TSDSI	TSDSI STD T1.3GPP 36.414-13.0.0 V1.0.0	13.0.0	30.05.2019	https://members.tdsi.in/index.php/s/BxBT9C9F8KxobBg
TTA	TTAT.3G-36.414(R13-13.0.0)	13.0.0	06.07.2017	http://www.tta.or.kr/data/ttasDown.jsp?where=14688&pk_num=TTAT.3G-36.414(R13-13.0.0)
TTC	TS-3GA-36.414(Rel13)v13.0.0	13.0.0	31.03.2017	https://www.ttc.or.jp/st/docs/3gpps2017/TS/TS-3GA-36.414(Rel13)v13.0.0.pdf

Release 14

ATIS	ATIS.3GPP.36.414V1410	14.1.0	02.05.2019	https://www.atis.org/docstore/
CCSA	CCSA TSD LTE 36.414	14.1.0	11.01.2019	http://www.ccsa.org.cn/ITU_spec/ITU-R/M.2012/M.2012-4/LTE/REL-14/CCSA-TSD-LTE-36414-e10.zip
ETSI	ETSI TS 136 414	14.1.0	24.08.2017	http://www.etsi.org/deliver/etsi_ts/136400_136499/136414/14.01.00_60/ts_136414v140100p.pdf
TSDSI	TSDSI STD T1.3GPP 36.414-14.1.0 V1.0.0	14.1.0	30.05.2019	https://members.tdsi.in/index.php/s/BxBT9C9F8KxobBg
TTA	TTAT.3G-36.414(R14-14.1.0)	14.1.0	10.05.2018	http://www.tta.or.kr/data/ttasDown.jsp?where=14688&pk_num=TTAT.3G-36.414(R14-14.1.0)
TTC	TS-3GA-36.414(Rel14)v14.1.0	14.1.0	13.04.2018	https://www.ttc.or.jp/st/docs/3gpps2018/TS/TS-3GA-36.414(Rel14)v14.1.0.pdf

2.1.4.7 TS 36.420

Evolved Universal Terrestrial Radio Access Network (E-UTRAN); X2 general aspects and principles

This document is an introduction to the TSG RAN TS 36.42x series of UMTS technical specifications that define the X2 interface. It is an interface for the interconnection of two E-UTRAN NodeB (eNodeB) components within the Evolved Universal Terrestrial Radio Access Network (E-UTRAN) architecture.

SDO	Document No.	Version	Issued date	Location
Release 10				
ATIS	ATIS.3GPP.36.420V1020	10.2.0	02.05.2019	https://www.atis.org/docstore/
CCSA	CCSA TSD LTE 36.420	10.2.0	21.10.2011	http://www.ccsa.org.cn/ITU_spec/ITU-R/M.2012/M.2012-4/LTE/REL-10/CCSA-TSD-LTE-36420-a20.rar
ETSI	ETSI TS 136 420	10.2.0	21.10.2011	http://www.etsi.org/deliver/etsi_ts/136400_136499/136420/10.02.00_60/ts_136420v100200p.pdf
TSDSI	TSDSI STD T1.3GPP 36.420-10.2.0 V1.0.0	10.2.0	30.05.2019	https://members.tdsi.in/index.php/s/BxBT9C9F8KxobBg
TTA	TTAT.3G-36.420(R10-10.2.0)	10.2.0	06.07.2017	http://www.tta.or.kr/data/ttasDown.jsp?where=14688&pk_num=TTAT.3G-36.420(R10-10.2.0)
TTC	TS-3GA-36.420(Rel10)v10.2.0	10.2.0	21.12.2011	https://www.ttc.or.jp/st/docs/3gpps2011/TS/TS-3GA-36.420(Rel10)v10.2.0.pdf
Release 11				
ATIS	ATIS.3GPP.36.420V1100	11.0.0	02.05.2019	https://www.atis.org/docstore/
CCSA	CCSA TSD LTE 36.420	11.0.0	18.10.2012	http://www.ccsa.org.cn/ITU_spec/ITU-R/M.2012/M.2012-4/LTE/REL-11/CCSA-TSD-LTE-36420-b00.rar
ETSI	ETSI TS 136 420	11.0.0	18.10.2012	http://www.etsi.org/deliver/etsi_ts/136400_136499/136420/11.00.00_60/ts_136420v110000p.pdf
TSDSI	TSDSI STD T1.3GPP 36.420-11.0.0 V1.0.0	11.0.0	30.05.2019	https://members.tdsi.in/index.php/s/BxBT9C9F8KxobBg
TTA	TTAT.3G-36.420(R11-11.0.0)	11.0.0	26.08.2013	http://www.tta.or.kr/data/ttasDown.jsp?where=14688&pk_num=TTAT.3G-36.420(R11-11.0.0)
TTC	TS-3GA-36.420(Rel11)v11.0.0	11.0.0	25.06.2013	https://www.ttc.or.jp/st/docs/3gpps2013/TS/TS-3GA-36.420(Rel11)v11.0.0.pdf
Release 12				
ATIS	ATIS.3GPP.36.420V1210	12.1.0	02.05.2019	https://www.atis.org/docstore/
CCSA	CCSA TSD LTE 36.420	12.1.0	04.02.2015	http://www.ccsa.org.cn/ITU_spec/ITU-R/M.2012/M.2012-4/LTE/REL-12/CCSA-TSD-LTE-36420-c10.rar
ETSI	ETSI TS 136 420	12.1.0	04.02.2015	http://www.etsi.org/deliver/etsi_ts/136400_136499/136420/12.01.00_60/ts_136420v120100p.pdf
TSDSI	TSDSI STD T1.3GPP 36.420-12.1.0 V1.0.0	12.1.0	30.05.2019	https://members.tdsi.in/index.php/s/BxBT9C9F8KxobBg
TTA	TTAT.3G-36.420(R12-12.1.0)	12.1.0	09.04.2015	http://www.tta.or.kr/data/ttasDown.jsp?where=14688&pk_num=TTAT.3G-36.420(R12-12.1.0)
TTC	TS-3GA-36.420(Rel12)v12.1.0	12.1.0	05.03.2015	https://www.ttc.or.jp/st/docs/3gpps2015/TS/TS-3GA-36.420(Rel12)v12.1.0.pdf
Release 13				
ATIS	ATIS.3GPP.36.420V1300	13.0.0	02.05.2019	https://www.atis.org/docstore/

CCSA	CCSA TSD LTE 36.420	13.0.0	21.01.2016	http://www.ccsa.org.cn/ITU_spec/ITU-R/M.2012/M.2012-4/LTE/REL-13/CCSA-TSD-LTE-36420-d00.rar
ETSI	ETSI TS 136 420	13.0.0	21.01.2016	http://www.etsi.org/deliver/etsi_ts/136400_136499/136420/13.00.00_60/ts_136420v130000p.pdf
TSDSI	TSDSI STD T1.3GPP 36.420-13.0.0 V1.0.0	13.0.0	30.05.2019	https://members.tdsi.in/index.php/s/BxBT9C9F8KxobBg
TTA	TTAT.3G-36.420(R13-13.0.0)	13.0.0	06.07.2017	http://www.tta.or.kr/data/ttasDown.jsp?where=14688&pk_num=TTAT.3G-36.420(R13-13.0.0)
TTC	TS-3GA-36.420(Rel13)v13.0.0	13.0.0	31.03.2017	https://www.ttc.or.jp/st/docs/3gpps2017/TS/TS-3GA-36.420(Rel13)v13.0.0.pdf

Release 14

ATIS	ATIS.3GPP.36.420V1401	14.0.1	02.05.2019	https://www.atis.org/docstore/
CCSA	CCSA TSD LTE 36.420	14.0.1	11.01.2019	http://www.ccsa.org.cn/ITU_spec/ITU-R/M.2012/M.2012-4/LTE/REL-14/CCSA-TSD-LTE-36420-e01.zip
ETSI	ETSI TS 136 420	14.0.1	11.04.2017	http://www.etsi.org/deliver/etsi_ts/136400_136499/136420/14.00.01_60/ts_136420v140001p.pdf
TSDSI	TSDSI STD T1.3GPP 36.420-14.0.1 V1.0.0	14.0.1	30.05.2019	https://members.tdsi.in/index.php/s/BxBT9C9F8KxobBg
TTA	TTAT.3G-36.420(R14-14.0.1)	14.0.1	10.05.2018	http://www.tta.or.kr/data/ttasDown.jsp?where=14688&pk_num=TTAT.3G-36.420(R14-14.0.1)
TTC	TS-3GA-36.420(Rel14)v14.0.1	14.0.1	13.04.2018	https://www.ttc.or.jp/st/docs/3gpps2018/TS/TS-3GA-36.420(Rel14)v14.0.1.pdf

2.1.4.8 TS 36.421**Evolved Universal Terrestrial Radio Access Network (E-UTRAN); X2 layer 1**

This document specifies the standards allowed to implement Layer 1 on the X2 interface. The specification of transmission delay requirements and O & M requirements are not in the scope of this document. In the following “Layer 1” and “Physical Layer” are assumed to be synonymous.

SDO	Document No.	Version	Issued date	Location	
Release 10					
ATIS	ATIS.3GPP.36.421V1001		10.0.1	02.05.2019	https://www.atis.org/docstore/
CCSA	CCSA TSD LTE 36.421		10.0.1	16.05.2011	http://www.ccsa.org.cn/ITU_spec/ITU-R/M.2012/M.2012-4/LTE/REL-10/CCSA-TSD-LTE-36421-a01.rar
ETSI	ETSI TS 136 421		10.0.1	16.05.2011	http://www.etsi.org/deliver/etsi_ts/136400_136499/136421/10.00.01_60/ts_136421v100001p.pdf
TSDSI	TSDSI STD T1.3GPP 36.421-10.0.1 V1.0.0		10.0.1	30.05.2019	https://members.tdsi.in/index.php/s/BxBT9C9F8KxobBg
TTA	TTAT.3G-36.421(R10-10.0.1)		10.0.1	26.08.2011	http://www.tta.or.kr/data/ttasDown.jsp?where=14688&pk_num=TTAT.3G-36.421(R10-10.0.1)
TTC	TS-3GA-36.421(Rel10)v10.0.1		10.0.1	22.06.2011	https://www.ttc.or.jp/st/docs/3gpps2011/TS/TS-3GA-36.421(Rel10)v10.0.1.pdf
Release 11					
ATIS	ATIS.3GPP.36.421V1110		11.1.0	02.05.2019	https://www.atis.org/docstore/
CCSA	CCSA TSD LTE 36.421		11.1.0	16.01.2013	http://www.ccsa.org.cn/ITU_spec/ITU-R/M.2012/M.2012-4/LTE/REL-11/CCSA-TSD-LTE-36421-b10.rar
ETSI	ETSI TS 136 421		11.1.0	16.01.2013	http://www.etsi.org/deliver/etsi_ts/136400_136499/136421/11.01.00_60/ts_136421v110100p.pdf
TSDSI	TSDSI STD T1.3GPP 36.421-11.1.0 V1.0.0		11.1.0	30.05.2019	https://members.tdsi.in/index.php/s/BxBT9C9F8KxobBg
TTA	TTAT.3G-36.421(R11-11.1.0)		11.1.0	26.08.2013	http://www.tta.or.kr/data/ttasDown.jsp?where=14688&pk_num=TTAT.3G-36.421(R11-11.1.0)
TTC	TS-3GA-36.421(Rel11)v11.1.0		11.1.0	25.06.2013	https://www.ttc.or.jp/st/docs/3gpps2013/TS/TS-3GA-36.421(Rel11)v11.1.0.pdf
Release 12					
ATIS	ATIS.3GPP.36.421V1200		12.0.0	02.05.2019	https://www.atis.org/docstore/
CCSA	CCSA TSD LTE 36.421		12.0.0	25.09.2014	http://www.ccsa.org.cn/ITU_spec/ITU-R/M.2012/M.2012-4/LTE/REL-12/CCSA-TSD-LTE-36421-c00.rar
ETSI	ETSI TS 136 421		12.0.0	25.09.2014	http://www.etsi.org/deliver/etsi_ts/136400_136499/136421/12.00.00_60/ts_136421v120000p.pdf
TSDSI	TSDSI STD T1.3GPP 36.421-12.0.0 V1.0.0		12.0.0	30.05.2019	https://members.tdsi.in/index.php/s/BxBT9C9F8KxobBg
TTA	TTAT.3G-36.421(R12-12.0.0)		12.0.0	09.04.2015	http://www.tta.or.kr/data/ttasDown.jsp?where=14688&pk_num=TTAT.3G-36.421(R12-12.0.0)
TTC	TS-3GA-36.421(Rel12)v12.0.0		12.0.0	05.03.2015	https://www.ttc.or.jp/st/docs/3gpps2015/TS/TS-3GA-36.421(Rel12)v12.0.0.pdf
Release 13					
ATIS	ATIS.3GPP.36.421V1300		13.0.0	02.05.2019	https://www.atis.org/docstore/

50

CCSA	CCSA TSD LTE 36.421	13.0.0	21.01.2016	http://www.ccsa.org.cn/ITU_spec/ITU-R/M.2012/M.2012-4/LTE/REL-13/CCSA-TSD-LTE-36421-d00.rar
ETSI	ETSI TS 136 421	13.0.0	21.01.2016	http://www.etsi.org/deliver/etsi_ts/136400_136499/136421/13.00.00_60/ts_136421v130000p.pdf
TSDSI	TSDSI STD T1.3GPP 36.421-13.0.0 V1.0.0	13.0.0	30.05.2019	https://members.tdsi.in/index.php/s/BxBT9C9F8KxobBg
TTA	TTAT.3G-36.421(R13-13.0.0)	13.0.0	06.07.2017	http://www.tta.or.kr/data/ttasDown.jsp?where=14688&pk_num=TTAT.3G-36.421(R13-13.0.0)
TTC	TS-3GA-36.421(Rel13)v13.0.0	13.0.0	31.03.2017	https://www.ttc.or.jp/st/docs/3gpps2017/TS/TS-3GA-36.421(Rel13)v13.0.0.pdf

Release 14

ATIS	ATIS.3GPP.36.421V1400	14.0.0	02.05.2019	https://www.atis.org/docstore/
CCSA	CCSA TSD LTE 36.421	14.0.0	11.01.2019	http://www.ccsa.org.cn/ITU_spec/ITU-R/M.2012/M.2012-4/LTE/REL-14/CCSA-TSD-LTE-36421-e00.zip
ETSI	ETSI TS 136 421	14.0.0	11.04.2017	http://www.etsi.org/deliver/etsi_ts/136400_136499/136421/14.00.00_60/ts_136421v140000p.pdf
TSDSI	TSDSI STD T1.3GPP 36.421-14.0.0 V1.0.0	14.0.0	30.05.2019	https://members.tdsi.in/index.php/s/BxBT9C9F8KxobBg
TTA	TTAT.3G-36.421(R14-14.0.0)	14.0.0	10.05.2018	http://www.tta.or.kr/data/ttasDown.jsp?where=14688&pk_num=TTAT.3G-36.421(R14-14.0.0)
TTC	TS-3GA-36.421(Rel14)v14.0.0	14.0.0	13.04.2018	https://www.ttc.or.jp/st/docs/3gpps2018/TS/TS-3GA-36.421(Rel14)v14.0.0.pdf

2.1.4.9 TS 36.422

Evolved Universal Terrestrial Radio Access Network (E-UTRAN); X2 signalling transport

This document specifies the standards for Signalling Transport to be used across X2 interface. X2 interface is a logical interface between eNodeBs. This document describes how the X2-AP signalling messages are transported over X2.

SDO	Document No.	Version	Issued date	Location	
Release 10					
ATIS	ATIS.3GPP.36.422V1010		10.1.0	02.05.2019	https://www.atis.org/docstore/
CCSA	CCSA TSD LTE 36.422		10.1.0	30.06.2011	http://www.ccsa.org.cn/ITU_spec/ITU-R/M.2012/M.2012-4/LTE/REL-10/CCSA-TSD-LTE-36422-a10.rar
ETSI	ETSI TS 136 422		10.1.0	30.06.2011	http://www.etsi.org/deliver/etsi_ts/136400_136499/136422/10.01.00_60/ts_136422v100100p.pdf
TSDSI	TSDSI STD T1.3GPP 36.422-10.1.0 V1.0.0		10.1.0	30.05.2019	https://members.tdsi.in/index.php/s/BxBT9C9F8KxobBg
TTA	TTAT.3G-36.422(R10-10.1.0)		10.1.0	26.08.2011	http://www.tta.or.kr/data/ttasDown.jsp?where=14688&pk_num=TTAT.3G-36.422(R10-10.1.0)
TTC	TS-3GA-36.422(Rel10)v10.1.0		10.1.0	31.08.2011	https://www.ttc.or.jp/st/docs/3gpps2011/TS/TS-3GA-36.422(Rel10)v10.1.0.pdf
Release 11					
ATIS	ATIS.3GPP.36.422V1100		11.0.0	02.05.2019	https://www.atis.org/docstore/
CCSA	CCSA TSD LTE 36.422		11.0.0	18.10.2012	http://www.ccsa.org.cn/ITU_spec/ITU-R/M.2012/M.2012-4/LTE/REL-11/CCSA-TSD-LTE-36422-b00.rar
ETSI	ETSI TS 136 422		11.0.0	18.10.2012	http://www.etsi.org/deliver/etsi_ts/136400_136499/136422/11.00.00_60/ts_136422v110000p.pdf
TSDSI	TSDSI STD T1.3GPP 36.422-11.0.0 V1.0.0		11.0.0	30.05.2019	https://members.tdsi.in/index.php/s/BxBT9C9F8KxobBg
TTA	TTAT.3G-36.422(R11-11.0.0)		11.0.0	26.08.2013	http://www.tta.or.kr/data/ttasDown.jsp?where=14688&pk_num=TTAT.3G-36.422(R11-11.0.0)
TTC	TS-3GA-36.422(Rel11)v11.0.0		11.0.0	25.06.2013	https://www.ttc.or.jp/st/docs/3gpps2013/TS/TS-3GA-36.422(Rel11)v11.0.0.pdf
Release 12					
ATIS	ATIS.3GPP.36.422V1200		12.0.0	02.05.2019	https://www.atis.org/docstore/
CCSA	CCSA TSD LTE 36.422		12.0.0	25.09.2014	http://www.ccsa.org.cn/ITU_spec/ITU-R/M.2012/M.2012-4/LTE/REL-12/CCSA-TSD-LTE-36422-c00.rar
ETSI	ETSI TS 136 422		12.0.0	25.09.2014	http://www.etsi.org/deliver/etsi_ts/136400_136499/136422/12.00.00_60/ts_136422v120000p.pdf
TSDSI	TSDSI STD T1.3GPP 36.422-12.0.0 V1.0.0		12.0.0	30.05.2019	https://members.tdsi.in/index.php/s/BxBT9C9F8KxobBg
TTA	TTAT.3G-36.422(R12-12.0.0)		12.0.0	09.04.2015	http://www.tta.or.kr/data/ttasDown.jsp?where=14688&pk_num=TTAT.3G-36.422(R12-12.0.0)
TTC	TS-3GA-36.422(Rel12)v12.0.0		12.0.0	05.03.2015	https://www.ttc.or.jp/st/docs/3gpps2015/TS/TS-3GA-36.422(Rel12)v12.0.0.pdf
Release 13					
ATIS	ATIS.3GPP.36.422V1300		13.0.0	02.05.2019	https://www.atis.org/docstore/

CCSA	CCSA TSD LTE 36.422	13.0.0	21.01.2016	http://www.ccsa.org.cn/ITU_spec/ITU-R/M.2012/M.2012-4/LTE/REL-13/CCSA-TSD-LTE-36422-d00.rar
ETSI	ETSI TS 136 422	13.0.0	21.01.2016	http://www.etsi.org/deliver/etsi_ts/136400_136499/136422/13.00.00_60/ts_136422v130000p.pdf
TSDSI	TSDSI STD T1.3GPP 36.422-13.0.0 V1.0.0	13.0.0	30.05.2019	https://members.tdsi.in/index.php/s/BxBT9C9F8KxobBg
TTA	TTAT.3G-36.422(R13-13.0.0)	13.0.0	06.07.2017	http://www.tta.or.kr/data/ttasDown.jsp?where=14688&pk_num=TTAT.3G-36.422(R13-13.0.0)
TTC	TS-3GA-36.422(Rel13)v13.0.0	13.0.0	31.03.2017	https://www.ttc.or.jp/st/docs/3gpps2017/TS/TS-3GA-36.422(Rel13)v13.0.0.pdf

Release 14

ATIS	ATIS.3GPP.36.422V1400	14.0.0	02.05.2019	https://www.atis.org/docstore/
CCSA	CCSA TSD LTE 36.422	14.0.0	11.01.2019	http://www.ccsa.org.cn/ITU_spec/ITU-R/M.2012/M.2012-4/LTE/REL-14/CCSA-TSD-LTE-36422-e00.zip
ETSI	ETSI TS 136 422	14.0.0	11.04.2017	http://www.etsi.org/deliver/etsi_ts/136400_136499/136422/14.00.00_60/ts_136422v140000p.pdf
TSDSI	TSDSI STD T1.3GPP 36.422-14.0.0 V1.0.0	14.0.0	30.05.2019	https://members.tdsi.in/index.php/s/BxBT9C9F8KxobBg
TTA	TTAT.3G-36.422(R14-14.0.0)	14.0.0	10.05.2018	http://www.tta.or.kr/data/ttasDown.jsp?where=14688&pk_num=TTAT.3G-36.422(R14-14.0.0)
TTC	TS-3GA-36.422(Rel14)v14.0.0	14.0.0	13.04.2018	https://www.ttc.or.jp/st/docs/3gpps2018/TS/TS-3GA-36.422(Rel14)v14.0.0.pdf

2.1.4.10 TS 36.423**Evolved Universal Terrestrial Radio Access Network (E-UTRAN); X2 Application Protocol (X2AP)**

This document specifies the radio network layer signalling procedures of the control plane between eNodeBs in E-UTRAN. X2AP supports the functions of X2 interface by signalling procedures defined in this document.

SDO	Document No.	Version	Issued date	Location	
Release 10					
ATIS	ATIS.3GPP.36.423V1070		10.7.0	02.05.2019	https://www.atis.org/docstore/
CCSA	CCSA TSD LTE 36.423		10.7.0	26.09.2013	http://www.ccsa.org.cn/ITU_spec/ITU-R/M.2012/M.2012-4/LTE/REL-10/CCSA-TSD-LTE-36423-a70.rar
ETSI	ETSI TS 136 423		10.7.0	26.09.2013	http://www.etsi.org/deliver/etsi_ts/136400_136499/136423/10.07.00_60/ts_136423v100700p.pdf
TSDSI	TSDSI STD T1.3GPP 36.423-10.7.0 V1.0.0		10.7.0	30.05.2019	https://members.tdsi.in/index.php/s/BxBT9C9F8KxobBg
TTA	TTAT.3G-36.423(R10-10.7.0)		10.7.0	10.08.2016	http://www.tta.or.kr/data/ttasDown.jsp?where=14688&pk_num=TTAT.3G-36.423(R10-10.7.0)
TTC	TS-3GA-36.423(Rel10)v10.7.0		10.7.0	22.11.2013	https://www.ttc.or.jp/st/docs/3gpps2013/TS/TS-3GA-36.423(Rel10)v10.7.0.pdf
Release 11					
ATIS	ATIS.3GPP.36.423V1190		11.9.0	02.05.2019	https://www.atis.org/docstore/
CCSA	CCSA TSD LTE 36.423		11.9.0	14.04.2015	http://www.ccsa.org.cn/ITU_spec/ITU-R/M.2012/M.2012-4/LTE/REL-11/CCSA-TSD-LTE-36423-b90.rar
ETSI	ETSI TS 136 423		11.9.0	14.04.2015	http://www.etsi.org/deliver/etsi_ts/136400_136499/136423/11.09.00_60/ts_136423v110900p.pdf
TSDSI	TSDSI STD T1.3GPP 36.423-11.9.0 V1.0.0		11.9.0	30.05.2019	https://members.tdsi.in/index.php/s/BxBT9C9F8KxobBg
TTA	TTAT.3G-36.423(R11-11.9.0)		11.9.0	06.07.2017	http://www.tta.or.kr/data/ttasDown.jsp?where=14688&pk_num=TTAT.3G-36.423(R11-11.9.0)
TTC	TS-3GA-36.423(Rel11)v11.9.0		11.9.0	30.06.2015	https://www.ttc.or.jp/st/docs/3gpps2015/TS/TS-3GA-36.423(Rel11)v11.9.0.pdf
Release 12					
ATIS	ATIS.3GPP.36.423V1290		12.9.0	02.05.2019	https://www.atis.org/docstore/
CCSA	CCSA TSD LTE 36.423		12.9.0	25.08.2016	http://www.ccsa.org.cn/ITU_spec/ITU-R/M.2012/M.2012-4/LTE/REL-12/CCSA-TSD-LTE-36423-c90.rar
ETSI	ETSI TS 136 423		12.9.0	25.08.2016	http://www.etsi.org/deliver/etsi_ts/136400_136499/136423/12.09.00_60/ts_136423v120900p.pdf
TSDSI	TSDSI STD T1.3GPP 36.423-12.9.0 V1.0.0		12.9.0	30.05.2019	https://members.tdsi.in/index.php/s/BxBT9C9F8KxobBg
TTA	TTAT.3G-36.423(R12-12.9.0)		12.9.0	06.07.2017	http://www.tta.or.kr/data/ttasDown.jsp?where=14688&pk_num=TTAT.3G-36.423(R12-12.9.0)
TTC	TS-3GA-36.423(Rel12)v12.9.0		12.9.0	31.03.2017	https://www.ttc.or.jp/st/docs/3gpps2017/TS/TS-3GA-36.423(Rel12)v12.9.0.pdf
Release 13					
ATIS	ATIS.3GPP.36.423V1370		13.7.0	02.05.2019	https://www.atis.org/docstore/

52

CCSA	CCSA TSD LTE 36.423	13.7.0	24.08.2017	http://www.ccsa.org.cn/ITU_spec/ITU-R/M.2012/M.2012-4/LTE/REL-13/CCSA-TSD-LTE-36423-d70.rar
ETSI	ETSI TS 136 423	13.7.0	24.08.2017	http://www.etsi.org/deliver/etsi_ts/136400_136499/136423/13.07.00_60/ts_136423v130700p.pdf
TSDSI	TSDSI STD T1.3GPP 36.423-13.7.0 V1.0.0	13.7.0	30.05.2019	https://members.tdsi.in/index.php/s/BxBT9C9F8KxobBg
TTA	TTAT.3G-36.423(R13-13.7.0)	13.7.0	10.05.2018	http://www.tta.or.kr/data/ttasDown.jsp?where=14688&pk_num=TTAT.3G-36.423(R13-13.7.0)
TTC	TS-3GA-36.423(Rel13)v13.7.0	13.7.0	22.09.2017	https://www.ttc.or.jp/st/docs/3gpps2017/TS/TS-3GA-36.423(Rel13)v13.7.0.pdf

Release 14

ATIS	ATIS.3GPP.36.423V1450	14.5.0	02.05.2019	https://www.atis.org/docstore/
CCSA	CCSA TSD LTE 36.423	14.5.0	11.01.2019	http://www.ccsa.org.cn/ITU_spec/ITU-R/M.2012/M.2012-4/LTE/REL-14/CCSA-TSD-LTE-36423-e50.zip
ETSI	ETSI TS 136 423	14.5.0	25.01.2018	http://www.etsi.org/deliver/etsi_ts/136400_136499/136423/14.05.00_60/ts_136423v140500p.pdf
TSDSI	TSDSI STD T1.3GPP 36.423-14.5.0 V1.0.0	14.5.0	30.05.2019	https://members.tdsi.in/index.php/s/BxBT9C9F8KxobBg
TTA	TTAT.3G-36.423(R14-14.5.0)	14.5.0	09.05.2019	http://www.tta.or.kr/data/ttasDown.jsp?where=14688&pk_num=TTAT.3G-36.423(R14-14.5.0)
TTC	TS-3GA-36.423(Rel14)v14.5.0	14.5.0	13.04.2018	https://www.ttc.or.jp/st/docs/3gpps2018/TS/TS-3GA-36.423(Rel14)v14.5.0.pdf

2.1.4.11 TS 36.424

Evolved Universal Terrestrial Radio Access Network (E-UTRAN); X2 data transport

This document specifies the standards for user data transport protocols and related signalling protocols to establish user plane transport bearers over the X2 interface.

SDO	Document No.	Version	Issued date	Location	
Release 10					
ATIS	ATIS.3GPP.36.424V1010		10.1.0	02.05.2019	https://www.atis.org/docstore/
CCSA	CCSA TSD LTE 36.424		10.1.0	30.06.2011	http://www.ccsa.org.cn/ITU_spec/ITU-R/M.2012/M.2012-4/LTE/REL-10/CCSA-TSD-LTE-36424-a10.rar
ETSI	ETSI TS 136 424		10.1.0	30.06.2011	http://www.etsi.org/deliver/etsi_ts/136400_136499/136424/10.01.00_60/ts_136424v100100p.pdf
TSDSI	TSDSI STD T1.3GPP 36.424-10.1.0 V1.0.0		10.1.0	30.05.2019	https://members.tdsi.in/index.php/s/BxBT9C9F8KxobBg
TTA	TTAT.3G-36.424(R10-10.1.0)		10.1.0	26.08.2011	http://www.tta.or.kr/data/ttasDown.jsp?where=14688&pk_num=TTAT.3G-36.424(R10-10.1.0)
TTC	TS-3GA-36.424(Rel10)v10.1.0		10.1.0	31.08.2011	https://www.ttc.or.jp/st/docs/3gpps2011/TS/TS-3GA-36.424(Rel10)v10.1.0.pdf
Release 11					
ATIS	ATIS.3GPP.36.424V1100		11.0.0	02.05.2019	https://www.atis.org/docstore/
CCSA	CCSA TSD LTE 36.424		11.0.0	18.10.2012	http://www.ccsa.org.cn/ITU_spec/ITU-R/M.2012/M.2012-4/LTE/REL-11/CCSA-TSD-LTE-36424-b00.rar
ETSI	ETSI TS 136 424		11.0.0	18.10.2012	http://www.etsi.org/deliver/etsi_ts/136400_136499/136424/11.00.00_60/ts_136424v110000p.pdf
TSDSI	TSDSI STD T1.3GPP 36.424-11.0.0 V1.0.0		11.0.0	30.05.2019	https://members.tdsi.in/index.php/s/BxBT9C9F8KxobBg
TTA	TTAT.3G-36.424(R11-11.0.0)		11.0.0	26.08.2013	http://www.tta.or.kr/data/ttasDown.jsp?where=14688&pk_num=TTAT.3G-36.424(R11-11.0.0)
TTC	TS-3GA-36.424(Rel11)v11.0.0		11.0.0	25.06.2013	https://www.ttc.or.jp/st/docs/3gpps2013/TS/TS-3GA-36.424(Rel11)v11.0.0.pdf
Release 12					
ATIS	ATIS.3GPP.36.424V1220		12.2.0	02.05.2019	https://www.atis.org/docstore/
CCSA	CCSA TSD LTE 36.424		12.2.0	15.04.2015	http://www.ccsa.org.cn/ITU_spec/ITU-R/M.2012/M.2012-4/LTE/REL-12/CCSA-TSD-LTE-36424-c20.rar
ETSI	ETSI TS 136 424		12.2.0	15.04.2015	http://www.etsi.org/deliver/etsi_ts/136400_136499/136424/12.02.00_60/ts_136424v120200p.pdf
TSDSI	TSDSI STD T1.3GPP 36.424-12.2.0 V1.0.0		12.2.0	30.05.2019	https://members.tdsi.in/index.php/s/BxBT9C9F8KxobBg
TTA	TTAT.3G-36.424(R12-12.2.0)		12.2.0	06.07.2017	http://www.tta.or.kr/data/ttasDown.jsp?where=14688&pk_num=TTAT.3G-36.424(R12-12.2.0)
TTC	TS-3GA-36.424(Rel12)v12.2.0		12.2.0	30.06.2015	https://www.ttc.or.jp/st/docs/3gpps2015/TS/TS-3GA-36.424(Rel12)v12.2.0.pdf
Release 13					
ATIS	ATIS.3GPP.36.424V1310		13.1.0	02.05.2019	https://www.atis.org/docstore/

CCSA	CCSA TSD LTE 36.424	13.1.0	20.05.2016	http://www.ccsa.org.cn/ITU_spec/ITU-R/M.2012/M.2012-4/LTE/REL-13/CCSA-TSD-LTE-36424-d10.rar
ETSI	ETSI TS 136 424	13.1.0	20.05.2016	http://www.etsi.org/deliver/etsi_ts/136400_136499/136424/13.01.00_60/ts_136424v130100p.pdf
TSDSI	TSDSI STD T1.3GPP 36.424-13.1.0 V1.0.0	13.1.0	30.05.2019	https://members.tdsi.in/index.php/s/BxBT9C9F8KxobBg
TTA	TTAT.3G-36.424(R13-13.1.0)	13.1.0	06.07.2017	http://www.tta.or.kr/data/ttasDown.jsp?where=14688&pk_num=TTAT.3G-36.424(R13-13.1.0)
TTC	TS-3GA-36.424(Rel13)v13.1.0	13.1.0	31.03.2017	https://www.ttc.or.jp/st/docs/3gpps2017/TS/TS-3GA-36.424(Rel13)v13.1.0.pdf

Release 14

ATIS	ATIS.3GPP.36.424V1410	14.1.0	02.05.2019	https://www.atis.org/docstore/
CCSA	CCSA TSD LTE 36.424	14.1.0	11.01.2019	http://www.ccsa.org.cn/ITU_spec/ITU-R/M.2012/M.2012-4/LTE/REL-14/CCSA-TSD-LTE-36424-e10.zip
ETSI	ETSI TS 136 424	14.1.0	24.08.2017	http://www.etsi.org/deliver/etsi_ts/136400_136499/136424/14.01.00_60/ts_136424v140100p.pdf
TSDSI	TSDSI STD T1.3GPP 36.424-14.1.0 V1.0.0	14.1.0	30.05.2019	https://members.tdsi.in/index.php/s/BxBT9C9F8KxobBg
TTA	TTAT.3G-36.424(R14-14.1.0)	14.1.0	10.05.2018	http://www.tta.or.kr/data/ttasDown.jsp?where=14688&pk_num=TTAT.3G-36.424(R14-14.1.0)
TTC	TS-3GA-36.424(Rel14)v14.1.0	14.1.0	13.04.2018	https://www.ttc.or.jp/st/docs/3gpps2018/TS/TS-3GA-36.424(Rel14)v14.1.0.pdf

2.1.4.12 TS 36.425**Evolved Universal Terrestrial Radio Access Network (E-UTRAN); X2 interface user plane protocol**

This document specifies the X2 user plane protocol being used over the X2 interface.

SDO	Document No.	Version	Issued date	Location	
Release 12					
ATIS	ATIS.3GPP.36.425V1210		12.1.0	02.05.2019	https://www.atis.org/docstore/
CCSA	CCSA TSD LTE 36.425		12.1.0	15.04.2015	http://www.ccsa.org.cn/ITU_spec/ITU-R/M.2012/M.2012-4/LTE/REL-12/CCSA-TSD-LTE-36425-c10.rar
ETSI	ETSI TS 136 425		12.1.0	15.04.2015	http://www.etsi.org/deliver/etsi_ts/136400_136499/136425/12.01.00_60/ts_136425v120100p.pdf
TSDSI	TSDSI STD T1.3GPP 36.425-12.1.0 V1.0.0		12.1.0	30.05.2019	https://members.tdsi.in/index.php/s/BxBT9C9F8KxobBg
TTA	TTAT.3G-36.425(R12-12.1.0)		12.1.0	06.07.2017	http://www.tta.or.kr/data/ttasDown.jsp?where=14688&pk_num=TTAT.3G-36.425(R12-12.1.0)
TTC	TS-3GA-36.425(Rel12)v12.1.0		12.1.0	30.06.2015	https://www.ttc.or.jp/st/docs/3gpps2015/TS/TS-3GA-36.425(Rel12)v12.1.0.pdf
Release 13					
ATIS	ATIS.3GPP.36.425V1311		13.1.1	02.05.2019	https://www.atis.org/docstore/
CCSA	CCSA TSD LTE 36.425		13.1.1	06.10.2016	http://www.ccsa.org.cn/ITU_spec/ITU-R/M.2012/M.2012-4/LTE/REL-13/CCSA-TSD-LTE-36425-d11.rar
ETSI	ETSI TS 136 425		13.1.1	06.10.2016	http://www.etsi.org/deliver/etsi_ts/136400_136499/136425/13.01.01_60/ts_136425v130101p.pdf
TSDSI	TSDSI STD T1.3GPP 36.425-13.1.1 V1.0.0		13.1.1	30.05.2019	https://members.tdsi.in/index.php/s/BxBT9C9F8KxobBg
TTA	TTAT.3G-36.425(R13-13.1.1)		13.1.1	06.07.2017	http://www.tta.or.kr/data/ttasDown.jsp?where=14688&pk_num=TTAT.3G-36.425(R13-13.1.1)
TTC	TS-3GA-36.425(Rel13)v13.1.1		13.1.1	31.03.2017	https://www.ttc.or.jp/st/docs/3gpps2017/TS/TS-3GA-36.425(Rel13)v13.1.1.pdf
Release 14					
ATIS	ATIS.3GPP.36.425V1400		14.0.0	02.05.2019	https://www.atis.org/docstore/
CCSA	CCSA TSD LTE 36.425		14.0.0	11.01.2019	http://www.ccsa.org.cn/ITU_spec/ITU-R/M.2012/M.2012-4/LTE/REL-14/CCSA-TSD-LTE-36425-e00.zip
ETSI	ETSI TS 136 425		14.0.0	11.04.2017	http://www.etsi.org/deliver/etsi_ts/136400_136499/136425/14.00.00_60/ts_136425v140000p.pdf
TSDSI	TSDSI STD T1.3GPP 36.425-14.0.0 V1.0.0		14.0.0	30.05.2019	https://members.tdsi.in/index.php/s/BxBT9C9F8KxobBg
TTA	TTAT.3G-36.425(R14-14.0.0)		14.0.0	10.05.2018	http://www.tta.or.kr/data/ttasDown.jsp?where=14688&pk_num=TTAT.3G-36.425(R14-14.0.0)
TTC	TS-3GA-36.425(Rel14)v14.0.0		14.0.0	13.04.2018	https://www.ttc.or.jp/st/docs/3gpps2018/TS/TS-3GA-36.425(Rel14)v14.0.0.pdf

2.1.4.13 TS 36.440

Evolved Universal Terrestrial Radio Access Network (E-UTRAN); General aspects and principles for interfaces supporting Multimedia Broadcast Multicast Service (MBMS) within E-UTRAN

This document describes the overall architecture of the interface for the provision of MBMS in the E-UTRAN. This includes also a description of the general aspects, assumptions and principles guiding the architecture and interface. The MBMS functions to be provided within that architecture are summarized. It provides an introduction to the TSG RAN TS 36.44x series of UMTS technical specifications that define the different interfaces introduced for MBMS provision in E-UTRAN.

SDO	Document No. Version	Issued date	Location
Release 10			
ATIS	ATIS.3GPP.36.440V1030	10.3.0 02.05.2019	https://www.atis.org/docstore/
CCSA	CCSA TSD LTE 36.440	10.3.0 20.07.2012	http://www.ccsa.org.cn/ITU_spec/ITU-R/M.2012/M.2012-4/LTE/REL-10/CCSA-TSD-LTE-36440-a30.rar
ETSI	ETSI TS 136 440	10.3.0 20.07.2012	http://www.etsi.org/deliver/etsi_ts/136400_136499/136440/10.03.00_60/ts_136440v100300p.pdf
TSDSI	TSDSI STD T1.3GPP 36.440-10.3.0 V1.0.0	10.3.0 30.05.2019	https://members.tdsi.in/index.php/s/BxBT9C9F8KxobBg
TTA	TTAT.3G-36.440(R10-10.3.0)	10.3.0 10.08.2016	http://www.tta.or.kr/data/ttasDown.jsp?where=14688&pk_num=TTAT.3G-36.440(R10-10.3.0)
TTC	TS-3GA-36.440(Rel10)v10.3.0	10.3.0 19.09.2012	https://www.ttc.or.jp/st/docs/3gpps2012/TS/TS-3GA-36.440(Rel10)v10.3.0.pdf
Release 11			
ATIS	ATIS.3GPP.36.440V1120	11.2.0 02.05.2019	https://www.atis.org/docstore/
CCSA	CCSA TSD LTE 36.440	11.2.0 22.04.2013	http://www.ccsa.org.cn/ITU_spec/ITU-R/M.2012/M.2012-4/LTE/REL-11/CCSA-TSD-LTE-36440-b20.rar
ETSI	ETSI TS 136 440	11.2.0 22.04.2013	http://www.etsi.org/deliver/etsi_ts/136400_136499/136440/11.02.00_60/ts_136440v110200p.pdf
TSDSI	TSDSI STD T1.3GPP 36.440-11.2.0 V1.0.0	11.2.0 30.05.2019	https://members.tdsi.in/index.php/s/BxBT9C9F8KxobBg
TTA	TTAT.3G-36.440(R11-11.2.0)	11.2.0 26.08.2013	http://www.tta.or.kr/data/ttasDown.jsp?where=14688&pk_num=TTAT.3G-36.440(R11-11.2.0)
TTC	TS-3GA-36.440(Rel11)v11.2.0	11.2.0 25.06.2013	https://www.ttc.or.jp/st/docs/3gpps2013/TS/TS-3GA-36.440(Rel11)v11.2.0.pdf
Release 12			
ATIS	ATIS.3GPP.36.440V1200	12.0.0 02.05.2019	https://www.atis.org/docstore/
CCSA	CCSA TSD LTE 36.440	12.0.0 26.09.2014	http://www.ccsa.org.cn/ITU_spec/ITU-R/M.2012/M.2012-4/LTE/REL-12/CCSA-TSD-LTE-36440-c00.rar
ETSI	ETSI TS 136 440	12.0.0 26.09.2014	http://www.etsi.org/deliver/etsi_ts/136400_136499/136440/12.00.00_60/ts_136440v120000p.pdf
TSDSI	TSDSI STD T1.3GPP 36.440-12.0.0 V1.0.0	12.0.0 30.05.2019	https://members.tdsi.in/index.php/s/BxBT9C9F8KxobBg
TTA	TTAT.3G-36.440(R12-12.0.0)	12.0.0 09.04.2015	http://www.tta.or.kr/data/ttasDown.jsp?where=14688&pk_num=TTAT.3G-36.440(R12-12.0.0)
TTC	TS-3GA-36.440(Rel12)v12.0.0	12.0.0 05.03.2015	https://www.ttc.or.jp/st/docs/3gpps2015/TS/TS-3GA-36.440(Rel12)v12.0.0.pdf
Release 13			
ATIS	ATIS.3GPP.36.440V1300	13.0.0 02.05.2019	https://www.atis.org/docstore/
CCSA	CCSA TSD LTE 36.440	13.0.0 21.01.2016	http://www.ccsa.org.cn/ITU_spec/ITU-R/M.2012/M.2012-4/LTE/REL-13/CCSA-TSD-LTE-36440-d00.rar
ETSI	ETSI TS 136 440	13.0.0 21.01.2016	http://www.etsi.org/deliver/etsi_ts/136400_136499/136440/13.00.00_60/ts_136440v130000p.pdf
TSDSI	TSDSI STD T1.3GPP 36.440-13.0.0 V1.0.0	13.0.0 30.05.2019	https://members.tdsi.in/index.php/s/BxBT9C9F8KxobBg
TTA	TTAT.3G-36.440(R13-13.0.0)	13.0.0 06.07.2017	http://www.tta.or.kr/data/ttasDown.jsp?where=14688&pk_num=TTAT.3G-36.440(R13-13.0.0)
TTC	TS-3GA-36.440(Rel13)v13.0.0	13.0.0 31.03.2017	https://www.ttc.or.jp/st/docs/3gpps2017/TS/TS-3GA-36.440(Rel13)v13.0.0.pdf
Release 14			
ATIS	ATIS.3GPP.36.440V1400	14.0.0 02.05.2019	https://www.atis.org/docstore/
CCSA	CCSA TSD LTE 36.440	14.0.0 11.01.2019	http://www.ccsa.org.cn/ITU_spec/ITU-R/M.2012/M.2012-4/LTE/REL-14/CCSA-TSD-LTE-36440-e00.zip
ETSI	ETSI TS 136 440	14.0.0 11.04.2017	http://www.etsi.org/deliver/etsi_ts/136400_136499/136440/14.00.00_60/ts_136440v140000p.pdf

TSDSI	TSDSI STD T1.3GPP 36.440-14.0.0 V1.0.0	14.0.0	30.05.2019	https://members.tdsi.in/index.php/s/BxBT9C9F8KxobBg
TTA	TTAT.3G-36.440(R14-14.0.0)	14.0.0	10.05.2018	http://www.tta.or.kr/data/ttasDown.jsp?where=14688&pk_num=TTAT.3G-36.440(R14-14.0.0)
TTC	TS-3GA-36.440(Rel14)v14.0.0	14.0.0	13.04.2018	https://www.ttc.or.jp/st/docs/3gpps2018/TS/TS-3GA-36.440(Rel14)v14.0.0.pdf

2.1.4.14 TS 36.441

Evolved Universal Terrestrial Radio Access Network (E-UTRAN); Layer 1 for interfaces supporting Multimedia Broadcast Multicast Service (MBMS) within E-UTRAN

This document specifies the standards allowed to implement layer 1 on the interfaces supporting Multimedia Broadcast Multicast Service (MBMS) within E-UTRAN. In the following, “layer 1” and “physical layer” are assumed to be synonymous.

SDO	Document No.	Version	Issued date	Location
Release 10				
ATIS	ATIS.3GPP.36.441V1010		10.1.0	02.05.2019 https://www.atis.org/docstore/
CCSA	CCSA TSD LTE 36.441		10.1.0	30.06.2011 http://www.ccsa.org.cn/ITU_spec/ITU-R/M.2012/M.2012-4/LTE/REL-10/CCSA-TSD-LTE-36441-a10.rar
ETSI	ETSI TS 136 441		10.1.0	30.06.2011 http://www.etsi.org/deliver/etsi_ts/136400_136499/136441/10.01.00_60/ts_136441v100100p.pdf
TSDSI	TSDSI STD T1.3GPP 36.441-10.1.0 V1.0.0		10.1.0	30.05.2019 https://members.tdsi.in/index.php/s/BxBT9C9F8KxobBg
TTA	TTAT.3G-36.441(R10-10.1.0)		10.1.0	26.08.2011 http://www.tta.or.kr/data/ttasDown.jsp?where=14688&pk_num=TTAT.3G-36.441(R10-10.1.0)
TTC	TS-3GA-36.441(Rel10)v10.1.0		10.1.0	31.08.2011 https://www.ttc.or.jp/st/docs/3gpps2011/TS/TS-3GA-36.441(Rel10)v10.1.0.pdf
Release 11				
ATIS	ATIS.3GPP.36.441V1100		11.0.0	02.05.2019 https://www.atis.org/docstore/
CCSA	CCSA TSD LTE 36.441		11.0.0	18.10.2012 http://www.ccsa.org.cn/ITU_spec/ITU-R/M.2012/M.2012-4/LTE/REL-11/CCSA-TSD-LTE-36441-b00.rar
ETSI	ETSI TS 136 441		11.0.0	18.10.2012 http://www.etsi.org/deliver/etsi_ts/136400_136499/136441/11.00.00_60/ts_136441v110000p.pdf
TSDSI	TSDSI STD T1.3GPP 36.441-11.0.0 V1.0.0		11.0.0	30.05.2019 https://members.tdsi.in/index.php/s/BxBT9C9F8KxobBg
TTA	TTAT.3G-36.441(R11-11.0.0)		11.0.0	26.08.2013 http://www.tta.or.kr/data/ttasDown.jsp?where=14688&pk_num=TTAT.3G-36.441(R11-11.0.0)
TTC	TS-3GA-36.441(Rel11)v11.0.0		11.0.0	25.06.2013 https://www.ttc.or.jp/st/docs/3gpps2013/TS/TS-3GA-36.441(Rel11)v11.0.0.pdf
Release 12				
ATIS	ATIS.3GPP.36.441V1200		12.0.0	02.05.2019 https://www.atis.org/docstore/
CCSA	CCSA TSD LTE 36.441		12.0.0	26.09.2014 http://www.ccsa.org.cn/ITU_spec/ITU-R/M.2012/M.2012-4/LTE/REL-12/CCSA-TSD-LTE-36441-c00.rar
ETSI	ETSI TS 136 441		12.0.0	26.09.2014 http://www.etsi.org/deliver/etsi_ts/136400_136499/136441/12.00.00_60/ts_136441v120000p.pdf
TSDSI	TSDSI STD T1.3GPP 36.441-12.0.0 V1.0.0		12.0.0	30.05.2019 https://members.tdsi.in/index.php/s/BxBT9C9F8KxobBg
TTA	TTAT.3G-36.441(R12-12.0.0)		12.0.0	09.04.2015 http://www.tta.or.kr/data/ttasDown.jsp?where=14688&pk_num=TTAT.3G-36.441(R12-12.0.0)
TTC	TS-3GA-36.441(Rel12)v12.0.0		12.0.0	05.03.2015 https://www.ttc.or.jp/st/docs/3gpps2015/TS/TS-3GA-36.441(Rel12)v12.0.0.pdf
Release 13				
ATIS	ATIS.3GPP.36.441V1300		13.0.0	02.05.2019 https://www.atis.org/docstore/
CCSA	CCSA TSD LTE 36.441		13.0.0	21.01.2016 http://www.ccsa.org.cn/ITU_spec/ITU-R/M.2012/M.2012-4/LTE/REL-13/CCSA-TSD-LTE-36441-d00.rar
ETSI	ETSI TS 136 441		13.0.0	21.01.2016 http://www.etsi.org/deliver/etsi_ts/136400_136499/136441/13.00.00_60/ts_136441v130000p.pdf
TSDSI	TSDSI STD T1.3GPP 36.441-13.0.0 V1.0.0		13.0.0	30.05.2019 https://members.tdsi.in/index.php/s/BxBT9C9F8KxobBg
TTA	TTAT.3G-36.441(R13-13.0.0)		13.0.0	06.07.2017 http://www.tta.or.kr/data/ttasDown.jsp?where=14688&pk_num=TTAT.3G-36.441(R13-13.0.0)
TTC	TS-3GA-36.441(Rel13)v13.0.0		13.0.0	31.03.2017 https://www.ttc.or.jp/st/docs/3gpps2017/TS/TS-3GA-36.441(Rel13)v13.0.0.pdf
Release 14				
ATIS	ATIS.3GPP.36.441V1400		14.0.0	02.05.2019 https://www.atis.org/docstore/
CCSA	CCSA TSD LTE 36.441		14.0.0	11.01.2019 http://www.ccsa.org.cn/ITU_spec/ITU-R/M.2012/M.2012-4/LTE/REL-14/CCSA-TSD-LTE-36441-e00.zip

ETSI	ETSI TS 136 441	14.0.0	11.04.2017	http://www.etsi.org/deliver/etsi_ts/136400_136499/136441/14.00.00_60/ts_136441v140000p.pdf
TSDSI	TSDSI STD T1.3GPP 36.441-14.0.0 V1.0.0	14.0.0	30.05.2019	https://members.tdsi.in/index.php/s/BxBT9C9F8KxobBg
TTA	TTAT.3G-36.441(R14-14.0.0)	14.0.0	10.05.2018	http://www.tta.or.kr/data/ttasDown.jsp?where=14688&pk_num=TTAT.3G-36.441(R14-14.0.0)
TTC	TS-3GA-36.441(Rel14)v14.0.0	14.0.0	13.04.2018	https://www.ttc.or.jp/st/docs/3gpps2018/TS/TS-3GA-36.441(Rel14)v14.0.0.pdf

2.1.4.15 TS 36.442

Evolved Universal Terrestrial Radio Access Network (E-UTRAN); Signalling Transport for interfaces supporting Multimedia Broadcast Multicast Service (MBMS) within E-UTRAN

This document specifies the standards for signalling transport to be used across M2 and M3 interfaces. M2 interface is a logical interface between the eNodeB and the MCE. M3 interface is a logical interface between the MCE and the MME. This document describes how the M2-AP signalling messages are transported over M2, and how the M3-AP signalling messages are transported over M3.

SDO	Document No.	Version	Issued date	Location
Release 10				
ATIS	ATIS.3GPP.36.442V1020		10.2.0	02.05.2019 https://www.atis.org/docstore/
CCSA	CCSA TSD LTE 36.442		10.2.0	21.10.2011 http://www.ccsa.org.cn/ITU_spec/ITU-R/M.2012/M.2012-4/LTE/REL-10/CCSA-TSD-LTE-36442-a20.rar
ETSI	ETSI TS 136 442		10.2.0	21.10.2011 http://www.etsi.org/deliver/etsi_ts/136400_136499/136442/10.02.00_60/ts_136442v100200p.pdf
TSDSI	TSDSI STD T1.3GPP 36.442-10.2.0 V1.0.0		10.2.0	30.05.2019 https://members.tdsi.in/index.php/s/BxBT9C9F8KxobBg
TTA	TTAT.3G-36.442(R10-10.2.0)		10.2.0	22.08.2012 http://www.tta.or.kr/data/ttasDown.jsp?where=14688&pk_num=TTAT.3G-36.442(R10-10.2.0)
TTC	TS-3GA-36.442(Rel10)v10.2.0		10.2.0	21.12.2011 https://www.ttc.or.jp/st/docs/3gpps2011/TS/TS-3GA-36.442(Rel10)v10.2.0.pdf
Release 11				
ATIS	ATIS.3GPP.36.442V1100		11.0.0	02.05.2019 https://www.atis.org/docstore/
CCSA	CCSA TSD LTE 36.442		11.0.0	18.10.2012 http://www.ccsa.org.cn/ITU_spec/ITU-R/M.2012/M.2012-4/LTE/REL-11/CCSA-TSD-LTE-36442-b00.rar
ETSI	ETSI TS 136 442		11.0.0	18.10.2012 http://www.etsi.org/deliver/etsi_ts/136400_136499/136442/11.00.00_60/ts_136442v110000p.pdf
TSDSI	TSDSI STD T1.3GPP 36.442-11.0.0 V1.0.0		11.0.0	30.05.2019 https://members.tdsi.in/index.php/s/BxBT9C9F8KxobBg
TTA	TTAT.3G-36.442(R11-11.0.0)		11.0.0	26.08.2013 http://www.tta.or.kr/data/ttasDown.jsp?where=14688&pk_num=TTAT.3G-36.442(R11-11.0.0)
TTC	TS-3GA-36.442(Rel11)v11.0.0		11.0.0	25.06.2013 https://www.ttc.or.jp/st/docs/3gpps2013/TS/TS-3GA-36.442(Rel11)v11.0.0.pdf
Release 12				
ATIS	ATIS.3GPP.36.442V1200		12.0.0	02.05.2019 https://www.atis.org/docstore/
CCSA	CCSA TSD LTE 36.442		12.0.0	26.09.2014 http://www.ccsa.org.cn/ITU_spec/ITU-R/M.2012/M.2012-4/LTE/REL-12/CCSA-TSD-LTE-36442-c00.rar
ETSI	ETSI TS 136 442		12.0.0	26.09.2014 http://www.etsi.org/deliver/etsi_ts/136400_136499/136442/12.00.00_60/ts_136442v120000p.pdf
TSDSI	TSDSI STD T1.3GPP 36.442-12.0.0 V1.0.0		12.0.0	30.05.2019 https://members.tdsi.in/index.php/s/BxBT9C9F8KxobBg
TTA	TTAT.3G-36.442(R12-12.0.0)		12.0.0	09.04.2015 http://www.tta.or.kr/data/ttasDown.jsp?where=14688&pk_num=TTAT.3G-36.442(R12-12.0.0)
TTC	TS-3GA-36.442(Rel12)v12.0.0		12.0.0	05.03.2015 https://www.ttc.or.jp/st/docs/3gpps2015/TS/TS-3GA-36.442(Rel12)v12.0.0.pdf
Release 13				
ATIS	ATIS.3GPP.36.442V1300		13.0.0	02.05.2019 https://www.atis.org/docstore/
CCSA	CCSA TSD LTE 36.442		13.0.0	21.01.2016 http://www.ccsa.org.cn/ITU_spec/ITU-R/M.2012/M.2012-4/LTE/REL-13/CCSA-TSD-LTE-36442-d00.rar
ETSI	ETSI TS 136 442		13.0.0	21.01.2016 http://www.etsi.org/deliver/etsi_ts/136400_136499/136442/13.00.00_60/ts_136442v130000p.pdf
TSDSI	TSDSI STD T1.3GPP 36.442-13.0.0 V1.0.0		13.0.0	30.05.2019 https://members.tdsi.in/index.php/s/BxBT9C9F8KxobBg
TTA	TTAT.3G-36.442(R13-13.0.0)		13.0.0	06.07.2017 http://www.tta.or.kr/data/ttasDown.jsp?where=14688&pk_num=TTAT.3G-36.442(R13-13.0.0)
TTC	TS-3GA-36.442(Rel13)v13.0.0		13.0.0	31.03.2017 https://www.ttc.or.jp/st/docs/3gpps2017/TS/TS-3GA-36.442(Rel13)v13.0.0.pdf

Release 14

ATIS	ATIS.3GPP.36.442V1400	14.0.0	02.05.2019	https://www.atis.org/docstore/
CCSA	CCSA TSD LTE 36.442	14.0.0	11.01.2019	http://www.ccsa.org.cn/ITU_spec/ITU-R/M.2012/M.2012-4/LTE/REL-14/CCSA-TSD-LTE-36442-e00.zip
ETSI	ETSI TS 136 442	14.0.0	11.04.2017	http://www.etsi.org/deliver/etsi_ts/136400_136499/136442/14.00.00_60/ts_136442v140000p.pdf
TSDSI	TSDSI STD T1.3GPP 36.442-14.0.0 V1.0.0	14.0.0	30.05.2019	https://members.tdsi.in/index.php/s/BxBT9C9F8KxobBg
TTA	TTAT.3G-36.442(R14-14.0.0)	14.0.0	10.05.2018	http://www.tta.or.kr/data/ttasDown.jsp?where=14688&pk_num=TTAT.3G-36.442(R14-14.0.0)
TTC	TS-3GA-36.442(Rel14)v14.0.0	14.0.0	13.04.2018	https://www.ttc.or.jp/st/docs/3gpps2018/TS/TS-3GA-36.442(Rel14)v14.0.0.pdf

2.1.4.16 TS 36.443**Evolved Universal Terrestrial Radio Access Network (E-UTRAN); M2 Application Protocol (M2AP)**

This document specifies the E-UTRAN radio network layer signalling protocol for the M2 interface. The M2 Application Protocol (M2AP) supports the functions of M2 interface by signalling procedures defined in this document.

SDO	Document No.	Version	Issued date	Location
Release 10				
ATIS	ATIS.3GPP.36.443V1050	10.5.0	02.05.2019	https://www.atis.org/docstore/
CCSA	CCSA TSD LTE 36.443	10.5.0	21.03.2012	http://www.ccsa.org.cn/ITU_spec/ITU-R/M.2012/M.2012-4/LTE/REL-10/CCSA-TSD-LTE-36443-a50.rar
ETSI	ETSI TS 136 443	10.5.0	21.03.2012	http://www.etsi.org/deliver/etsi_ts/136400_136499/136443/10.05.00_60/ts_136443v100500p.pdf
TSDSI	TSDSI STD T1.3GPP 36.443-10.5.0 V1.0.0	10.5.0	30.05.2019	https://members.tdsi.in/index.php/s/BxBT9C9F8KxobBg
TTA	TTAT.3G-36.443(R10-10.5.0)	10.5.0	22.08.2012	http://www.tta.or.kr/data/ttasDown.jsp?where=14688&pk_num=TTAT.3G-36.443(R10-10.5.0)
TTC	TS-3GA-36.443(Rel10)v10.5.0	10.5.0	27.06.2012	https://www.ttc.or.jp/st/docs/3gpps2012/TS/TS-3GA-36.443(Rel10)v10.5.0.pdf
Release 11				
ATIS	ATIS.3GPP.36.443V1140	11.4.0	02.05.2019	https://www.atis.org/docstore/
CCSA	CCSA TSD LTE 36.443	11.4.0	15.04.2015	http://www.ccsa.org.cn/ITU_spec/ITU-R/M.2012/M.2012-4/LTE/REL-11/CCSA-TSD-LTE-36443-b40.rar
ETSI	ETSI TS 136 443	11.4.0	15.04.2015	http://www.etsi.org/deliver/etsi_ts/136400_136499/136443/11.04.00_60/ts_136443v110400p.pdf
TSDSI	TSDSI STD T1.3GPP 36.443-11.4.0 V1.0.0	11.4.0	30.05.2019	https://members.tdsi.in/index.php/s/BxBT9C9F8KxobBg
TTA	TTAT.3G-36.443(R11-11.4.0)	11.4.0	06.07.2017	http://www.tta.or.kr/data/ttasDown.jsp?where=14688&pk_num=TTAT.3G-36.443(R11-11.4.0)
TTC	TS-3GA-36.443(Rel11)v11.4.0	11.4.0	30.06.2015	https://www.ttc.or.jp/st/docs/3gpps2015/TS/TS-3GA-36.443(Rel11)v11.4.0.pdf
Release 12				
ATIS	ATIS.3GPP.36.443V1220	12.2.0	02.05.2019	https://www.atis.org/docstore/
CCSA	CCSA TSD LTE 36.443	12.2.0	15.04.2015	http://www.ccsa.org.cn/ITU_spec/ITU-R/M.2012/M.2012-4/LTE/REL-12/CCSA-TSD-LTE-36443-c20.rar
ETSI	ETSI TS 136 443	12.2.0	15.04.2015	http://www.etsi.org/deliver/etsi_ts/136400_136499/136443/12.02.00_60/ts_136443v120200p.pdf
TSDSI	TSDSI STD T1.3GPP 36.443-12.2.0 V1.0.0	12.2.0	30.05.2019	https://members.tdsi.in/index.php/s/BxBT9C9F8KxobBg
TTA	TTAT.3G-36.443(R12-12.2.0)	12.2.0	23.12.2015	http://www.tta.or.kr/data/ttasDown.jsp?where=14688&pk_num=TTAT.3G-36.443(R12-12.2.0)
TTC	TS-3GA-36.443(Rel12)v12.2.0	12.2.0	30.06.2015	https://www.ttc.or.jp/st/docs/3gpps2015/TS/TS-3GA-36.443(Rel12)v12.2.0.pdf
Release 13				
ATIS	ATIS.3GPP.36.443V1330	13.3.0	02.05.2019	https://www.atis.org/docstore/
CCSA	CCSA TSD LTE 36.443	13.3.0	20.05.2016	http://www.ccsa.org.cn/ITU_spec/ITU-R/M.2012/M.2012-4/LTE/REL-13/CCSA-TSD-LTE-36443-d30.rar
ETSI	ETSI TS 136 443	13.3.0	20.05.2016	http://www.etsi.org/deliver/etsi_ts/136400_136499/136443/13.03.00_60/ts_136443v130300p.pdf
TSDSI	TSDSI STD T1.3GPP 36.443-13.3.0 V1.0.0	13.3.0	30.05.2019	https://members.tdsi.in/index.php/s/BxBT9C9F8KxobBg
TTA	TTAT.3G-36.443(R13-13.3.0)	13.3.0	06.07.2017	http://www.tta.or.kr/data/ttasDown.jsp?where=14688&pk_num=TTAT.3G-36.443(R13-13.3.0)
TTC	TS-3GA-36.443(Rel13)v13.3.0	13.3.0	31.03.2017	https://www.ttc.or.jp/st/docs/3gpps2017/TS/TS-3GA-36.443(Rel13)v13.3.0.pdf

Release 14

ATIS	ATIS.3GPP.36.443V1401	14.0.1	02.05.2019	https://www.atis.org/docstore/
CCSA	CCSA TSD LTE 36.443	14.0.1	11.01.2019	http://www.ccsa.org.cn/ITU_spec/ITU-R/M.2012/M.2012-4/LTE/REL-14/CCSA-TSD-LTE-36443-e01.zip
ETSI	ETSI TS 136 443	14.0.1	10.10.2017	http://www.etsi.org/deliver/etsi_ts/136400_136499/136443/14.00.01_60/ts_136443v140001p.pdf
TSDSI	TSDSI STD T1.3GPP 36.443-14.0.1 V1.0.0	14.0.1	30.05.2019	https://members.tdsi.in/index.php/s/BxBT9C9F8KxobBg
TTA	TTAT.3G-36.443(R14-14.0.1)	14.0.1	10.05.2018	http://www.tta.or.kr/data/ttasDown.jsp?where=14688&pk_num=TTAT.3G-36.443(R14-14.0.1)
TTC	TS-3GA-36.443(Rel14)v14.0.1	14.0.1	13.04.2018	https://www.ttc.or.jp/st/docs/3gpps2018/TS/TS-3GA-36.443(Rel14)v14.0.1.pdf

2.1.4.17 TS 36.444**Evolved Universal Terrestrial Radio Access Network (E-UTRAN); M3 Application Protocol (M3AP)**

This document specifies the E-UTRAN radio network layer signalling protocol for the M3 interface. The M3 Application Protocol (M3AP) supports the functions of M3 interface by signalling procedures defined in this document.

SDO	Document No.	Version	Issued date	Location
Release 10				
ATIS	ATIS.3GPP.36.444V1040		10.4.0	02.05.2019 https://www.atis.org/docstore/
CCSA	CCSA TSD LTE 36.444		10.4.0	16.01.2013 http://www.ccsa.org.cn/ITU_spec/ITU-R/M.2012/M.2012-4/LTE/REL-10/CCSA-TSD-LTE-36444-a40.rar
ETSI	ETSI TS 136 444		10.4.0	16.01.2013 http://www.etsi.org/deliver/etsi_ts/136400_136499/136444/10.04.00_60/ts_136444v100400p.pdf
TSDSI	TSDSI STD T1.3GPP 36.444-10.4.0 V1.0.0		10.4.0	30.05.2019 https://members.tdsi.in/index.php/s/BxBT9C9F8KxobBg
TTA	TTAT.3G-36.444(R10-10.4.0)		10.4.0	10.08.2016 http://www.tta.or.kr/data/ttasDown.jsp?where=14688&pk_num=TTAT.3G-36.444(R10-10.4.0)
TTC	TS-3GA-36.444(Rel10)v10.4.0		10.4.0	25.06.2013 https://www.ttc.or.jp/st/docs/3gpps2013/TS/TS-3GA-36.444(Rel10)v10.4.0.pdf
Release 11				
ATIS	ATIS.3GPP.36.444V1160		11.6.0	02.05.2019 https://www.atis.org/docstore/
CCSA	CCSA TSD LTE 36.444		11.6.0	11.07.2013 http://www.ccsa.org.cn/ITU_spec/ITU-R/M.2012/M.2012-4/LTE/REL-11/CCSA-TSD-LTE-36444-b60.rar
ETSI	ETSI TS 136 444		11.6.0	11.07.2013 http://www.etsi.org/deliver/etsi_ts/136400_136499/136444/11.06.00_60/ts_136444v110600p.pdf
TSDSI	TSDSI STD T1.3GPP 36.444-11.6.0 V1.0.0		11.6.0	30.05.2019 https://members.tdsi.in/index.php/s/BxBT9C9F8KxobBg
TTA	TTAT.3G-36.444(R11-11.6.0)		11.6.0	10.08.2016 http://www.tta.or.kr/data/ttasDown.jsp?where=14688&pk_num=TTAT.3G-36.444(R11-11.6.0)
TTC	TS-3GA-36.444(Rel11)v11.6.0		11.6.0	30.08.2013 https://www.ttc.or.jp/st/docs/3gpps2013/TS/TS-3GA-36.444(Rel11)v11.6.0.pdf
Release 12				
ATIS	ATIS.3GPP.36.444V1220		12.2.0	02.05.2019 https://www.atis.org/docstore/
CCSA	CCSA TSD LTE 36.444		12.2.0	15.04.2015 http://www.ccsa.org.cn/ITU_spec/ITU-R/M.2012/M.2012-4/LTE/REL-12/CCSA-TSD-LTE-36444-c20.rar
ETSI	ETSI TS 136 444		12.2.0	15.04.2015 http://www.etsi.org/deliver/etsi_ts/136400_136499/136444/12.02.00_60/ts_136444v120200p.pdf
TSDSI	TSDSI STD T1.3GPP 36.444-12.2.0 V1.0.0		12.2.0	30.05.2019 https://members.tdsi.in/index.php/s/BxBT9C9F8KxobBg
TTA	TTAT.3G-36.444(R12-12.2.0)		12.2.0	23.12.2015 http://www.tta.or.kr/data/ttasDown.jsp?where=14688&pk_num=TTAT.3G-36.444(R12-12.2.0)
TTC	TS-3GA-36.444(Rel12)v12.2.0		12.2.0	30.06.2015 https://www.ttc.or.jp/st/docs/3gpps2015/TS/TS-3GA-36.444(Rel12)v12.2.0.pdf
Release 13				
ATIS	ATIS.3GPP.36.444V1320		13.2.0	02.05.2019 https://www.atis.org/docstore/
CCSA	CCSA TSD LTE 36.444		13.2.0	20.05.2016 http://www.ccsa.org.cn/ITU_spec/ITU-R/M.2012/M.2012-4/LTE/REL-13/CCSA-TSD-LTE-36444-d20.rar
ETSI	ETSI TS 136 444		13.2.0	20.05.2016 http://www.etsi.org/deliver/etsi_ts/136400_136499/136444/13.02.00_60/ts_136444v130200p.pdf
TSDSI	TSDSI STD T1.3GPP 36.444-13.2.0 V1.0.0		13.2.0	30.05.2019 https://members.tdsi.in/index.php/s/BxBT9C9F8KxobBg
TTA	TTAT.3G-36.444(R13-13.2.0)		13.2.0	06.07.2017 http://www.tta.or.kr/data/ttasDown.jsp?where=14688&pk_num=TTAT.3G-36.444(R13-13.2.0)
TTC	TS-3GA-36.444(Rel13)v13.2.0		13.2.0	31.03.2017 https://www.ttc.or.jp/st/docs/3gpps2017/TS/TS-3GA-36.444(Rel13)v13.2.0.pdf

Release 14

ATIS	ATIS.3GPP.36.444V1410	14.1.0	02.05.2019	https://www.atis.org/docstore/
CCSA	CCSA TSD LTE 36.444	14.1.0	11.01.2019	http://www.ccsa.org.cn/ITU_spec/ITU-R/M.2012/M.2012-4/LTE/REL-14/CCSA-TSD-LTE-36444-e10.zip
ETSI	ETSI TS 136 444	14.1.0	24.08.2017	http://www.etsi.org/deliver/etsi_ts/136400_136499/136444/14.01.00_60/ts_136444v140100p.pdf
TSDSI	TSDSI STD T1.3GPP 36.444-14.1.0 V1.0.0	14.1.0	30.05.2019	https://members.tdsi.in/index.php/s/BxBT9C9F8KxobBg
TTA	TTAT.3G-36.444(R14-14.1.0)	14.1.0	10.05.2018	http://www.tta.or.kr/data/ttasDown.jsp?where=14688&pk_num=TTAT.3G-36.444(R14-14.1.0)
TTC	TS-3GA-36.444(Rel14)v14.1.0	14.1.0	13.04.2018	https://www.ttc.or.jp/st/docs/3gpps2018/TS/TS-3GA-36.444(Rel14)v14.1.0.pdf

2.1.4.18 TS 36.445**Evolved Universal Terrestrial Radio Access Network (E-UTRAN); M1 data transport**

This document specifies the standards for user data transport protocols over the E-UTRAN M1 interface.

SDO	Document No.	Version	Issued date	Location
Release 10				
ATIS	ATIS.3GPP.36.445V1010	10.1.0	02.05.2019	https://www.atis.org/docstore/
CCSA	CCSA TSD LTE 36.445	10.1.0	30.06.2011	http://www.ccsa.org.cn/ITU_spec/ITU-R/M.2012/M.2012-4/LTE/REL-10/CCSA-TSD-LTE-36445-a10.rar
ETSI	ETSI TS 136 445	10.1.0	30.06.2011	http://www.etsi.org/deliver/etsi_ts/136400_136499/136445/10.01.00_60/ts_136445v100100p.pdf
TSDSI	TSDSI STD T1.3GPP 36.445-10.1.0 V1.0.0	10.1.0	30.05.2019	https://members.tdsi.in/index.php/s/BxBT9C9F8KxobBg
TTA	TTAT.3G-36.445(R10-10.1.0)	10.1.0	26.08.2011	http://www.tta.or.kr/data/ttasDown.jsp?where=14688&pk_num=TTAT.3G-36.445(R10-10.1.0)
TTC	TS-3GA-36.445(Rel10)v10.1.0	10.1.0	31.08.2011	https://www.ttc.or.jp/st/docs/3gpps2011/TS/TS-3GA-36.445(Rel10)v10.1.0.pdf
Release 11				
ATIS	ATIS.3GPP.36.445V1100	11.0.0	02.05.2019	https://www.atis.org/docstore/
CCSA	CCSA TSD LTE 36.445	11.0.0	18.10.2012	http://www.ccsa.org.cn/ITU_spec/ITU-R/M.2012/M.2012-4/LTE/REL-11/CCSA-TSD-LTE-36445-b00.rar
ETSI	ETSI TS 136 445	11.0.0	18.10.2012	http://www.etsi.org/deliver/etsi_ts/136400_136499/136445/11.00.00_60/ts_136445v110000p.pdf
TSDSI	TSDSI STD T1.3GPP 36.445-11.0.0 V1.0.0	11.0.0	30.05.2019	https://members.tdsi.in/index.php/s/BxBT9C9F8KxobBg
TTA	TTAT.3G-36.445(R11-11.0.0)	11.0.0	26.08.2013	http://www.tta.or.kr/data/ttasDown.jsp?where=14688&pk_num=TTAT.3G-36.445(R11-11.0.0)
TTC	TS-3GA-36.445(Rel11)v11.0.0	11.0.0	25.06.2013	https://www.ttc.or.jp/st/docs/3gpps2013/TS/TS-3GA-36.445(Rel11)v11.0.0.pdf
Release 12				
ATIS	ATIS.3GPP.36.445V1200	12.0.0	02.05.2019	https://www.atis.org/docstore/
CCSA	CCSA TSD LTE 36.445	12.0.0	26.09.2014	http://www.ccsa.org.cn/ITU_spec/ITU-R/M.2012/M.2012-4/LTE/REL-12/CCSA-TSD-LTE-36445-c00.rar
ETSI	ETSI TS 136 445	12.0.0	26.09.2014	http://www.etsi.org/deliver/etsi_ts/136400_136499/136445/12.00.00_60/ts_136445v120000p.pdf
TSDSI	TSDSI STD T1.3GPP 36.445-12.0.0 V1.0.0	12.0.0	30.05.2019	https://members.tdsi.in/index.php/s/BxBT9C9F8KxobBg
TTA	TTAT.3G-36.445(R12-12.0.0)	12.0.0	09.04.2015	http://www.tta.or.kr/data/ttasDown.jsp?where=14688&pk_num=TTAT.3G-36.445(R12-12.0.0)
TTC	TS-3GA-36.445(Rel12)v12.0.0	12.0.0	05.03.2015	https://www.ttc.or.jp/st/docs/3gpps2015/TS/TS-3GA-36.445(Rel12)v12.0.0.pdf
Release 13				
ATIS	ATIS.3GPP.36.445V1300	13.0.0	02.05.2019	https://www.atis.org/docstore/
CCSA	CCSA TSD LTE 36.445	13.0.0	21.01.2016	http://www.ccsa.org.cn/ITU_spec/ITU-R/M.2012/M.2012-4/LTE/REL-13/CCSA-TSD-LTE-36445-d00.rar
ETSI	ETSI TS 136 445	13.0.0	21.01.2016	http://www.etsi.org/deliver/etsi_ts/136400_136499/136445/13.00.00_60/ts_136445v130000p.pdf
TSDSI	TSDSI STD T1.3GPP 36.445-13.0.0 V1.0.0	13.0.0	30.05.2019	https://members.tdsi.in/index.php/s/BxBT9C9F8KxobBg
TTA	TTAT.3G-36.445(R13-13.0.0)	13.0.0	06.07.2017	http://www.tta.or.kr/data/ttasDown.jsp?where=14688&pk_num=TTAT.3G-36.445(R13-13.0.0)
TTC	TS-3GA-36.445(Rel13)v13.0.0	13.0.0	31.03.2017	https://www.ttc.or.jp/st/docs/3gpps2017/TS/TS-3GA-36.445(Rel13)v13.0.0.pdf
Release 14				

60

ATIS	ATIS.3GPP.36.445V1400	14.0.0	02.05.2019	https://www.atis.org/docstore/
CCSA	CCSA TSD LTE 36.445	14.0.0	11.01.2019	http://www.ccsa.org.cn/ITU_spec/ITU-R/M.2012/M.2012-4/LTE/REL-14/CCSA-TSD-LTE-36445-e00.zip
ETSI	ETSI TS 136 445	14.0.0	11.04.2017	http://www.etsi.org/deliver/etsi_ts/136400_136499/136445/14.00.00_60/ts_136445v140000p.pdf
TSDSI	TSDSI STD T1.3GPP 36.445-14.0.0 V1.0.0	14.0.0	30.05.2019	https://members.tdsi.in/index.php/s/BxBT9C9F8KxobBg
TTA	TTAT.3G-36.445(R14-14.0.0)	14.0.0	10.05.2018	http://www.tta.or.kr/data/ttasDown.jsp?where=14688&pk_num=TTAT.3G-36.445(R14-14.0.0)
TTC	TS-3GA-36.445(Rel14)v14.0.0	14.0.0	13.04.2018	https://www.ttc.or.jp/st/docs/3gpps2018/TS/TS-3GA-36.445(Rel14)v14.0.0.pdf

Rec. ITU-R M.2012-4

2.1.4.19 TS 36.455

Evolved Universal Terrestrial Radio Access (E-UTRA); LTE Positioning Protocol A (LPPa)

This document specifies the control plane radio network layer signalling procedures between eNodeB and E-SMLC. LPPa supports the concerned functions by signalling procedures defined in this document.

SDO	Document No.	Version	Issued date	Location
Release 10				
ATIS	ATIS.3GPP.36.455V1040	10.4.0	02.05.2019	https://www.atis.org/docstore/
CCSA	CCSA TSD LTE 36.455	10.4.0	18.10.2012	http://www.ccsa.org.cn/ITU_spec/ITU-R/M.2012/M.2012-4/LTE/REL-10/CCSA-TSD-LTE-36455-a40.rar
ETSI	ETSI TS 136 455	10.4.0	18.10.2012	http://www.etsi.org/deliver/etsi_ts/136400_136499/136455/10.04.00_60/ts_136455v100400p.pdf
TSDSI	TSDSI STD T1.3GPP 36.455-10.4.0 V1.0.0	10.4.0	30.05.2019	https://members.tdsi.in/index.php/s/BxBT9C9F8KxobBg
TTA	TTAT.3G-36.455(R10-10.4.0)	10.4.0	10.05.2018	http://www.tta.or.kr/data/ttasDown.jsp?where=14688&pk_num=TTAT.3G-36.455(R10-10.4.0)
TTC	TS-3GA-36.455(Rel10)v10.4.0	10.4.0	19.12.2012	https://www.ttc.or.jp/st/docs/3gpps2012/TS/TS-3GA-36.455(Rel10)v10.4.0.pdf
Release 11				
ATIS	ATIS.3GPP.36.455V1130	11.3.0	02.05.2019	https://www.atis.org/docstore/
CCSA	CCSA TSD LTE 36.455	11.3.0	11.07.2013	http://www.ccsa.org.cn/ITU_spec/ITU-R/M.2012/M.2012-4/LTE/REL-11/CCSA-TSD-LTE-36455-b30.rar
ETSI	ETSI TS 136 455	11.3.0	11.07.2013	http://www.etsi.org/deliver/etsi_ts/136400_136499/136455/11.03.00_60/ts_136455v110300p.pdf
TSDSI	TSDSI STD T1.3GPP 36.455-11.3.0 V1.0.0	11.3.0	30.05.2019	https://members.tdsi.in/index.php/s/BxBT9C9F8KxobBg
TTA	TTAT.3G-36.455(R11-11.3.0)	11.3.0	10.08.2016	http://www.tta.or.kr/data/ttasDown.jsp?where=14688&pk_num=TTAT.3G-36.455(R11-11.3.0)
TTC	TS-3GA-36.455(Rel11)v11.3.0	11.3.0	30.08.2013	https://www.ttc.or.jp/st/docs/3gpps2013/TS/TS-3GA-36.455(Rel11)v11.3.0.pdf
Release 12				
ATIS	ATIS.3GPP.36.455V1220	12.2.0	02.05.2019	https://www.atis.org/docstore/
CCSA	CCSA TSD LTE 36.455	12.2.0	15.04.2015	http://www.ccsa.org.cn/ITU_spec/ITU-R/M.2012/M.2012-4/LTE/REL-12/CCSA-TSD-LTE-36455-c20.rar
ETSI	ETSI TS 136 455	12.2.0	15.04.2015	http://www.etsi.org/deliver/etsi_ts/136400_136499/136455/12.02.00_60/ts_136455v120200p.pdf
TSDSI	TSDSI STD T1.3GPP 36.455-12.2.0 V1.0.0	12.2.0	30.05.2019	https://members.tdsi.in/index.php/s/BxBT9C9F8KxobBg
TTA	TTAT.3G-36.455(R12-12.2.0)	12.2.0	06.07.2017	http://www.tta.or.kr/data/ttasDown.jsp?where=14688&pk_num=TTAT.3G-36.455(R12-12.2.0)
TTC	TS-3GA-36.455(Rel12)v12.2.0	12.2.0	30.06.2015	https://www.ttc.or.jp/st/docs/3gpps2015/TS/TS-3GA-36.455(Rel12)v12.2.0.pdf
Release 13				
ATIS	ATIS.3GPP.36.455V1310	13.1.0	02.05.2019	https://www.atis.org/docstore/
CCSA	CCSA TSD LTE 36.455	13.1.0	26.05.2016	http://www.ccsa.org.cn/ITU_spec/ITU-R/M.2012/M.2012-4/LTE/REL-13/CCSA-TSD-LTE-36455-d10.rar
ETSI	ETSI TS 136 455	13.1.0	26.05.2016	http://www.etsi.org/deliver/etsi_ts/136400_136499/136455/13.01.00_60/ts_136455v130100p.pdf
TSDSI	TSDSI STD T1.3GPP 36.455-13.1.0 V1.0.0	13.1.0	30.05.2019	https://members.tdsi.in/index.php/s/BxBT9C9F8KxobBg
TTA	TTAT.3G-36.455(R13-13.1.0)	13.1.0	06.07.2017	http://www.tta.or.kr/data/ttasDown.jsp?where=14688&pk_num=TTAT.3G-36.455(R13-13.1.0)
TTC	TS-3GA-36.455(Rel13)v13.1.0	13.1.0	31.03.2017	https://www.ttc.or.jp/st/docs/3gpps2017/TS/TS-3GA-36.455(Rel13)v13.1.0.pdf

Release 14

ATIS	ATIS.3GPP.36.455V1440	14.4.0	02.05.2019	https://www.atis.org/docstore/
CCSA	CCSA TSD LTE 36.455	14.4.0	11.01.2019	http://www.ccsa.org.cn/ITU_spec/ITU-R/M.2012/M.2012-4/LTE/REL-14/CCSA-TSD-LTE-36455-e40.zip
ETSI	ETSI TS 136 455	14.4.0	25.01.2018	http://www.etsi.org/deliver/etsi_ts/136400_136499/136455/14.04.00_60/ts_136455v140400p.pdf
TSDSI	TSDSI STD T1.3GPP 36.455-14.4.0 V1.0.0	14.4.0	30.05.2019	https://members.tdsi.in/index.php/s/BxBT9C9F8KxobBg
TTA	TTAT.3G-36.455(R14-14.4.0)	14.4.0	09.05.2019	http://www.tta.or.kr/data/ttasDown.jsp?where=14688&pk_num=TTAT.3G-36.455(R14-14.4.0)
TTC	TS-3GA-36.455(Rel14)v14.4.0	14.4.0	13.04.2018	https://www.ttc.or.jp/st/docs/3gpps2018/TS/TS-3GA-36.455(Rel14)v14.4.0.pdf

2.1.4.20 TS 36.456

SLm interface general aspects and principles

This document is an introduction to the 3GPP TS 36.45x series of technical specifications that define the SLm interface for the interconnection of the Evolved Serving Mobile Location Centre (E-SMLC) to the Location Measurement Unit (LMU) components of the Evolved Universal Terrestrial Radio Access Network (E-UTRAN).

SDO	Document No.	Version	Issued date	Location
Release 11				
ATIS	ATIS.3GPP.36.456V1100	11.0.0	02.05.2019	https://www.atis.org/docstore/
CCSA	CCSA TSD LTE 36.456	11.0.0	12.02.2013	http://www.ccsa.org.cn/ITU_spec/ITU-R/M.2012/M.2012-4/LTE/REL-11/CCSA-TSD-LTE-36456-b00.rar
ETSI	ETSI TS 136 456	11.0.0	12.02.2013	http://www.etsi.org/deliver/etsi_ts/136400_136499/136456/11.00.00_60/ts_136456v110000p.pdf
TSDSI	TSDSI STD T1.3GPP 36.456-11.0.0 V1.0.0	11.0.0	30.05.2019	https://members.tdsi.in/index.php/s/BxBT9C9F8KxobBg
TTA	TTAT.3G-36.456(R11-11.0.0)	11.0.0	26.08.2013	http://www.tta.or.kr/data/ttasDown.jsp?where=14688&pk_num=TTAT.3G-36.456(R11-11.0.0)
TTC	TS-3GA-36.456(Rel11)v11.0.0	11.0.0	25.06.2013	https://www.ttc.or.jp/st/docs/3gpps2013/TS/TS-3GA-36.456(Rel11)v11.0.0.pdf
Release 12				
ATIS	ATIS.3GPP.36.456V1200	12.0.0	02.05.2019	https://www.atis.org/docstore/
CCSA	CCSA TSD LTE 36.456	12.0.0	26.09.2014	http://www.ccsa.org.cn/ITU_spec/ITU-R/M.2012/M.2012-4/LTE/REL-12/CCSA-TSD-LTE-36456-c00.rar
ETSI	ETSI TS 136 456	12.0.0	26.09.2014	http://www.etsi.org/deliver/etsi_ts/136400_136499/136456/12.00.00_60/ts_136456v120000p.pdf
TSDSI	TSDSI STD T1.3GPP 36.456-12.0.0 V1.0.0	12.0.0	30.05.2019	https://members.tdsi.in/index.php/s/BxBT9C9F8KxobBg
TTA	TTAT.3G-36.456(R12-12.0.0)	12.0.0	09.04.2015	http://www.tta.or.kr/data/ttasDown.jsp?where=14688&pk_num=TTAT.3G-36.456(R12-12.0.0)
TTC	TS-3GA-36.456(Rel12)v12.0.0	12.0.0	05.03.2015	https://www.ttc.or.jp/st/docs/3gpps2015/TS/TS-3GA-36.456(Rel12)v12.0.0.pdf
Release 13				
ATIS	ATIS.3GPP.36.456V1300	13.0.0	02.05.2019	https://www.atis.org/docstore/
CCSA	CCSA TSD LTE 36.456	13.0.0	21.01.2016	http://www.ccsa.org.cn/ITU_spec/ITU-R/M.2012/M.2012-4/LTE/REL-13/CCSA-TSD-LTE-36456-d00.rar
ETSI	ETSI TS 136 456	13.0.0	21.01.2016	http://www.etsi.org/deliver/etsi_ts/136400_136499/136456/13.00.00_60/ts_136456v130000p.pdf
TSDSI	TSDSI STD T1.3GPP 36.456-13.0.0 V1.0.0	13.0.0	30.05.2019	https://members.tdsi.in/index.php/s/BxBT9C9F8KxobBg
TTA	TTAT.3G-36.456(R13-13.0.0)	13.0.0	06.07.2017	http://www.tta.or.kr/data/ttasDown.jsp?where=14688&pk_num=TTAT.3G-36.456(R13-13.0.0)
TTC	TS-3GA-36.456(Rel13)v13.0.0	13.0.0	31.03.2017	https://www.ttc.or.jp/st/docs/3gpps2017/TS/TS-3GA-36.456(Rel13)v13.0.0.pdf
Release 14				
ATIS	ATIS.3GPP.36.456V1400	14.0.0	02.05.2019	https://www.atis.org/docstore/
CCSA	CCSA TSD LTE 36.456	14.0.0	11.01.2019	http://www.ccsa.org.cn/ITU_spec/ITU-R/M.2012/M.2012-4/LTE/REL-14/CCSA-TSD-LTE-36456-e00.zip
ETSI	ETSI TS 136 456	14.0.0	11.04.2017	http://www.etsi.org/deliver/etsi_ts/136400_136499/136456/14.00.00_60/ts_136456v140000p.pdf
TSDSI	TSDSI STD T1.3GPP 36.456-14.0.0 V1.0.0	14.0.0	30.05.2019	https://members.tdsi.in/index.php/s/BxBT9C9F8KxobBg
TTA	TTAT.3G-36.456(R14-14.0.0)	14.0.0	10.05.2018	http://www.tta.or.kr/data/ttasDown.jsp?where=14688&pk_num=TTAT.3G-36.456(R14-14.0.0)
TTC	TS-3GA-36.456(Rel14)v14.0.0	14.0.0	13.04.2018	https://www.ttc.or.jp/st/docs/3gpps2018/TS/TS-3GA-36.456(Rel14)v14.0.0.pdf

2.1.4.21 TS 36.457

SLm interface layer 1

This document specifies the standards allowed to implement layer 1 on the SLm interface.

SDO	Document No.	Version	Issued date	Location
Release 11				
ATIS	ATIS.3GPP.36.457V1100		11.0.0	02.05.2019 https://www.atis.org/docstore/
CCSA	CCSA TSD LTE 36.457		11.0.0	12.02.2013 http://www.ccsa.org.cn/ITU_spec/ITU-R/M.2012/M.2012-4/LTE/REL-11/CCSA-TSD-LTE-36457-b00.rar
ETSI	ETSI TS 136 457		11.0.0	12.02.2013 http://www.etsi.org/deliver/etsi_ts/136400_136499/136457/11.00.00_60/ts_136457v110000p.pdf
TSDSI	TSDSI STD T1.3GPP 36.457-11.0.0 V1.0.0		11.0.0	30.05.2019 https://members.tdsi.in/index.php/s/BxBT9C9F8KxobBg
TTA	TTAT.3G-36.457(R11-11.0.0)		11.0.0	26.08.2013 http://www.tta.or.kr/data/ttasDown.jsp?where=14688&pk_num=TTAT.3G-36.457(R11-11.0.0)
TTC	TS-3GA-36.457(Rel11)v11.0.0		11.0.0	25.06.2013 https://www.ttc.or.jp/st/docs/3gpps2013/TS/TS-3GA-36.457(Rel11)v11.0.0.pdf
Release 12				
ATIS	ATIS.3GPP.36.457V1200		12.0.0	02.05.2019 https://www.atis.org/docstore/
CCSA	CCSA TSD LTE 36.457		12.0.0	26.09.2014 http://www.ccsa.org.cn/ITU_spec/ITU-R/M.2012/M.2012-4/LTE/REL-12/CCSA-TSD-LTE-36457-c00.rar
ETSI	ETSI TS 136 457		12.0.0	26.09.2014 http://www.etsi.org/deliver/etsi_ts/136400_136499/136457/12.00.00_60/ts_136457v120000p.pdf
TSDSI	TSDSI STD T1.3GPP 36.457-12.0.0 V1.0.0		12.0.0	30.05.2019 https://members.tdsi.in/index.php/s/BxBT9C9F8KxobBg
TTA	TTAT.3G-36.457(R12-12.0.0)		12.0.0	09.04.2015 http://www.tta.or.kr/data/ttasDown.jsp?where=14688&pk_num=TTAT.3G-36.457(R12-12.0.0)
TTC	TS-3GA-36.457(Rel12)v12.0.0		12.0.0	05.03.2015 https://www.ttc.or.jp/st/docs/3gpps2015/TS/TS-3GA-36.457(Rel12)v12.0.0.pdf
Release 13				
ATIS	ATIS.3GPP.36.457V1300		13.0.0	02.05.2019 https://www.atis.org/docstore/
CCSA	CCSA TSD LTE 36.457		13.0.0	21.01.2016 http://www.ccsa.org.cn/ITU_spec/ITU-R/M.2012/M.2012-4/LTE/REL-13/CCSA-TSD-LTE-36457-d00.rar
ETSI	ETSI TS 136 457		13.0.0	21.01.2016 http://www.etsi.org/deliver/etsi_ts/136400_136499/136457/13.00.00_60/ts_136457v130000p.pdf
TSDSI	TSDSI STD T1.3GPP 36.457-13.0.0 V1.0.0		13.0.0	30.05.2019 https://members.tdsi.in/index.php/s/BxBT9C9F8KxobBg
TTA	TTAT.3G-36.457(R13-13.0.0)		13.0.0	06.07.2017 http://www.tta.or.kr/data/ttasDown.jsp?where=14688&pk_num=TTAT.3G-36.457(R13-13.0.0)
TTC	TS-3GA-36.457(Rel13)v13.0.0		13.0.0	31.03.2017 https://www.ttc.or.jp/st/docs/3gpps2017/TS/TS-3GA-36.457(Rel13)v13.0.0.pdf
Release 14				
ATIS	ATIS.3GPP.36.457V1400		14.0.0	02.05.2019 https://www.atis.org/docstore/
CCSA	CCSA TSD LTE 36.457		14.0.0	11.01.2019 http://www.ccsa.org.cn/ITU_spec/ITU-R/M.2012/M.2012-4/LTE/REL-14/CCSA-TSD-LTE-36457-e00.zip
ETSI	ETSI TS 136 457		14.0.0	11.04.2017 http://www.etsi.org/deliver/etsi_ts/136400_136499/136457/14.00.00_60/ts_136457v140000p.pdf
TSDSI	TSDSI STD T1.3GPP 36.457-14.0.0 V1.0.0		14.0.0	30.05.2019 https://members.tdsi.in/index.php/s/BxBT9C9F8KxobBg
TTA	TTAT.3G-36.457(R14-14.0.0)		14.0.0	10.05.2018 http://www.tta.or.kr/data/ttasDown.jsp?where=14688&pk_num=TTAT.3G-36.457(R14-14.0.0)
TTC	TS-3GA-36.457(Rel14)v14.0.0		14.0.0	13.04.2018 https://www.ttc.or.jp/st/docs/3gpps2018/TS/TS-3GA-36.457(Rel14)v14.0.0.pdf

2.1.4.22 TS 36.458

SLm interface signalling transport

This document specifies the standards for signalling transport to be used across the SLm interface. The SLm interface is a logical interface between the LMU and the E-SMLC in the E-UTRAN core network. This document describes how the SLmAP signalling messages are transported over SLm.

SDO	Document No.	Version	Issued date	Location
Release 11				
ATIS	ATIS.3GPP.36.458V1100		11.0.0	02.05.2019 https://www.atis.org/docstore/
CCSA	CCSA TSD LTE 36.458		11.0.0	12.02.2013 http://www.ccsa.org.cn/ITU_spec/ITU-R/M.2012/M.2012-4/LTE/REL-11/CCSA-TSD-LTE-36458-b00.rar
ETSI	ETSI TS 136 458		11.0.0	12.02.2013 http://www.etsi.org/deliver/etsi_ts/136400_136499/136458/11.00.00_60/ts_136458v110000p.pdf
TSDSI	TSDSI STD T1.3GPP 36.458-11.0.0 V1.0.0		11.0.0	30.05.2019 https://members.tdsi.in/index.php/s/BxBT9C9F8KxobBg
TTA	TTAT.3G-36.458(R11-11.0.0)		11.0.0	26.08.2013 http://www.tta.or.kr/data/ttasDown.jsp?where=14688&pk_num=TTAT.3G-36.458(R11-11.0.0)
TTC	TS-3GA-36.458(Rel11)v11.0.0		11.0.0	25.06.2013 https://www.ttc.or.jp/st/docs/3gpps2013/TS/TS-3GA-36.458(Rel11)v11.0.0.pdf
Release 12				
ATIS	ATIS.3GPP.36.458V1200		12.0.0	02.05.2019 https://www.atis.org/docstore/
CCSA	CCSA TSD LTE 36.458		12.0.0	26.09.2014 http://www.ccsa.org.cn/ITU_spec/ITU-R/M.2012/M.2012-4/LTE/REL-12/CCSA-TSD-LTE-36458-c00.rar
ETSI	ETSI TS 136 458		12.0.0	26.09.2014 http://www.etsi.org/deliver/etsi_ts/136400_136499/136458/12.00.00_60/ts_136458v120000p.pdf
TSDSI	TSDSI STD T1.3GPP 36.458-12.0.0 V1.0.0		12.0.0	30.05.2019 https://members.tdsi.in/index.php/s/BxBT9C9F8KxobBg
TTA	TTAT.3G-36.458(R12-12.0.0)		12.0.0	09.04.2015 http://www.tta.or.kr/data/ttasDown.jsp?where=14688&pk_num=TTAT.3G-36.458(R12-12.0.0)
TTC	TS-3GA-36.458(Rel12)v12.0.0		12.0.0	05.03.2015 https://www.ttc.or.jp/st/docs/3gpps2015/TS/TS-3GA-36.458(Rel12)v12.0.0.pdf
Release 13				
ATIS	ATIS.3GPP.36.458V1300		13.0.0	02.05.2019 https://www.atis.org/docstore/
CCSA	CCSA TSD LTE 36.458		13.0.0	21.01.2016 http://www.ccsa.org.cn/ITU_spec/ITU-R/M.2012/M.2012-4/LTE/REL-13/CCSA-TSD-LTE-36458-d00.rar
ETSI	ETSI TS 136 458		13.0.0	21.01.2016 http://www.etsi.org/deliver/etsi_ts/136400_136499/136458/13.00.00_60/ts_136458v130000p.pdf
TSDSI	TSDSI STD T1.3GPP 36.458-13.0.0 V1.0.0		13.0.0	30.05.2019 https://members.tdsi.in/index.php/s/BxBT9C9F8KxobBg
TTA	TTAT.3G-36.458(R13-13.0.0)		13.0.0	06.07.2017 http://www.tta.or.kr/data/ttasDown.jsp?where=14688&pk_num=TTAT.3G-36.458(R13-13.0.0)
TTC	TS-3GA-36.458(Rel13)v13.0.0		13.0.0	31.03.2017 https://www.ttc.or.jp/st/docs/3gpps2017/TS/TS-3GA-36.458(Rel13)v13.0.0.pdf
Release 14				
ATIS	ATIS.3GPP.36.458V1400		14.0.0	02.05.2019 https://www.atis.org/docstore/
CCSA	CCSA TSD LTE 36.458		14.0.0	11.01.2019 http://www.ccsa.org.cn/ITU_spec/ITU-R/M.2012/M.2012-4/LTE/REL-14/CCSA-TSD-LTE-36458-e00.zip
ETSI	ETSI TS 136 458		14.0.0	11.04.2017 http://www.etsi.org/deliver/etsi_ts/136400_136499/136458/14.00.00_60/ts_136458v140000p.pdf
TSDSI	TSDSI STD T1.3GPP 36.458-14.0.0 V1.0.0		14.0.0	30.05.2019 https://members.tdsi.in/index.php/s/BxBT9C9F8KxobBg
TTA	TTAT.3G-36.458(R14-14.0.0)		14.0.0	10.05.2018 http://www.tta.or.kr/data/ttasDown.jsp?where=14688&pk_num=TTAT.3G-36.458(R14-14.0.0)
TTC	TS-3GA-36.458(Rel14)v14.0.0		14.0.0	13.04.2018 https://www.ttc.or.jp/st/docs/3gpps2018/TS/TS-3GA-36.458(Rel14)v14.0.0.pdf

2.1.4.23 TS 36.459

SLm interface Application Protocol (SLmAP)

This document specifies the E-UTRAN radio network layer signalling protocol for the SLm interface. The SLm Application Protocol (SLmAP) supports the functions of the SLm interface by signalling procedures defined in this document.

SDO	Document No.	Version	Issued date	Location
Release 11				
ATIS	ATIS.3GPP.36.459V1130		11.3.0	02.05.2019 https://www.atis.org/docstore/
CCSA	CCSA TSD LTE 36.459		11.3.0	26.09.2013 http://www.ccsa.org.cn/ITU_spec/ITU-R/M.2012/M.2012-4/LTE/REL-11/CCSA-TSD-LTE-36459-b30.rar
ETSI	ETSI TS 136 459		11.3.0	26.09.2013 http://www.etsi.org/deliver/etsi_ts/136400_136499/136459/11.03.00_60/ts_136459v110300p.pdf
TSDSI	TSDSI STD T1.3GPP 36.459-11.3.0 V1.0.0		11.3.0	30.05.2019 https://members.tdsi.in/index.php/s/BxBT9C9F8KxobBg
TTA	TTAT.3G-36.459(R11-11.3.0)		11.3.0	10.08.2016 http://www.tta.or.kr/data/ttasDown.jsp?where=14688&pk_num=TTAT.3G-36.459(R11-11.3.0)

64

TTC TS-3GA-36.459(Rel11)v11.3.0 11.3.0 22.11.2013 [https://www.ttc.or.jp/st/docs/3gpps2013/TS/TS-3GA-36.459\(Rel11\)v11.3.0.pdf](https://www.ttc.or.jp/st/docs/3gpps2013/TS/TS-3GA-36.459(Rel11)v11.3.0.pdf)

Release 12

ATIS ATIS.3GPP.36.459V1210 12.1.0 02.05.2019 <https://www.atis.org/docstore/>
CCSA CCSA TSD LTE 36.459 12.1.0 27.04.2015 http://www.ccsa.org.cn/ITU_spec/ITU-R/M.2012/M.2012-4/LTE/REL-12/CCSA-TSD-LTE-36459-c10.rar
ETSI ETSI TS 136 459 12.1.0 27.04.2015 http://www.etsi.org/deliver/etsi_ts/136400_136499/136459/12.01.00_60/ts_136459v120100p.pdf
TSDSI TSDSI STD T1.3GPP 36.459-12.1.0 V1.0.0 12.1.0 30.05.2019 <https://members.tdsi.in/index.php/s/BxBT9C9F8KxobBg>
TTA TTAT.3G-36.459(R12-12.1.0) 12.1.0 06.07.2017 [http://www.tta.or.kr/data/ttasDown.jsp?where=14688&pk_num=TTAT.3G-36.459\(R12-12.1.0\)](http://www.tta.or.kr/data/ttasDown.jsp?where=14688&pk_num=TTAT.3G-36.459(R12-12.1.0))
TTC TS-3GA-36.459(Rel12)v12.1.0 12.1.0 30.06.2015 [https://www.ttc.or.jp/st/docs/3gpps2015/TS/TS-3GA-36.459\(Rel12\)v12.1.0.pdf](https://www.ttc.or.jp/st/docs/3gpps2015/TS/TS-3GA-36.459(Rel12)v12.1.0.pdf)

Release 13

ATIS ATIS.3GPP.36.459V1310 13.1.0 02.05.2019 <https://www.atis.org/docstore/>
CCSA CCSA TSD LTE 36.459 13.1.0 20.05.2016 http://www.ccsa.org.cn/ITU_spec/ITU-R/M.2012/M.2012-4/LTE/REL-13/CCSA-TSD-LTE-36459-d10.rar
ETSI ETSI TS 136 459 13.1.0 20.05.2016 http://www.etsi.org/deliver/etsi_ts/136400_136499/136459/13.01.00_60/ts_136459v130100p.pdf
TSDSI TSDSI STD T1.3GPP 36.459-13.1.0 V1.0.0 13.1.0 30.05.2019 <https://members.tdsi.in/index.php/s/BxBT9C9F8KxobBg>
TTA TTAT.3G-36.459(R13-13.1.0) 13.1.0 06.07.2017 [http://www.tta.or.kr/data/ttasDown.jsp?where=14688&pk_num=TTAT.3G-36.459\(R13-13.1.0\)](http://www.tta.or.kr/data/ttasDown.jsp?where=14688&pk_num=TTAT.3G-36.459(R13-13.1.0))
TTC TS-3GA-36.459(Rel13)v13.1.0 13.1.0 31.03.2017 [https://www.ttc.or.jp/st/docs/3gpps2017/TS/TS-3GA-36.459\(Rel13\)v13.1.0.pdf](https://www.ttc.or.jp/st/docs/3gpps2017/TS/TS-3GA-36.459(Rel13)v13.1.0.pdf)

Release 14

ATIS ATIS.3GPP.36.459V1400 14.0.0 02.05.2019 <https://www.atis.org/docstore/>
CCSA CCSA TSD LTE 36.459 14.0.0 11.01.2019 http://www.ccsa.org.cn/ITU_spec/ITU-R/M.2012/M.2012-4/LTE/REL-14/CCSA-TSD-LTE-36459-e00.zip
ETSI ETSI TS 136 459 14.0.0 11.04.2017 http://www.etsi.org/deliver/etsi_ts/136400_136499/136459/14.00.00_60/ts_136459v140000p.pdf
TSDSI TSDSI STD T1.3GPP 36.459-14.0.0 V1.0.0 14.0.0 30.05.2019 <https://members.tdsi.in/index.php/s/BxBT9C9F8KxobBg>
TTA TTAT.3G-36.459(R14-14.0.0) 14.0.0 10.05.2018 [http://www.tta.or.kr/data/ttasDown.jsp?where=14688&pk_num=TTAT.3G-36.459\(R14-14.0.0\)](http://www.tta.or.kr/data/ttasDown.jsp?where=14688&pk_num=TTAT.3G-36.459(R14-14.0.0))
TTC TS-3GA-36.459(Rel14)v14.0.0 14.0.0 13.04.2018 [https://www.ttc.or.jp/st/docs/3gpps2018/TS/TS-3GA-36.459\(Rel14\)v14.0.0.pdf](https://www.ttc.or.jp/st/docs/3gpps2018/TS/TS-3GA-36.459(Rel14)v14.0.0.pdf)

2.1.4.24 TS 36.461

Evolved Universal Terrestrial Radio Access Network (E-UTRAN) and Wireless LAN (WLAN); Xw layer 1

This document specifies the standards allowed to implement Layer 1 on the Xw interface. The specification of transmission delay requirements and O&M requirements are not in the scope of this document.

SDO	Document No.	Version	Issued date	Location
Release 13				
ARIB	ARIB STD-T104-36.461		13.0.0 12.04.2018	http://www.arib.or.jp/english/html/overview/doc/STD-T104v5_20/2_T104/ARIB-STD-T104/Rel13/36/A36461-d00.pdf
ATIS	ATIS.3GPP.36.461V1300		13.0.0 02.05.2019	https://www.atis.org/docstore/
CCSA	CCSA TSD LTE 36.461		13.0.0 22.04.2016	http://www.ccsa.org.cn/ITU_spec/ITU-R/M.2012/M.2012-4/LTE/REL-13/CCSA-TSD-LTE-36461-d00.rar
ETSI	ETSI TS 136 461		13.0.0 22.04.2016	http://www.etsi.org/deliver/etsi_ts/136400_136499/136461/13.00.00_60/ts_136461v130000p.pdf
TSDSI	TSDSI STD T1.3GPP 36.461-13.0.0 V1.0.0		13.0.0 30.05.2019	https://members.tdsi.in/index.php/s/BxBT9C9F8KxobBg
TTA	TTAT.3G-36.461(R13-13.0.0)		13.0.0 06.07.2017	http://www.tta.or.kr/data/ttasDown.jsp?where=14688&pk_num=TTAT.3G-36.461(R13-13.0.0)
Release 14				
ARIB	ARIB STD-T104-36.461		14.0.0 12.04.2018	http://www.arib.or.jp/english/html/overview/doc/STD-T104v5_20/2_T104/ARIB-STD-T104/Rel14/36/A36461-e00.pdf
ATIS	ATIS.3GPP.36.461V1400		14.0.0 02.05.2019	https://www.atis.org/docstore/
CCSA	CCSA TSD LTE 36.461		14.0.0 11.01.2019	http://www.ccsa.org.cn/ITU_spec/ITU-R/M.2012/M.2012-4/LTE/REL-14/CCSA-TSD-LTE-36461-e00.zip
ETSI	ETSI TS 136 461		14.0.0 11.04.2017	http://www.etsi.org/deliver/etsi_ts/136400_136499/136461/14.00.00_60/ts_136461v140000p.pdf
TSDSI	TSDSI STD T1.3GPP 36.461-14.0.0 V1.0.0		14.0.0 30.05.2019	https://members.tdsi.in/index.php/s/BxBT9C9F8KxobBg

TTA TTAT.3G-36.461(R14-14.0.0) 14.0.0 10.05.2018 [http://www.tta.or.kr/data/ttasDown.jsp?where=14688&pk_num=TTAT.3G-36.461\(R14-14.0.0\)](http://www.tta.or.kr/data/ttasDown.jsp?where=14688&pk_num=TTAT.3G-36.461(R14-14.0.0))

2.1.4.25 TS 36.462

Evolved Universal Terrestrial Radio Access Network (E-UTRAN) and Wireless LAN (WLAN); Xw signalling transport

This document specifies the standards for Signalling Transport to be used across the Xw interface. The Xw interface is a logical interface between the eNB and the WLAN Termination (WT). This document describes how the Xw-AP signalling messages are transported over Xw.

SDO	Document No.	Version	Issued date	Location
Release 13				
ARIB	ARIB STD-T104-36.462		13.0.0	12.04.2018 http://www.arib.or.jp/english/html/overview/doc/STD-T104v5_20/2_T104/ARIB-STD-T104/Rel13/36/A36462-d00.pdf
ATIS	ATIS.3GPP.36.462V1300		13.0.0	02.05.2019 https://www.atis.org/docstore/
CCSA	CCSA TSD LTE 36.462		13.0.0	22.04.2016 http://www.ccsa.org.cn/ITU_spec/ITU-R/M.2012/M.2012-4/LTE/REL-13/CCSA-TSD-LTE-36462-d00.rar
ETSI	ETSI TS 136 462		13.0.0	22.04.2016 http://www.etsi.org/deliver/etsi_ts/136400_136499/136462/13.00.00_60/ts_136462v130000p.pdf
TSDSI	TSDSI STD T1.3GPP 36.462-13.0.0 V1.0.0		13.0.0	30.05.2019 https://members.tdsi.in/index.php/s/BxBT9C9F8KxobBg
TTA	TTAT.3G-36.462(R13-13.0.0)		13.0.0	06.07.2017 http://www.tta.or.kr/data/ttasDown.jsp?where=14688&pk_num=TTAT.3G-36.462(R13-13.0.0)
Release 14				
ARIB	ARIB STD-T104-36.462		14.0.0	12.04.2018 http://www.arib.or.jp/english/html/overview/doc/STD-T104v5_20/2_T104/ARIB-STD-T104/Rel14/36/A36462-e00.pdf
ATIS	ATIS.3GPP.36.462V1400		14.0.0	02.05.2019 https://www.atis.org/docstore/
CCSA	CCSA TSD LTE 36.462		14.0.0	11.01.2019 http://www.ccsa.org.cn/ITU_spec/ITU-R/M.2012/M.2012-4/LTE/REL-14/CCSA-TSD-LTE-36462-e00.zip
ETSI	ETSI TS 136 462		14.0.0	11.04.2017 http://www.etsi.org/deliver/etsi_ts/136400_136499/136462/14.00.00_60/ts_136462v140000p.pdf
TSDSI	TSDSI STD T1.3GPP 36.462-14.0.0 V1.0.0		14.0.0	30.05.2019 https://members.tdsi.in/index.php/s/BxBT9C9F8KxobBg
TTA	TTAT.3G-36.462(R14-14.0.0)		14.0.0	10.05.2018 http://www.tta.or.kr/data/ttasDown.jsp?where=14688&pk_num=TTAT.3G-36.462(R14-14.0.0)

2.1.4.26 TS 36.463

Evolved Universal Terrestrial Radio Access Network (E-UTRAN) and Wireless LAN (WLAN); Xw application protocol (XwAP)

This document specifies the signalling procedures of the control plane between an eNB and WLAN Termination (WT). The Xw Application Protocol (XwAP) supports the functions of Xw interface by signalling procedures defined in this document.

SDO	Document No.	Version	Issued date	Location
Release 13				
ARIB	ARIB STD-T104-36.463		13.1.0	12.04.2018 http://www.arib.or.jp/english/html/overview/doc/STD-T104v5_20/2_T104/ARIB-STD-T104/Rel13/36/A36463-d10.pdf
ATIS	ATIS.3GPP.36.463V1310		13.1.0	02.05.2019 https://www.atis.org/docstore/
CCSA	CCSA TSD LTE 36.463		13.1.0	25.08.2016 http://www.ccsa.org.cn/ITU_spec/ITU-R/M.2012/M.2012-4/LTE/REL-13/CCSA-TSD-LTE-36463-d10.rar
ETSI	ETSI TS 136 463		13.1.0	25.08.2016 http://www.etsi.org/deliver/etsi_ts/136400_136499/136463/13.01.00_60/ts_136463v130100p.pdf
TSDSI	TSDSI STD T1.3GPP 36.463-13.1.0 V1.0.0		13.1.0	30.05.2019 https://members.tdsi.in/index.php/s/BxBT9C9F8KxobBg
TTA	TTAT.3G-36.463(R13-13.1.0)		13.1.0	06.07.2017 http://www.tta.or.kr/data/ttasDown.jsp?where=14688&pk_num=TTAT.3G-36.463(R13-13.1.0)
Release 14				
ARIB	ARIB STD-T104-36.463		14.2.0	12.04.2018 http://www.arib.or.jp/english/html/overview/doc/STD-T104v5_20/2_T104/ARIB-STD-T104/Rel14/36/A36463-e20.pdf
ATIS	ATIS.3GPP.36.463V1420		14.2.0	02.05.2019 https://www.atis.org/docstore/
CCSA	CCSA TSD LTE 36.463		14.2.0	11.01.2019 http://www.ccsa.org.cn/ITU_spec/ITU-R/M.2012/M.2012-4/LTE/REL-14/CCSA-TSD-LTE-36463-e20.zip
ETSI	ETSI TS 136 463		14.2.0	24.08.2017 http://www.etsi.org/deliver/etsi_ts/136400_136499/136463/14.02.00_60/ts_136463v140200p.pdf

TSDSI	TSDSI STD T1.3GPP 36.463-14.2.0 V1.0.0	14.2.0	30.05.2019	https://members.tdsi.in/index.php/s/BxBT9C9F8KxobBg
TTA	TTAT.3G-36.463(R14-14.2.0)	14.2.0	10.05.2018	http://www.tta.or.kr/data/ttasDown.jsp?where=14688&pk_num=TTAT.3G-36.463(R14-14.2.0)

2.1.4.27 TS 36.464

Evolved Universal Terrestrial Radio Access Network (E-UTRAN) and Wireless LAN (WLAN); Xw data transport

This document specifies the standards for user data transport protocols and related signalling protocols to establish user plane transport bearers over the Xw interface for LTE/WLAN Aggregation (LWA).

SDO	Document No.	Version	Issued date	Location	
Release 13					
ARIB	ARIB STD-T104-36.464		13.3.0	12.04.2018	http://www.arib.or.jp/english/html/overview/doc/STD-T104v5_20/2_T104/ARIB-STD-T104/Rel13/36/A36464-d30.pdf
ATIS	ATIS.3GPP.36.464V1330		13.3.0	02.05.2019	https://www.atis.org/docstore/
CCSA	CCSA TSD LTE 36.464		13.2.0	18.10.2017	http://www.ccsa.org.cn/ITU_spec/ITU-R/M.2012/M.2012-4/LTE/REL-13/CCSA-TSD-LTE-36464-d20.rar
ETSI	ETSI TS 136 464		13.3.0	18.10.2017	http://www.etsi.org/deliver/etsi_ts/136400_136499/136464/13.03.00_60/ts_136464v130300p.pdf
TSDSI	TSDSI STD T1.3GPP 36.464-13.3.0 V1.0.0		13.3.0	30.05.2019	https://members.tdsi.in/index.php/s/BxBT9C9F8KxobBg
TTA	TTAT.3G-36.464(R13-13.3.0)		13.3.0	10.05.2018	http://www.tta.or.kr/data/ttasDown.jsp?where=14688&pk_num=TTAT.3G-36.464(R13-13.3.0)
Release 14					
ARIB	ARIB STD-T104-36.464		14.2.0	12.04.2018	http://www.arib.or.jp/english/html/overview/doc/STD-T104v5_20/2_T104/ARIB-STD-T104/Rel14/36/A36464-e20.pdf
ATIS	ATIS.3GPP.36.464V1420		14.2.0	02.05.2019	https://www.atis.org/docstore/
CCSA	CCSA TSD LTE 36.464		14.2.0	11.01.2019	http://www.ccsa.org.cn/ITU_spec/ITU-R/M.2012/M.2012-4/LTE/REL-14/CCSA-TSD-LTE-36464-e20.zip
ETSI	ETSI TS 136 464		14.2.0	18.10.2017	http://www.etsi.org/deliver/etsi_ts/136400_136499/136464/14.02.00_60/ts_136464v140200p.pdf
TSDSI	TSDSI STD T1.3GPP 36.464-14.2.0 V1.0.0		14.2.0	30.05.2019	https://members.tdsi.in/index.php/s/BxBT9C9F8KxobBg
TTA	TTAT.3G-36.464(R14-14.2.0)		14.2.0	10.05.2018	http://www.tta.or.kr/data/ttasDown.jsp?where=14688&pk_num=TTAT.3G-36.464(R14-14.2.0)

2.1.4.28 TS 36.465

Evolved Universal Terrestrial Radio Access Network (E-UTRAN) and Wireless LAN (WLAN); Xw interface user plane protocol

This document specifies the Xw user plane protocol being used over the Xw interface for LTE/WLAN Aggregation (LWA).

SDO	Document No.	Version	Issued date	Location	
Release 13					
ARIB	ARIB STD-T104-36.465		13.2.0	12.04.2018	http://www.arib.or.jp/english/html/overview/doc/STD-T104v5_20/2_T104/ARIB-STD-T104/Rel13/36/A36465-d20.pdf
ATIS	ATIS.3GPP.36.465V1320		13.2.0	02.05.2019	https://www.atis.org/docstore/
CCSA	CCSA TSD LTE 36.465		13.1.0	19.10.2017	http://www.ccsa.org.cn/ITU_spec/ITU-R/M.2012/M.2012-4/LTE/REL-13/CCSA-TSD-LTE-36465-d10.rar
ETSI	ETSI TS 136 465		13.2.0	19.10.2017	http://www.etsi.org/deliver/etsi_ts/136400_136499/136465/13.02.00_60/ts_136465v130200p.pdf
TSDSI	TSDSI STD T1.3GPP 36.465-13.2.0 V1.0.0		13.2.0	30.05.2019	https://members.tdsi.in/index.php/s/BxBT9C9F8KxobBg
TTA	TTAT.3G-36.465(R13-13.2.0)		13.2.0	10.05.2018	http://www.tta.or.kr/data/ttasDown.jsp?where=14688&pk_num=TTAT.3G-36.465(R13-13.2.0)
Release 14					
ARIB	ARIB STD-T104-36.465		14.1.0	12.04.2018	http://www.arib.or.jp/english/html/overview/doc/STD-T104v5_20/2_T104/ARIB-STD-T104/Rel14/36/A36465-e10.pdf
ATIS	ATIS.3GPP.36.465V1410		14.1.0	02.05.2019	https://www.atis.org/docstore/
CCSA	CCSA TSD LTE 36.465		14.1.0	11.01.2019	http://www.ccsa.org.cn/ITU_spec/ITU-R/M.2012/M.2012-4/LTE/REL-14/CCSA-TSD-LTE-36465-e10.zip
ETSI	ETSI TS 136 465		14.1.0	19.10.2017	http://www.etsi.org/deliver/etsi_ts/136400_136499/136465/14.01.00_60/ts_136465v140100p.pdf
TSDSI	TSDSI STD T1.3GPP 36.465-14.1.0 V1.0.0		14.1.0	30.05.2019	https://members.tdsi.in/index.php/s/BxBT9C9F8KxobBg

TTA TTAT.3G-36.465(R14-14.1.0) 14.1.0 10.05.2018 [http://www.tta.or.kr/data/ttasDown.jsp?where=14688&pk_num=TTAT.3G-36.465\(R14-14.1.0\)](http://www.tta.or.kr/data/ttasDown.jsp?where=14688&pk_num=TTAT.3G-36.465(R14-14.1.0))

2.1.4.29 TS 25.460

UTRAN Iuant interface: General aspects and principles

This document is an introduction to the 3GPP TS 25.46x series of technical specifications that define the Iuant Interface for UMTS and E-UTRAN. The logical Iuant interface is a NodeB/eNodeB internal interface between the implementation specific O&M function and the RET antennas and TMAs control unit function of the NodeB/eNodeB.

SDO	Document No.	Version	Issued date	Location
Release 10				
ARIB	ARIB STD-T104-25.460		10.0.1 12.04.2018	http://www.arib.or.jp/english/html/overview/doc/STD-T104v5_20/2_T104/ARIB-STD-T104/Rel10/25/A25460-a01.pdf
ATIS	ATIS.3GPP.25.460V1001		10.0.1 02.05.2019	https://www.atis.org/docstore/
CCSA	CCSA TSD LTE 25.460		10.0.1 14.04.2011	http://www.ccsa.org.cn/ITU_spec/ITU-R/M.2012/M.2012-4/LTE/REL-10/CCSA-TSD-LTE-25460-a01.rar
ETSI	ETSI TS 125 460		10.0.1 14.04.2011	http://www.etsi.org/deliver/etsi_ts/125400_125499/125460/10.00.01_60/ts_125460v100001p.pdf
TSDSI	TSDSI STD T1.3GPP 25.460-10.0.1 V1.0.0		10.0.1 30.05.2019	https://members.tdsi.in/index.php/s/BxBT9C9F8KxobBg
TTA	TTAT.3G-25.460(R10-10.0.1)		10.0.1 26.08.2011	http://www.tta.or.kr/data/ttasDown.jsp?where=14688&pk_num=TTAT.3G-25.460(R10-10.0.1)
Release 11				
ARIB	ARIB STD-T104-25.460		11.0.0 12.04.2018	http://www.arib.or.jp/english/html/overview/doc/STD-T104v5_20/2_T104/ARIB-STD-T104/Rel11/25/A25460-b00.pdf
ATIS	ATIS.3GPP.25.460V1100		11.0.0 02.05.2019	https://www.atis.org/docstore/
CCSA	CCSA TSD LTE 25.460		11.0.0 10.10.2012	http://www.ccsa.org.cn/ITU_spec/ITU-R/M.2012/M.2012-4/LTE/REL-11/CCSA-TSD-LTE-25460-b00.rar
ETSI	ETSI TS 125 460		11.0.0 10.10.2012	http://www.etsi.org/deliver/etsi_ts/125400_125499/125460/11.00.00_60/ts_125460v110000p.pdf
TSDSI	TSDSI STD T1.3GPP 25.460-11.0.0 V1.0.0		11.0.0 30.05.2019	https://members.tdsi.in/index.php/s/BxBT9C9F8KxobBg
TTA	TTAT.3G-25.460(R11-11.0.0)		11.0.0 26.08.2013	http://www.tta.or.kr/data/ttasDown.jsp?where=14688&pk_num=TTAT.3G-25.460(R11-11.0.0)
Release 12				
ARIB	ARIB STD-T104-25.460		12.0.0 12.04.2018	http://www.arib.or.jp/english/html/overview/doc/STD-T104v5_20/2_T104/ARIB-STD-T104/Rel12/25/A25460-c00.pdf
ATIS	ATIS.3GPP.25.460V1200		12.0.0 02.05.2019	https://www.atis.org/docstore/
CCSA	CCSA TSD LTE 25.460		12.0.0 25.09.2014	http://www.ccsa.org.cn/ITU_spec/ITU-R/M.2012/M.2012-4/LTE/REL-12/CCSA-TSD-LTE-25460-c00.rar
ETSI	ETSI TS 125 460		12.0.0 25.09.2014	http://www.etsi.org/deliver/etsi_ts/125400_125499/125460/12.00.00_60/ts_125460v120000p.pdf
TSDSI	TSDSI STD T1.3GPP 25.460-12.0.0 V1.0.0		12.0.0 30.05.2019	https://members.tdsi.in/index.php/s/BxBT9C9F8KxobBg
TTA	TTAT.3G-25.460(R12-12.0.0)		12.0.0 09.04.2015	http://www.tta.or.kr/data/ttasDown.jsp?where=14688&pk_num=TTAT.3G-25.460(R12-12.0.0)
Release 13				
ARIB	ARIB STD-T104-25.460		13.0.0 12.04.2018	http://www.arib.or.jp/english/html/overview/doc/STD-T104v5_20/2_T104/ARIB-STD-T104/Rel13/25/A25460-d00.pdf
ATIS	ATIS.3GPP.25.460V1300		13.0.0 02.05.2019	https://www.atis.org/docstore/
CCSA	CCSA TSD LTE 25.460		13.0.0 21.01.2016	http://www.ccsa.org.cn/ITU_spec/ITU-R/M.2012/M.2012-4/LTE/REL-13/CCSA-TSD-LTE-25460-d00.rar
ETSI	ETSI TS 125 460		13.0.0 21.01.2016	http://www.etsi.org/deliver/etsi_ts/125400_125499/125460/13.00.00_60/ts_125460v130000p.pdf
TSDSI	TSDSI STD T1.3GPP 25.460-13.0.0 V1.0.0		13.0.0 30.05.2019	https://members.tdsi.in/index.php/s/BxBT9C9F8KxobBg
TTA	TTAT.3G-25.460(R13-13.0.0)		13.0.0 06.07.2017	http://www.tta.or.kr/data/ttasDown.jsp?where=14688&pk_num=TTAT.3G-25.460(R13-13.0.0)
Release 14				
ARIB	ARIB STD-T104-25.460		14.0.0 12.04.2018	http://www.arib.or.jp/english/html/overview/doc/STD-T104v5_20/2_T104/ARIB-STD-T104/Rel14/25/A25460-e00.pdf
ATIS	ATIS.3GPP.25.460V1400		14.0.0 02.05.2019	https://www.atis.org/docstore/
CCSA	CCSA TSD LTE 25.460		14.0.0 11.01.2019	http://www.ccsa.org.cn/ITU_spec/ITU-R/M.2012/M.2012-4/LTE/REL-14/CCSA-TSD-LTE-25460-e00.zip
ETSI	ETSI TS 125 460		14.0.0 06.04.2017	http://www.etsi.org/deliver/etsi_ts/125400_125499/125460/14.00.00_60/ts_125460v140000p.pdf

TSDSI	TSDSI STD T1.3GPP 25.460-14.0.0 V1.0.0	14.0.0	30.05.2019	https://members.tdsi.in/index.php/s/BxBT9C9F8KxobBg
TTA	TTAT.3G-25.460(R14-14.0.0)	14.0.0	10.05.2018	http://www.tta.or.kr/data/ttasDown.jsp?where=14688&pk_num=TTAT.3G-25.460(R14-14.0.0)

2.1.4.30 TS 25.461

UTRAN Iuant interface: Layer 1

This document specifies the standards allowed to implement layer 1 on the Iuant interface. The specification of transmission delay requirements and O&M requirements are not in the scope of this document.

SDO	Document No.	Version	Issued date	Location	
Release 10					
ARIB	ARIB STD-T104-25.461		10.3.0	12.04.2018	http://www.arib.or.jp/english/html/overview/doc/STD-T104v5_20/2_T104/ARIB-STD-T104/Rel10/25/A25461-a30.pdf
ATIS	ATIS.3GPP.25.461V1030		10.3.0	02.05.2019	https://www.atis.org/docstore/
CCSA	CCSA TSD LTE 25.461		10.3.0	10.01.2012	http://www.ccsa.org.cn/ITU_spec/ITU-R/M.2012/M.2012-4/LTE/REL-10/CCSA-TSD-LTE-25461-a30.rar
ETSI	ETSI TS 125 461		10.3.0	10.01.2012	http://www.etsi.org/deliver/etsi_ts/125400_125499/125461/10.03.00_60/ts_125461v100300p.pdf
TSDSI	TSDSI STD T1.3GPP 25.461-10.3.0 V1.0.0		10.3.0	30.05.2019	https://members.tdsi.in/index.php/s/BxBT9C9F8KxobBg
TTA	TTAT.3G-25.461(R10-10.3.0)		10.3.0	22.08.2012	http://www.tta.or.kr/data/ttasDown.jsp?where=14688&pk_num=TTAT.3G-25.461(R10-10.3.0)
Release 11					
ARIB	ARIB STD-T104-25.461		11.2.0	12.04.2018	http://www.arib.or.jp/english/html/overview/doc/STD-T104v5_20/2_T104/ARIB-STD-T104/Rel11/25/A25461-b20.pdf
ATIS	ATIS.3GPP.25.461V1120		11.2.0	02.05.2019	https://www.atis.org/docstore/
CCSA	CCSA TSD LTE 25.461		11.2.0	16.01.2013	http://www.ccsa.org.cn/ITU_spec/ITU-R/M.2012/M.2012-4/LTE/REL-11/CCSA-TSD-LTE-25461-b20.rar
ETSI	ETSI TS 125 461		11.2.0	16.01.2013	http://www.etsi.org/deliver/etsi_ts/125400_125499/125461/11.02.00_60/ts_125461v110200p.pdf
TSDSI	TSDSI STD T1.3GPP 25.461-11.2.0 V1.0.0		11.2.0	30.05.2019	https://members.tdsi.in/index.php/s/BxBT9C9F8KxobBg
TTA	TTAT.3G-25.461(R11-11.2.0)		11.2.0	26.08.2013	http://www.tta.or.kr/data/ttasDown.jsp?where=14688&pk_num=TTAT.3G-25.461(R11-11.2.0)
Release 12					
ARIB	ARIB STD-T104-25.461		12.1.0	12.04.2018	http://www.arib.or.jp/english/html/overview/doc/STD-T104v5_20/2_T104/ARIB-STD-T104/Rel12/25/A25461-c10.pdf
ATIS	ATIS.3GPP.25.461V1210		12.1.0	02.05.2019	https://www.atis.org/docstore/
CCSA	CCSA TSD LTE 25.461		12.1.0	25.09.2014	http://www.ccsa.org.cn/ITU_spec/ITU-R/M.2012/M.2012-4/LTE/REL-12/CCSA-TSD-LTE-25461-c10.rar
ETSI	ETSI TS 125 461		12.1.0	25.09.2014	http://www.etsi.org/deliver/etsi_ts/125400_125499/125461/12.01.00_60/ts_125461v120100p.pdf
TSDSI	TSDSI STD T1.3GPP 25.461-12.1.0 V1.0.0		12.1.0	30.05.2019	https://members.tdsi.in/index.php/s/BxBT9C9F8KxobBg
TTA	TTAT.3G-25.461(R12-12.1.0)		12.1.0	09.04.2015	http://www.tta.or.kr/data/ttasDown.jsp?where=14688&pk_num=TTAT.3G-25.461(R12-12.1.0)
Release 13					
ARIB	ARIB STD-T104-25.461		13.1.0	12.04.2018	http://www.arib.or.jp/english/html/overview/doc/STD-T104v5_20/2_T104/ARIB-STD-T104/Rel13/25/A25461-d10.pdf
ATIS	ATIS.3GPP.25.461V1310		13.1.0	02.05.2019	https://www.atis.org/docstore/
CCSA	CCSA TSD LTE 25.461		13.1.0	11.05.2016	http://www.ccsa.org.cn/ITU_spec/ITU-R/M.2012/M.2012-4/LTE/REL-13/CCSA-TSD-LTE-25461-d10.rar
ETSI	ETSI TS 125 461		13.1.0	11.05.2016	http://www.etsi.org/deliver/etsi_ts/125400_125499/125461/13.01.00_60/ts_125461v130100p.pdf
TSDSI	TSDSI STD T1.3GPP 25.461-13.1.0 V1.0.0		13.1.0	30.05.2019	https://members.tdsi.in/index.php/s/BxBT9C9F8KxobBg
TTA	TTAT.3G-25.461(R13-13.1.0)		13.1.0	06.07.2017	http://www.tta.or.kr/data/ttasDown.jsp?where=14688&pk_num=TTAT.3G-25.461(R13-13.1.0)
Release 14					
ARIB	ARIB STD-T104-25.461		14.1.0	12.04.2018	http://www.arib.or.jp/english/html/overview/doc/STD-T104v5_20/2_T104/ARIB-STD-T104/Rel14/25/A25461-e10.pdf
ATIS	ATIS.3GPP.25.461V1410		14.1.0	02.05.2019	https://www.atis.org/docstore/
CCSA	CCSA TSD LTE 25.461		14.1.0	11.01.2019	http://www.ccsa.org.cn/ITU_spec/ITU-R/M.2012/M.2012-4/LTE/REL-14/CCSA-TSD-LTE-25461-e10.zip
ETSI	ETSI TS 125 461		14.1.0	19.05.2017	http://www.etsi.org/deliver/etsi_ts/125400_125499/125461/14.01.00_60/ts_125461v140100p.pdf

TSDSI	TSDSI STD T1.3GPP 25.461-14.1.0 V1.0.0	14.1.0	30.05.2019	https://members.tdsi.in/index.php/s/BxBT9C9F8KxobBg
TTA	TTAT.3G-25.461(R14-14.1.0)	14.1.0	10.05.2018	http://www.tta.or.kr/data/ttasDown.jsp?where=14688&pk_num=TTAT.3G-25.461(R14-14.1.0)

2.1.4.31 TS 25.462

UTRAN Iuant interface: Signalling transport

This document specifies the signalling transport related to RETAP and TMAAP signalling to be used across the Iuant interface. The logical Iuant interface is a NodeB/eNodeB internal interface between the implementation specific O&M function and the RET antennas and TMAs control unit function of the NodeB/eNodeB.

SDO	Document No.	Version	Issued date	Location	
Release 10					
ARIB	ARIB STD-T104-25.462		10.1.0	12.04.2018	http://www.arib.or.jp/english/html/overview/doc/STD-T104v5_20/2_T104/ARIB-STD-T104/Rel10/25/A25462-a10.pdf
ATIS	ATIS.3GPP.25.462V1010		10.1.0	02.05.2019	https://www.atis.org/docstore/
CCSA	CCSA TSD LTE 25.462		10.1.0	30.06.2011	http://www.ccsa.org.cn/ITU_spec/ITU-R/M.2012/M.2012-4/LTE/REL-10/CCSA-TSD-LTE-25462-a10.rar
ETSI	ETSI TS 125 462		10.1.0	30.06.2011	http://www.etsi.org/deliver/etsi_ts/125400_125499/125462/10.01.00_60/ts_125462v100100p.pdf
TSDSI	TSDSI STD T1.3GPP 25.462-10.1.0 V1.0.0		10.1.0	30.05.2019	https://members.tdsi.in/index.php/s/BxBT9C9F8KxobBg
TTA	TTAT.3G-25.462(R10-10.1.0)		10.1.0	26.08.2011	http://www.tta.or.kr/data/ttasDown.jsp?where=14688&pk_num=TTAT.3G-25.462(R10-10.1.0)
Release 11					
ARIB	ARIB STD-T104-25.462		11.0.0	12.04.2018	http://www.arib.or.jp/english/html/overview/doc/STD-T104v5_20/2_T104/ARIB-STD-T104/Rel11/25/A25462-b00.pdf
ATIS	ATIS.3GPP.25.462V1100		11.0.0	02.05.2019	https://www.atis.org/docstore/
CCSA	CCSA TSD LTE 25.462		11.0.0	10.10.2012	http://www.ccsa.org.cn/ITU_spec/ITU-R/M.2012/M.2012-4/LTE/REL-11/CCSA-TSD-LTE-25462-b00.rar
ETSI	ETSI TS 125 462		11.0.0	10.10.2012	http://www.etsi.org/deliver/etsi_ts/125400_125499/125462/11.00.00_60/ts_125462v110000p.pdf
TSDSI	TSDSI STD T1.3GPP 25.462-11.0.0 V1.0.0		11.0.0	30.05.2019	https://members.tdsi.in/index.php/s/BxBT9C9F8KxobBg
TTA	TTAT.3G-25.462(R11-11.0.0)		11.0.0	26.08.2013	http://www.tta.or.kr/data/ttasDown.jsp?where=14688&pk_num=TTAT.3G-25.462(R11-11.0.0)
Release 12					
ARIB	ARIB STD-T104-25.462		12.0.0	12.04.2018	http://www.arib.or.jp/english/html/overview/doc/STD-T104v5_20/2_T104/ARIB-STD-T104/Rel12/25/A25462-c00.pdf
ATIS	ATIS.3GPP.25.462V1200		12.0.0	02.05.2019	https://www.atis.org/docstore/
CCSA	CCSA TSD LTE 25.462		12.0.0	25.09.2014	http://www.ccsa.org.cn/ITU_spec/ITU-R/M.2012/M.2012-4/LTE/REL-12/CCSA-TSD-LTE-25462-c00.rar
ETSI	ETSI TS 125 462		12.0.0	25.09.2014	http://www.etsi.org/deliver/etsi_ts/125400_125499/125462/12.00.00_60/ts_125462v120000p.pdf
TSDSI	TSDSI STD T1.3GPP 25.462-12.0.0 V1.0.0		12.0.0	30.05.2019	https://members.tdsi.in/index.php/s/BxBT9C9F8KxobBg
TTA	TTAT.3G-25.462(R12-12.0.0)		12.0.0	09.04.2015	http://www.tta.or.kr/data/ttasDown.jsp?where=14688&pk_num=TTAT.3G-25.462(R12-12.0.0)
Release 13					
ARIB	ARIB STD-T104-25.462		13.0.0	12.04.2018	http://www.arib.or.jp/english/html/overview/doc/STD-T104v5_20/2_T104/ARIB-STD-T104/Rel13/25/A25462-d00.pdf
ATIS	ATIS.3GPP.25.462V1300		13.0.0	02.05.2019	https://www.atis.org/docstore/
CCSA	CCSA TSD LTE 25.462		13.0.0	19.01.2016	http://www.ccsa.org.cn/ITU_spec/ITU-R/M.2012/M.2012-4/LTE/REL-13/CCSA-TSD-LTE-25462-d00.rar
ETSI	ETSI TS 125 462		13.0.0	19.01.2016	http://www.etsi.org/deliver/etsi_ts/125400_125499/125462/13.00.00_60/ts_125462v130000p.pdf
TSDSI	TSDSI STD T1.3GPP 25.462-13.0.0 V1.0.0		13.0.0	30.05.2019	https://members.tdsi.in/index.php/s/BxBT9C9F8KxobBg
TTA	TTAT.3G-25.462(R13-13.0.0)		13.0.0	06.07.2017	http://www.tta.or.kr/data/ttasDown.jsp?where=14688&pk_num=TTAT.3G-25.462(R13-13.0.0)
Release 14					
ARIB	ARIB STD-T104-25.462		14.0.0	12.04.2018	http://www.arib.or.jp/english/html/overview/doc/STD-T104v5_20/2_T104/ARIB-STD-T104/Rel14/25/A25462-e00.pdf
ATIS	ATIS.3GPP.25.462V1400		14.0.0	02.05.2019	https://www.atis.org/docstore/
CCSA	CCSA TSD LTE 25.462		14.0.0	11.01.2019	http://www.ccsa.org.cn/ITU_spec/ITU-R/M.2012/M.2012-4/LTE/REL-14/CCSA-TSD-LTE-25462-e00.zip

ETSI	ETSI TS 125 462	14.0.0	04.04.2017	http://www.etsi.org/deliver/etsi_ts/125400_125499/125462/14.00.00_60/ts_125462v140000p.pdf
TSDSI	TSDSI STD T1.3GPP 25.462-14.0.0 V1.0.0	14.0.0	30.05.2019	https://members.tdsi.in/index.php/s/BxBT9C9F8KxobBg
TTA	TTAT.3G-25.462(R14-14.0.0)	14.0.0	10.05.2018	http://www.tta.or.kr/data/ttasDown.jsp?where=14688&pk_num=TTAT.3G-25.462(R14-14.0.0)

2.1.4.32 TS 25.466

UTRAN Iuant interface: Application part

This document specifies the Remote Electrical Tilting Application Part (RETAP) between the implementation specific O&M transport function and the RET Antenna Control unit function of the NodeB/eNodeB. The document also specifies the Tower Mounted Amplifier Application Part (TMAAP) between the implementation specific O&M transport function and the TMA control function of the NodeB/eNodeB. It defines the Iuant interface and its associated signalling procedures.

SDO	Document No.	Version	Issued date	Location
Release 10				
ARIB	ARIB STD-T104-25.466		10.3.0	12.04.2018 http://www.arib.or.jp/english/html/overview/doc/STD-T104v5_20/2_T104/ARIB-STD-T104/Rel10/25/A25466-a30.pdf
ATIS	ATIS.3GPP.25.466V1030		10.3.0	02.05.2019 https://www.atis.org/docstore/
CCSA	CCSA TSD LTE 25.466		10.3.0	10.01.2012 http://www.ccsa.org.cn/ITU_spec/ITU-R/M.2012/M.2012-4/LTE/REL-10/CCSA-TSD-LTE-25466-a30.rar
ETSI	ETSI TS 125 466		10.3.0	10.01.2012 http://www.etsi.org/deliver/etsi_ts/125400_125499/125466/10.03.00_60/ts_125466v100300p.pdf
TSDSI	TSDSI STD T1.3GPP 25.466-10.3.0 V1.0.0		10.3.0	30.05.2019 https://members.tdsi.in/index.php/s/BxBT9C9F8KxobBg
TTA	TTAT.3G-25.466(R10-10.3.0)		10.3.0	22.08.2012 http://www.tta.or.kr/data/ttasDown.jsp?where=14688&pk_num=TTAT.3G-25.466(R10-10.3.0)
Release 11				
ARIB	ARIB STD-T104-25.466		11.3.0	12.04.2018 http://www.arib.or.jp/english/html/overview/doc/STD-T104v5_20/2_T104/ARIB-STD-T104/Rel11/25/A25466-b30.pdf
ATIS	ATIS.3GPP.25.466V1130		11.3.0	02.05.2019 https://www.atis.org/docstore/
CCSA	CCSA TSD LTE 25.466		11.3.0	16.01.2013 http://www.ccsa.org.cn/ITU_spec/ITU-R/M.2012/M.2012-4/LTE/REL-11/CCSA-TSD-LTE-25466-b30.rar
ETSI	ETSI TS 125 466		11.3.0	16.01.2013 http://www.etsi.org/deliver/etsi_ts/125400_125499/125466/11.03.00_60/ts_125466v110300p.pdf
TSDSI	TSDSI STD T1.3GPP 25.466-11.3.0 V1.0.0		11.3.0	30.05.2019 https://members.tdsi.in/index.php/s/BxBT9C9F8KxobBg
TTA	TTAT.3G-25.466(R11-11.3.0)		11.3.0	26.08.2013 http://www.tta.or.kr/data/ttasDown.jsp?where=14688&pk_num=TTAT.3G-25.466(R11-11.3.0)
Release 12				
ARIB	ARIB STD-T104-25.466		12.2.0	12.04.2018 http://www.arib.or.jp/english/html/overview/doc/STD-T104v5_20/2_T104/ARIB-STD-T104/Rel12/25/A25466-c20.pdf
ATIS	ATIS.3GPP.25.466V1220		12.2.0	02.05.2019 https://www.atis.org/docstore/
CCSA	CCSA TSD LTE 25.466		12.2.0	08.04.2015 http://www.ccsa.org.cn/ITU_spec/ITU-R/M.2012/M.2012-4/LTE/REL-12/CCSA-TSD-LTE-25466-c20.rar
ETSI	ETSI TS 125 466		12.2.0	08.04.2015 http://www.etsi.org/deliver/etsi_ts/125400_125499/125466/12.02.00_60/ts_125466v120200p.pdf
TSDSI	TSDSI STD T1.3GPP 25.466-12.2.0 V1.0.0		12.2.0	30.05.2019 https://members.tdsi.in/index.php/s/BxBT9C9F8KxobBg
TTA	TTAT.3G-25.466(R12-12.2.0)		12.2.0	06.07.2017 http://www.tta.or.kr/data/ttasDown.jsp?where=14688&pk_num=TTAT.3G-25.466(R12-12.2.0)
Release 13				
ARIB	ARIB STD-T104-25.466		13.2.0	12.04.2018 http://www.arib.or.jp/english/html/overview/doc/STD-T104v5_20/2_T104/ARIB-STD-T104/Rel13/25/A25466-d20.pdf
ATIS	ATIS.3GPP.25.466V1320		13.2.0	02.05.2019 https://www.atis.org/docstore/
CCSA	CCSA TSD LTE 25.466		13.1.0	18.10.2017 http://www.ccsa.org.cn/ITU_spec/ITU-R/M.2012/M.2012-4/LTE/REL-13/CCSA-TSD-LTE-25466-d10.rar
ETSI	ETSI TS 125 466		13.2.0	18.10.2017 http://www.etsi.org/deliver/etsi_ts/125400_125499/125466/13.02.00_60/ts_125466v130200p.pdf
TSDSI	TSDSI STD T1.3GPP 25.466-13.2.0 V1.0.0		13.2.0	30.05.2019 https://members.tdsi.in/index.php/s/BxBT9C9F8KxobBg
TTA	TTAT.3G-25.466(R13-13.2.0)		13.2.0	10.05.2018 http://www.tta.or.kr/data/ttasDown.jsp?where=14688&pk_num=TTAT.3G-25.466(R13-13.2.0)
Release 14				
ARIB	ARIB STD-T104-25.466		14.2.0	12.04.2018 http://www.arib.or.jp/english/html/overview/doc/STD-T104v5_20/2_T104/ARIB-STD-T104/Rel14/25/A25466-e20.pdf

ATIS	ATIS.3GPP.25.466V1420	14.2.0	02.05.2019	https://www.atis.org/docstore/
CCSA	CCSA TSD LTE 25.466	14.2.0	11.01.2019	http://www.ccsa.org.cn/ITU_spec/ITU-R/M.2012/M.2012-4/LTE/REL-14/CCSA-TSD-LTE-25466-e20.zip
ETSI	ETSI TS 125 466	14.2.0	18.10.2017	http://www.etsi.org/deliver/etsi_ts/125400_125499/125466/14.02.00_60/ts_125466v140200p.pdf
TSDSI	TSDSI STD T1.3GPP 25.466-14.2.0 V1.0.0	14.2.0	30.05.2019	https://members.tdsi.in/index.php/s/BxBT9C9F8KxobBg
TTA	TTAT.3G-25.466(R14-14.2.0)	14.2.0	10.05.2018	http://www.tta.or.kr/data/ttasDown.jsp?where=14688&pk_num=TTAT.3G-25.466(R14-14.2.0)

2.1.5 Radio-frequency aspects

2.1.5.1 TS 36.101

Evolved Universal Terrestrial Radio Access (E-UTRA); User Equipment (UE) radio transmission and reception

This document establishes the minimum RF characteristics and minimum performance requirements for E-UTRA User Equipment (UE).

SDO	Document No.	Version	Issued date	Location	
Release 10					
ARIB	ARIB STD-T104-36.101		10.25.0	12.04.2018	http://www.arib.or.jp/english/html/overview/doc/STD-T104v5_20/2_T104/ARIB-STD-T104/Rel10/36/A36101-ap0.pdf
ATIS	ATIS.3GPP.36.101V10250		10.25.0	02.05.2019	https://www.atis.org/docstore/
CCSA	CCSA TSD LTE 36.101		10.24.1	09.11.2017	http://www.ccsa.org.cn/ITU_spec/ITU-R/M.2012/M.2012-4/LTE/REL-10/CCSA-TSD-LTE-36101-ao1.rar
ETSI	ETSI TS 136 101		10.25.0	09.11.2017	http://www.etsi.org/deliver/etsi_ts/136100_136199/136101/10.25.00_60/ts_136101v102500p.pdf
TSDSI	TSDSI STD T1.3GPP 36.101-10.25.0 V1.0.0		10.25.0	30.05.2019	https://members.tdsi.in/index.php/s/BxBT9C9F8KxobBg
TTA	TTAT.3G-36.101(R10-10.25.0)		10.25.0	10.05.2018	http://www.tta.or.kr/data/ttasDown.jsp?where=14688&pk_num=TTAT.3G-36.101(R10-10.25.0)
Release 11					
ARIB	ARIB STD-T104-36.101		11.22.0	12.04.2018	http://www.arib.or.jp/english/html/overview/doc/STD-T104v5_20/2_T104/ARIB-STD-T104/Rel11/36/A36101-bm0.pdf
ATIS	ATIS.3GPP.36.101V11220		11.22.0	02.05.2019	https://www.atis.org/docstore/
CCSA	CCSA TSD LTE 36.101		11.20.0	29.01.2018	http://www.ccsa.org.cn/ITU_spec/ITU-R/M.2012/M.2012-4/LTE/REL-11/CCSA-TSD-LTE-36101-bk0.rar
ETSI	ETSI TS 136 101		11.22.0	29.01.2018	http://www.etsi.org/deliver/etsi_ts/136100_136199/136101/11.22.00_60/ts_136101v112200p.pdf
TSDSI	TSDSI STD T1.3GPP 36.101-11.22.0 V1.0.0		11.22.0	30.05.2019	https://members.tdsi.in/index.php/s/BxBT9C9F8KxobBg
TTA	TTAT.3G-36.101(R11-11.22.0)		11.22.0	09.05.2019	http://www.tta.or.kr/data/ttasDown.jsp?where=14688&pk_num=TTAT.3G-36.101(R11-11.22.0)
Release 12					
ARIB	ARIB STD-T104-36.101		12.18.0	12.04.2018	http://www.arib.or.jp/english/html/overview/doc/STD-T104v5_20/2_T104/ARIB-STD-T104/Rel12/36/A36101-ci0.pdf
ATIS	ATIS.3GPP.36.101V12180		12.18.0	02.05.2019	https://www.atis.org/docstore/
CCSA	CCSA TSD LTE 36.101		12.16.0	29.01.2018	http://www.ccsa.org.cn/ITU_spec/ITU-R/M.2012/M.2012-4/LTE/REL-12/CCSA-TSD-LTE-36101-cg0.rar
ETSI	ETSI TS 136 101		12.18.0	29.01.2018	http://www.etsi.org/deliver/etsi_ts/136100_136199/136101/12.18.00_60/ts_136101v121800p.pdf
TSDSI	TSDSI STD T1.3GPP 36.101-12.18.0 V1.0.0		12.18.0	30.05.2019	https://members.tdsi.in/index.php/s/BxBT9C9F8KxobBg
TTA	TTAT.3G-36.101(R12-12.18.0)		12.18.0	09.05.2019	http://www.tta.or.kr/data/ttasDown.jsp?where=14688&pk_num=TTAT.3G-36.101(R12-12.18.0)
Release 13					
ARIB	ARIB STD-T104-36.101		13.10.0	12.04.2018	http://www.arib.or.jp/english/html/overview/doc/STD-T104v5_20/2_T104/ARIB-STD-T104/Rel13/36/A36101-da0.pdf
ATIS	ATIS.3GPP.36.101V13100		13.10.0	02.05.2019	https://www.atis.org/docstore/
CCSA	CCSA TSD LTE 36.101		13.8.0	29.01.2018	http://www.ccsa.org.cn/ITU_spec/ITU-R/M.2012/M.2012-4/LTE/REL-13/CCSA-TSD-LTE-36101-d80.rar
ETSI	ETSI TS 136 101		13.10.0	29.01.2018	http://www.etsi.org/deliver/etsi_ts/136100_136199/136101/13.10.00_60/ts_136101v131000p.pdf
TSDSI	TSDSI STD T1.3GPP 36.101-13.10.0 V1.0.0		13.10.0	30.05.2019	https://members.tdsi.in/index.php/s/BxBT9C9F8KxobBg
TTA	TTAT.3G-36.101(R13-13.10.0)		13.10.0	09.05.2019	http://www.tta.or.kr/data/ttasDown.jsp?where=14688&pk_num=TTAT.3G-36.101(R13-13.10.0)

Release 14

ARIB	ARIB STD-T104-36.101	14.6.0	12.04.2018	http://www.arib.or.jp/english/html/overview/doc/STD-T104v5_20/2_T104/ARIB-STD-T104/Rel14/36/A36101-e60.pdf
ATIS	ATIS.3GPP.36.101V1460	14.6.0	02.05.2019	https://www.atis.org/docstore/
CCSA	CCSA TSD LTE 36.101	14.6.0	11.01.2019	http://www.ccsa.org.cn/ITU_spec/ITU-R/M.2012/M.2012-4/LTE/REL-14/CCSA-TSD-LTE-36101-e60.zip
ETSI	ETSI TS 136 101	14.6.0	29.01.2018	http://www.etsi.org/deliver/etsi_ts/136100_136199/136101/14.06.00_60/ts_136101v140600p.pdf
TSDSI	TSDSI STD T1.3GPP 36.101-14.6.0 V1.0.0	14.6.0	30.05.2019	https://members.tdsi.in/index.php/s/BxBT9C9F8KxobBg
TTA	TTAT.3G-36.101(R14-14.6.0)	14.6.0	09.05.2019	http://www.tta.or.kr/data/ttasDown.jsp?where=14688&pk_num=TTAT.3G-36.101(R14-14.6.0)

2.1.5.2 TS 36.104

Evolved Universal Terrestrial Radio Access (E-UTRA); Base Station (BS) radio transmission and reception

This document establishes the minimum RF characteristics and minimum performance requirements of E-UTRA Base Station (BS).

SDO	Document No.	Version	Issued date	Location
Release 10				
ARIB	ARIB STD-T104-36.104		10.12.0	12.04.2018 http://www.arib.or.jp/english/html/overview/doc/STD-T104v5_20/2_T104/ARIB-STD-T104/Rel10/36/A36104-ac0.pdf
ATIS	ATIS.3GPP.36.104V10121		10.12.1	02.05.2019 https://www.atis.org/docstore/
CCSA	CCSA TSD LTE 36.104		10.12.0	28.03.2018 http://www.ccsa.org.cn/ITU_spec/ITU-R/M.2012/M.2012-4/LTE/REL-10/CCSA-TSD-LTE-36104-ac0.rar
ETSI	ETSI TS 136 104		10.12.1	28.03.2018 http://www.etsi.org/deliver/etsi_ts/136100_136199/136104/10.12.01_60/ts_136104v101201p.pdf
TSDSI	TSDSI STD T1.3GPP 36.104-10.12.1 V1.0.0		10.12.1	30.05.2019 https://members.tdsi.in/index.php/s/BxBT9C9F8KxobBg
TTA	TTAT.3G-36.104(R10-10.12.1)		10.12.1	09.05.2019 http://www.tta.or.kr/data/ttasDown.jsp?where=14688&pk_num=TTAT.3G-36.104(R10-10.12.1)
Release 11				
ARIB	ARIB STD-T104-36.104		11.16.0	12.04.2018 http://www.arib.or.jp/english/html/overview/doc/STD-T104v5_20/2_T104/ARIB-STD-T104/Rel11/36/A36104-bg0.pdf
ATIS	ATIS.3GPP.36.104V11160		11.16.0	02.05.2019 https://www.atis.org/docstore/
CCSA	CCSA TSD LTE 36.104		11.16.0	26.01.2017 http://www.ccsa.org.cn/ITU_spec/ITU-R/M.2012/M.2012-4/LTE/REL-11/CCSA-TSD-LTE-36104-bg0.rar
ETSI	ETSI TS 136 104		11.16.0	26.01.2017 http://www.etsi.org/deliver/etsi_ts/136100_136199/136104/11.16.00_60/ts_136104v111600p.pdf
TSDSI	TSDSI STD T1.3GPP 36.104-11.16.0 V1.0.0		11.16.0	30.05.2019 https://members.tdsi.in/index.php/s/BxBT9C9F8KxobBg
TTA	TTAT.3G-36.104(R11-11.16.0)		11.16.0	10.05.2018 http://www.tta.or.kr/data/ttasDown.jsp?where=14688&pk_num=TTAT.3G-36.104(R11-11.16.0)
Release 12				
ARIB	ARIB STD-T104-36.104		12.12.0	12.04.2018 http://www.arib.or.jp/english/html/overview/doc/STD-T104v5_20/2_T104/ARIB-STD-T104/Rel12/36/A36104-cc0.pdf
ATIS	ATIS.3GPP.36.104V12120		12.12.0	02.05.2019 https://www.atis.org/docstore/
CCSA	CCSA TSD LTE 36.104		12.12.0	26.01.2017 http://www.ccsa.org.cn/ITU_spec/ITU-R/M.2012/M.2012-4/LTE/REL-12/CCSA-TSD-LTE-36104-cc0.rar
ETSI	ETSI TS 136 104		12.12.0	26.01.2017 http://www.etsi.org/deliver/etsi_ts/136100_136199/136104/12.12.00_60/ts_136104v121200p.pdf
TSDSI	TSDSI STD T1.3GPP 36.104-12.12.0 V1.0.0		12.12.0	30.05.2019 https://members.tdsi.in/index.php/s/BxBT9C9F8KxobBg
TTA	TTAT.3G-36.104(R12-12.12.0)		12.12.0	10.05.2018 http://www.tta.or.kr/data/ttasDown.jsp?where=14688&pk_num=TTAT.3G-36.104(R12-12.12.0)
Release 13				
ARIB	ARIB STD-T104-36.104		13.10.0	12.04.2018 http://www.arib.or.jp/english/html/overview/doc/STD-T104v5_20/2_T104/ARIB-STD-T104/Rel13/36/A36104-da0.pdf
ATIS	ATIS.3GPP.36.104V13100		13.10.0	02.05.2019 https://www.atis.org/docstore/
CCSA	CCSA TSD LTE 36.104		13.8.0	25.01.2018 http://www.ccsa.org.cn/ITU_spec/ITU-R/M.2012/M.2012-4/LTE/REL-13/CCSA-TSD-LTE-36104-d80.rar
ETSI	ETSI TS 136 104		13.10.0	25.01.2018 http://www.etsi.org/deliver/etsi_ts/136100_136199/136104/13.10.00_60/ts_136104v131000p.pdf
TSDSI	TSDSI STD T1.3GPP 36.104-13.10.0 V1.0.0		13.10.0	30.05.2019 https://members.tdsi.in/index.php/s/BxBT9C9F8KxobBg
TTA	TTAT.3G-36.104(R13-13.10.0)		13.10.0	09.05.2019 http://www.tta.or.kr/data/ttasDown.jsp?where=14688&pk_num=TTAT.3G-36.104(R13-13.10.0)
Release 14				
ARIB	ARIB STD-T104-36.104		14.6.0	12.04.2018 http://www.arib.or.jp/english/html/overview/doc/STD-T104v5_20/2_T104/ARIB-STD-T104/Rel14/36/A36104-e60.pdf
ATIS	ATIS.3GPP.36.104V1460		14.6.0	02.05.2019 https://www.atis.org/docstore/

CCSA	CCSA TSD LTE 36.104	14.6.0	11.01.2019	http://www.ccsa.org.cn/ITU_spec/ITU-R/M.2012/M.2012-4/LTE/REL-14/CCSA-TSD-LTE-36104-e60.zip
ETSI	ETSI TS 136 104	14.6.0	25.01.2018	http://www.etsi.org/deliver/etsi_ts/136100_136199/136104/14.06.00_60/ts_136104v140600p.pdf
TSDSI	TSDSI STD T1.3GPP 36.104-14.6.0 V1.0.0	14.6.0	30.05.2019	https://members.tdsi.in/index.php/s/BxBT9C9F8KxobBg
TTA	TTAT.3G-36.104(R14-14.6.0)	14.6.0	09.05.2019	http://www.tta.or.kr/data/ttasDown.jsp?where=14688&pk_num=TTAT.3G-36.104(R14-14.6.0)

2.1.5.3 TS 36.106

Evolved Universal Terrestrial Radio Access (E-UTRA); FDD repeater radio transmission and reception

This document establishes the minimum RF characteristics of E-UTRA FDD Repeater.

SDO	Document No.	Version	Issued date	Location
Release 10				
ATIS	ATIS.3GPP.36.106V1070		10.7.0	https://www.atis.org/docstore/
CCSA	CCSA TSD LTE 36.106		10.7.0	http://www.ccsa.org.cn/ITU_spec/ITU-R/M.2012/M.2012-4/LTE/REL-10/CCSA-TSD-LTE-36106-a70.rar
ETSI	ETSI TS 136 106		10.7.0	http://www.etsi.org/deliver/etsi_ts/136100_136199/136106/10.07.00_60/ts_136106v100700p.pdf
TSDSI	TSDSI STD T1.3GPP 36.106-10.7.0 V1.0.0		10.7.0	https://members.tdsi.in/index.php/s/BxBT9C9F8KxobBg
TTA	TTAT.3G-36.106(R10-10.7.0)		10.7.0	http://www.tta.or.kr/data/ttasDown.jsp?where=14688&pk_num=TTAT.3G-36.106(R10-10.7.0)
Release 11				
ATIS	ATIS.3GPP.36.106V1120		11.2.0	https://www.atis.org/docstore/
CCSA	CCSA TSD LTE 36.106		11.2.0	http://www.ccsa.org.cn/ITU_spec/ITU-R/M.2012/M.2012-4/LTE/REL-11/CCSA-TSD-LTE-36106-b20.rar
ETSI	ETSI TS 136 106		11.2.0	http://www.etsi.org/deliver/etsi_ts/136100_136199/136106/11.02.00_60/ts_136106v110200p.pdf
TSDSI	TSDSI STD T1.3GPP 36.106-11.2.0 V1.0.0		11.2.0	https://members.tdsi.in/index.php/s/BxBT9C9F8KxobBg
TTA	TTAT.3G-36.106(R11-11.2.0)		11.2.0	http://www.tta.or.kr/data/ttasDown.jsp?where=14688&pk_num=TTAT.3G-36.106(R11-11.2.0)
Release 12				
ATIS	ATIS.3GPP.36.106V1210		12.1.0	https://www.atis.org/docstore/
CCSA	CCSA TSD LTE 36.106		12.1.0	http://www.ccsa.org.cn/ITU_spec/ITU-R/M.2012/M.2012-4/LTE/REL-12/CCSA-TSD-LTE-36106-c10.rar
ETSI	ETSI TS 136 106		12.1.0	http://www.etsi.org/deliver/etsi_ts/136100_136199/136106/12.01.00_60/ts_136106v120100p.pdf
TSDSI	TSDSI STD T1.3GPP 36.106-12.1.0 V1.0.0		12.1.0	https://members.tdsi.in/index.php/s/BxBT9C9F8KxobBg
TTA	TTAT.3G-36.106(R12-12.1.0)		12.1.0	http://www.tta.or.kr/data/ttasDown.jsp?where=14688&pk_num=TTAT.3G-36.106(R12-12.1.0)
Release 13				
ATIS	ATIS.3GPP.36.106V1300		13.0.0	https://www.atis.org/docstore/
CCSA	CCSA TSD LTE 36.106		13.0.0	http://www.ccsa.org.cn/ITU_spec/ITU-R/M.2012/M.2012-4/LTE/REL-13/CCSA-TSD-LTE-36106-d00.rar
ETSI	ETSI TS 136 106		13.0.0	http://www.etsi.org/deliver/etsi_ts/136100_136199/136106/13.00.00_60/ts_136106v130000p.pdf
TSDSI	TSDSI STD T1.3GPP 36.106-13.0.0 V1.0.0		13.0.0	https://members.tdsi.in/index.php/s/BxBT9C9F8KxobBg
TTA	TTAT.3G-36.106(R13-13.0.0)		13.0.0	http://www.tta.or.kr/data/ttasDown.jsp?where=14688&pk_num=TTAT.3G-36.106(R13-13.0.0)
Release 14				
ATIS	ATIS.3GPP.36.106V1400		14.0.0	https://www.atis.org/docstore/
CCSA	CCSA TSD LTE 36.106		14.0.0	http://www.ccsa.org.cn/ITU_spec/ITU-R/M.2012/M.2012-4/LTE/REL-14/CCSA-TSD-LTE-36106-e00.zip
ETSI	ETSI TS 136 106		14.0.0	http://www.etsi.org/deliver/etsi_ts/136100_136199/136106/14.00.00_60/ts_136106v140000p.pdf
TSDSI	TSDSI STD T1.3GPP 36.106-14.0.0 V1.0.0		14.0.0	https://members.tdsi.in/index.php/s/BxBT9C9F8KxobBg
TTA	TTAT.3G-36.106(R14-14.0.0)		14.0.0	http://www.tta.or.kr/data/ttasDown.jsp?where=14688&pk_num=TTAT.3G-36.106(R14-14.0.0)

2.1.5.4 TS 36.111

Location Measurement Unit (LMU) performance specification; Network based positioning systems in Evolved Universal Terrestrial Radio Access Network (E-UTRAN)

This document establishes the Location Measurement Unit (LMU) minimum UTDOA positioning requirement for the FDD and TDD mode of E-UTRAN.

SDO	Document No.	Version	Issued date	Location
Release 11				
ARIB	ARIB STD-T104-36.111		11.4.0	12.04.2018 http://www.arib.or.jp/english/html/overview/doc/STD-T104v5_20/2_T104/ARIB-STD-T104/Rel11/36/A36111-b40.pdf
ATIS	ATIS.3GPP.36.111V1140		11.4.0	02.05.2019 https://www.atis.org/docstore/
CCSA	CCSA TSD LTE 36.111		11.4.0	24.10.2014 http://www.ccsa.org.cn/ITU_spec/ITU-R/M.2012/M.2012-4/LTE/REL-11/CCSA-TSD-LTE-36111-b40.rar
ETSI	ETSI TS 136 111		11.4.0	24.10.2014 http://www.etsi.org/deliver/etsi_ts/136100_136199/136111/11.04.00_60/ts_136111v110400p.pdf
TSDSI	TSDSI STD T1.3GPP 36.111-11.4.0 V1.0.0		11.4.0	30.05.2019 https://members.tdsi.in/index.php/s/BxBT9C9F8KxobBg
TTA	TTAT.3G-36.111(R11-11.4.0)		11.4.0	09.04.2015 http://www.tta.or.kr/data/ttasDown.jsp?where=14688&pk_num=TTAT.3G-36.111(R11-11.4.0)
Release 12				
ARIB	ARIB STD-T104-36.111		12.0.0	12.04.2018 http://www.arib.or.jp/english/html/overview/doc/STD-T104v5_20/2_T104/ARIB-STD-T104/Rel12/36/A36111-c00.pdf
ATIS	ATIS.3GPP.36.111V1200		12.0.0	02.05.2019 https://www.atis.org/docstore/
CCSA	CCSA TSD LTE 36.111		12.0.0	24.10.2014 http://www.ccsa.org.cn/ITU_spec/ITU-R/M.2012/M.2012-4/LTE/REL-12/CCSA-TSD-LTE-36111-c00.rar
ETSI	ETSI TS 136 111		12.0.0	24.10.2014 http://www.etsi.org/deliver/etsi_ts/136100_136199/136111/12.00.00_60/ts_136111v120000p.pdf
TSDSI	TSDSI STD T1.3GPP 36.111-12.0.0 V1.0.0		12.0.0	30.05.2019 https://members.tdsi.in/index.php/s/BxBT9C9F8KxobBg
TTA	TTAT.3G-36.111(R12-12.0.0)		12.0.0	09.04.2015 http://www.tta.or.kr/data/ttasDown.jsp?where=14688&pk_num=TTAT.3G-36.111(R12-12.0.0)
Release 13				
ARIB	ARIB STD-T104-36.111		13.0.0	12.04.2018 http://www.arib.or.jp/english/html/overview/doc/STD-T104v5_20/2_T104/ARIB-STD-T104/Rel13/36/A36111-d00.pdf
ATIS	ATIS.3GPP.36.111V1300		13.0.0	02.05.2019 https://www.atis.org/docstore/
CCSA	CCSA TSD LTE 36.111		13.0.0	28.01.2016 http://www.ccsa.org.cn/ITU_spec/ITU-R/M.2012/M.2012-4/LTE/REL-13/CCSA-TSD-LTE-36111-d00.rar
ETSI	ETSI TS 136 111		13.0.0	28.01.2016 http://www.etsi.org/deliver/etsi_ts/136100_136199/136111/13.00.00_60/ts_136111v130000p.pdf
TSDSI	TSDSI STD T1.3GPP 36.111-13.0.0 V1.0.0		13.0.0	30.05.2019 https://members.tdsi.in/index.php/s/BxBT9C9F8KxobBg
TTA	TTAT.3G-36.111(R13-13.0.0)		13.0.0	06.07.2017 http://www.tta.or.kr/data/ttasDown.jsp?where=14688&pk_num=TTAT.3G-36.111(R13-13.0.0)
Release 14				
ARIB	ARIB STD-T104-36.111		14.0.0	12.04.2018 http://www.arib.or.jp/english/html/overview/doc/STD-T104v5_20/2_T104/ARIB-STD-T104/Rel14/36/A36111-e00.pdf
ATIS	ATIS.3GPP.36.111V1400		14.0.0	02.05.2019 https://www.atis.org/docstore/
CCSA	CCSA TSD LTE 36.111		14.0.0	11.01.2019 http://www.ccsa.org.cn/ITU_spec/ITU-R/M.2012/M.2012-4/LTE/REL-14/CCSA-TSD-LTE-36111-e00.zip
ETSI	ETSI TS 136 111		14.0.0	13.04.2017 http://www.etsi.org/deliver/etsi_ts/136100_136199/136111/14.00.00_60/ts_136111v140000p.pdf
TSDSI	TSDSI STD T1.3GPP 36.111-14.0.0 V1.0.0		14.0.0	30.05.2019 https://members.tdsi.in/index.php/s/BxBT9C9F8KxobBg
TTA	TTAT.3G-36.111(R14-14.0.0)		14.0.0	10.05.2018 http://www.tta.or.kr/data/ttasDown.jsp?where=14688&pk_num=TTAT.3G-36.111(R14-14.0.0)

2.1.5.5 TS 36.112

Location Measurement Unit (LMU) conformance specification; Network based positioning systems in Evolved Universal Terrestrial Radio Access Network (E-UTRAN)

This document establishes the conformance requirements for E-UTRAN Location Measurement Units (LMU) operating in the FDD or TDD mode.

SDO	Document No.	Version	Issued date	Location	
Release 11					
ARIB	ARIB STD-T104-36.112		11.1.0	12.04.2018	http://www.arib.or.jp/english/html/overview/doc/STD-T104v5_20/2_T104/ARIB-STD-T104/Rel11/36/A36112-b10.pdf
ATIS	ATIS.3GPP.36.112V1110		11.1.0	02.05.2019	https://www.atis.org/docstore/
CCSA	CCSA TSD LTE 36.112		11.1.0	03.02.2015	http://www.ccsa.org.cn/ITU_spec/ITU-R/M.2012/M.2012-4/LTE/REL-11/CCSA-TSD-LTE-36112-b10.rar
ETSI	ETSI TS 136 112		11.1.0	03.02.2015	http://www.etsi.org/deliver/etsi_ts/136100_136199/136112/11.01.00_60/ts_136112v110100p.pdf
TSDSI	TSDSI STD T1.3GPP 36.112-11.1.0 V1.0.0		11.1.0	30.05.2019	https://members.tdsi.in/index.php/s/BxBT9C9F8KxobBg
TTA	TTAT.3G-36.112(R11-11.1.0)		11.1.0	09.04.2015	http://www.tta.or.kr/data/ttasDown.jsp?where=14688&pk_num=TTAT.3G-36.112(R11-11.1.0)
Release 12					
ARIB	ARIB STD-T104-36.112		12.2.0	12.04.2018	http://www.arib.or.jp/english/html/overview/doc/STD-T104v5_20/2_T104/ARIB-STD-T104/Rel12/36/A36112-c20.pdf
ATIS	ATIS.3GPP.36.112V1220		12.2.0	02.05.2019	https://www.atis.org/docstore/
CCSA	CCSA TSD LTE 36.112		12.2.0	20.04.2015	http://www.ccsa.org.cn/ITU_spec/ITU-R/M.2012/M.2012-4/LTE/REL-12/CCSA-TSD-LTE-36112-c20.rar
ETSI	ETSI TS 136 112		12.2.0	20.04.2015	http://www.etsi.org/deliver/etsi_ts/136100_136199/136112/12.02.00_60/ts_136112v120200p.pdf
TSDSI	TSDSI STD T1.3GPP 36.112-12.2.0 V1.0.0		12.2.0	30.05.2019	https://members.tdsi.in/index.php/s/BxBT9C9F8KxobBg
TTA	TTAT.3G-36.112(R12-12.2.0)		12.2.0	06.07.2017	http://www.tta.or.kr/data/ttasDown.jsp?where=14688&pk_num=TTAT.3G-36.112(R12-12.2.0)
Release 13					
ARIB	ARIB STD-T104-36.112		13.0.1	12.04.2018	http://www.arib.or.jp/english/html/overview/doc/STD-T104v5_20/2_T104/ARIB-STD-T104/Rel13/36/A36112-d01.pdf
ATIS	ATIS.3GPP.36.112V1301		13.0.1	02.05.2019	https://www.atis.org/docstore/
CCSA	CCSA TSD LTE 36.112		13.0.1	28.01.2016	http://www.ccsa.org.cn/ITU_spec/ITU-R/M.2012/M.2012-4/LTE/REL-13/CCSA-TSD-LTE-36112-d01.rar
ETSI	ETSI TS 136 112		13.0.1	28.01.2016	http://www.etsi.org/deliver/etsi_ts/136100_136199/136112/13.00.01_60/ts_136112v130001p.pdf
TSDSI	TSDSI STD T1.3GPP 36.112-13.0.1 V1.0.0		13.0.1	30.05.2019	https://members.tdsi.in/index.php/s/BxBT9C9F8KxobBg
TTA	TTAT.3G-36.112(R13-13.0.1)		13.0.1	06.07.2017	http://www.tta.or.kr/data/ttasDown.jsp?where=14688&pk_num=TTAT.3G-36.112(R13-13.0.1)
Release 14					
ARIB	ARIB STD-T104-36.112		14.0.0	12.04.2018	http://www.arib.or.jp/english/html/overview/doc/STD-T104v5_20/2_T104/ARIB-STD-T104/Rel14/36/A36112-e00.pdf
ATIS	ATIS.3GPP.36.112V1400		14.0.0	02.05.2019	https://www.atis.org/docstore/
CCSA	CCSA TSD LTE 36.112		14.0.0	11.01.2019	http://www.ccsa.org.cn/ITU_spec/ITU-R/M.2012/M.2012-4/LTE/REL-14/CCSA-TSD-LTE-36112-e00.zip
ETSI	ETSI TS 136 112		14.0.0	13.04.2017	http://www.etsi.org/deliver/etsi_ts/136100_136199/136112/14.00.00_60/ts_136112v140000p.pdf
TSDSI	TSDSI STD T1.3GPP 36.112-14.0.0 V1.0.0		14.0.0	30.05.2019	https://members.tdsi.in/index.php/s/BxBT9C9F8KxobBg
TTA	TTAT.3G-36.112(R14-14.0.0)		14.0.0	10.05.2018	http://www.tta.or.kr/data/ttasDown.jsp?where=14688&pk_num=TTAT.3G-36.112(R14-14.0.0)

2.1.5.6 TS 36.113

Evolved Universal Terrestrial Radio Access (E-UTRA); Base Station (BS) and repeater ElectroMagnetic Compatibility (EMC)

This document covers the assessment of E-UTRA base stations, repeaters and associated ancillary equipment in respect of Electromagnetic Compatibility (EMC). This document specifies the applicable test conditions, performance assessment and performance criteria for E-UTRA base stations, repeaters and associated ancillary equipment in one of the following categories: (i) base stations of E-UTRA meeting the requirements of TS 36.104, with conformance demonstrated by compliance to TS 36.141; (ii) repeaters of FDD E-UTRA meeting the requirements of TS 36.106, with conformance demonstrated by compliance to TS 36.143. The environment classification used in this document refers to the environment classification used in IEC 61000-6-1 and IEC 61000-6-3. The EMC requirements have been selected to ensure an adequate level of compatibility for apparatus at residential, commercial and light industrial environments. The levels, however, do not cover extreme cases which may occur in any location but with low probability of occurrence.

76

Rec. ITU-R M.2012-4

SDO	Document No.	Version	Issued date	Location
Release 10				
ARIB	ARIB STD-T104-36.113		10.5.0 12.04.2018	http://www.arib.or.jp/english/html/overview/doc/STD-T104v5_20/2_T104/ARIB-STD-T104/Rel10/36/A36113-a50.pdf
ATIS	ATIS.3GPP.36.113V1050		10.5.0 02.05.2019	https://www.atis.org/docstore/
CCSA	CCSA TSD LTE 36.113		10.5.0 30.07.2012	http://www.ccsa.org.cn/ITU_spec/ITU-R/M.2012/M.2012-4/LTE/REL-10/CCSA-TSD-LTE-36113-a50.rar
ETSI	ETSI TS 136 113		10.5.0 30.07.2012	http://www.etsi.org/deliver/etsi_ts/136100_136199/136113/10.05.00_60/ts_136113v100500p.pdf
TSDSI	TSDSI STD T1.3GPP 36.113-10.5.0 V1.0.0		10.5.0 30.05.2019	https://members.tdsi.in/index.php/s/BxBT9C9F8KxobBg
TTA	TTAT.3G-36.113(R10-10.5.0)		10.5.0 10.08.2016	http://www.tta.or.kr/data/ttasDown.jsp?where=14688&pk_num=TTAT.3G-36.113(R10-10.5.0)
Release 11				
ARIB	ARIB STD-T104-36.113		11.3.0 12.04.2018	http://www.arib.or.jp/english/html/overview/doc/STD-T104v5_20/2_T104/ARIB-STD-T104/Rel11/36/A36113-b30.pdf
ATIS	ATIS.3GPP.36.113V1130		11.3.0 02.05.2019	https://www.atis.org/docstore/
CCSA	CCSA TSD LTE 36.113		11.3.0 03.02.2015	http://www.ccsa.org.cn/ITU_spec/ITU-R/M.2012/M.2012-4/LTE/REL-11/CCSA-TSD-LTE-36113-b30.rar
ETSI	ETSI TS 136 113		11.3.0 03.02.2015	http://www.etsi.org/deliver/etsi_ts/136100_136199/136113/11.03.00_60/ts_136113v110300p.pdf
TSDSI	TSDSI STD T1.3GPP 36.113-11.3.0 V1.0.0		11.3.0 30.05.2019	https://members.tdsi.in/index.php/s/BxBT9C9F8KxobBg
TTA	TTAT.3G-36.113(R11-11.3.0)		11.3.0 10.08.2016	http://www.tta.or.kr/data/ttasDown.jsp?where=14688&pk_num=TTAT.3G-36.113(R11-11.3.0)
Release 12				
ARIB	ARIB STD-T104-36.113		12.3.0 12.04.2018	http://www.arib.or.jp/english/html/overview/doc/STD-T104v5_20/2_T104/ARIB-STD-T104/Rel12/36/A36113-c30.pdf
ATIS	ATIS.3GPP.36.113V1230		12.3.0 02.05.2019	https://www.atis.org/docstore/
CCSA	CCSA TSD LTE 36.113		12.3.0 03.02.2015	http://www.ccsa.org.cn/ITU_spec/ITU-R/M.2012/M.2012-4/LTE/REL-12/CCSA-TSD-LTE-36113-c30.rar
ETSI	ETSI TS 136 113		12.3.0 03.02.2015	http://www.etsi.org/deliver/etsi_ts/136100_136199/136113/12.03.00_60/ts_136113v120300p.pdf
TSDSI	TSDSI STD T1.3GPP 36.113-12.3.0 V1.0.0		12.3.0 30.05.2019	https://members.tdsi.in/index.php/s/BxBT9C9F8KxobBg
TTA	TTAT.3G-36.113(R12-12.3.0)		12.3.0 09.04.2015	http://www.tta.or.kr/data/ttasDown.jsp?where=14688&pk_num=TTAT.3G-36.113(R12-12.3.0)
Release 13				
ARIB	ARIB STD-T104-36.113		13.3.0 12.04.2018	http://www.arib.or.jp/english/html/overview/doc/STD-T104v5_20/2_T104/ARIB-STD-T104/Rel13/36/A36113-d30.pdf
ATIS	ATIS.3GPP.36.113V1330		13.3.0 02.05.2019	https://www.atis.org/docstore/
CCSA	CCSA TSD LTE 36.113		13.3.0 26.01.2017	http://www.ccsa.org.cn/ITU_spec/ITU-R/M.2012/M.2012-4/LTE/REL-13/CCSA-TSD-LTE-36113-d30.rar
ETSI	ETSI TS 136 113		13.3.0 26.01.2017	http://www.etsi.org/deliver/etsi_ts/136100_136199/136113/13.03.00_60/ts_136113v130300p.pdf
TSDSI	TSDSI STD T1.3GPP 36.113-13.3.0 V1.0.0		13.3.0 30.05.2019	https://members.tdsi.in/index.php/s/BxBT9C9F8KxobBg
TTA	TTAT.3G-36.113(R13-13.3.0)		13.3.0 10.05.2018	http://www.tta.or.kr/data/ttasDown.jsp?where=14688&pk_num=TTAT.3G-36.113(R13-13.3.0)
Release 14				
ARIB	ARIB STD-T104-36.113		14.2.0 12.04.2018	http://www.arib.or.jp/english/html/overview/doc/STD-T104v5_20/2_T104/ARIB-STD-T104/Rel14/36/A36113-e20.pdf
ATIS	ATIS.3GPP.36.113V1420		14.2.0 02.05.2019	https://www.atis.org/docstore/
CCSA	CCSA TSD LTE 36.113		14.2.0 11.01.2019	http://www.ccsa.org.cn/ITU_spec/ITU-R/M.2012/M.2012-4/LTE/REL-14/CCSA-TSD-LTE-36113-e20.zip
ETSI	ETSI TS 136 113		14.2.0 13.04.2017	http://www.etsi.org/deliver/etsi_ts/136100_136199/136113/14.02.00_60/ts_136113v140200p.pdf
TSDSI	TSDSI STD T1.3GPP 36.113-14.2.0 V1.0.0		14.2.0 30.05.2019	https://members.tdsi.in/index.php/s/BxBT9C9F8KxobBg
TTA	TTAT.3G-36.113(R14-14.2.0)		14.2.0 10.05.2018	http://www.tta.or.kr/data/ttasDown.jsp?where=14688&pk_num=TTAT.3G-36.113(R14-14.2.0)

2.1.5.7 TS 36.116

Evolved Universal Terrestrial Radio Access (E-UTRA); Relay radio transmission and reception

This document establishes the minimum RF characteristics and minimum performance requirements of E-UTRA Relay.

SDO	Document No.	Version	Issued date	Location
Release 11				
ATIS	ATIS.3GPP.36.116V1170		11.7.0	02.05.2019 https://www.atis.org/docstore/
CCSA	CCSA TSD LTE 36.116		11.7.0	28.01.2016 http://www.ccsa.org.cn/ITU_spec/ITU-R/M.2012/M.2012-4/LTE/REL-11/CCSA-TSD-LTE-36116-b70.rar
ETSI	ETSI TS 136 116		11.7.0	28.01.2016 http://www.etsi.org/deliver/etsi_ts/136100_136199/136116/11.07.00_60/ts_136116v110700p.pdf
TSDSI	TSDSI STD T1.3GPP 36.116-11.7.0 V1.0.0		11.7.0	30.05.2019 https://members.tdsi.in/index.php/s/BxBT9C9F8KxobBg
TTA	TTAT.3G-36.116(R11-11.7.0)		11.7.0	06.07.2017 http://www.tta.or.kr/data/ttasDown.jsp?where=14688&pk_num=TTAT.3G-36.116(R11-11.7.0)
Release 12				
ATIS	ATIS.3GPP.36.116V1240		12.4.0	02.05.2019 https://www.atis.org/docstore/
CCSA	CCSA TSD LTE 36.116		12.4.0	28.01.2016 http://www.ccsa.org.cn/ITU_spec/ITU-R/M.2012/M.2012-4/LTE/REL-12/CCSA-TSD-LTE-36116-c40.rar
ETSI	ETSI TS 136 116		12.4.0	28.01.2016 http://www.etsi.org/deliver/etsi_ts/136100_136199/136116/12.04.00_60/ts_136116v120400p.pdf
TSDSI	TSDSI STD T1.3GPP 36.116-12.4.0 V1.0.0		12.4.0	30.05.2019 https://members.tdsi.in/index.php/s/BxBT9C9F8KxobBg
TTA	TTAT.3G-36.116(R12-12.4.0)		12.4.0	06.07.2017 http://www.tta.or.kr/data/ttasDown.jsp?where=14688&pk_num=TTAT.3G-36.116(R12-12.4.0)
Release 13				
ATIS	ATIS.3GPP.36.116V1301		13.0.1	02.05.2019 https://www.atis.org/docstore/
CCSA	CCSA TSD LTE 36.116		13.0.1	28.01.2016 http://www.ccsa.org.cn/ITU_spec/ITU-R/M.2012/M.2012-4/LTE/REL-13/CCSA-TSD-LTE-36116-d01.rar
ETSI	ETSI TS 136 116		13.0.1	28.01.2016 http://www.etsi.org/deliver/etsi_ts/136100_136199/136116/13.00.01_60/ts_136116v130001p.pdf
TSDSI	TSDSI STD T1.3GPP 36.116-13.0.1 V1.0.0		13.0.1	30.05.2019 https://members.tdsi.in/index.php/s/BxBT9C9F8KxobBg
TTA	TTAT.3G-36.116(R13-13.0.1)		13.0.1	06.07.2017 http://www.tta.or.kr/data/ttasDown.jsp?where=14688&pk_num=TTAT.3G-36.116(R13-13.0.1)
Release 14				
ATIS	ATIS.3GPP.36.116V1400		14.0.0	02.05.2019 https://www.atis.org/docstore/
CCSA	CCSA TSD LTE 36.116		14.0.0	11.01.2019 http://www.ccsa.org.cn/ITU_spec/ITU-R/M.2012/M.2012-4/LTE/REL-14/CCSA-TSD-LTE-36116-e00.zip
ETSI	ETSI TS 136 116		14.0.0	13.04.2017 http://www.etsi.org/deliver/etsi_ts/136100_136199/136116/14.00.00_60/ts_136116v140000p.pdf
TSDSI	TSDSI STD T1.3GPP 36.116-14.0.0 V1.0.0		14.0.0	30.05.2019 https://members.tdsi.in/index.php/s/BxBT9C9F8KxobBg
TTA	TTAT.3G-36.116(R14-14.0.0)		14.0.0	10.05.2018 http://www.tta.or.kr/data/ttasDown.jsp?where=14688&pk_num=TTAT.3G-36.116(R14-14.0.0)

2.1.5.8 TS 36.117

Evolved Universal Terrestrial Radio Access (E-UTRA); Relay conformance testing

This document specifies the Radio Frequency (RF) test methods and conformance requirements for E-UTRA Relay. These have been derived from, and are consistent with the E-UTRA Relay specifications defined in TS 36.116.

SDO	Document No.	Version	Issued date	Location
Release 11				
ATIS	ATIS.3GPP.36.117V1140		11.4.0	02.05.2019 https://www.atis.org/docstore/
CCSA	CCSA TSD LTE 36.117		11.4.0	28.01.2016 http://www.ccsa.org.cn/ITU_spec/ITU-R/M.2012/M.2012-4/LTE/REL-11/CCSA-TSD-LTE-36117-b40.rar
ETSI	ETSI TS 136 117		11.4.0	28.01.2016 http://www.etsi.org/deliver/etsi_ts/136100_136199/136117/11.04.00_60/ts_136117v110400p.pdf
TSDSI	TSDSI STD T1.3GPP 36.117-11.4.0 V1.0.0		11.4.0	30.05.2019 https://members.tdsi.in/index.php/s/BxBT9C9F8KxobBg
TTA	TTAT.3G-36.117(R11-11.4.0)		11.4.0	06.07.2017 http://www.tta.or.kr/data/ttasDown.jsp?where=14688&pk_num=TTAT.3G-36.117(R11-11.4.0)
Release 12				
ATIS	ATIS.3GPP.36.117V1230		12.3.0	02.05.2019 https://www.atis.org/docstore/
CCSA	CCSA TSD LTE 36.117		12.3.0	28.01.2016 http://www.ccsa.org.cn/ITU_spec/ITU-R/M.2012/M.2012-4/LTE/REL-12/CCSA-TSD-LTE-36117-c30.rar
ETSI	ETSI TS 136 117		12.3.0	28.01.2016 http://www.etsi.org/deliver/etsi_ts/136100_136199/136117/12.03.00_60/ts_136117v120300p.pdf

78

TSDSI	TSDSI STD T1.3GPP 36.117-12.3.0 V1.0.0	12.3.0	30.05.2019	https://members.tdsi.in/index.php/s/BxBT9C9F8KxobBg
TTA	TTAT.3G-36.117(R12-12.3.0)	12.3.0	06.07.2017	http://www.tta.or.kr/data/ttasDown.jsp?where=14688&pk_num=TTAT.3G-36.117(R12-12.3.0)

Release 13

ATIS	ATIS.3GPP.36.117V1301	13.0.1	02.05.2019	https://www.atis.org/docstore/
CCSA	CCSA TSD LTE 36.117	13.0.1	28.01.2016	http://www.ccsa.org.cn/ITU_spec/ITU-R/M.2012/M.2012-4/LTE/REL-13/CCSA-TSD-LTE-36117-d01.rar
ETSI	ETSI TS 136 117	13.0.1	28.01.2016	http://www.etsi.org/deliver/etsi_ts/136100_136199/136117/13.00.01_60/ts_136117v130001p.pdf
TSDSI	TSDSI STD T1.3GPP 36.117-13.0.1 V1.0.0	13.0.1	30.05.2019	https://members.tdsi.in/index.php/s/BxBT9C9F8KxobBg
TTA	TTAT.3G-36.117(R13-13.0.1)	13.0.1	06.07.2017	http://www.tta.or.kr/data/ttasDown.jsp?where=14688&pk_num=TTAT.3G-36.117(R13-13.0.1)

Release 14

ATIS	ATIS.3GPP.36.117V1400	14.0.0	02.05.2019	https://www.atis.org/docstore/
CCSA	CCSA TSD LTE 36.117	14.0.0	11.01.2019	http://www.ccsa.org.cn/ITU_spec/ITU-R/M.2012/M.2012-4/LTE/REL-14/CCSA-TSD-LTE-36117-e00.zip
ETSI	ETSI TS 136 117	14.0.0	13.04.2017	http://www.etsi.org/deliver/etsi_ts/136100_136199/136117/14.00.00_60/ts_136117v140000p.pdf
TSDSI	TSDSI STD T1.3GPP 36.117-14.0.0 V1.0.0	14.0.0	30.05.2019	https://members.tdsi.in/index.php/s/BxBT9C9F8KxobBg
TTA	TTAT.3G-36.117(R14-14.0.0)	14.0.0	10.05.2018	http://www.tta.or.kr/data/ttasDown.jsp?where=14688&pk_num=TTAT.3G-36.117(R14-14.0.0)

2.1.5.9 TS 36.124

Evolved Universal Terrestrial Radio Access (E-UTRA); Electromagnetic compatibility (EMC) requirements for mobile terminals and ancillary equipment

This document establishes the essential EMC requirements for “3rd generation” digital cellular mobile terminal equipment and ancillary accessories in combination with a 3GPP E-UTRA user equipment (UE). This document specifies the applicable EMC tests, the methods of measurement, the frequency range, the limits and the minimum performance criteria for all types of E-UTRA UEs and their accessories. Requirements for the radiated emission from the enclosure port of integral antenna equipment and ancillaries have been included. The immunity requirements have been selected to ensure an adequate level of compatibility for apparatus in residential, commercial, light industrial and vehicular environments. The levels however, do not cover extreme cases, which may occur in any location but with low probability of occurrence. Compliance of radio equipment to the requirements of this document does not signify compliance to any requirement related to the use of the equipment (i.e. licensing requirements). Compliance to the requirements of this document does not signify compliance to any safety requirement. However, any temporary or permanent unsafe condition caused by EMC is considered as non-compliance.

SDO	Document No.	Version	Issued date	Location	
Release 10					
ARIB	ARIB STD-T104-36.124		10.3.0	12.04.2018	http://www.arib.or.jp/english/html/overview/doc/STD-T104v5_20/2_T104/ARIB-STD-T104/Rel10/36/A36124-a30.pdf
ATIS	ATIS.3GPP.36.124V1030		10.3.0	02.05.2019	https://www.atis.org/docstore/
CCSA	CCSA TSD LTE 36.124		10.3.0	04.11.2011	http://www.ccsa.org.cn/ITU_spec/ITU-R/M.2012/M.2012-4/LTE/REL-10/CCSA-TSD-LTE-36124-a30.rar
ETSI	ETSI TS 136 124		10.3.0	04.11.2011	http://www.etsi.org/deliver/etsi_ts/136100_136199/136124/10.03.00_60/ts_136124v100300p.pdf
TSDSI	TSDSI STD T1.3GPP 36.124-10.3.0 V1.0.0		10.3.0	30.05.2019	https://members.tdsi.in/index.php/s/BxBT9C9F8KxobBg
TTA	TTAT.3G-36.124(R10-10.3.0)		10.3.0	22.08.2012	http://www.tta.or.kr/data/ttasDown.jsp?where=14688&pk_num=TTAT.3G-36.124(R10-10.3.0)
Release 11					
ARIB	ARIB STD-T104-36.124		11.2.0	12.04.2018	http://www.arib.or.jp/english/html/overview/doc/STD-T104v5_20/2_T104/ARIB-STD-T104/Rel11/36/A36124-b20.pdf
ATIS	ATIS.3GPP.36.124V1120		11.2.0	02.05.2019	https://www.atis.org/docstore/
CCSA	CCSA TSD LTE 36.124		11.2.0	15.02.2013	http://www.ccsa.org.cn/ITU_spec/ITU-R/M.2012/M.2012-4/LTE/REL-11/CCSA-TSD-LTE-36124-b20.rar

ETSI	ETSI TS 136 124	11.2.0	15.02.2013	http://www.etsi.org/deliver/etsi_ts/136100_136199/136124/11.02.00_60/ts_136124v110200p.pdf
TSDSI	TSDSI STD T1.3GPP 36.124-11.2.0 V1.0.0	11.2.0	30.05.2019	https://members.tdsi.in/index.php/s/BxBT9C9F8KxobBg
TTA	TTAT.3G-36.124(R11-11.2.0)	11.2.0	26.08.2013	http://www.tta.or.kr/data/ttasDown.jsp?where=14688&pk_num=TTAT.3G-36.124(R11-11.2.0)
Release 12				
ARIB	ARIB STD-T104-36.124	12.1.0	12.04.2018	http://www.arib.or.jp/english/html/overview/doc/STD-T104v5_20/2_T104/ARIB-STD-T104/Rel12/36/A36124-c10.pdf
ATIS	ATIS.3GPP.36.124V1210	12.1.0	02.05.2019	https://www.atis.org/docstore/
CCSA	CCSA TSD LTE 36.124	12.1.0	22.10.2014	http://www.ccsa.org.cn/ITU_spec/ITU-R/M.2012/M.2012-4/LTE/REL-12/CCSA-TSD-LTE-36124-c10.rar
ETSI	ETSI TS 136 124	12.1.0	22.10.2014	http://www.etsi.org/deliver/etsi_ts/136100_136199/136124/12.01.00_60/ts_136124v120100p.pdf
TSDSI	TSDSI STD T1.3GPP 36.124-12.1.0 V1.0.0	12.1.0	30.05.2019	https://members.tdsi.in/index.php/s/BxBT9C9F8KxobBg
TTA	TTAT.3G-36.124(R12-12.1.0)	12.1.0	09.04.2015	http://www.tta.or.kr/data/ttasDown.jsp?where=14688&pk_num=TTAT.3G-36.124(R12-12.1.0)
Release 13				
ARIB	ARIB STD-T104-36.124	13.1.0	12.04.2018	http://www.arib.or.jp/english/html/overview/doc/STD-T104v5_20/2_T104/ARIB-STD-T104/Rel13/36/A36124-d10.pdf
ATIS	ATIS.3GPP.36.124V1310	13.1.0	02.05.2019	https://www.atis.org/docstore/
CCSA	CCSA TSD LTE 36.124	13.1.0	22.04.2016	http://www.ccsa.org.cn/ITU_spec/ITU-R/M.2012/M.2012-4/LTE/REL-13/CCSA-TSD-LTE-36124-d10.rar
ETSI	ETSI TS 136 124	13.1.0	22.04.2016	http://www.etsi.org/deliver/etsi_ts/136100_136199/136124/13.01.00_60/ts_136124v130100p.pdf
TSDSI	TSDSI STD T1.3GPP 36.124-13.1.0 V1.0.0	13.1.0	30.05.2019	https://members.tdsi.in/index.php/s/BxBT9C9F8KxobBg
TTA	TTAT.3G-36.124(R13-13.1.0)	13.1.0	10.05.2018	http://www.tta.or.kr/data/ttasDown.jsp?where=14688&pk_num=TTAT.3G-36.124(R13-13.1.0)
Release 14				
ARIB	ARIB STD-T104-36.124	14.1.0	12.04.2018	http://www.arib.or.jp/english/html/overview/doc/STD-T104v5_20/2_T104/ARIB-STD-T104/Rel14/36/A36124-e10.pdf
ATIS	ATIS.3GPP.36.124V1410	14.1.0	02.05.2019	https://www.atis.org/docstore/
CCSA	CCSA TSD LTE 36.124	14.1.0	11.01.2019	http://www.ccsa.org.cn/ITU_spec/ITU-R/M.2012/M.2012-4/LTE/REL-14/CCSA-TSD-LTE-36124-e10.zip
ETSI	ETSI TS 136 124	14.1.0	31.05.2017	http://www.etsi.org/deliver/etsi_ts/136100_136199/136124/14.01.00_60/ts_136124v140100p.pdf
TSDSI	TSDSI STD T1.3GPP 36.124-14.1.0 V1.0.0	14.1.0	30.05.2019	https://members.tdsi.in/index.php/s/BxBT9C9F8KxobBg
TTA	TTAT.3G-36.124(R14-14.1.0)	14.1.0	10.05.2018	http://www.tta.or.kr/data/ttasDown.jsp?where=14688&pk_num=TTAT.3G-36.124(R14-14.1.0)

2.1.5.10 TS 36.133

Evolved Universal Terrestrial Radio Access (E-UTRA); Requirements for support of radio resource management

This document specifies requirements for support of Radio Resource Management for the FDD and TDD modes of E-UTRA. These requirements include requirements on measurements in UTRAN and the UE as well as requirements on node dynamical behaviour and interaction, in terms of delay and response characteristics.

SDO	Document No.	Version	Issued date	Location	
Release 10					
ARIB	ARIB STD-T104-36.133		10.22.0	12.04.2018	http://www.arib.or.jp/english/html/overview/doc/STD-T104v5_20/2_T104/ARIB-STD-T104/Rel10/36/A36133-am0.pdf
ATIS	ATIS.3GPP.36.133V10220		10.22.0	02.05.2019	https://www.atis.org/docstore/
CCSA	CCSA TSD LTE 36.133		10.22.0	19.12.2016	http://www.ccsa.org.cn/ITU_spec/ITU-R/M.2012/M.2012-4/LTE/REL-10/CCSA-TSD-LTE-36133-am0.rar
ETSI	ETSI TS 136 133		10.22.0	19.12.2016	http://www.etsi.org/deliver/etsi_ts/136100_136199/136133/10.22.00_60/ts_136133v102200p.pdf
TSDSI	TSDSI STD T1.3GPP 36.133-10.22.0 V1.0.0		10.22.0	30.05.2019	https://members.tdsi.in/index.php/s/BxBT9C9F8KxobBg
TTA	TTAT.3G-36.133(R10-10.22.0)		10.22.0	06.07.2017	http://www.tta.or.kr/data/ttasDown.jsp?where=14688&pk_num=TTAT.3G-36.133(R10-10.22.0)
Release 11					
ARIB	ARIB STD-T104-36.133		11.18.0	12.04.2018	http://www.arib.or.jp/english/html/overview/doc/STD-T104v5_20/2_T104/ARIB-STD-T104/Rel11/36/A36133-bi0.pdf
ATIS	ATIS.3GPP.36.133V11180		11.18.0	02.05.2019	https://www.atis.org/docstore/

80

CCSA	CCSA TSD LTE 36.133	11.18.0	19.12.2016	http://www.ccsa.org.cn/ITU_spec/ITU-R/M.2012/M.2012-4/LTE/REL-11/CCSA-TSD-LTE-36133-bi0.rar
ETSI	ETSI TS 136 133	11.18.0	19.12.2016	http://www.etsi.org/deliver/etsi_ts/136100_136199/136133/11.18.00_60/ts_136133v111800p.pdf
TSDSI	TSDSI STD T1.3GPP 36.133-11.18.0 V1.0.0	11.18.0	30.05.2019	https://members.tdsi.in/index.php/s/BxBT9C9F8KxobBg
TTA	TTAT.3G-36.133(R11-11.18.0)	11.18.0	06.07.2017	http://www.tta.or.kr/data/ttasDown.jsp?where=14688&pk_num=TTAT.3G-36.133(R11-11.18.0)

Release 12

ARIB	ARIB STD-T104-36.133	12.18.0	12.04.2018	http://www.arib.or.jp/english/html/overview/doc/STD-T104v5_20/2_T104/ARIB-STD-T104/Rel12/36/A36133-ci0.pdf
ATIS	ATIS.3GPP.36.133V12180	12.18.0	02.05.2019	https://www.atis.org/docstore/
CCSA	CCSA TSD LTE 36.133	12.16.0	30.01.2018	http://www.ccsa.org.cn/ITU_spec/ITU-R/M.2012/M.2012-4/LTE/REL-12/CCSA-TSD-LTE-36133-cg0.rar
ETSI	ETSI TS 136 133	12.18.0	30.01.2018	http://www.etsi.org/deliver/etsi_ts/136100_136199/136133/12.18.00_60/ts_136133v121800p.pdf
TSDSI	TSDSI STD T1.3GPP 36.133-12.18.0 V1.0.0	12.18.0	30.05.2019	https://members.tdsi.in/index.php/s/BxBT9C9F8KxobBg
TTA	TTAT.3G-36.133(R12-12.18.0)	12.18.0	09.05.2019	http://www.tta.or.kr/data/ttasDown.jsp?where=14688&pk_num=TTAT.3G-36.133(R12-12.18.0)

Release 13

ARIB	ARIB STD-T104-36.133	13.10.0	12.04.2018	http://www.arib.or.jp/english/html/overview/doc/STD-T104v5_20/2_T104/ARIB-STD-T104/Rel13/36/A36133-da0.pdf
ATIS	ATIS.3GPP.36.133V13100	13.10.0	02.05.2019	https://www.atis.org/docstore/
CCSA	CCSA TSD LTE 36.133	13.8.0	30.01.2018	http://www.ccsa.org.cn/ITU_spec/ITU-R/M.2012/M.2012-4/LTE/REL-13/CCSA-TSD-LTE-36133-d80.rar
ETSI	ETSI TS 136 133	13.10.0	30.01.2018	http://www.etsi.org/deliver/etsi_ts/136100_136199/136133/13.10.00_60/ts_136133v131000p.pdf
TSDSI	TSDSI STD T1.3GPP 36.133-13.10.0 V1.0.0	13.10.0	30.05.2019	https://members.tdsi.in/index.php/s/BxBT9C9F8KxobBg
TTA	TTAT.3G-36.133(R13-13.10.0)	13.10.0	09.05.2019	http://www.tta.or.kr/data/ttasDown.jsp?where=14688&pk_num=TTAT.3G-36.133(R13-13.10.0)

Release 14

ARIB	ARIB STD-T104-36.133	14.6.0	12.04.2018	http://www.arib.or.jp/english/html/overview/doc/STD-T104v5_20/2_T104/ARIB-STD-T104/Rel14/36/A36133-e60.pdf
ATIS	ATIS.3GPP.36.133V1460	14.6.0	02.05.2019	https://www.atis.org/docstore/
CCSA	CCSA TSD LTE 36.133	14.6.0	11.01.2019	http://www.ccsa.org.cn/ITU_spec/ITU-R/M.2012/M.2012-4/LTE/REL-14/CCSA-TSD-LTE-36133-e60.zip
ETSI	ETSI TS 136 133	14.6.0	30.01.2018	http://www.etsi.org/deliver/etsi_ts/136100_136199/136133/14.06.00_60/ts_136133v140600p.pdf
TSDSI	TSDSI STD T1.3GPP 36.133-14.6.0 V1.0.0	14.6.0	30.05.2019	https://members.tdsi.in/index.php/s/BxBT9C9F8KxobBg
TTA	TTAT.3G-36.133(R14-14.6.0)	14.6.0	09.05.2019	http://www.tta.or.kr/data/ttasDown.jsp?where=14688&pk_num=TTAT.3G-36.133(R14-14.6.0)

2.1.5.11 TS 36.141

Evolved Universal Terrestrial Radio Access (E-UTRA); Base Station (BS) conformance testing

This document specifies the Radio Frequency (RF) test methods and conformance requirements for E-UTRA Base Stations (BS) operating either in the FDD mode (used in paired bands) or the TDD mode (used in unpaired bands). These have been derived from, and are consistent with the E-UTRA Base Station (BS) specifications defined in TS 36 104.

SDO	Document No.	Version	Issued date	Location
Release 10				
ARIB	ARIB STD-T104-36.141		10.13.0 12.04.2018	http://www.arib.or.jp/english/html/overview/doc/STD-T104v5_20/2_T104/ARIB-STD-T104/Rel10/36/A36141-ad0.pdf
ATIS	ATIS.3GPP.36.141V10130		10.13.0 02.05.2019	https://www.atis.org/docstore/
CCSA	CCSA TSD LTE 36.141		10.13.0 27.07.2017	http://www.ccsa.org.cn/ITU_spec/ITU-R/M.2012/M.2012-4/LTE/REL-10/CCSA-TSD-LTE-36141-ad0.rar
ETSI	ETSI TS 136 141		10.13.0 27.07.2017	http://www.etsi.org/deliver/etsi_ts/136100_136199/136141/10.13.00_60/ts_136141v101300p.pdf
TSDSI	TSDSI STD T1.3GPP 36.141-10.13.0 V1.0.0		10.13.0 30.05.2019	https://members.tdsi.in/index.php/s/BxBT9C9F8KxobBg
TTA	TTAT.3G-36.141(R10-10.13.0)		10.13.0 10.05.2018	http://www.tta.or.kr/data/ttasDown.jsp?where=14688&pk_num=TTAT.3G-36.141(R10-10.13.0)
Release 11				
ARIB	ARIB STD-T104-36.141		11.16.0 12.04.2018	http://www.arib.or.jp/english/html/overview/doc/STD-T104v5_20/2_T104/ARIB-STD-T104/Rel11/36/A36141-bg0.pdf

ATIS	ATIS.3GPP.36.141V11160	11.16.0	02.05.2019	https://www.atis.org/docstore/
CCSA	CCSA TSD LTE 36.141	11.16.0	27.07.2017	http://www.ccsa.org.cn/ITU_spec/ITU-R/M.2012/M.2012-4/LTE/REL-11/CCSA-TSD-LTE-36141-bg0.rar
ETSI	ETSI TS 136 141	11.16.0	27.07.2017	http://www.etsi.org/deliver/etsi_ts/136100_136199/136141/11.16.00_60/ts_136141v111600p.pdf
TSDSI	TSDSI STD T1.3GPP 36.141-11.16.0 V1.0.0	11.16.0	30.05.2019	https://members.tdsi.in/index.php/s/BxBT9C9F8KxobBg
TTA	TTAT.3G-36.141(R11-11.16.0)	11.16.0	10.05.2018	http://www.tta.or.kr/data/ttasDown.jsp?where=14688&pk_num=TTAT.3G-36.141(R11-11.16.0)
Release 12				
ARIB	ARIB STD-T104-36.141	12.13.0	12.04.2018	http://www.arib.or.jp/english/html/overview/doc/STD-T104v5_2/2_T104/ARIB-STD-T104/Rel12/36/A36141-cd0.pdf
ATIS	ATIS.3GPP.36.141V12130	12.13.0	02.05.2019	https://www.atis.org/docstore/
CCSA	CCSA TSD LTE 36.141	12.13.0	27.07.2017	http://www.ccsa.org.cn/ITU_spec/ITU-R/M.2012/M.2012-4/LTE/REL-12/CCSA-TSD-LTE-36141-cd0.rar
ETSI	ETSI TS 136 141	12.13.0	27.07.2017	http://www.etsi.org/deliver/etsi_ts/136100_136199/136141/12.13.00_60/ts_136141v121300p.pdf
TSDSI	TSDSI STD T1.3GPP 36.141-12.13.0 V1.0.0	12.13.0	30.05.2019	https://members.tdsi.in/index.php/s/BxBT9C9F8KxobBg
TTA	TTAT.3G-36.141(R12-12.13.0)	12.13.0	10.05.2018	http://www.tta.or.kr/data/ttasDown.jsp?where=14688&pk_num=TTAT.3G-36.141(R12-12.13.0)
Release 13				
ARIB	ARIB STD-T104-36.141	13.10.0	12.04.2018	http://www.arib.or.jp/english/html/overview/doc/STD-T104v5_2/2_T104/ARIB-STD-T104/Rel13/36/A36141-da0.pdf
ATIS	ATIS.3GPP.36.141V13100	13.10.0	02.05.2019	https://www.atis.org/docstore/
CCSA	CCSA TSD LTE 36.141	13.8.0	25.01.2018	http://www.ccsa.org.cn/ITU_spec/ITU-R/M.2012/M.2012-4/LTE/REL-13/CCSA-TSD-LTE-36141-d80.rar
ETSI	ETSI TS 136 141	13.10.0	25.01.2018	http://www.etsi.org/deliver/etsi_ts/136100_136199/136141/13.10.00_60/ts_136141v131000p.pdf
TSDSI	TSDSI STD T1.3GPP 36.141-13.10.0 V1.0.0	13.10.0	30.05.2019	https://members.tdsi.in/index.php/s/BxBT9C9F8KxobBg
TTA	TTAT.3G-36.141(R13-13.10.0)	13.10.0	09.05.2019	http://www.tta.or.kr/data/ttasDown.jsp?where=14688&pk_num=TTAT.3G-36.141(R13-13.10.0)
Release 14				
ARIB	ARIB STD-T104-36.141	14.6.0	12.04.2018	http://www.arib.or.jp/english/html/overview/doc/STD-T104v5_2/2_T104/ARIB-STD-T104/Rel14/36/A36141-e60.pdf
ATIS	ATIS.3GPP.36.141V1460	14.6.0	02.05.2019	https://www.atis.org/docstore/
CCSA	CCSA TSD LTE 36.141	14.6.0	11.01.2019	http://www.ccsa.org.cn/ITU_spec/ITU-R/M.2012/M.2012-4/LTE/REL-14/CCSA-TSD-LTE-36141-e60.zip
ETSI	ETSI TS 136 141	14.6.0	25.01.2018	http://www.etsi.org/deliver/etsi_ts/136100_136199/136141/14.06.00_60/ts_136141v140600p.pdf
TSDSI	TSDSI STD T1.3GPP 36.141-14.6.0 V1.0.0	14.6.0	30.05.2019	https://members.tdsi.in/index.php/s/BxBT9C9F8KxobBg
TTA	TTAT.3G-36.141(R14-14.6.0)	14.6.0	09.05.2019	http://www.tta.or.kr/data/ttasDown.jsp?where=14688&pk_num=TTAT.3G-36.141(R14-14.6.0)

2.1.5.12 TS 36.143

Evolved Universal Terrestrial Radio Access (E-UTRA); FDD repeater conformance testing

This document specifies the Radio Frequency (RF) test methods and conformance requirements for E-UTRA FDD Repeater. These have been derived from, and are consistent with the E-UTRA FDD repeater specifications defined in TS 36.106.

SDO	Document No.	Version	Issued date	Location	
Release 10					
ATIS	ATIS.3GPP.36.143V1070		10.7.0	02.05.2019	https://www.atis.org/docstore/
CCSA	CCSA TSD LTE 36.143		10.7.0	26.04.2013	http://www.ccsa.org.cn/ITU_spec/ITU-R/M.2012/M.2012-4/LTE/REL-10/CCSA-TSD-LTE-36143-a70.rar
ETSI	ETSI TS 136 143		10.7.0	26.04.2013	http://www.etsi.org/deliver/etsi_ts/136100_136199/136143/10.07.00_60/ts_136143v100700p.pdf
TSDSI	TSDSI STD T1.3GPP 36.143-10.7.0 V1.0.0		10.7.0	30.05.2019	https://members.tdsi.in/index.php/s/BxBT9C9F8KxobBg
TTA	TTAT.3G-36.143(R10-10.7.0)		10.7.0	26.08.2013	http://www.tta.or.kr/data/ttasDown.jsp?where=14688&pk_num=TTAT.3G-36.143(R10-10.7.0)
Release 11					
ATIS	ATIS.3GPP.36.143V1120		11.2.0	02.05.2019	https://www.atis.org/docstore/
CCSA	CCSA TSD LTE 36.143		11.2.0	26.04.2013	http://www.ccsa.org.cn/ITU_spec/ITU-R/M.2012/M.2012-4/LTE/REL-11/CCSA-TSD-LTE-36143-b20.rar
ETSI	ETSI TS 136 143		11.2.0	26.04.2013	http://www.etsi.org/deliver/etsi_ts/136100_136199/136143/11.02.00_60/ts_136143v110200p.pdf
TSDSI	TSDSI STD T1.3GPP 36.143-11.2.0 V1.0.0		11.2.0	30.05.2019	https://members.tdsi.in/index.php/s/BxBT9C9F8KxobBg

82**Rec. ITU-R M.2012-4**

TTA	TTAT.3G-36.143(R11-11.2.0)	11.2.0	26.08.2013	http://www.tta.or.kr/data/ttasDown.jsp?where=14688&pk_num=TTAT.3G-36.143(R11-11.2.0)
-----	----------------------------	--------	------------	---

Release 12

ATIS	ATIS.3GPP.36.143V1210	12.1.0	02.05.2019	https://www.atis.org/docstore/
CCSA	CCSA TSD LTE 36.143	12.1.0	03.02.2015	http://www.ccsa.org.cn/ITU_spec/ITU-R/M.2012/M.2012-4/LTE/REL-12/CCSA-TSD-LTE-36143-c10.rar
ETSI	ETSI TS 136 143	12.1.0	03.02.2015	http://www.etsi.org/deliver/etsi_ts/136100_136199/136143/12.01.00_60/ts_136143v120100p.pdf
TSDSI	TSDSI STD T1.3GPP 36.143-12.1.0 V1.0.0	12.1.0	30.05.2019	https://members.tdsi.in/index.php/s/BxBT9C9F8KxobBg
TTA	TTAT.3G-36.143(R12-12.1.0)	12.1.0	09.04.2015	http://www.tta.or.kr/data/ttasDown.jsp?where=14688&pk_num=TTAT.3G-36.143(R12-12.1.0)

Release 13

ATIS	ATIS.3GPP.36.143V1300	13.0.0	02.05.2019	https://www.atis.org/docstore/
CCSA	CCSA TSD LTE 36.143	13.0.0	28.01.2016	http://www.ccsa.org.cn/ITU_spec/ITU-R/M.2012/M.2012-4/LTE/REL-13/CCSA-TSD-LTE-36143-d00.rar
ETSI	ETSI TS 136 143	13.0.0	28.01.2016	http://www.etsi.org/deliver/etsi_ts/136100_136199/136143/13.00.00_60/ts_136143v130000p.pdf
TSDSI	TSDSI STD T1.3GPP 36.143-13.0.0 V1.0.0	13.0.0	30.05.2019	https://members.tdsi.in/index.php/s/BxBT9C9F8KxobBg
TTA	TTAT.3G-36.143(R13-13.0.0)	13.0.0	06.07.2017	http://www.tta.or.kr/data/ttasDown.jsp?where=14688&pk_num=TTAT.3G-36.143(R13-13.0.0)

Release 14

ATIS	ATIS.3GPP.36.143V1400	14.0.0	02.05.2019	https://www.atis.org/docstore/
CCSA	CCSA TSD LTE 36.143	14.0.0	11.01.2019	http://www.ccsa.org.cn/ITU_spec/ITU-R/M.2012/M.2012-4/LTE/REL-14/CCSA-TSD-LTE-36143-e00.zip
ETSI	ETSI TS 136 143	14.0.0	13.04.2017	http://www.etsi.org/deliver/etsi_ts/136100_136199/136143/14.00.00_60/ts_136143v140000p.pdf
TSDSI	TSDSI STD T1.3GPP 36.143-14.0.0 V1.0.0	14.0.0	30.05.2019	https://members.tdsi.in/index.php/s/BxBT9C9F8KxobBg
TTA	TTAT.3G-36.143(R14-14.0.0)	14.0.0	10.05.2018	http://www.tta.or.kr/data/ttasDown.jsp?where=14688&pk_num=TTAT.3G-36.143(R14-14.0.0)

2.1.5.13 TS 36.171**Evolved Universal Terrestrial Radio Access (E-UTRA); Requirements for Support of Assisted Global Navigation Satellite System (A-GNSS)**

This document establishes the minimum performance requirements for A-GNSS (including A-GPS) for FDD or TDD mode of E-UTRA for the User Equipment (UE).

SDO	Document No.	Version	Issued date	Location
Release 10				
ARIB	ARIB STD-T104-36.171		10.2.0	12.04.2018 http://www.arib.or.jp/english/html/overview/doc/STD-T104v5_20/2_T104/ARIB-STD-T104/Rel10/36/A36171-a20.pdf
ATIS	ATIS.3GPP.36.171V1020		10.2.0	02.05.2019 https://www.atis.org/docstore/
CCSA	CCSA TSD LTE 36.171		10.2.0	19.07.2013 http://www.ccsa.org.cn/ITU_spec/ITU-R/M.2012/M.2012-4/LTE/REL-10/CCSA-TSD-LTE-36171-a20.rar
ETSI	ETSI TS 136 171		10.2.0	19.07.2013 http://www.etsi.org/deliver/etsi_ts/136100_136199/136171/10.02.00_60/ts_136171v100200p.pdf
TSDSI	TSDSI STD T1.3GPP 36.171-10.2.0 V1.0.0		10.2.0	30.05.2019 https://members.tdsi.in/index.php/s/BxBT9C9F8KxobBg
TTA	TTAT.3G-36.171(R10-10.2.0)		10.2.0	10.08.2016 http://www.tta.or.kr/data/ttasDown.jsp?where=14688&pk_num=TTAT.3G-36.171(R10-10.2.0)
Release 11				
ARIB	ARIB STD-T104-36.171		11.1.0	12.04.2018 http://www.arib.or.jp/english/html/overview/doc/STD-T104v5_20/2_T104/ARIB-STD-T104/Rel11/36/A36171-b10.pdf
ATIS	ATIS.3GPP.36.171V1110		11.1.0	02.05.2019 https://www.atis.org/docstore/
CCSA	CCSA TSD LTE 36.171		11.1.0	19.07.2013 http://www.ccsa.org.cn/ITU_spec/ITU-R/M.2012/M.2012-4/LTE/REL-11/CCSA-TSD-LTE-36171-b10.rar
ETSI	ETSI TS 136 171		11.1.0	19.07.2013 http://www.etsi.org/deliver/etsi_ts/136100_136199/136171/11.01.00_60/ts_136171v110100p.pdf
TSDSI	TSDSI STD T1.3GPP 36.171-11.1.0 V1.0.0		11.1.0	30.05.2019 https://members.tdsi.in/index.php/s/BxBT9C9F8KxobBg
TTA	TTAT.3G-36.171(R11-11.1.0)		11.1.0	06.07.2017 http://www.tta.or.kr/data/ttasDown.jsp?where=14688&pk_num=TTAT.3G-36.171(R11-11.1.0)
Release 12				
ARIB	ARIB STD-T104-36.171		12.1.0	12.04.2018 http://www.arib.or.jp/english/html/overview/doc/STD-T104v5_20/2_T104/ARIB-STD-T104/Rel12/36/A36171-c10.pdf

ATIS	ATIS.3GPP.36.171V1210	12.1.0	02.05.2019	https://www.atis.org/docstore/
CCSA	CCSA TSD LTE 36.171	12.1.0	03.02.2015	http://www.ccsa.org.cn/ITU_spec/ITU-R/M.2012/M.2012-4/LTE/REL-12/CCSA-TSD-LTE-36171-c10.rar
ETSI	ETSI TS 136 171	12.1.0	03.02.2015	http://www.etsi.org/deliver/etsi_ts/136100_136199/136171/12.01.00_60/ts_136171v120100p.pdf
TSDSI	TSDSI STD T1.3GPP 36.171-12.1.0 V1.0.0	12.1.0	30.05.2019	https://members.tdsi.in/index.php/s/BxBT9C9F8KxobBg
TTA	TTAT.3G-36.171(R12-12.1.0)	12.1.0	09.04.2015	http://www.tta.or.kr/data/ttasDown.jsp?where=14688&pk_num=TTAT.3G-36.171(R12-12.1.0)
Release 13				
ARIB	ARIB STD-T104-36.171	13.0.0	12.04.2018	http://www.arib.or.jp/english/html/overview/doc/STD-T104v5_20/2_T104/ARIB-STD-T104/Rel13/36/A36171-d00.pdf
ATIS	ATIS.3GPP.36.171V1300	13.0.0	02.05.2019	https://www.atis.org/docstore/
CCSA	CCSA TSD LTE 36.171	13.0.0	28.01.2016	http://www.ccsa.org.cn/ITU_spec/ITU-R/M.2012/M.2012-4/LTE/REL-13/CCSA-TSD-LTE-36171-d00.rar
ETSI	ETSI TS 136 171	13.0.0	28.01.2016	http://www.etsi.org/deliver/etsi_ts/136100_136199/136171/13.00.00_60/ts_136171v130000p.pdf
TSDSI	TSDSI STD T1.3GPP 36.171-13.0.0 V1.0.0	13.0.0	30.05.2019	https://members.tdsi.in/index.php/s/BxBT9C9F8KxobBg
TTA	TTAT.3G-36.171(R13-13.0.0)	13.0.0	06.07.2017	http://www.tta.or.kr/data/ttasDown.jsp?where=14688&pk_num=TTAT.3G-36.171(R13-13.0.0)
Release 14				
ARIB	ARIB STD-T104-36.171	14.0.0	12.04.2018	http://www.arib.or.jp/english/html/overview/doc/STD-T104v5_20/2_T104/ARIB-STD-T104/Rel14/36/A36171-e00.pdf
ATIS	ATIS.3GPP.36.171V1400	14.0.0	02.05.2019	https://www.atis.org/docstore/
CCSA	CCSA TSD LTE 36.171	14.0.0	11.01.2019	http://www.ccsa.org.cn/ITU_spec/ITU-R/M.2012/M.2012-4/LTE/REL-14/CCSA-TSD-LTE-36171-e00.zip
ETSI	ETSI TS 136 171	14.0.0	13.04.2017	http://www.etsi.org/deliver/etsi_ts/136100_136199/136171/14.00.00_60/ts_136171v140000p.pdf
TSDSI	TSDSI STD T1.3GPP 36.171-14.0.0 V1.0.0	14.0.0	30.05.2019	https://members.tdsi.in/index.php/s/BxBT9C9F8KxobBg
TTA	TTAT.3G-36.171(R14-14.0.0)	14.0.0	10.05.2018	http://www.tta.or.kr/data/ttasDown.jsp?where=14688&pk_num=TTAT.3G-36.171(R14-14.0.0)

2.1.5.14 TS 36.307

Evolved Universal Terrestrial Radio Access (E-UTRA); Requirements on User Equipments (UEs) supporting a release-independent frequency band

This document specifies requirements on UEs supporting a frequency band that is independent of release. TSG-RAN has agreed that the standardization of new frequency bands may be independent of a release. However, in order to implement a UE that conforms to a particular release but supports a band of operation that is specified in a later release, it is necessary to specify some extra requirements. All frequency bands are fully specified in this release of the specifications. This document does not contain any requirements for UEs supporting frequency bands independent of release.

SDO	Document No.	Version	Issued date	Location
Release 10				
ARIB	ARIB STD-T104-36.307		10.22.0 12.04.2018	http://www.arib.or.jp/english/html/overview/doc/STD-T104v5_20/2_T104/ARIB-STD-T104/Rel10/36/A36307-am0.pdf
ATIS	ATIS.3GPP.36.307V10220		10.22.0 02.05.2019	https://www.atis.org/docstore/
CCSA	CCSA TSD LTE 36.307		10.22.0 27.07.2017	http://www.ccsa.org.cn/ITU_spec/ITU-R/M.2012/M.2012-4/LTE/REL-10/CCSA-TSD-LTE-36307-am0.rar
ETSI	ETSI TS 136 307		10.22.0 27.07.2017	http://www.etsi.org/deliver/etsi_ts/136300_136399/136307/10.22.00_60/ts_136307v102200p.pdf
TSDSI	TSDSI STD T1.3GPP 36.307-10.22.0 V1.0.0		10.22.0 30.05.2019	https://members.tdsi.in/index.php/s/BxBT9C9F8KxobBg
TTA	TTAT.3G-36.307(R10-10.22.0)		10.22.0 10.05.2018	http://www.tta.or.kr/data/ttasDown.jsp?where=14688&pk_num=TTAT.3G-36.307(R10-10.22.0)
Release 11				
ARIB	ARIB STD-T104-36.307		11.19.0 12.04.2018	http://www.arib.or.jp/english/html/overview/doc/STD-T104v5_20/2_T104/ARIB-STD-T104/Rel11/36/A36307-bj0.pdf
ATIS	ATIS.3GPP.36.307V11190		11.19.0 02.05.2019	https://www.atis.org/docstore/
CCSA	CCSA TSD LTE 36.307		11.19.0 27.07.2017	http://www.ccsa.org.cn/ITU_spec/ITU-R/M.2012/M.2012-4/LTE/REL-11/CCSA-TSD-LTE-36307-bj0.rar

84

ETSI	ETSI TS 136 307	11.19.0	27.07.2017	http://www.etsi.org/deliver/etsi_ts/136300_136399/136307/11.19.00_60/ts_136307v111900p.pdf
TSDSI	TSDSI STD T1.3GPP 36.307-11.19.0 V1.0.0	11.19.0	30.05.2019	https://members.tdsi.in/index.php/s/BxBT9C9F8KxobBg
TTA	TTAT.3G-36.307(R11-11.19.0)	11.19.0	10.05.2018	http://www.tta.or.kr/data/ttasDown.jsp?where=14688&pk_num=TTAT.3G-36.307(R11-11.19.0)

Release 12

ARIB	ARIB STD-T104-36.307	12.15.0	12.04.2018	http://www.arib.or.jp/english/html/overview/doc/STD-T104v5_20/2_T104/ARIB-STD-T104/Rel12/36/A36307-cf0.pdf
ATIS	ATIS.3GPP.36.307V12150	12.15.0	02.05.2019	https://www.atis.org/docstore/
CCSA	CCSA TSD LTE 36.307	12.15.0	27.07.2017	http://www.ccsa.org.cn/ITU_spec/ITU-R/M.2012/M.2012-4/LTE/REL-12/CCSA-TSD-LTE-36307-cf0.rar
ETSI	ETSI TS 136 307	12.15.0	27.07.2017	http://www.etsi.org/deliver/etsi_ts/136300_136399/136307/12.15.00_60/ts_136307v121500p.pdf
TSDSI	TSDSI STD T1.3GPP 36.307-12.15.0 V1.0.0	12.15.0	30.05.2019	https://members.tdsi.in/index.php/s/BxBT9C9F8KxobBg
TTA	TTAT.3G-36.307(R12-12.15.0)	12.15.0	10.05.2018	http://www.tta.or.kr/data/ttasDown.jsp?where=14688&pk_num=TTAT.3G-36.307(R12-12.15.0)

Release 13

ARIB	ARIB STD-T104-36.307	13.8.0	12.04.2018	http://www.arib.or.jp/english/html/overview/doc/STD-T104v5_20/2_T104/ARIB-STD-T104/Rel13/36/A36307-d80.pdf
ATIS	ATIS.3GPP.36.307V1380	13.8.0	02.05.2019	https://www.atis.org/docstore/
CCSA	CCSA TSD LTE 36.307	13.7.0	19.10.2017	http://www.ccsa.org.cn/ITU_spec/ITU-R/M.2012/M.2012-4/LTE/REL-13/CCSA-TSD-LTE-36307-d70.rar
ETSI	ETSI TS 136 307	13.8.0	19.10.2017	http://www.etsi.org/deliver/etsi_ts/136300_136399/136307/13.08.00_60/ts_136307v130800p.pdf
TSDSI	TSDSI STD T1.3GPP 36.307-13.8.0 V1.0.0	13.8.0	30.05.2019	https://members.tdsi.in/index.php/s/BxBT9C9F8KxobBg
TTA	TTAT.3G-36.307(R13-13.8.0)	13.8.0	10.05.2018	http://www.tta.or.kr/data/ttasDown.jsp?where=14688&pk_num=TTAT.3G-36.307(R13-13.8.0)

Release 14

ARIB	ARIB STD-T104-36.307	14.4.0	12.04.2018	http://www.arib.or.jp/english/html/overview/doc/STD-T104v5_20/2_T104/ARIB-STD-T104/Rel14/36/A36307-e40.pdf
ATIS	ATIS.3GPP.36.307V1440	14.4.0	02.05.2019	https://www.atis.org/docstore/
CCSA	CCSA TSD LTE 36.307	14.4.0	11.01.2019	http://www.ccsa.org.cn/ITU_spec/ITU-R/M.2012/M.2012-4/LTE/REL-14/CCSA-TSD-LTE-36307-e40.zip
ETSI	ETSI TS 136 307	14.4.0	19.10.2017	http://www.etsi.org/deliver/etsi_ts/136300_136399/136307/14.04.00_60/ts_136307v140400p.pdf
TSDSI	TSDSI STD T1.3GPP 36.307-14.4.0 V1.0.0	14.4.0	30.05.2019	https://members.tdsi.in/index.php/s/BxBT9C9F8KxobBg
TTA	TTAT.3G-36.307(R14-14.4.0)	14.4.0	10.05.2018	http://www.tta.or.kr/data/ttasDown.jsp?where=14688&pk_num=TTAT.3G-36.307(R14-14.4.0)

2.1.5.15 TS 37.104

E-UTRA, UTRA and GSM/EDGE; Multi-Standard Radio (MSR) Base Station (BS) radio transmission and reception

This document establishes the minimum RF characteristics of E-UTRA, UTRA and GSM/EDGE Multi-Standard Radio (MSR) Base Station (BS). Requirements for multi-RAT and single-RAT operation of MSR BS are covered in this document. The requirements in this document for E-UTRA and UTRA single-RAT operation of MSR BS are also applicable to E-UTRA and UTRA multi-carrier capable single-RAT BS. Requirements for GSM BS that are only single-RAT capable are not covered.

SDO	Document No.	Version	Issued date	Location
-----	--------------	---------	-------------	----------

Release 10

ATIS	ATIS.3GPP.37.104V10140	10.14.0	02.05.2019	https://www.atis.org/docstore/
CCSA	CCSA TSD LTE 37.104	10.14.0	03.04.2014	http://www.ccsa.org.cn/ITU_spec/ITU-R/M.2012/M.2012-4/LTE/REL-10/CCSA-TSD-LTE-37104-ae0.rar
ETSI	ETSI TS 137 104	10.14.0	03.04.2014	http://www.etsi.org/deliver/etsi_ts/137100_137199/137104/10.14.00_60/ts_137104v101400p.pdf
TSDSI	TSDSI STD T1.3GPP 37.104-10.14.0 V1.0.0	10.14.0	30.05.2019	https://members.tdsi.in/index.php/s/BxBT9C9F8KxobBg
TTA	TTAT.3G-37.104(R10-10.14.0)	10.14.0	10.08.2016	http://www.tta.or.kr/data/ttasDown.jsp?where=14688&pk_num=TTAT.3G-37.104(R10-10.14.0)

Release 11

ATIS	ATIS.3GPP.37.104V11140	11.14.0	02.05.2019	https://www.atis.org/docstore/
CCSA	CCSA TSD LTE 37.104	11.14.0	25.04.2016	http://www.ccsa.org.cn/ITU_spec/ITU-R/M.2012/M.2012-4/LTE/REL-11/CCSA-TSD-LTE-37104-be0.rar

ETSI	ETSI TS 137 104	11.14.0	25.04.2016	http://www.etsi.org/deliver/etsi_ts/137100_137199/137104/11.14.00_60/ts_137104v111400p.pdf
TSDSI	TSDSI STD T1.3GPP 37.104-11.14.0 V1.0.0	11.14.0	30.05.2019	https://members.tdsi.in/index.php/s/BxBT9C9F8KxobBg
TTA	TTAT.3G-37.104(R11-11.14.0)	11.14.0	06.07.2017	http://www.tta.or.kr/data/ttasDown.jsp?where=14688&pk_num=TTAT.3G-37.104(R11-11.14.0)

Release 12

ATIS	ATIS.3GPP.37.104V12130	12.13.0	02.05.2019	https://www.atis.org/docstore/
CCSA	CCSA TSD LTE 37.104	12.13.0	24.08.2017	http://www.ccsa.org.cn/ITU_spec/ITU-R/M.2012/M.2012-4/LTE/REL-12/CCSA-TSD-LTE-37104-cd0.rar
ETSI	ETSI TS 137 104	12.13.0	24.08.2017	http://www.etsi.org/deliver/etsi_ts/137100_137199/137104/12.13.00_60/ts_137104v121300p.pdf
TSDSI	TSDSI STD T1.3GPP 37.104-12.13.0 V1.0.0	12.13.0	30.05.2019	https://members.tdsi.in/index.php/s/BxBT9C9F8KxobBg
TTA	TTAT.3G-37.104(R12-12.13.0)	12.13.0	10.05.2018	http://www.tta.or.kr/data/ttasDown.jsp?where=14688&pk_num=TTAT.3G-37.104(R12-12.13.0)

Release 13

ATIS	ATIS.3GPP.37.104V1380	13.8.0	02.05.2019	https://www.atis.org/docstore/
CCSA	CCSA TSD LTE 37.104	13.6.0	25.01.2018	http://www.ccsa.org.cn/ITU_spec/ITU-R/M.2012/M.2012-4/LTE/REL-13/CCSA-TSD-LTE-37104-d60.rar
ETSI	ETSI TS 137 104	13.8.0	25.01.2018	http://www.etsi.org/deliver/etsi_ts/137100_137199/137104/13.08.00_60/ts_137104v130800p.pdf
TSDSI	TSDSI STD T1.3GPP 37.104-13.8.0 V1.0.0	13.8.0	30.05.2019	https://members.tdsi.in/index.php/s/BxBT9C9F8KxobBg
TTA	TTAT.3G-37.104(R13-13.8.0)	13.8.0	09.05.2019	http://www.tta.or.kr/data/ttasDown.jsp?where=14688&pk_num=TTAT.3G-37.104(R13-13.8.0)

Release 14

ATIS	ATIS.3GPP.37.104V1460	14.6.0	02.05.2019	https://www.atis.org/docstore/
CCSA	CCSA TSD LTE 37.104	14.6.0	11.01.2019	http://www.ccsa.org.cn/ITU_spec/ITU-R/M.2012/M.2012-4/LTE/REL-14/CCSA-TSD-LTE-37104-e60.zip
ETSI	ETSI TS 137 104	14.6.0	25.01.2018	http://www.etsi.org/deliver/etsi_ts/137100_137199/137104/14.06.00_60/ts_137104v140600p.pdf
TSDSI	TSDSI STD T1.3GPP 37.104-14.6.0 V1.0.0	14.6.0	30.05.2019	https://members.tdsi.in/index.php/s/BxBT9C9F8KxobBg
TTA	TTAT.3G-37.104(R14-14.6.0)	14.6.0	09.05.2019	http://www.tta.or.kr/data/ttasDown.jsp?where=14688&pk_num=TTAT.3G-37.104(R14-14.6.0)

2.1.5.16 TS 37.105

Active Antenna System (AAS) Base Station (BS) transmission and reception

This document establishes the RF characteristics, the RF minimum requirements and minimum performance requirements for E-UTRA AAS Base Station (BS), the FDD mode of UTRA AAS Base Station (BS), the 1,28 Mchip/s TDD mode of UTRA AAS Base Station (BS) in single RAT and any MSR AAS Base Station (BS) implementation of these RATs.

SDO	Document No.	Version	Issued date	Location
Release 13				
ATIS	ATIS.3GPP.37.105V1360		13.6.0	02.05.2019 https://www.atis.org/docstore/
CCSA	CCSA TSD LTE 37.105		13.5.0	19.10.2017 http://www.ccsa.org.cn/ITU_spec/ITU-R/M.2012/M.2012-4/LTE/REL-13/CCSA-TSD-LTE-37105-d50.rar
ETSI	ETSI TS 137 105		13.6.0	19.10.2017 http://www.etsi.org/deliver/etsi_ts/137100_137199/137105/13.06.00_60/ts_137105v130600p.pdf
TSDSI	TSDSI STD T1.3GPP 37.105-13.6.0 V1.0.0		13.6.0	30.05.2019 https://members.tdsi.in/index.php/s/BxBT9C9F8KxobBg
TTA	TTAT.3G-37.105(R13-13.6.0)		13.6.0	10.05.2018 http://www.tta.or.kr/data/ttasDown.jsp?where=14688&pk_num=TTAT.3G-37.105(R13-13.6.0)
Release 14				
ATIS	ATIS.3GPP.37.105V1420		14.2.0	02.05.2019 https://www.atis.org/docstore/
CCSA	CCSA TSD LTE 37.105		14.2.0	11.01.2019 http://www.ccsa.org.cn/ITU_spec/ITU-R/M.2012/M.2012-4/LTE/REL-14/CCSA-TSD-LTE-37105-e20.zip
ETSI	ETSI TS 137 105		14.2.0	19.10.2017 http://www.etsi.org/deliver/etsi_ts/137100_137199/137105/14.02.00_60/ts_137105v140200p.pdf
TSDSI	TSDSI STD T1.3GPP 37.105-14.2.0 V1.0.0		14.2.0	30.05.2019 https://members.tdsi.in/index.php/s/BxBT9C9F8KxobBg
TTA	TTAT.3G-37.105(R14-14.2.0)		14.2.0	10.05.2018 http://www.tta.or.kr/data/ttasDown.jsp?where=14688&pk_num=TTAT.3G-37.105(R14-14.2.0)

2.1.5.17 TS 37.113

E-UTRA, UTRA and GSM/EDGE; Multi-Standard Radio (MSR) Base Station (BS) Electromagnetic Compatibility (EMC)

This document covers the assessment of E-UTRA, UTRA and GSM/EDGE Multi-Standard Radio (MSR) Base Stations and associated ancillary equipment in respect of Electromagnetic Compatibility (EMC). This document specifies the applicable test conditions, performance assessment and performance criteria for E-UTRA, UTRA and GSM/EDGE Base Stations and associated ancillary equipment in one of the following categories: (i) Multi-Standard Radio (MSR) Base Stations for E-UTRA, UTRA and GSM/EDGE meeting the requirements of TS 37.104, with conformance demonstrated by compliance to TS 37.141; (ii) Base Stations for E-UTRA meeting the requirements of TS 36.104, with conformance demonstrated by compliance to TS 36.141; (iii) Base Stations for UTRA FDD meeting the requirements of TS 25.104, with conformance demonstrated by compliance to TS 25.141; (iv) Base Stations for UTRA TDD meeting the requirements of TS 25.105, with conformance demonstrated by compliance to TS 25.142; (v) Base Stations for GSM/EDGE meeting the requirements of TS 45.005, with conformance demonstrated by compliance to TS 51.021. The environment classification used in this document refers to the environment classification used in IEC 61000-6-1 and IEC 61000-6-3.

The EMC requirements have been selected to ensure an adequate level of compatibility for apparatus at residential, commercial and light industrial environments. The levels, however, do not cover extreme cases which may occur in any location but with low probability of occurrence.

SDO	Document No.	Version	Issued date	Location
Release 10				
ATIS	ATIS.3GPP.37.113V1050		10.5.0	02.05.2019 https://www.atis.org/docstore/
CCSA	CCSA TSD LTE 37.113		10.5.0	02.08.2016 http://www.ccsa.org.cn/ITU_spec/ITU-R/M.2012/M.2012-4/LTE/REL-10/CCSA-TSD-LTE-37113-a50.rar
ETSI	ETSI TS 137 113		10.5.0	02.08.2016 http://www.etsi.org/deliver/etsi_ts/137100_137199/137113/10.05.00_60/ts_137113v100500p.pdf
TSDSI	TSDSI STD T1.3GPP 37.113-10.5.0 V1.0.0		10.5.0	30.05.2019 https://members.tdsi.in/index.php/s/BxBT9C9F8KxobBg
TTA	TTAT.3G-37.113(R10-10.5.0)		10.5.0	06.07.2017 http://www.tta.or.kr/data/ttasDown.jsp?where=14688&pk_num=TTAT.3G-37.113(R10-10.5.0)
Release 11				
ATIS	ATIS.3GPP.37.113V1140		11.4.0	02.05.2019 https://www.atis.org/docstore/
CCSA	CCSA TSD LTE 37.113		11.4.0	02.08.2016 http://www.ccsa.org.cn/ITU_spec/ITU-R/M.2012/M.2012-4/LTE/REL-11/CCSA-TSD-LTE-37113-b40.rar
ETSI	ETSI TS 137 113		11.4.0	02.08.2016 http://www.etsi.org/deliver/etsi_ts/137100_137199/137113/11.04.00_60/ts_137113v110400p.pdf
TSDSI	TSDSI STD T1.3GPP 37.113-11.4.0 V1.0.0		11.4.0	30.05.2019 https://members.tdsi.in/index.php/s/BxBT9C9F8KxobBg
TTA	TTAT.3G-37.113(R11-11.4.0)		11.4.0	06.07.2017 http://www.tta.or.kr/data/ttasDown.jsp?where=14688&pk_num=TTAT.3G-37.113(R11-11.4.0)
Release 12				
ATIS	ATIS.3GPP.37.113V1240		12.4.0	02.05.2019 https://www.atis.org/docstore/
CCSA	CCSA TSD LTE 37.113		12.4.0	02.08.2016 http://www.ccsa.org.cn/ITU_spec/ITU-R/M.2012/M.2012-4/LTE/REL-12/CCSA-TSD-LTE-37113-c40.rar
ETSI	ETSI TS 137 113		12.4.0	02.08.2016 http://www.etsi.org/deliver/etsi_ts/137100_137199/137113/12.04.00_60/ts_137113v120400p.pdf
TSDSI	TSDSI STD T1.3GPP 37.113-12.4.0 V1.0.0		12.4.0	30.05.2019 https://members.tdsi.in/index.php/s/BxBT9C9F8KxobBg
TTA	TTAT.3G-37.113(R12-12.4.0)		12.4.0	06.07.2017 http://www.tta.or.kr/data/ttasDown.jsp?where=14688&pk_num=TTAT.3G-37.113(R12-12.4.0)
Release 13				
ATIS	ATIS.3GPP.37.113V1340		13.4.0	02.05.2019 https://www.atis.org/docstore/
CCSA	CCSA TSD LTE 37.113		13.4.0	24.08.2017 http://www.ccsa.org.cn/ITU_spec/ITU-R/M.2012/M.2012-4/LTE/REL-13/CCSA-TSD-LTE-37113-d40.rar
ETSI	ETSI TS 137 113		13.4.0	24.08.2017 http://www.etsi.org/deliver/etsi_ts/137100_137199/137113/13.04.00_60/ts_137113v130400p.pdf
TSDSI	TSDSI STD T1.3GPP 37.113-13.4.0 V1.0.0		13.4.0	30.05.2019 https://members.tdsi.in/index.php/s/BxBT9C9F8KxobBg
TTA	TTAT.3G-37.113(R13-13.4.0)		13.4.0	10.05.2018 http://www.tta.or.kr/data/ttasDown.jsp?where=14688&pk_num=TTAT.3G-37.113(R13-13.4.0)

Release 14

ATIS	ATIS.3GPP.37.113V1420	14.2.0	02.05.2019	https://www.atis.org/docstore/
CCSA	CCSA TSD LTE 37.113	14.2.0	11.01.2019	http://www.ccsa.org.cn/ITU_spec/ITU-R/M.2012/M.2012-4/LTE/REL-14/CCSA-TSD-LTE-37113-e20.zip
ETSI	ETSI TS 137 113	14.2.0	24.08.2017	http://www.etsi.org/deliver/etsi_ts/137100_137199/137113/14.02.00_60/ts_137113v140200p.pdf
TSDSI	TSDSI STD T1.3GPP 37.113-14.2.0 V1.0.0	14.2.0	30.05.2019	https://members.tdsi.in/index.php/s/BxBT9C9F8KxobBg
TTA	TTAT.3G-37.113(R14-14.2.0)	14.2.0	10.05.2018	http://www.tta.or.kr/data/ttasDown.jsp?where=14688&pk_num=TTAT.3G-37.113(R14-14.2.0)

2.1.5.18 TS 37.114**Active Antenna System (AAS) Base Station (BS) Electromagnetic Compatibility (EMC)**

This document covers the assessment of E-UTRA, UTRA and Multi-Standard Radio (MSR) Active Antenna Systems Base Stations in respect of Electromagnetic Compatibility (EMC).

This document specifies the applicable test conditions, performance assessment and performance criteria for E-UTRA and UTRA Base Stations and associated ancillary equipment in one of the following categories:

- Active Antenna System Base Station for E-UTRA, UTRA and MSR meeting the requirements of 3GPP TS 37.105, with conformance demonstrated by compliance to 3GPP TS 37.145.

The scope of this document is AAS BS with TAB connectors for every transceiver unit at the Transceiver Array Boundary. Requirement, procedures and values of an AAS Base Station without TAB connectors are not included in this document and are FFS.

The environment classification used in this document refers to the residential, commercial and light industrial environment classification used in IEC 61000-6-1 and IEC 61000-6-3.

The EMC requirements have been selected to ensure an adequate level of compatibility for apparatus at residential, commercial and light industrial environments. The levels, however, do not cover extreme cases which may occur in any location but with low probability of occurrence.

SDO	Document No.	Version	Issued date	Location
-----	--------------	---------	-------------	----------

Release 13

ATIS	ATIS.3GPP.37.114V1330	13.3.0	02.05.2019	https://www.atis.org/docstore/
CCSA	CCSA TSD LTE 37.114	13.3.0	24.08.2017	http://www.ccsa.org.cn/ITU_spec/ITU-R/M.2012/M.2012-4/LTE/REL-13/CCSA-TSD-LTE-37114-d30.rar
ETSI	ETSI TS 137 114	13.3.0	24.08.2017	http://www.etsi.org/deliver/etsi_ts/137100_137199/137114/13.03.00_60/ts_137114v130300p.pdf
TSDSI	TSDSI STD T1.3GPP 37.114-13.3.0 V1.0.0	13.3.0	30.05.2019	https://members.tdsi.in/index.php/s/BxBT9C9F8KxobBg
TTA	TTAT.3G-37.114(R13-13.3.0)	13.3.0	10.05.2018	http://www.tta.or.kr/data/ttasDown.jsp?where=14688&pk_num=TTAT.3G-37.114(R13-13.3.0)

Release 14

ATIS	ATIS.3GPP.37.114V1410	14.1.0	02.05.2019	https://www.atis.org/docstore/
CCSA	CCSA TSD LTE 37.114	14.1.0	11.01.2019	http://www.ccsa.org.cn/ITU_spec/ITU-R/M.2012/M.2012-4/LTE/REL-14/CCSA-TSD-LTE-37114-e10.zip
ETSI	ETSI TS 137 114	14.1.0	24.08.2017	http://www.etsi.org/deliver/etsi_ts/137100_137199/137114/14.01.00_60/ts_137114v140100p.pdf
TSDSI	TSDSI STD T1.3GPP 37.114-14.1.0 V1.0.0	14.1.0	30.05.2019	https://members.tdsi.in/index.php/s/BxBT9C9F8KxobBg
TTA	TTAT.3G-37.114(R14-14.1.0)	14.1.0	10.05.2018	http://www.tta.or.kr/data/ttasDown.jsp?where=14688&pk_num=TTAT.3G-37.114(R14-14.1.0)

2.1.5.19 TS 37.141**E-UTRA, UTRA and GSM/EDGE; Multi-Standard Radio (MSR) Base Station (BS) conformance testing**

This document specifies the Radio Frequency (RF) test methods and conformance requirements for E-UTRA, UTRA and GSM/EDGE Multi-Standard Radio (MSR) Base Station (BS).

SDO	Document No.	Version	Issued date	Location
Release 10				
ATIS	ATIS.3GPP.37.141V10140		10.14.0	02.05.2019 https://www.atis.org/docstore/
CCSA	CCSA TSD LTE 37.141		10.14.0	04.02.2015 http://www.ccsa.org.cn/ITU_spec/ITU-R/M.2012/M.2012-4/LTE/REL-10/CCSA-TSD-LTE-37141-ae0.rar
ETSI	ETSI TS 137 141		10.14.0	04.02.2015 http://www.etsi.org/deliver/etsi_ts/137100_137199/137141/10.14.00_60/ts_137141v101400p.pdf
TSDSI	TSDSI STD T1.3GPP 37.141-10.14.0 V1.0.0		10.14.0	30.05.2019 https://members.tdsi.in/index.php/s/BxBT9C9F8KxobBg
TTA	TTAT.3G-37.141(R10-10.14.0)		10.14.0	10.08.2016 http://www.tta.or.kr/data/ttasDown.jsp?where=14688&pk_num=TTAT.3G-37.141(R10-10.14.0)
Release 11				
ATIS	ATIS.3GPP.37.141V11150		11.15.0	02.05.2019 https://www.atis.org/docstore/
CCSA	CCSA TSD LTE 37.141		11.15.0	14.10.2016 http://www.ccsa.org.cn/ITU_spec/ITU-R/M.2012/M.2012-4/LTE/REL-11/CCSA-TSD-LTE-37141-bf0.rar
ETSI	ETSI TS 137 141		11.15.0	14.10.2016 http://www.etsi.org/deliver/etsi_ts/137100_137199/137141/11.15.00_60/ts_137141v111500p.pdf
TSDSI	TSDSI STD T1.3GPP 37.141-11.15.0 V1.0.0		11.15.0	30.05.2019 https://members.tdsi.in/index.php/s/BxBT9C9F8KxobBg
TTA	TTAT.3G-37.141(R11-11.15.0)		11.15.0	06.07.2017 http://www.tta.or.kr/data/ttasDown.jsp?where=14688&pk_num=TTAT.3G-37.141(R11-11.15.0)
Release 12				
ATIS	ATIS.3GPP.37.141V12130		12.13.0	02.05.2019 https://www.atis.org/docstore/
CCSA	CCSA TSD LTE 37.141		12.13.0	28.08.2017 http://www.ccsa.org.cn/ITU_spec/ITU-R/M.2012/M.2012-4/LTE/REL-12/CCSA-TSD-LTE-37141-cd0.rar
ETSI	ETSI TS 137 141		12.13.0	28.08.2017 http://www.etsi.org/deliver/etsi_ts/137100_137199/137141/12.13.00_60/ts_137141v121300p.pdf
TSDSI	TSDSI STD T1.3GPP 37.141-12.13.0 V1.0.0		12.13.0	30.05.2019 https://members.tdsi.in/index.php/s/BxBT9C9F8KxobBg
TTA	TTAT.3G-37.141(R12-12.13.0)		12.13.0	10.05.2018 http://www.tta.or.kr/data/ttasDown.jsp?where=14688&pk_num=TTAT.3G-37.141(R12-12.13.0)
Release 13				
ATIS	ATIS.3GPP.37.141V1390		13.9.0	02.05.2019 https://www.atis.org/docstore/
CCSA	CCSA TSD LTE 37.141		13.7.0	26.01.2018 http://www.ccsa.org.cn/ITU_spec/ITU-R/M.2012/M.2012-4/LTE/REL-13/CCSA-TSD-LTE-37141-d70.rar
ETSI	ETSI TS 137 141		13.9.0	26.01.2018 http://www.etsi.org/deliver/etsi_ts/137100_137199/137141/13.09.00_60/ts_137141v130900p.pdf
TSDSI	TSDSI STD T1.3GPP 37.141-13.9.0 V1.0.0		13.9.0	30.05.2019 https://members.tdsi.in/index.php/s/BxBT9C9F8KxobBg
TTA	TTAT.3G-37.141(R13-13.9.0)		13.9.0	09.05.2019 http://www.tta.or.kr/data/ttasDown.jsp?where=14688&pk_num=TTAT.3G-37.141(R13-13.9.0)
Release 14				
ATIS	ATIS.3GPP.37.141V1460		14.6.0	02.05.2019 https://www.atis.org/docstore/
CCSA	CCSA TSD LTE 37.141		14.6.0	11.01.2019 http://www.ccsa.org.cn/ITU_spec/ITU-R/M.2012/M.2012-4/LTE/REL-14/CCSA-TSD-LTE-37141-e60.zip
ETSI	ETSI TS 137 141		14.6.0	26.01.2018 http://www.etsi.org/deliver/etsi_ts/137100_137199/137141/14.06.00_60/ts_137141v140600p.pdf
TSDSI	TSDSI STD T1.3GPP 37.141-14.6.0 V1.0.0		14.6.0	30.05.2019 https://members.tdsi.in/index.php/s/BxBT9C9F8KxobBg
TTA	TTAT.3G-37.141(R14-14.6.0)		14.6.0	09.05.2019 http://www.tta.or.kr/data/ttasDown.jsp?where=14688&pk_num=TTAT.3G-37.141(R14-14.6.0)

2.1.5.20 TS 37.144**User Equipment (UE) and Mobile Station (MS) GSM, UTRA and E-UTRA over the air performance requirements**

This document establishes over the air antenna minimum requirements for user equipment (UE) and mobile station (MS).

Handheld UE requirements are defined for roaming bands for the speech position (beside the head and beside the head and hand) and hand phantom browsing mode position. Laptop mounted equipment requirements are defined for roaming bands for the data transfer position (laptop ground plane phantom). Laptop embedded equipment requirements are defined for roaming bands for the data transfer position (free space).

All bands are potential roaming bands, and the requirements for roaming bands shall therefore be fulfilled for all bands supported by a UE/MS.

Requirements for operating bands are dependent on how the network has been built and are thus operator specific and cannot be specified here. Recommended performance values for operating bands (Annex B) are however included in this specification for information. It should be recognised that the ability to meet the recommended performance values depends on the number of frequency bands supported by the UE/MS.

SDO	Document No.	Version	Issued date	Location
Release 13				
ATIS	ATIS.3GPP.37.144V1300		13.0.0	02.05.2019 https://www.atis.org/docstore/
CCSA	CCSA TSD LTE 37.144		13.0.0	02.08.2016 http://www.ccsa.org.cn/ITU_spec/ITU-R/M.2012/M.2012-4/LTE/REL-13/CCSA-TSD-LTE-37144-d00.rar
ETSI	ETSI TS 137 144		13.0.0	02.08.2016 http://www.etsi.org/deliver/etsi_ts/137100_137199/137144/13.00.00_60/ts_137144v130000p.pdf
TSDSI	TSDSI STD T1.3GPP 37.144-13.0.0 V1.0.0		13.0.0	30.05.2019 https://members.tdsi.in/index.php/s/BxBT9C9F8KxobBg
TTA	TTAT.3G-37.144(R13-13.0.0)		13.0.0	06.07.2017 http://www.tta.or.kr/data/ttasDown.jsp?where=14688&pk_num=TTAT.3G-37.144(R13-13.0.0)
Release 14				
ATIS	ATIS.3GPP.37.144V1450		14.5.0	02.05.2019 https://www.atis.org/docstore/
CCSA	CCSA TSD LTE 37.144		14.5.0	11.01.2019 http://www.ccsa.org.cn/ITU_spec/ITU-R/M.2012/M.2012-4/LTE/REL-14/CCSA-TSD-LTE-37144-e50.zip
ETSI	ETSI TS 137 144		14.5.0	25.01.2018 http://www.etsi.org/deliver/etsi_ts/137100_137199/137144/14.05.00_60/ts_137144v140500p.pdf
TSDSI	TSDSI STD T1.3GPP 37.144-14.5.0 V1.0.0		14.5.0	30.05.2019 https://members.tdsi.in/index.php/s/BxBT9C9F8KxobBg
TTA	TTAT.3G-37.144(R14-14.5.0)		14.5.0	09.05.2019 http://www.tta.or.kr/data/ttasDown.jsp?where=14688&pk_num=TTAT.3G-37.144(R14-14.5.0)

2.1.5.21 TS 37.145-1

Active Antenna System (AAS) Base Station (BS) conformance testing; Part 1: conducted conformance testing

This document specifies the Radio Frequency (RF) test methods and conformance requirements for Single RAT E-UTRA, UTRA and Multi-Standard Radio (MSR) UTRA and EUTRA Active Antenna System (AAS) Base Station (BS). These have been derived from, and are consistent with the E-UTRA, UTRA AAS BS specification defined in 3GPP TS 25.104. The technical specification is in two parts: part 1 (this document) covers conducted requirements and part 2 covers radiated requirements.

SDO	Document No.	Version	Issued date	Location
Release 13				
ATIS	ATIS.3GPP.37.145-1V1340		13.4.0	02.05.2019 https://www.atis.org/docstore/
CCSA	CCSA TSD LTE 37.145-1		13.3.0	19.10.2017 http://www.ccsa.org.cn/ITU_spec/ITU-R/M.2012/M.2012-4/LTE/REL-13/CCSA-TSD-LTE-37145-1-d30.rar
ETSI	ETSI TS 137 145-1		13.4.0	19.10.2017 http://www.etsi.org/deliver/etsi_ts/137100_137199/13714501/13.04.00_60/ts_13714501v130400p.pdf
TSDSI	TSDSI STD T1.3GPP 37.145-1-13.4.0 V1.0.0		13.4.0	30.05.2019 https://members.tdsi.in/index.php/s/BxBT9C9F8KxobBg
TTA	TTAT.3G-37.145-1(R13-13.4.0)		13.4.0	10.05.2018 http://www.tta.or.kr/data/ttasDown.jsp?where=14688&pk_num=TTAT.3G-37.145-1(R13-13.4.0)
Release 14				
ATIS	ATIS.3GPP.37.145-1V1420		14.2.0	02.05.2019 https://www.atis.org/docstore/
CCSA	CCSA TSD LTE 37.145-1		14.2.0	11.01.2019 http://www.ccsa.org.cn/ITU_spec/ITU-R/M.2012/M.2012-4/LTE/REL-14/CCSA-TSD-LTE-37145-1-e20.zip

ETSI	ETSI TS 137 145-1	14.2.0	19.10.2017	http://www.etsi.org/deliver/etsi_ts/137100_137199/13714501/14.02.00_60/ts_13714501v140200p.pdf
TSDSI	TSDSI STD T1.3GPP 37.145-1-14.2.0 V1.0.0	14.2.0	30.05.2019	https://members.tdsi.in/index.php/s/BxBT9C9F8KxobBg
TTA	TTAT.3G-37.145-1(R14-14.2.0)	14.2.0	10.05.2018	http://www.tta.or.kr/data/ttasDown.jsp?where=14688&pk_num=TTAT.3G-37.145-1(R14-14.2.0)

2.1.5.22 TS 37.145-2

Active Antenna System (AAS) Base Station (BS) conformance testing; Part 2: radiated conformance testing

This document specifies the Radio Frequency (RF) test methods and conformance requirements for Single RAT E-UTRA, UTRA and Multi-Standard Radio (MSR) UTRA and EUTRA Active Antenna System (AAS) Base Station (BS). These have been derived from, and are consistent with the E-UTRA, UTRA AAS BS specification defined in 3GPP TS 25.104. The technical specification is in 2 parts, part 1 covers conducted requirements and part 2 (this document) covers radiated requirements.

SDO	Document No.	Version	Issued date	Location
Release 13				
ATIS	ATIS.3GPP.37.145-2V1350		13.5.0	02.05.2019 https://www.atis.org/docstore/
CCSA	CCSA TSD LTE 37.145-2		13.3.0	25.01.2018 http://www.ccsa.org.cn/ITU_spec/ITU-R/M.2012/M.2012-4/LTE/REL-13/CCSA-TSD-LTE-37145-2-d30.rar
ETSI	ETSI TS 137 145-2		13.5.0	25.01.2018 http://www.etsi.org/deliver/etsi_ts/137100_137199/13714502/13.05.00_60/ts_13714502v130500p.pdf
TSDSI	TSDSI STD T1.3GPP 37.145-2-13.5.0 V1.0.0		13.5.0	30.05.2019 https://members.tdsi.in/index.php/s/BxBT9C9F8KxobBg
TTA	TTAT.3G-37.145-2(R13-13.5.0)		13.5.0	09.05.2019 http://www.tta.or.kr/data/ttasDown.jsp?where=14688&pk_num=TTAT.3G-37.145-2(R13-13.5.0)
Release 14				
ATIS	ATIS.3GPP.37.145-2V1430		14.3.0	02.05.2019 https://www.atis.org/docstore/
CCSA	CCSA TSD LTE 37.145-2		14.3.0	11.01.2019 http://www.ccsa.org.cn/ITU_spec/ITU-R/M.2012/M.2012-4/LTE/REL-14/CCSA-TSD-LTE-37145-2-e30.zip
ETSI	ETSI TS 137 145-2		14.3.0	25.01.2018 http://www.etsi.org/deliver/etsi_ts/137100_137199/13714502/14.03.00_60/ts_13714502v140300p.pdf
TSDSI	TSDSI STD T1.3GPP 37.145-2-14.3.0 V1.0.0		14.3.0	30.05.2019 https://members.tdsi.in/index.php/s/BxBT9C9F8KxobBg
TTA	TTAT.3G-37.145-2(R14-14.3.0)		14.3.0	09.05.2019 http://www.tta.or.kr/data/ttasDown.jsp?where=14688&pk_num=TTAT.3G-37.145-2(R14-14.3.0)

2.1.5.23 TS 37.171

Universal Terrestrial Radio Access (UTRA) and Evolved UTRA (E-UTRA); User Equipment (UE) performance requirements for RAT-Independent Positioning Enhancements

This document establishes the minimum performance requirements for RAT-Independent Positioning Enhancements (e.g. MBS positioning technology) for FDD or TDD mode of UTRA and E-UTRA for the User Equipment (UE).

SDO	Document No.	Version	Issued date	Location
Release 13				
ARIB	ARIB STD-T104-37.171		13.1.0	12.04.2018 http://www.arib.or.jp/english/html/overview/doc/STD-T104v5_20/2_T104/ARIB-STD-T104/Rel13/37/A37171-d10.pdf
ATIS	ATIS.3GPP.37.171V1310		13.1.0	02.05.2019 https://www.atis.org/docstore/
CCSA	CCSA TSD LTE 37.171		13.1.0	27.01.2017 http://www.ccsa.org.cn/ITU_spec/ITU-R/M.2012/M.2012-4/LTE/REL-13/CCSA-TSD-LTE-37171-d10.rar
ETSI	ETSI TS 137 171		13.1.0	27.01.2017 http://www.etsi.org/deliver/etsi_ts/137100_137199/137171/13.01.00_60/ts_137171v130100p.pdf
TSDSI	TSDSI STD T1.3GPP 37.171-13.1.0 V1.0.0		13.1.0	30.05.2019 https://members.tdsi.in/index.php/s/BxBT9C9F8KxobBg
TTA	TTAT.3G-37.171(R13-13.1.0)		13.1.0	10.05.2018 http://www.tta.or.kr/data/ttasDown.jsp?where=14688&pk_num=TTAT.3G-37.171(R13-13.1.0)

Release 14

ARIB	ARIB STD-T104-37.171	14.4.0	12.04.2018	http://www.arib.or.jp/english/html/overview/doc/STD-T104v5_20/2_T104/ARIB-STD-T104/Rel14/37/A37171-e40.pdf
ATIS	ATIS.3GPP.37.171V1440	14.4.0	02.05.2019	https://www.atis.org/docstore/
CCSA	CCSA TSD LTE 37.171	14.4.0	11.01.2019	http://www.ccsa.org.cn/ITU_spec/ITU-R/M.2012/M.2012-4/LTE/REL-14/CCSA-TSD-LTE-37171-e40.zip
ETSI	ETSI TS 137 171	14.4.0	29.01.2018	http://www.etsi.org/deliver/etsi_ts/137100_137199/137171/14.04.00_60/ts_137171v140400p.pdf
TSDSI	TSDSI STD T1.3GPP 37.171-14.4.0 V1.0.0	14.4.0	30.05.2019	https://members.tdsi.in/index.php/s/BxBT9C9F8KxobBg
TTA	TTAT.3G-37.171(R14-14.4.0)	14.4.0	09.05.2019	http://www.tta.or.kr/data/ttasDown.jsp?where=14688&pk_num=TTAT.3G-37.171(R14-14.4.0)

2.1.5.24 TS 37.320

Radio measurement collection for Minimization of Drive Tests (MDT); Overall description; Stage 2

This document provides an overview and overall description of the minimization of drive tests functionality. The document describes functions and procedures to support collection of UE-specific measurements for MDT using Control Plane architecture, for both UTRAN and E-UTRAN. Details of the signalling procedures for single-RAT operation are specified in the appropriate radio interface protocol specification. Network operation and overall control of MDT is described in OAM specifications.

SDO	Document No.	Version	Issued date	Location
Release 10				
ARIB	ARIB STD-T104-37.320	10.4.0	12.04.2018	http://www.arib.or.jp/english/html/overview/doc/STD-T104v5_20/2_T104/ARIB-STD-T104/Rel10/37/A37320-a40.pdf
ATIS	ATIS.3GPP.37.320V1040	10.4.0	02.05.2019	https://www.atis.org/docstore/
CCSA	CCSA TSD LTE 37.320	10.4.0	19.01.2012	http://www.ccsa.org.cn/ITU_spec/ITU-R/M.2012/M.2012-4/LTE/REL-10/CCSA-TSD-LTE-37320-a40.rar
ETSI	ETSI TS 137 320	10.4.0	19.01.2012	http://www.etsi.org/deliver/etsi_ts/137300_137399/137320/10.04.00_60/ts_137320v100400p.pdf
TSDSI	TSDSI STD T1.3GPP 37.320-10.4.0 V1.0.0	10.4.0	30.05.2019	https://members.tdsi.in/index.php/s/BxBT9C9F8KxobBg
TTA	TTAT.3G-37.320(R10-10.4.0)	10.4.0	22.08.2012	http://www.tta.or.kr/data/ttasDown.jsp?where=14688&pk_num=TTAT.3G-37.320(R10-10.4.0)
Release 11				
ARIB	ARIB STD-T104-37.320	11.4.0	12.04.2018	http://www.arib.or.jp/english/html/overview/doc/STD-T104v5_20/2_T104/ARIB-STD-T104/Rel11/37/A37320-b40.pdf
ATIS	ATIS.3GPP.37.320V1140	11.4.0	02.05.2019	https://www.atis.org/docstore/
CCSA	CCSA TSD LTE 37.320	11.4.0	29.09.2014	http://www.ccsa.org.cn/ITU_spec/ITU-R/M.2012/M.2012-4/LTE/REL-11/CCSA-TSD-LTE-37320-b40.rar
ETSI	ETSI TS 137 320	11.4.0	29.09.2014	http://www.etsi.org/deliver/etsi_ts/137300_137399/137320/11.04.00_60/ts_137320v110400p.pdf
TSDSI	TSDSI STD T1.3GPP 37.320-11.4.0 V1.0.0	11.4.0	30.05.2019	https://members.tdsi.in/index.php/s/BxBT9C9F8KxobBg
TTA	TTAT.3G-37.320(R11-11.4.0)	11.4.0	10.08.2016	http://www.tta.or.kr/data/ttasDown.jsp?where=14688&pk_num=TTAT.3G-37.320(R11-11.4.0)
Release 12				
ARIB	ARIB STD-T104-37.320	12.2.0	12.04.2018	http://www.arib.or.jp/english/html/overview/doc/STD-T104v5_20/2_T104/ARIB-STD-T104/Rel12/37/A37320-c20.pdf
ATIS	ATIS.3GPP.37.320V1220	12.2.0	02.05.2019	https://www.atis.org/docstore/
CCSA	CCSA TSD LTE 37.320	12.2.0	29.09.2014	http://www.ccsa.org.cn/ITU_spec/ITU-R/M.2012/M.2012-4/LTE/REL-12/CCSA-TSD-LTE-37320-c20.rar
ETSI	ETSI TS 137 320	12.2.0	29.09.2014	http://www.etsi.org/deliver/etsi_ts/137300_137399/137320/12.02.00_60/ts_137320v120200p.pdf
TSDSI	TSDSI STD T1.3GPP 37.320-12.2.0 V1.0.0	12.2.0	30.05.2019	https://members.tdsi.in/index.php/s/BxBT9C9F8KxobBg
TTA	TTAT.3G-37.320(R12-12.2.0)	12.2.0	09.04.2015	http://www.tta.or.kr/data/ttasDown.jsp?where=14688&pk_num=TTAT.3G-37.320(R12-12.2.0)
Release 13				
ARIB	ARIB STD-T104-37.320	13.1.0	12.04.2018	http://www.arib.or.jp/english/html/overview/doc/STD-T104v5_20/2_T104/ARIB-STD-T104/Rel13/37/A37320-d10.pdf
ATIS	ATIS.3GPP.37.320V1310	13.1.0	02.05.2019	https://www.atis.org/docstore/
CCSA	CCSA TSD LTE 37.320	13.1.0	27.04.2016	http://www.ccsa.org.cn/ITU_spec/ITU-R/M.2012/M.2012-4/LTE/REL-13/CCSA-TSD-LTE-37320-d10.rar
ETSI	ETSI TS 137 320	13.1.0	27.04.2016	http://www.etsi.org/deliver/etsi_ts/137300_137399/137320/13.01.00_60/ts_137320v130100p.pdf
TSDSI	TSDSI STD T1.3GPP 37.320-13.1.0 V1.0.0	13.1.0	30.05.2019	https://members.tdsi.in/index.php/s/BxBT9C9F8KxobBg

92

Rec. ITU-R M.2012-4

TTA	TTAT.3G-37.320(R13-13.1.0)	13.1.0	06.07.2017	http://www.tta.or.kr/data/ttasDown.jsp?where=14688&pk_num=TTAT.3G-37.320(R13-13.1.0)
-----	----------------------------	--------	------------	---

Release 14

ARIB	ARIB STD-T104-37.320	14.0.0	12.04.2018	http://www.arib.or.jp/english/html/overview/doc/STD-T104v5_20/2_T104/ARIB-STD-T104/Rel14/37/A37320-e00.pdf
ATIS	ATIS.3GPP.37.320V1400	14.0.0	02.05.2019	https://www.atis.org/docstore/
CCSA	CCSA TSD LTE 37.320	14.0.0	11.01.2019	http://www.ccsa.org.cn/ITU_spec/ITU-R/M.2012/M.2012-4/LTE/REL-14/CCSA-TSD-LTE-37320-e00.zip
ETSI	ETSI TS 137 320	14.0.0	11.04.2017	http://www.etsi.org/deliver/etsi_ts/137300_137399/137320/14.00.00_60/ts_137320v140000p.pdf
TSDSI	TSDSI STD T1.3GPP 37.320-14.0.0 V1.0.0	14.0.0	30.05.2019	https://members.tdsi.in/index.php/s/BxBT9C9F8KxobBg
TTA	TTAT.3G-37.320(R14-14.0.0)	14.0.0	10.05.2018	http://www.tta.or.kr/data/ttasDown.jsp?where=14688&pk_num=TTAT.3G-37.320(R14-14.0.0)

2.1.6 User Equipment (UE) conformance testing

2.1.6.1 TS 36.508

Evolved Universal Terrestrial Radio Access (E-UTRA) and Evolved Packet Core (EPC); Common test environments for User Equipment (UE) conformance testing

This document contains definitions of reference conditions and test signals, default parameters, reference radio bearer configurations used in radio bearer interoperability testing, common radio bearer configurations for other test purposes, common requirements for test equipment and generic set-up procedures for use in conformance tests for the 3rd Generation E-UTRAN User Equipment (UE).

SDO	Document No.	Version	Issued date	Location	
Release 10					
ARIB	ARIB STD-T104-36.508		10.5.0	12.04.2018	http://www.arib.or.jp/english/html/overview/doc/STD-T104v5_20/2_T104/ARIB-STD-T104/Rel10/36/A36508-a50.pdf
ATIS	ATIS.3GPP.36.508V1050		10.5.0	02.05.2019	https://www.atis.org/docstore/
CCSA	CCSA TSD LTE 36.508		10.5.0	02.07.2013	http://www.ccsa.org.cn/ITU_spec/ITU-R/M.2012/M.2012-4/LTE/REL-10/CCSA-TSD-LTE-36508-a50.rar
ETSI	ETSI TS 136 508		10.5.0	02.07.2013	http://www.etsi.org/deliver/etsi_ts/136500_136599/136508/10.05.00_60/ts_136508v100500p.pdf
TSDSI	TSDSI STD T1.3GPP 36.508-10.5.0 V1.0.0		10.5.0	30.05.2019	https://members.tdsi.in/index.php/s/BxBT9C9F8KxobBg
TTA	TTAT.3G-36.508(R10-10.5.0)		10.5.0	10.08.2016	http://www.tta.or.kr/data/ttasDown.jsp?where=14688&pk_num=TTAT.3G-36.508(R10-10.5.0)
Release 11					
ARIB	ARIB STD-T104-36.508		11.4.0	12.04.2018	http://www.arib.or.jp/english/html/overview/doc/STD-T104v5_20/2_T104/ARIB-STD-T104/Rel11/36/A36508-b40.pdf
ATIS	ATIS.3GPP.36.508V1140		11.4.0	02.05.2019	https://www.atis.org/docstore/
CCSA	CCSA TSD LTE 36.508		11.4.0	02.04.2014	http://www.ccsa.org.cn/ITU_spec/ITU-R/M.2012/M.2012-4/LTE/REL-11/CCSA-TSD-LTE-36508-b40.rar
ETSI	ETSI TS 136 508		11.4.0	02.04.2014	http://www.etsi.org/deliver/etsi_ts/136500_136599/136508/11.04.00_60/ts_136508v110400p.pdf
TSDSI	TSDSI STD T1.3GPP 36.508-11.4.0 V1.0.0		11.4.0	30.05.2019	https://members.tdsi.in/index.php/s/BxBT9C9F8KxobBg
TTA	TTAT.3G-36.508(R11-11.4.0)		11.4.0	10.08.2016	http://www.tta.or.kr/data/ttasDown.jsp?where=14688&pk_num=TTAT.3G-36.508(R11-11.4.0)
Release 12					
ARIB	ARIB STD-T104-36.508		12.11.0	12.04.2018	http://www.arib.or.jp/english/html/overview/doc/STD-T104v5_20/2_T104/ARIB-STD-T104/Rel12/36/A36508-cb0.pdf
ATIS	ATIS.3GPP.36.508V12110		12.11.0	02.05.2019	https://www.atis.org/docstore/
CCSA	CCSA TSD LTE 36.508		12.11.0	02.11.2016	http://www.ccsa.org.cn/ITU_spec/ITU-R/M.2012/M.2012-4/LTE/REL-12/CCSA-TSD-LTE-36508-cb0.rar
ETSI	ETSI TS 136 508		12.11.0	02.11.2016	http://www.etsi.org/deliver/etsi_ts/136500_136599/136508/12.11.00_60/ts_136508v121100p.pdf
TSDSI	TSDSI STD T1.3GPP 36.508-12.11.0 V1.0.0		12.11.0	30.05.2019	https://members.tdsi.in/index.php/s/BxBT9C9F8KxobBg
TTA	TTAT.3G-36.508(R12-12.11.0)		12.11.0	10.05.2018	http://www.tta.or.kr/data/ttasDown.jsp?where=14688&pk_num=TTAT.3G-36.508(R12-12.11.0)

Release 13

ARIB	ARIB STD-T104-36.508	13.3.1	12.04.2018	http://www.arib.or.jp/english/html/overview/doc/STD-T104v5_20/2_T104/ARIB-STD-T104/Rel13/36/A36508-d31.pdf
ATIS	ATIS.3GPP.36.508V1331	13.3.1	02.05.2019	https://www.atis.org/docstore/
CCSA	CCSA TSD LTE 36.508	13.3.1	10.05.2017	http://www.ccsa.org.cn/ITU_spec/ITU-R/M.2012/M.2012-4/LTE/REL-13/CCSA-TSD-LTE-36508-d31.rar
ETSI	ETSI TS 136 508	13.3.1	10.05.2017	http://www.etsi.org/deliver/etsi_ts/136500_136599/136508/13.03.01_60/ts_136508v130301p.pdf
TSDSI	TSDSI STD T1.3GPP 36.508-13.3.1 V1.0.0	13.3.1	30.05.2019	https://members.tdsi.in/index.php/s/BxBT9C9F8KxobBg
TTA	TTAT.3G-36.508(R13-13.3.1)	13.3.1	10.05.2018	http://www.tta.or.kr/data/ttasDown.jsp?where=14688&pk_num=TTAT.3G-36.508(R13-13.3.1)
Release 14				
ARIB	ARIB STD-T104-36.508	14.4.0	12.04.2018	http://www.arib.or.jp/english/html/overview/doc/STD-T104v5_20/2_T104/ARIB-STD-T104/Rel14/36/A36508-e40.pdf
ATIS	ATIS.3GPP.36.508V1440	14.4.0	02.05.2019	https://www.atis.org/docstore/
CCSA	CCSA TSD LTE 36.508	14.4.0	11.01.2019	http://www.ccsa.org.cn/ITU_spec/ITU-R/M.2012/M.2012-4/LTE/REL-14/CCSA-TSD-LTE-36508-e40.zip
ETSI	ETSI TS 136 508	14.4.0	30.01.2018	http://www.etsi.org/deliver/etsi_ts/136500_136599/136508/14.04.00_60/ts_136508v140400p.pdf
TSDSI	TSDSI STD T1.3GPP 36.508-14.4.0 V1.0.0	14.4.0	30.05.2019	https://members.tdsi.in/index.php/s/BxBT9C9F8KxobBg
TTA	TTAT.3G-36.508(R14-14.4.0)	14.4.0	09.05.2019	http://www.tta.or.kr/data/ttasDown.jsp?where=14688&pk_num=TTAT.3G-36.508(R14-14.4.0)

2.1.6.2 TS 36.509

Evolved Universal Terrestrial Radio Access (E-UTRA) and Evolved Packet Core (EPC); Special conformance testing functions for User Equipment (UE)

This document defines for User Equipment (UE) in E-UTRA FDD or TDD mode those special functions and their activation/deactivation methods that are required in UE for conformance testing purposes.

This document also describes the operation of these special functions for UEs supporting E-UTRA FDD or TDD mode, when operating in UTRA FDD and TDD mode, in GSM/GPRS mode, and in CDMA2000 mode.

SDO	Document No.	Version	Issued date	Location
Release 10				
ARIB	ARIB STD-T104-36.509	10.3.0	12.04.2018	http://www.arib.or.jp/english/html/overview/doc/STD-T104v5_20/2_T104/ARIB-STD-T104/Rel10/36/A36509-a30.pdf
ATIS	ATIS.3GPP.36.509V1030	10.3.0	02.05.2019	https://www.atis.org/docstore/
CCSA	CCSA TSD LTE 36.509	10.3.0	26.09.2014	http://www.ccsa.org.cn/ITU_spec/ITU-R/M.2012/M.2012-4/LTE/REL-10/CCSA-TSD-LTE-36509-a30.rar
ETSI	ETSI TS 136 509	10.3.0	26.09.2014	http://www.etsi.org/deliver/etsi_ts/136500_136599/136509/10.03.00_60/ts_136509v100300p.pdf
TSDSI	TSDSI STD T1.3GPP 36.509-10.3.0 V1.0.0	10.3.0	30.05.2019	https://members.tdsi.in/index.php/s/BxBT9C9F8KxobBg
TTA	TTAT.3G-36.509(R10-10.3.0)	10.3.0	10.08.2016	http://www.tta.or.kr/data/ttasDown.jsp?where=14688&pk_num=TTAT.3G-36.509(R10-10.3.0)
Release 11				
ARIB	ARIB STD-T104-36.509	11.0.0	12.04.2018	http://www.arib.or.jp/english/html/overview/doc/STD-T104v5_20/2_T104/ARIB-STD-T104/Rel11/36/A36509-b00.pdf
ATIS	ATIS.3GPP.36.509V1100	11.0.0	02.05.2019	https://www.atis.org/docstore/
CCSA	CCSA TSD LTE 36.509	11.0.0	28.07.2015	http://www.ccsa.org.cn/ITU_spec/ITU-R/M.2012/M.2012-4/LTE/REL-11/CCSA-TSD-LTE-36509-b00.rar
ETSI	ETSI TS 136 509	11.0.0	28.07.2015	http://www.etsi.org/deliver/etsi_ts/136500_136599/136509/11.00.00_60/ts_136509v110000p.pdf
TSDSI	TSDSI STD T1.3GPP 36.509-11.0.0 V1.0.0	11.0.0	30.05.2019	https://members.tdsi.in/index.php/s/BxBT9C9F8KxobBg
TTA	TTAT.3G-36.509(R11-11.0.0)	11.0.0	10.08.2016	http://www.tta.or.kr/data/ttasDown.jsp?where=14688&pk_num=TTAT.3G-36.509(R11-11.0.0)
Release 12				
ARIB	ARIB STD-T104-36.509	12.4.0	12.04.2018	http://www.arib.or.jp/english/html/overview/doc/STD-T104v5_20/2_T104/ARIB-STD-T104/Rel12/36/A36509-c40.pdf
ATIS	ATIS.3GPP.36.509V1240	12.4.0	02.05.2019	https://www.atis.org/docstore/
CCSA	CCSA TSD LTE 36.509	12.4.0	25.08.2016	http://www.ccsa.org.cn/ITU_spec/ITU-R/M.2012/M.2012-4/LTE/REL-12/CCSA-TSD-LTE-36509-c40.rar

94

ETSI	ETSI TS 136 509	12.4.0	25.08.2016	http://www.etsi.org/deliver/etsi_ts/136500_136599/136509/12.04.00_60/ts_136509v120400p.pdf
TSDSI	TSDSI STD T1.3GPP 36.509-12.4.0 V1.0.0	12.4.0	30.05.2019	https://members.tdsi.in/index.php/s/BxBT9C9F8KxobBg
TTA	TTAT.3G-36.509(R12-12.4.0)	12.4.0	06.07.2017	http://www.tta.or.kr/data/ttasDown.jsp?where=14688&pk_num=TTAT.3G-36.509(R12-12.4.0)

Release 13

ARIB	ARIB STD-T104-36.509	13.6.0	12.04.2018	http://www.arib.or.jp/english/html/overview/doc/STD-T104v5_20/2_T104/ARIB-STD-T104/Rel13/36/A36509-d60.pdf
ATIS	ATIS.3GPP.36.509V1360	13.6.0	02.05.2019	https://www.atis.org/docstore/
CCSA	CCSA TSD LTE 36.509	13.4.0	16.01.2018	http://www.ccsa.org.cn/ITU_spec/ITU-R/M.2012/M.2012-4/LTE/REL-13/CCSA-TSD-LTE-36509-d40.rar
ETSI	ETSI TS 136 509	13.6.0	16.01.2018	http://www.etsi.org/deliver/etsi_ts/136500_136599/136509/13.06.00_60/ts_136509v130600p.pdf
TSDSI	TSDSI STD T1.3GPP 36.509-13.6.0 V1.0.0	13.6.0	30.05.2019	https://members.tdsi.in/index.php/s/BxBT9C9F8KxobBg
TTA	TTAT.3G-36.509(R13-13.6.0)	13.6.0	09.05.2019	http://www.tta.or.kr/data/ttasDown.jsp?where=14688&pk_num=TTAT.3G-36.509(R13-13.6.0)

Release 14

ARIB	ARIB STD-T104-36.509	14.2.0	12.04.2018	http://www.arib.or.jp/english/html/overview/doc/STD-T104v5_20/2_T104/ARIB-STD-T104/Rel14/36/A36509-e20.pdf
ATIS	ATIS.3GPP.36.509V1420	14.2.0	02.05.2019	https://www.atis.org/docstore/
CCSA	CCSA TSD LTE 36.509	14.2.0	11.01.2019	http://www.ccsa.org.cn/ITU_spec/ITU-R/M.2012/M.2012-4/LTE/REL-14/CCSA-TSD-LTE-36509-e20.zip
ETSI	ETSI TS 136 509	14.2.0	16.01.2018	http://www.etsi.org/deliver/etsi_ts/136500_136599/136509/14.02.00_60/ts_136509v140200p.pdf
TSDSI	TSDSI STD T1.3GPP 36.509-14.2.0 V1.0.0	14.2.0	30.05.2019	https://members.tdsi.in/index.php/s/BxBT9C9F8KxobBg
TTA	TTAT.3G-36.509(R14-14.2.0)	14.2.0	09.05.2019	http://www.tta.or.kr/data/ttasDown.jsp?where=14688&pk_num=TTAT.3G-36.509(R14-14.2.0)

2.1.6.3 TS 36.521-1

Evolved Universal Terrestrial Radio Access (E-UTRA); User Equipment (UE) conformance specification; Radio transmission and reception; Part 1: Conformance testing

This document specifies the measurement procedures for the conformance test of the user equipment (UE) that contain transmitting characteristics, receiving characteristics and performance requirements as part of the 3G Long Term Evolution (3G LTE). Conformance test for the support of RRM (Radio Resource Management) are specified in TS 36.521-3.

The requirements are listed in different clauses only if the corresponding parameters deviate. More generally, tests are only applicable to those mobiles that are intended to support the appropriate functionality. To indicate the circumstances in which tests apply, this is noted in the “definition and applicability” part of the test.

For example only Release 8 and later UE declared to support LTE shall be tested for this functionality. In the event that for some tests different conditions apply for different releases, this is indicated within the text of the test itself.

SDO	Document No.	Version	Issued date	Location
-----	--------------	---------	-------------	----------

Release 10

ARIB	ARIB STD-T104-36.521-1	10.6.0	12.04.2018	http://www.arib.or.jp/english/html/overview/doc/STD-T104v5_20/2_T104/ARIB-STD-T104/Rel10/36/A36521-1-a60.pdf
ATIS	ATIS.3GPP.36.521-1V1060	10.6.0	02.05.2019	https://www.atis.org/docstore/
CCSA	CCSA TSD LTE 36.521-1	10.6.0	04.07.2013	http://www.ccsa.org.cn/ITU_spec/ITU-R/M.2012/M.2012-4/LTE/REL-10/CCSA-TSD-LTE-36521-1-a60.rar
ETSI	ETSI TS 136 521-1	10.6.0	04.07.2013	http://www.etsi.org/deliver/etsi_ts/136500_136599/13652101/10.06.00_60/ts_13652101v100600p.pdf
TSDSI	TSDSI STD T1.3GPP 36.521-1-10.6.0 V1.0.0	10.6.0	30.05.2019	https://members.tdsi.in/index.php/s/BxBT9C9F8KxobBg
TTA	TTAT.3G-36.521-1(R10-10.6.0)	10.6.0	10.08.2016	http://www.tta.or.kr/data/ttasDown.jsp?where=14688&pk_num=TTAT.3G-36.521-1(R10-10.6.0)

Release 11

ARIB	ARIB STD-T104-36.521-1	11.4.0	12.04.2018	http://www.arib.or.jp/english/html/overview/doc/STD-T104v5_20/2_T104/ARIB-STD-T104/Rel11/36/A36521-1-b40.pdf
ATIS	ATIS.3GPP.36.521-1V1140	11.4.0	02.05.2019	https://www.atis.org/docstore/
CCSA	CCSA TSD LTE 36.521-1	11.4.0	26.03.2014	http://www.ccsa.org.cn/ITU_spec/ITU-R/M.2012/M.2012-4/LTE/REL-11/CCSA-TSD-LTE-36521-1-b40.rar
ETSI	ETSI TS 136 521-1	11.4.0	26.03.2014	http://www.etsi.org/deliver/etsi_ts/136500_136599/13652101/11.04.00_60/ts_13652101v110400p.pdf
TSDSI	TSDSI STD T1.3GPP 36.521-1-11.4.0 V1.0.0	11.4.0	30.05.2019	https://members.tdsi.in/index.php/s/BxBT9C9F8KxobBg
TTA	TTAT.3G-36.521-1(R11-11.4.0)	11.4.0	10.08.2016	http://www.tta.or.kr/data/ttasDown.jsp?where=14688&pk_num=TTAT.3G-36.521-1(R11-11.4.0)
Release 12				
ARIB	ARIB STD-T104-36.521-1	12.9.0	12.04.2018	http://www.arib.or.jp/english/html/overview/doc/STD-T104v5_20/2_T104/ARIB-STD-T104/Rel12/36/A36521-1-c90.pdf
ATIS	ATIS.3GPP.36.521-1V1290	12.9.0	02.05.2019	https://www.atis.org/docstore/
CCSA	CCSA TSD LTE 36.521-1	12.9.0	20.05.2016	http://www.ccsa.org.cn/ITU_spec/ITU-R/M.2012/M.2012-4/LTE/REL-12/CCSA-TSD-LTE-36521-1-c90.rar
ETSI	ETSI TS 136 521-1	12.9.0	20.05.2016	http://www.etsi.org/deliver/etsi_ts/136500_136599/13652101/12.09.00_60/ts_13652101v120900p.pdf
TSDSI	TSDSI STD T1.3GPP 36.521-1-12.9.0 V1.0.0	12.9.0	30.05.2019	https://members.tdsi.in/index.php/s/BxBT9C9F8KxobBg
TTA	TTAT.3G-36.521-1(R12-12.9.0)	12.9.0	10.05.2018	http://www.tta.or.kr/data/ttasDown.jsp?where=14688&pk_num=TTAT.3G-36.521-1(R12-12.9.0)
Release 13				
ARIB	ARIB STD-T104-36.521-1	13.4.0	12.04.2018	http://www.arib.or.jp/english/html/overview/doc/STD-T104v5_20/2_T104/ARIB-STD-T104/Rel13/36/A36521-1-d40.pdf
ATIS	ATIS.3GPP.36.521-1V1340	13.4.0	02.05.2019	https://www.atis.org/docstore/
CCSA	CCSA TSD LTE 36.521-1	13.4.0	11.04.2017	http://www.ccsa.org.cn/ITU_spec/ITU-R/M.2012/M.2012-4/LTE/REL-13/CCSA-TSD-LTE-36521-1-d40.rar
ETSI	ETSI TS 136 521-1	13.4.0	11.04.2017	http://www.etsi.org/deliver/etsi_ts/136500_136599/13652101/13.04.00_60/ts_13652101v130400p.pdf
TSDSI	TSDSI STD T1.3GPP 36.521-1-13.4.0 V1.0.0	13.4.0	30.05.2019	https://members.tdsi.in/index.php/s/BxBT9C9F8KxobBg
TTA	TTAT.3G-36.521-1(R13-13.4.0)	13.4.0	10.05.2018	http://www.tta.or.kr/data/ttasDown.jsp?where=14688&pk_num=TTAT.3G-36.521-1(R13-13.4.0)
Release 14				
ARIB	ARIB STD-T104-36.521-1	14.5.0	12.04.2018	http://www.arib.or.jp/english/html/overview/doc/STD-T104v5_20/2_T104/ARIB-STD-T104/Rel14/36/A36521-1-e50.pdf
ATIS	ATIS.3GPP.36.521-1V1450	14.5.0	02.05.2019	https://www.atis.org/docstore/
CCSA	CCSA TSD LTE 36.521-1	14.5.0	11.01.2019	http://www.ccsa.org.cn/ITU_spec/ITU-R/M.2012/M.2012-4/LTE/REL-14/CCSA-TSD-LTE-36521-1-e50.zip
ETSI	ETSI TS 136 521-1	14.5.0	01.02.2018	http://www.etsi.org/deliver/etsi_ts/136500_136599/13652101/14.05.00_60/ts_13652101v140500p.pdf
TSDSI	TSDSI STD T1.3GPP 36.521-1-14.5.0 V1.0.0	14.5.0	30.05.2019	https://members.tdsi.in/index.php/s/BxBT9C9F8KxobBg
TTA	TTAT.3G-36.521-1(R14-14.5.0)	14.5.0	09.05.2019	http://www.tta.or.kr/data/ttasDown.jsp?where=14688&pk_num=TTAT.3G-36.521-1(R14-14.5.0)

2.1.6.4 TS 36.521-2

Evolved Universal Terrestrial Radio Access (E-UTRA); User Equipment (UE) conformance specification; Radio transmission and reception; Part 2: Implementation Conformance Statement (ICS)

This document provides the ICS proforma for 3G Evolved Universal Terrestrial Radio Access (E-UTRA) User Equipment (UE), in compliance with the relevant requirements, and in accordance with the relevant guidance given in ISO/IEC 9646-1 and ISO/IEC 9646-7.

This document specifies the recommended applicability statement for the test cases included in 3GPP TS 36.521-1 and 3GPP TS 36.521-3. These applicability statements are based on the features implemented in the UE.

Special conformance testing functions can be found in 3GPP TS 36.509 and the common test environments are included in 3GPP TS 36.508.

This document is valid for UE implemented according to 3GPP releases starting from Release 8 up to the Release indicated on the cover page of this document.

96

Rec. ITU-R M.2012-4

SDO	Document No.	Version	Issued date	Location
Release 10				
ARIB	ARIB STD-T104-36.521-2		10.6.0	12.04.2018 http://www.arib.or.jp/english/html/overview/doc/STD-T104v5_20/2_T104/ARIB-STD-T104/Rel10/36/A36521-2-a60.pdf
ATIS	ATIS.3GPP.36.521-2V1060		10.6.0	02.05.2019 https://www.atis.org/docstore/
CCSA	CCSA TSD LTE 36.521-2		10.6.0	02.07.2013 http://www.ccsa.org.cn/ITU_spec/ITU-R/M.2012/M.2012-4/LTE/REL-10/CCSA-TSD-LTE-36521-2-a60.rar
ETSI	ETSI TS 136 521-2		10.6.0	02.07.2013 http://www.etsi.org/deliver/etsi_ts/136500_136599/13652102/10.06.00_60/ts_13652102v100600p.pdf
TSDSI	TSDSI STD T1.3GPP 36.521-2-10.6.0 V1.0.0		10.6.0	30.05.2019 https://members.tdsi.in/index.php/s/BxBT9C9F8KxobBg
TTA	TTAT.3G-36.521-2(R10-10.6.0)		10.6.0	10.08.2016 http://www.tta.or.kr/data/ttasDown.jsp?where=14688&pk_num=TTAT.3G-36.521-2(R10-10.6.0)
Release 11				
ARIB	ARIB STD-T104-36.521-2		11.4.0	12.04.2018 http://www.arib.or.jp/english/html/overview/doc/STD-T104v5_20/2_T104/ARIB-STD-T104/Rel11/36/A36521-2-b40.pdf
ATIS	ATIS.3GPP.36.521-2V1140		11.4.0	02.05.2019 https://www.atis.org/docstore/
CCSA	CCSA TSD LTE 36.521-2		11.4.0	02.04.2014 http://www.ccsa.org.cn/ITU_spec/ITU-R/M.2012/M.2012-4/LTE/REL-11/CCSA-TSD-LTE-36521-2-b40.rar
ETSI	ETSI TS 136 521-2		11.4.0	02.04.2014 http://www.etsi.org/deliver/etsi_ts/136500_136599/13652102/11.04.00_60/ts_13652102v110400p.pdf
TSDSI	TSDSI STD T1.3GPP 36.521-2-11.4.0 V1.0.0		11.4.0	30.05.2019 https://members.tdsi.in/index.php/s/BxBT9C9F8KxobBg
TTA	TTAT.3G-36.521-2(R11-11.4.0)		11.4.0	10.08.2016 http://www.tta.or.kr/data/ttasDown.jsp?where=14688&pk_num=TTAT.3G-36.521-2(R11-11.4.0)
Release 12				
ARIB	ARIB STD-T104-36.521-2		12.9.0	12.04.2018 http://www.arib.or.jp/english/html/overview/doc/STD-T104v5_20/2_T104/ARIB-STD-T104/Rel12/36/A36521-2-c90.pdf
ATIS	ATIS.3GPP.36.521-2V1290		12.9.0	02.05.2019 https://www.atis.org/docstore/
CCSA	CCSA TSD LTE 36.521-2		12.9.0	14.11.2016 http://www.ccsa.org.cn/ITU_spec/ITU-R/M.2012/M.2012-4/LTE/REL-12/CCSA-TSD-LTE-36521-2-c90.rar
ETSI	ETSI TS 136 521-2		12.9.0	14.11.2016 http://www.etsi.org/deliver/etsi_ts/136500_136599/13652102/12.09.00_60/ts_13652102v120900p.pdf
TSDSI	TSDSI STD T1.3GPP 36.521-2-12.9.0 V1.0.0		12.9.0	30.05.2019 https://members.tdsi.in/index.php/s/BxBT9C9F8KxobBg
TTA	TTAT.3G-36.521-2(R12-12.9.0)		12.9.0	06.07.2017 http://www.tta.or.kr/data/ttasDown.jsp?where=14688&pk_num=TTAT.3G-36.521-2(R12-12.9.0)
Release 13				
ARIB	ARIB STD-T104-36.521-2		13.4.0	12.04.2018 http://www.arib.or.jp/english/html/overview/doc/STD-T104v5_20/2_T104/ARIB-STD-T104/Rel13/36/A36521-2-d40.pdf
ATIS	ATIS.3GPP.36.521-2V1340		13.4.0	02.05.2019 https://www.atis.org/docstore/
CCSA	CCSA TSD LTE 36.521-2		13.4.0	11.04.2017 http://www.ccsa.org.cn/ITU_spec/ITU-R/M.2012/M.2012-4/LTE/REL-13/CCSA-TSD-LTE-36521-2-d40.rar
ETSI	ETSI TS 136 521-2		13.4.0	11.04.2017 http://www.etsi.org/deliver/etsi_ts/136500_136599/13652102/13.04.00_60/ts_13652102v130400p.pdf
TSDSI	TSDSI STD T1.3GPP 36.521-2-13.4.0 V1.0.0		13.4.0	30.05.2019 https://members.tdsi.in/index.php/s/BxBT9C9F8KxobBg
TTA	TTAT.3G-36.521-2(R13-13.4.0)		13.4.0	10.05.2018 http://www.tta.or.kr/data/ttasDown.jsp?where=14688&pk_num=TTAT.3G-36.521-2(R13-13.4.0)
Release 14				
ARIB	ARIB STD-T104-36.521-2		14.5.0	12.04.2018 http://www.arib.or.jp/english/html/overview/doc/STD-T104v5_20/2_T104/ARIB-STD-T104/Rel14/36/A36521-2-e50.pdf
ATIS	ATIS.3GPP.36.521-2V1450		14.5.0	02.05.2019 https://www.atis.org/docstore/
CCSA	CCSA TSD LTE 36.521-2		14.5.0	11.01.2019 http://www.ccsa.org.cn/ITU_spec/ITU-R/M.2012/M.2012-4/LTE/REL-14/CCSA-TSD-LTE-36521-2-e50.zip
ETSI	ETSI TS 136 521-2		14.5.0	26.01.2018 http://www.etsi.org/deliver/etsi_ts/136500_136599/13652102/14.05.00_60/ts_13652102v140500p.pdf
TSDSI	TSDSI STD T1.3GPP 36.521-2-14.5.0 V1.0.0		14.5.0	30.05.2019 https://members.tdsi.in/index.php/s/BxBT9C9F8KxobBg
TTA	TTAT.3G-36.521-2(R14-14.5.0)		14.5.0	09.05.2019 http://www.tta.or.kr/data/ttasDown.jsp?where=14688&pk_num=TTAT.3G-36.521-2(R14-14.5.0)

2.1.6.5 TS 36.521-3

Evolved Universal Terrestrial Radio Access (E-UTRA); User Equipment (UE) conformance specification; Radio transmission and reception; Part 3: Radio Resource Management (RRM) conformance testing

This document specifies the measurement procedures for the conformance test of the user equipment (UE) that contain requirements for support of RRM (Radio Resource Management) as part of the 3G Long Term Evolution (3G LTE).

The requirements are listed in different clauses only if the corresponding parameters deviate. More generally, tests are only applicable to those mobiles that are intended to support the appropriate functionality. To indicate the circumstances in which tests apply, this is noted in the “test applicability” part of the test.

For example only Release 8 and later UE declared to support LTE shall be tested for this functionality. In the event that for some tests different conditions apply for different releases, this is indicated within the text of the test itself.

SDO	Document No.	Version	Issued date	Location
Release 10				
ARIB	ARIB STD-T104-36.521-3		10.5.0	12.04.2018 http://www.arib.or.jp/english/html/overview/doc/STD-T104v5_20/2_T104/ARIB-STD-T104/Rel10/36/A36521-3-a50.pdf
ATIS	ATIS.3GPP.36.521-3V1050		10.5.0	02.05.2019 https://www.atis.org/docstore/
CCSA	CCSA TSD LTE 36.521-3		10.5.0	14.11.2016 http://www.ccsa.org.cn/ITU_spec/ITU-R/M.2012/M.2012-4/LTE/REL-10/CCSA-TSD-LTE-36521-3-a50.rar
ETSI	ETSI TS 136 521-3		10.5.0	14.11.2016 http://www.etsi.org/deliver/etsi_ts/136500_136599/13652103/10.05.00_60/ts_13652103v100500p.pdf
TSDSI	TSDSI STD T1.3GPP 36.521-3-10.5.0 V1.0.0		10.5.0	30.05.2019 https://members.tdsi.in/index.php/s/BxBT9C9F8KxobBg
TTA	TTAT.3G-36.521-3(R10-10.5.0)		10.5.0	06.07.2017 http://www.tta.or.kr/data/ttasDown.jsp?where=14688&pk_num=TTAT.3G-36.521-3(R10-10.5.0)
Release 11				
ARIB	ARIB STD-T104-36.521-3		11.4.0	12.04.2018 http://www.arib.or.jp/english/html/overview/doc/STD-T104v5_20/2_T104/ARIB-STD-T104/Rel11/36/A36521-3-b40.pdf
ATIS	ATIS.3GPP.36.521-3V1140		11.4.0	02.05.2019 https://www.atis.org/docstore/
CCSA	CCSA TSD LTE 36.521-3		11.4.0	03.04.2014 http://www.ccsa.org.cn/ITU_spec/ITU-R/M.2012/M.2012-4/LTE/REL-11/CCSA-TSD-LTE-36521-3-b40.rar
ETSI	ETSI TS 136 521-3		11.4.0	03.04.2014 http://www.etsi.org/deliver/etsi_ts/136500_136599/13652103/11.04.00_60/ts_13652103v110400p.pdf
TSDSI	TSDSI STD T1.3GPP 36.521-3-11.4.0 V1.0.0		11.4.0	30.05.2019 https://members.tdsi.in/index.php/s/BxBT9C9F8KxobBg
TTA	TTAT.3G-36.521-3(R11-11.4.0)		11.4.0	10.08.2016 http://www.tta.or.kr/data/ttasDown.jsp?where=14688&pk_num=TTAT.3G-36.521-3(R11-11.4.0)
Release 12				
ARIB	ARIB STD-T104-36.521-3		12.12.0	12.04.2018 http://www.arib.or.jp/english/html/overview/doc/STD-T104v5_20/2_T104/ARIB-STD-T104/Rel12/36/A36521-3-cc0.pdf
ATIS	ATIS.3GPP.36.521-3V12120		12.12.0	02.05.2019 https://www.atis.org/docstore/
CCSA	CCSA TSD LTE 36.521-3		12.12.0	11.04.2017 http://www.ccsa.org.cn/ITU_spec/ITU-R/M.2012/M.2012-4/LTE/REL-12/CCSA-TSD-LTE-36521-3-cc0.rar
ETSI	ETSI TS 136 521-3		12.12.0	11.04.2017 http://www.etsi.org/deliver/etsi_ts/136500_136599/13652103/12.12.00_60/ts_13652103v121200p.pdf
TSDSI	TSDSI STD T1.3GPP 36.521-3-12.12.0 V1.0.0		12.12.0	30.05.2019 https://members.tdsi.in/index.php/s/BxBT9C9F8KxobBg
TTA	TTAT.3G-36.521-3(R12-12.12.0)		12.12.0	10.05.2018 http://www.tta.or.kr/data/ttasDown.jsp?where=14688&pk_num=TTAT.3G-36.521-3(R12-12.12.0)
Release 13				
ARIB	ARIB STD-T104-36.521-3		13.2.0	12.04.2018 http://www.arib.or.jp/english/html/overview/doc/STD-T104v5_20/2_T104/ARIB-STD-T104/Rel13/36/A36521-3-d20.pdf
ATIS	ATIS.3GPP.36.521-3V1320		13.2.0	02.05.2019 https://www.atis.org/docstore/
CCSA	CCSA TSD LTE 36.521-3		13.2.0	11.04.2017 http://www.ccsa.org.cn/ITU_spec/ITU-R/M.2012/M.2012-4/LTE/REL-13/CCSA-TSD-LTE-36521-3-d20.rar
ETSI	ETSI TS 136 521-3		13.2.0	11.04.2017 http://www.etsi.org/deliver/etsi_ts/136500_136599/13652103/13.02.00_60/ts_13652103v130200p.pdf
TSDSI	TSDSI STD T1.3GPP 36.521-3-13.2.0 V1.0.0		13.2.0	30.05.2019 https://members.tdsi.in/index.php/s/BxBT9C9F8KxobBg

98				Rec. ITU-R M.2012-4
TTA	TTAT.3G-36.521-3(R13-13.2.0)	13.2.0	10.05.2018	http://www.tta.or.kr/data/ttasDown.jsp?where=14688&pk_num=TTAT.3G-36.521-3(R13-13.2.0)

Release 14

ARIB	ARIB STD-T104-36.521-3	14.4.0	12.04.2018	http://www.arib.or.jp/english/html/overview/doc/STD-T104v5_20/2_T104/ARIB-STD-T104/Rel14/36/A36521-3-e40.pdf
ATIS	ATIS.3GPP.36.521-3V1440	14.4.0	02.05.2019	https://www.atis.org/docstore/
CCSA	CCSA TSD LTE 36.521-3	14.4.0	11.01.2019	http://www.ccsa.org.cn/ITU_spec/ITU-R/M.2012/M.2012-4/LTE/REL-14/CCSA-TSD-LTE-36521-3-e40.zip
ETSI	ETSI TS 136 521-3	14.4.0	02.02.2018	http://www.etsi.org/deliver/etsi_ts/136500_136599/13652103/14.04.00_60/ts_13652103v140400p.pdf
TSDSI	TSDSI STD T1.3GPP 36.521-3-14.4.0 V1.0.0	14.4.0	30.05.2019	https://members.tdsi.in/index.php/s/BxBT9C9F8KxobBg
TTA	TTAT.3G-36.521-3(R14-14.4.0)	14.4.0	09.05.2019	http://www.tta.or.kr/data/ttasDown.jsp?where=14688&pk_num=TTAT.3G-36.521-3(R14-14.4.0)

2.1.6.6 TS 36.523-1

Evolved Universal Terrestrial Radio Access (E-UTRA) and Evolved Packet Core (EPC); User Equipment (UE) conformance specification; Part 1: Protocol conformance specification

This document specifies the protocol conformance testing for the 3rd Generation E-UTRAN User Equipment (UE).

This is the first part of a multi-part test specification. The following information can be found in this part:

- the overall test structure;
- the test configurations;
- the conformance requirement and reference to the core specifications;
- the test purposes; and
- a brief description of the test procedure, the specific test requirements and short message exchange table.

The following information relevant to testing could be found in accompanying specifications:

- the default setting of the test parameters (TS 36.508);
- the applicability of each test case (TS 36.523-2).

A detailed description of the expected sequence of messages could be found in the 3rd part of this test specification.

The Implementation Conformance Statement (ICS) pro-forma could be found in the 2nd part of this document.

This document is valid for UE implemented according to 3GPP releases starting from Release 8 up to the Release indicated on the cover page of this document.

SDO	Document No.	Version	Issued date	Location	
Release 10					
ARIB	ARIB STD-T104-36.523-1		10.4.0	12.04.2018	http://www.arib.or.jp/english/html/overview/doc/STD-T104v5_20/2_T104/ARIB-STD-T104/Rel10/36/A36523-1-a40.pdf
ATIS	ATIS.3GPP.36.523-1V1040		10.4.0	02.05.2019	https://www.atis.org/docstore/
CCSA	CCSA TSD LTE 36.523-1		10.4.0	29.07.2015	http://www.ccsa.org.cn/ITU_spec/ITU-R/M.2012/M.2012-4/LTE/REL-10/CCSA-TSD-LTE-36523-1-a40.rar
ETSI	ETSI TS 136 523-1		10.4.0	29.07.2015	http://www.etsi.org/deliver/etsi_ts/136500_136599/13652301/10.04.00_60/ts_13652301v100400p.pdf

TSDSI	TSDSI STD T1.3GPP 36.523-1-10.4.0 V1.0.0	10.4.0	30.05.2019	https://members.tdsi.in/index.php/s/BxBT9C9F8KxobBg
TTA	TTAT.3G-36.523-1(R10-10.4.0)	10.4.0	06.07.2017	http://www.tta.or.kr/data/ttasDown.jsp?where=14688&pk_num=TTAT.3G-36.523-1(R10-10.4.0)
Release 11				
ARIB	ARIB STD-T104-36.523-1	11.7.0	12.04.2018	http://www.arib.or.jp/english/html/overview/doc/STD-T104v5_20/2_T104/ARIB-STD-T104/Rel11/36/A36523-1-b70.pdf
ATIS	ATIS.3GPP.36.523-1V1170	11.7.0	02.05.2019	https://www.atis.org/docstore/
CCSA	CCSA TSD LTE 36.523-1	11.7.0	29.07.2015	http://www.ccsa.org.cn/ITU_spec/ITU-R/M.2012/M.2012-4/LTE/REL-11/CCSA-TSD-LTE-36523-1-b70.rar
ETSI	ETSI TS 136 523-1	11.7.0	29.07.2015	http://www.etsi.org/deliver/etsi_ts/136500_136599/13652301/11.07.00_60/ts_13652301v110700p.pdf
TSDSI	TSDSI STD T1.3GPP 36.523-1-11.7.0 V1.0.0	11.7.0	30.05.2019	https://members.tdsi.in/index.php/s/BxBT9C9F8KxobBg
TTA	TTAT.3G-36.523-1(R11-11.7.0)	11.7.0	06.07.2017	http://www.tta.or.kr/data/ttasDown.jsp?where=14688&pk_num=TTAT.3G-36.523-1(R11-11.7.0)
Release 12				
ARIB	ARIB STD-T104-36.523-1	12.10.0	12.04.2018	http://www.arib.or.jp/english/html/overview/doc/STD-T104v5_20/2_T104/ARIB-STD-T104/Rel12/36/A36523-1-ca0.pdf
ATIS	ATIS.3GPP.36.523-1V12100	12.10.0	02.05.2019	https://www.atis.org/docstore/
CCSA	CCSA TSD LTE 36.523-1	12.10.0	07.11.2016	http://www.ccsa.org.cn/ITU_spec/ITU-R/M.2012/M.2012-4/LTE/REL-12/CCSA-TSD-LTE-36523-1-ca0.rar
ETSI	ETSI TS 136 523-1	12.10.0	07.11.2016	http://www.etsi.org/deliver/etsi_ts/136500_136599/13652301/12.10.00_60/ts_13652301v121000p.pdf
TSDSI	TSDSI STD T1.3GPP 36.523-1-12.10.0 V1.0.0	12.10.0	30.05.2019	https://members.tdsi.in/index.php/s/BxBT9C9F8KxobBg
TTA	TTAT.3G-36.523-1(R12-12.10.0)	12.10.0	06.07.2017	http://www.tta.or.kr/data/ttasDown.jsp?where=14688&pk_num=TTAT.3G-36.523-1(R12-12.10.0)
Release 13				
ARIB	ARIB STD-T104-36.523-1	13.5.0	12.04.2018	http://www.arib.or.jp/english/html/overview/doc/STD-T104v5_20/2_T104/ARIB-STD-T104/Rel13/36/A36523-1-d50.pdf
ATIS	ATIS.3GPP.36.523-1V1350	13.5.0	02.05.2019	https://www.atis.org/docstore/
CCSA	CCSA TSD LTE 36.523-1	13.4.0	19.10.2017	http://www.ccsa.org.cn/ITU_spec/ITU-R/M.2012/M.2012-4/LTE/REL-13/CCSA-TSD-LTE-36523-1-d40.rar
ETSI	ETSI TS 136 523-1	13.5.0	19.10.2017	http://www.etsi.org/deliver/etsi_ts/136500_136599/13652301/13.05.00_60/ts_13652301v130500p.pdf
TSDSI	TSDSI STD T1.3GPP 36.523-1-13.5.0 V1.0.0	13.5.0	30.05.2019	https://members.tdsi.in/index.php/s/BxBT9C9F8KxobBg
TTA	TTAT.3G-36.523-1(R13-13.5.0)	13.5.0	10.05.2018	http://www.tta.or.kr/data/ttasDown.jsp?where=14688&pk_num=TTAT.3G-36.523-1(R13-13.5.0)
Release 14				
ARIB	ARIB STD-T104-36.523-1	14.3.0	12.04.2018	http://www.arib.or.jp/english/html/overview/doc/STD-T104v5_20/2_T104/ARIB-STD-T104/Rel14/36/A36523-1-e30.pdf
ATIS	ATIS.3GPP.36.523-1V1430	14.3.0	02.05.2019	https://www.atis.org/docstore/
CCSA	CCSA TSD LTE 36.523-1	14.3.0	11.01.2019	http://www.ccsa.org.cn/ITU_spec/ITU-R/M.2012/M.2012-4/LTE/REL-14/CCSA-TSD-LTE-36523-1-e30.zip
ETSI	ETSI TS 136 523-1	14.3.0	02.02.2018	http://www.etsi.org/deliver/etsi_ts/136500_136599/13652301/14.03.00_60/ts_13652301v140300p.pdf
TSDSI	TSDSI STD T1.3GPP 36.523-1-14.3.0 V1.0.0	14.3.0	30.05.2019	https://members.tdsi.in/index.php/s/BxBT9C9F8KxobBg
TTA	TTAT.3G-36.523-1(R14-14.3.0)	14.3.0	09.05.2019	http://www.tta.or.kr/data/ttasDown.jsp?where=14688&pk_num=TTAT.3G-36.523-1(R14-14.3.0)

2.1.6.7 TS 36.523-2

Evolved Universal Terrestrial Radio Access (E-UTRA) and Evolved Packet Core (EPC); User Equipment (UE) conformance specification; Part 2: Implementation Conformance Statement (ICS) proforma specification

This document provides the ICS proforma for 3rd Generation User Equipment (UE), in compliance with the relevant EPS (E-UTRA/EPC) requirements, and in accordance with the relevant guidance given in ISO/IEC 9646-1 and ISO/IEC 9646-7.

This document also specifies a recommended applicability statement for the test cases included in TS 36.523-1. These applicability statements are based on the features implemented in the UE.

Special conformance testing functions can be found in TS 36.509 and the common test environments are included in 3GPP TS 36.508.

This document is valid for UE complying with EPS (E-UTRA/EPC) and implemented according to 3GPP releases starting from Release 8 up to the Release indicated on the cover page of this document.

SDO	Document No.	Version	Issued date	Location	
Release 10					
ARIB	ARIB STD-T104-36.523-2		10.3.0	12.04.2018	http://www.arib.or.jp/english/html/overview/doc/STD-T104v5_20/2_T104/ARIB-STD-T104/Rel10/36/A36523-2-a30.pdf
ATIS	ATIS.3GPP.36.523-2V1030		10.3.0	02.05.2019	https://www.atis.org/docstore/
CCSA	CCSA TSD LTE 36.523-2		10.3.0	14.01.2013	http://www.ccsa.org.cn/ITU_spec/ITU-R/M.2012/M.2012-4/LTE/REL-10/CCSA-TSD-LTE-36523-2-a30.rar
ETSI	ETSI TS 136 523-2		10.3.0	14.01.2013	http://www.etsi.org/deliver/etsi_ts/136500_136599/13652302/10.03.00_60/ts_13652302v100300p.pdf
TSDSI	TSDSI STD T1.3GPP 36.523-2-10.3.0 V1.0.0		10.3.0	30.05.2019	https://members.tdsi.in/index.php/s/BxBT9C9F8KxobBg
TTA	TTAT.3G-36.523-2(R10-10.3.0)		10.3.0	26.08.2013	http://www.tta.or.kr/data/ttasDown.jsp?where=14688&pk_num=TTAT.3G-36.523-2(R10-10.3.0)
Release 11					
ARIB	ARIB STD-T104-36.523-2		11.6.0	12.04.2018	http://www.arib.or.jp/english/html/overview/doc/STD-T104v5_20/2_T104/ARIB-STD-T104/Rel11/36/A36523-2-b60.pdf
ATIS	ATIS.3GPP.36.523-2V1160		11.6.0	02.05.2019	https://www.atis.org/docstore/
CCSA	CCSA TSD LTE 36.523-2		11.6.0	03.04.2014	http://www.ccsa.org.cn/ITU_spec/ITU-R/M.2012/M.2012-4/LTE/REL-11/CCSA-TSD-LTE-36523-2-b60.rar
ETSI	ETSI TS 136 523-2		11.6.0	03.04.2014	http://www.etsi.org/deliver/etsi_ts/136500_136599/13652302/11.06.00_60/ts_13652302v110600p.pdf
TSDSI	TSDSI STD T1.3GPP 36.523-2-11.6.0 V1.0.0		11.6.0	30.05.2019	https://members.tdsi.in/index.php/s/BxBT9C9F8KxobBg
TTA	TTAT.3G-36.523-2(R11-11.6.0)		11.6.0	10.08.2016	http://www.tta.or.kr/data/ttasDown.jsp?where=14688&pk_num=TTAT.3G-36.523-2(R11-11.6.0)
Release 12					
ARIB	ARIB STD-T104-36.523-2		12.10.0	12.04.2018	http://www.arib.or.jp/english/html/overview/doc/STD-T104v5_20/2_T104/ARIB-STD-T104/Rel12/36/A36523-2-ca0.pdf
ATIS	ATIS.3GPP.36.523-2V12100		12.10.0	02.05.2019	https://www.atis.org/docstore/
CCSA	CCSA TSD LTE 36.523-2		12.10.0	02.11.2016	http://www.ccsa.org.cn/ITU_spec/ITU-R/M.2012/M.2012-4/LTE/REL-12/CCSA-TSD-LTE-36523-2-ca0.rar
ETSI	ETSI TS 136 523-2		12.10.0	02.11.2016	http://www.etsi.org/deliver/etsi_ts/136500_136599/13652302/12.10.00_60/ts_13652302v121000p.pdf
TSDSI	TSDSI STD T1.3GPP 36.523-2-12.10.0 V1.0.0		12.10.0	30.05.2019	https://members.tdsi.in/index.php/s/BxBT9C9F8KxobBg
TTA	TTAT.3G-36.523-2(R12-12.10.0)		12.10.0	06.07.2017	http://www.tta.or.kr/data/ttasDown.jsp?where=14688&pk_num=TTAT.3G-36.523-2(R12-12.10.0)
Release 13					
ARIB	ARIB STD-T104-36.523-2		13.4.0	12.04.2018	http://www.arib.or.jp/english/html/overview/doc/STD-T104v5_20/2_T104/ARIB-STD-T104/Rel13/36/A36523-2-d40.pdf
ATIS	ATIS.3GPP.36.523-2V1340		13.4.0	02.05.2019	https://www.atis.org/docstore/
CCSA	CCSA TSD LTE 36.523-2		13.4.0	11.04.2017	http://www.ccsa.org.cn/ITU_spec/ITU-R/M.2012/M.2012-4/LTE/REL-13/CCSA-TSD-LTE-36523-2-d40.rar
ETSI	ETSI TS 136 523-2		13.4.0	11.04.2017	http://www.etsi.org/deliver/etsi_ts/136500_136599/13652302/13.04.00_60/ts_13652302v130400p.pdf
TSDSI	TSDSI STD T1.3GPP 36.523-2-13.4.0 V1.0.0		13.4.0	30.05.2019	https://members.tdsi.in/index.php/s/BxBT9C9F8KxobBg
TTA	TTAT.3G-36.523-2(R13-13.4.0)		13.4.0	10.05.2018	http://www.tta.or.kr/data/ttasDown.jsp?where=14688&pk_num=TTAT.3G-36.523-2(R13-13.4.0)
Release 14					
ARIB	ARIB STD-T104-36.523-2		14.4.0	12.04.2018	http://www.arib.or.jp/english/html/overview/doc/STD-T104v5_20/2_T104/ARIB-STD-T104/Rel14/36/A36523-2-e40.pdf
ATIS	ATIS.3GPP.36.523-2V1440		14.4.0	02.05.2019	https://www.atis.org/docstore/
CCSA	CCSA TSD LTE 36.523-2		14.4.0	11.01.2019	http://www.ccsa.org.cn/ITU_spec/ITU-R/M.2012/M.2012-4/LTE/REL-14/CCSA-TSD-LTE-36523-2-e40.zip
ETSI	ETSI TS 136 523-2		14.4.0	19.01.2018	http://www.etsi.org/deliver/etsi_ts/136500_136599/13652302/14.04.00_60/ts_13652302v140400p.pdf
TSDSI	TSDSI STD T1.3GPP 36.523-2-14.4.0 V1.0.0		14.4.0	30.05.2019	https://members.tdsi.in/index.php/s/BxBT9C9F8KxobBg
TTA	TTAT.3G-36.523-2(R14-14.4.0)		14.4.0	09.05.2019	http://www.tta.or.kr/data/ttasDown.jsp?where=14688&pk_num=TTAT.3G-36.523-2(R14-14.4.0)

2.1.6.8 TS 36.523-3**Evolved Universal Terrestrial Radio Access (E-UTRA) and Evolved Packet Core (EPC); User Equipment (UE) conformance specification; Part 3: Test suites**

This document specifies the protocol and signalling conformance testing in TTCN-3 for the 3GPP UE at the UE-E-UTRAN radio interface.

The following TTCN test specification and design considerations can be found in this document:

- the test system architecture;
- the overall test suite structure;
- the test models and ASP definitions;
- the test methods and usage of communication ports definitions;
- the test configurations;
- the design principles and assumptions;
- TTCN styles and conventions;
- the partial PIXIT proforma;
- the test suites.

The Abstract Test Suites designed in the document are based on the test cases specified in prose (3GPP TS 36.523-1). The applicability of the individual test cases is specified in the test ICS proforma specification (3GPP TS 36.523-2).

This document is valid for UE implemented according to 3GPP Rel-9 upwards.

SDO	Document No.	Version	Issued date	Location
Release 10				
ARIB	ARIB STD-T104-36.523-3		10.5.1 12.04.2018	http://www.arib.or.jp/english/html/overview/doc/STD-T104v5_20/2_T104/ARIB-STD-T104/Rel10/36/A36523-3-a51.pdf
ATIS	ATIS.3GPP.36.523-3V1051		10.5.1 02.05.2019	https://www.atis.org/docstore/
CCSA	CCSA TSD LTE 36.523-3		10.5.1 15.10.2013	http://www.ccsa.org.cn/ITU_spec/ITU-R/M.2012/M.2012-4/LTE/REL-10/CCSA-TSD-LTE-36523-3-a51.rar
ETSI	ETSI TS 136 523-3		10.5.1 15.10.2013	http://www.etsi.org/deliver/etsi_ts/136500_136599/13652303/10.05.01_60/ts_13652303v100501p.pdf
TSDSI	TSDSI STD T1.3GPP 36.523-3-10.5.1 V1.0.0		10.5.1 30.05.2019	https://members.tdsi.in/index.php/s/BxBT9C9F8KxobBg
TTA	TTAT.3G-36.523-3(R10-10.5.1)		10.5.1 10.08.2016	http://www.tta.or.kr/data/ttasDown.jsp?where=14688&pk_num=TTAT.3G-36.523-3(R10-10.5.1)
Release 11				
ARIB	ARIB STD-T104-36.523-3		11.7.0 12.04.2018	http://www.arib.or.jp/english/html/overview/doc/STD-T104v5_20/2_T104/ARIB-STD-T104/Rel11/36/A36523-3-b70.pdf
ATIS	ATIS.3GPP.36.523-3V1170		11.7.0 02.05.2019	https://www.atis.org/docstore/
CCSA	CCSA TSD LTE 36.523-3		11.7.0 18.01.2016	http://www.ccsa.org.cn/ITU_spec/ITU-R/M.2012/M.2012-4/LTE/REL-11/CCSA-TSD-LTE-36523-3-b70.rar
ETSI	ETSI TS 136 523-3		11.7.0 18.01.2016	http://www.etsi.org/deliver/etsi_ts/136500_136599/13652303/11.07.00_60/ts_13652303v110700p.pdf
TSDSI	TSDSI STD T1.3GPP 36.523-3-11.7.0 V1.0.0		11.7.0 30.05.2019	https://members.tdsi.in/index.php/s/BxBT9C9F8KxobBg
TTA	TTAT.3G-36.523-3(R11-11.7.0)		11.7.0 06.07.2017	http://www.tta.or.kr/data/ttasDown.jsp?where=14688&pk_num=TTAT.3G-36.523-3(R11-11.7.0)

102

Rec. ITU-R M.2012-4

Release 12

ARIB	ARIB STD-T104-36.523-3	12.8.0	12.04.2018	http://www.arib.or.jp/english/html/overview/doc/STD-T104v5_20/2_T104/ARIB-STD-T104/Rel12/36/A36523-3-c80.pdf
ATIS	ATIS.3GPP.36.523-3V1280	12.8.0	02.05.2019	https://www.atis.org/docstore/
CCSA	CCSA TSD LTE 36.523-3	12.8.0	11.04.2017	http://www.ccsa.org.cn/ITU_spec/ITU-R/M.2012/M.2012-4/LTE/REL-12/CCSA-TSD-LTE-36523-3-c80.rar
ETSI	ETSI TS 136 523-3	12.8.0	11.04.2017	http://www.etsi.org/deliver/etsi_ts/136500_136599/13652303/12.08.00_60/ts_13652303v120800p.pdf
TSDSI	TSDSI STD T1.3GPP 36.523-3-12.8.0 V1.0.0	12.8.0	30.05.2019	https://members.tdsi.in/index.php/s/BxBT9C9F8KxobBg
TTA	TTAT.3G-36.523-3(R12-12.8.0)	12.8.0	10.05.2018	http://www.tta.or.kr/data/ttasDown.jsp?where=14688&pk_num=TTAT.3G-36.523-3(R12-12.8.0)

Release 13

ARIB	ARIB STD-T104-36.523-3	13.4.0	12.04.2018	http://www.arib.or.jp/english/html/overview/doc/STD-T104v5_20/2_T104/ARIB-STD-T104/Rel13/36/A36523-3-d40.pdf
ATIS	ATIS.3GPP.36.523-3V1340	13.4.0	02.05.2019	https://www.atis.org/docstore/
CCSA	CCSA TSD LTE 36.523-3	13.3.0	11.10.2017	http://www.ccsa.org.cn/ITU_spec/ITU-R/M.2012/M.2012-4/LTE/REL-13/CCSA-TSD-LTE-36523-3-d30.rar
ETSI	ETSI TS 136 523-3	13.4.0	11.10.2017	http://www.etsi.org/deliver/etsi_ts/136500_136599/13652303/13.04.00_60/ts_13652303v130400p.pdf
TSDSI	TSDSI STD T1.3GPP 36.523-3-13.4.0 V1.0.0	13.4.0	30.05.2019	https://members.tdsi.in/index.php/s/BxBT9C9F8KxobBg
TTA	TTAT.3G-36.523-3(R13-13.4.0)	13.4.0	10.05.2018	http://www.tta.or.kr/data/ttasDown.jsp?where=14688&pk_num=TTAT.3G-36.523-3(R13-13.4.0)

Release 14

ARIB	ARIB STD-T104-36.523-3	14.2.0	12.04.2018	http://www.arib.or.jp/english/html/overview/doc/STD-T104v5_20/2_T104/ARIB-STD-T104/Rel14/36/A36523-3-e20.pdf
ATIS	ATIS.3GPP.36.523-3V1420	14.2.0	02.05.2019	https://www.atis.org/docstore/
CCSA	CCSA TSD LTE 36.523-3	14.2.0	11.01.2019	http://www.ccsa.org.cn/ITU_spec/ITU-R/M.2012/M.2012-4/LTE/REL-14/CCSA-TSD-LTE-36523-3-e20.zip
ETSI	ETSI TS 136 523-3	14.2.0	26.01.2018	http://www.etsi.org/deliver/etsi_ts/136500_136599/13652303/14.02.00_60/ts_13652303v140200p.pdf
TSDSI	TSDSI STD T1.3GPP 36.523-3-14.2.0 V1.0.0	14.2.0	30.05.2019	https://members.tdsi.in/index.php/s/BxBT9C9F8KxobBg
TTA	TTAT.3G-36.523-3(R14-14.2.0)	14.2.0	09.05.2019	http://www.tta.or.kr/data/ttasDown.jsp?where=14688&pk_num=TTAT.3G-36.523-3(R14-14.2.0)

2.1.6.9 TS 36.579-1

Mission Critical (MC) services over LTE; Part 1: Common test environment

This document defines the common test environment required for testing Client and Server implementations for compliance to the Mission Critical Services over LTE protocol requirements defined by 3GPP.

It contains definitions of reference conditions and test signals, default messages and other parameters, generic procedures, and, common requirements for test equipment with the goal for facilitating testing in general and test procedures specification in particular. Various parts of its content are referred to from other parts of the Mission Critical Services over LTE protocol conformance testing specification e.g. TS 36.579-2 and TS 36.579-3.

This document does not define the common test environment required for testing the implementation of the underlying LTE protocols, i.e. the LTE bearers used for transport of the Mission Critical Services signalling and media. This is defined in TS 36.508 and referred to from this document whenever needed.

In regard to default messages or other information elements contents, this document refers to content defined in requirements specifications specified by 3GPP or other organisations. In the case of Session Initiation Protocol (SIP) and Session Description Protocol (SDP) information elements this document refers to those specified in TS 34.229-1 and explicitly specifies only those relevant for the purposes of the Mission Critical Services over LTE protocol conformance testing.

In this release of the specification only Mission Critical Push To Talk (MCPTT) Services are considered. Future releases may include other Mission Critical Services.

SDO	Document No.	Version	Issued date	Location
Release 13				
ATIS	ATIS.3GPP.36.579-1V1320		13.2.0	02.05.2019 https://www.atis.org/docstore/
CCSA	CCSA TSD LTE 36.579-1		13.2.0	11.01.2019 http://www.ccsa.org.cn/ITU_spec/ITU-R/M.2012/M.2012-4/LTE/REL-13/CCSA-TSD-LTE-36579-1-d20.zip
ETSI	ETSI TS 136 579-1		13.0.0	30.05.2018 http://www.etsi.org/deliver/etsi_ts/136500_136599/13657901/13.00.00_60/ts_13657901v130000p.pdf
TSDSI	TSDSI STD T1.3GPP 36.579-1-13.2.0 V1.0.0		13.2.0	30.05.2019 https://members.tdsi.in/index.php/s/BxBT9C9F8KxobBg
Release 14				
ATIS	ATIS.3GPP.36.579-1V1400		14.0.0	02.05.2019 https://www.atis.org/docstore/
CCSA	CCSA TSD LTE 36.579-1		14.1.0	11.01.2019 http://www.ccsa.org.cn/ITU_spec/ITU-R/M.2012/M.2012-4/LTE/REL-14/CCSA-TSD-LTE-36579-1-e10.zip
ETSI	ETSI TS 136 579-1		14.0.0	16.10.2018 http://www.etsi.org/deliver/etsi_ts/136500_136599/13657901/14.00.00_60/ts_13657901v140000p.pdf
TSDSI	TSDSI STD T1.3GPP 36.579-1-14.0.0 V1.0.0		14.0.0	30.05.2019 https://members.tdsi.in/index.php/s/BxBT9C9F8KxobBg

2.1.6.10 TS 36.579-2

Mission Critical (MC) services over LTE; Part 2: Mission Critical Push To Talk (MCPTT) User Equipment (UE) Protocol conformance specification

This document specifies the protocol conformance testing for testing a MCPTT Client for compliance to the Mission Critical Push To Talk (MCPTT) over LTE protocol requirements defined by 3GPP.

In particular this document contains:

- the overall test structure;
- the test configurations;
- the conformance requirement and reference to the core specifications;
- the test purposes; and
- a brief description of the test procedure, the specific test requirements and short message exchange table.

This document is valid for MCPTT Clients implemented according to 3GPP releases starting from Release 13 up to the Release indicated on the cover page of this document.

The following information relevant to testing specified in this document could be found in accompanying specifications:

- default setting of the test parameters TS 36.579-1;
- Implementation Conformance Statement (ICS) TS 36.579-4 and Implementation eXtra Information for Testing (IXIT) TS 36.579-5;
- the applicability of each test case TS 36.579-4.

The test cases are expected to be executed through the 3GPP radio interface. This document does not specify the protocol conformance testing for the EPS (LTE) bearers which carry the MCPTT data sent or received by the MCPTT Client and which are required to be supported by the UE in which the MCPTT Client is installed. This is defined in TS 36.523-1.

SDO	Document No.	Version	Issued date	Location
Release 13				
ATIS	ATIS.3GPP.36.579-2V1320		13.2.0	02.05.2019 https://www.atis.org/docstore/
CCSA	CCSA TSD LTE 36.579-2		13.2.0	11.01.2019 http://www.ccsa.org.cn/ITU_spec/ITU-R/M.2012/M.2012-4/LTE/REL-13/CCSA-TSD-LTE-36579-2-d20.zip
ETSI	ETSI TS 136 579-2		13.0.0	30.05.2018 http://www.etsi.org/deliver/etsi_ts/136500_136599/13657902/13.00.00_60/ts_13657902v130000p.pdf
TSDSI	TSDSI STD T1.3GPP 36.579-2-13.2.0 V1.0.0		13.2.0	30.05.2019 https://members.tdsi.in/index.php/s/BxBT9C9F8KxobBg
Release 14				
ATIS	ATIS.3GPP.36.579-2V1400		14.0.0	02.05.2019 https://www.atis.org/docstore/
CCSA	CCSA TSD LTE 36.579-2		14.1.0	11.01.2019 http://www.ccsa.org.cn/ITU_spec/ITU-R/M.2012/M.2012-4/LTE/REL-14/CCSA-TSD-LTE-36579-2-e10.zip
ETSI	ETSI TS 136 579-2		14.0.0	16.10.2018 http://www.etsi.org/deliver/etsi_ts/136500_136599/13657902/14.00.00_60/ts_13657902v140000p.pdf
TSDSI	TSDSI STD T1.3GPP 36.579-2-14.0.0 V1.0.0		14.0.0	30.05.2019 https://members.tdsi.in/index.php/s/BxBT9C9F8KxobBg

2.1.6.11 TS 36.579-3

Mission Critical (MC) services over LTE; Part 3: Mission Critical Push To Talk (MCPTT) Server Application conformance specification

This document specifies the protocol conformance testing for testing a MCPTT Server for compliance to the Mission Critical Push To Talk (MCPTT) over LTE protocol requirements defined by 3GPP. This document addresses only MCPTT Server-Client, and, MCPTT Server-Server communication scenarios. It does not cover e.g. MCPTT Server-EPS, MCPTT Server-SIP Core, etc. scenarios which involve interfaces which implementation may widely vary.

In particular this specification contains:

- the overall test structure;
- the test configurations;
- the conformance requirement and reference to the core specifications;
- the test purposes; and
- a brief description of the test procedure, the specific test requirements and short message exchange table.

This document is valid for MCPTT Servers implemented according to 3GPP releases starting from Release 13 up to the Release indicated on the cover page of this document.

The following information relevant to testing specified in this document could be found in accompanying specifications:

- default setting of the test parameters TS 36.579-1;
- Implementation Conformance Statement (ICS) TS 36.579-4 and Implementation eXtra Information for Testing (IXIT) TS 36.579-5;

– the applicability of each test case TS 36.579-4.

This document does not specify the protocol conformance testing for the EPS (LTE) bearers which carry the MCPTT data sent or received by the MCPTT Server. The specification of such testing is out of the scope of RAN5.

SDO	Document No.	Version	Issued date	Location
Release 13				
ATIS	ATIS.3GPP.36.579-3V1300		13.0.0	02.05.2019 https://www.atis.org/docstore/
CCSA	CCSA TSD LTE 36.579-3		13.0.0	11.01.2019 http://www.ccsa.org.cn/ITU_spec/ITU-R/M.2012/M.2012-4/LTE/REL-13/CCSA-TSD-LTE-36579-3-d00.zip
ETSI	ETSI TS 136 579-3		13.0.0	07.04.2018 http://www.etsi.org/deliver/etsi_ts/136500_136599/13657903/13.00.00_60/ts_13657903v130000p.pdf
TSDSI	TSDSI STD T1.3GPP 36.579-3-13.0.0 V1.0.0		13.0.0	30.05.2019 https://members.tdsi.in/index.php/s/BxBT9C9F8KxobBg

2.1.6.12 TS 36.579-4

Mission Critical (MC) services over LTE; Part 4: Test Applicability and Implementation Conformance Statement (ICS) proforma specification

This document provides the Implementation Conformance Statement (ICS) proforma for testing Client or Server implementations for compliance to the Mission Critical Services over LTE protocol requirements defined by 3GPP, and in accordance with the relevant guidance given in ISO/IEC 9646-1 and ISO/IEC 9646-7.

This document specifies the recommended applicability statement for the test cases included in 3GPP TS 36.579-2 and 3GPP TS 36.579-3. These applicability statements are based on the features implemented in the Client or the Server respectively.

This document is valid for Mission Critical Services Servers and Clients implemented according to 3GPP releases starting from Release 13 up to the Release indicated on the cover page of this document.

This document does not specify applicability or ICS for protocol conformance testing for the EPS (LTE) bearers which carry the Mission Critical Services data sent or received by the Client and/or the Server. These are defined in TS 36.523-2.

SDO	Document No.	Version	Issued date	Location
Release 13				
ATIS	ATIS.3GPP.36.579-4V13100		13.10.0	02.05.2019 https://www.atis.org/docstore/
CCSA	CCSA TSD LTE 36.579-4		13.1.0	11.01.2019 http://www.ccsa.org.cn/ITU_spec/ITU-R/M.2012/M.2012-4/LTE/REL-13/CCSA-TSD-LTE-36579-4-d10.zip
ETSI	ETSI TS 136 579-4		13.0.0	30.05.2018 http://www.etsi.org/deliver/etsi_ts/136500_136599/13657904/13.00.00_60/ts_13657904v130000p.pdf
TSDSI	TSDSI STD T1.3GPP 36.579-4-13.10.0 V1.0.0		13.10.0	30.05.2019 https://members.tdsi.in/index.php/s/BxBT9C9F8KxobBg
Release 14				
ATIS	ATIS.3GPP.36.579-4V1400		14.0.0	02.05.2019 https://www.atis.org/docstore/
CCSA	CCSA TSD LTE 36.579-4		14.0.0	11.01.2019 http://www.ccsa.org.cn/ITU_spec/ITU-R/M.2012/M.2012-4/LTE/REL-14/CCSA-TSD-LTE-36579-4-e00.zip
ETSI	ETSI TS 136 579-4		14.0.0	17.10.2018 http://www.etsi.org/deliver/etsi_ts/136500_136599/13657904/14.00.00_60/ts_13657904v140000p.pdf
TSDSI	TSDSI STD T1.3GPP 36.579-4-14.0.0 V1.0.0		14.0.0	30.05.2019 https://members.tdsi.in/index.php/s/BxBT9C9F8KxobBg

2.1.6.13 TS 36.579-5**Mission Critical (MC) services over LTE; Part 5: Abstract test suite (ATS)**

This document specifies the protocol and signalling conformance testing in TTCN-3 for the Mission Critical services over LTE signalling and protocol requirements defined by 3GPP.

The following TTCN test specification and design considerations can be found in this document:

- the test system architecture;
- the overall test suite structure;
- the test models and ASP definitions;
- the test methods and usage of communication ports definitions;
- the test configurations;
- the design principles and assumptions;
- TTCN styles and conventions;
- the partial Implementation eXtra Information for Testing (IXIT) proforma;
- the test suites.

The Abstract Test Suites designed in the document are based on the test cases specified in 3GPP TS 36.579-2. The test cases specified in 3GPP TS 36.579-3 are out of scope of this document.

The applicability of the individual test cases is specified in the test ICS proforma specification in 3GPP TS 36.579-4). Where appropriate the Abstract Test Suites belonging to this specification may refer to other Abstract Test Suites e.g. 3GPP TS 36.523-3 for test requirements related to the EPS (LTE) bearers which carry the Mission Critical services data.

This document is valid for TTCN development for Mission Critical services clients' conformance tests according to 3GPP Releases starting from Release 13 up to the Release indicated on the cover page of this document.

SDO	Document No.	Version	Issued date	Location
Release 13				
ATIS	ATIS.3GPP.36.579-5V1310		13.1.0	02.05.2019 https://www.atis.org/docstore/
ATIS	ATIS.3GPP.36.579-5V1300		13.0.0	02.05.2019 https://www.atis.org/docstore/
CCSA	CCSA TSD LTE 36.579-5		13.1.0	11.01.2019 http://www.ccsa.org.cn/ITU_spec/ITU-R/M.2012/M.2012-4/LTE/REL-13/CCSA-TSD-LTE-36579-5-d10.zip
ETSI	ETSI TS 136 579-5		13.0.0	07.04.2018 http://www.etsi.org/deliver/etsi_ts/136500_136599/13657905/13.00.00_60/ts_13657905v130000p.pdf
TSDSI	TSDSI STD T1.3GPP 36.579-5-13.1.0 V1.0.0		13.1.0	30.05.2019 https://members.tdsi.in/index.php/s/BxBT9C9F8KxobBg
TSDSI	TSDSI STD T1.3GPP 36.579-5-13.0.0 V1.0.0		13.0.0	30.05.2019 https://members.tdsi.in/index.php/s/BxBT9C9F8KxobBg

2.1.6.14 TS 37.544**Universal Terrestrial Radio Access (UTRA) and Evolved UTRA (E-UTRA); User Equipment (UE) Over The Air (OTA) performance; Conformance testing**

This document describes the test procedure for the radiated performances measurements of the user equipment (UE).

The handheld UE measurement procedures explained in this document are defined for roaming bands for the speech mode position (beside the head and beside the head and hand) and hand phantom browsing mode position. Laptop mounted equipment (LME) measurement procedures are defined for roaming bands for the data mode transfer position (laptop ground plane phantom). Laptop embedded equipment (LEE) measurement procedures are defined for roaming bands for the data mode transfer position (free space).

The browsing mode position explained in this document applies when the UE is held in hand, but not pressed against ear (such as web browsing and navigation).

The data mode transfer position (free space) explained in this document applies when the UE is used away from the user's head. Free space measurements are applicable to devices used in the data mode transfer position that consist of the laptop mounted equipment (LME) plug-in UEs and laptop embedded equipment (LEE) UEs.

All bands are potential roaming bands, and the requirements for roaming bands shall therefore be fulfilled for all bands supported by a UE.

Radiated performance of multiple-antenna receivers for handheld UE is defined for roaming bands in free space configuration.

Recommended performance values for operating bands (Annex I) are however included in this specification for information. It should be recognised that the ability to meet the recommended performance values depends on the number of frequency bands supported by the UE.

The radiated radio tests considered here are:

- 1 The measurement of the Total Radiated Power (TRP)
- 2 The measurement of the Total Radiated Sensitivity (TRS)
- 3 The measurement of Total Radiated Multi-antenna Sensitivity (TRMS)

The test procedure described in this document measures the performance of the transmitter and the receiver, including the antenna and also the effects of the user.

SDO	Document No.	Version	Issued date	Location
Release 14				
ATIS	ATIS.3GPP.37.544V1440		14.4.0	02.05.2019 https://www.atis.org/docstore/
CCSA	CCSA TSD LTE 37.544		14.4.0	11.01.2019 http://www.ccsa.org.cn/ITU_spec/ITU-R/M.2012/M.2012-4/LTE/REL-14/CCSA-TSD-LTE-37544-e40.zip
ETSI	ETSI TS 137 544		14.4.0	19.01.2018 http://www.etsi.org/deliver/etsi_ts/137500_137599/137544/14.04.00_60/ts_137544v140400p.pdf
TSDSI	TSDSI STD T1.3GPP 37.544-14.4.0 V1.0.0		14.4.0	30.05.2019 https://members.tdsi.in/index.php/s/BxBT9C9F8KxobBg
TTA	TTAT.3G-37.544(R14-14.4.0)		14.4.0	09.05.2019 http://www.tta.or.kr/data/ttasDown.jsp?where=14688&pk_num=TTAT.3G-37.544(R14-14.4.0)

2.1.6.15 TS 37.571-1

Universal Terrestrial Radio Access (UTRA) and Evolved UTRA (E-UTRA) and Evolved Packet Core (EPC); User Equipment (UE) conformance specification for UE positioning; Part 1: Conformance test specification

This document specifies the procedures for the conformance test of the measurement requirements for FDD mode of UTRA and FDD or TDD mode of E-UTRA for the User Equipment (UE) that supports one or more of the defined positioning methods. These positioning methods are for UTRA: Assisted Global Positioning System (A-GPS), Assisted Global Navigation Satellite Systems (A-GNSS) and for E-UTRA: Assisted Global Navigation Satellite System (A-GNSS), Observed Time Difference of Arrival (OTDOA), Enhanced Cell ID (ECID).

Tests are only applicable to those mobiles that are intended to support the appropriate functionality. To indicate the circumstances in which tests apply, this is noted in the “Test applicability” part of the test.

The Implementation Conformance Statement (ICS) pro-forma could be found in the 3rd part of this document.

SDO	Document No.	Version	Issued date	Location
Release 10				
ARIB	ARIB STD-T104-37.571-1		10.8.0	12.04.2018 http://www.arib.or.jp/english/html/overview/doc/STD-T104v5_20/2_T104/ARIB-STD-T104/Rel10/37/A37571-1-a80.pdf
ATIS	ATIS.3GPP.37.571-1V1080		10.8.0	02.05.2019 https://www.atis.org/docstore/
ETSI	ETSI TS 137 571-1		10.8.0	15.01.2016 http://www.etsi.org/deliver/etsi_ts/137500_137599/13757101/10.08.00_60/ts_13757101v100800p.pdf
TSDSI	TSDSI STD T1.3GPP 37.571-1-10.8.0 V1.0.0		10.8.0	30.05.2019 https://members.tdsi.in/index.php/s/BxBT9C9F8KxobBg
TTA	TTAT.3G-37.571-1(R10-10.8.0)		10.8.0	06.07.2017 http://www.tta.or.kr/data/ttasDown.jsp?where=14688&pk_num=TTAT.3G-37.571-1(R10-10.8.0)
Release 11				
ARIB	ARIB STD-T104-37.571-1		11.3.0	12.04.2018 http://www.arib.or.jp/english/html/overview/doc/STD-T104v5_20/2_T104/ARIB-STD-T104/Rel11/37/A37571-1-b30.pdf
ATIS	ATIS.3GPP.37.571-1V1130		11.3.0	02.05.2019 https://www.atis.org/docstore/
ETSI	ETSI TS 137 571-1		11.3.0	15.01.2016 http://www.etsi.org/deliver/etsi_ts/137500_137599/13757101/11.03.00_60/ts_13757101v110300p.pdf
TSDSI	TSDSI STD T1.3GPP 37.571-1-11.3.0 V1.0.0		11.3.0	30.05.2019 https://members.tdsi.in/index.php/s/BxBT9C9F8KxobBg
TTA	TTAT.3G-37.571-1(R11-11.3.0)		11.3.0	06.07.2017 http://www.tta.or.kr/data/ttasDown.jsp?where=14688&pk_num=TTAT.3G-37.571-1(R11-11.3.0)
Release 12				
ARIB	ARIB STD-T104-37.571-1		12.8.0	12.04.2018 http://www.arib.or.jp/english/html/overview/doc/STD-T104v5_20/2_T104/ARIB-STD-T104/Rel12/37/A37571-1-c80.pdf
ATIS	ATIS.3GPP.37.571-1V1280		12.8.0	02.05.2019 https://www.atis.org/docstore/
ETSI	ETSI TS 137 571-1		12.8.0	03.11.2016 http://www.etsi.org/deliver/etsi_ts/137500_137599/13757101/12.08.00_60/ts_13757101v120800p.pdf
TSDSI	TSDSI STD T1.3GPP 37.571-1-12.8.0 V1.0.0		12.8.0	30.05.2019 https://members.tdsi.in/index.php/s/BxBT9C9F8KxobBg
TTA	TTAT.3G-37.571-1(R12-12.8.0)		12.8.0	06.07.2017 http://www.tta.or.kr/data/ttasDown.jsp?where=14688&pk_num=TTAT.3G-37.571-1(R12-12.8.0)
Release 13				
ARIB	ARIB STD-T104-37.571-1		13.3.0	12.04.2018 http://www.arib.or.jp/english/html/overview/doc/STD-T104v5_20/2_T104/ARIB-STD-T104/Rel13/37/A37571-1-d30.pdf
ATIS	ATIS.3GPP.37.571-1V1330		13.3.0	02.05.2019 https://www.atis.org/docstore/
ETSI	ETSI TS 137 571-1		13.3.0	10.04.2017 http://www.etsi.org/deliver/etsi_ts/137500_137599/13757101/13.03.00_60/ts_13757101v130300p.pdf
TSDSI	TSDSI STD T1.3GPP 37.571-1-13.3.0 V1.0.0		13.3.0	30.05.2019 https://members.tdsi.in/index.php/s/BxBT9C9F8KxobBg
TTA	TTAT.3G-37.571-1(R13-13.3.0)		13.3.0	10.05.2018 http://www.tta.or.kr/data/ttasDown.jsp?where=14688&pk_num=TTAT.3G-37.571-1(R13-13.3.0)
Release 14				
ARIB	ARIB STD-T104-37.571-1		14.4.0	12.04.2018 http://www.arib.or.jp/english/html/overview/doc/STD-T104v5_20/2_T104/ARIB-STD-T104/Rel14/37/A37571-1-e40.pdf
ATIS	ATIS.3GPP.37.571-1V1440		14.4.0	02.05.2019 https://www.atis.org/docstore/

CCSA	CCSA TSD LTE 37.571-1	14.4.0	15.01.2016	http://www.ccsa.org.cn/ITU_spec/ITU-R/M.2012/M.2012-4/LTE/REL-14/CCSA-TSD-LTE-37571-1-e40.zip
ETSI	ETSI TS 137 571-1	14.4.0	19.01.2018	http://www.etsi.org/deliver/etsi_ts/137500_137599/13757101/14.04.00_60/ts_13757101v140400p.pdf
TSDSI	TSDSI STD T1.3GPP 37.571-1-14.4.0 V1.0.0	14.4.0	30.05.2019	https://members.tdsi.in/index.php/s/BxBT9C9F8KxobBg
TTA	TTAT.3G-37.571-1(R14-14.4.0)	14.4.0	09.05.2019	http://www.tta.or.kr/data/ttasDown.jsp?where=14688&pk_num=TTAT.3G-37.571-1(R14-14.4.0)

2.1.6.16 TS 37.571-2

Universal Terrestrial Radio Access (UTRA) and Evolved UTRA (E-UTRA) and Evolved Packet Core (EPC); User Equipment (UE) conformance specification for UE positioning; Part 2: Protocol conformance

This document specifies the protocol conformance testing for the 3rd Generation UTRAN and E-UTRAN User Equipment (UE) supporting UE positioning.

This is the second part of a multi-part test specification. The following information can be found in this part:

- the overall protocol conformance test structure;
- the protocol conformance test configurations;
- the conformance requirement and reference to the core specifications;
- the test purposes; and
- a brief description of the test procedure, the specific test requirements and short message exchange table.

The Implementation Conformance Statement (ICS) pro-forma could be found in the 3rd part of this document.

This document is valid for UE supporting UE positioning implemented according to 3GPP releases starting from Release 99 up to the Release indicated on the cover page of this document.

SDO	Document No.	Version	Issued date	Location
Release 10				
ARIB	ARIB STD-T104-37.571-2		10.10.0 12.04.2018	http://www.arib.or.jp/english/html/overview/doc/STD-T104v5_20/2_T104/ARIB-STD-T104/Rel10/37/A37571-2-aa0.pdf
ATIS	ATIS.3GPP.37.571-2V10100		10.10.0 02.05.2019	https://www.atis.org/docstore/
CCSA	CCSA TSD LTE 37.571-2		10.10.0 15.01.2016	http://www.ccsa.org.cn/ITU_spec/ITU-R/M.2012/M.2012-4/LTE/REL-10/CCSA-TSD-LTE-37571-2-aa0.rar
ETSI	ETSI TS 137 571-2		10.10.0 15.01.2016	http://www.etsi.org/deliver/etsi_ts/137500_137599/13757102/10.10.00_60/ts_13757102v101000p.pdf
TSDSI	TSDSI STD T1.3GPP 37.571-2-10.10.0 V1.0.0		10.10.0 30.05.2019	https://members.tdsi.in/index.php/s/BxBT9C9F8KxobBg
TTA	TTAT.3G-37.571-2(R10-10.10.0)		10.10.0 06.07.2017	http://www.tta.or.kr/data/ttasDown.jsp?where=14688&pk_num=TTAT.3G-37.571-2(R10-10.10.0)
Release 11				
ARIB	ARIB STD-T104-37.571-2		11.1.0 12.04.2018	http://www.arib.or.jp/english/html/overview/doc/STD-T104v5_20/2_T104/ARIB-STD-T104/Rel11/37/A37571-2-b10.pdf
ATIS	ATIS.3GPP.37.571-2V1110		11.1.0 02.05.2019	https://www.atis.org/docstore/
CCSA	CCSA TSD LTE 37.571-2		11.1.0 03.11.2016	http://www.ccsa.org.cn/ITU_spec/ITU-R/M.2012/M.2012-4/LTE/REL-11/CCSA-TSD-LTE-37571-2-b10.rar
ETSI	ETSI TS 137 571-2		11.1.0 15.01.2016	http://www.etsi.org/deliver/etsi_ts/137500_137599/13757102/11.01.00_60/ts_13757102v110100p.pdf
TSDSI	TSDSI STD T1.3GPP 37.571-2-11.1.0 V1.0.0		11.1.0 30.05.2019	https://members.tdsi.in/index.php/s/BxBT9C9F8KxobBg
TTA	TTAT.3G-37.571-2(R11-11.1.0)		11.1.0 06.07.2017	http://www.tta.or.kr/data/ttasDown.jsp?where=14688&pk_num=TTAT.3G-37.571-2(R11-11.1.0)
Release 12				

110

ARIB	ARIB STD-T104-37.571-2	12.7.0	12.04.2018	http://www.arib.or.jp/english/html/overview/doc/STD-T104v5_20/2_T104/ARIB-STD-T104/Rel12/37/A37571-2-c70.pdf
ATIS	ATIS.3GPP.37.571-2V1270	12.7.0	02.05.2019	https://www.atis.org/docstore/
CCSA	CCSA TSD LTE 37.571-2	12.7.0	10.04.2017	http://www.ccsa.org.cn/ITU_spec/ITU-R/M.2012/M.2012-4/LTE/REL-12/CCSA-TSD-LTE-37571-2-c70.rar
ETSI	ETSI TS 137 571-2	12.7.0	10.04.2017	http://www.etsi.org/deliver/etsi_ts/137500_137599/13757102/12.07.00_60/ts_13757102v120700p.pdf
TSDSI	TSDSI STD T1.3GPP 37.571-2-12.7.0 V1.0.0	12.7.0	30.05.2019	https://members.tdsi.in/index.php/s/BxBT9C9F8KxobBg
TTA	TTAT.3G-37.571-2(R12-12.7.0)	12.7.0	10.05.2018	http://www.tta.or.kr/data/ttasDown.jsp?where=14688&pk_num=TTAT.3G-37.571-2(R12-12.7.0)

Release 13

ARIB	ARIB STD-T104-37.571-2	13.3.0	12.04.2018	http://www.arib.or.jp/english/html/overview/doc/STD-T104v5_20/2_T104/ARIB-STD-T104/Rel13/37/A37571-2-d30.pdf
ATIS	ATIS.3GPP.37.571-2V1330	13.3.0	02.05.2019	https://www.atis.org/docstore/
CCSA	CCSA TSD LTE 37.571-2	13.2.0	11.01.2019	http://www.ccsa.org.cn/ITU_spec/ITU-R/M.2012/M.2012-4/LTE/REL-13/CCSA-TSD-LTE-37571-2-d20.rar
ETSI	ETSI TS 137 571-2	13.3.0	11.10.2017	http://www.etsi.org/deliver/etsi_ts/137500_137599/13757102/13.03.00_60/ts_13757102v130300p.pdf
TSDSI	TSDSI STD T1.3GPP 37.571-2-13.3.0 V1.0.0	13.3.0	30.05.2019	https://members.tdsi.in/index.php/s/BxBT9C9F8KxobBg
TTA	TTAT.3G-37.571-2(R13-13.3.0)	13.3.0	10.05.2018	http://www.tta.or.kr/data/ttasDown.jsp?where=14688&pk_num=TTAT.3G-37.571-2(R13-13.3.0)

Release 14

ARIB	ARIB STD-T104-37.571-2	14.3.0	12.04.2018	http://www.arib.or.jp/english/html/overview/doc/STD-T104v5_20/2_T104/ARIB-STD-T104/Rel14/37/A37571-2-e30.pdf
ATIS	ATIS.3GPP.37.571-2V1430	14.3.0	02.05.2019	https://www.atis.org/docstore/
CCSA	CCSA TSD LTE 37.571-2	14.3.0	15.01.2016	http://www.ccsa.org.cn/ITU_spec/ITU-R/M.2012/M.2012-4/LTE/REL-14/CCSA-TSD-LTE-37571-2-e30.zip
ETSI	ETSI TS 137 571-2	14.3.0	19.01.2018	http://www.etsi.org/deliver/etsi_ts/137500_137599/13757102/14.03.00_60/ts_13757102v140300p.pdf
TSDSI	TSDSI STD T1.3GPP 37.571-2-14.3.0 V1.0.0	14.3.0	30.05.2019	https://members.tdsi.in/index.php/s/BxBT9C9F8KxobBg
TTA	TTAT.3G-37.571-2(R14-14.3.0)	14.3.0	09.05.2019	http://www.tta.or.kr/data/ttasDown.jsp?where=14688&pk_num=TTAT.3G-37.571-2(R14-14.3.0)

2.1.6.17 TS 37.571-3

Universal Terrestrial Radio Access (UTRA) and Evolved UTRA (E-UTRA) and Evolved Packet Core (EPC); User Equipment (UE) conformance specification for UE positioning; Part 3: Implementation Conformance Statement (ICS)

This document provides the ICS proforma for 3rd Generation UTRAN and E-UTRAN User Equipment (UE) supporting UE positioning, in compliance with the relevant requirements, and in accordance with the relevant guidance given in ISO/IEC 9646-1 and ISO/IEC 9646-7.

This document also specifies a recommended applicability statement for the test cases included in 3GPP TS 37.571-1 and 3GPP TS 37.571-2. These applicability statements are based on the features implemented in the UE.

Special conformance testing functions can be found in 3GPP TS 34.109 for UTRA and 3GPP TS 36.509 for E-UTRA. The common test environments are included in 3GPP TS 34.108 for UTRA and in 3GPP TS 36.508 for E-UTRA.

This document is valid for UE supporting UE positioning implemented according to 3GPP releases starting from Release 99 up to the Release indicated on the cover page of this document.

SDO	Document No.	Version	Issued date	Location
-----	--------------	---------	-------------	----------

Release 10

ARIB	ARIB STD-T104-37.571-3	10.8.0	12.04.2018	http://www.arib.or.jp/english/html/overview/doc/STD-T104v5_20/2_T104/ARIB-STD-T104/Rel10/37/A37571-3-a80.pdf
ATIS	ATIS.3GPP.37.571-3V1080	10.8.0	02.05.2019	https://www.atis.org/docstore/
ETSI	ETSI TS 137 571-3	10.8.0	15.01.2016	http://www.etsi.org/deliver/etsi_ts/137500_137599/13757103/10.08.00_60/ts_13757103v100800p.pdf
TSDSI	TSDSI STD T1.3GPP 37.571-3-10.8.0 V1.0.0	10.8.0	30.05.2019	https://members.tdsi.in/index.php/s/BxBT9C9F8KxobBg

TTA	TTAT.3G-37.571-3(R10-10.8.0)	10.8.0	06.07.2017	http://www.tta.or.kr/data/ttasDown.jsp?where=14688&pk_num=TTAT.3G-37.571-3(R10-10.8.0)
Release 11				
ARIB	ARIB STD-T104-37.571-3	11.1.0	12.04.2018	http://www.arib.or.jp/english/html/overview/doc/STD-T104v5_20/2_T104/ARIB-STD-T104/Rel11/37/A37571-3-b10.pdf
ATIS	ATIS.3GPP.37.571-3V1110	11.1.0	02.05.2019	https://www.atis.org/docstore/
ETSI	ETSI TS 137 571-3	11.1.0	15.01.2016	http://www.etsi.org/deliver/etsi_ts/137500_137599/13757103/11.01.00_60/ts_13757103v110100p.pdf
TSDSI	TSDSI STD T1.3GPP 37.571-3-11.1.0 V1.0.0	11.1.0	30.05.2019	https://members.tdsi.in/index.php/s/BxBT9C9F8KxobBg
TTA	TTAT.3G-37.571-3(R11-11.1.0)	11.1.0	06.07.2017	http://www.tta.or.kr/data/ttasDown.jsp?where=14688&pk_num=TTAT.3G-37.571-3(R11-11.1.0)
Release 12				
ARIB	ARIB STD-T104-37.571-3	12.9.0	12.04.2018	http://www.arib.or.jp/english/html/overview/doc/STD-T104v5_20/2_T104/ARIB-STD-T104/Rel12/37/A37571-3-c90.pdf
ATIS	ATIS.3GPP.37.571-3V1290	12.9.0	02.05.2019	https://www.atis.org/docstore/
ETSI	ETSI TS 137 571-3	12.9.0	10.04.2017	http://www.etsi.org/deliver/etsi_ts/137500_137599/13757103/12.09.00_60/ts_13757103v120900p.pdf
TSDSI	TSDSI STD T1.3GPP 37.571-3-12.9.0 V1.0.0	12.9.0	30.05.2019	https://members.tdsi.in/index.php/s/BxBT9C9F8KxobBg
TTA	TTAT.3G-37.571-3(R12-12.9.0)	12.9.0	10.05.2018	http://www.tta.or.kr/data/ttasDown.jsp?where=14688&pk_num=TTAT.3G-37.571-3(R12-12.9.0)
Release 13				
ARIB	ARIB STD-T104-37.571-3	13.3.0	12.04.2018	http://www.arib.or.jp/english/html/overview/doc/STD-T104v5_20/2_T104/ARIB-STD-T104/Rel13/37/A37571-3-d30.pdf
ATIS	ATIS.3GPP.37.571-3V1330	13.3.0	02.05.2019	https://www.atis.org/docstore/
ETSI	ETSI TS 137 571-3	13.3.0	11.10.2017	http://www.etsi.org/deliver/etsi_ts/137500_137599/13757103/13.03.00_60/ts_13757103v130300p.pdf
TSDSI	TSDSI STD T1.3GPP 37.571-3-13.3.0 V1.0.0	13.3.0	30.05.2019	https://members.tdsi.in/index.php/s/BxBT9C9F8KxobBg
TTA	TTAT.3G-37.571-3(R13-13.3.0)	13.3.0	10.05.2018	http://www.tta.or.kr/data/ttasDown.jsp?where=14688&pk_num=TTAT.3G-37.571-3(R13-13.3.0)
Release 14				
ARIB	ARIB STD-T104-37.571-3	14.3.1	12.04.2018	http://www.arib.or.jp/english/html/overview/doc/STD-T104v5_20/2_T104/ARIB-STD-T104/Rel14/37/A37571-3-e31.pdf
ATIS	ATIS.3GPP.37.571-3V1431	14.3.1	02.05.2019	https://www.atis.org/docstore/
CCSA	CCSA TSD LTE 37.571-3	14.3.1	15.01.2016	http://www.ccsa.org.cn/ITU_spec/ITU-R/M.2012/M.2012-4/LTE/REL-14/CCSA-TSD-LTE-37571-3-e31.zip
ETSI	ETSI TS 137 571-3	14.3.1	31.01.2018	http://www.etsi.org/deliver/etsi_ts/137500_137599/13757103/14.03.01_60/ts_13757103v140301p.pdf
TSDSI	TSDSI STD T1.3GPP 37.571-3-14.3.1 V1.0.0	14.3.1	30.05.2019	https://members.tdsi.in/index.php/s/BxBT9C9F8KxobBg
TTA	TTAT.3G-37.571-3(R14-14.3.1)	14.3.1	09.05.2019	http://www.tta.or.kr/data/ttasDown.jsp?where=14688&pk_num=TTAT.3G-37.571-3(R14-14.3.1)

2.1.6.18 TS 37.571-4

Universal Terrestrial Radio Access (UTRA) and Evolved UTRA (E-UTRA) and Evolved Packet Core (EPC); User Equipment (UE) conformance specification for UE positioning; Part 4: Test suites

This document specifies the protocol and signalling conformance testing in TTCN for the UE:

- A-GPS at the UTRA Uu interface;
- LTE positioning at the LTE-Uu interface;
- A-GNSS at the UTRA Uu interface.

The following TTCN test specification and design considerations can be found in this document:

- Test system architecture;
- Test models and ASP definitions;

- Test methods and usage of communication ports definitions;
- Test configurations;
- Design principles and assumptions;
- TTCN styles and conventions;
- Partial PIXIT proforma;
- Test suites in TTCN-2 and TTCN-3;
- The Test Suites designed and implemented in this document are based on the test specifications in prose in 3GPP TS 37.571-2;
- The applicability of the individual test cases is specified in the test ICS proforma specification in 3GPP TS 37.571-3.

SDO	Document No.	Version	Issued date	Location
Release 10				
ARIB	ARIB STD-T104-37.571-4		10.10.0 12.04.2018	http://www.arib.or.jp/english/html/overview/doc/STD-T104v5_20/2_T104/ARIB-STD-T104/Rel10/37/A37571-4-aa0.pdf
ATIS	ATIS.3GPP.37.571-4V10100		10.10.0 02.05.2019	https://www.atis.org/docstore/
CCSA	CCSA TSD LTE 37.571-4		10.10.0 10.04.2017	http://www.ccsa.org.cn/ITU_spec/ITU-R/M.2012/M.2012-4/LTE/REL-10/CCSA-TSD-LTE-37571-4-aa0.rar
ETSI	ETSI TS 137 571-4		10.10.0 15.01.2016	http://www.etsi.org/deliver/etsi_ts/137500_137599/13757104/10.10.00_60/ts_13757104v101000p.pdf
TSDSI	TSDSI STD T1.3GPP 37.571-4-10.10.0 V1.0.0		10.10.0 30.05.2019	https://members.tdsi.in/index.php/s/BxBT9C9F8KxobBg
TTA	TTAT.3G-37.571-4(R10-10.10.0)		10.10.0 06.07.2017	http://www.tta.or.kr/data/ttasDown.jsp?where=14688&pk_num=TTAT.3G-37.571-4(R10-10.10.0)
Release 11				
ARIB	ARIB STD-T104-37.571-4		11.1.0 12.04.2018	http://www.arib.or.jp/english/html/overview/doc/STD-T104v5_20/2_T104/ARIB-STD-T104/Rel11/37/A37571-4-b10.pdf
ATIS	ATIS.3GPP.37.571-4V1110		11.1.0 02.05.2019	https://www.atis.org/docstore/
CCSA	CCSA TSD LTE 37.571-4		11.1.0 11.10.2017	http://www.ccsa.org.cn/ITU_spec/ITU-R/M.2012/M.2012-4/LTE/REL-11/CCSA-TSD-LTE-37571-4-b10.rar
ETSI	ETSI TS 137 571-4		11.1.0 15.01.2016	http://www.etsi.org/deliver/etsi_ts/137500_137599/13757104/11.01.00_60/ts_13757104v110100p.pdf
TSDSI	TSDSI STD T1.3GPP 37.571-4-11.1.0 V1.0.0		11.1.0 30.05.2019	https://members.tdsi.in/index.php/s/BxBT9C9F8KxobBg
TTA	TTAT.3G-37.571-4(R11-11.1.0)		11.1.0 10.08.2016	http://www.tta.or.kr/data/ttasDown.jsp?where=14688&pk_num=TTAT.3G-37.571-4(R11-11.1.0)
Release 12				
ARIB	ARIB STD-T104-37.571-4		12.6.0 12.04.2018	http://www.arib.or.jp/english/html/overview/doc/STD-T104v5_20/2_T104/ARIB-STD-T104/Rel12/37/A37571-4-c60.pdf
ATIS	ATIS.3GPP.37.571-4V1260		12.6.0 02.05.2019	https://www.atis.org/docstore/
CCSA	CCSA TSD LTE 37.571-4		12.6.0 11.01.2019	http://www.ccsa.org.cn/ITU_spec/ITU-R/M.2012/M.2012-4/LTE/REL-12/CCSA-TSD-LTE-37571-4-c60.rar
ETSI	ETSI TS 137 571-4		12.6.0 10.04.2017	http://www.etsi.org/deliver/etsi_ts/137500_137599/13757104/12.06.00_60/ts_13757104v120600p.pdf
TSDSI	TSDSI STD T1.3GPP 37.571-4-12.6.0 V1.0.0		12.6.0 30.05.2019	https://members.tdsi.in/index.php/s/BxBT9C9F8KxobBg
TTA	TTAT.3G-37.571-4(R12-12.6.0)		12.6.0 10.05.2018	http://www.tta.or.kr/data/ttasDown.jsp?where=14688&pk_num=TTAT.3G-37.571-4(R12-12.6.0)
Release 13				
ARIB	ARIB STD-T104-37.571-4		13.4.0 12.04.2018	http://www.arib.or.jp/english/html/overview/doc/STD-T104v5_20/2_T104/ARIB-STD-T104/Rel13/37/A37571-4-d40.pdf
ATIS	ATIS.3GPP.37.571-4V1340		13.4.0 02.05.2019	https://www.atis.org/docstore/
CCSA	CCSA TSD LTE 37.571-4		13.3.0 15.01.2016	http://www.ccsa.org.cn/ITU_spec/ITU-R/M.2012/M.2012-4/LTE/REL-13/CCSA-TSD-LTE-37571-4-d30.rar
ETSI	ETSI TS 137 571-4		13.4.0 11.10.2017	http://www.etsi.org/deliver/etsi_ts/137500_137599/13757104/13.04.00_60/ts_13757104v130400p.pdf
TSDSI	TSDSI STD T1.3GPP 37.571-4-13.4.0 V1.0.0		13.4.0 30.05.2019	https://members.tdsi.in/index.php/s/BxBT9C9F8KxobBg
TTA	TTAT.3G-37.571-4(R13-13.4.0)		13.4.0 10.05.2018	http://www.tta.or.kr/data/ttasDown.jsp?where=14688&pk_num=TTAT.3G-37.571-4(R13-13.4.0)
Release 14				

ARIB	ARIB STD-T104-37.571-4	14.1.0	12.04.2018	http://www.arib.or.jp/english/html/overview/doc/STD-T104v5_20/2_T104/ARIB-STD-T104/Rel14/37/A37571-4-e10.pdf
ATIS	ATIS.3GPP.37.571-4V1410	14.1.0	02.05.2019	https://www.atis.org/docstore/
CCSA	CCSA TSD LTE 37.571-4	14.1.0	15.01.2016	http://www.ccsa.org.cn/ITU_spec/ITU-R/M.2012/M.2012-4/LTE/REL-14/CCSA-TSD-LTE-37571-4-e10.zip
ETSI	ETSI TS 137 571-4	14.1.0	19.01.2018	http://www.etsi.org/deliver/etsi_ts/137500_137599/13757104/14.01.00_60/ts_13757104v140100p.pdf
TSDSI	TSDSI STD T1.3GPP 37.571-4-14.1.0 V1.0.0	14.1.0	30.05.2019	https://members.tdsi.in/index.php/s/BxBT9C9F8KxobBg
TTA	TTAT.3G-37.571-4(R14-14.1.0)	14.1.0	09.05.2019	http://www.tta.or.kr/data/ttasDown.jsp?where=14688&pk_num=TTAT.3G-37.571-4(R14-14.1.0)

2.1.6.19 TS 37.571-5

Universal Terrestrial Radio Access (UTRA) and Evolved UTRA (E-UTRA) and Evolved Packet Core (EPC); User Equipment (UE) conformance specification for UE positioning; Part 5: Test scenarios and assistance data

This document specifies the test scenarios and assistance data required for the conformance test for FDD or TDD mode of UTRA and E-UTRA for the User Equipment (UE) that supports one or more of the defined positioning methods. For UTRA these are Assisted Global Positioning System (A-GPS) and Assisted Global Navigation Satellite System (A-GNSS). For E-UTRA these are A-GNSS, Observed Time Difference of Arrival (OTDOA) and Enhanced Cell ID (ECID).

SDO	Document No.	Version	Issued date	Location
Release 10				
ARIB	ARIB STD-T104-37.571-5		10.11.0	12.04.2018 http://www.arib.or.jp/english/html/overview/doc/STD-T104v5_20/2_T104/ARIB-STD-T104/Rel10/37/A37571-5-ab0.pdf
ATIS	ATIS.3GPP.37.571-5V10110		10.11.0	02.05.2019 https://www.atis.org/docstore/
CCSA	CCSA TSD LTE 37.571-5		10.11.0	10.04.2017 http://www.ccsa.org.cn/ITU_spec/ITU-R/M.2012/M.2012-4/LTE/REL-10/CCSA-TSD-LTE-37571-5-ab0.rar
ETSI	ETSI TS 137 571-5		10.11.0	18.01.2016 http://www.etsi.org/deliver/etsi_ts/137500_137599/13757105/10.11.00_60/ts_13757105v101100p.pdf
TSDSI	TSDSI STD T1.3GPP 37.571-5-10.11.0 V1.0.0		10.11.0	30.05.2019 https://members.tdsi.in/index.php/s/BxBT9C9F8KxobBg
TTA	TTAT.3G-37.571-5(R10-10.11.0)		10.11.0	06.07.2017 http://www.tta.or.kr/data/ttasDown.jsp?where=14688&pk_num=TTAT.3G-37.571-5(R10-10.11.0)
Release 11				
ARIB	ARIB STD-T104-37.571-5		11.1.0	12.04.2018 http://www.arib.or.jp/english/html/overview/doc/STD-T104v5_20/2_T104/ARIB-STD-T104/Rel11/37/A37571-5-b10.pdf
ATIS	ATIS.3GPP.37.571-5V11110		11.1.0	02.05.2019 https://www.atis.org/docstore/
CCSA	CCSA TSD LTE 37.571-5		11.1.0	11.10.2017 http://www.ccsa.org.cn/ITU_spec/ITU-R/M.2012/M.2012-4/LTE/REL-11/CCSA-TSD-LTE-37571-5-b10.rar
ETSI	ETSI TS 137 571-5		11.1.0	18.01.2016 http://www.etsi.org/deliver/etsi_ts/137500_137599/13757105/11.01.00_60/ts_13757105v110100p.pdf
TSDSI	TSDSI STD T1.3GPP 37.571-5-11.1.0 V1.0.0		11.1.0	30.05.2019 https://members.tdsi.in/index.php/s/BxBT9C9F8KxobBg
TTA	TTAT.3G-37.571-5(R11-11.1.0)		11.1.0	06.07.2017 http://www.tta.or.kr/data/ttasDown.jsp?where=14688&pk_num=TTAT.3G-37.571-5(R11-11.1.0)
Release 12				
ARIB	ARIB STD-T104-37.571-5		12.7.0	12.04.2018 http://www.arib.or.jp/english/html/overview/doc/STD-T104v5_20/2_T104/ARIB-STD-T104/Rel12/37/A37571-5-c70.pdf
ATIS	ATIS.3GPP.37.571-5V1270		12.7.0	02.05.2019 https://www.atis.org/docstore/
CCSA	CCSA TSD LTE 37.571-5		12.7.0	11.01.2019 http://www.ccsa.org.cn/ITU_spec/ITU-R/M.2012/M.2012-4/LTE/REL-12/CCSA-TSD-LTE-37571-5-c70.rar
ETSI	ETSI TS 137 571-5		12.7.0	10.04.2017 http://www.etsi.org/deliver/etsi_ts/137500_137599/13757105/12.07.00_60/ts_13757105v120700p.pdf
TSDSI	TSDSI STD T1.3GPP 37.571-5-12.7.0 V1.0.0		12.7.0	30.05.2019 https://members.tdsi.in/index.php/s/BxBT9C9F8KxobBg
TTA	TTAT.3G-37.571-5(R12-12.7.0)		12.7.0	10.05.2018 http://www.tta.or.kr/data/ttasDown.jsp?where=14688&pk_num=TTAT.3G-37.571-5(R12-12.7.0)
Release 13				
ARIB	ARIB STD-T104-37.571-5		13.3.0	12.04.2018 http://www.arib.or.jp/english/html/overview/doc/STD-T104v5_20/2_T104/ARIB-STD-T104/Rel13/37/A37571-5-d30.pdf
ATIS	ATIS.3GPP.37.571-5V1330		13.3.0	02.05.2019 https://www.atis.org/docstore/
CCSA	CCSA TSD LTE 37.571-5		13.2.0	15.01.2016 http://www.ccsa.org.cn/ITU_spec/ITU-R/M.2012/M.2012-4/LTE/REL-13/CCSA-TSD-LTE-37571-5-d20.rar
ETSI	ETSI TS 137 571-5		13.3.0	11.10.2017 http://www.etsi.org/deliver/etsi_ts/137500_137599/13757105/13.03.00_60/ts_13757105v130300p.pdf

114

TSDSI	TSDSI STD T1.3GPP 37.571-5-13.3.0 V1.0.0	13.3.0	30.05.2019	https://members.tdsi.in/index.php/s/BxBT9C9F8KxobBg
TTA	TTAT.3G-37.571-5(R13-13.3.0)	13.3.0	10.05.2018	http://www.tta.or.kr/data/ttasDown.jsp?where=14688&pk_num=TTAT.3G-37.571-5(R13-13.3.0)

Release 14

ARIB	ARIB STD-T104-37.571-5	14.2.0	12.04.2018	http://www.arib.or.jp/english/html/overview/doc/STD-T104v5_20/2_T104/ARIB-STD-T104/Rel14/37/A37571-5-e20.pdf
ATIS	ATIS.3GPP.37.571-5V1420	14.2.0	02.05.2019	https://www.atis.org/docstore/
CCSA	CCSA TSD LTE 37.571-5	14.2.0	15.01.2016	http://www.ccsa.org.cn/ITU_spec/ITU-R/M.2012/M.2012-4/LTE/REL-14/CCSA-TSD-LTE-37571-5-e20.zip
ETSI	ETSI TS 137 571-5	14.2.0	11.10.2017	http://www.etsi.org/deliver/etsi_ts/137500_137599/13757105/14.02.00_60/ts_13757105v140200p.pdf
TSDSI	TSDSI STD T1.3GPP 37.571-5-14.2.0 V1.0.0	14.2.0	30.05.2019	https://members.tdsi.in/index.php/s/BxBT9C9F8KxobBg
TTA	TTAT.3G-37.571-5(R14-14.2.0)	14.2.0	10.05.2018	http://www.tta.or.kr/data/ttasDown.jsp?where=14688&pk_num=TTAT.3G-37.571-5(R14-14.2.0)

Rec. ITU-R M.2012-4

2.2 Other specifications

The radio aspects of *LTE-Advanced* include the capabilities of LTE Release 8 and LTE Release 9. Information on the Radio specifications Release 8 and Release 9 is provided in § 2.2.1.

Furthermore, information on system and core network specifications is also provided for a complete system perspective. These system and core network specifications address the network, terminal, and service aspects required to provide an integrated mobility solution including aspects such as user services, connectivity, interoperability, mobility and roaming, security, codecs and media, operations and maintenance, charging, etc. Information on the System and core network specifications Release 8, Release 9, Release 10, Release 11, Release 12, Release 13 and Release 14 is provided in § 2.2.2.

2.2.1 Radio specifications

Release 8 and Release 9 of specifications listed in § 2.1 are provided as the foundation of the radio aspects of *LTE-Advanced*. They are available at <http://ties.itu.int/u/itu-r/ede/rsg5/IMT-Advanced/GCS/M.2012-4/LTE-Advanced/>.

2.2.2 System and core network specifications

The system and core network specifications listed in this section are available at <http://ties.itu.int/u/itu-r/ede/rsg5/IMT-Advanced/GCS/M.2012-4/LTE-Advanced/>.

2.2.2.1 TS 21.111

USIM and IC card requirements

This specification describes the requirements of the USIM and the USIM IC card (UICC). These are derived from the service and security requirements defined in the respective specifications. The document is the basis for the detailed specification of the USIM and the UICC, and the interface to the terminal.

2.2.2.2 TS 21.201

Technical specifications and technical reports relating to an Evolved Packet System (EPS) based 3GPP system

This document identifies the 3GPP technical specifications and technical reports required or potentially required to build a system based on the Evolved Packet System/LTE/E-UTRAN radio technology.

2.2.2.3 TS 21.202

Technical Specifications and Technical Reports relating to the Common IP Multimedia Subsystem (IMS)

This document identifies the 3GPP Technical Specifications and Technical Reports specifically relating to the Common IP Multimedia Subsystem (IMS) maintained by 3GPP. Standards organizations adopting the Common IP Multimedia Subsystem (IMS) might not need to use all listed specifications.

2.2.2.4 TR 21.905

Vocabulary

Document TR 21.905 is a collection of terms, definitions and abbreviations related to the baseline documents defining the objectives and systems framework. This document provides a tool for further work on the technical documentation and facilitates their understanding.

2.2.2.5 TS 22.002

Bearer services supported by a GSM PLMN

This specification describes a set of bearer services to be provided to subscribers by a 3G and beyond network itself and in connection with other networks. This document is also be used as a reference for defining the corresponding required mobile network capabilities which are specified by means of the connection type concept.

2.2.2.6 TS 22.004

General on supplementary services

This specification describes a recommended set of supplementary services to the teleservices and bearer services which will be supported by a 3G and beyond network in connection with other networks as a basis for the definition of the network capabilities required.

2.2.2.7 TS 22.011

Service accessibility

This specification describes the service access procedures as presented to the user. The document contains definitions and procedures are provided for international roaming, national roaming and regionally provided service. These are mandatory in relation to the technical realization of the UE.

2.2.2.8 TS 22.016

International mobile equipment identities (IMEI)

This specification describes the principal purpose and use of unique equipment identities.

2.2.2.9 TS 22.022

Personalization of GSM ME mobile functionality specification – Stage 1

This specification describes functional specifications of five features to personalize UE. These features are called:

- network personalization;
- network subset personalization;
- service provider (SP) personalization;
- corporate personalization;
- UMTS subscriber identity module (USIM) personalization.

This specification describes requirements for UE, which provide these personalization features.

2.2.2.10 TS 22.034

High-speed circuit switched data (HSCSD) – Stage 1

This specification describes the Stage 1 description of HSCSD. HSCSD is a feature that allows users subscribing to the general bearer services to access user rates that can be achieved with one or more traffic channel. HSCSD also defines a flexible use of air interface resources, which makes efficient and flexible use of higher user rates feasible.

2.2.2.11 TS 22.038**SIM application toolkit (SAT) – Stage 1**

This specification describes the Stage 1 description of the SAT primarily from the subscriber's and serving environment's points of view, and does not deal with the details of the human interface itself. It includes information applicable to network operators, serving environments and terminal, switch and database manufacturers and contains the core requirements for a SAT, which are sufficient to provide a complete service.

2.2.2.12 TS 22.041**Operator Determined Barring (ODB)**

This document specifies the network feature Operator Determined Barring (ODB), which allows the network operator or service provider to regulate, by means of an exceptional procedure, access by the subscribers to services (both Circuit and Packet Oriented), by the barring of certain categories of outgoing or incoming calls/Packet Oriented Services or of roaming.

2.2.2.13 TS 22.060**General packet radio service (GPRS) – Stage 1**

This specification describes the Stage 1 description of the GPRS.

2.2.2.14 TS 22.067**Priority set-up service – Stage 1 (ASCI spec)**

This specification describes the Stage 1 description of the enhanced multi-level precedence and pre-emption (eMLPP) service. This service has two parts: precedence and pre-emption. Precedence involves assigning a priority level to a call in combination with fast call set-up.

Pre-emption involves the seizing of resources, which are in use by a call of a lower precedence, by a higher level precedence call in the absence of idle resources. Pre-emption can also involve the disconnection of an ongoing call of lower precedence to accept an incoming call of higher precedence.

2.2.2.15 TS 22.071**Location services (LCS) – Stage 1**

LCS is a network provided enabling technology consisting of standardized service capabilities that enables the provision of location applications. This application may be service provider specific. The description of the numerous and varied possible location applications which are enabled by this technology are outside the scope of this specification. However, clarifying examples of how the functionality being specified may be used to provide specific LCS is included in various sections of the specification.

2.2.2.16 TS 22.078**Customized applications for mobile network enhanced logic (CAMEL) – Stage 1**

This specification describes the Stage 1 description for CAMEL feature, which provides the mechanisms to support services consistently independently of the serving network. The CAMEL features shall facilitate service control of operator specific services external from the serving network. The CAMEL feature is a network feature and not a supplementary service. It is a tool to help the network operator to provide the subscribers with the operator specific services even when roaming outside the home network.

2.2.2.17 TS 22.081**Line Identification supplementary services; Stage 1**

This document specifies the supplementary services belonging to the group Line Identification Supplementary Services, which consist of Calling line identification presentation (CLIP), Calling line identification restriction (CLIR), Connected line identification presentation (COLP), and Connected line identification restriction (COLR).

2.2.2.18 TS 22.082**Call Forwarding (CF) Supplementary Services; Stage 1**

This document specifies the supplementary services belonging to the group Call Offering Supplementary Services, which consist of Call forwarding unconditional, Call forwarding on mobile subscriber busy, Call forwarding on no reply, and Call forwarding on mobile subscriber not reachable.

2.2.2.19 TS 22.083**Call Waiting (CW) and Call Holding (HOLD); Supplementary Services; Stage 1**

This document specifies the supplementary services belonging to the group Call Completion Supplementary Services, which consist of Call waiting and Call hold.

2.2.2.20 TS 22.084**MultiParty (MPTY) supplementary service; Stage 1**

This document specifies the supplementary services belonging to the group MultiParty Supplementary Services, which consist of MultiParty service.

2.2.2.21 TS 22.085**Closed User Group (CUG) supplementary services; Stage 1**

This document specifies the supplementary services belonging to the group Community Of Interest Supplementary Services, which consist of Closed user group.

2.2.2.22 TS 22.086**Advice of Charge (AoC) supplementary services; Stage 1**

This document specifies the supplementary services belonging to the group Charging Supplementary Services, which consist of Advice of Charge (Information) and Advice of Charge (Charging).

2.2.2.23 TS 22.087**User-to-User Signalling (UUS); Service description; Stage 1**

This document specifies the User-to-User Signalling (UUS) supplementary service, which allows a mobile subscriber to send/receive a limited amount of information to/from another PLMN or ISDN subscriber over the signalling channel in association with a call to the other subscriber.

2.2.2.24 TS 22.088**Call Barring (CB) supplementary services; Stage 1**

This document specifies the supplementary services belonging to the group Call Restriction Supplementary Services, which consist of barring of outgoing calls and barring of incoming calls.

2.2.2.25 TS 22.090**Unstructured supplementary service data (USSD); Stage 1**

There are two modes of USSD: MMI-mode and application mode. MMI-mode USSD is for the transparent transport of MMI strings entered by the user to the network and for the transparent transport of text strings from the network that are displayed by the mobile for user information. Application mode USSD is for the transparent transport of data between the network and the mobile station. Application mode USSD is intended to be used by applications in the network and their peer applications in the UE. The communication over the radio interface takes place on the signalling channels using short dialogues with peak data throughput rate capabilities of up to approximately 600 bits/s outside of a call and 1 000 bits/s during a call.

2.2.2.26 TS 22.091**Explicit Call Transfer (ECT) supplementary service; Stage 1**

This document specifies the stage 1 description of Explicit Call Transfer (ECT) from the service subscriber's and user's points of view, in particular, the procedures for normal operation with successful outcome, the action to be taken in exceptional circumstances, and the interaction with other supplementary services.

2.2.2.27 TS 22.093**Completion of Calls to Busy Subscriber (CCBS); Service description, Stage 1**

This document specifies the stage 1 description of Completion of Calls to Busy Subscriber (CCBS) from the subscriber's and user's points of view, in particular, the procedures for normal operation with successful outcome, the action to be taken in exceptional circumstances, and the interaction with other supplementary services.

2.2.2.28 TS 22.094**Follow Me service description; Stage 1**

This document specifies the stage 1 description for the Follow Me feature, which enables a mobile subscriber A to manipulate the Follow Me data of a party B in such a way that – under certain conditions – subsequent calls directed to party B will be forwarded to subscriber A.

2.2.2.29 TS 22.096**Name identification supplementary services; Stage 1**

This document specifies the supplementary services belonging to the group Name Identification supplementary services, which consist of Calling Name Presentation (CNAP).

2.2.2.30 TS 22.101**UMTS service principles**

This specification describes the service principles of the UMTS.

2.2.2.31 TS 22.105**Services and service capabilities**

Pre-UMTS systems have largely standardized the complete sets of bearer services, teleservices and supplementary services that they provide. One major difference between UMTS and preUMTS systems is that service capabilities rather than services are standardized for UMTS, allowing service

differentiation and system continuity. This document describes how and what kind of services the UMTS user has access to.

2.2.2.32 TS 22.115

Service aspects: charging and billing

This specification describes the service aspects of charging and billing of the UMTS. This standard is not intended to duplicate existing standards or standards being developed by other groups on these topics, and will reference these where appropriate. This standard will elaborate on the charging requirements described in the charging principles in TS 22.101 UMTS service principles. It will allow the generation of accurate charging information to be used in the commercial and contractual relationships between the parties concerned.

2.2.2.33 TS 22.129

Handover requirements between UMTS and GSM or other radio systems

This specification describes service requirements for handover (terms are defined below) within UMTS systems and between UMTS, other IMT-2000 family members and second generation systems. Particular emphasis has been placed on the description of requirements for handover between UMTS and GSM but requirements specific to other systems are incorporated as required.

2.2.2.34 TS 22.135

Multicall

This specification describes multicall scenarios and requirements for UMTS phase 1 release 1999. Multicall feature specifies functionality and interactions related to usage of several simultaneous bearers between a terminal and a network. Multicall features allow both circuit-switched call(s) and packet session(s) to exist simultaneously.

2.2.2.35 TS 22.146

Multimedia Broadcast/Multicast Service (MBMS) user services; Stage 1

The document describes MBMS User Services that use the capabilities of MBMS. Application scenarios including charging, QoS aspects and related service requirements derived from them are described. These scenarios and service requirements can be used as guidance for the design of codecs and bearers.

2.2.2.36 TS 22.153

Multimedia priority service

The document specifies the service requirements for Multimedia Priority Service (MPS). Its scope is to specify those requirements of MPS necessary to provide an end-to-end service and to interwork with external networks where needed. Service interactions with external networks are considered within the scope of this document although these interactions may be specified in other standards.

2.2.2.37 TS 22.173

Multimedia telephony service and supplementary services; Stage 1

The document defines the IMS multimedia telephony service and the minimum set of capabilities required to secure multi-vendor and multi-operator inter-operability for multimedia telephony and related supplementary services.

2.2.2.38 TS 22.179**Mission Critical Push to Talk (MCPTT) over LTE; Stage 1**

This document provides the service requirements for operation of the MCPTT Service. MCPTT makes use of capabilities included in Group Communications System Enablers for LTE (GCSE_LTE) and Proximity Services (ProSe), with additional requirements specific to the MCPTT Service. The MCPTT Service can be used for public safety applications and also for general commercial applications (e.g. utility companies and railways).

2.2.2.39 TS 22.182**Customized Alerting Tones (CAT) requirements; Stage 1**

This document specifies the requirements and technical considerations for Customized Alerting Tone (CAT) service in both CS and PS domains, especially additional features for roaming and interoperability support.

2.2.2.40 TS 22.183**Customized Ringing Signal (CRS) requirements; Stage 1**

The document specifies the requirements and technical considerations for Customized Ringing Signal (CRS) service in the PS and CS domains, especially additional features for roaming and interoperability support.

2.2.2.41 TS 22.185**Service requirements for V2X services**

This document provides 3GPP support for V2X service requirements to be supported by LTE transport. These requirements are identified by taking into account the V2X service requirements defined in other SDOs, e.g. ETSI ITS, US SAE. The specification includes requirements of safety and non-safety aspects.

2.2.2.42 TS 22.220**Service requirements for Home NodeB (HNB) and Home eNodeB (HeNB)**

This specification defines the service requirements for the basic functionalities for the support of Home NodeB (HNB) and Home eNodeB (HeNB) – jointly referred to as H(e)NB – and the further functionalities that will enable the mobile operators to provide more advanced services as well as improving the user experience.

2.2.2.43 TS 22.228**IP Multimedia Subsystem Stage 1**

This specification describes all IP Multimedia services offered by UMTS Systems and second generation systems.

2.2.2.44 TS 22.234**Requirements on 3GPP system to Wireless Local Area Network (WLAN) interworking**

The document specifies the functional requirements placed on the 3GPP system for interworking WLAN with the 3GPP system. Guidance is given for WLAN operators intending to provide the interworked WLAN capability.

2.2.2.45 TS 22.246**Multimedia Broadcast/Multicast Service (MBMS) user services; Stage 1**

This document describes MBMS User Services that use the capabilities of MBMS. Application scenarios including charging, QoS aspects and related service requirements derived from them are described. These scenarios and service requirements can be used as guidance for the design of codecs and bearers.

2.2.2.46 TS 22.268**Public Warning System (PWS) requirements**

This document covers the core requirements for the PWS that are sufficient to provide a complete service. This TS also covers subsystem additional requirements for the Earthquake and Tsunami Warning System (ETWS) and the Commercial Mobile Alert System (CMAS).

2.2.2.47 TS 22.278**Service requirements for the Evolved Packet System (EPS)**

This document describes the service requirements for the Evolved Packet System.

2.2.2.48 TS 22.279**Combined Circuit Switched (CS) and IP Multimedia Subsystem (IMS) sessions; Stage 1**

This document specifies service requirements for Combining CS and IMS services using a CS speech or CS multimedia call in association with an IMS session.

2.2.2.49 TS 22.280**Mission Critical Services Common Requirements**

This document provides the service requirements that are common across two or more mission critical services, that is MCPTT, MCData and MCVideo. The mission critical services make use of capabilities included in Group Communications System Enablers for LTE (GCSE_LTE) and Proximity Services (ProSe), with additional requirements specific to the MCPTT Service as specified in 3GPP TS 22.179, MCVideo Service as specified in 3GPP TS 22.281, and MCData Service as specified in 3GPP TS 22.282. The mission critical services can be used for public safety applications and also for general commercial applications (e.g. utility companies and railway operators).

2.2.2.50 TS 22.281**Mission Critical Video over LTE**

This document provides the service requirements for operation of the MCVideo service. MCVideo makes use of capabilities included in Group Communication System Enablers for LTE (GCSE_LTE), Proximity Services (ProSe), Isolated E-UTRAN operation for Public Safety (IOPS) and Mission Critical Services Common Requirements (MCCoRe) with additional requirements specific to the MCVideo Service. The MCVideo Service can be used for public safety applications and also for general commercial applications (e.g. utility companies and railways).

2.2.2.51 TS 22.282**Mission Critical Data over LTE**

This document provides the service requirements for operation of the MCData service. MCData makes use of capabilities included in Group Communication System Enablers for LTE (GCSE_LTE), Proximity Services (ProSe), Isolated E-UTRAN operation for Public Safety (IOPS) and Mission

Critical Services Common Requirements (MCCoRe) with additional requirements specific to the MCDData Service. The MCDData Service can be used for public safety applications and also for general commercial applications (e.g. utility companies and railways).

2.2.2.52 TS 22.346

Isolated Evolved Universal Terrestrial Radio Access Network (E-UTRAN) operation for public safety; Stage 1

This document specifies the service requirements for Isolated E-UTRAN Operation in support of mission critical network operation for Public Safety. In particular, requirements are specified for:

- Initiation of Isolated E-UTRAN operation.
- Ongoing Isolated E-UTRAN operation.
- Termination of Isolated E-UTRAN operation.
- Security aspects of Isolated E-UTRAN operation.

2.2.2.53 TS 22.368

Service requirements for Machine-Type Communications (MTC); Stage 1

This document specifies the service requirements for Network Improvements for Machine Type Communications. In particular it will:

- identify and specify general requirements for machine type communications;
- identify service aspects where network improvements (compared to the current human-to-human oriented services) are needed to cater for the specific nature of machine-type communications;
- specify machine type communication requirements for these service aspects where network improvements are needed for machine type communication.

2.2.2.54 TS 22.468

Group Communication System Enablers for LTE (GCSE_LTE)

This document collects the requirements as relevant to improve the EPC and E-UTRAN for system enablers to the 3GPP system to support Group Communication over LTE for Public Safety and Critical Communication.

The US requirements as specified in NPSTC (Mission Critical Voice Requirements), the TETRA + Critical Communications Association (TCCA) and ITU inputs are taken as starting point.

Other regional requirements may also be reflected in the work. The requirements are worded in a way to easily accommodate future requirements from other regions or stakeholders.

2.2.2.55 TS 22.519

Business communication requirements

This document specifies network requirements:

- to support connection and interoperation of business communication capabilities (either hosted in NGCN or NGN) to the NGN; and
- to support connection and interoperation of business communication capabilities to other business communication capabilities (either hosted in NGCN or NGN); and
- to support connection and interoperation of business communication capabilities to other business communication capabilities located in or connected to the ISDN and PSTN; and

– to support PABX functionality (hosted enterprise services) in an NGN.

NOTE 1: Network requirements to support connection of NGCN directly connected to an NGN are specified.

NOTE 2: Attachment of legacy PBX functionality to the NGN is not specified in this document. It is assumed that existing legacy service requirements apply in this case.

This document also specifies network requirements for communication between NGCN capabilities (including user equipment) to other NGCN capabilities of the same enterprise through the NGN (e.g. geographically separated).

This document does not specify NGCN services, nor does it specify network based application services provided to a user of an NGCN.

2.2.2.56 TS 23.002

Network architecture

This specification describes the possible architectures of the mobile system.

2.2.2.57 TS 23.003

Numbering, addressing and identification

This document defines the principal purpose and use of International Mobile station Equipment Identities (IMEI) within the digital cellular telecommunications system and the 3GPP system.

2.2.2.58 TS 23.007

Restoration procedures

The data stored in location registers are automatically updated in normal operation; the main information stored in a location register defines the location of each mobile station and the subscriber data required to handle traffic for each mobile subscriber. The loss or corruption of these data will seriously degrade the service offered to mobile subscribers; it is therefore necessary to define procedures to limit the effects of failure of a location register, and to restore the location register data automatically. This document defines the necessary procedures.

2.2.2.59 TS 23.008

Organization of subscriber data

This document provides details concerning information to be stored in home subscriber servers, visitor location registers, GPRS Support Nodes and Call Session Control Function (CSCF) concerning mobile subscriber.

2.2.2.60 TS 23.011

Technical realization of Supplementary Services

This document describes the general aspects on how supplementary services in the 3GPP system are realized from a technical point of view. Description of technical realisation for specific supplementary services can be found in 3GPP TS 23.072.

All supplementary services may require signalling on the radio path. For some supplementary services information needs to be transferred between the Home Location Register (HLR), the Visitor Location Register (VLR), the Mobile services Switching Centre (MSC) and the Serving GPRS Support Node (SGSN). Signalling procedures for such information transfer are defined in 3GPP TS 29.002.

2.2.2.61 TS 23.012

Location management procedures

This document describes the location management procedures for the circuit switched domain, with respect to the application level functional behaviour. This is to be distinguished from the corresponding protocol handling behaviour, which is specified in 3GPP TS 29.002. The following location management procedures are included:

- location updating;
- location cancellation;
- MS purging;
- IMSI attach/detach.

The procedures in the Mobile Station (MS) are described in 3GPP TS 23.022. The procedures between MSC, VLR and HLR utilise the Mobile Application Part (MAP) and details concerning the protocol handling are contained in 3GPP TS 29.002.

This document excludes location management procedures for the packet switched domain, which are covered in 3GPP TS 23.060.

The descriptions herein depict a logical separation between the MSC and VLR. This logical separation, as well as the messages transferred between the two logical entities are the basis of a model used to define the externally visible behaviour of the MSC/VLR, which may be a single physical entity. They do not impose any requirement except the definition of the externally visible behaviour.

2.2.2.62 TS 23.018

Basic call handling; Technical realization

This document specifies the technical realization of the handling of calls originated by a UMTS or GSM mobile subscriber and calls directed to a UMTS or GSM mobile subscriber, up to the point where the call is established. Normal release of the call after establishment is also specified. Trunk Originated call is also modelled.

2.2.2.63 TS 23.034

High Speed Circuit Switched Data (HSCSD) – Stage 2

This document describes the stage 2 service description for a High Speed Circuit Switched Data (HSCSD) on GSM/GERAN in A/G_b mode and I_u mode. HSCSD utilizes the multislot mechanism, i.e. using multiple traffic channels (/bearers) for the communication.

Additionally, the document specifies some HSCSD related requirements for multi system mobile stations operating in UTRAN I_u mode. Stage 2 identifies the functional capabilities and information flows needed to support the service. Furthermore, it identifies various possible physical locations for the functional capabilities.

2.2.2.64 TS 23.038

Alphabets and language-specific information

This specification describes the language specific requirements for the terminals including character coding.

2.2.2.65 TS 23.040**Technical realization of the Short Message Service (SMS)**

This specification describes the point-to-point SMS.

2.2.2.66 TS 23.041**Technical realization of Cell Broadcast Service (CBS)**

This specification describes the point-to-multipoint CBS.

2.2.2.67 TS 23.042**Compression algorithm for text messaging services**

This specification describes the compression algorithm for text messaging services.

2.2.2.68 TS 23.057**Mobile Execution Environment (MExE) – Stage 2**

This TS describes the functional capabilities and the security architecture of the Mobile Execution Environment.

2.2.2.69 TS 23.060**General packet radio service (GPRS) service description – Stage 2**

This specification describes a general overview over the GPRS architecture as well as a more detailed overview of the MS – CN protocol architecture. Details of the protocols will be specified in companion documents.

2.2.2.70 TS 23.078**Customized Applications for Mobile network Enhanced Logic (CAMEL) Phase 4; Stage 2**

This document specifies the stage 2 description for the fourth phase of the Customized Applications for Mobile network Enhanced Logic (CAMEL) feature, which provides the mechanisms to support services of operators which are not covered by standardized services even when roaming outside the HPLMN.

The CAMEL feature is a network feature and not a supplementary service. It is a tool to help the network operator to provide the subscribers with the operator specific services even when roaming outside the HPLMN. CAMEL applicability to IP-based multimedia services is introduced in the fourth phase of the CAMEL. It is specified in 3GPP TS 23.278.

2.2.2.71 TS 23.081**Line Identification supplementary services; Stage 2**

This document gives the stage 2 description of the call identification supplementary services.

The group line identification supplementary services are divided into the following four supplementary services:

- Calling line identification presentation CLIP;
- Calling line identification restriction CLIR;
- Connected line identification presentation COLP;
- Connected line identification restriction COLR.

2.2.2.72 TS 23.082**Call Forwarding (CF) supplementary services; Stage 2**

This document gives the stage 2 description of the call forwarding supplementary services.

The group of supplementary services call offering supplementary services is divided into four different supplementary services:

- Call forwarding unconditional (CFU);
- Call forwarding on mobile subscriber busy (CFB);
- Call forwarding on no reply (CFNRy);
- Call forwarding on mobile subscriber not reachable (CFNRc).

2.2.2.73 TS 23.083**Call Waiting (CW) and Call Hold (HOLD) supplementary services; Stage 2**

This document gives the stage 2 description of the call completion supplementary services.

The group of call completion supplementary services is divided into the following two supplementary services:

- Call waiting (CW);
- Call hold (HOLD).

2.2.2.74 TS 23.084**Multi Party (MPTY) supplementary service; Stage 2**

This document gives the stage 2 description of the multi party supplementary services.

Only one multi party supplementary service has been defined, this is the Multi Party (MPTY) service.

2.2.2.75 TS 23.085**Closed User Group (CUG) supplementary service; Stage 2**

This document gives the stage 2 description of the closed user group supplementary service.

The community of interest supplementary service defined is:

- Closed user group (CUG).

2.2.2.76 TS 23.086**Advice of Charge (AoC) supplementary services; Stage 2**

This document gives the stage 2 description of the Advice of Charge (AoC) supplementary services.

The charging supplementary services currently defined are:

- Advice of Charge (Information) (AoCI);
- Advice of Charge (Charging) (AoCC).

2.2.2.77 TS 23.087**User-to-User Signalling (UUS) supplementary service; Stage 2**

This document gives the stage 2 description of the User-to-User signalling supplementary services.

The User-to-user supplementary service is divided into three different services:

- Service 1 (UUS1)

- Service 2 (UUS2)
- Service 3 (UUS3)

2.2.2.78 TS 23.088

Call Barring (CB) Supplementary Services; Stage 2

This document gives the stage 2 description of the call barring services.

The possibility for a mobile subscriber to have certain categories of calls barred originated from or terminated at his access:

Barring of outgoing calls:

- Barring of all outgoing calls (BAOC) (Barring program 1);
- Barring of outgoing international calls (BOIC) (Barring program 2);
- Barring of outgoing international calls EXCEPT those directed to the home PLMN country (BOIC-exHC) (Barring program 3).

Barring of incoming calls:

- Barring of all incoming calls (BAIC) (Barring program 1);
- Barring of incoming calls when roaming outside the home PLMN country (BIC-Roam) (Barring program 2);
- Anonymous Call Rejection (ACR) (Barring program 3).

The call barring program “incoming calls when roaming outside the home PLMN country” is only relevant if as a general rule the called mobile subscriber pays the charges for the forwarded part of the call from his home PLMN country to any other country.

2.2.2.79 TS 23.090

Unstructured Supplementary Service Data (USSD); Stage 2

This document gives the stage 2 description of Unstructured Supplementary Service Data (USSD).

The USSD mechanism allows the Mobile Station (MS) user and a PLMN operator defined application to communicate in a way which is transparent to the MS and to intermediate network entities. The mechanism allows development of PLMN specific supplementary services.

This document defines the requirements for handling USSD at the MS and network entities. It does not include specification of particular applications, nor does it specify how a particular application is selected. Where more than one application exists at a network entity, routing of messages to the correct application is carried out by the USSD handler. The MMI for USSD is specified in 3GPP TS 22.030 and 3GPP TS 22.090. The alphabet indicator and the data coding scheme are defined in 3GPP TS 23.038.

USSD may be initiated by the MS user, or by the network in the following ways:

- Network initiated USSD;
- Mobile initiated USSD.

2.2.2.80 TS 23.091

Explicit Call Transfer (ECT) supplementary service; Stage 2

This document gives the stage 2 description of the call transfer supplementary services.

Only one call transfer supplementary service has been defined, this is the Explicit Call Transfer (ECT) supplementary service, and it is described in this document.

2.2.2.81 TS 23.093**Technical realization of Completion of Calls to Busy Subscriber (CCBS); Stage 2**

This document gives the stage 2 description of the Completion of Calls to Busy Subscriber (CCBS) supplementary service.

2.2.2.82 TS 23.094**Follow-Me (FM); Stage 2**

This document specifies the stage 2 description for the Follow Me feature.

The Follow Me feature enables a mobile subscriber A to manipulate the Follow Me data of a remote party B in such a way that subsequent calls directed to remote party B will be forwarded to subscriber A.

2.2.2.83 TS 23.096**Name identification supplementary services; Stage 2**

This document gives the stage 2 description of the Name Identification Supplementary Services.

The group of Name Identification Supplementary Services contains the following Supplementary Service:

CNAP – Calling name presentation.

2.2.2.84 TS 23.101**General UMTS architecture**

This specification describes the basic physical and functional separation of UMTS. The content of this specification is limited to those features that are common to all UMTS networks independent of their origin. It identifies and names the reference points and functional groupings appearing at this level.

2.2.2.85 TS 23.107**QoS concept and architecture**

This specification describes the framework for QoS in UMTS. The document shall be used as a living document which will cover all issues related QoS in UMTS.

2.2.2.86 TS 23.108**Mobile radio interface layer 3 specification, core network protocols; Stage 2**

This specification describes the procedures used at the radio interface for Call Control (CC), Mobility Management (MM) and Session Management (SM). It contains examples of the structured procedures.

2.2.2.87 TS 23.110**UMTS access stratum services and functions**

This specification describes the detailed specifications of the protocols which rule the information flows, both control and user data, between the access stratum and the parts of UMTS outside the access stratum, and of the detailed specifications of the UTRAN. These detailed specifications are to be found in other technical specifications.

2.2.2.88 TS 23.119**Gateway Location Register (GLR); Stage 2**

This document gives the stage 2 description of the Gateway Location Register (GLR) within the UMTS Core Network as a means of reducing the amount of MAP signalling traffic associated with location management carried over inter-PLMN links for roaming users.

This document will be restricted of the case where the GLR supports one VPLMN only.

2.2.2.89 TS 23.122**Non-Access-Stratum (NAS) functions related to Mobile Station (MS) in idle mode**

This specification provides an overview of the tasks undertaken by a Mobile Station (MS) when in idle mode (that is, switched on but not having a dedicated channel allocated, e.g. not making or receiving a call; or when in group receive mode, that is, receiving a group call or broadcast call but not having a dedicated connection). It also describes the corresponding network functions.

2.2.2.90 TS 23.135**Multicall supplementary service; Stage 2**

This document gives the stage 2 description of the Multicall supplementary service.

2.2.2.91 TS 23.142**Value-added Services for SMS (VAS4SMS) – Interface and Signalling Flow**

The specification describes the stage 2 of the VAS4SMS (Value Added Service for SMS). It includes:

- the logic architecture;
- the logic elements functionality;
- the signalling flows;
- the interaction with other features.

2.2.2.92 TS 23.153**Out-of-band transcoder control; Stage 2**

This document specifies the stage 2 description of the Out-of-Band Transcoder Control for speech services. It describes the principles and procedures to support Transcoder Free Operation, Tandem Free Operation and the interworking between TrFO and TFO. Transcoder at the edge is also part of this document.

2.2.2.93 TS 23.161**Network-Based IP Flow Mobility (NBIFOM); Stage 2**

The scope of this document is to specify the support of NBIFOM (Network based IP Flow Mobility) i.e. IP flow mobility based on network mobility protocols. This feature supports PDN connections that are simultaneously connected over 3GPP access (i.e. S5/S8 connection to a PDN GW) and a WLAN access (i.e. S2a or S2b connection to the same PDN GW).

2.2.2.94 TS 23.167**IP Multimedia Subsystem (IMS) emergency sessions**

This document defines the stage 2 service description for emergency services in the IP Multimedia Core Network Subsystem (IMS), including the elements necessary to support IP Multimedia (IM) emergency services.

2.2.2.95 TS 23.179**Functional architecture and information flows to support mission critical communication services; Stage 2**

This document specifies the functional architecture, procedures and information flows needed to support the mission critical push to talk (MCPTT) service including the common services core architecture for identity management, group management, and configuration management required to support the MCPTT voice service. Support for both MCPTT group calls and MCPTT private calls operating in on-network and off-network modes of operation is specified.

The corresponding service requirements are defined in 3GPP TS 22.179.

This document is applicable primarily to MCPTT voice service using E-UTRAN access based on the EPC architecture defined in 3GPP TS 23.401. Certain MCPTT functions such as dispatch and administrative functions could also be supported via non-3GPP access networks but no additional functionality is specified to support non-3GPP access.

The MCPTT service requires preferential handling compared to normal telecommunication services e.g. in support of police or fire brigade including the handling of prioritised MCPTT calls for emergency and imminent threats.

The MCPTT service can be used for public safety applications and also for general commercial applications, e.g. utility companies and railways.

In this document, MCPTT calls between MCPTT users on different MCPTT systems are considered, however, for roaming only EPC-level roaming and IMS-level roaming are considered i.e. partner MCPTT system based roaming (also known as "migration") is out of scope.

2.2.2.96 TS 23.203**Policy and charging control architecture**

This document specifies the overall stage 2 level functionality for Policy and Charging Control that encompasses the following high level functions for IP-CANs (e.g. GPRS, I-WLAN, Fixed Broadband, etc.): (i) Flow Based Charging, including charging control and online credit control; (ii) Policy control (e.g. gating control, QoS control, QoS signalling, etc.).

2.2.2.97 TS 23.204**Support of Short Message Service (SMS) over generic 3GPP Internet Protocol (IP) access; Stage 2**

This document specifies the new capabilities and enhancements needed to support SMS over a generic IP Connectivity Access Network (IP-CAN) using IMS capabilities.

2.2.2.98 TS 23.205**Bearer-independent circuit-switched core network; Stage 2**

This document defines the stage 2 description for the bearer independent CS core network. The stage 2 shall cover the information flow between the GMSC server, MSC server and media gateways. Note

that nothing in this document shall preclude an implementation of a combined MSC Server and MGW. This document shall show the CS core network termination of the Iu interface in order to cover the information flow stimulus to the core network and describe the interaction with the supplementary and value added services and capabilities.

2.2.2.99 TS 23.214

Architecture enhancements for control and user plane separation of EPC nodes

This document specifies the overall stage 2 level functionality for control and user plane separation of EPC's SGW, PGW and TDF. This enables a flexible placement of the separated control plane and user plane functions for supporting diverse deployment scenarios (e.g. central or distributed user plane function) without affecting the overall functionality provided by these EPC entities.

2.2.2.100 TS 23.216

Single Radio Voice Call Continuity (SRVCC)

This technical specification specifies the architecture enhancements for Single Radio Voice Call Continuity (SRVCC) between E-UTRAN access and 3GPP2's 1xCS, and between E-UTRAN access and 3GPP's UTRAN/GERAN accesses and between UTRAN (HSPA) access and 3GPP's UTRAN/GERAN accesses, for Circuit Switched (CS) calls that are anchored in the IMS.

2.2.2.101 TS 23.218

IP Multimedia (IM) session handling; IM call model; Stage 2

This document specifies the IP multimedia (IM) Call Model for handling of an IP multimedia session origination and termination for an IP Multimedia subscriber. This document includes interactions between an application server and IP multimedia sessions.

2.2.2.102 TS 23.228

IP Multimedia Subsystem; Stage 2

This document describes the architectural requirement for an IP multimedia components incorporated in an UMTS system as well as second generation systems for GSM inside the core network and identify relevant interfaces to the existing system and the new one in between the new components incorporated.

2.2.2.103 TS 23.231

SIP-I based circuit-switched core network; Stage 2

This document defines the stage 2 description for the SIP-I based CS core network. This stage 2 shall cover the information flows between the GMSC server, MSC server and media gateways that are required to support a SIP-I based Nc interface. This document shall show the CS core network termination of the Iu and A interfaces in order to cover the information flow stimulus to the core network and describe the interaction with the supplementary and value added services and capabilities.

2.2.2.104 TS 23.234

3GPP system to Wireless Local Area Network (WLAN) interworking; System description

This document specifies system description for interworking between 3GPP systems and Wireless Local Area Networks (WLANs), which extends 3GPP services and functionality to the WLAN access environment. It is not limited to WLAN technologies, but also valid for other IP based Access Networks that support the same capabilities towards the interworking system as WLAN does.

2.2.2.105 TS 23.237**IP Multimedia Subsystem (IMS) Service Continuity; Stage 2**

This document specifies the architectural requirements and procedures for delivery of IMS Service Continuity.

2.2.2.106 TS 23.246**Multimedia Broadcast/Multicast Service (MBMS); Architecture and functional description**

This document describes the stage 2 description (architectural solution and functionalities) for the MBMS Bearer Service, which includes, together with MBMS User Services defined in TS 26.346, all the elements necessary to realise the stage 1 requirements in TS 22.146 and TS 22.246. This document encompasses both GPRS and EPS.

This document also includes considerations on the manner in which User Services should make use of the MBMS Bearer Service described herein. It should be noted that the specification of MBMS User Services in TS 26.346 takes precedence over User Service aspects described in this document.

This document includes information applicable to network operators, service providers and manufacturers.

2.2.2.107 TS 23.259**Personal Network Management (PNM); Procedures and information flows; Stage 2**

This document provides the procedure details and the information flows for support of Personal Network Management including the PN UE redirection and PN access control applications enabled by Personal Network Management (PNM).

2.2.2.108 TS 23.261**IP flow mobility and seamless Wireless Local Area Network (WLAN) offload; Stage 2**

This document specifies the Stage 2 system description for IP flow mobility between a 3GPP and a WLAN. The technical solution is based on the working principles of DSMIPv6 and it is applicable to both the Evolved Packet System and the I-WLAN mobility architecture. The specification covers the system description of seamless WLAN offload and IP flow mobility between 3GPP and WLAN as well as the respective interactions with the PCC and ANDSF frameworks. The system description for non-seamless WLAN offload is covered in 3GPP TS 23.402. This document specifies also the detailed extensions to S2c and H1 reference points for IP flow mobility. The extensions to the PCC and to the ANDSF framework are specified respectively in 3GPP TS 23.203 and in 3GPP TS 23.402.

2.2.2.109 TS 23.271**Functional stage 2 description of Location Services (LCS)**

This document specifies the stage 2 of the Location Services (LCS) feature in UMTS, GSM and EPS (for E-UTRAN), which provides the mechanisms to support mobile location services for operators, subscribers and third party service providers.

2.2.2.110 TS 23.272**Circuit Switched Fallback in Evolved Packet System**

This technical specification specifies the architecture enhancements for functionality to enable fallback from E-UTRAN access to UTRAN/GERAN CS domain access and to CDMA 1x RTT CS domain access, and functionality to reuse of voice and other CS-domain services (e.g. CS UDI video/SMS/LCS/USSD) by reuse of CS infrastructure.

2.2.2.111 TS 23.278**Customized Applications for Mobile network Enhanced Logic (CAMEL) Phase 4; Stage 2; IM CN Interworking**

This document specifies the stage 2 description for the Customized Applications for Mobile network Enhanced Logic (CAMEL) feature that provides the mechanisms to support services for the IP Multimedia Core Network (IM CN) Subsystem.

2.2.2.112 TS 23.279**Combining Circuit Switched (CS) and IP Multimedia Subsystem (IMS) services; Stage 2**

This document provides architectural details to combine CS services and IMS services for using them in parallel between the same two users in a peer-to-peer context. This document provides a detailed description of how capabilities and identities are exchanged to enable the combination of CS and IMS services between the same two UEs.

2.2.2.113 TS 23.280**Common functional architecture to support mission critical services; Stage 2**

This document specifies the common functional architecture, procedures and information flows needed to support mission critical services including the common services core architecture.

The corresponding service requirements are defined in 3GPP TS 22.179, 3GPP TS 22.280, 3GPP TS 22.281 and 3GPP TS 22.282.

This document is applicable primarily to mission critical services using E-UTRAN access based on the EPC architecture defined in 3GPP TS 23.401. Certain MC service functions such as dispatch and administrative functions could also be supported via non-3GPP access networks but no additional functionality is specified to support non-3GPP access.

The common functional architecture to support mission critical services can be used for public safety applications and also for general commercial applications e.g. utility companies and railways.

2.2.2.114 TS 23.281**Functional architecture and information flows to support Mission Critical Video (MCVideo); Stage 2**

This document specifies the functional model, procedures and information flows needed for the mission critical video (MCVideo) service. Support for both MCVideo group streaming and MCVideo private streaming operating in on-network and off-network modes of operation is specified.

The corresponding service requirements are defined in 3GPP TS 22.280, and 3GPP TS 22.281.

This document is applicable primarily to mission critical video service using E-UTRAN access based on the common functional architecture for mission critical services defined in 3GPP TS 23.280 and the EPC architecture defined in 3GPP TS 23.401.

The MCVideo service can be used for public safety applications and also for general commercial applications e.g. utility companies and railways.

2.2.2.115 TS 23.282**Functional architecture and information flows to support Mission Critical Data (MCData); Stage 2**

This document specifies the functional architecture, procedures and information flows needed to support the Mission Critical Data (MCData) services. MCData is a suite of services which utilizes

the common functional architecture defined in 3GPP TS 23.280 to support MC services over LTE including the common services core.

MCDATA services suite consists of the following sub-services:

- short data service (SDS);
- file distribution (FD).

MCDATA features include:

- conversation management;
- transmission and reception control;
- communication release; and
- enhanced status.

The corresponding service requirements are defined in 3GPP TS 22.282 and 3GPP TS 22.280.

This document is applicable primarily to MCDATA service using E-UTRAN access based on the EPC architecture defined in 3GPP TS 23.401. Certain application functions of the MCDATA service could also be supported via non-3GPP access networks but no additional functionality is specified to support non-3GPP access.

The MCDATA service can be used for public safety applications and also for general commercial applications e.g. utility companies and railways.

2.2.2.116 TS 23.285

Architecture enhancements for V2X services

This document specifies architecture enhancements to facilitate vehicular communications for Vehicle-to-Everything (V2X) services, which includes Vehicle-to-Vehicle (V2V), Vehicle-to-Pedestrian (V2P), Vehicle-to-Infrastructure (V2I), and Vehicle-to-Network (V2N), according to the use cases and service requirements defined in TS 22.185.

The following vehicular communications for V2X services are specified:

- V2X communication over PC5 reference point.
- V2X communication over LTE-Uu reference point.

2.2.2.117 TS 23.292

IP Multimedia Subsystem (IMS) centralized services; Stage 2

This document specifies the architectural requirements for delivery of consistent services to the user regardless of the attached access type (e.g. CS domain access, or IP-CAN). This is achieved by implementing the services in the IP Multimedia Subsystem (IMS).

2.2.2.118 TS 23.303

Proximity-based services (ProSe); Stage 2

This document specifies the Stage 2 of the Proximity Services (ProSe) features in EPS. ProSe features consist of: ProSe discovery (direct or EPC-level) and ProSe Direct Communication (using E-UTRAN or WLAN direct).

ProSe discovery identifies that ProSe-enabled UEs are in proximity, using E-UTRAN (with or without E-UTRAN) or EPC.

ProSe Direct Communication enables establishment of communication paths between two or more ProSe-enabled UEs that are in direct communication range. The ProSe Direct Communication path could use E-UTRAN or WLAN.

For Public Safety specific usage:

- Public Safety ProSe-enabled UEs can establish the communication path directly between two or more Public Safety ProSe-enabled UEs, regardless of whether the Public Safety ProSe-enabled UE is served by E-UTRAN.
- ProSe Direct Communication is also facilitated by the use of a ProSe UE-to-Network Relay, which acts as a relay between E-UTRAN and UEs not served by E-UTRAN.

Security aspects of ProSe are defined in TS 33.303.

In this Release of the specification, there is no support for ProSe UE-to-Network Relays.

2.2.2.119 TS 23.327

Mobility between 3GPP-Wireless Local Area Network (WLAN) interworking and 3GPP systems

This document specifies the stage 2 system description for providing mobility between 3GPP Wireless Local Area Network Interworking (I WLAN) and 3GPP Systems. It is to define a technical solution based on the working principles of DSMIPv6 with necessary enhancement of the I WLAN architecture for supporting mobility and roaming between 3GPP WLAN Interworking system and 3GPP Systems so that ongoing 3GPP PS based services can be maintained with minimal impact on the end user's perceived quality on the services at a change of the access network (between I WLAN and 3GPP Access Systems).

2.2.2.120 TS 23.333

Multimedia Resource Function Controller (MRFC) – Multimedia Resource Function Processor (MRFP) Mp interface; Procedures descriptions

This specification describes the functional requirements and information flows that generate procedures between the Multimedia Resource Function Controller (MRFC) and the Multimedia Resource Function Processor (MRFP), limited to information flows relevant to the Mp Interface.

2.2.2.121 TS 23.334

IP Multimedia Subsystem (IMS) Application Level Gateway (IMS-ALG) – IMS Access Gateway (IMS-AGW) interface: Procedures descriptions

Annex G of 3GPP TS 23.228 gives out an IMS Application Level Gateway (IMS-ALG) and IMS Access Media Gateway (IMS-AGW) based reference model to support NAPT-PT, gate control and traffic policing between IP-CAN and IMS domain.

2.2.2.122 TS 23.335

User Data Convergence (UDC); Technical realization and information flows; Stage 2

This document describes the procedures and signalling flows associated to the technical realization of the 3GPP User Data Convergence (UDC). It furthermore indicates some requirements for the stage 3 specifications. Special consideration is put in the following areas:

- reference architecture for the UDC concept;
- general description of procedures for the user data manipulation (e.g. create, delete, update, etc.);

- identification of the requirements on the UDC for the applicability of the mechanisms described in this document.

User data convergence is an optional concept to ensure data consistency and simplify creation of new services by providing easy access to the user data, as well as to ensure the consistency of storage and data models and to have minimum impact on traffic mechanisms, reference points and protocols of network elements.

2.2.2.123 TS 23.379

Functional architecture and information flows to support Mission Critical Push To Talk (MCPTT); Stage 2

This document specifies the functional architecture, procedures and information flows needed to support the mission critical push to talk (MCPTT) service. The MCPTT service utilizes the common functional architecture to support MC services over LTE including the common services core defined in 3GPP TS 23.280. Support for both MCPTT group calls and MCPTT private calls operating in on-network and off-network modes of operation is specified.

The corresponding service requirements are defined in 3GPP TS 22.179 and 3GPP TS 22.280.

This document is applicable primarily to MCPTT voice service using E-UTRAN access based on the EPC architecture defined in 3GPP TS 23.401. Certain application functions of the MCPTT service such as dispatch and administrative functions could also be supported via non-3GPP access networks but no additional functionality is specified to support non-3GPP access.

The MCPTT service requires preferential handling compared to normal telecommunication services e.g. in support of police or fire brigade including the handling of prioritised MCPTT calls for emergency and imminent threats.

The MCPTT service can be used for public safety applications and also for general commercial applications e.g. utility companies and railways.

In this document, MCPTT calls between MCPTT users on different MCPTT systems are considered.

2.2.2.124 TS 23.380

IMS Restoration procedures

This document specifies the procedures required in 3GPP IMS to handle an S-CSCF service interruption scenario with minimum impact to the service to the end user.

2.2.2.125 TS 23.401

GPRS enhancements for E-UTRAN access

This technical specification defines the stage 2 service description for the Evolved 3GPP Packet Switched Domain – also called the Evolved Packet System (EPS) in this document. The Evolved 3GPP Packet Switched Domain provides IP connectivity using the Evolved Universal Terrestrial Radio Access Network (E-UTRAN). The specification also covers mobility between E-UTRAN and pre-E-UTRAN 3GPP radio access technologies.

2.2.2.126 TS 23.402

Architecture enhancements for non-3GPP accesses

This technical specification defines the stage 2 service description for providing IP connectivity using non-3GPP accesses to the Evolved 3GPP Packet Switched domain. In addition, for E-UTRAN and non-3GPP accesses, the specification describes the Evolved 3GPP PS Domain where the protocols between its Core Network elements are IETF based.

2.2.2.127 TS 23.468**Group Communication System Enablers for LTE (GCSE_LTE); Stage 2**

This document provides the stage 2 description for the 3GPP system provided enablers to support group communication services using EUTRAN access. The corresponding stage 1 requirements are defined in TS 22.468.

The group communication system is represented by an Application Server (GCS AS) using the 3GPP system provided enablers for transferring its application signalling and for delivering application data, e.g. media data, to a group of UEs either (i) over MBMS Bearer Services using the Broadcast Mode of MBMS (TS 23.246); or (ii) over EPS Bearers; or (iii) over both MBMS and EPS bearer services.

The specification covers both roaming and non-roaming scenarios and includes support for service continuity, i.e. support for continuous reception of application data when a UE changes between reception of application data via EPS and MBMS Bearer Services.

Application level interactions between the UE and the GCS Application Server are out of scope of this specification.

2.2.2.128 TS 23.682**Architecture enhancements to facilitate communications with packet data networks and applications**

This document specifies architecture enhancements to facilitate communications with packet data networks and applications (e.g. Machine Type Communication (MTC) applications on the (external) network/MTC servers) as per the use cases and service requirements defined in TS 22.368, TS 22.101, and related 3GPP requirements specifications. Both roaming and non-roaming scenarios are covered.

In this release, this document specifies the network elements, interfaces and procedures for:

- Device triggering by applications/servers (e.g. MTC applications on the (external) network/MTC servers).
- PS-Only support with and without MSISDN.

2.2.2.129 TS 24.002**GSM – UMTS Public Land Mobile Network (PLMN) access reference configuration**

This document describes the reference configuration for access to a PLMN.

2.2.2.130 TS 24.007**Mobile radio interface signalling layer 3; General aspects**

This specification describes the principal architecture of Layer 3 and its sub-layers on the GSM Um interface, i.e. the interface between mobile station (MS) and network; for the CM sub-layer, the description is restricted to paradigmatic examples, CC, supplementary services, and short message services for non-general packet radio service (GPRS) services. It also defines the basic message format and error handling applied by the Layer 3 protocols.

2.2.2.131 TS 24.008**Mobile radio interface Layer 3 specification; Core network protocols; Stage 3**

This specification describes the procedures used at the radio interface for call control, mobility management and session management. The procedures currently described are for the CC of

circuit-switched connections, SM for GPRS services, MM and radio resource management for circuit-switched and GPRS services. MBMS is also added.

2.2.2.132 TS 24.010

Mobile radio interface Layer 3; Supplementary services specification; General aspects

This specification describes the general aspects of the specification of supplementary services at the Layer 3 radio interface. Details are specified in other TSs.

2.2.2.133 TS 24.011

Point-to-Point (PP) Short Message Service (SMS) support on mobile radio interface

This specification describes the procedures used across the mobile radio interface by the signalling Layer 3 function short message control (SMC) and short message relay (SM-RL) function for both circuit-switched GSM and GPRS.

2.2.2.134 TS 24.022

Radio Link Protocol (RLP) for circuit switched bearer and teleservices

This specification describes the RLP for data transmission over the UMTS public land mobile network (PLMN). RLP covers the Layer 2 functionality of the ISO OSI reference model (IS 7498). It is based on ideas contained in IS 3309, IS 4335 and IS 7809 (HDLC of ISO) as well as ITU-T Recommendations X.25, Q.921 and Q.922 (LAP-B and LAP-D, respectively). RLP has been tailored to the special needs of digital radio transmission. RLP provides to its users the OSI data link service (IS 8886).

2.2.2.135 TS 24.030

Location Services (LCS); Supplementary service operations; Stage 3

This document gives the stage 3 description of the Location Service (LCS) operations for mobile station. These operations shall apply to both CS and PS domain.

The group of location services operations is divided into two different classes:

- Network initiated location services operations;
- Mobile initiated location services operations.

2.2.2.136 TS 24.080

Mobile radio interface Layer 3 supplementary services specification; Formats and coding

This specification describes the coding of information necessary for support of supplementary service operation on the mobile radio interface L3. Details are specified in other TSs.

2.2.2.137 TS 24.081

Line identification supplementary services; Stage 3

This document specifies the procedures used at the radio interface for normal operation, registration, erasure, activation, deactivation, invocation and interrogation of line identification supplementary services. Provision and withdrawal of supplementary services is an administrative matter between the mobile subscriber and the service provider and cause no signalling on the radio interface.

2.2.2.138 TS 24.082**Call Forwarding (CF) supplementary services; Stage 3**

This TS specifies the procedures used at the radio interface for: normal operation, registration, erasure, activation, deactivation, interrogation, and network invocation of the call offering supplementary services within the 3GPP system.

2.2.2.139 TS 24.083**Call Waiting (CW) and Call Hold (HOLD) supplementary services; Stage 3**

This document specifies the procedures used at the radio interface (Reference point Um as defined in 3GPP TS 24.002) for normal operation, registration, erasure, activation, deactivation, invocation and interrogation of call completion supplementary services. Provision and withdrawal of supplementary services is an administrative matter between the mobile subscriber and the service provider and cause no signalling on the radio interface.

2.2.2.140 TS 24.084**MultiParty (MPTY) supplementary service; Stage 3**

This document specifies the procedures used at the radio interface (Reference point Um as defined in 3GPP TS 24.002) for normal operation and invocation of MultiParty supplementary services.

2.2.2.141 TS 24.085**Closed User Group (CUG) supplementary service; Stage 3**

This technical specification (TS) for mobile communications specifies the procedures used at the radio interface (reference point Um as defined in 3GPP TS 24.002) for normal operation, registration, erasure, activation, deactivation, invocation and interrogation of community of interest supplementary services. The provision and withdrawal of supplementary services is an administrative matter between the mobile subscriber and the service provider and causes no signalling on the radio interface.

2.2.2.142 TS 24.086**Advice of Charge (AoC) supplementary services; Stage 3**

This document specifies the procedures used at the radio interface (reference point Um as defined in 3GPP TS 24.002) for normal operation, registration, erasure, activation, deactivation, invocation and interrogation of charging supplementary services. The provision and withdrawal of supplementary services is an administrative matter between the mobile subscriber and the service provider and causes no signalling on the radio interface.

2.2.2.143 TS 24.087**User-to-User Signalling (UUS); Stage 3**

This technical specification gives the stage 3 description of the User-to-User signalling supplementary services.

2.2.2.144 TS 24.088**Call Barring (CB) supplementary service; Stage 3**

This technical specification (TS) specifies the procedures used at the radio interface (reference point Um as defined in 3GPP TS 24.002) for normal operation, registration, erasure, activation, deactivation, invocation and interrogation of call barring supplementary services. Provision and

withdrawal of supplementary services is an administrative matter between the mobile subscriber and the service provider and cause no signalling on the radio interface.

2.2.2.145 TS 24.090

Unstructured Supplementary Service Data (USSD); Stage 3

This document gives the stage 3 description of the Unstructured Supplementary Service Data (USSD) operations.

2.2.2.146 TS 24.091

Explicit Call Transfer (ECT) supplementary service; Stage 3

This document gives the stage 3 description of the call transfer supplementary services. This document specifies the procedures used at the radio interface (Reference point Um as defined in 3GPP TS 24.002) for normal operation, registration, erasure, activation, deactivation, invocation and interrogation of call transfer supplementary services. Provision and withdrawal of supplementary services is an administrative matter between the mobile subscriber and the service provider and cause no signalling on the radio interface. In 3GPP TS 24.010 the general aspects of the specification of supplementary services at the layer 3 radio interface are given.

2.2.2.147 TS 24.093

Call Completion to Busy Subscriber (CCBS); Stage 3

This document gives the stage 3 description of the Completion of Calls to Busy Subscriber (CCBS) supplementary service. This document specifies the procedures used at the radio interface (Reference point Um as defined in 3GPP TS 24.002) for normal operation, activation, deactivation, invocation and interrogation of the completion of calls to busy subscriber supplementary services. Provision and withdrawal of supplementary services is an administrative matter between the mobile subscriber and the service provider and cause no signalling on the radio interface.

2.2.2.148 TS 24.096

Name identification supplementary services; Stage 3

This technical specification (TS) specifies the procedures used at the radio interface for normal operation, registration, erasure, activation, deactivation, invocation and interrogation of name identification supplementary services. Provision and withdrawal of supplementary services is an administrative matter between the mobile subscriber and the service provider and cause no signalling on the radio interface. In 3GPP TS 24.010 the general aspects of the specification of supplementary services at the layer 3 radio interface are given. 3GPP TS 24.080 specifies the formats and coding for the supplementary services.

2.2.2.149 TS 24.103

Telepresence using the IP Multimedia (IM) Core Network (CN) Subsystem (IMS); Stage 3

This document provides the protocol details for telepresence using the IP Multimedia (IM) Core Network (CN) subsystem based on the Session Initiation Protocol (SIP), the Session Description Protocol (SDP), the Binary Floor Control Protocol (BFCP) and the ControLling mUltiple streams for tElepresence (CLUE) controlling multiple streams for telepresence based on service requirements.

This document addresses the areas of describing and negotiating IM session with multiple media streams based on the IM CN subsystem, including point to point calls as specified in 3GPP TS 24.229 and multiparty conferences as specified in 3GPP TS 24.147, to facilitate the support of telepresence.

The functionalities for conference policy control and the signalling between a MRFC and a MRFP are not specified in this document.

Where possible, this document specifies the requirements for this protocol by reference to specifications produced by the IETF within the scope of SIP, SDP, CLUE and BFCP, either directly, or as modified by 3GPP TS 24.229.

This document is applicable to Application Servers (ASs), Multimedia Resource Function Controllers (MRFCs), Multimedia Resource Function Processors (MRFP) and User Equipment (UE) providing IM session supporting telepresence capabilities.

2.2.2.150 TS 24.105

Application specific Congestion control for Data Communication (ACDC) Management Object (MO)

This document defines Management Object (MO) that is used to configure the UE with parameters related to Application specific Congestion control for Data Communication (ACDC) functionality.

The MO is compatible with the OMA Device Management (DM) protocol specifications, version 1.2 and upwards, and is defined using the OMA DM Device Description Framework (DDF) as described in the Enabler Release Definition OMA-ERELD-DM-V1_2.

The MO consists of relevant parameters for provisioning of ACDC at a UE.

2.2.2.151 TS 24.109

Bootstrapping interface (Ub) and network application function interface (Ua); Protocol details

This document defines stage 3 for the HTTP Digest AKA based implementation of Ub interface (UE-BSF), the Disposable-Ks model based implementation of Upa interface (NAF-UE) and the HTTP Digest and the PSK TLS based implementation of bootstrapped security association usage over Ua interface (UE-NAF) in Generic Authentication Architecture (GAA) as specified in 3GPP TS 33.220. The purpose of the Ub interface is to create a security association between UE and BSF for further usage in GAA applications. The purpose of the Upa interface is to provide a push mechanism to create a bootstrapped security association between the UE and NAF for secure communication of pushed messages. The purpose of the Ua interface is to use the so created bootstrapped security association between UE and NAF for secure communication.

This document also defines stage 3 for the Authentication Proxy usage as specified in 3GPP TS 33.222.

This document also defines stage 3 for the subscriber certificate enrolment as specified in 3GPP TS 33.221 which is one realization of the Ua interface. The subscriber certificate enrolment uses the HTTP Digest based implementation of bootstrapped security association usage to enrol a subscriber certificate and the delivery of a CA certificate.

2.2.2.152 TS 24.116

Stage 3 aspects of system architecture enhancements for TV services

This document defines the stage 3 aspects of the architecture enhancements for broadcast TV service (see 3GPP TS 23.246).

This document specifies:

- the requirements on the device in Receive only mode;
- the procedure for selecting a network to receive broadcast TV service; and
- the usage of the information configured in the TV service configuration.

The clause 4 applies to a device in Receive only mode only. The remaining clauses are applicable to:

- a 3GPP UE wishing to receive broadcast TV service; and
- a device in Receive only mode.

2.2.2.153 TS 24.117

TV service configuration Management Object (MO)

This document defines a Management Object (MO) that can be used to configure the parameters related to TV service provided via a PLMN.

The MO is compatible with the OMA Device Management (DM) protocol specifications, version 1.2 and upwards, and is defined using the OMA DM Device Description Framework (DDF) as described in the Enabler Release Definition OMA-ERELD-DM-V1_2.

The MO consists of nodes and leaves conveying configuration parameters used for selecting and receiving TV service from a PLMN, according to the procedures described in 3GPP TS 23.246 and 3GPP TS 24.116.

2.2.2.154 TS 24.135

Multicall supplementary service; Stage 3

This document gives the stage 3 description of the Multicall (MC) supplementary service. This document specifies the procedures used by the radio interface for normal operation, registration and interrogation of the Multicall supplementary service. Provision, withdrawal, erasure, activation and deactivation of supplementary services is an administrative matter between the mobile subscriber and the service provider and causes no signalling on the radio interface.

3GPP TS 24.010 describes the general aspects of the specification of supplementary services at the layer 3 radio interface.

3GPP TS 24.080 specifies the formats and coding for the supplementary services.

Definitions and descriptions of supplementary services are given in 3GPP TS 22.004, 3GPP TS 22.072, 3GPP TS 22.08x, 3GPP TS 22.09x-series and 3GPP TS 22.135. 3GPP TS 22.135 is related specifically to the Multicall supplementary service.

The technical realisation of supplementary services are described in 3GPP TS 23.011, 3GPP TS 23.072, 3GPP TS 23.08x, 23.09x-series and 3GPP TS 23.135. 3GPP TS 23.135 is related specifically to the Multicall supplementary service.

The procedures for Call Control and Mobility Management at the layer 3 radio interface are defined in 3GPP TS 24.007 and 3GPP TS 24.008.

The following supplementary services are described in this document:

- Multicall (MC).

2.2.2.155 TS 24.139

3GPP system – fixed broadband access network interworking; Stage 3

This document specifies the UE – EPC procedures for accessing 3GPP Evolved Packet Core (EPC) via a Fixed Broadband Access network. The specification covers the Support of QoS, Tunnel management procedures including the support of NAT traversal, and non-seamless offloading impacts. The document is applicable to the UE and the network (i.e. the 3GPP EPC).

2.2.2.156 TS 24.141**Presence service using the IP Multimedia (IM) Core Network (CN) subsystem; Stage 3**

This specification provides the protocol details for the presence service within the IP Multimedia (IM) Core Network (CN) subsystem based on the Session Initiation Protocol (SIP) and SIP Events as defined in 3GPP TS 24.229.

2.2.2.157 TS 24.147**Conferencing using the IP Multimedia (IM) Core Network (CN) subsystem; Stage 3**

This specification provides the protocol details for conferencing within the IP Multimedia Core Network subsystem (IMS) based on the Session Initiation Protocol (SIP), SIP Events, the Session Description Protocol (SDP) and the Binary Floor Control Protocol (BFCP).

2.2.2.158 TS 24.161**Network-Based IP Flow Mobility (NBIFOM); Stage 3**

This document specifies the procedures of network-based IP flow mobility (NBIFOM). NBIFOM is based on network mobility protocols (i.e. GTP or PMIP) which is performed between 3GPP access and WLAN access network as specified in 3GPP TS 23.161.

2.2.2.159 TS 24.166**3GPP IP Multimedia Subsystem (IMS) conferencing Management Object (MO)**

This document defines the IMS conferencing management object. The management object is compatible with OMA Device Management protocol specifications, version 1.2 and upwards, and is defined using the OMA DM Device Description Framework as described in the Enabler Release Definition OMA-ERELED_DM-V1_2.

2.2.2.160 TS 24.167**3GPP IMS Management Object (MO); Stage 3**

This document defines a mobile device 3GPP IMS Management Object. The management object is compatible with OMA Device Management protocol specifications, version 1.2 and upwards, and is defined using the OMA DM Device Description Framework as described in the Enabler Release Definition OMA-ERELED_DM-V1_2.

2.2.2.161 TS 24.171**Control Plane Location Services (LCS) procedures in the Evolved Packet System (EPS)**

This document specifies the operations and information coding for the Non-access Stratum (NAS) layer protocol for supporting the Location Services (LCS) in the Evolved Universal Terrestrial Radio Access Network (E-UTRAN).

2.2.2.162 TS 24.173**IMS multimedia telephony communication service and supplementary services; Stage 3**

This specification provides the protocol details for multimedia telephony communication service and associated supplementary services in the IP Multimedia (IM) Core Network (CN) subsystem based on the requirements from 3GPP TS 22.173. Multimedia telephony and supplementary services allow users to establish communications between them and enrich that by enabling supplementary services.

2.2.2.163 TS 24.182**IP Multimedia Subsystem (IMS) Customized Alerting Tones (CAT); Protocol specification**

This document provides the protocol details for the Customized Alerting Tones (CAT) service in the IP Multimedia (IM) Core Network (CN) subsystem based on the requirements from 3GPP TS 22.182. The CAT service is an operator specific service by which an operator enables the subscriber to customize the media which is played to the calling party during alerting of the called party. This document is applicable to User Equipment (UE) and Application Servers (AS) which are intended to support the CAT service.

2.2.2.164 TS 24.183**IP Multimedia Subsystem (IMS) Customized Ringing Signal (CRS); Protocol specification**

The specification provides the protocol details for the Customized Ringing Signal (CRS) service in the IP Multimedia (IM) Core Network (CN) subsystem based on the requirements from 3GPP TS 22.183. The CRS service is an operator specific service by which an operator enables the subscriber to customize the media which is played to the called party as an incoming communication indication during establishment of a communication. This document is applicable to User Equipment (UE) and Application Servers (AS) which are intended to support the CRS service.

2.2.2.165 TS 24.216**Communication Continuity Management Object (MO)**

The Communication Continuity Management Object consists of relevant parameters that can be managed for Communication Continuity capabilities.

2.2.2.166 TS 24.229**IP multimedia call control protocol based on Session Initiation Protocol (SIP) and Session Description Protocol (SDP); Stage 3**

This specification defines a call control protocol for use in the IP Multimedia (IM) Core Network (CN) subsystem based on the Session Initiation Protocol (SIP), and the associated Session Description Protocol (SDP).

2.2.2.167 TS 24.234**3GPP system to Wireless Local Area Network (WLAN) interworking; WLAN User Equipment (WLAN UE) to network protocols; Stage 3**

The document specifies the network selection, including authentication and access authorization using authentication, authorization and accounting (AAA) procedures used for the interworking of the 3GPP system and WLANs. In addition, it also specifies the tunnel management procedures used for establishing an end-to-end tunnel from the WLAN UE to the 3GPP network via the Wu reference point. The document is applicable to the WLAN user equipment (UE) and the network. In this technical specification, the network includes the WLAN and 3GPP network.

Furthermore, the document specifies procedures within I-WLAN necessary in order for IMS emergency calls to be supported when I-WLAN is used as the underlying access network. These involve both network selection as well as tunnel management procedures.

2.2.2.168 TS 24.235**3GPP System to Wireless Local Area Network (WLAN) interworking Management Object (MO)**

This document defines the 3GPP System to Wireless Local Area Network interworking Management Object (MO) for I-WLAN PLMN selection as specified in 3GPP TS 24.234. The 3GPP System to Wireless Local Area Network interworking Management Object consists of relevant parameters that can be managed for WLAN UE as specified in 3GPP TS 24.234.

2.2.2.169 TS 24.237**IP Multimedia (IM) Core Network (CN) subsystem IP Multimedia Subsystem (IMS) service continuity; Stage 3**

This specification provides the capability of continuing ongoing communication sessions with multiple media across different access networks. This document provides the protocol details for enabling IMS SC based on the Session Initiation protocol (SIP) and the Session Description Protocol (SDP) and the protocols of the 3GPP Circuit-Switched (CS) domain (e.g. CAP, MAP, ISUP, BICC and the NAS call control protocol for the CS access).

2.2.2.170 TS 24.238**Session Initiation Protocol (SIP) based user configuration; Stage 3**

This document provides a Session Initiation Protocol (SIP) based protocol framework that serves as a means of user configuration of supplementary services in the IP Multimedia (IM) Core Network (CN) subsystem. The protocol framework relies upon the contents of the Request-URI in a SIP INVITE request to enable basic configuration of services without requiring use of the Ut interface. This document is applicable to User Equipment (UE) and Application Servers (AS) that are intended to support user configuration of supplementary services.

2.2.2.171 TS 24.239**Flexible Alerting (FA) using IP Multimedia (IM) Core Network (CN) subsystem; Protocol specification**

This document provides the protocol details for the Flexible Alerting supplementary service in the IP Multimedia (IM) Core Network (CN) subsystem. Flexible Alerting (FA) causes a call to a pilot identity to branch the call into several legs to alert several termination addresses (group members) simultaneously. The first leg to be answered is connected to the calling party.

The other call legs are abandoned. The document is applicable to User Equipment (UE) and Application Servers (AS) which are intended to support the FA supplementary service.

2.2.2.172 TS 24.244**Wireless LAN control plane protocol for trusted WLAN access to EPC; Stage 3**

This document specifies the procedures of the Wireless LAN control plane protocol (WLCP) for trusted WLAN access to EPC which is used between User Equipment (UE) and Trusted WLAN Access Gateway (TWAG) for multi-connection mode as specified in 3GPP TS 23.402.

This document also defines the message format, information elements coding, error handling and system parameters applied by the WLCP protocol.

2.2.2.173 TS 24.247**Messaging service using the IP Multimedia (IM) Core Network (CN) subsystem; Stage 3**

This specification provides the protocol details for the messaging service within the IP Multimedia CN Subsystem (IMS) based on the Session Initiation Protocol (SIP), the Session Description Protocol (SDP) and, the Message Session Relay Protocol (MSRP).

2.2.2.174 TS 24.250**Protocol for Reliable Data Service between UE and SCEF; Stage 3**

This document specifies a Reliable Data Service (RDS) protocol between the UE and Service Capability Exposure Function (SCEF).

This document defines the frame structure, format of fields and procedures for operation of the RDS protocol. RDS is mainly intended to be used for acknowledged data transfer, but it also supports unacknowledged data transfer.

This document is applicable to the UE and to the SCEF in the Evolved Packet System (EPS).

2.2.2.175 TS 24.259**Personal Network Management (PNM); Stage 3**

This specification provides the protocol details for enabling Personal Network management services in the IP Multimedia Core Network subsystem based on the protocols of SIP and the SDP. This document is applicable to UEs and AS providing PNM capabilities.

2.2.2.176 TS 24.275**Management Object (MO) for Basic Communication Part (BCP) of IMS Multimedia Telephony (MMTEL) communication service**

This document defines the management object (MO) for Basic Communication Part (BCP) of IMS Multimedia Telephony (MMTEL) communication service.

The MO for BCP of MMTEL communication service is compatible with OMA device management protocol specifications, version 1.2 and upwards, and is defined using the OMA DM device description framework as described in the enabler release definition OMA-ERELD_DM-V1_2.

The MO for BCP of MMTEL communication service consists of relevant configuration parameter that can be managed for a UE supporting the timer RequestTimeout specified in 3GPP TS 24.173.

2.2.2.177 TS 24.279**Combining Circuit Switched (CS) and IP Multimedia Subsystem (IMS) services; Stage 3**

This specification provides the technical realization for the combination of Circuit Switched calls and IM sessions when using them simultaneously between the same two users. It also describes the use of CS and IM services in combination, using the existing procedures that have been defined for CS and IMS. It includes the necessary function as adding an IM session to an ongoing CS call, adding a CS call to an ongoing IM session, supplementary services as they relate to CSICS and supporting capability exchange.

2.2.2.178 TS 24.281**Mission Critical Video (MCVideo) signalling control; Protocol specification**

This document specifies the signalling control needed to support Mission Critical Video (MCVideo) service.

The MCVideo service and its associated media plane control protocols can be used for public safety applications and also for general commercial applications (e.g. utility companies and railways).

This document is applicable to User Equipment (UE) supporting MCVideo client, and MCVideo server.

2.2.2.179 TS 24.282

Mission Critical Data (MCData) signalling control; Protocol specification

This document specifies the signalling control protocols needed to support Mission Critical Data (MCData) communications as specified by 3GPP TS 23.282. This document specifies both on-network and off-network protocols.

This document utilises the common functional architecture to support mission critical services as specified in 3GPP TS 23.280, in support of MCData communications.

The MCData service can be used for public safety applications and also for general commercial applications e.g. utility companies and railways.

This document is applicable to User Equipment (UE) supporting the MCData client functionality, and to application servers supporting the MCData server functionality.

2.2.2.180 TS 24.285

Allowed Closed Subscriber Group (CSG) list; Management Object (MO)

The Allowed CSG List MO consists of relevant parameters for that can be used by the UE to select the appropriate CSG cell based on its subscription. The Allowed CSG List MO defines the relevant parameters related to the Allowed CSG List and to the Operator CSG List.

2.2.2.181 TS 24.286

IP Multimedia (IM) Core Network (CN) subsystem Centralized Services (ICS); Management Object (MO)

This document defines the IMS Centralized Services Management Object (MO). The management object is compatible with OMA Device Management protocol specifications, version 1.2 and upwards, and is defined using the OMA DM Device Description Framework as described in the Enabler Release Definition OMA-ERELED_DM-V1_2.

2.2.2.182 TS 24.292

IP Multimedia (IM) Core Network (CN) subsystem Centralized Services (ICS); Stage 3

IP Multimedia (IM) Core Network (CN) subsystem centralized services (ICS) allow for the delivery of consistent IMS services to the user regardless of the attached access type (e.g. CS domain access or IP-CAN). This specification provides the protocol details for the realization of ICS based on the Session Initiation protocol (SIP), the Session Description Protocol (SDP) and the protocols of the 3GPP Circuit-Switched (CS) domain (e.g. CAP, MAP, ISUP, BICC and the NAS call control protocol for the CS access).

2.2.2.183 TS 24.294

IP Multimedia Subsystem (IMS) Centralized Services (ICS) protocol via I1 interface

This document describes the I1 interface between IMS Centralized Services (ICS) UE and Service Centralization and Continuity (SCC) Application Server (AS).

2.2.2.184 TS 24.301**Non-Access-Stratum (NAS) protocol for Evolved Packet System (EPS); Stage 3**

This specification specifies the procedures used by the protocols for mobility management and session management between User Equipment (UE) and Mobility Management Entity (MME) in the Evolved Packet System (EPS). These protocols belong to the non-access stratum (NAS). The EPS Mobility Management (EMM) protocol defined in this document provides procedures for the control of mobility when the User Equipment (UE) is using the Evolved UMTS Terrestrial Radio Access Network (E-UTRAN). The EMM protocol also provides control of security for the NAS protocols. The EPS Session Management (ESM) protocol defined in this document provides procedures for the handling of EPS bearer contexts. Together with the bearer control provided by the access stratum, this protocol is used for the control of user plane bearers. For both NAS protocols this document specifies procedures for the support of inter-system mobility between E-UTRAN and other 3GPP or non-3GPP access networks.

2.2.2.185 TS 24.302**Access to the 3GPP Evolved Packet Core (EPC) via non-3GPP access networks; Stage 3**

This document specifies the discovery and network selection procedures for access to 3GPP Evolved Packet Core (EPC) via non-3GPP access networks and includes Authentication and Access Authorization using Authentication, Authorization and Accounting (AAA) procedures used for the interworking of the 3GPP EPC and the non-3GPP access networks. This document also specifies the Tunnel management procedures used for establishing an end-to-end tunnel from the UE to the ePDG to the point of obtaining IP connectivity and includes the selection of the IP mobility mode.

2.2.2.186 TS 24.303**Mobility management based on Dual-Stack Mobile IPv6; Stage 3**

This document specifies the signalling procedures for accessing the 3GPP Evolved Packet Core network and handling the mobility between 3GPP and non-3GPP accesses via the S2c reference point defined in 3GPP TS 23.402. In addition this document specifies the procedures used for the DSMIPv6 Home Agent discovery, for bootstrapping the DSMIPv6 security association between the UE and the Home Agent and for managing the DSMIPv6 tunnel. DSMIPv6 procedures can be used independently of the underlying access technology.

2.2.2.187 TS 24.304**Mobility management based on Mobile IPv4; User Equipment (UE) – foreign agent interface; Stage 3**

This document describes the stage 3 aspects of mobility management for User Equipment (UE) using IETF Mobile IPv4 foreign agent mode to access the Evolved Packet Core Network (EPC) through trusted non-3GPP access networks and for mobility management of UE between the 3GPP access network and trusted non-3GPP access networks. In particular, this document describes the UE – Mobile IPv4 Foreign Agent (FA) interface stage 3 aspects, where the FA functionality is located within the access network in the non-3GPP access domain.

2.2.2.188 TS 24.305**Selective Disabling of 3GPP User Equipment Capabilities (SDoUE) Management Object (MO)**

This document specifies a mobile device Selective Disabling of 3GPP UE Capabilities (SDoUE) Management Object (MO) and the rules and corresponding behaviour of the UE with regard to the

selective disabling of 3GPP UE capabilities, for example, when services or functions are disabled/enabled.

The SDoUE MO consists of the relevant parameters that can be managed for selective disabling of 3GPP UE capabilities. The SDoUE MO defines a repository of data into the ME. The service requirements for selective disabling of 3GPP UE capabilities are defined in 3GPP TS 22.011.

2.2.2.189 TS 24.312

Access Network Discovery and Selection Function (ANDSF) Management Object (MO)

This document defines management objects that can be used by the Access Network Discovery and Selection Function (ANDSF) and the UE. The Management Object (MO) is compatible with the OMA Device Management (DM) protocol specifications, version 1.2 and upwards, and is defined using the OMA DM Device Description Framework (DDF) as described in the Enabler Release Definition OMA-ERELED-DM-V1_2.

2.2.2.190 TS 24.315

IP Multimedia Subsystem (IMS) Operator Determined Barring (ODB); Stage 3: protocol specification

This document specifies the stage 3, Protocol Description of the network feature Operator Determined Barring (ODB) of IMS Multimedia Telephony Services. It is based on the requirements described in 3GPP TS 22.041. It provides the protocol details in the IP Multimedia (IM) Core Network (CN) subsystem based on the Session Initiation Protocol (SIP) and the Session Description Protocol (SDP). In addition, it provides protocol details for XCAP for barring of supplementary services configuration.

2.2.2.191 TS 24.322

Tunnelling of IP Multimedia Subsystem (IMS) services over restrictive access networks; Stage 3

This document specifies procedures and protocol elements for tunnelling of IMS traffic over restrictive access networks, specifically procedures and protocol elements for establishing, maintaining, and sending traffic via a firewall traversal tunnel between the UE and an enhanced firewall traversal function (EFTF) in the network. This document is applicable to UE and EFTF.

This document applies only to the case when the IMS traffic is not routed via EPC of a PLMN. Procedures for tunnelling of IMS traffic that is routed via EPC are specified in 3GPP TS 24.302 annex F.

2.2.2.192 TS 24.327

Mobility between 3GPP Wireless Local Area Network (WLAN) interworking (I-WLAN) and 3GPP systems; General Packet Radio System (GPRS) and 3GPP I-WLAN aspects; Stage 3

This document specifies the signalling procedures for handling the mobility of a UE between 3GPP Wireless Local Area Network Interworking (I-WLAN) and GPRS systems and is applicable to the User Equipment (UE) and the network nodes supporting mobility between 3GPP I-WLAN and GPRS systems. In addition, it specifies the procedures used between the UE and the network nodes for the attach and the detach cases. It also specifies how the UE performs handover when moving from 3GPP I-WLAN to GPRS systems and vice-versa.

2.2.2.193 TS 24.333

Proximity-services (ProSe) Management Objects (MO)

This document defines Management Objects (MO) that are used to configure the ProSe-enabled UE. The MOs are compatible with the OMA Device Management (DM) protocol specifications, version 1.2 and upwards, and are defined using the OMA DM Device Description Framework (DDF) as described in the Enabler Release Definition OMA-ERELED-DM-V1_2.

The MOs consist of relevant parameters for provisioning and authorisation of ProSe at the ProSe-enabled UE.

The protocol aspects for ProSe are described in 3GPP TS 24.334.

2.2.2.194 TS 24.334

Proximity-services (ProSe) User Equipment (UE) to ProSe function protocol aspects; Stage 3

This document specifies the protocols for Proximity-based Services (ProSe) between:

- the ProSe-enabled UE and the ProSe Function (over the PC3 interface); and
- two ProSe-enabled UEs (over the PC5 interface).

This document defines the associated procedures for ProSe service authorisation, ProSe direct discovery, EPC-level ProSe discovery, and EPC support for WLAN direct discovery and communication.

This document also defines the message format, message contents, error handling and system parameters applied by the protocols for ProSe.

This document is applicable to:

- the ProSe-enabled UE; and
- the ProSe Function.

2.2.2.195 TS 24.337

IP Multimedia (IM) Core Network (CN) subsystem IP Multimedia Subsystem (IMS) Inter-UE transfer; Stage 3

This document provides the protocol details for enabling IMS inter-UE transfer based on the Session Initiation protocol (SIP) and the Session Description Protocol (SDP).

2.2.2.196 TS 24.341

Support of SMS over IP networks; Stage 3

This document provides the protocol details for SMS over IP within the IP Multimedia (IM) Core Network (CN) subsystem based on the Session Initiation Protocol (SIP) and SIP Events as defined in 3GPP TS 24.229. Where possible this document specifies the requirements for this protocol by reference to specifications produced by the IETF within the scope of SIP and SIP Events, either directly, or as modified by 3GPP TS 24.229. This document is applicable to Application Servers (ASs) and User Equipment (UE) providing SMS over IP functionality.

2.2.2.197 TS 24.368

Non-Access Stratum (NAS) Management Object (MO)

This document defines a Management Object (MO) that can be used to configure the UE with parameters related to Non-Access Stratum (NAS) functionality.

2.2.2.198 TS 24.371**Web Real-Time Communications (WebRTC) client access to the IP Multimedia (IM) Core Network (CN) subsystem; Protocol specification**

This document provides the details for allowing Web Real-Time Communication (WebRTC) IMS Clients (WIC) to access the IP Multimedia (IM) Core Network (CN) subsystem.

This document is applicable to WebRTC IMS client (WIC), eP-CSCF, WebRTC Web Server Function (WWSF) and WebRTC Authorization Function (WAF).

2.2.2.199 TS 24.379**Mission Critical Push To Talk (MCPTT) call control; Protocol specification**

This document specifies the session control protocols needed to support Mission Critical Push To Talk (MCPTT). This document specifies both on-network and off-network protocols.

Mission critical communication services are services that require preferential handling compared to normal telecommunication services, e.g. in support of police or fire brigade.

The MCPTT service can be used for public safety applications and also for general commercial applications (e.g. utility companies and railways).

This document is applicable to User Equipment (UE) supporting the MCPTT client functionality, and to application servers supporting the MCPTT server functionality.

2.2.2.200 TS 24.380**Mission Critical Push To Talk (MCPTT) media plane control; Protocol specification**

This document specifies the media plane control protocols and interactions with the media needed to support Mission Critical Push To Talk (MCPTT).

This document specifies protocol for using pre-established session to setup calls, floor control and managing MBMS subchannels over MBMS bearers on-network and off-network protocols for floor control.

Mission critical communication services are services that require preferential handling compared to normal telecommunication services, e.g. in support of police or fire brigade. Floor control provides a mechanism for managing the right to transmit at a point in time during an MCPTT call.

The MCPTT service and its associated media plane control protocols can be used for public safety applications and for general commercial applications (e.g. utility companies and railways).

This document is applicable to User Equipment (UE) supporting the floor participant functionality, setting up calls using pre-established SIP sessions and using MBMS bearers for group communication and to floor control servers supporting these functions in the MCPTT system.

2.2.2.201 TS 24.381**Mission Critical Push To Talk (MCPTT) group management; Protocol specification**

This document specifies the group management protocols needed to support Mission Critical Push To Talk (MCPTT). Group management applies only when the UE operates on the network.

Mission critical communication services are services that require preferential handling compared to normal telecommunication services, e.g. in support of police or fire brigade.

The MCPTT service can be used for public safety applications and for general commercial applications (e.g. utility companies and railways).

This document is applicable to User Equipment (UE) supporting the group management client (GMC) functionality, to application server supporting the group management server (GMS) functionality, and to application server supporting the MCPTT server functionality.

2.2.2.202 TS 24.382

Mission Critical Push To Talk (MCPTT) identity management; Protocol specification

This document specifies the identity management and authentication protocols needed to support Mission Critical Push To Talk (MCPTT). Identity management applies only to on-network operation.

Mission critical communication services are services that require preferential handling compared to normal telecommunication services, e.g. in support of police or fire brigade.

The MCPTT service can be used for public safety applications and for general commercial applications (e.g. utility companies and railways).

This document is applicable to User Equipment (UE) supporting the identity management client functionality, and to application servers supporting the identity management server functionality.

2.2.2.203 TS 24.383

Mission Critical Push To Talk (MCPTT) Management Object (MO)

This document defines a number of Mission Critical Push To Talk (MCPTT) Management Objects (MO) that are configured for the MCPTT UE for the operation of the MCPTT Service. The management objects are compatible with OMA Device Management protocol specifications, version 1.2 and upwards, and is defined using the OMA DM Device Description Framework as described in the Enabler Release Definition OMA OMA-ERELED_DM-V1_2.

Mission critical communication services are services that require preferential handling compared to normal telecommunication services, e.g. in support of police or fire brigade.

The MCPTT service can be used for public safety applications and for general commercial applications (e.g. utility companies and railways).

This document is applicable to an MCPTT UE supporting on-line, off-line or both on-line and off-line configuration of the configuration management client.

This document is applicable to an MCPTT UE supporting off-line configuration of the group management client.

The parameters defined by the management objects in this document are configured in the MCPTT UE using on-line configuration over the CSC-4 reference point and using off-line configuration over the CSC-11 and CSC-12 reference points. Other specifications define how these parameters are used in the operation of MCPTT, and whether they are applicable to on-network operation or off-network operation, or both:

- 3GPP TS 24.379
- 3GPP TS 24.380
- 3GPP TS 24.381
- 3GPP TS 24.382
- 3GPP TS 24.384

The common network operation means both on-network operation and off-network operation in this document.

The following management objects are defined in this document:

- MCPTT UE configuration MO

- MCPTT user profile MO
- MCPTT group configuration MO
- MCPTT service configuration MO
- MCPTT UE initial configuration MO

The MOs listed above define repositories of data in the ME.

2.2.2.204 TS 24.384

Mission Critical Push To Talk (MCPTT) configuration management; Protocol specification

This document specifies the configuration management documents and protocols needed to support Mission Critical Push To Talk (MCPTT) online configuration over the CSC-4 and CSC-5 reference points and the procedures to support Mission Critical Push To Talk (MCPTT) offline configuration over the CSC-11 and CSC-12 reference points. Configuration management documents defined in this document includes:

- MCPTT UE initial configuration document;
- MCPTT UE configuration document;
- MCPTT user profile configuration document; and
- MCPTT service configuration document.

Mission critical communication services are services that require preferential handling compared to normal telecommunication services, e.g. in support of police or fire brigade.

The MCPTT service can be used for public safety applications and for general commercial applications (e.g. utility companies and railways).

This document is applicable to an MCPTT UE supporting the configuration management client functionality, to application server supporting the configuration management server functionality, and to application server supporting the MCPTT server functionality.

2.2.2.205 TS 24.385

V2X services Management Object (MO)

This document defines Management Object (MO) that is used to configure the UE for V2X services.

The MO is compatible with the OMA Device Management (DM) protocol specifications, version 1.2 and upwards, and is defined using the OMA DM Device Description Framework (DDF) as described in the Enabler Release Definition OMA-ERELD-DM-V1_2.

The MO consists of relevant parameters for provisioning and authorization of V2X communication at the UE.

The protocol aspects for V2X are described in 3GPP TS 24.386.

2.2.2.206 TS 24.386

User Equipment (UE) to V2X control function; protocol aspects; Stage 3

This document specifies the protocols:

- for V2X authorization between the UE and the V2X control function (over the V3 interface);
- for V2X communication among the UEs (over the PC5 interface); and
- for V2X communication between the UE and the V2X application server (over the LTE-Uu interface).

This document defines the associated procedures for V2X authorization and V2X communication.

This document also defines the message format, message contents, error handling and system parameters applied by the protocols for V2X.

This document is applicable to:

- the UE;
- the V2X control function; and
- the V2X application server.

2.2.2.207 TS 24.390

Unstructured Supplementary Service Data (USSD) using IP Multimedia (IM) Core Network (CN) subsystem IMS; Stage 3

This document describes the procedures for using Unstructured Supplementary Service Data (USSD) operations for mobile initiated MMI mode over IP Multimedia Core Network Subsystem (IMS). MMI mode is for the transparent transport of MMI strings entered by the user to the Application Servers (AS) and for the transparent transport of text strings back to the User Equipment (UE) to be displayed for user information. Support of USSD service is optional and only applicable for an operator's Public Land Mobile Network (PLMN). This document is applicable to UE and AS which are intended to support USSD operations over IP Multimedia Core Network Subsystem (IMS) in mobile initiated MMI mode.

2.2.2.208 TS 24.391

Unstructured Supplementary Service Data (USSD) using IP Multimedia (IM) Core Network (CN) subsystem (IMS) Management Object (MO)

This document defines the unstructured supplementary service data (USSD) using IP Multimedia (IM) Core Network (CN) subsystem (IMS) management object (MO). The MO is compatible with OMA device management protocol specifications, version 1.2 and upwards, and is defined using the OMA DM device description framework as described in the enabler release definition OMA-ERELED_DM-V1_2.

The USSD using IMS (USSI) MO consists of relevant configuration parameters that can be managed for the UE's USSI capabilities specified in 3GPP TS 24.390.

2.2.2.209 TS 24.481

Mission Critical Services (MCS) group management; Protocol specification

This document specifies the group management protocols needed to support Mission Critical Services (MCSs). Group management applies only when the UE operates on the network.

Mission critical communication services are services that require preferential handling compared to normal telecommunication services, e.g. in support of police or fire brigade.

The MCSs can be used for public safety applications and for general commercial applications (e.g. utility companies and railways).

This document is applicable to User Equipment (UE) supporting the group management client (GMC) functionality, to application server supporting the group management server (GMS) functionality, and to application server supporting the MCPTT server functionality.

2.2.2.210 TS 24.482**Mission Critical Services (MCS) identity management; Protocol specification**

This document specifies the identity management and authentication protocols needed to support Mission Critical Services (MCSs). Identity management applies only to on-network operation.

Mission critical communication services are services that require preferential handling compared to normal telecommunication services, e.g. in support of police or fire brigade.

The MCSs can be used for public safety applications and for general commercial applications (e.g. utility companies and railways).

This document is applicable to User Equipment (UE) supporting the identity management client functionality, and to application servers supporting the identity management server functionality.

2.2.2.211 TS 24.483**Mission Critical Services (MCS) Management Object (MO)**

This document defines a number of Mission Critical Services (MCSs) Management Objects (MO) that are configured for the UE for the operation of the MCSs. The management objects are compatible with OMA Device Management protocol specifications, version 1.2 and upwards, and is defined using the OMA DM Device Description Framework as described in the Enabler Release Definition OMA OMA-ERELD_DM-V1_2.

Mission critical communication services are services that require preferential handling compared to normal telecommunication services, e.g. in support of police or fire brigade.

The MCSs can be used for public safety applications and for general commercial applications (e.g. utility companies and railways).

This document is applicable to an UE supporting on-line, off-line or both on-line and off-line configuration of the configuration management client.

This document is applicable to an UE supporting off-line configuration of the group management client.

The parameters defined by the management objects in this document are configured in the UE using on-line configuration over the CSC-4 reference point and using off-line configuration over the CSC-11 and CSC-12 reference points. Other specifications define how these parameters are used in the operation of MCSs, and whether they are applicable to on-network operation or off-network operation, or both:

- 3GPP TS 24.379
- 3GPP TS 24.380
- 3GPP TS 24.381
- 3GPP TS 24.382
- 3GPP TS 24.384

The common network operation means both on-network operation and off-network operation in this document.

The following management objects are defined in this document:

- MCPTT UE configuration MO
- MCPTT user profile MO
- MCPTT group configuration MO
- MCPTT service configuration MO

- MCPTT UE initial configuration MO

The MOs listed above define repositories of data in the ME.

2.2.2.212 TS 24.484

Mission Critical Services (MCS) configuration management; Protocol specification

This document specifies the configuration management documents and protocols needed to support Mission Critical Service (MCS) online configuration over the CSC-4 and CSC-5 reference points and the procedures to support Mission Critical Service (MCS) offline configuration over the CSC-11 and CSC-12 reference points. Configuration management documents defined in this document includes:

- MCPTT UE initial configuration document;
- MCPTT UE configuration document;
- MCPTT user profile configuration document; and
- MCPTT service configuration document.

Mission critical communication services are services that require preferential handling compared to normal telecommunication services, e.g. in support of police or fire brigade.

The MCSs can be used for public safety applications and for general commercial applications (e.g. utility companies and railways).

This document is applicable to an MCPTT UE supporting the configuration management client functionality, to application server supporting the configuration management server functionality, and to application server supporting the MCPTT server functionality.

2.2.2.213 TS 24.417

Management Object (MO) for Originating Identification Presentation (OIP) and Originating Identification Restriction (OIR) using IP Multimedia (IM) Core Network (CN) subsystem

This document defines a Management Object (MO) for Originating Identification Presentation (OIP) and Originating Identification Restriction (OIR). The management object is compatible with OMA Device Management protocol specifications, version 1.2 and upwards, and is defined using the OMA DM Device Description Framework as described in the Enabler Release Definition OMA-ERELED_DM-V1_2.

The OIP/OIR MO consists of relevant parameters that can be managed for the UE configuration related to the Originating Identification Presentation (OIP) and Originating Identification Restriction (OIR) service defined in 3GPP TS 24.607.

2.2.2.214 TS 24.424

Management Object (MO) for Extensible Markup Language (XML) Configuration Access Protocol (XCAP) over the Ut interface for Manipulating Supplementary Services (SS)

This document defines the management object (MO) for extensible markup language (XML) configuration access protocol (XCAP) over the Ut interface for manipulating supplementary services (SS).

The MO for XCAP over Ut interface for manipulating SS is compatible with OMA device management protocol specifications, version 1.2 and upwards, and is defined using the OMA DM device description framework as described in the enabler release definition OMA-ERELED_DM-V1_2.

The MO for XCAP over Ut interface for manipulating SS consists of relevant configuration parameters that can be managed for a UE supporting the UE role specified in 3GPP TS 24.623.

2.2.2.215 TS 24.523**Core and enterprise Next Generation Network (NGN) interaction scenarios; Architecture and functional description**

This document provides the possible scenarios for:

- the interconnection of an Next Generation Corporate Network (NGCN) with a Next Generation Network (NGN); and
- the support of NGCN capabilities within an NGN, either towards a User Equipment (UE) or to an NGCN.

Unless otherwise specified by reference to other documents, all requirements relating to architecture and functional requirements are contained within this document.

2.2.2.216 TS 24.524**Hosted enterprise services; Architecture, functional description and signalling**

This document describes the architecture and functionality required to support enterprise and corporate services as IMS applications hosted in the NGN operator's network on behalf of an enterprise (Hosted Enterprise Services).

This document also specifies the protocol requirements for the UE to attach to the NGN (in particular the IMS) and also any protocol requirements related to application servers provided in support of hosted enterprise services.

2.2.2.217 TS 24.525**Business trunking; Architecture and functional description**

This document provides architecture and functional requirements for business trunking for the Next Generation Network (NGN).

This document also specifies the protocol requirements for the Next Generation Corporate Networks (NGCNs) to attach to the NGN (in particular the IM CN subsystem) and also any protocol requirements relation to application servers provided in support of business trunking.

Business trunking is a set of NGN capabilities that may be applied to communications between NGCNs using the NGN as a transit.

2.2.2.218 TS 24.581**Mission Critical Video (MCVideo) media plane control; Protocol specification**

This document specifies the media plane control and transmission control protocols and interactions with the media needed to support Mission Critical Video (MCVideo) service.

The MCVideo service and its associated media plane control protocols can be used for public safety applications and also for general commercial applications (e.g. utility companies and railways).

This document is applicable to User Equipment (UE) supporting MCVideo client, and MCVideo server supporting media distribution function and transmission control server.

2.2.2.219 TS 24.582**Mission Critical Data (MCData) media plane control; Protocol specification**

This document specifies the media plane control protocols and interactions with the media needed to support Mission Critical Data (MCData) services, which are Short Data Service (SDS) and File Distribution (FD).

Mission critical communication services are services that require preferential handling compared to normal telecommunication services, e.g. in support of police or fire brigade.

The MCDATA service and its associated media plane control protocols can be used for public safety applications and also for general commercial applications (e.g. utility companies and railways).

This document is applicable to User Equipment (UE) supporting MCDATA client functionality and to servers in the MCDATA system.

2.2.2.220 TS 24.604

Communication Diversion (CDIV) using IP Multimedia (IM) Core Network (CN) subsystem; Protocol specification

This document specifies the stage 3, Protocol Description of the Communications Diversion (CDIV) supplementary services, based on stages 1 and 2 of the ISDN Communication diversion supplementary services. It provides the protocol details in the IP Multimedia (IM) Core Network (CN) subsystem based on the Session Initiation Protocol (SIP) and the Session Description Protocol (SDP).

2.2.2.221 TS 24.605

Conference (CONF) using IP Multimedia (IM) Core Network (CN) subsystem; Protocol specification

This document specifies the stage 3 Protocol Description of the Conference (CONF) service based on stages 1 and 2 of the ISDN CONF supplementary service. It provides the protocol details in the IP Multimedia (IM) Core Network (CN) subsystem based on the Session Initiation Protocol (SIP) and the Session Description Protocol (SDP).

2.2.2.222 TS 24.606

Message Waiting Indication (MWI) using IP Multimedia (IM) Core Network (CN) subsystem; Protocol specification

This document specifies the stage 3 Protocol Description of the Message Waiting Indication (MWI) service, based on stages 1 and 2 of the ISDN MWI supplementary services. It provides the protocol details in the IP Multimedia (IM) Core Network (CN) subsystem based on the Session Initiation Protocol (SIP) and the Session Description Protocol (SDP).

2.2.2.223 TS 24.607

Originating Identification Presentation (OIP) and Originating Identification Restriction (OIR) using IP Multimedia (IM) Core Network (CN) subsystem; Protocol specification

This document specifies the stage 3 (protocol description) of the Originating Identification Presentation (OIP) supplementary service and the Originating Identification Restriction (OIR) supplementary services, based on stages 1 and 2 of the ISDN CLIP and CLIR supplementary service. It provides the protocol details in the IP Multimedia (IM) Core Network (CN) subsystem based on the Session Initiation Protocol (SIP) and the Session Description Protocol (SDP).

2.2.2.224 TS 24.608

Terminating Identification Presentation (TIP) and Terminating Identification Restriction (TIR) using IP Multimedia (IM) Core Network (CN) subsystem; Protocol specification

This document specifies the stage 3 protocol description of the Terminating Identification Presentation (TIP) and Terminating Identification Restriction (TIR) services, based on stage 1 and 2 of the ISDN COLP and COLR supplementary services. It provides the protocol details in the IP

Multimedia (IM) Core Network (CN) subsystem based on the Session Initiation Protocol (SIP) and the Session Description Protocol (SDP).

2.2.2.225 TS 24.610

Communication HOLD (HOLD) using IP Multimedia (IM) Core Network (CN) subsystem; Protocol specification

This document specifies the stage 3 Protocol Description of the Communication Hold (HOLD) services, based on stages 1 and 2 of the ISDN Hold (HOLD) supplementary services. It provides the protocol details in the IP Multimedia (IM) Core Network (CN) subsystem based on the Session Initiation Protocol (SIP) and the Session Description Protocol (SDP).

2.2.2.226 TS 24.611

Anonymous Communication Rejection (ACR) and Communication Barring (CB) using IP Multimedia (IM) Core Network (CN) subsystem; Protocol specification

This document specifies the stage 3, Protocol Description of the Anonymous Communication Rejection (ACR) and Communication Barring (CB) supplementary service, based on stage 1 and 2 of the ISDN supplementary service Anonymous Call Rejection (ACR), Incoming Communication Barring (ICB) and Outgoing Communication Barring (OCB). It provides the protocol details in the IP Multimedia (IM) Core Network (CN) subsystem based on the Session Initiation Protocol (SIP) and the Session Description Protocol (SDP).

2.2.2.227 TS 24.615

Communication Waiting (CW) using IP Multimedia (IM) Core Network (CN) subsystem; Protocol specification

This document specifies the stage 3, Protocol Description of the Communication Waiting (CW) service, based on stage 1 and stage 2 of the ISDN call waiting supplementary services. It provides the protocol details in the IP Multimedia (IM) Core Network (CN) subsystem based on the Session Initiation Protocol (SIP) and the Session Description Protocol (SDP).

2.2.2.228 TS 24.616

Malicious Communication Identification (MCID) using IP Multimedia (IM) Core Network (CN) subsystem; Protocol specification

This document specifies the stage 3 Protocol Description of the Malicious Call Communication Identification (MCID) service based on the stages 1 and 2 of ISDN Malicious Call Identification supplementary service. It provides the protocol details in the IP Multimedia (IM) Core Network (CN) subsystem based on the Session Initiation Protocol (SIP) and the Session Description Protocol (SDP). The MCID service will store session related information independent of the service requested.

2.2.2.229 TS 24.623

Extensible Markup Language (XML) Configuration Access Protocol (XCAP) over the Ut interface for manipulating supplementary services

This document defines a protocol used for manipulating data related to supplementary services. The protocol is based on the eXtensibleMarkup Language (XML) Configuration Access Protocol (XCAP) RFC 4825. A new XCAP application usage is defined for the purpose of manipulating the supplementary services data. The common XCAP related aspects that are applicable to supplementary services are specified in this document. The protocol allows authorized users to manipulate service-related data either when they are connected to IMS or when they are connected to non-IMS networks (e.g. the public Internet).

2.2.2.230 TS 24.628**Common Basic Communication procedures using IP Multimedia (IM) Core Network (CN) subsystem; Protocol specification**

This document describes the stage 3 protocol for basic communication procedures common to several services in the IP Multimedia (IM) Core Network (CN) subsystem when at least one Application Server (AS) is included in the communication. The common procedures are based on stage 3 specifications for supplementary services.

2.2.2.231 TS 24.629**Explicit Communication Transfer (ECT) using IP Multimedia (IM) Core Network (CN) subsystem; Protocol specification**

This document specifies the stage 3 (protocol description) of the Explicit Communication transfer (ECT) supplementary service, based on stage 1 and 2 of the ISDN ECT supplementary service. It provides the protocol details in the IP Multimedia (IM) Core Network (CN) subsystem based on the Session Initiation Protocol (SIP) and the Session Description Protocol (SDP).

2.2.2.232 TS 24.642**Completion of Communications to Busy Subscriber (CCBS) and Completion of Communications by No Reply (CCNR) using IP Multimedia (IM) Core Network (CN) subsystem; Protocol specification**

This document specifies the stage 3 Protocol Description of the Completion of Communications to Busy Subscriber (CCBS) service and the Completion of Communication on no Reply (CCNR) service, based on stages 1 and 2 of the ISDN supplementary services. It provides the protocol details in the IP Multimedia (IM) Core Network (CN) subsystem based on the Session Initiation Protocol (SIP) and the Session Description Protocol (SDP).

2.2.2.233 TS 24.647**Advice of Charge (AOC) using IP Multimedia (IM) Core Network (CN) subsystem**

This document specifies the stage 3 Protocol Description of the Advice of Charge (AOC) service, based on stage 1 and 2 of the ISDN Supplementary Service Advice of Charge for all calls (permanent mode). It provides the protocol details in the IP Multimedia (IM) Core Network (CN) subsystem based on the Session Initiation Protocol (SIP) and the Session Description Protocol (SDP).

2.2.2.234 TS 24.654**Closed User Group (CUG) using IP Multimedia (IM) Core Network (CN) subsystem, Protocol specification**

This document specifies the stage 3 Protocol Description of the Closed User Group (CUG) service, based on stage 1 and 2 of the ISDN Communication diversion supplementary services. It provides the protocol details in the IP Multimedia (IM) Core Network (CN) subsystem based on the Session Initiation Protocol (SIP) and the Session Description Protocol (SDP).

2.2.2.235 TS 26.071**AMR speech codec: general description**

This specification describes an introduction to the set of the adaptive multi-rate (AMR) specifications.

2.2.2.236 TS 26.090**AMR speech codec: transcoding functions**

This specification describes a detailed description of the AMR speech codec transcoding functions.

2.2.2.237 TS 26.091**AMR speech codec: error concealment of lost frames**

This specification describes example procedures for the error concealment, also called frame substitution or muting procedure, of lost speech or silence indicator frames.

2.2.2.238 TS 26.092**AMR speech codec: comfort noise aspects**

This specification describes the detailed requirements for the correct operation of the background acoustic noise evaluation, noise parameter encoding/decoding and comfort noise generation for the AMR speech codec during source controlled rate (SCR) operation.

2.2.2.239 TS 26.093**AMR speech codec: source controlled rate (SCR) operation**

This specification describes the operation of the AMR speech codec during SCR operation.

2.2.2.240 TS 26.094**AMR speech codec: voice activity detector (VAD)**

This specification describes two alternatives for the VAD to be used during SCR operation in conjunction with the AMR codec.

2.2.2.241 TS 26.110**Codec for circuit-switched multimedia telephony service: general description**

This specification describes an introduction to the set of specifications for the support of circuit-switched 3G-324M multimedia telephony service.

2.2.2.242 TS 26.111**Codec for circuit-switched multimedia telephony service: modifications to Recommendation ITU-T H.324**

This specification describes the modifications applicable to the Recommendation ITU-T H.324, Annex C for the support of circuit-switched 3G-324M multimedia telephony service.

2.2.2.243 TS 26.116**Television (TV) over 3GPP services; Video profiles**

This document specifies requirements and guidelines on video source formats (frame rate, resolution, aspect ratio, colorimetry, bit depth...) and encoding parameters (codec format, random access point period, SEI messages...) for different types of TV services, including linear TV, catch-up TV or on-demand services. A limited set of Operation Points (e.g. SDTV, HDTV...) are defined to provide confidence to content providers/broadcasters on the quality of experience offered by 3GPP services when used for TV-like distribution. Operation Points define format and encoding restrictions, but may also be viewed as compatibility points for UEs.

In particular, the Operation Points defined in this document may serve as the primary tested configurations for TV centric video distribution. The initial set of Operation Points are defined based on the analysis and findings in the technical report TR 26.949.

In addition, in the context of DASH operations, not only the main distribution format are defined, but also a subset of spatial and temporal resolutions. In order to minimize testing for seamless switching experience, suitable lower resolutions of distribution formats are defined. Furthermore, to compensate congestion situations, a minimum service quality is defined in order to provide service continuity.

2.2.2.244 TS 26.179

Mission Critical Push To Talk (MCPTT); Codecs and media handling

This document specifies the codecs and media handling for MCPTT. The corresponding service requirements are defined in 3GPP TS 22.179. The corresponding functional architecture, procedures and information flows are defined in 3GPP TS 23.179.

2.2.2.245 TS 26.223

Telepresence using the IP Multimedia Subsystem (IMS); Media handling and interaction

This document specifies a client for the IMS-based telepresence service supporting conversational speech, video and text transported over RTP. Telepresence is defined as a conference with interactive audio-visual communications experience between remote locations, where the users enjoy a strong sense of realism and presence between all participants (i.e. as if they are in same location) by optimizing a variety of attributes such as audio and video quality, eye contact, body language, spatial audio, coordinated environments and natural image size. A telepresence system is defined as a set of functions, devices and network elements which are able to capture, deliver, manage and render multiple high quality interactive audio and video signals in a telepresence conference. An appropriate number of devices (e.g. cameras, screens, loudspeakers, microphones, codecs) and environmental characteristics are used to establish telepresence.

The media handling capabilities of a telepresence client (TP UE) are specified in this document. A TP UE supports Multimedia Telephony Service for IMS (MTSI) UE media handling capabilities, but it also supports more advanced media handling capabilities. The media handling aspects of a TP UE within the scope of this document include media codecs, media configuration and session control, data transport, audio/video parameters, and interworking with MTSI.

2.2.2.246 TS 26.281

Mission Critical Video (MCVideo); Codecs and media handling

This document specifies the codecs and media handling for MCVideo. The requirements for MCVideo are specified by SA1 in two technical specifications:

- The requirements specific to Mission Critical Video have been specified in 3GPP TS 22.281.
- The requirements common to multiple mission critical services have been specified in 3GPP TS 22.280.

The architectural work for MCVideo is specified by SA6 in two technical specifications:

- Architectural and feature work specific to MCVideo have been specified in 3GPP TS 23.281.
- Architectural aspects common to multiple mission critical services have been specified in 3GPP TS 23.280.

2.2.2.247 TS 26.307**Presentation layer for 3GPP services**

This document specifies an HTML5 profile as a common presentation layer for 3GPP services.

2.2.2.248 TS 26.346**Multimedia Broadcast/Multicast Service (MBMS); Protocols and codecs**

This document defines a set of media codecs, formats and transport/application protocols to enable the deployment of MBMS user services either over the MBMS bearer service or other UMTS Bearer Services within the 3GPP system.

In this version of the specification, only MBMS download and streaming delivery methods are specified. This document does not preclude the use of other delivery methods.

This document includes information applicable to network operators, service providers and manufacturers.

2.2.2.249 TS 26.347**Multimedia Broadcast/Multicast Service (MBMS); Application Programming Interface and URL**

This document provides application methods and interfaces between an MBMS-aware application and the UE MBMS Client to access 3GPP MBMS User services. The purpose of the document is the definition of enablers in order to simplify the usage of MBMS in web-centric as well as app-based service environments.

This document defines several APIs to access MBMS User Services and a URL to access resources available as part of an MBMS User Service. The MBMS User Services are defined in TS 26.346 and are not part of this document.

2.2.2.250 TS 26.441**Codec for Enhanced Voice Services (EVS); General overview**

This document is an introduction to the audio processing parts of the Enhanced Voice Services coder. A general overview of the audio processing functions is given with reference to the documents where each function is specified in detail.

2.2.2.251 TS 26.442**Codec for Enhanced Voice Services (EVS); ANSI C code (fixed-point)**

This document contains an electronic copy of the ANSI-C code for the Enhanced Voice Services (EVS) Codec. The ANSI-C code is necessary for a bit exact implementation of the EVS Codec (3GPP TS 26.445), Voice Activity Detection (VAD) (3GPP TS 26.451), Comfort Noise Generation (CNG) (3GPP TS 26.449), Discontinuous Transmission (DTX) (3GPP TS 26.450), Packet Loss Concealment (PLC) of Lost Packets (3GPP TS 26.447), Jitter Buffer Management (JBM) (3GPP TS 26.448), and AMR-WB Interoperable Function (3GPP TS 26.446).

2.2.2.252 TS 26.444**Codec for Enhanced Voice Services (EVS); Test sequences**

This document specifies the digital test sequences for the Enhanced Voice Services (EVS) Codec. These sequences test for a bit-exact implementation of the EVS Codec (3GPP TS 26.445), Voice Activity Detection (VAD) (3GPP TS.26.451), Comfort Noise Generation (3GPP TS 26.449),

Discontinuous Transmission (DTX) (3GPP TS 26.450), Error Concealment of Lost Packets (3GPP TS 26.447), Jitter Buffer Management (JBM) (3GPP TS 26.448), and AMR-WB Interoperable Function (3GPP TS 26.446).

2.2.2.253 TS 26.445

Codec for Enhanced Voice Services (EVS); Detailed algorithmic description

This document is a detailed description of the signal processing algorithms of the Enhanced Voice Services coder.

2.2.2.254 TS 26.446

Codec for Enhanced Voice Services (EVS); Adaptive Multi-Rate - Wideband (AMR-WB) backward compatible functions

This document specifies the AMR-WB backward compatible functions of the EVS codec.

This document is a high-level overview of the functionality with reference to the Codec Detailed Algorithmic Description where the functionality is specified in detail.

2.2.2.255 TS 26.447

Codec for Enhanced Voice Services (EVS); Error concealment of lost packets

This document defines a frame loss concealment procedure, also termed frame substitution and muting procedure, which is executed by the Enhanced Voice Services (EVS) decoder when one or more frames (speech or audio or SID frames) are unavailable for decoding due to e.g. packet loss, corruption of a packet or late arrival of a packet.

2.2.2.256 TS 26.448

Codec for Enhanced Voice Services (EVS); Jitter buffer management

This document defines the Jitter Buffer Management solution for the Codec for Enhanced Voice Services (EVS).

2.2.2.257 TS 26.449

Codec for Enhanced Voice Services (EVS); Comfort Noise Generation (CNG) aspects

This document gives an overview for the requirements of the background acoustic noise evaluation, noise parameter encoding/decoding and comfort noise generation for the Enhanced Voice Services (EVS) speech codec during Discontinuous Transmission (DTX) operation.

2.2.2.258 TS 26.450

Codec for Enhanced Voice Services (EVS); Discontinuous Transmission (DTX)

This document specifies the system level aspects of the Discontinuous Transmission (DTX) function of the EVS codec.

2.2.2.259 TS 26.451

Codec for Enhanced Voice Services (EVS); Voice Activity Detection (VAD)

This document specifies the Voice Activity Detector (VAD) used in the Discontinuous Transmission (DTX) of the EVS Codec. Although the main application of the VAD algorithm is the detection of speech or voice signals, the algorithm is more accurately described as a Signal Activity Detection (SAD) algorithm.

This document is a high-level overview of the functionality with reference to the Codec Detailed Algorithmic Description where the functionality is specified in detail.

2.2.2.260 TS 26.453

Codec for Enhanced Voice Services (EVS); Speech codec frame structure

The **Enhanced Voice Services (EVS)** Codec is specified in the series of Technical Specifications 3GPP TS 26.441 to TS 26.451 and it is characterized in TR 26.952.

This document describes the "generic frame format" for the EVS Codec for the application in 3G Circuit-Switched Networks. This format is based on the RTP framing, as specified in TS 26.445. This generic frame format will be used as a common reference point, when interfacing speech frames between different elements of the 3G system. Appropriate mappings to and from this generic frame format will be used within and between each system element.

2.2.2.261 TS 26.454

Codec for Enhanced Voice Services (EVS); Interface to Iu, Uu, Nb and Mb

The **Enhanced Voice Services (EVS)** Codec is specified in Technical Specifications 3GPP TS 26.441 to TS 26.451. The generic frame format for 3G CS networks is specified in TS 26.453. The allowed EVS Configurations of the UMTS_EVS Codec Type are specified in TS 26.103.

This document specifies the mapping of the EVS generic frame format (3GPP TS 26.453) to the Iu Interface (3GPP TS 25.415) and the Uu Interface, including handling of the EVS-CMR by the UE and the Iu-terminating MGW.

This document specifies also the mapping to the Nb Interface in a BICC-based circuit switched core network. (3GPP TS 29.415) and the Nb-Interface in a SIP-I-based circuit switched core network (3GPP TS 23.231).

This document specifies also the interworking of different EVS Configurations on the terminations of the MGW and the interworking between EVS and AMR-WB on the terminations of the MGW.

2.2.2.262 TS 27.005

Use of Data Terminal Equipment – Data Circuit terminating Equipment (DTE-DCE) interface for Short Message Service (SMS) and Cell Broadcast Service (CBS)

This specification describes three interface protocols for control of SMS functions within a GSM mobile telephone from a remote terminal via an asynchronous interface.

2.2.2.263 TS 27.007

AT command set for User Equipment (UE)

This specification describes a profile of AT commands and recommends that this profile be used for controlling mobile equipment (ME) functions and GSM network services from a terminal equipment (TE) through terminal adaptor (TA).

2.2.2.264 TS 27.010

Terminal Equipment to User Equipment (TE-UE) multiplexer protocol

This specification describes a multiplexing protocol between a mobile station and an external data terminal for the purposes of enabling multiple channels to be established for different purposes (e.g. simultaneous SMS and data call).

2.2.2.265 TS 28.301

Telecommunication management; Licensed Shared Access (LSA) Controller (LC) Integration Reference Point (IRP); Requirements

This document specifies the requirements of the Licensed Shared Access (LSA) Controller (LC) Integration Reference Point (IRP). This IRP allows the NM to interact with the LC. This interaction with the LC enables the NM to configure NEs utilizing LSA spectrum resources.

The following two deployment scenarios are supported:

- one scenario in which the LC communicates LSA spectrum resource availability information to the NM, and
- one scenario in which the LC determines and communicates to the NM constraints on parameters of cells liable to use LSA spectrum resources.

2.2.2.266 TS 28.302

Telecommunication management; Licensed Shared Access (LSA) Controller (LC) Integration Reference Point (IRP); Information Service (IS)

This document specifies the LSA controller (LC) Integration Reference Point (IRP) management operations and notifications that can be communicated between an IRPAgent and one or several IRPManagers.

This document specifies the semantics and behaviour of operations, notifications and their parameters visible across the reference point in a protocol and technology neutral way. It does not define their syntax and encoding.

2.2.2.267 TS 28.303

Telecommunication management; Licensed Shared Access (LSA) Controller (LC) Integration Reference Point (IRP); Solution Set (SS) definitions

The purpose of this document is to define the mapping of the LSA Controller (LC) Integration Reference Point (IRP) (see 3GPP TS 28.302) to the protocol specific details necessary for implementation of this IRP in a CORBA/IDL environment and in a SOAP/WSDL environment.

This Solution Set specification is related to 3GPP TS 28.302 V14.0.X.

2.2.2.268 TS 28.390

Telecommunication management; Fixed Mobile Convergence (FMC); Interface Integration Reference Point (IRP) Solution Profiles (SPs)

The objective of this specification is to define a set of Solution Profiles (SPs) for Interface IRPs. Each SP identifies the necessary and sufficient subset of the 3GPP IRP defined solutions (solutions) required for the network management of a specific operating environment or domain, including that defined for the converged management environments.

A specific operating environment or domain is characterised by a set of Requirement statements. In other words, the solutions identified in a specific SP would satisfy the Requirements listed in that same SP.

An SP, in its simplest form, is nothing else than a list of solutions (e.g. 3GPP IRP defined operations). The purpose is to place a combination of solutions under a common (SP) name so that:

- Operators and vendors need not decide arbitrarily which solutions are to be used to satisfy the Requirements;

- There is one document where readers can have a clear view of solutions, specified in various IRP specifications, required to satisfy the Requirements.

This version of the TS contains a number of SPs defined in clause 4 and onwards, one clause for each SP.

2.2.2.269 TS 28.402

Telecommunication management; Performance Management (PM); Performance measurements for Evolved Packet Core (EPC) and non-3GPP access interworking system

This document describes the measurements for EPC and non-3GPP access network interworking.

TS 32.401 describes Performance Management concepts and requirements.

This document is valid for all measurement types provided by an implementation of EPC and non-3GPP access Interworking System. Only measurement types that are specific to EPC and non-3GPP access interworking are defined within this documents. Vendor specific measurement types used in EPC and non-3GPP access Interworking System are not covered. Instead, these could be applied according to manufacturer's documentation.

Measurements related to "external" technologies (such as ATM or IP) as described by "external" standards bodies (e.g. ITU-T or IETF) are only be referenced within this specification, wherever there is a need identified for the existence of such a reference.

The definition of the standard measurements is intended to result in comparability of measurement data produced in a multi-vendor network, for those measurement types that can be standardised across all vendors' implementations.

The structure of this document is as follows:

- Header 1: Network Element (e.g. measurements related to ePDG);
- Header 2: Measurement function (e.g. Tunnel establishment);
- Header 3: Measurements.

2.2.2.270 TS 28.403

Telecommunication management; Performance Management (PM); Performance measurements for Wireless Local Area Network (WLAN)

This document describes the measurements for WLAN.

TS 32.401 describes Performance Management concepts and requirements.

This document is valid for all measurement types provided by an implementation of a WLAN.

Only measurement types that are specific to WLAN are defined within this document. Vendor specific measurement types used in WLAN are not covered. Instead, these could be applied according to manufacturer's documentation.

Measurements related to "external" technologies (such as WLAN or IP) as described by "external" standards bodies (e.g. IEEE or IETF) are only referenced within this document, wherever there is a need identified for the existence of such a reference.

The definition of the standard measurements is intended to result in comparability of measurement data produced in a multi-vendor network, for those measurement types that can be standardised across all vendors' implementations.

2.2.2.271 TS 28.500**Telecommunication management; Management concept, architecture and requirements for mobile networks that include virtualized network functions**

This document specifies the management concepts, the management requirements and use cases from operators' perspective for mobile networks that include virtualized network functions which can be part of EPC or IMS, and provides the management architecture for these mobile networks.

2.2.2.272 TS 28.510**Telecommunication management; Configuration Management (CM) for mobile networks that include virtualized network functions; Requirements**

This document (together with the relevant requirements described in 3GPP TR 21.905, 3GPP TS 32.102, 3GPP TS 32.600 and 3GPP TS 28.500) specifies the requirements applicable to Configuration Management (CM) of virtualized network functions which can be part of EPC or IMS.

2.2.2.273 TS 28.511**Telecommunication management; Configuration Management (CM) for mobile networks that include virtualized network functions; Procedures**

This document specifies the Configuration Management (CM) procedures for mobile networks that include virtualized network functions which can be part of EPC or IMS.

2.2.2.274 TS 28.512**Telecommunication management; Configuration Management (CM) for mobile networks that include virtualized network functions; Stage 2**

This document is Configuration Management stage 2 specification for mobile networks that include virtualized network functions which can be part of EPC or IMS.

2.2.2.275 TS 28.513**Telecommunication management; Configuration Management (CM) for mobile networks that include virtualized network functions; Stage 3**

This document is Configuration Management stage 3 specification for mobile networks that include virtualized network functions which can be part of EPC or IMS.

2.2.2.276 TS 28.515**Telecommunication management; Fault Management (FM) for mobile networks that include virtualized network functions; Requirements**

This document (together with the relevant requirements described in TS 28.500, TS 32.101, TS 32.102 and TS 32.111-1) specifies the requirements applicable to Fault Management (FM) of mobile networks that include virtualized network functions which can be part of EPC or IMS.

2.2.2.277 TS 28.516**Telecommunication management; Fault Management (FM) for mobile networks that include virtualized network functions; Procedures**

This document specifies the Fault Management procedures for mobile networks that include virtualized network functions which can be part of EPC or IMS.

2.2.2.278 TS 28.517**Telecommunication management; Fault Management (FM) for mobile networks that include virtualized network functions; Stage 2**

This document is Fault Management stage 2 specification for mobile networks that include virtualized network functions which can be part of EPC or IMS.

2.2.2.279 TS 28.518**Telecommunication management; Fault Management (FM) for mobile networks that include virtualized network functions; Stage 3**

This document is Fault Management stage 3 specification for mobile networks that include virtualized network functions which can be part of EPC or IMS.

2.2.2.280 TS 28.520**Telecommunication management; Performance Management (PM) for mobile networks that include virtualized network functions; Requirements**

This document (together with the relevant requirements described in TS 32.401, TS 32.411, TS 28.500, TS 32.101 and TS 32.102) specifies the requirements applicable to Performance Management (PM) of mobile networks that include virtualized network functions which can be part of EPC or IMS.

2.2.2.281 TS 28.521**Telecommunication management; Performance Management (PM) for mobile networks that include virtualized network functions; Procedures**

This document specifies the Performance Management procedures for mobile networks that include virtualized network functions which can be part of EPC or IMS.

2.2.2.282 TS 28.522**Telecommunication management; Performance Management (PM) for mobile networks that include virtualized network functions; Stage 2**

This document is the Performance Management stage 2 specification for mobile networks that include virtualized network functions, which can be part of EPC or IMS.

2.2.2.283 TS 28.523**Telecommunication management; Performance Management (PM) for mobile networks that include virtualized network functions; Stage 3**

This document is the Performance Management stage 3 specification for mobile networks that include virtualized network functions, which can be part of EPC or IMS.

2.2.2.284 TS 28.525**Telecommunication management; Life Cycle Management (LCM) for mobile networks that include virtualized network functions; Requirements**

This document (together with the relevant requirements described in TS 28.500, TS 32.101 and TS 32.102) specifies the requirements applicable to Lifecycle Management (LCM) for mobile networks that include virtualized network functions which can be part of EPC or IMS.

2.2.2.285 TS 28.526**Telecommunication management; Life Cycle Management (LCM) for mobile networks that include virtualized network functions; Procedures**

This document specifies the Life Cycle Management (LCM) procedures for mobile networks that include virtualized network functions, which can be part of EPC or IMS.

2.2.2.286 TS 28.527**Telecommunication management; Life Cycle Management (LCM) for mobile networks that include virtualized network functions; Stage 2**

This document is the Life Cycle Management (LCM) stage 2 specification for mobile networks that include virtualized network functions, which can be part of EPC or IMS.

2.2.2.287 TS 28.528**Telecommunication management; Life Cycle Management (LCM) for mobile networks that include virtualized network functions; Stage 3**

This document is the Life Cycle Management (LCM) stage 3 specification for mobile networks that include virtualized network functions, which can be part of EPC or IMS.

2.2.2.288 TS 28.611**Telecommunication management; Evolved Packet Core (EPC) and non-3GPP access interworking system Network Resource Model (NRM) Integration Reference Point (IRP); Requirements**

This document describes the Network Resource Model (NRM) Integration Reference Point (IRP) requirements for the EPC and WLAN interworking system according to the structure defined in 3GPP TS 23.402 (e.g. ePDG, 3GPP AAA, etc).

2.2.2.289 TS 28.612**Telecommunication management; Evolved Packet Core (EPC) and non-3GPP access interworking system Network Resource Model (NRM) Integration Reference Point (IRP); Information Service (IS)**

This document is an Integration Reference Point (IRP) named “Evolved Packet Core (EPC) and non-3GPP access interworking system Network resource Model (NRM) IRP; Information Service (IS)”, through which an 'IRPAgent' (typically an Element Manager or Network Element) can communicate configuration management information to one or several 'IRPManagers' (typically Network Managers) concerning interworking network resources.

This document specifies the semantics and behaviour of Information Object Class (IOC) attributes and relations visible across the reference point in a protocol and technology neutral way. It does not define their syntax and encoding.

It reuses relevant parts of the generic NRM in 3GPP TS 28.622, either by direct reuse or sub-classing, and in addition to that defines specific IOCs in EPC and non-3GPP access interworking systems.

In order to access the information defined by this NRM, an interface IRP is needed, such as the Basic CM IRP IS (3GPP TS 32.602) or the Bulk CM IRP IS (3GPP TS 32.612). However, which interface IRP is applicable is outside the scope of this document.

2.2.2.290 TS 28.616**Telecommunication management; Evolved Packet Core (EPC) and non-3GPP access interworking system Network Resource Model (NRM) Integration Reference Point (IRP); Solution Set (SS) definitions**

This document is part of an Integration Reference Point (IRP) named Evolved Packet Core (EPC) and non-3GPP access Interworking System Network Resource Model (NRM) IRP, through which an IRPAgent can communicate configuration management information to one or several IRPManagers concerning EPC and non-3GPP access interworking system resources. The EPC and non-3GPP access Interworking System NRM IRP comprises a set of specifications defining requirements, a protocol neutral information service and one or more solution sets.

This document specifies the solution sets for the EPC and non-3GPP access interworking system NRM IRP.

This solution set specification is related to 3GPP TS 28.612.

2.2.2.291 TS 28.622**Telecommunication management; Generic Network Resource Model (NRM) Integration Reference Point (IRP); Information Service (IS)**

This document specifies the Generic network resource information that can be communicated between an IRPAgent and an IRPManager for telecommunication network management purposes, including management of converged networks.

This document specifies the semantics of information object class attributes and relations visible across the reference point in a protocol and technology neutral way. It does not define their syntax and encoding.

2.2.2.292 TS 28.680**Telecommunication management; Wireless Local Area Network (WLAN) management; Concepts and requirements**

This document describes the concepts and requirements of WLAN management that focus on WLAN performance monitoring and alarm notifications.

2.2.2.293 TS 28.681**Telecommunication management; Wireless Local Area Network (WLAN) Network Resource Model (NRM) Integration Reference Point (IRP); Requirements**

This document describes the NRM IRP requirements of WLAN management.

2.2.2.294 TS 28.682**Telecommunication management; Wireless Local Area Network (WLAN) Network Resource Model (NRM) Integration Reference Point (IRP); Information Service (IS)**

This document is part of an Integration Reference Point (IRP) named Wireless Local Area Networks (WLAN) Management Network Resource Model (NRM) IRP, through which an IRPAgent can communicate management information to one or several IRPManagers concerning WLAN management. The WLAN management NRM IRP comprises a set of specifications defining Requirements, a protocol neutral Information Service and one or more Solution Set(s).

This document specifies the protocol neutral WLAN management NRM IRP: Information Service (IS).

This document also contains stage 2 descriptions for those functionalities for the WLAN Management.

2.2.2.295 TS 28.683

Telecommunication management; Wireless Local Area Network (WLAN) Network Resource Model (NRM) Integration Reference Point (IRP); Solution Set (SS) definitions

This document is part of an Integration Reference Point (IRP) named Wireless Local Area Network (WLAN) Management Network Resource Model (NRM) IRP, through which an IRPAgent can communicate management information to one or several IRPManagers concerning WLAN management. The WLAN management NRM IRP comprises a set of specifications defining Requirements, a protocol neutral Information Service and one or more Solution Set(s).

This document specifies the Solution Sets for the WLAN NRM IRP.

2.2.2.296 TS 29.002

Mobile Application Part (MAP) specification

It is necessary to transfer between entities of a Public Land Mobile Network (PLMN) information specific to the PLMN in order to deal with the specific behaviour of roaming Mobile Stations (MS)s. The Signalling System No. 7 specified by CCITT is used to transfer this information.

2.2.2.297 TS 29.010

Information element mapping between Mobile Station - Base Station System (MS - BSS) and Base Station System - Mobile-services Switching Centre (BSS - MSC); Signalling Procedures and the Mobile Application Part (MAP).

The scope of this document is:

- to provide a detailed specification for the interworking between information elements contained in layer 3 messages sent on the MS-MSC interface (Call Control and Mobility Management parts of 3GPP TS 24.008) and parameters contained in MAP services sent over the MSC-VLR interface (3GPP TS 29.002) where the MSC acts as a transparent relay of information;
- to provide a detailed specification for the interworking between information elements contained in BSSMAP messages sent on the BSC-MSC interface (3GPP TS 48.008) and parameters contained in MAP services sent over the MSC-VLR interface (3GPP TS 29.002) where the MSC acts as a transparent relay of information;
- to provide a detailed specification for the interworking between information elements contained in BSSMAP messages (3GPP TS 48.008) and RANAP ((3GPP TS 25.413);
- to provide a detailed specification for the interworking as in i) and ii) above when the MSC also processes the information;
- to provide a detailed specification for the interworking between information elements contained in layer 3 messages sent on the MS-SGSN interface (GPRS mobility part of 3GPP TS 24.008) and parameters contained in MAP services sent over the SGSN-HLR interface (3GPP TS 29.002);
- to provide a detailed specification for the interworking between information elements contained in RANAP messages sent on the SGSN-RNC interface (3GPP TS 25.413) and parameters contained in S1AP messages sent on the MME-eNodeB interface (3GPP TS 36.413);

- to provide a detailed specification for the interworking between information elements contained in BSSMAP messages (3GPP TS 48.008) or RANAP messages (3GPP TS 25.413) during SRVCC handovers.

Interworking for supplementary services is given in 3GPP TS 29.011. Interworking for the short message service is given in 3GPP TS 23.040 and 3GPP TS 24.011. Interworking between the call control signalling of 3GPP TS 24.008 and the PSTN/ISDN is given in GSM 09.03, 3GPP TS 29.007 and 3GPP TS 49.008. Interworking between the 'A' and 'E' interfaces for inter-MSC handover signalling is given in 3GPP TS 29.007 and 3GPP TS 49.008.

2.2.2.298 TS 29.011

Signalling Interworking for supplementary services

The scope of this Technical Specification is to provide a detailed specification for interworking between the A interface protocol and the Mobile Application Part for handling of supplementary services. The MAP interfaces of interest are the B-, C-, D- and E-interfaces.

The A-, C-, D- and E-interfaces are physical interfaces while the B-interface is an internal interface defined for modelling purposes. Information relating to the modelling interface is not normative in this specification.

Supplementary service signalling may be passed by the MSC/VLR between the A- and E-interfaces after inter-MSC handover. This procedure is transparent as far as supplementary services are concerned therefore interworking concerning this process is not described in this specification.

2.2.2.299 TS 29.016

General Packet Radio Service (GPRS); Serving GPRS Support Node (SGSN) – Visitors Location Register (VLR); Gs interface network service specification

This document specifies or references the subset of MTP and SCCP which is used for the reliable transport of BSSAP+ messages in the Gs interface. This document references the 3GPP TS 29.202 which specifies alternative transport layers that can be applied instead of the MTP. This document also specifies the SCCP addressing capabilities to be provided in the Gs interface. This document is divided into two main parts, clause 5 dealing with the use of MTP and clauses 6 and 7 dealing with the use of SCCP. Clause 5 of this document deals with the subset of the MTP that is required between an SGSN and a VLR. It is intended that this implementation of MTP is compatible with a full MTP implementation. Clause 4 references the 3GPP TS 29.202 which specifies alternatives to the MTP. The SCCP is used to provide message routing between the SGSN and the VLR. The SCCP routing principles specified in this document allow connecting one SGSN to several VLR. No segmentation at SCCP level is needed on the Gs interface. Only SCCP class 0 is used on the Gs interface. Clauses 6 and 7 identify the SCCP subset that should be used between an SGSN and a VLR.

2.2.2.300 TS 29.018

General Packet Radio Service (GPRS); Serving GPRS Support Node (SGSN) – Visitors Location Register (VLR); Gs interface layer 3 specification

This document specifies or references procedures used on the Serving GPRS Support Node (SGSN) to Visitors Location Register (VLR) interface for interoperability between GSM circuit switched services and GSM packet data services. This document specifies the layer 3 messages and procedures on the Gs interface to allow coordination between databases and to relay certain messages related to GSM circuit switched services over the GPRS subsystem. The functional split between VLR and SGSN is defined in 3GPP TS 23.060. The required procedures between VLR and SGSN are defined in detail in this document.

2.2.2.301 TS 29.060

General Packet Radio Service (GPRS); GPRS Tunnelling Protocol (GTP) across the Gn and Gp interface

This document defines the second version of GTP used on: the Gn and Gp interfaces of the General Packet Radio Service (GPRS); the Iu, Gn and Gp interfaces of the UMTS system.

2.2.2.302 TS 29.061

Interworking between the Public Land Mobile Network (PLMN) supporting packet based services and Packet Data Networks (PDN)

This document defines the requirements for Packet Domain interworking between a:

- a) PLMN and PDN;
- b) PLMN and PLMN.

This document is valid for a PLMN in A/G_b mode as well as for a PLMN in I_u mode. If text applies only for one of these systems it is explicitly mentioned by using the terms “ A/G_b mode” and “ I_u mode”. Please note, that the A interface does not play any role in the scope of this document although the term “ A/G_b mode” is used.

2.2.2.303 TS 29.078

Customized Applications for Mobile network Enhanced Logic (CAMEL) Phase 4; CAMEL Application Part (CAP) specification

This document specifies the CAMEL Application Part (CAP) supporting the fourth phase of the network feature Customized Applications for Mobile network Enhanced Logic. CAP is based on a sub-set of the ETSI Core INAP CS-2 as specified by ETSI EN 301 140-1. Descriptions and definitions provided by ETSI EN 301 140-1 are directly referenced by this standard in the case no additions or clarifications are needed for the use in the CAP.

2.2.2.304 TS 29.079

Optimal media routeing within the IP Multimedia Subsystem (IMS); Stage 3

This document defines optional Optimal Media Routeing (OMR) procedures that can be applied by entities in the IP Multimedia Subsystem (IMS) that control media resources and are capable of manipulating the Session Description Protocol (SDP).

2.2.2.305 TS 29.109

Generic Authentication Architecture (GAA); Zh and Zn Interfaces based on the Diameter protocol; Stage 3

This stage 3 specification defines the Diameter based implementation for bootstrapping Zh interface (BSF-HSS) and Dz interface (BSF-SLF) for HSS resolution for the BSF, the MAP based implementation for bootstrapping Zh' interface (BSF-HLR) and GAA Application Zn interface (BSF-NAF) in Generic Authentication Architecture (GAA). This specification also defines the Web Services based implementation for GAA Application Zn reference point (BSF-NAF). The definition contains procedures, message contents and coding. The procedures for bootstrapping and usage of bootstrapped security association are defined in 3GPP TS 33.220.

This document also specifies the Diameter and Web Services based implementation for the GAA Application Push Function Zpn reference point (BSF-NAF). The procedures for bootstrapping are defined in 3GPP TS 33.223.

This specification is a part of the Generic Authentication Architecture (GAA) specification series.

The diameter based implementation for the Zh interface is based on re-usage of Cx interface Multimedia-Auth-Request/Answer messages originally between CSCF and HSS. These messages are defined in 3GPP TS 29.229. The 3GPP IMS mobility management uses the same definitions between CSCF and HSS. This document defines how the defined messages are used with the bootstrapping and GAA application procedures (e.g. subscriber certificates) and the application logic that is needed in GAA network elements (BSF, HSS, and NAF).

2.2.2.306 TS 29.116

Representational state transfer over xMB reference point between content provider and BM-SC

This document describes the REST-based protocol for the xMB reference point between the Content Provider and the BM-SC. The xMB reference point and related stage 2 protocol procedures are defined in 3GPP TS 23.246 and in 3GPP TS 26.346.

2.2.2.307 TS 29.118

Mobility Management Entity (MME) – Visitor Location Register (VLR) SGs interface specification

CS Fallback in the Evolved Packet System (EPS) enables the provisioning of CS-domain services (e.g. voice call, Location Services (LCS) or supplementary services) by reuse of CS infrastructure when the UE is served by E-UTRAN. Additionally, SMS delivery via the CS core network is realized without CS fallback. This document specifies the procedures and the SGs Application Part (SGsAP) messages used on the SGs interface between the Mobility Management Entity (MME) in the EPS and the Visitor Location Register (VLR), to allow location management coordination and to relay certain messages related to GSM circuit switched services over the EPS system. This document also specifies the use of Stream Control Transmission Protocol (SCTP) for the transport of SGsAP messages.

2.2.2.308 TS 29.119

GPRS Tunnelling Protocol (GTP) specification for Gateway Location Register (GLR)

This document describes the signalling requirements and procedures used at network elements related to the GLR for GTP within the 3GPP system at the application level.

This document gives the description of the systems needed only in the network utilising GLR as the delta document against 3GPP TS 29.060.

2.2.2.309 TS 29.120

Mobile Application Part (MAP) specification for Gateway Location Register (GLR)

This document describes the signalling requirements and procedures used at network elements related to the GLR for MAP within the 3GPP system at the application level.

This document gives the description of the systems needed only in the network utilising GLR as the delta document against 3GPP TS 29.002.

2.2.2.310 TS 29.128

Mobility Management Entity (MME) and Serving GPRS Support Node (SGSN) interfaces for interworking with packet data networks and applications

This document describes the Diameter-based interfaces between the SCEF/IWK-SCEF and other network entities such as MME/SGSN for the Architecture enhancements to facilitate communications with packet data networks and applications.

In particular, this document specifies the T6a interface between the MME and the SCEF, the T6ai interface between the MME and the IWK-SCEF, the T6b interface between the SGSN and the SCEF, the T6bi interface between the SGSN and the SCEF and the T7 interface between the SCEF and the IWK-SCEF. The procedures over those interfaces are defined in 3GPP TS 23.682.

2.2.2.311 TS 29.139

3GPP system - fixed broadband access network interworking; Home (e)Node B - security gateway interface

This document specifies the H(e)NB – SeGW interface. The interface is used for the interworking between a 3GPP system and a Fixed Broadband Access network defined by Broadband Forum. The interworking procedure provides the IP connectivity to a 3GPP UE using a H(e)NB connected to a Fixed Broadband Access network as specified in 3GPP TS 23.139.

The specification covers the QoS aspects and Tunnel management procedures.

2.2.2.312 TS 29.153

Service capability exposure functionality over Ns reference point

This document defines the protocol for Ns reference point between the Service Capability Exposure Function (SCEF) and RAN Congestion Awareness Function (RCAF).

The Ns reference point and related stage 2 procedures are defined in 3GPP TS 23.682.

2.2.2.313 TS 29.154

Service capability exposure functionality over Nt reference point

This document defines the protocol for Nt reference point. The functional requirements and the stage 2 specifications of the Nt reference point are contained in 3GPP TS 23.203. The Nt reference point lies between Service Capability Exposure Function (SCEF) and Policy and Charging Rules Function (PCRF).

2.2.2.314 TS 29.155

Traffic steering control; Representational State Transfer (REST) over St reference point

This document describes the Representational State Transfer (REST) protocol-based St reference point, which is used to provision the traffic steering control information to the TSSF from the PCRF.

2.2.2.315 TS 29.161

Interworking between the Public Land Mobile Network (PLMN) supporting packet based services with Wireless Local Area Network (WLAN) access and Packet data Networks (PDN)

This document defines the requirements for Packet Domain interworking between a PLMN with WLAN access and PDN; and the requirements for Packet Domain interworking between PLMN with WLAN access and PLMN. This document also defines the usage of Radius at the Pp Reference Point between the Packet Data Gateway and the Presence Network Agent.

2.2.2.316 TS 29.162**Interworking between the IM CN subsystem and IP networks**

The IM CN subsystem interworks with the external IP networks through the Mb reference point. This document details the interworking between the IM CN subsystem and external IP networks for IM service support. It addresses the issues of control plane interworking and, user plane interworking for specific interworking use cases.

2.2.2.317 TS 29.163**Interworking between the IP Multimedia (IM) Core Network (CN) subsystem and Circuit Switched (CS) networks**

This document specifies the principles of interworking between the 3GPP IM CN subsystem and BICC/ISUP based legacy CS networks, in order to support IM basic voice, data and multimedia calls. This document addresses the areas of control and user plane interworking between the IM CN subsystem and CS networks through the network functions, which include the MGCF and IM-MGW. For the specification of control plane interworking, areas such as the interworking between SIP and BICC or ISUP are detailed in terms of the processes and protocol mappings required for the support of both IM originated and terminated voice and multimedia calls. Other areas addressed encompass the transport protocol and signalling issues for negotiation and mapping of bearer capabilities and QoS information.

2.2.2.318 TS 29.164**Interworking between the 3GPP CS domain with BICC or ISUP as signalling protocol and external SIP-I networks**

This specification defines interworking procedures between a 3GPP CS domain which applies either BICC or ISUP as signalling protocol, and external networks that use SIP-I as signalling protocol. The document also describes the related interworking architecture. This specification also defines stage 2 procedures for the control of the MGW.

2.2.2.319 TS 29.165**Inter-IMS Network to Network Interface (NNI)**

The objective of this document is to address the Inter-IMS Network to Network Interface (II-NNI) consisting of Ici and Izi reference points between IMS networks in order to support end-to-end service interoperability. This document will address the issues related to control plane signalling (3GPP usage of SIP and SDP protocols, required SIP headers) as well as other interconnecting aspects like security, numbering/naming/addressing and user plane issues as transport protocol, media and codecs actually covered in a widespread set of 3GPP specifications. A profiling of the Inter-IMS Network to Network Interface (II-NNI) is also provided.

2.2.2.320 TS 29.168**Cell Broadcast Centre interfaces with the Evolved Packet Core; Stage 3**

This document specifies the procedures and the SBc Application Part (SBc-AP) messages used on the SBc-AP interface between the Mobility Management Entity (MME) and the Cell Broadcast Centre (CBC). This document supports the following functions. Warning Message Transmission function in the EPS.

2.2.2.321 TS 29.171**Location Services (LCS); LCS Application Protocol (LCS-AP) between the Mobile Management Entity (MME) and Evolved Serving Mobile Location Centre (E-SMLC); SLs interface**

This document specifies the procedures and information coding for LCS Application Protocol (LCS-AP) that is needed to support the location services in E-UTRAN. The LCS-AP message set is applicable to the SLs interface between the E-SMLC and the MME. LCS-AP is developed in accordance to the general principles stated in 3GPP TS 23.271.

2.2.2.322 TS 29.172**Location Services (LCS); Evolved Packet Core (EPC) LCS Protocol (ELP) between the Gateway Mobile Location Centre (GMLC) and the Mobile Management Entity (MME); SLg interface**

This document specifies the procedures and information coding for the EPC LCS Protocol (ELP) that is needed to support the location services in E-UTRAN. The ELP message set is applicable to the SLg interface between the MME and the GMLC. ELP is developed in accordance to the general principles stated in 3GPP TS 23.271.

2.2.2.323 TS 29.173**Location Services (LCS); Diameter-based SLh interface for Control Plane LCS**

This document describes the Diameter-based SLh interface between the GMLC and the HSS defined for the Control Plane LCS in EPC.

2.2.2.324 TS 29.201**Representational State Transfer (REST) reference point between Application Function (AF) and Protocol Converter (PC)**

This document describes the Representational State Transfer (REST) reference point, which is used to exchange application level session information between the Protocol Converter (PC) and the Application Function (AF). REST shall be used as an architectural style as appropriate.

2.2.2.325 TS 29.202**Signalling system No. 7 (SS7) signalling transport in core network; Stage 3**

This document defines the possible protocol architectures for transport of SS7 signalling protocols in Core Network.

2.2.2.326 TS 29.204**Signalling System No. 7 (SS7) security gateway; Architecture, functional description and protocol details**

This specification provides functional description of the SS7 Security Gateway. The document covers also network architecture, routing considerations, and protocol details.

2.2.2.327 TS 29.205**Application of Q.1900 series to bearer-independent Circuit Switched (CS) core network architecture; Stage 3**

This document describes the protocols to be used when ITU-T Q.1902 "Bearer Independent Call Control" is used as call control protocol in a 3GPP Bearer Independent CS core network

3GPP TS 23.205. The Q.1902 operates between (G)MSC servers. The BICC architecture as described in ITU-T Q.1902 consists of a number of protocols. The following types of protocols are described: call control protocol, bearer control protocols and a resource control protocol for this architecture. The architecture complies with the requirements imposed by 3GPP TS 23.205 and TS 23.153.

2.2.2.328 TS 29.212

Policy and charging control (PCC); Reference points

This document provides the protocol specification related to the Gx, Gxx and Sd reference points.

2.2.2.329 TS 29.213

Policy and charging control signalling flows and Quality of Service (QoS) parameter mapping

This specification adds detailed flows of Policy and Charging Control over the Rx and Gx reference points and their relationship with the bearer level signalling flows over the Gn interface. This specification also describes the binding and the mapping of QoS parameters among SDP, UMTS QoS parameters, and QoS authorization parameters.

2.2.2.330 TS 29.214

Policy and charging control over Rx reference point

This specification provides the stage 3 specification of the Rx reference point that lies between the application function and the policy and charging rule function.

2.2.2.331 TS 29.215

Policy and Charging Control (PCC) over S9 reference point; Stage 3

This document provides the stage 3 specification of the S9 reference point for this release. The functional requirements of stage 2 specification for the S9 reference point are contained in 3GPP TS 23.203. The S9 reference point lies between the PCRF in the home PLMN (also known as H-PCRF) and the PCRF in the visited PLMN (also known as V-PCRF). Whenever it is possible this document specifies the requirements for the protocols by reference to specifications produced by the IETF within the scope of Diameter. Where this is not possible extensions to Diameter are defined within this document.

2.2.2.332 TS 29.217

Policy and Charging Control (PCC); Congestion reporting over Np reference point

This document provides the stage 3 specification of the Np reference point. The functional requirements and the stage 2 specifications of the Np reference point are contained in 3GPP TS 23.203. The Np reference point lies between the RAN Congestion Awareness Function (RCAF) and the Policy and Charging Rules Function (PCRF) for the non-roaming case, between the RCAF and the H-PCRF for the home-routed scenario and between the RCAF and the V-PCRF for the visited access scenario.

2.2.2.333 TS 29.219

Policy and charging control: Spending limit reporting over Sy reference point

This document provides the protocol specification related to the Sy reference point. The Sy reference point lies between the Policy and Charging Rule Function (PCRF) and the Online Charging System (OCS). It enables transfer of policy counter status information relating to subscriber spending from OCS to PCRF.

2.2.2.334 TS 29.228**IP Multimedia (IM) Subsystem Cx and Dx Interfaces; Signalling flows and message contents**

This 3GPP technical specification (TS) specifies the interactions between the HSS (Home Subscriber Server) and the CSCF (Call Session Control Functions), referred to as the Cx interface, and the interactions between the CSCF and the SLF (Server Locator Function), referred to as the Dx interface.

2.2.2.335 TS 29.229**Cx and Dx interfaces based on the Diameter protocol; Protocol details**

This specification defines a transport protocol for use in the IP multimedia (IM) Core Network (CN) subsystem based on Diameter.

2.2.2.336 TS 29.230**Diameter applications; 3GPP specific codes and identifiers**

This document lists the 3GPP specific Diameter protocol codes, including the AVP codes and Experimental result codes. This document lists also the application identifiers assigned to 3GPP specific Diameter applications by IANA and the Diameter command code range which is assigned to 3GPP by IANA.

2.2.2.337 TS 29.231**Application of SIP-I Protocols to Circuit Switched (CS) core network architecture; Stage 3**

This specification describes the protocols to be used when SIP-I is optionally used as call control protocol in a 3GPP CS core network on Nc interface. The SIP-I protocol operates between (G)MSC servers. The SIP-I architecture consists of a number of protocols. The following types of protocols are described: call control protocol, resource control protocols and user plane protocol for this architecture.

2.2.2.338 TS 29.232**Media Gateway Controller (MGC) – Media Gateway (MGW) interface; Stage 3**

This document describes the protocol to be used on the Media Gateway Controller (MGC) – Media Gateway (MGW) interface. The Media Gateway Controllers covered in this specification are the MSC server and the GMSC server. The basis for this interface profile is the H.248.1 protocol as specified in ITU-T.

2.2.2.339 TS 29.235**Interworking between SIP-I based circuit-switched core network and other networks**

This specification defines the interworking between SIP-I based circuit-switched core network with out-of-band transcoder control related procedures and:

- an external SIP-I based signalling network;
- an ISUP based network such as an ISUP based 3GPP CS Domain or an PSTN;
- an BICC based network such as an BICC based 3GPP CS Domain;
- an Internet Multimedia Subsystem.

2.2.2.340 TS 29.238**Interconnection Border Control Functions (IBCF) – Transition Gateway (TrGW) interface; Ix interface; Stage 3**

This document describes the protocol to be used on the Interconnection Border Control Function (IBCF) – Transition Gateway (TrGW) interface and the CS-IBCF – CS-TrGW interface. The basis for this protocol is the H.248 protocol as specified in ITU-T.

2.2.2.341 TS 29.244**Interface between the Control plane and the User Plane of EPC Nodes**

This document specifies the Packet Forwarding Control Protocol (PFCP) used on the interface between the control plane and the user plane function in a split SGW, PGW and TDF architecture in EPC.

The architecture reference model and stage 2 information are specified in 3GPP TS 23.214.

PFCP shall be used over the Sxa, Sxb, Sxc and the combined Sxa/Sxb reference points.

PFCP shall also be used over the Sxa' and Sxb' reference points specified in 3GPP TS 33.107. In the rest of this specification, no difference is made between Sxa and Sxa', or between Sxb and Sxb'. The Sxa' and Sxb' reference points reuse the protocol specified for the Sxa and Sxb reference points, but comply in addition with the security requirements specified in clause 8 of 3GPP 33.107.

2.2.2.342 TS 29.250**Nu reference point between SCEF and PFDF for sponsored data connectivity**

This document provides the stage 3 specification of the Nu reference point. The functional requirements and the stage 2 specifications of the Nu reference point are specified in 3GPP TS 23.682. The Nu reference point lies between the Packet Flow Description Function (PFDF) and the Service Capability Exposure Function (SCEF).

2.2.2.343 TS 29.251**Gw and Gwn reference point for sponsored data connectivity**

This document provides the stage 3 specification of the Gw and Gwn reference points. The functional requirements and the stage 2 specifications of the Gw and Gwn reference points are specified in 3GPP TS 23.203. The Gw reference point lies between the Packet Flow Description Function (PFDF) and the Policy and Charging Enforcement Function (PCEF). The Gwn reference point lies between the Packet Flow Description Function (PFDF) and the Traffic Detection Function (TDF).

2.2.2.344 TS 29.272**Evolved Packet System (EPS); Mobility Management Entity (MME) and Serving GPRS Support Node (SGSN) related interfaces based on Diameter protocol**

This document describes the Mobility Management Entity (MME) and Serving GPRS Support Node (SGSN) related diameter-based interfaces towards the Home Subscriber Server (HSS), and the MME and the SGSN related diameter-based interface towards the Equipment Identity Register (EIR).

2.2.2.345 TS 29.273**Evolved Packet System (EPS); 3GPP EPS AAA interfaces**

This document defines the stage-3 protocol description for several reference points for the non-3GPP access in EPS.

2.2.2.346 TS 29.274**3GPP Evolved Packet System (EPS); Evolved General Packet Radio Service (GPRS) Tunnelling Protocol for Control plane (GTPv2-C); Stage 3**

This document specifies the stage 3 of the control plane of the GPRS Tunnelling Protocol, Version 2 for Evolved Packet System interfaces (GTPv2-C). In this document, unless otherwise specified the S5 interface refers always to “GTP-based S5” and S8 interface refers always to “GTP-based S8” interface.

2.2.2.347 TS 29.275**Proxy Mobile IPv6 (PMIPv6) based Mobility and Tunnelling protocols; Stage 3**

This document specifies the stage 3 of the PMIPv6 Based Mobility and Tunnelling Protocols used over the PMIP-based S2a, S2b, S5, and S8 reference points defined in 3GPP TS 23.402, and are thus applicable to the Serving GW, PDN Gateway, ePDG, and Trusted Non-3GPP Access. Protocols specifications are compliant with relevant IETF RFCs. In this specification PMIP refers to PMIPv6 as defined in IETF RFC5213.

2.2.2.348 TS 29.276**3GPP Evolved Packet System (EPS); Optimized handover procedures and protocols between E-UTRAN access and cdma2000 HRPD Access; Stage 3**

This document specifies the stage 3 of the Evolved Packet System S101 interface between the MME and the HRPD Access Network. The S101 interface supports procedures for Pre-Registration, Session Maintenance and Active handoffs between E-UTRAN and HRPD networks.

2.2.2.349 TS 29.277**Optimised handover procedures and protocol between EUTRAN access and non-3GPP accesses (S102); Stage 3**

This document specifies the stage 3 of the Evolved Packet System S102 interface between the MME and the 1x CS IWS to relay the 1xCS signalling messages documented in 3GPP TS 23.216 and 3GPP TS 23.272. 1x CS signalling messages are those messages that are defined for A21 interface as described in 3GPP2 A.S0008-D and 3GPP2 A.S0009-D. The S102 interface messages shall be based on A21 messages.

The S102 interface is used to support UEs that do not transmit and receive on both the LTE and 1x radio interfaces simultaneously. S102 protocol aspects for SRVCC from E-UTRAN access to 3GPP2 1xCS is covered in this specification. Handling of non-voice component and protocol aspects for SRVCC from 3GPP2 1xCS to E-UTRAN direction is not specified in this release.

The S102 interface is also used to support CS fallback to 1xRTT procedures from E-UTRAN access to CDMA 1x RTT CS domain and to support SMS over S102 with the CDMA 1xRTT CS domain through support of registration over EPS procedures as specified in 3GPP TS 23.272.

2.2.2.350 TS 29.278**Customized Applications for Mobile network Enhanced Logic (CAMEL) Phase 4; CAMEL Application Part (CAP) specification for IP Multimedia Subsystems (IMS)**

This document specifies the CAMEL Application Part (CAP) supporting the fourth phase of the network feature Customized Applications for Mobile network Enhanced Logic for IP Multimedia CN subsystems. CAP is based on a sub-set of the ETSI Core INAP CS-2 as specified by ETSI

EN 301 140-1. Descriptions and definitions provided by ETSI EN 301 140-1 are directly referenced by this standard in case no additions or clarifications are needed for the use in the CAP.

2.2.2.351 TS 29.279

Mobile IPv4 (MIPv4) based mobility protocols; Stage 3

This document specifies the stage 3 of the MIPv4 Based Mobility Protocol used over the S2a reference point defined in 3GPP TS 23.402, and is thus applicable to the PDN Gateway and Trusted Non-3GPP Access. Protocol specification is compliant with relevant IETF RFCs.

2.2.2.352 TS 29.280

Evolved Packet System (EPS); 3GPP Sv interface (MME to MSC, and SGSN to MSC) for SRVCC

This document describes the Sv interface between the Mobility Management Entity (MME) or Serving GPRS Support Node (SGSN) and 3GPP MSC server enhanced for SRVCC. Sv interface is used to support Inter-RAT handover from VoIP/IMS over EPS to CS domain over 3GPP UTRAN/GERAN access or from UTRAN (HSPA) to 3GPP UTRAN/GERAN access.

2.2.2.353 TS 29.281

General Packet Radio System (GPRS) Tunnelling Protocol User Plane (GTPv1-U)

This document defines the user plane of GTP used on:

- the Gn and Gp interfaces of the General Packet Radio Service (GPRS);
- the Iu, Gn and Gp interfaces of the UMTS system;
- the S1-U, X2, S4, S5, S8 and S12 interfaces of the Evolved Packet System (EPS).

2.2.2.354 TS 29.282

Mobile IPv6 vendor specific option format and usage within 3GPP

This document specifies the format and usage of the Mobile IPv6 Vendor Specific Option within the Third Generation Partnership Project.

2.2.2.355 TS 29.283

Diameter data management applications

The common functional architecture for support of Mission Critical (MC) services is specified in 3GPP TS 23.280.

The functional architecture for support of Mission Critical Push To Talk (MCPTT) services is specified in 3GPP TS 23.379.

The functional architecture for support of Mission Critical Video (MCVideo) services is specified in 3GPP TS 23.281.

The functional architecture for support of Mission Critical Data (MCData) services is specified in 3GPP TS 23.282.

This 3GPP Technical Specification (TS) specifies:

- 1 The interactions between the MC Service User Database and the MC Service Server:
 - This interface between the MCPTT User Database and the MCPTT Server is referred to as the MCPTT-2 reference point, as specified in 3GPP TS 23.379.

- This interface between the MCVideo User Database and the MCVideo Server is referred to as the MCVideo-2 reference point, as specified in 3GPP TS 23.281.
 - This interface between the MCDData User Database and the MCDData Server is referred to as the MCDData-2 reference point, as specified in 3GPP TS 23.282.
 - This interface between the MCDData User Database and the MCDData Server is referred to as the MCVideo-2 reference point, as specified in 3GPP TS 23.282.
- The interactions between the MC Service User Database and the Configuration Management Server. This interface is referred to as the CSC-13 reference point.

2.2.2.356 TS 29.292

Interworking between the IP Multimedia (IM) Core Network (CN) subsystem (IMS) and MSC Server for IMS Centralized Services (ICS)

IMS Centralized Services (ICS) enable the delivery of IM CN subsystem based multimedia telephony and supplementary services as defined in 3GPP TS 24.173 to users regardless of the attached access network type; e.g. CS domain access or IP-CAN.

This document specifies the principles of interworking between the IM CN subsystem and CS domain in order to enable ICS for UEs using CS domain access. This document addresses the area of registration procedures interworking between the CS domain and IM CN subsystem. This document addresses the areas of control and user plane interworking between the IM CN subsystem and CS domain through an MSC Server enhanced for ICS and CS-MGW respectively. This includes the signalling procedures between the MSC Server and CS-MGW. For the specification of control plane interworking, present document defines the protocol interworking between the 3GPP profile of SIP as described in 3GPP TS 24.229 and NAS signalling as described in 3GPP TS 24.008 required for the support of IM CN subsystem based multimedia telephony and supplementary services.

2.2.2.357 TS 29.303

Domain Name System Procedures; Stage 3

This document describes Domain Name System (DNS) Procedures for the Evolved Packet System. This document covers the Evolved Packet Core gateway node selection using DNS (e.g. SGW and PGW nodes) excluding all User Equipment (UE) initiated DNS-based discovery and selection procedures.

2.2.2.358 TS 29.305

InterWorking Function (IWF) between MAP based and Diameter based interfaces

This document is to specify the InterWorking Functions (IWF):

- between MAP-based Gr, Gf interfaces and Diameter-based S6a, S6d, S13, S13a interfaces;
- between the S6a interface with SMS subscription data on the MME side and the S6a interface without SMS subscription data plus the MAP-based D interface for SMS subscription on the HSS side;
- between the S6a interface with SMS subscription data on the MME side and the S6a interface without SMS subscription data plus the MAP-based D interface for SMS subscription on the HSS side;
- between MAP-based C for SMS interface and Diameter-based S6c interface;
- between MAP-based E for SMS interface and Diameter-based SGd interface.

2.2.2.359 TS 29.311

Service level interworking for messaging services

This document specifies the protocol details of service level interworking between Instant Message as specified in OMA-TS-SIMPLE_IM using the 3GPP IP Multimedia CN subsystem and the Short Message Service over both legacy CS/PS network as specified in the 3GPP TS 23.040 and a generic IP Connectivity Access Network (IP-CAN) as specified in the 3GPP TS 24.341. These include:

- procedures to implement service level interworking between IM and SM;
- procedures to implement service level interworking between CPM and SM;
- enhancement of the IP-SM-GW as an Application Server to support service selection, authorization and mapping between IM and SM protocols;
- interaction between service level interworking and transport layer interworking.

2.2.2.360 TS 29.328

IP Multimedia (IM) Subsystem Sh interface; Signalling flows and message contents

This 3GPP technical specification (TS) specifies: The interactions between the HSS (Home Subscriber Server) and the SIP AS (Application Server) and between the HSS and the OSA SCS (Service Capability Server). This interface is referred to as the Sh reference point. The interactions between the SIP AS and the SLF (Subscription Locator Function) and between the OSA SCS and the SLF. This interface is referred to as the Dh reference point.

2.2.2.361 TS 29.329

Sh interface based on the Diameter protocol; Protocol details

This document defines a transport protocol for use in the IP multimedia (IM) Core Network (CN) subsystem based on Diameter. This document is applicable to:

- The Sh interface between an AS and the HSS.
- The Sh interface between an SCS and the HSS.

Whenever it is possible this document specifies the requirements for this protocol by reference to specifications produced by the IETF within the scope of Diameter. Where this is not possible, extensions to Diameter are defined within this document.

2.2.2.362 TS 29.333

Multimedia Resource Function Controller (MRFC) – Multimedia Resource Function Processor (MRFP) Mp interface; Stage 3

This document describes the protocol to be used on the Multimedia Resource Function Controller (MRFC) – Multimedia Resource Function Processor (MRFP) interface (Mp interface). The IMS architecture is described in 3GPP TS 23.228, the functional requirements are described in 3G TS 23.333. This specification defines a profile of the Gateway Control Protocol (H.248.1), for controlling Multimedia Resource Function Processor supporting in-band user interaction, conferencing and transcoding for multimedia-services. This document is valid for a 3rd generation PLMN (UMTS) complying with Release 7 and later.

2.2.2.363 TS 29.334**IMS Application Level Gateway (IMS-ALG) – IMS Access Gateway (IMS-AGW); Iq Interface; Stage 3**

This document describes the protocol to be used on the IMS Application Level Gateway (ALG) – IMS Access Gateway (IMS-AGW) interface. The basis for this protocol is the H.248 protocol as specified in ITU-T. The IMS architecture is described in 3GPP TS 23.228.

2.2.2.364 TS 29.335**User Data Convergence (UDC); User data repository access protocol over the Ud interface; Stage 3**

This document describes the stage 3 user data repository access protocol over Ud interface.

2.2.2.365 TS 29.336**Home Subscriber Server (HSS) diameter interfaces for interworking with packet data networks and applications**

This document describes the Diameter-based interfaces between the HSS and other network elements involved in the architecture for interworking with packet data networks and applications, such as Machine-Type Communications (MTC).

In particular, this document specifies the S6m interface between the Home Subscriber Server (HSS) and the MTC Interworking Function (MTC-IWF) and the S6n interface between the HSS and the MTC-AAA. The procedures over those interfaces are defined in 3GPP TS 23.682.

2.2.2.366 TS 29.337**Diameter-based T4 Interface for communications with packet data networks and applications**

This document describes the Diameter based interface between the Machine Type Communications-InterWorking Function (MTC-IWF) and the Short Message Service-Service Centre (SMS-SC) for communications with packet data networks and applications.

This specification defines the Diameter application for the T4 reference point between the MTC-IWF and the SMS-SC. The interactions between the MTC-IWF and the SMS-SC are specified.

The stage 2 description for communications with packet data networks and applications (architecture and functionality) is specified in the 3GPP TS 23.682.

2.2.2.367 TS 29.338**Diameter based protocols to support Short Message Service (SMS) capable Mobile Management Entities (MMEs)**

This document defines the Diameter-based interfaces specific to SMS when they are used in conjunction with the “SMS in MME” architecture specified in 3GPP TS 23.272. It comprises:

- the Diameter application for the S6c interface between the HSS and the SMS-GMSC or the SMS Router and between the SMS-GMSC and the SMS Router;
- the Diameter application for the SGd interface between the MME and the SMS-IW MSC or the SMS-GMSC or the SMS Router and between the SMS-GMSC and the SMS Router.

2.2.2.368 TS 29.343**Proximity-services (ProSe) function to ProSe application server aspects (PC2); Stage 3**

This document provides the stage 3 specification of the PC2 reference point. The functional requirements and the stage 2 procedures of the PC2 reference point are contained in 3GPP TS 23.303. The PC2 reference point lies between the ProSe Function and ProSe Application Server.

2.2.2.369 TS 29.344

Proximity-services (ProSe) function to Home Subscriber Server (HSS) aspects; Stage 3

This document describes the Diameter-based PC4a interface between the Proximity Services (ProSe) Function and the Home Subscriber Server (HSS) defined for ProSe services.

This specification defines the Diameter application for PC4a reference point between the ProSe Function and the HSS. The interactions between the ProSe Function and the HSS are specified.

The stage 2 description for Proximity Services (ProSe) features in EPS is specified in 3GPP TS 23.303.

2.2.2.370 TS 29.345

Inter-Proximity-services (ProSe) function signalling aspects; Stage 3

This document describes the Diameter-based interfaces between the Proximity Services (ProSe) Function in the HPLMN and the ProSe Function in a local PLMN (PC6 interface) or between the Proximity Services (ProSe) Function in the HPLMN and the ProSe Function in a visited PLMN (PC7 interface).

This specification defines the Diameter application for PC6/PC7 reference points between the ProSe Functions. The interactions between the ProSe Functions are specified.

The stage 2 description for Proximity Services (ProSe) features in EPS is specified in 3GPP TS 23.303.

2.2.2.371 TS 29.364

IP Multimedia Subsystem (IMS) Application Server (AS) service data descriptions for AS interoperability

This specification standardizes the structure and the coding of the service data that are transported over the Sh interface between an Application Server supporting Multimedia Telephony supplementary services as defined in 3GPP TS 22.173 and the HSS. Two optional formats are specified. One is based on a binary coding of the service data and supports the subset of MMTEL services corresponding to PSTN/ISDN and CS supplementary services. The other uses an XML format and supports the full set of MMTEL services.

2.2.2.372 TS 29.368

Tsp interface protocol between the MTC Interworking Function (MTC-IWF) and Service Capability Server (SCS)

This document provides the protocol specification related to the Tsp reference point which is part of the architecture for Machine Type Communication. The Tsp reference point lies between the Service Capability Server (SCS) and the Machine Type Communication Inter Working Function (MTC-IWF).

2.2.2.373 TS 29.388

V2X Control Function to Home Subscriber Server (HSS) aspects (V4); Stage 3

This document describes the Diameter-based V4 interface between the V2X Control Function and the Home Subscriber Server (HSS) defined for V2X services.

This specification defines the Diameter application for V4 reference point between the V2X Control Function and the HSS. The interactions between the V2X Control Function and the HSS are specified.

The stage 2 description for V2X service features in EPS is specified in 3GPP TS 23.285.

2.2.2.374 TS 29.389

Inter-V2X Control Function Signalling aspects (V6); Stage 3

This document describes the Diameter-based interfaces between the V2X Control Function in the HPLMN and the V2X Control Function in the VPLMN (V6 interface).

This specification defines the Diameter application for V6 reference points between the V2X Control Functions. The interactions between the V2X Control Functions are specified.

The stage 2 description for V2X service features in EPS is specified in 3GPP TS 23.285.

2.2.2.375 TS 29.405

Nq and Nq' Application Protocol (Nq-AP); Stage 3

This document specifies the procedures and the Nq and Nq' Application Protocol (Nq-AP) messages used on the Nq/Nq' interfaces between the RAN Congestion Awareness Function (RCAF) and the Mobility Management Entity (MME) or the Serving GPRS Support Node (SGSN). The related stage 2 requirements are specified in 3GPP TS 23.401 and 3GPP TS 23.060.

2.2.2.376 TS 29.468

Group Communication System Enablers for LTE (GCSE_LTE); MB2 reference point; Stage 3

This document defines the protocol for the MB2 reference point between the Group Communication Service Application Server (GCS AS) and the Broadcast-Multicast Service Centre (BM-SC).

The MB2 reference point and related stage 2 procedures are defined in 3GPP TS 23.468 as part of the Group Communication System Enablers for LTE. The stage 1 requirements for Group Communication System Enablers for LTE are specified in 3GPP TS 22.468.

2.2.2.377 TS 29.658

SIP Transfer of IP Multimedia Service Tariff Information; Protocol specification

This document specifies the protocol for the real-time transfer of Tariff Information between a Charge Determination Point (CDP) and a Charge Generation Point (CGP) by means of the Session Initiation Protocol (SIP).

It identifies the protocol procedures and switching functions needed to support the transfer of tariff information related to IP multimedia services.

2.2.2.378 TS 31.101

UICC-terminal interface; Physical and logical characteristics

This specification specifies the interface between the UICC and the Terminal for 3G and beyond telecom network operation. This includes the requirements for the physical characteristics of the UICC, the electrical interface between the UICC and the Terminal, the initial communication establishment and the transport protocols, the communication commands and the procedures and the application independent files and protocols.

2.2.2.379 TS 31.102**Characteristics of the Universal Subscriber Identity Module (USIM) application**

This specification defines the USIM application for 3G and beyond telecom network operation. This specification specifies command parameters, file structures and content, security functions and the application protocol to be used on the interface between UICC (USIM) and ME.

2.2.2.380 TS 31.103**Characteristics of the IP Multimedia Services Identity Module (ISIM) application**

This specification defines the ISIM application for 3G and beyond telecom network operation. This specification specifies command parameters, file structures and content, security functions and the application protocol to be used on the interface between UICC (ISIM) and ME.

2.2.2.381 TS 31.104**Characteristics of the Hosting Party Subscription Identity Module (HPSIM) application**

This document defines the Hosting Party Subscription Identity Module (HPSIM) application. This application resides on the UICC, an IC card specified in 3GPP TS 31.101.

3GPP TS 31.104 applies to a H(e)NB supporting the HPSIM for H(e)NB Hosting Party authentication and specifies:

- identification of the Hosting Party;
- security mechanism, e.g. authentication based on EAP-AKA method.

2.2.2.382 TS 31.111**Universal Subscriber Identity Module (USIM) Application Toolkit (USAT)**

This specification defines the interface between the UICC and the Mobile Equipment (ME), and mandatory ME procedures, specifically for “USIM Application Toolkit”. USAT is a set of commands and procedures for use during the network operation phase of 3G and beyond, in addition to those defined in TS 31.101.

2.2.2.383 TS 31.115**Secured packet structure for (Universal) Subscriber Identity Module (U)SIM Toolkit applications**

This specification specifies the structure of the Secured Packets in implementations using Short Message Service and Cell Broadcast Service. It is applicable to the exchange of secured packets between an entity in a 3G and beyond or GSM PLMN and an entity in the (U)SIM.

2.2.2.384 TS 31.116**Remote APDU Structure for (Universal) Subscriber Identity Module (U)SIM Toolkit applications**

This specification defines the remote management of files and applets on the SIM/USIM.

2.2.2.385 TS 31.130**(U)SIM Application Programming Interface (API); (U)SIM API for Java Card**

This specification defines the (U)SIM Application Programming Interface extending the “UICC API for Java Card™”. This API allows development of a (U)SAT application running together with a (U)SIM application and using GSM/3G and beyond network features.

2.2.2.386 TS 31.133**IP Multimedia Services Identity Module (ISIM) Application Programming Interface (API); ISIM API for Java Card™**

This specification defines the ISIM Application Programming Interface extending the “UICC API for Java Card™”. This API allows development of an application running together with an ISIM application. This document includes information applicable to network operators, service providers, server, ISIM and database manufacturers.

2.2.2.387 TS 31.220**Characteristics of the Contact Manager for 3GPP UICC applications**

This specification defines the Contact Manager for 3GPP UICC applications based on OMA DS, also specifies the external interface between the Contact Manager Server in the UICC and the Contact Manager External Client in the ME.

2.2.2.388 TS 31.221**Contact Manager Application Programming Interface (API); Contact Manager API for Java Card**

This specification defines the Application Programming Interface for the Contact Manager for 3GPP UICC applications, as specified in TS 31.220. This API allows development of applications running together with a contact manager application.

2.2.2.389 TS 32.101**Telecommunication management; Principles and high-level requirements**

This document establishes and defines the management principles and high-level requirements for the management of PLMNs. In particular, this document identifies the requirements for:

- the upper level of a management system;
- the reference model, showing the elements the management system interacts with;
- the network operator processes needed to run, operate and maintain a network;
- the functional architecture of the management system;
- the principles to be applied to management interfaces.

The requirements identified in this document are directed to the further development of management specifications as well as the development of management products. This document can be seen as guidance for the development of all other technical specifications addressing the management of PLMNs.

2.2.2.390 TS 32.102**Telecommunication management; Architecture**

This document identifies and standardizes the most important and strategic contexts in the physical architecture for the management of PLMNs. It serves as a framework to help define a telecom management physical architecture for a planned PLMN and to adopt standards and provide products that are easy to integrate. The requirements identified in this document are applicable to all further development of 3GPP Telecom Management specifications as well as the development of PLMN Management products. This document can be seen as guidance for the development of all other technical specifications addressing the management of PLMNs, except TS 32.101.

2.2.2.391 TS 32.103

Telecommunication management; Integration Reference Point (IRP) overview and usage guide

This document gives an overview about 3GPP's management interface capabilities and related functionality. It provides high-level information about IRP Framework, available IRPs as well as their relationship with each other. This document is intended to be a guide into the world of 3GPP management specifications, enabling also non-subject matter experts to gain an understanding about 3GPP's management solutions.

It also provides IRP packaging suggestions, intended to guide service providers as well as equipment and solutions providers to identify and choose suitable standardized management interface capabilities.

2.2.2.392 TS 32.150

Telecommunication management; Integration Reference Point (IRP) Concept and definitions

This document provides the overall concept for all Integration Reference Point (IRP) specifications. Relevant IRP overview and high-level definitions are already provided in 3GPP TS 32.101 and TS 32.102. IRP specifications are intended to be applicable to any management interface developed in 3GPP SA5.

2.2.2.393 TS 32.253

Telecommunication management; Charging management; Control Plane (CP) data transfer domain charging

This document is part of a series of documents that specify charging functionality and charging management in GSM/UMTS/LTE networks. The GSM/UMTS/LTE core network charging architecture and principles are specified in TS 32.240, which provides an umbrella for other charging management TSs that specify:

- the content of the CDRs per domain / subsystem / service (offline charging);
- the content of real-time charging messages per domain / subsystem / service (online charging);
- the functionality of online and offline charging for those domains / subsystems / services;
- the interfaces that are used in the charging framework to transfer the charging information (i.e. CDRs or charging events).

The complete document structure for these TSs is defined in TS 32.240.

This document specifies the offline and online charging description for Control Plane (CP) data transfer domain, based on the functional stage 2 description in TS 23.682 for Non-IP Data Delivery (NIDD) using SCEF procedures. This charging description includes the offline and online charging architecture and scenarios specific to Control Plane (CP) data transfer domain, as well as the mapping of the common 3GPP charging architecture specified in TS 32.240 onto the Control Plane (CP) data transfer domain. It further specifies the structure and content of the CDRs for offline charging. This document is related to other 3GPP charging TSs as follows:

- The common 3GPP charging architecture is specified in TS 32.240.
- The parameters, abstract syntax and encoding rules for the CDRs are specified in TS 32.298.
- A transaction based mechanism for the transfer of CDRs within the network is specified in TS 32.295.
- The file based mechanism used to transfer the CDRs from the network to the operator's billing domain (e.g. the billing system or a mediation device) is specified in TS 32.297.

- The 3GPP Diameter application that is used for Control Plane (CP) data transfer domain offline and online charging is specified in TS 32.299.

Control Plane (CP) data transfer is also provided by Short Message Service (SMS), for which charging functionalities are not specified in this document. SMS charging functionality is defined for Circuit Switched domain in TS 32.250, for Packet Switched domain in TS 32.251 and for SMS Nodes in TS 32.274.

2.2.2.394 TS 32.276

Telecommunication management; Charging management; Voice Call Service (VCS) charging

This document is part of a series of documents that specify charging functionality and charging management in GSM/UMTS networks. The GSM/UMTS core network charging architecture and principles are specified in TS 32.240, which provides an umbrella for other charging management TSs.

This document specifies the online charging description for Voice Call Service (VCS) charging from a Proxy Function, based on the functional description of the Voice Call Service charging in the EU Roaming Regulations III specifications.

The concept of voice call is interpreted as any CS call, whatever the teleservice used (speech, 3.1 kHz audio, Fax, or CS data) except CS video telephony calls (BS 37, 64 kbit/s unrestricted digital info mode).

Voice over LTE is not included in this definition. This charging specification includes the online charging architecture and scenarios specific to VCS charging from a Proxy Function, as well as the mapping of the common 3GPP charging architecture specified in TS 32.240 onto VCS. It further specifies the charging events for online charging.

2.2.2.395 TS 32.277

Telecommunication management; Charging management; Proximity-based Services (ProSe) charging

This document is part of a series of documents that specify charging functionality and charging management in GSM/UMTS networks. The GSM/UMTS core network charging architecture and principles are specified in TS 32.240, which provides an umbrella for other charging management TSs

This document specifies the offline and online charging description for the Proximity-based Services (ProSe), based on the stage 2 description of ProSe in TS 23.303. This charging description includes the offline and online charging architecture and scenarios specific to the ProSe, as well as the mapping of the common 3GPP charging architecture specified in TS 32.240 onto the ProSe. It further specifies the structure and content of the CDRs for offline charging, and the charging events for online charging.

2.2.2.396 TS 32.278

Telecommunication management; Charging management; Monitoring event charging

This document is part of a series of documents that specify charging functionality and charging management in GSM/UMTS/LTE networks. The GSM/UMTS/LTE core network charging architecture and principles are specified in TS 32.240, which provides an umbrella for other charging management TSs that specify:

- the content of the CDRs per domain / subsystem / service (offline charging);

- the content of real-time charging messages per domain / subsystem / service (online charging);
- the functionality of online and offline charging for those domains / subsystems / services;
- the interfaces that are used in the charging framework to transfer the charging information (i.e. CDRs or charging events).

The complete document structure for these TSs is defined in TS 32.240.

This document specifies the Offline Charging description for Monitoring Events, based on the functional stage 2 description in TS 23.682. This charging description includes the offline charging architecture and scenarios specific to Monitoring Events, as well as the mapping of the common 3GPP charging architecture specified in TS 32.240 onto the 3GPP Architecture for Service Capability Exposure. It further specifies the structure and content of the CDRs for offline charging. This document is related to other 3GPP charging TSs as follows:

- The common 3GPP charging architecture is specified in TS 32.240.
- The parameters, abstract syntax and encoding rules for the CDRs are specified in TS 32.298.
- A transaction based mechanism for the transfer of CDRs within the network is specified in TS 32.295.
- The file based mechanism used to transfer the CDRs from the network to the operator's billing domain (e.g. the billing system or a mediation device) is specified in TS 32.297.
- The 3GPP Diameter application that is used for Monitoring Event offline charging is specified in TS 32.299.

The online charging functionality for Monitoring Events is outside the scope of 3GPP standardisation.

All references, abbreviations, definitions, descriptions, principles and requirements, used in this document, that are common across 3GPP TSs, are defined in the 3GPP Vocabulary, TR 21.905. Those that are common across charging management in GSM/UMTS/LTE domains, services or subsystems are provided in the umbrella document TS 32.240 and are copied into clause 3 of this document for ease of reading. Finally, those items that are specific to this document are defined exclusively in this document.

2.2.2.397 TS 32.401

Telecommunication management; Performance Management (PM); Concept and requirements

This document describes the requirements for the management of performance measurements and the collection of performance measurement result data across GSM, UMTS and LTE networks. It defines the administration of measurement schedules by the Network Element Manager (EM), the generation of measurement results in the Network Elements (NEs) and the transfer of these results to one or more Operations Systems, i.e. EM(s) and/or Network Manager(s) (NM(s)).

The basic Performance Management concept that this document is built upon is described in clause 4.

The requirements of how an EM administers the performance measurements and how the results can be collected are defined in detail in clause 5. Measurements available for collection by NEs are described in the following specifications:

- TS 52.402 for GSM systems;
- TS 32.405, TS 32.406, TS 32.407 and TS 32.408 for UMTS and combined UMTS/GSM systems;
- TS 32.409 for IMS networks;
- TS 32.425 for E-UTRAN.

- TS 32.426 for EPC.
- TS 32.452 for Home Node B (HNB) Subsystem (HNS).
- TS 32.453 for Home enhanced Node B (HeNB) Subsystem (HeNS).

Effort has been made to ensure consistency in the definition of measurements between different NEs and generations. The performance measurement result is described in Performance Measurement File Format Definition (3GPP TS 32.432).

The following is beyond the scope of this document, and therefore this document does not describe:

- the formal definition of the interface that the EM uses to administer performance measurements in the NEs;
- the formal definition of the interface that the EM uses to collect measurement results from the NEs;
- how the data, once accumulated and collected, could or should be processed, stored, or presented to an end user;
- the information which may be obtained through the collection and processing of call or event related records which have been produced by the NEs primarily for the purpose of raising bills and other charges.

The management requirements have been derived from existing telecommunications operations experience. The management definitions were then derived from other standardisation work so as to minimise the re-invention factor. References are given as appropriate.

The objectives of this standardisation are:

- to provide the descriptions for a standard set of measurements;
- to produce a common description of the management technique for measurement administration and result accumulation; and
- to define a method for the bulk transmission of measurement results across a management interface.

The definition of the standard measurements is intended to result in comparability of measurement result data produced in a multi-vendor wireless network, for those measurement types that can be standardised across all vendors' implementations.

As far as possible, existing standardisation in the area of Performance Management has been re-used and enhanced where particular requirements, peculiar to the mobile telephony environment, have been recognised.

This document considers all the above aspects of Performance Management for a GSM, UMTS or LTE network and its NEs defined in the core Technical Specifications. However, only those aspects which are specific to a GSM/UMTS/LTE system and particular to wireless network operation are included in this document.

2.2.2.398 TS 32.409

Telecommunication management; Performance Management (PM); Performance measurements; IP Multimedia Subsystem (IMS)

This document describes the measurements of IMS.

3GPP TS 32.401 describes Performance Management concepts and requirements.

This document is valid for all measurement types provided by an implementation of an IMS network. These may be measurement types defined within this document, measurements defined within other standards bodies, or vendor specific measurement types.

Only measurement types that are specific to IMS network are defined within this documents. I.e. vendor specific measurement types and measurements related to "external" technologies used in IMS network, such as ATM or IP, are not covered. Instead, these could be applied as described by the other, "external" standards bodies (e.g. ITU-T or IETF) or according to manufacturer's documentation.

The definition of the standard measurements is intended to result in comparability of measurement data produced in a multi-vendor network, for those measurement types that can be standardised across all vendors' implementations.

The structure of this document is as follows:

- Header 1: Network Element (e.g. measurements related to CSCF);
- Header 2: Measurement function (e.g. Registration related measurements);
- Header 3: Measurements.

2.2.2.399 TS 32.425

Telecommunication management; Performance Management (PM); Performance measurements Evolved Universal Terrestrial Radio Access Network (E-UTRAN)

This document describes the measurements for E-UTRAN.

TS 32.401 describes Performance Management concepts and requirements.

This document is valid for all measurement types provided by an implementation of an E-UTRAN.

Only measurement types that are specific to E-UTRAN are defined within this documents. Vendor specific measurement types used in E-UTRAN are not covered. Instead, these could be applied according to manufacturer's documentation.

Measurements related to "external" technologies (such as ATM or IP) as described by "external" standards bodies (e.g. ITU-T or IETF) shall only be referenced within this specification, wherever there is a need identified for the existence of such a reference.

The definition of the standard measurements is intended to result in comparability of measurement data produced in a multi-vendor network, for those measurement types that can be standardised across all vendors' implementations.

The structure of this document is as follows:

- Header 1: Network Element (e.g. measurements related to eNodeB);
- Header 2: Measurement function (e.g. RRC connection setup related measurements);
- Header 3: Measurements.

2.2.2.400 TS 32.426

Telecommunication management; Performance Management (PM); Performance measurements Evolved Packet Core (EPC) network

This document describes the measurements for EPC and combined EPC/UMTS/GSM.

TS 32.401 describes Performance Management concepts and requirements.

This document is valid for all measurement types provided by an implementation of an EPC network and combined EPC/UMTS/GSM network. Only measurement types that are specific to EPC or combined EPC/UMTS/GSM networks are defined within this documents.

Vendor specific measurement types used in EPC and combined EPC/UMTS/GSM networks are not covered. Instead, these could be applied according to manufacturer's documentation.

Measurements related to "external" technologies (such as IP) as described by "external" standards bodies (e.g. IETF) shall only be referenced within this specification, wherever there is a need identified for the existence of such a reference.

The definition of the standard measurements is intended to result in comparability of measurement data produced in a multi-vendor network, for those measurement types that can be standardised across all vendors' implementations.

The structure of this document is as follows:

- Header 1: Network Element (e.g. MME related measurements);
- Header 2: Measurement function;
- Header 3: Measurements.

2.2.2.401 TS 32.432

Telecommunication management; Performance measurement: File format definition

This document describes the general semantics of performance measurement result and collection. It defines the report file format, report file conventions and the file transfer procedure. Clause 4 specifies the file format for the bulk transfer of performance measurement results to the NM, while clause 5 discusses the file transfer procedure utilised on that interface.

This document does not give the definition of any specific file format – such as XML and ASN.1, which will be given in Performance Measurement eXtensible Markup Language (XML) File Format Definition 3GPP TS 32.435 and Performance Measurement Abstract Syntax Notation 1 (ASN.1) File Format Definition 3GPP TS 32.436.

2.2.2.402 TS 32.435

Telecommunication management; Performance measurement; eXtensible Markup Language (XML) file format definition

This document describes the XML file format of performance measurement results whose semantics is defined in 3GPP TS 32.432.

2.2.2.403 TS 32.436

Telecommunication management; Performance measurement: Abstract Syntax Notation 1 (ASN.1) file format definition

This document defines the ASN.1 file format definition for performance measurement results collection whose semantics is defined in 3GPP TS 32.432.

2.2.2.404 TS 32.453

Telecommunication management; Performance Management (PM); Performance measurements Home enhanced Node B (HeNB) Subsystem (HeNS)

This document describes the measurements for Home enhanced Node B Subsystem (HeNS).

HeNS consists of a HeNB and optionally a HeNB GW. And, it is connected by means of the standard S1 interface to the EPC (Evolved Packet Core), more specifically to the MME (Mobility Management Entity) by means of the S1-MME interface and to the Serving Gateway (S-GW) by means of the S1-U interface

TS 32.401 describes Performance Management concepts and requirements.

This document is valid for all measurement types provided by an implementation of HeNS.

Only measurement types that are specific to HeNS are defined within this documents. Vendor specific measurement types used in HeNS are not covered. Instead, these could be applied according to manufacturer's documentation.

Measurements related to "external" technologies (such as ATM or IP) as described by "external" standards bodies (e.g. ITU-T or IETF) shall only be referenced within this specification, wherever there is a need identified for the existence of such a reference.

The definition of the standard measurements is intended to result in comparability of measurement data produced in a multi-vendor network, for those measurement types that can be standardised across all vendors' implementations.

The structure of this document is as follows:

- Header 1: Network Element (e.g. measurements related to HeNB and HeNB GW);
- Header 2: Measurement function (e.g. HeNB registration measurements);
- Header 3: Measurements.

2.2.2.405 TS 32.501

Telecommunication management; Self-configuration of network elements; Concepts and requirements

This document describes the concepts how self-configuration works and what IRP requirements need to be met to support this functionality. The document also captures if a requirement shall be met via the Itf-N interface or via other protocols. This version of the TS is restricted to self-configuration of eNBs. The requirements in this document are not imposed on HNBs.

2.2.2.406 TS 32.508

Telecommunication management; Procedure flows for multi-vendor plug-and-play eNode B connection to the network

This document describes the procedure flows between network entities involved in the **multi-vendor plug-and-play** eNB connection to network.

These procedures are based on requirements and use cases specified in 3GPP TS 32.501. The format of the data exchanged in these procedures is defined in 3GPP TS 32.509.

2.2.2.407 TS 32.509

Telecommunication management; Data formats for multi-vendor plug and play eNode B connection to the network

This document describes the data formats used between network entities involved in the multi-vendor plug and play eNB connection to network.

These data formats are based on requirements and use cases specified in 3GPP TS 32.501. The procedure flows where these data exchanged are defined in 3GPP TS 32.508.

2.2.2.408 TS 32.602

Telecommunication management; Configuration Management (CM); Basic CM Integration Reference Point (IRP); Information Service (IS)

This document defines a component of an Integration Reference Point (IRP) through which an 'IRPAgent' (typically an Element Manager or Network Element) can communicate basic Configuration Management related information to one or several 'IRPManagers' (typically Network Managers).

The function of this Basic CM IRP Information Service is to define an interface for the retrieval and modification of Configuration Management Information.

This Basic CM IRP IS is aligned with ITU-T M.3700 in that ITU-T M.3700 is a subset of the Basic CM IRP IS in terms of the definitions of operations for the retrieval and modification of Configuration Management Information.

2.2.2.409 TS 32.612

Telecommunication management; Configuration Management (CM); Bulk CM Integration Reference Point (IRP): Information Service (IS)

This document (Bulk Configuration Management IRP: Information Service) defines a number of Integration Reference Point (IRP) through which an 'IRPAgent' (typically an Element Manager or Network Element) can communicate bulk Configuration Management related information to one or several 'IRPManagers' (typically Network Managers).

2.2.2.410 TS 33.102

Security architecture

Provides a specification of all security mechanisms and protocols, except algorithms.

2.2.2.411 TS 33.105

Cryptographic algorithm requirements

Defines requirements for standard cipher and integrity algorithm.

2.2.2.412 TS 33.106

Lawful interception requirements

Defines all requirements for network based lawful interception.

2.2.2.413 TS 33.107

3G security; Lawful interception architecture and functions

This document describes the architecture and functional requirements within a Third Generation Mobile Communication System (3GMS) and the Evolved Packet System (EPS). The specification shows the service requirements from a Law Enforcement point of view only. The aim of this document is to define a 3GMS and EPS interception system that supports a number of regional interception regulations, but these regulations are not repeated here as they vary. Regional interception requirements shall be met in using specific (regional) mediation functions allowing only required information to be transported.

2.2.2.414 TS 33.108

3G security; Handover interface for Lawful Interception (LI)

This specification addresses the handover interfaces for Lawful Interception (LI) of Packet-Data Services, Circuit Switched Services, Multimedia Services within the UMTS network and Evolved Packet System (EPS). The handover interface in this context includes the delivery of Intercept Related Information (HI2) and Content of Communication (HI3) to the Law Enforcement Monitoring Facility.

2.2.2.415 TS 33.110

Key establishment between a Universal Integrated Circuit Card (UICC) and a terminal

This document describes the security features and mechanisms to provision a shared key between a

UICC and a terminal that may host the UICC or be connected to the device hosting the UICC via a local interface. Candidate applications to use this key establishment mechanism include but are not restricted to secure channel between a UICC and a terminal. The scope of this specification includes an architecture overview and the detailed procedure how to establish the shared key between the UICC and the terminal.

2.2.2.416 TS 33.116

Security Assurance Specification (SCAS) for the MME network product class

This document contains objectives, requirements and test cases that are specific to the MME network product class. It refers to the Catalogue of General Security Assurance Requirements and formulates specific adaptations of the requirements and test cases given there, as well as specifying requirements and test cases unique to the MME network product class.

2.2.2.417 TS 33.117

Catalogue of general security assurance requirements

This document contains objectives, requirements and test cases that are deemed applicable, possibly after adaptation, to several network product classes.

It has been recognized that several network product classes will share very similar if not identical security requirements for some aspects. Therefore, these are collected in this "catalogue" document applicable to many network product classes. In addition to this catalogue, requirements specific to different network product classes will be captured in separate documents.

2.2.2.418 TS 33.141

Presence service; Security

This document is the Stage 2 specification for the security requirements, security architecture, security features and security mechanisms for the Presence Service, which includes the elements necessary to realize the requirements in TS 22.141 and TS 23.141. As far as SIP-based procedures are concerned, this specification refers to TS 33.203. The main content of this specification is the security for the Ut reference point, which is HTTP-based, as applied in presence services. The document includes information applicable to network operators, service providers and manufacturers.

2.2.2.419 TS 33.179

Security of Mission Critical Push To Talk (MCPTT) over LTE

This document specifies the security architecture, procedures and information flows needed to protect the mission critical push to talk (MCPTT) service. The architecture includes mechanisms for authentication, protection of MCPTT signalling and protection of MCPTT media. Security for both MCPTT group calls and MCPTT private calls operating in on-network and off-network modes of operation is specified.

The functional architecture for MCPTT is defined in 3GPP TS 23.179, the corresponding service requirements are defined in 3GPP TS 22.179.

The MCPTT service can be used for public safety applications and also for general commercial applications e.g. utility companies and railways. As the security model is based on the public safety environment, some security features may not be applicable to MCPTT for commercial purposes.

2.2.2.420 TS 33.180

Security of the mission critical service

This document specifies the security architecture, procedures and information flows needed to protect the mission critical service (MCX). The architecture includes mechanisms to protect the Common Functional Architecture and security mechanisms for mission critical applications. This includes Push-To-Talk (MCPTT), Video (MCVideo) and Data (MCData). Additionally, security mechanisms relating to on-network use, off-network use, roaming, migration, interconnection, interworking and multiple security domains are described.

This specification complements the Common Functional Architecture defined in TS 23.280, the functional architecture for MCPTT defined in 3GPP TS 23.379, the functional architecture for MCVideo defined in 3GPP TS 23.281 and the functional architecture for MCData defined in 3GPP TS 23.282.

The MC service can be used for public safety applications and also for general commercial applications e.g. utility companies and railways. As the security model is based on the public safety environment, some security features may not be applicable to MCPTT for commercial purposes.

2.2.2.421 TS 33.185

Security aspect for LTE support of Vehicle-to-Everything (V2X) services

This document specifies the security aspects of V2X features in LTE, including security architecture, security requirements on the network entities that are used to support V2X services, as well as the procedures and solutions which are provided to meet those requirements.

2.2.2.422 TS 33.187

Security aspects of Machine-Type Communications (MTC) and other mobile data applications communications enhancements

This document specifies the security architecture enhancements (i.e. enhancements to the security features and the security mechanisms) to facilitate Machine-Type and other mobile data applications Communications enhancements (MTCe) as per the use cases and service requirements defined in 3GPP TS 22.368 and the architecture enhancements and procedures defined in 3GPP TS 23.682.

2.2.2.423 TS 35.231

Specification of the TUAk algorithm set: A second example algorithm set for the 3GPP authentication and key generation functions $f1$, $f1^*$, $f2$, $f3$, $f4$, $f5$ and $f5^*$; Document 1: Algorithm specification

This document and the other Technical Specifications in the series, TS 35.232 and TS 35.233 contain an example set of algorithms which could be used as the authentication and key generation functions $f1$, $f1^*$, $f2$, $f3$, $f4$, $f5$ and $f5^*$ for 3GPP systems. All seven functions are operator-specifiable rather than being fully standardised and other algorithms could be envisaged.

2.2.2.424 TS 35.232

Specification of the TUAk algorithm set: A second example algorithm set for the 3GPP authentication and key generation functions $f1$, $f1^*$, $f2$, $f3$, $f4$, $f5$ and $f5^*$; Document 2: Implementers' test data

This document and the other Technical Specifications in the series, TS 35.231 and TS 35.233, contain an example set of algorithms which could be used as the authentication and key generation functions $f1$, $f1^*$, $f2$, $f3$, $f4$, $f5$ and $f5^*$ for 3GPP systems. In particular, this document defines the test data:

- for the Keccak permutation used within Tuak,
- for the authentication algorithms $f1$ and $f1^*$,
- for the algorithms $f2$, $f3$, $f4$, $f5$ and $f5^*$.

2.2.2.425 TS 35.233

Specification of the TUAk algorithm set: A second example algorithm set for the 3GPP authentication and key generation functions $f1$, $f1^*$, $f2$, $f3$, $f4$, $f5$ and $f5^*$; Document 3: Design conformance test data

This document and the other Technical Specifications in the series, TS 35.231 and TS 35.232, contain an example set of algorithms which could be used as the authentication and key generation functions $f1$, $f1^*$, $f2$, $f3$, $f4$, $f5$ and $f5^*$ for 3GPP systems.

This document provides sets of input/output test data for ‘black box’ testing of physical realizations of all algorithms, and in particular:

- Test data for the Keccak permutation used within Tuak.
- Test data for the MILENAGE authentication and key generation algorithms $f1$, $f1^*$, $f2$, $f3$, $f4$, $f5$ and $f5^*$.

2.2.2.426 TS 33.250

Security assurance specification for the PGW network product class

This document contains requirements and test cases that are specific to the PGW network product class. It refers to the Catalogue of General Security Assurance Requirements and formulates specific adaptations of the requirements and test cases given there, as well as specifying requirements and test cases unique to the PGW network product class.

2.2.2.427 TS 33.303

Proximity-based **Services** (ProSe); Security aspects

This document specifies the security aspects of the Proximity Services (ProSe) features in EPS. The ProSe features covered are:

- Configuration of ProSe-enabled UEs;
- Open ProSe Direct Discovery (in network coverage);
- One-to-many communication for ProSe-enabled Public Safety UEs;
- EPC-level ProSe Discovery;
- EPC support for WLAN Direct Communication.

2.2.2.428 TS 32.281

Telecommunication management; Charging management; Announcement service

During any phase of a voice or video call, the Online Charging System (OCS) may need to deliver billing/charging in-session notifications to the end user via announcements as part of the rating, balance management and billing process. For example, the OCS may need to inform the user about usage states, threshold crossings, offer statuses, reason for call rejection, alerts about low balances, etc.

In Circuit Switched (CS) domain, online charging of a voice session is performed using Customised Applications for Mobile network Enhanced Logic (CAMEL) mechanisms. In order to deliver in-session notifications or to interact with the end user, OCS can use CAMEL messages such as: Play Announcement, Prompt and Collect, Connect to Resource, Establish Temporary Connection. Such

notifications can be delivered pre-, mid- or post-call. However, in IMS and MMTel charging defined in TS 32.260 and TS 32.275 as well as in Diameter Credit-Control Application (DCCA) defined in RFC 4006, announcement capabilities, available at the OCS level, are limited to redirection of a session to a given SIP URI at completion of the session. When redirected the session may be connected to a resource that delivers an announcement.

The Announcement service in this specification provides announcement capabilities for use in a Diameter based online charging session. The OCS is able to specify that a given announcement be played to a call party in order to deliver charging/billing related notifications.

Annex 2

Specification of the WirelessMAN-Advanced radio interface technology

Background

IMT-Advanced is a system with global development activity and the IMT-Advanced terrestrial radio interface specifications identified in this Recommendation have been developed by the ITU in collaboration with the GCS¹⁰ Proponents and the Transposing Organizations. It is noted from Document IMT-ADV/24(Rev.3), that:

- The GCS Proponent must be one of the RIT¹¹/SRIT¹² Proponents for the relevant technology, and must have legal authority to grant to ITU-R the relevant legal usage rights to the relevant specifications provided within a GCS corresponding to a technology in Recommendation ITU-R M.2012
- A Transposing Organization must have been authorized by the relevant GCS Proponent to produce transposed standards for a particular technology, and must have the relevant legal usage rights.

It is further noted that GCS Proponents and Transposing Organizations must also qualify appropriately under the auspices of Resolution ITU-R 9-5 and the ITU-R “Guidelines for the contribution of material of other organizations to the work of the Study Groups and for inviting other organizations to take part in the study of specific matters (Resolution ITU-R 9-5)”.

The ITU has provided the global and overall framework and requirements, and has developed the Global Core Specification jointly with the GCS Proponent. The detailed standardization has been undertaken within the recognized Transposing Organizations which operate in concert with the GCS Proponent. This Recommendation therefore makes extensive use of references to externally developed specifications.

This approach was considered to be the most appropriate solution to enable completion of this Recommendation within the aggressive schedules set by the ITU and by the needs of administrations, operators and manufacturers.

¹⁰ Global Core Specifications.

¹¹ Radio Interface Technology.

¹² Set of Radio Interface Technologies.

This Recommendation has therefore been constructed to take full advantage of this method of work and to allow the global standardization time-scales to be maintained. The main body of this Recommendation has been developed by the ITU, with each Annex containing references pointing to the location of the more detailed information.

This Annex 2 contains the detailed information developed by the ITU and “IEEE” (the GCS Proponent) and IEEE, ARIB, TTA, ITRI and WiMAX Forum (the Transposing Organizations). Such use of referencing enables timely completion and update of the high-level elements of this Recommendation, with change control procedures, transposition, and public enquiry procedures being undertaken within the external organization. This information has generally been adopted unchanged, recognizing the need to minimize duplication of work, and the need to facilitate and support an ongoing maintenance and update process.

This general agreement, noting that the detailed information of the radio interface should to a large extent be achieved by reference to the work of external organizations, highlights not only the ITU’s significant role as a catalyst in stimulating, coordinating and facilitating the development of advanced telecommunications technologies, but also its forward-looking and flexible approach to the development of this and other telecommunications standards for the 21st century.

A more detailed understanding of the process for the development of the first release of this Recommendation may be found in Document IMT-ADV/24(Rev.3) whereas details on the process for the development of Revisions of this Recommendation may be found in Document IMT-ADV/25(Rev.2).

1 Overview of the radio interface technology

The WirelessMAN-Advanced radio interface specification is developed by IEEE. A complete end-to-end system based on WirelessMAN-Advanced is called WiMAX 2, as developed by the WiMAX Forum.

1.1 Overview of physical layer

The following sections highlights selected physical layer (PHY) features.

1.1.1 Multiple access scheme

WirelessMAN-Advanced uses OFDMA as the multiple-access scheme in downlink (DL) and uplink (UL). It further supports both TDD and FDD duplex schemes including H-FDD operation of the mobile stations (MSs) in the FDD networks. The frame structure attributes and baseband processing are common for both duplex schemes. The OFDMA parameters are summarized in Table 2.1. *WirelessMAN-Advanced* also supports wider channel bandwidths, up to 160 MHz, with carrier aggregation. In Table 2.1, TTG and RTG denote transmit/receive and receive/transmit transition gaps, respectively.

TABLE 2.1
OFDMA parameters

Nominal channel bandwidth (MHz)		5	7	8.75	10	20
Sampling factor		28/25	8/7	8/7	28/25	28/25
Sampling frequency (MHz)		5.6	8	10	11.2	22.4
FFT size		512	1 024	1 024	1 024	2 048
Subcarrier spacing (kHz)		10.94	7.81	9.76	10.94	10.94
Useful symbol time T_u (μ s)		91.429	128	102.4	91.429	91.429
CP $T_g = 1/8 T_u$	Symbol time T_s (μ s)		102.857	144	115.2	102.857
	FDD	Number of OFDM symbols per 5 ms frame	48	34	43	48
		Idle time (μ s)	62.857	104	46.40	62.857
	TDD	Number of OFDM symbols per 5 ms frame	47	33	42	47
		TTG + RTG (μ s)	165.714	248	161.6	165.714
CP $T_g = 1/16 T_u$	Symbol time T_s (μ s)		97.143	136	108.8	97.143
	FDD	Number of OFDM symbols per 5 ms frame	51	36	45	51
		Idle time (μ s)	45.71	104	104	45.71
	TDD	Number of OFDM symbols per 5 ms frame	50	35	44	50
		TTG + RTG (μ s)	142.853	240	212.8	142.853
CP $T_g = 1/4 T_u$	Symbol Time T_s (μ s)		114.286	160	128	114.286
	FDD	Number of OFDM symbols per 5 ms frame	43	31	39	43
		Idle time (μ s)	85.694	40	8	85.694
	TDD	Number of OFDM symbols per 5 ms frame	42	30	37	42
		TTG + RTG (μ s)	199.98	200	264	199.98

1.1.2 Frame structure

A superframe is a collection of consecutive equally-sized radio frames whose beginning is marked with a superframe header (SFH), which carries short-term and long-term system configuration information.

In order to decrease the air-link access latency, the radio frames are further divided into a number of subframes where each subframe comprises of an integer number of OFDM symbols. The transmission time interval (TTI) is defined as the transmission latency over the air-link and is equal to a multiple of subframe length (default is one subframe). There are four types of subframes: 1) type-1 subframe, which consists of six OFDM symbols, 2) type-2 subframe, which consists of seven OFDM symbols, 3) type-3 subframe which consists of five OFDM symbols, and 4) type-4 subframe, which consists of nine OFDM symbols and can be used only in UL for channel bandwidth of 8.75 MHz when supporting legacy, i.e. OFDMA TDD WMAN, frames.

The basic frame structure is shown in Fig. 2.1, where superframe length is 20 ms (comprised of four radio frames), radio frame size is 5 ms, and subframe length depends on channel bandwidth, length

of cyclic prefix, and subframe type, i.e. type-1/2/3/4. The number of subframes per radio frame is predetermined to maximize the spectral efficiency for each frame configuration depending on channel bandwidth, length of cyclic prefix, subframe type, and duplex mode.

The concept of time zones applies to both TDD and FDD systems. These time zones are time-division multiplexed across time domain in the DL to support both new and legacy MSs. For UL transmissions both time and frequency-division multiplexing approaches can be used to support legacy and new terminals. The non-backward compatible improvements and features are restricted to the new zones. All backward compatible features and functions are used in the legacy zones.

FIGURE 2.1

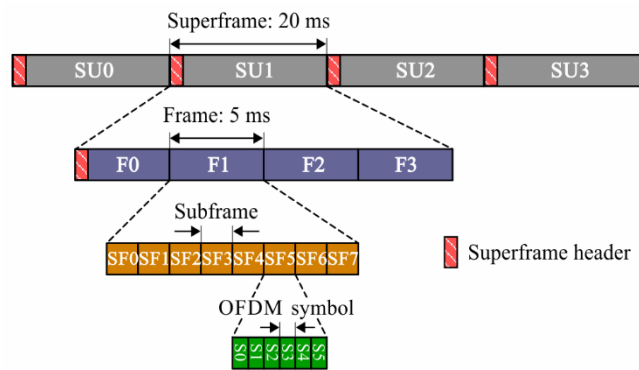
Basic frame structure

M.2012-02-01

1.1.3 Physical structure and resource unit

The DL/UL subframes are divided into a number of frequency partitions, where each partition consists of a set of physical resource units (PRUs) over the available number of OFDM symbols in the subframe. Each frequency partition can include localized and/or distributed physical resource units. Frequency partitions can be used for different purposes such as fractional frequency reuse (FFR). The DL/UL resource partitioning and mapping is illustrated in Fig. 2.2. PRU is the basic physical unit for resource allocation that comprises 18 contiguous subcarriers by N_{sym} contiguous OFDM symbols where N_{sym} is 6, 7, 5 and 9 OFDM symbols for type-1, type-2, type-3 and type-4 subframes, respectively (type-4 is used only for UL). A logical resource unit (LRU) is the basic logical unit for distributed and localized resource allocations. LRU comprises of $18 \times N_{\text{sym}}$ subcarriers.

FIGURE 2.2

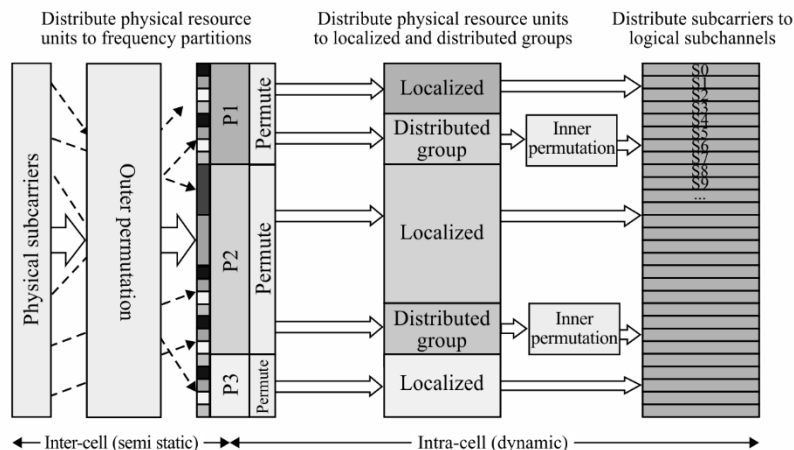
Resource mapping process

M.2012-02-02

1.1.4 Resource mapping

The resource mapping process is defined as follows as illustrated in Fig. 2.2, where P_i denotes the i -th frequency partition.

The PRUs are first subdivided into sub-bands and mini-bands where a sub-band comprises four adjacent PRUs and a mini-band comprises one PRU. The sub-bands are suitable for frequency selective allocations as they provide a contiguous allocation of PRUs in frequency. The mini-bands are suitable for frequency diverse allocations and are permuted in frequency (outer permutation in Fig. 2.2).

After frequency partitioning, the partition between localized or contiguous resource units (CRUs) and distributed resource units (DRUs) is done on a sector specific basis. All sub-bands are categorized into CRU, while mini-bands are categorized into either CRU or DRU. CRUs are used to achieve frequency-selective scheduling gain. A CRU comprises a group of subcarriers which are contiguous across frequency. DRUs are used to achieve frequency diversity gain. A DRU contains a group of subcarriers which are spread across a frequency partition. The sizes of the CRU and DRU are equal to that of PRU.

To form CRUs and DRUs, the subcarriers over the OFDM symbols of a sub-frame are partitioned into guard and used subcarriers. The DC subcarrier is not used. The used subcarriers are divided into PRUs. Each PRU contains pilot and data subcarriers. The number of used pilot and data subcarriers depends on MIMO mode, rank and number of multiplexed MS, as well as the number of OFDM symbols within a sub-frame.

The subcarrier (tone-pair) permutation defined for DRU of a DL frequency partition spreads the subcarriers across all the distributed resource allocations within a frequency partition. After mapping all pilots, the remaining used subcarriers are paired into contiguous subcarrier-pairs (tone-pairs), and then are permuted to define the distributed logical resource units (DLRUs). The DL subcarrier permutation is performed per OFDM symbol within a sub-frame. Each of the DRUs of an UL frequency partition is divided into 3 tiles of 6 adjacent subcarriers over N_{sym} symbols. The tiles are collectively permuted across all the distributed resource allocations within a frequency partition to define DLRUs. The contiguous logical resource unit (CLRUs) are obtained from direct mapping of CRUs. CLRUs are categorized into sub-band-based LRUs, so-called sub-band logical resource unit (SLRU), and mini-band-based LRUs, so called mini-band logical resource unit (NLRU).

1.1.5 Modulation and coding

FIGURE 2.3

Coding and modulation procedures

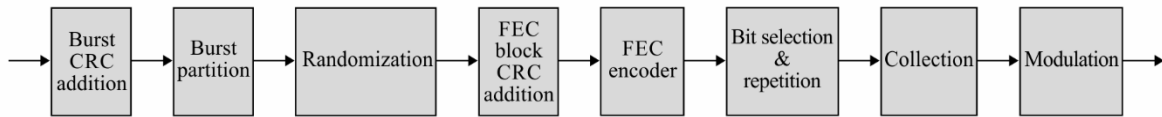

M.2012-02-03

Figure 2.3 shows the channel coding and modulation procedures. A cyclic redundancy check (CRC) is appended to a burst (i.e. a physical layer data unit) prior to partitioning. The 16-bit CRC is calculated over the entire bits in the burst. If the burst size including burst CRC exceeds the maximum FEC block size, the burst is partitioned into KFB FEC blocks, each of which is encoded separately. If a burst is partitioned into more than one forward error correction (FEC) blocks, a FEC block CRC is appended to each FEC block before the FEC encoding. The FEC block CRC of a FEC block is calculated based on the entire bits in that FEC block. Each partitioned FEC block including 16-bit FEC block CRC has the same length. The maximum FEC block size is 4 800 bits. Concatenation rules are based on the number of information bits and do not depend on the structure of the resource allocation (number of logical resource units and their size). *WirelessMAN-Advanced* utilizes the convolutional turbo code (CTC) with code rate of 1/3. The CTC scheme is extended to support additional FEC block sizes. Furthermore, the FEC block sizes can be regularly increased with predetermined block size resolutions. The FEC block sizes which are multiple of seven are removed for the tail-biting encoding structure. The encoder block depicted in Fig. 2.3 includes the interleaver.

Bit selection and repetition are used in *WirelessMAN-Advanced* to achieve rate matching. Bit selection adapts the number of coded-bits to the size of the resource allocation which may vary depending on the resource unit size and sub-frame type. The total subcarriers in the allocated resource unit are segmented to each FEC block. The total number of information and parity bits generated by FEC encoder are considered as the maximum size of circular buffer. Repetition is performed when the number of transmitted bits is larger than the number of selected bits. The selection of coded bits is done cyclically over the buffer. The mother-code bits, the total number of information and parity bits generated by FEC encoder, are considered as a maximum size of circular buffer. In case that the size of the circular buffer N_{buffer} is smaller than the number of mother-code bits, the first N_{buffer} bits of mother-code bits are considered as selected bits.

Modulation constellations of QPSK, 16QAM, and 64QAM are supported. The mapping of bits to the constellation point depends on the constellation-rearrangement (CoRe) version used for HARQ retransmission as described and further depends on the MIMO scheme. The QAM symbols are mapped into the input of the MIMO encoder. The sizes include the addition of CRC (per burst and per FEC block), if applicable. Other sizes require padding to the next burst size. The code rate and modulation depend on the burst size and the resource allocation.

Incremental redundancy HARQ (HARQ-IR) is used in *WirelessMAN-Advanced* by determining the starting position of the bit selection for HARQ retransmissions. Chase combining HARQ (HARQ-CC) is also supported and considered as a special case of HARQ-IR. The 2-bit sub-packet identifier (SPID) is used to identify the starting position. The CoRe scheme can be expressed by a bit-level interleaver.

The resource allocation and transmission formats in each retransmission in DL can be adapted with control signalling. The resource allocation in each retransmission in UL can be fixed or adaptive according to control signalling. In HARQ re-transmissions, the bits or symbols can be transmitted in a different order to exploit the frequency diversity of the channel.

For HARQ retransmission, the mapping of bits or modulated symbols to spatial streams may be applied to exploit spatial diversity with given mapping pattern, depending on the type of HARQ-IR. In this case, the predefined set of mapping patterns should be known to the transmitter and receiver. In DL HARQ, the base station (BS) may transmit coded bits exceeding current available soft buffer capacity.

1.1.6 Pilot structure

Transmission of pilot subcarriers in DL is necessary to allow channel estimation, channel quality measurement (e.g. channel quality indicator, CQI), frequency offset estimation, etc. To optimize the system performance in different propagation environments, *WirelessMAN-Advanced* supports both common and dedicated pilot structures. The classification of pilots into common and dedicated is done based on their usage. The common pilots can be used in distributed allocation by all MSs. Dedicated pilots can be used with both localized and distributed allocations. They are associated with user specific pilot index. The dedicated pilots are associated with a specific resource allocation, are intended to be used by the MSs allocated to specific resource allocation, and therefore shall be precoded or beamformed in the same way as the data subcarriers of the resource allocation. The pilot structure is defined for up to eight streams and there is a unified design for common and dedicated pilots. There is equal pilot density per spatial stream; however, there is not necessarily equal pilot density per OFDM symbols.

FIGURE 2.4

Pilot structures for 1, 2, 4, and 8 streams for Type-1 sub-frame

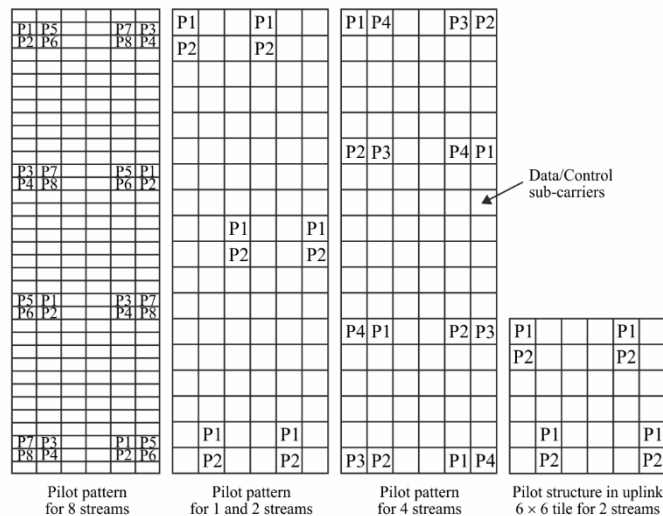

M.2012-02-04

For the sub-frame consisting of five OFDM symbols, the last OFDM symbol is deleted. For the sub-frame consisting of seven OFDM symbols, the first OFDM symbol is added as the 7th OFDM symbol. To overcome the effects of pilot interference among the neighbouring sectors or BSs, an interlaced pilot structure is utilized by cyclically shifting the base pilot pattern such that the pilots of neighbouring cells do not overlap.

The UL pilots are dedicated to localized and distributed resource units and are precoded using the same precoding as the data subcarriers of the resource allocation. The pilot structure is defined for up to four transmit streams for SU-MIMO and up to eight streams for CSM. When pilots are power-boosted, each data subcarrier should have the same transmission power across all OFDM symbols in a resource block.

The 18×6 UL resource blocks use the same pilot patterns as the DL counterpart. The pilot pattern for 6×6 tile structure is used for DLRU only in case the number of streams is one or two and it is also shown in Fig. 2.4.

1.1.7 Control channels

DL control channels carry essential information for system operation. Depending on the type of control signalling, information is transmitted over different time intervals (i.e. from superframe to sub-frame intervals). The system configuration parameters are transmitted at the superframe intervals, whereas control signalling related to user data allocations is transmitted at the frame/sub-frame intervals.

1.1.7.1 Downlink control channels

Superframe Header (SFH)

The superframe header (SFH) carries essential system parameters and configuration information. The content of SFH is divided into two segments; i.e. primary and secondary SFHs. The primary SFH is transmitted every superframe, whereas the secondary SFH is transmitted over one or more superframes. The primary and secondary SFHs are located in the first sub-frame within a superframe and are time-division-multiplexed with the advanced preamble. The SFH occupies no more than 5 MHz bandwidth. The primary SFH is transmitted using predetermined modulation and coding scheme. The secondary SFH is transmitted using predetermined modulation scheme while its repetition coding factor is signalled in the primary SFH. The primary and secondary SFHs are transmitted using two spatial streams and space-frequency block coding to improve coverage and reliability. The MS is not required to know the antenna configuration prior to decoding the primary SFH. The information transmitted in the secondary SFH is divided into different sub-packets. The secondary SFH sub-packet 1 (SP1) includes information needed for network re-entry. The secondary SFH sub-packet 2 (SP2) contains information for initial network entry. The secondary SFH sub-packet 3 (SP3) contains remaining system information for maintaining communication with the BS.

Advanced MAP (A-MAP)

The advanced MAP (A-MAP) consists of both user-specific and non-user-specific control information. Non-user-specific control information includes information that is not dedicated to a specific user or a specific group of users. It contains information required to decode user-specific control signalling. User specific control information consists of information intended for one or more users. It includes scheduling assignment, power control information, and HARQ feedback. Resources can be allocated persistently to the MSs. Group control information is used to allocate resources and/or configure resources to one or multiple MSs within a user group. Within a subframe, control and data channels are frequency-division-multiplexed. Both control and data channels are transmitted on logical resource units that span over all OFDM symbols within a subframe.

Each DL subframe contains a control region including both non-user-specific and user-specific control information. All A-MAPs share a time-frequency region known as A-MAP region. The control regions are located in every subframe. The corresponding UL allocations occurs L subframes later, where L is determined by A-MAP relevance. The coding rate is predetermined for non-user-specific information while it is indicated by SFH for user-specific control information.

An A-MAP allocation Information Element (IE) is defined as the basic element of unicast service control. A unicast control IE may be addressed to one user using a unicast identifier or to multiple users using a multicast/broadcast identifier. The identifier is masked with CRC in the A-MAP allocation IE. It may contain information related to resource allocation, HARQ, MIMO transmission mode, etc. Each A-MAP IE is coded separately.

Non-user-specific control information is encoded separately from the user-specific control information. In the DL subframes, frequency partition for reuse-1 and/or frequency partition for power-boostered reuse-3 may contain an A-MAP region. The A-MAP region occupies the first few DLRUs in a frequency partition. The structure of an A-MAP region is illustrated in Fig. 2.5. The resource occupied by each A-MAP physical channel may vary depending on the system configuration and scheduler operation. There are different types of A-MAPs as follows:

- **Assignment A-MAP** contains resource assignment information which is categorized into multiple types of resource assignment IEs (assignment A-MAP IE).
- **HARQ Feedback A-MAP** contains HARQ ACK/NACK information for UL data transmission.
- **Power Control A-MAP** includes fast power control command to MSs.

There are different assignment A-MAP IE types that distinguish between DL/UL, persistent/non-persistent, single user/group resource allocation, basic/extended IE scenarios.

FIGURE 2.5
A-MAP location and structure (example)

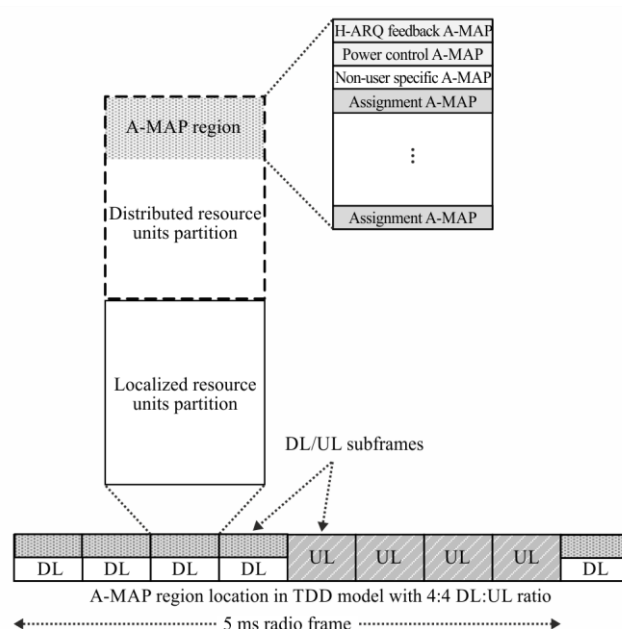

M.2012-02-05

1.1.7.2 Uplink control channels

Fast Feedback Channel (FBCH)

The UL fast feedback channel (FBCH) carries CQI and MIMO feedback.

CQI feedback provides information about channel conditions as seen by the MS. This information is used by the BS for link adaptation, resource allocation, power control, etc. The channel quality measurement includes both narrowband and wideband measurements. The CQI feedback overhead can be reduced through differential feedback or other compression techniques. Examples of CQI include effective carrier to interference plus noise ratio (CINR), band selection, etc.

MIMO feedback provides wideband and/or narrowband spatial characteristics of the channel that are required for MIMO operation. The MIMO mode, preferred matrix index (PMI), rank adaptation information, channel covariance matrix elements, and best sub-band index are examples of MIMO feedback information.

There are two types of UL FBCHs: a) primary fast feedback channel (P-FBCH) and b) secondary fast feedback channel (S-FBCH). S-FBCH can be used to support CQI reporting at higher code rate and thus more CQI information bits. FBCH is frequency-division-multiplexed with other UL control and data channels.

FBCH starts at a predetermined location, with the size defined in a DL broadcast control message. Fast feedback allocations to an MS can be periodic and the allocations are configurable. The specific type of feedback information carried on each fast feedback opportunity can be different. The number of bits carried in the fast feedback channel can be adaptive. For efficient transmission of feedback channels, a mini-tile is defined comprising two subcarriers by six OFDM symbols. One LRU consists of nine mini-tiles and can be shared by multiple FBCHs.

HARQ feedback channel

HARQ feedback (ACK/NACK) is used to acknowledge DL data transmissions. The UL HARQ feedback channel starts at a predetermined offset with respect to the corresponding DL transmission. The HARQ feedback channel is frequency-division-multiplexed with other control and data channels. Orthogonal codes are used to multiplex multiple HARQ feedback channels. The HARQ feedback channel comprises three distributed mini-tiles.

Sounding channel

The sounding channel is used by an MS to transmit sounding reference signals to enable the BS to measure UL channel conditions. The sounding channel may occupy either specific UL sub-bands or the entire bandwidth over an OFDM symbol. The BS can configure an MS to transmit the UL sounding signal over predefined subcarriers within specific sub-bands or the entire bandwidth. The sounding channel is orthogonally multiplexed (in time or frequency) with other control and data channels. Furthermore, the BS can configure multiple user terminals to transmit sounding signals on the corresponding sounding channels using code-, frequency-, or time-division multiplexing. Power control for the sounding channel can be utilized to adjust the sounding quality. The transmit power from each mobile terminal may be separately controlled according to certain CINR target values.

Ranging channel

The ranging channel is used for UL synchronization. The ranging channel can be further classified into ranging for non-synchronized and synchronized MSs. The ranging channel for non-synchronized MS (NS-RCH) is used for initial network entry and for handover to a target BS. The ranging channel for synchronized MS (S-RCH) is used for periodic ranging. In a femtocell, MSs shall perform initial ranging, handover ranging, and periodic ranging by using the S-RCH.

Bandwidth request (BR) channel

Bandwidth request (BR) channels are used to request UL grant. BRs are transmitted through BR preamble with or without messages. BR messages can include information about the status of queued traffic at the MS such as buffer size and quality of service parameters. Contention or non-contention based random access is used to transmit BR information on this control channel.

The BR channel starts at a configurable location with the configuration defined in a DL broadcast control message. The BR channel is frequency-division-multiplexed with other UL control and data channels. A BR tile is defined as six contiguous subcarriers by six OFDMA symbols. Each BR channel consists of three distributed BR tiles. Multiple BR preamble can be transmitted on the same BR channel using code-division multiplexing.

1.1.8 Power control

Power control mechanism is supported for DL and UL. Using DL power control, user-specific information with dedicated pilot is received by the terminal with the controlled power level. The DL advanced MAPs can be power-controlled based on the terminal UL channel quality feedback.

The UL power control is supported to compensate the path loss, shadowing, fast fading and implementation loss as well as to mitigate inter-cell and intra-cell interference. The BS can transmit necessary information through control channel or message to terminals to support UL power control. The parameters of power control algorithm are optimized on system-wide basis by the BS and broadcasted periodically.

In high-mobility scenarios, power control scheme may not be able to compensate the fast fading channel effect because of the variations of the channel impulse response. As a result, the power control is used to compensate the distance-dependent path loss, shadowing and implementation loss only.

The channel variations and implementation loss are compensated via open-loop power control without frequently interacting with the BS. The terminal can determine the transmit power based on the transmission parameters sent by the serving BS, UL channel transmission quality, DL channel state information, and interference knowledge obtained from DL. Open-loop power control provides a coarse initial power setting of the terminal when an initial connection is established.

The dynamic channel variations are compensated via closed-loop power control with power control commands from the serving BS. The BS measures UL channel state and interference information using UL data and/or control channel transmissions and sends power control commands to the terminal. The terminal adjusts its transmission power based on the power control commands from the BS.

1.1.9 Downlink synchronization

WirelessMAN-Advanced utilizes a new hierarchical structure for the DL synchronization where two types of preambles, a) primary advanced preamble (PA-Preamble) and b) secondary advanced preamble (SA-Preamble), are transmitted (Fig. 2.6). One PA-Preamble symbol and two SA-Preamble symbols exist within the superframe. The location of the A-Preamble symbol is specified as the first symbol of frame except for the last frame. PA-Preamble is located at the first symbol of second frame in a superframe while SA-Preamble is located at the first symbol of the first and the third frames. The PA-Preamble carries information about system bandwidth and carrier configuration. The PA-Preamble has a fixed bandwidth of 5 MHz. A frequency reuse of one is applied to the PA-Preamble in frequency domain. SA-Preamble is repeated once every two frames and spans the entire system bandwidth and carries the cell ID. A frequency reuse of three is used for this set of sequences to mitigate inter-cell interference. SA-Preamble carries 768 distinct cell IDs.

The set of SA-Preamble sequences is partitioned and each partition is dedicated to specific BS type such as macro BS, femto BS, etc. The partition information is broadcasted in the secondary SFH and AAI-SCD message.

FIGURE 2.6
Structure of advanced preambles

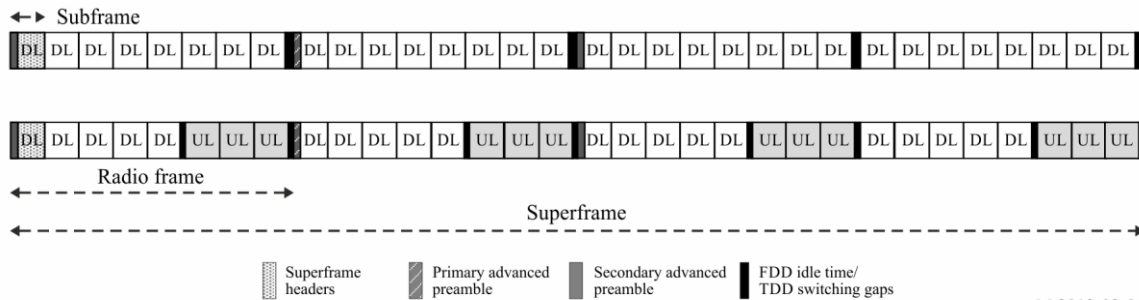

M.2012-02-06

1.1.10 Multi-antenna techniques

1.1.10.1 MIMO structure

WirelessMAN-Advanced supports several advanced multi-antenna techniques including single and multi-user MIMO (spatial multiplexing and beamforming) as well as a number of transmit diversity schemes. In single-user MIMO (SU-MIMO) scheme only one user can be scheduled over one (time, frequency, space) resource unit. In multi-user MIMO (MU-MIMO), on the other hand, multiple users can be scheduled in one resource unit. Vertical encoding utilizes one encoder block (or layer), whereas multi-layer encoding uses multiple encoders (or multiple layers). A layer is defined as a coding and modulation input path to the MIMO encoder. A stream is defined as the output of the MIMO encoder that is further processed through the beamforming or the precoder block. For spatial multiplexing, the rank is defined as the number of streams to be used for the user.

FIGURE 2.7
MIMO structure

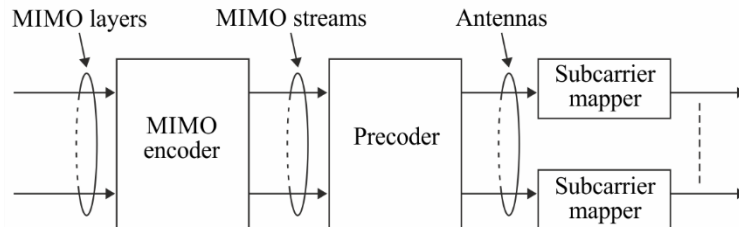

M.2012-02-07

The MIMO transmitter structure is shown in Fig. 2.7. The encoder block contains the channel encoder, interleaving, rate-matching, and modulating blocks per layer. The resource mapping block maps the complex-valued modulation symbols to the corresponding time-frequency resources. The MIMO encoder block maps the layers onto the streams, which are further processed through the precoder block.

The precoder block maps the streams to antennas by generating the antenna-specific data symbols according to the selected MIMO mode. The OFDM symbol construction block maps antenna-specific data to the OFDM symbols. Table 2.2 contains information on various MIMO modes supported by WirelessMAN-Advanced.

TABLE 2.2
DL MIMO modes

Mode index	Description	MIMO encoding format	MIMO precoding
Mode 0	Open-Loop SU-MIMO (TX Diversity)	Space-Frequency Block Coding (SFBC)	Non-Adaptive
Mode 1	Open-Loop SU-MIMO (Spatial Multiplexing)	Vertical Encoding	Non-Adaptive
Mode 2	Closed-Loop SU-MIMO (Spatial Multiplexing)	Vertical Encoding	Adaptive
Mode 3	Open-Loop MU-MIMO (Spatial Multiplexing)	Multi-layer Encoding	Non-Adaptive
Mode 4	Closed-Loop MU-MIMO (Spatial Multiplexing)	Multi-layer Encoding	Adaptive
Mode 5	Open-Loop SU-MIMO (TX Diversity)	Conjugate Data Repetition (CDR)	Non-Adaptive

The minimum antenna configuration in the DL and UL is 2×2 and 1×2 , respectively. For open-loop spatial multiplexing and closed-loop SU-MIMO, the number of streams is constrained to the minimum of number of transmit or receive antennas. The MU-MIMO can support up to two streams with two transmit antennas and up to four streams for four transmit antennas and up to eight streams for eight transmit antennas. Table 2.3 summarized the DL MIMO parameters for various MIMO modes.

TABLE 2.3
DL MIMO parameters

	Number of transmit antennas	STC rate per layer	Number of streams	Number of subcarriers	Number of layers
MIMO Mode 0	2	1	2	2	1
	4	1	2	2	1
	8	1	2	2	1
MIMO Mode 1 and MIMO Mode 2	2	1	1	1	1
	2	2	2	1	1
	4	1	1	1	1
	4	2	2	1	1
	4	3	3	1	1
	4	4	4	1	1
	8	1	1	1	1
	8	2	2	1	1
	8	3	3	1	1
	8	4	4	1	1
	8	5	5	1	1
	8	6	6	1	1
	8	7	7	1	1
8	8	8	1	1	

	Number of transmit antennas	STC rate per layer	Number of streams	Number of subcarriers	Number of layers
MIMO Mode 3 and MIMO Mode 4	2	1	2	1	2
	4	1	2	1	2
	4	1	3	1	3
	4	1	4	1	4
	8	1	2	1	2
	8	1	3	1	3
	8	1	4	1	4
MIMO Mode 4	4	2 and 1 ^a	3	1	2
	4	2 and 1 ^b	4	1	3
	4	2	4	1	2
	8	2 and 1 ^a	3	1	2
	8	2 and 1 ^b	4	1	3
	8	2	4	1	2
	8	1	8	1	8
	8	2 and 1 ^c	8	1	7
	8	2 and 1 ^d	8	1	6
	8	2 and 1 ^e	8	1	5
	8	2	8	1	4

TABLE 2.3 (*end*)

	Number of transmit antennas	STC rate per layer	Number of streams	Number of subcarriers	Number of layers
MIMO Mode 5	2	1/2	1	2	1
	4	1/2	1	2	1
	7	1/2	1	2	1

- ^a 2 streams to one MS and 1 stream to another MS, with 1 layer each.
- ^b 2 streams to one MS and 1 stream each to the other two MSs, with 1 layer each.
- ^c 2 streams to one MS and 1 stream each to the other six MSs, with 1 layer each.
- ^d 2 streams each to two MS and 1 stream each to the other four MSs, with 1 layer each.
- ^e 2 streams each to three MS and 1 stream each to the other two MSs, with 1 layer each.

The stream to antenna mapping depends on the MIMO scheme. In DL, the CQI and rank feedback are transmitted to assist the BS in rank adaptation, mode switching, and rate adaptation. For spatial multiplexing, the rank is defined as the number of streams to be used for each user. In FDD and TDD systems, unitary codebook based precoding is used for closed-loop SU-MIMO. In DL, an MS may feedback some information to the BS in closed-loop SU-MIMO such as rank, sub-band selection, CQI, precoding matrix index (PMI), and long-term channel state information.

In DL, the MU-MIMO transmission with up to two streams per user is supported. Beamforming is enabled with this precoding mechanism. *WirelessMAN-Advanced* has the capability to adapt between SU-MIMO and MU-MIMO in a predefined and flexible manner. Multi-BS MIMO techniques are also supported for improving sector and cell-edge throughput using multi-BS collaborative precoding, network coordinated beamforming, or inter-cell interference cancellation.

For UL MIMO, the BS will schedule users to resource blocks and determines the modulation and coding scheme (MCS) level and MIMO parameters (mode, rank, etc.). The supported antenna configurations include one, two or four transmit antennas and more than two receive antennas. The UL MIMO modes and parameters are shown in Table 2.4 and Table 2.5, respectively.

TABLE 2.4
UL MIMO modes

Mode Index	Description	MIMO Encoding Format	MIMO Precoding
Mode 0	Open-Loop SU-MIMO (TX Diversity)	SFBC	Non-Adaptive
Mode 1	Open-Loop SU-MIMO (Spatial Multiplexing)	Vertical Encoding	Non-Adaptive
Mode 2	Closed-Loop SU-MIMO (Spatial Multiplexing)	Vertical Encoding	Adaptive
Mode 3	Open-Loop Collaborative Spatial Multiplexing (MU-MIMO)	Vertical Encoding	Non-Adaptive
Mode 4	Closed-Loop Collaborative Spatial Multiplexing (MU-MIMO)	Vertical Encoding	Adaptive

TABLE 2.5
UL MIMO parameters

	Number of transmit antennas	STC rate per layer	Number of streams	Number of subcarriers	Number of layers
MIMO Mode 0	2	1	2	2	1
	4	1	2	2	1
MIMO Mode 1	1	1	1	1	1
MIMO Mode 1 and MIMO Mode 2	2	1	1	1	1
	2	2	2	1	1
	4	1	1	1	1
	4	2	2	1	1
	4	3	3	1	1
	4	4	4	1	1
MIMO Mode 3 and MIMO Mode 4	1	1	1	1	1
	2	1	1	1	1
	2	2	2	1	1
	4	1	1	1	1
	4	2	2	1	1
	4	3	3	1	1
	4	4	4	1	1

The supported UL transmit diversity modes include two and four transmit antenna schemes with rate 1 such as space frequency block coding (SFBC) and two stream precoder. In FDD and TDD systems, unitary codebook-based precoding is supported. In this mode, the MS transmits a sounding reference signal in the UL to assist the UL scheduling and precoder selection in the BS. The BS signals the resource allocation, MCS, rank, preferred precoder index, and packet size to the MS. UL MU-MIMO enables multiple MSs to be spatially multiplexed on the same radio resources. Both open-

loop and closed-loop MU-MIMO are supported. The MSs with single transmit antenna can operate in open-loop SU- or MU-MIMO mode.

1.2 Overview of MAC layer

The following sections describe selected MAC features.

1.2.1 MAC addressing

WirelessMAN-Advanced defines global and logical addresses for an MS that identify the user and its connections during a session. The MS is identified by the globally unique 48-bit IEEE extended unique identifier assigned by the IEEE Registration Authority. The MS is further assigned the following logical identifiers: 1) A station identifier during network entry (or network re-entry), that uniquely identifies the MS within the cell, and 2) a flow identifier (FID) that uniquely identifies the control connections and transport connections with the MS. A temporary station identifier is used to protect the mapping between the actual station identifier during network entry. A deregistration identifier is defined to uniquely identify the MS within the set of paging group identifiers, paging cycle, and paging offset.

1.2.2 Network entry

Network entry is the procedure through which an MS detects a cellular network and establishes a connection with that network. The network entry has the following steps (see Fig. 2.8):

- synchronization with the BS by acquiring the preambles;
- acquiring necessary system information such as BS and network service provider identifiers for initial network entry and cell selection;
- initial ranging;
- basic capability negotiation;
- authentication/authorization and key exchange;
- registration and service flow setup.

FIGURE 2.8
Network entry procedures

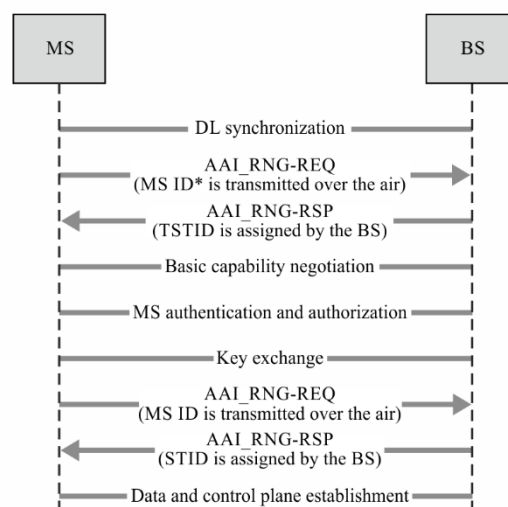

1.2.3 Connection management and quality of service

A connection is defined as a mapping between the MAC layers of a BS and one (or several) MS. If there is a one-to-one mapping between one BS and one MS, the connection is called a unicast connection; otherwise, it is called a multicast or broadcast connection. Two types of connections are specified: control connections and transport connections. Control connections are used to carry MAC control messages. Transport connections are used to carry user data including upper layer signalling messages. A MAC control message is never transferred over transport connection, and user data is never transferred over the control connections. One pair of bi-directional (DL/UL) unicast control connections are automatically established when an MS performs initial network entry.

All the user data communications are in the context of transport connections. A transport connection is unidirectional and established with a unique FID. Each transport connection is associated with an active service flow to provide various levels of QoS required by the service flow. An MS may have multiple transport connections which have different set of QoS parameters, and each transport connection may have one or more sets of QoS parameters.

The transport connection is established when the associated active service flow is admitted or activated, and released when the associated service flow becomes inactive. Transport connections can be preprovisioned or dynamically created. Pre-provisioned connections are those established by system for an MS during the MS network entry. On the other hand, the BS or the MS can create new connections dynamically if required.

2.1.2.4 MAC header

WirelessMAN-Advanced specifies a number of efficient MAC headers for various applications comprising of fewer fields with shorter size compared to the generic MAC header of OFDMA TDD WMAN. The advanced generic MAC header in Fig. 2.9 consists of Extended Header Indicator, FID, and Payload Length fields. Other MAC header types include two-byte short-packet MAC header, which is defined to support small-payload applications such as VoIP and is characterized by small data packets and non-ARQ connection, Fragmentation extended header, Packing extended header for transport connections, MAC Control extended header for control connections, and Multiplexing extended header that is used when data from multiple connections associated with the same security association is present in the payload of the MAC protocol data unit (PDU).

FIGURE 2.9
Advanced generic MAC headers

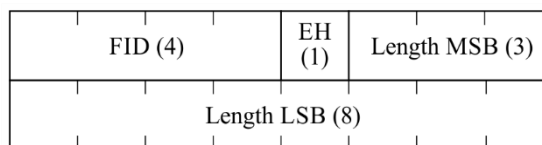

M.2012-02-09

2.1.2.5 ARQ and HARQ functions

An ARQ block is generated from one or multiple MAC service data units (SDUs) or MAC SDU fragment(s). ARQ blocks can be variable in size and are sequentially numbered.

WirelessMAN-Advanced uses adaptive asynchronous and non-adaptive synchronous HARQ schemes in the DL and UL, respectively. The HARQ operation is relying on an N-process (multi-channel) stop-and-wait protocol. In adaptive asynchronous HARQ, the resource allocation and transmission format for the HARQ retransmissions may be different from the initial transmission. In case of retransmission, control signalling is required to indicate the resource allocation and transmission format along with other HARQ necessary parameters. A non-adaptive synchronous

HARQ scheme is used in the UL where the parameters and the resource allocation for the retransmission are known a priori.

1.2.6 Mobility management and handover

WirelessMAN-Advanced supports both network-controlled and MS-assisted handover (HO). As illustrated in Fig. 2.10, the handover procedures may be initiated by either MS or BS; the final handover decision and target BS selection may be made either by the serving BS or the MS. The MS executes the handover or cancels the procedure through HO cancellation message. The network re-entry procedures with the target BS, as shown in Fig. 2.10, may be optimized by target BS possession of MS information obtained from serving BS via core network. The MS may also maintain communication with serving BS while performing network re-entry at target BS as directed by serving BS.

FIGURE 2.10
Handover procedures

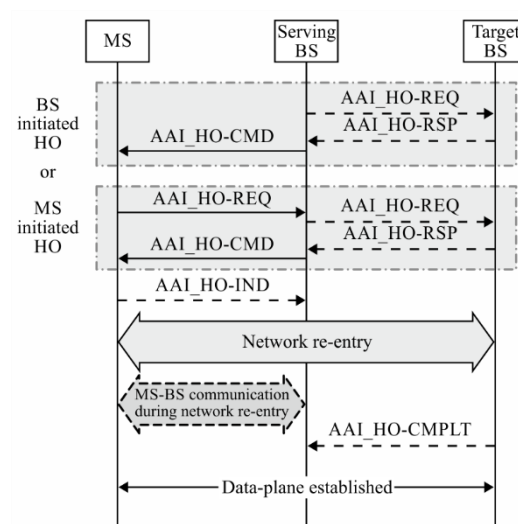

M.2012-02-10

1.2.7 Power management

WirelessMAN-Advanced provides power management functions including sleep mode and idle mode to mitigate power consumption of the MS. Sleep mode is a state in which an MS performs prenegotiated periods of absence from the serving BS. The sleep mode may be enacted when an MS is in the connected state. Using the sleep mode, the MS is provided with a series of alternative listening and sleep windows. The listening window is the time interval in which MS is available for transmit/receive of control signalling and data. The WirelessMAN-Advanced has the capability of dynamically adjusting the duration of sleep and listening windows within a sleep cycle based on changing traffic patterns and HARQ operations. When MS is in active mode, sleep parameters are negotiated between MS and BS. The base station instructs the MS to enter sleep mode. MAC management messages can be used for sleep mode request/response. The period of the sleep cycle is measured in units of frames or superframes and is the sum of a sleep and listening windows. During the MS listening window, BS may transmit the traffic indication message intended for one or multiple MSs. The listening window can be extended through explicit or implicit signalling. The maximum length of the extension is to the end of the current sleep cycle.

Idle mode allows the MS to become periodically available for DL broadcast traffic messaging such as paging message without registration with the network. The network assigns MSs in the idle mode to a paging group during idle mode entry or location update. If an MS is assigned to multiple paging

groups, it may also be assigned multiple paging offsets within a paging cycle where each paging offset corresponds to a separate paging group. The assignment of multiple paging offsets to an MS allows monitoring of the paging messages at different paging offset when the MS is located in one of its paging groups. The distance between two adjacent paging offsets should be long enough so that the MS paged in the first paging offset can inform the network before the next paging offset in the same paging cycle occurs, thereby avoiding unnecessary paging in the next paging offset. The MS monitors the paging message during listening interval. The paging message contains identification of the MSs to be notified of pending traffic or location update. The start of the paging listening interval is calculated based on paging cycle and paging offset are defined in terms of number of superframes.

The serving BS transmits the list of paging group identifiers (PGID) at the predetermined location at the beginning of the paging available interval. During paging available interval, the MS monitors the SFH and if there is an indication of any change in system configuration information, the MS will acquire the latest system information at the next instance of SFH transmission (i.e. next SFH). To provide location privacy, the paging controller assigns Deregistration identifiers to uniquely identify the MSs in the idle mode in a particular paging group.

An MS in idle mode performs location update, if either of these conditions are met, paging group location update, timer based location update, or power down location update. The MS performs the location update when the MS detects a change in paging group by monitoring the PGIDs, which are transmitted by the BS. The MS periodically performs location update procedure prior to the expiration of idle mode timer. At every location update including paging group update, the idle mode timer is reset.

1.2.8 Security

Security functions provide subscribers with privacy, authentication, and confidentiality across WirelessMAN-Advanced network. The PKM protocol provides mutual and unilateral authentication and establishes confidentiality between the MS and the BS by supporting transparent exchange of authentication and authorization (EAP) messages.

The MS and the BS may support encryption methods and algorithms for secure transmission of MAC PDUs. WirelessMAN-Advanced supports selectively confidentiality or integrity protection over MAC control messages. Figure 2.11 shows the functional blocks of security architecture.

FIGURE 2.11
Functional blocks of security architecture

		EAP (out of scope of IEEE 802.16 m specification)
Authorization/Security association control		EAP encapsulation/ De-encapsulation
Location privacy	Enhanced key management	PKM control management
Standalone signaling header authentication	Management message authentication	User data and management message encryption

M.2012-02-11

The security architecture is divided into security management and encryption and integrity logical entities. The security management functions include overall security management and control, EAP encapsulation/de-encapsulation, privacy key management (PKM) control, security association management, and identity/location privacy. To accomplish identity/location privacy, the MSID

(i.e. MS MAC address) is not disclosed over the air even during network entry. The BS assigns a station identifier (STID) to the MS which is securely transmitted to the MS so that the MS's identity and location can be hidden. The encryption and integrity protection entity functions include encryption of user data and authentication, control message authentication, message confidentiality protection.

2 Detailed specification of the radio interface technology¹³

The material in § 2 reflects the structure of the IEEE specifications from the first release of Recommendation ITU-R M.2012 (01-2012) prior to the IEEE revising the structure of the specifications related to WirelessMAN-Advanced on 8 June 2013.

Detailed specifications described in this Annex are developed around a "Global Core Specification" (GCS)¹⁴, which is related to externally developed materials incorporated by specific references for a specific technology. The process and use of the GCS, references, and related notifications and certifications are found as Document IMT-ADV/24(Rev.3).

The IMT-Advanced standards contained in this section are derived from the global core specification for WirelessMAN-Advanced contained at <http://ties.itu.int/u/itu-r/ede/rsg5/IMT-Advanced/GCS/M.2012-0/WirelessMAN-Advanced/>. The following notes apply to the sections below:

- 1) The identified relevant *Transposing Organizations* should make their reference material available from their website.
- 2) This information was supplied by the *Transposing Organizations* and relates to their own deliverables of the transposed global core specification.

2.1 Description of the global core specification and the transposed standards

IEEE Std 802.16 is composed of IEEE Std 802.16-2009, as amended, consecutively, by IEEE Std 802.16j-2009, IEEE Std 802.16h-2010, and IEEE Std 802.16m-2011. IEEE Std 802.16 is described in § 2.2.1.1.

In accordance with Clause 16.1.1 of IEEE Std 802.16, the *WirelessMAN-Advanced* GCS is specified in the clauses of IEEE Std 802.16 as indicated in Table 2.6. Anything in IEEE Std 802.16 that is not included in Table 2.6 is excluded from the *WirelessMAN-Advanced* GCS.

¹³ On 8 June 2012, the IEEE-SA Standards Board approved IEEE Std 802.16.1 (*WirelessMAN-Advanced Air Interface for Broadband Wireless Access Systems*) as a new IEEE standard. IEEE Std 802.16.1 encompasses the WirelessMAN-Advanced air interface, with some minor improvements. On the same date, the Standards Board approved IEEE Std 802.16-2012 as a new revision of IEEE Std 802.16, which now excludes the WirelessMAN-Advanced air interface.

Accordingly, the material in § 2.2 reflects IEEE's structure of the WirelessMAN-Advanced air interface specification IEEE Std 802.16 which is composed of IEEE Std 802.16-2009, as amended, consecutively, by IEEE Std 802.16j-2009, IEEE Std 802.16h-2010, and IEEE Std 802.16m-2011.

¹⁴ A "GCS" (Global Core Specification) is the set of specifications that defines a single RIT, an SRIT, or a RIT within an SRIT.

TABLE 2.6

Description of the *WirelessMAN-Advanced* GCS

IEEE Std 802.16 Clause and Subject	IEEE Std 802.16-2009	IEEE Std 802.16j-2009	IEEE Std 802.16h- 2010	IEEE Std 802.16m-2011
Clause 1.4: Reference models	Base specification		Amended	Amended
Clause 2: Normative references	Base specification		Amended	Amended
Clause 3: Definitions	Base specification	Amended	Amended	Amended
Clause 4: Abbreviations and acronyms	Base specification	Amended	Amended	Amended
Clause 5.2: Packet convergence sublayer	Base specification			Amended
Clause 16: <i>WirelessMAN-Advanced</i> air interface				Base specification
Annex R: MAC control messages				Base specification
Annex S: Test vectors				Base specification
Annex T: Supported frequency bands				Base specification
Annex U: Radio specifications				Base specification
Annex V: Default capability class and parameters				Base specification

2.1.1 IEEE Std 802.16**IEEE Std 802.16: Standard for local and metropolitan area networks – Air interface for broadband wireless access systems**

This standard specifies the air interface, including the medium access control layer (MAC) and physical layer (PHY), of combined fixed and mobile point-to-multipoint broadband wireless access (BWA) systems providing multiple services. The MAC is structured to support multiple PHY specifications, each suited to a particular operational environment.

IEEE Std 802.16 is composed of IEEE Std 802.16-2009, as amended, consecutively, by IEEE Std 802.16j-2009, IEEE Std 802.16h-2010, and IEEE Std 802.16m-2011.

2.1.1.1 IEEE Std 802.16-2009**Standard for local and metropolitan area networks – Part 16: Air interface for broadband wireless access systems**

This standard specifies the air interface, including the medium access control layer (MAC) and physical layer (PHY), of combined fixed and mobile point-to-multipoint broadband wireless access (BWA) systems providing multiple services. The MAC is structured to support multiple PHY specifications, each suited to a particular operational environment.

2.1.1.2 IEEE Std 802.16j-2009

Standard for local and metropolitan area networks – Part 16: Air interface for broadband wireless access systems – Amendment 1: Multiple relay specification

This amendment updates and expands IEEE Std 802.16-2009, specifying physical layer and medium access control layer enhancements to IEEE Std 802.16 for licensed bands to enable the operation of relay stations. Subscriber station specifications are not changed.

2.1.1.3 IEEE Std 802.16h-2010

Standard for local and metropolitan area networks – Part 16: Air interface for broadband wireless access systems – Amendment 2: Improved coexistence mechanisms for license-exempt operation

This amendment updates and expands IEEE Std 802.16, specifying improved mechanisms, as policies and medium access control enhancements, to enable coexistence among license-exempt systems and to facilitate the coexistence of such systems with primary users.

2.1.1.4 IEEE Std 802.16m-2011

Standard for local and metropolitan area networks – Part 16: Air interface for broadband wireless access systems – Amendment 3: Advanced air interface

This amendment specifies the *WirelessMAN-Advanced* air interface, an enhanced air interface designed to meet the requirements of the IMT-Advanced standardization activity conducted by the ITU-R. The amendment is based on the WirelessMAN-OFDMA specification of IEEE Std 802.16 and provides continuing support for WirelessMAN-OFDMA subscriber stations.

2.1.2 Transposed standards

2.1.2.1 Transpositions: IEEE

Reserved.

2.1.2.2 Transpositions: ARIB

	Base specification per IEEE Std 802.16-2009	Amendment per IEEE Std 802.16j-2009	Amendment per IEEE Std 802.16h-2010	Amendment per IEEE Std 802.16m-2011
Transposing Organization	ARIB	ARIB	ARIB	ARIB
Document number	ARIB STD-T105 Annex 1	ARIB STD-T105 Annex 2	ARIB STD-T105 Annex 3	ARIB STD-T105 Annex 4
Version	1.30	1.30	1.30	1.30
Date	18 December 2012	18 December 2012	18 December 2012	18 December 2012
Clause 1.4: Reference models	http://www.arib.or.jp/IMT-Advanced/WirelessMAN-Advanced.1.30/ARIB%20STD-T105%20Annex%201_IEEE%20Std%20802%2016-2009.pdf (Clause 1.4, ARIB transposition of IEEE Std 802.16-2009)	Not applicable	http://www.arib.or.jp/IMT-Advanced/WirelessMAN-Advanced.1.30/ARIB%20STD-T105%20Annex%203_IEEE%20Std%20802%2016h-2010.pdf (Clause 1.4, ARIB transposition of IEEE Std 802.16h)	http://www.arib.or.jp/IMT-Advanced/WirelessMAN-Advanced.1.30/ARIB%20STD-T105%20Annex%204_IEEE%20Std%20802%2016m-2011.pdf (Clause 1.4, ARIB transposition of IEEE Std 802.16m)

	Base specification per IEEE Std 802.16-2009	Amendment per IEEE Std 802.16j-2009	Amendment per IEEE Std 802.16h-2010	Amendment per IEEE Std 802.16m-2011
Clause 2: Normative references	http://www.arib.or.jp/IMT-Advanced/WirelessMAN-Advanced.1.30/ARIB%20STD-T105%20Annex%201-IEE%20Std%20802%2016-2009.pdf (Clause 2, ARIB transposition of IEEE Std 802.16-2009)	Not applicable	http://www.arib.or.jp/IMT-Advanced/WirelessMAN-Advanced.1.30/ARIB%20STD-T105%20Annex%203-IEE%20Std%20802%2016-h-2010.pdf (Clause 2, ARIB transposition of IEEE Std 802.16h)	http://www.arib.or.jp/IMT-Advanced/WirelessMAN-Advanced.1.30/ARIB%20STD-T105%20Annex%204-IEE%20Std%20802%2016-m-2011.pdf (Clause 2, ARIB transposition of IEEE Std 802.16m)
Clause 3: Definitions	http://www.arib.or.jp/IMT-Advanced/WirelessMAN-Advanced.1.30/ARIB%20STD-T105%20Annex%201-IEE%20Std%20802%2016-2009.pdf (Clause 3, ARIB transposition of IEEE Std 802.16-2009)	http://www.arib.or.jp/IMT-Advanced/WirelessMAN-Advanced.1.30/ARIB%20STD-T105%20Annex%202-IEE%20Std%20802%2016j-2009.pdf (Clause 3, ARIB transposition of IEEE Std 802.16j)	http://www.arib.or.jp/IMT-Advanced/WirelessMAN-Advanced.1.30/ARIB%20STD-T105%20Annex%203-IEE%20Std%20802%2016-h-2010.pdf (Clause 3, ARIB transposition of IEEE Std 802.16h)	http://www.arib.or.jp/IMT-Advanced/WirelessMAN-Advanced.1.30/ARIB%20STD-T105%20Annex%204-IEE%20Std%20802%2016-m-2011.pdf (Clause 3, ARIB transposition of IEEE Std 802.16m)
Clause 4: Abbreviations and acronyms	http://www.arib.or.jp/IMT-Advanced/WirelessMAN-Advanced.1.30/ARIB%20STD-T105%20Annex%201-IEE%20Std%20802%2016-2009.pdf (Clause 4, ARIB transposition of IEEE Std 802.16-2009)	http://www.arib.or.jp/IMT-Advanced/WirelessMAN-Advanced.1.30/ARIB%20STD-T105%20Annex%202-IEE%20Std%20802%2016j-2009.pdf (Clause 4, ARIB transposition of IEEE Std 802.16j)	http://www.arib.or.jp/IMT-Advanced/WirelessMAN-Advanced.1.30/ARIB%20STD-T105%20Annex%203-IEE%20Std%20802%2016-h-2010.pdf (Clause 4, ARIB transposition of IEEE Std 802.16h)	http://www.arib.or.jp/IMT-Advanced/WirelessMAN-Advanced.1.30/ARIB%20STD-T105%20Annex%204-IEE%20Std%20802%2016-m-2011.pdf (Clause 4, ARIB transposition of IEEE Std 802.16m)
Clause 5.2: Packet convergence sublayer	http://www.arib.or.jp/IMT-Advanced/WirelessMAN-Advanced.1.30/ARIB%20STD-T105%20Annex%201-IEE%20Std%20802%2016-2009.pdf (Clause 5.2, ARIB transposition of IEEE Std 802.16-2009)	Not applicable	Not applicable	http://www.arib.or.jp/IMT-Advanced/WirelessMAN-Advanced.1.30/ARIB%20STD-T105%20Annex%204-IEE%20Std%20802%2016-m-2011.pdf (Clause 5.2, ARIB transposition of IEEE Std 802.16m)
Clause 16: WirelessMAN- Advanced air interface	Not applicable	Not applicable	Not applicable	http://www.arib.or.jp/IMT-Advanced/WirelessMAN-Advanced.1.30/ARIB%20STD-T105%20Annex%204-IEE%20Std%20802%2016-m-2011.pdf (Clause 16, ARIB transposition of IEEE Std 802.16m)
Annex R: MAC control messages	Not applicable	Not applicable	Not applicable	http://www.arib.or.jp/IMT-Advanced/WirelessMAN-Advanced.1.30/ARIB%20STD-T105%20Annex%204-IEE%20Std%20802%2016-m-2011.pdf (Annex R, ARIB transposition of IEEE Std 802.16m)

	Base specification per IEEE Std 802.16-2009	Amendment per IEEE Std 802.16j-2009	Amendment per IEEE Std 802.16h-2010	Amendment per IEEE Std 802.16m-2011
Annex S: Test vectors	Not applicable	Not applicable	Not applicable	http://www.arib.or.jp/IMT-Advanced/WirelessMAN-Advanced.1.30/ARIB%20STD-T105%20Annex%204_IEEE%20Std%20802%2016m-2011.pdf (Annex S, ARIB transposition of IEEE Std 802.16m)
Annex T: Supported frequency bands	Not applicable	Not applicable	Not applicable	http://www.arib.or.jp/IMT-Advanced/WirelessMAN-Advanced.1.30/ARIB%20STD-T105%20Annex%204_IEEE%20Std%20802%2016m-2011.pdf (Annex T, ARIB transposition of IEEE Std 802.16m)
Annex U: Radio specifications	Not applicable	Not applicable	Not applicable	http://www.arib.or.jp/IMT-Advanced/WirelessMAN-Advanced.1.30/ARIB%20STD-T105%20Annex%204_IEEE%20Std%20802%2016m-2011.pdf (Annex U, ARIB transposition of IEEE Std 802.16m)
Annex V: Default capability class and parameters	Not applicable	Not applicable	Not applicable	http://www.arib.or.jp/IMT-Advanced/WirelessMAN-Advanced.1.30/ARIB%20STD-T105%20Annex%204_IEEE%20Std%20802%2016m-2011.pdf (Annex V, ARIB transposition of IEEE Std 802.16m)

2.1.2.3 Transpositions: TTA

	Base specification per IEEE Std 802.16-2009	Amendment per IEEE Std 802.16j-2009	Amendment per IEEE Std 802.16h-2010	Amendment per IEEE Std 802.16m-2011
Transposing Organization	TTA	TTA	TTA	TTA
Document number	TTAE.IE-802.16-2009	TTAE.IE-802.16j	TTAE.IE-802.16h	TTAE.IE-802.16m
Version	1.0	1.0	1.0	1.0
Date	29 June 2011	29 June 2011	29 June 2011	29 June 2011

	Base specification per IEEE Std 802.16-2009	Amendment per IEEE Std 802.16j-2009	Amendment per IEEE Std 802.16h-2010	Amendment per IEEE Std 802.16m-2011
Clause 1.4: Reference models	<a href="http://www.tta.or.kr/data/tt
asDown.jsp?where=14688
&pk_num=TTAE.IE-
802.16-2009">http://www.tta.or.kr/data/tt asDown.jsp?where=14688 &pk_num=TTAE.IE- 802.16-2009 (Clause 1.4, TTA transposition of IEEE Std 802.16-2009)	Not applicable	<a href="http://www.tta.or.kr/data/tt
asDown.jsp?where=14688
&pk_num=TTAE.IE-
802.16h">http://www.tta.or.kr/data/tt asDown.jsp?where=14688 &pk_num=TTAE.IE- 802.16h (Clause 1.4, TTA transposition of IEEE Std 802.16h)	<a href="http://www.tta.or.kr/data/tt
asDown.jsp?where=14688
&pk_num=TTAE.IE-
802.16m">http://www.tta.or.kr/data/tt asDown.jsp?where=14688 &pk_num=TTAE.IE- 802.16m (Clause 1.4, TTA transposition of IEEE Std 802.16m)
Clause 2: Normative references	<a href="http://www.tta.or.kr/data/tt
asDown.jsp?where=14688
&pk_num=TTAE.IE-
802.16-2009">http://www.tta.or.kr/data/tt asDown.jsp?where=14688 &pk_num=TTAE.IE- 802.16-2009 (Clause 2, TTA transposition of IEEE Std 802.16-2009)	Not applicable	<a href="http://www.tta.or.kr/data/tt
asDown.jsp?where=14688
&pk_num=TTAE.IE-
802.16h">http://www.tta.or.kr/data/tt asDown.jsp?where=14688 &pk_num=TTAE.IE- 802.16h (Clause 2, TTA transposition of IEEE Std 802.16h)	<a href="http://www.tta.or.kr/data/tt
asDown.jsp?where=14688
&pk_num=TTAE.IE-
802.16m">http://www.tta.or.kr/data/tt asDown.jsp?where=14688 &pk_num=TTAE.IE- 802.16m (Clause 2, TTA transposition of IEEE Std 802.16m)
Clause 3: Definitions	<a href="http://www.tta.or.kr/data/tt
asDown.jsp?where=14688
&pk_num=TTAE.IE-
802.16-2009">http://www.tta.or.kr/data/tt asDown.jsp?where=14688 &pk_num=TTAE.IE- 802.16-2009 (Clause 3, TTA transposition of IEEE Std 802.16-2009)	<a href="http://www.tta.or.kr/data/tt
asDown.jsp?where=14688
&pk_num=TTAE.IE-
802.16j">http://www.tta.or.kr/data/tt asDown.jsp?where=14688 &pk_num=TTAE.IE- 802.16j (Clause 3, TTA transposition of IEEE Std 802.16j)	<a href="http://www.tta.or.kr/data/tt
asDown.jsp?where=14688
&pk_num=TTAE.IE-
802.16h">http://www.tta.or.kr/data/tt asDown.jsp?where=14688 &pk_num=TTAE.IE- 802.16h (Clause 3, TTA transposition of IEEE Std 802.16h)	<a href="http://www.tta.or.kr/data/tt
asDown.jsp?where=14688
&pk_num=TTAE.IE-
802.16m">http://www.tta.or.kr/data/tt asDown.jsp?where=14688 &pk_num=TTAE.IE- 802.16m (Clause 3, TTA transposition of IEEE Std 802.16m)
Clause 4: Abbreviations and acronyms	<a href="http://www.tta.or.kr/data/tt
asDown.jsp?where=14688
&pk_num=TTAE.IE-
802.16-2009">http://www.tta.or.kr/data/tt asDown.jsp?where=14688 &pk_num=TTAE.IE- 802.16-2009 (Clause 4, TTA transposition of IEEE Std 802.16-2009)	<a href="http://www.tta.or.kr/data/tt
asDown.jsp?where=14688
&pk_num=TTAE.IE-
802.16j">http://www.tta.or.kr/data/tt asDown.jsp?where=14688 &pk_num=TTAE.IE- 802.16j (Clause 4, TTA transposition of IEEE Std 802.16j)	<a href="http://www.tta.or.kr/data/tt
asDown.jsp?where=14688
&pk_num=TTAE.IE-
802.16h">http://www.tta.or.kr/data/tt asDown.jsp?where=14688 &pk_num=TTAE.IE- 802.16h (Clause 4, TTA transposition of IEEE Std 802.16h)	<a href="http://www.tta.or.kr/data/tt
asDown.jsp?where=14688
&pk_num=TTAE.IE-
802.16m">http://www.tta.or.kr/data/tt asDown.jsp?where=14688 &pk_num=TTAE.IE- 802.16m (Clause 4, TTA transposition of IEEE Std 802.16m)
Clause 5.2: Packet convergence sublayer	<a href="http://www.tta.or.kr/data/tt
asDown.jsp?where=14688
&pk_num=TTAE.IE-
802.16-2009">http://www.tta.or.kr/data/tt asDown.jsp?where=14688 &pk_num=TTAE.IE- 802.16-2009 (Clause 5.2, TTA transposition of IEEE Std 802.16-2009)	Not applicable	Not applicable	<a href="http://www.tta.or.kr/data/tt
asDown.jsp?where=14688
&pk_num=TTAE.IE-
802.16m">http://www.tta.or.kr/data/tt asDown.jsp?where=14688 &pk_num=TTAE.IE- 802.16m (Clause 5.2, TTA transposition of IEEE Std 802.16m)
Clause 16: WirelessMAN- Advanced air interface	Not applicable	Not applicable	Not applicable	<a href="http://www.tta.or.kr/data/tt
asDown.jsp?where=14688
&pk_num=TTAE.IE-
802.16m">http://www.tta.or.kr/data/tt asDown.jsp?where=14688 &pk_num=TTAE.IE- 802.16m (Clause 16, TTA transposition of IEEE Std 802.16m)
Annex R: MAC control messages	Not applicable	Not applicable	Not applicable	<a href="http://www.tta.or.kr/data/tt
asDown.jsp?where=14688
&pk_num=TTAE.IE-
802.16m">http://www.tta.or.kr/data/tt asDown.jsp?where=14688 &pk_num=TTAE.IE- 802.16m (Annex R, TTA transposition of IEEE Std 802.16m)
Annex S: Test vectors	Not applicable	Not applicable	Not applicable	<a href="http://www.tta.or.kr/data/tt
asDown.jsp?where=14688
&pk_num=TTAE.IE-
802.16m">http://www.tta.or.kr/data/tt asDown.jsp?where=14688 &pk_num=TTAE.IE- 802.16m (Annex S, TTA transposition of IEEE Std 802.16m)

	Base specification per IEEE Std 802.16-2009	Amendment per IEEE Std 802.16j-2009	Amendment per IEEE Std 802.16h-2010	Amendment per IEEE Std 802.16m-2011
Annex T: Supported frequency bands	Not applicable	Not applicable	Not applicable	<a href="http://www.tta.or.kr/data/tt
asDown.jsp?where=14688
&pk_num=TTAE.IE-
802.16m">http://www.tta.or.kr/data/tt asDown.jsp?where=14688 &pk_num=TTAE.IE- 802.16m (Annex T, TTA transposition of IEEE Std 802.16m)
Annex U: Radio specifications	Not applicable	Not applicable	Not applicable	<a href="http://www.tta.or.kr/data/tt
asDown.jsp?where=14688
&pk_num=TTAE.IE-
802.16m">http://www.tta.or.kr/data/tt asDown.jsp?where=14688 &pk_num=TTAE.IE- 802.16m (Annex U, TTA transposition of IEEE Std 802.16m)
Annex V: Default capability class and parameters	Not applicable	Not applicable	Not applicable	<a href="http://www.tta.or.kr/data/tt
asDown.jsp?where=14688
&pk_num=TTAE.IE-
802.16m">http://www.tta.or.kr/data/tt asDown.jsp?where=14688 &pk_num=TTAE.IE- 802.16m (Annex V, TTA transposition of IEEE Std 802.16m)

2.1.2.4 Transpositions: WiMAX Forum

	Base specification per IEEE Std 802.16-2009	Amendment per IEEE Std 802.16j-2009	Amendment per IEEE Std 802.16h-2010	Amendment per IEEE Std 802.16m-2011
Transposing Organization	WIMAX FORUM	WIMAX FORUM	WIMAX FORUM	WIMAX FORUM
Document number	T28-001-R020v01, WIMAX FORUM transposition of IEEE Std 802.16-2009	T28-001-R020v01, WIMAX FORUM transposition of IEEE Std 802.16j	T28-001-R020v01, WIMAX FORUM transposition of IEEE Std 802.16h	T28-001-R020v01, WIMAX FORUM transposition of IEEE Std 802.16m
Version	V01	V01	V01	V01
Date	20 September 2011	20 September 2011	20 September 2011	20 September 2011
Clause 1.4: Reference models	<a href="http://www.wimaxforum.o
rg/files/WMF-IMT-
Advanced-Spec-T28-001-
R020v01.pdf">http://www.wimaxforum.o rg/files/WMF-IMT- Advanced-Spec-T28-001- R020v01.pdf (Clause 1.4, WIMAX FORUM transposition of IEEE Std 802.16-2009)	Not applicable	<a href="http://www.wimaxforum.o
rg/files/WMF-IMT-
Advanced-Spec-T28-001-
R020v01.pdf">http://www.wimaxforum.o rg/files/WMF-IMT- Advanced-Spec-T28-001- R020v01.pdf (Clause 1.4, WIMAX FORUM transposition of IEEE Std 802.16h)	<a href="http://www.wimaxforum.o
rg/files/WMF-IMT-
Advanced-Spec-T28-001-
R020v01.pdf">http://www.wimaxforum.o rg/files/WMF-IMT- Advanced-Spec-T28-001- R020v01.pdf (Clause 1.4, WIMAX FORUM transposition of IEEE Std 802.16m)
Clause 2: Normative references	<a href="http://www.wimaxforum.o
rg/files/WMF-IMT-
Advanced-Spec-T28-001-
R020v01.pdf">http://www.wimaxforum.o rg/files/WMF-IMT- Advanced-Spec-T28-001- R020v01.pdf (Clause 2, WIMAX FORUM transposition of IEEE Std 802.16-2009)	Not applicable	<a href="http://www.wimaxforum.o
rg/files/WMF-IMT-
Advanced-Spec-T28-001-
R020v01.pdf">http://www.wimaxforum.o rg/files/WMF-IMT- Advanced-Spec-T28-001- R020v01.pdf (Clause 2, WIMAX FORUM transposition of IEEE Std 802.16h)	<a href="http://www.wimaxforum.o
rg/files/WMF-IMT-
Advanced-Spec-T28-001-
R020v01.pdf">http://www.wimaxforum.o rg/files/WMF-IMT- Advanced-Spec-T28-001- R020v01.pdf (Clause 2, WIMAX FORUM transposition of IEEE Std 802.16m)
Clause 3: Definitions	<a href="http://www.wimaxforum.o
rg/files/WMF-IMT-
Advanced-Spec-T28-001-
R020v01.pdf">http://www.wimaxforum.o rg/files/WMF-IMT- Advanced-Spec-T28-001- R020v01.pdf (Clause 3, WIMAX FORUM transposition of IEEE Std 802.16-2009)	<a href="http://www.wimaxforum.o
rg/files/WMF-IMT-
Advanced-Spec-T28-001-
R020v01.pdf">http://www.wimaxforum.o rg/files/WMF-IMT- Advanced-Spec-T28-001- R020v01.pdf (Clause 3, WIMAX FORUM transposition of IEEE Std 802.16j)	<a href="http://www.wimaxforum.o
rg/files/WMF-IMT-
Advanced-Spec-T28-001-
R020v01.pdf">http://www.wimaxforum.o rg/files/WMF-IMT- Advanced-Spec-T28-001- R020v01.pdf (Clause 3, WIMAX FORUM transposition of IEEE Std 802.16h)	<a href="http://www.wimaxforum.o
rg/files/WMF-IMT-
Advanced-Spec-T28-001-
R020v01.pdf">http://www.wimaxforum.o rg/files/WMF-IMT- Advanced-Spec-T28-001- R020v01.pdf (Clause 3, WIMAX FORUM transposition of IEEE Std 802.16m)

	Base specification per IEEE Std 802.16-2009	Amendment per IEEE Std 802.16j-2009	Amendment per IEEE Std 802.16h-2010	Amendment per IEEE Std 802.16m-2011
Clause 4: Abbreviations and acronyms	http://www.wimaxforum.org/files/WMF-IMT-Advanced-Spec-T28-001-R020v01.pdf (Clause 4, WIMAX FORUM transposition of IEEE Std 802.16-2009)	http://www.wimaxforum.org/files/WMF-IMT-Advanced-Spec-T28-001-R020v01.pdf (Clause 4, WIMAX FORUM transposition of IEEE Std 802.16j)	http://www.wimaxforum.org/files/WMF-IMT-Advanced-Spec-T28-001-R020v01.pdf (Clause 4, WIMAX FORUM transposition of IEEE Std 802.16h)	http://www.wimaxforum.org/files/WMF-IMT-Advanced-Spec-T28-001-R020v01.pdf (Clause 4, WIMAX FORUM transposition of IEEE Std 802.16m)
Clause 5.2: Packet convergence sublayer	http://www.wimaxforum.org/files/WMF-IMT-Advanced-Spec-T28-001-R020v01.pdf (Clause 5.2, WIMAX FORUM transposition of IEEE Std 802.16-2009)	Not applicable	Not applicable	http://www.wimaxforum.org/files/WMF-IMT-Advanced-Spec-T28-001-R020v01.pdf (Clause 5.2, WIMAX FORUM transposition of IEEE Std 802.16m)
Clause 16: WirelessMAN- Advanced air interface	Not applicable	Not applicable	Not applicable	http://www.wimaxforum.org/files/WMF-IMT-Advanced-Spec-T28-001-R020v01.pdf (Clause 16, WIMAX FORUM transposition of IEEE Std 802.16m)
Annex R: MAC control messages	Not applicable	Not applicable	Not applicable	http://www.wimaxforum.org/files/WMF-IMT-Advanced-Spec-T28-001-R020v01.pdf (Annex R, WIMAX FORUM transposition of IEEE Std 802.16m)
Annex S: Test vectors	Not applicable	Not applicable	Not applicable	http://www.wimaxforum.org/files/WMF-IMT-Advanced-Spec-T28-001-R020v01.pdf (Annex S, WIMAX FORUM transposition of IEEE Std 802.16m)
Annex T: Supported frequency bands	Not applicable	Not applicable	Not applicable	http://www.wimaxforum.org/files/WMF-IMT-Advanced-Spec-T28-001-R020v01.pdf (Annex T, WIMAX FORUM transposition of IEEE Std 802.16m)
Annex U: Radio specifications	Not applicable	Not applicable	Not applicable	http://www.wimaxforum.org/files/WMF-IMT-Advanced-Spec-T28-001-R020v01.pdf (Annex U, WIMAX FORUM transposition of IEEE Std 802.16m)
Annex V: Default capability class and parameters	Not applicable	Not applicable	Not applicable	http://www.wimaxforum.org/files/WMF-IMT-Advanced-Spec-T28-001-R020v01.pdf (Annex V, WIMAX FORUM transposition of IEEE Std 802.16m)

3 Detailed specification of the radio interface technology¹⁵

The material in § 2.3 reflects the structure of the IEEE specifications subsequent to the IEEE revising the structure of the relevant IEEE specifications related to WirelessMAN-Advanced on 8 June 2013 beginning with Revision 1 of Recommendation ITU-R M.2012 (2014).

Detailed specifications described in this Annex are developed around a “Global Core Specification” (GCS), which is related to externally developed materials incorporated by specific references for a specific technology. The process and use of the GCS, references, and related notifications and certifications are found as Document IMT-ADV/24(Rev.3).

The IMT-Advanced standards contained in this section are derived from the global core specification for WirelessMAN-Advanced contained at <http://ties.itu.int/u/itu-r/ede/rsg5/IMT-Advanced/GCS/M.2012-1/WirelessMAN-Advanced/>. The following notes apply to the sections below:

- 1) The identified relevant Transposing Organizations should make their reference material available from their website.
- 2) This information was supplied by the *Transposing Organizations* and relates to their own deliverables of the transposed global core specification.

3.1 Description of the global core specification and the transposed standards

IEEE Std 802.16.1 is composed of IEEE Std 802.16.1-2012, as amended, consecutively, by IEEE Std 802.16.1b-2012 and IEEE Std 802.16.1a-2013. IEEE Std 802.16.1 is described in § 3.1.1.

¹⁵ On 8 June 2012, the IEEE-SA Standards Board approved IEEE Std 802.16.1 (*WirelessMAN-Advanced Air Interface for Broadband Wireless Access Systems*) as a new IEEE standard. IEEE Std 802.16.1 encompasses the WirelessMAN-Advanced air interface, with some minor improvements. On the same date, the Standards Board approved IEEE Std 802.16-2012 as a new revision of IEEE Std 802.16, which now excludes the WirelessMAN-Advanced air interface.

Accordingly, the material in § 3 reflects IEEE’s transfer of the WirelessMAN-Advanced air interface specification to IEEE Std 802.16.1. The WirelessMAN-Advanced GCS for § 3 includes IEEE Std 802.16.1 but not IEEE Std 802.16.

IEEE has further enhanced IEEE Std 802.16.1 with two amendments:

- IEEE Std 802.16.1a: WirelessMAN-Advanced Air Interface for Broadband Wireless Access Systems – Amendment: Higher Reliability Networks.
- IEEE Std 802.16.1b: WirelessMAN-Advanced Air Interface for Broadband Wireless Access Systems – Amendment: Enhancements to Support Machine-to-Machine Applications.

The content of these two standards is also included in § 3.

TABLE 2.7

Description of the *WirelessMAN-Advanced* GCS

IEEE Std 802.16.1 Clause and Subject	IEEE Std 802.16.1-2012	IEEE Std 802.16.1b-2012	IEEE Std 802.16.1a-2013
Clause 1: Overview	Base specification	Amended	Amended
Clause 2: Normative references	Base specification		
Clause 3: Definitions	Base specification	Amended	Amended
Clause 4: Abbreviations and acronyms	Base specification		Amended
Clause 5: Service-Specific Convergence Sublayer	Base specification		Amended
Clause 6: WirelessMAN-Advanced Air Interface	Base specification	Amended	Amended
Annex A: Bibliography	Base specification		
Annex B: Control Messages	Base specification	Amended	Amended
Annex C: Test Vectors	Base specification		
Annex D: Supported frequency bands	Base specification		
Annex E: Radio specifications	Base specification		
Annex F: Default capability class and parameters	Base specification		

3.1.1 IEEE Std 802.16.1**IEEE Std 802.16.1: IEEE Standard for WirelessMAN-Advanced Air Interface for Broadband Wireless Access Systems**

This standard specifies the WirelessMAN-Advanced Air Interface, including the medium access control layer (MAC) and physical layer (PHY), of a broadband wireless access (BWA) system supporting multiple services

IEEE Std 802.16.1 is composed of IEEE Std 802.16.1-2012, as amended, consecutively, by IEEE Std 802.16.1b-2012 and IEEE Std 802.16.1a-2013.

3.1.1.1 IEEE Std 802.16.1-2012**IEEE Standard for WirelessMAN-Advanced Air Interface for Broadband Wireless Access Systems**

This standard specifies the WirelessMAN-Advanced Air Interface, including the medium access control layer (MAC) and physical layer (PHY), of a broadband wireless access (BWA) system supporting multiple services.

3.1.1.2 IEEE Std 802.16.1b-2012**IEEE Standard for WirelessMAN-Advanced Air Interface for Broadband Wireless Access Systems – Amendment 1: Enhancements to Support Machine-to-Machine Applications**

This amendment specifies enhancements to the WirelessMAN-Advanced Air Interface. The enhancements provide improved support for machine-to-machine applications. As of the approval

date, the applicable version of IEEE Std 802.16.1 is IEEE Std 802.16.1-2012, as amended by IEEE 802.16.1b-2012.

3.1.1.3 IEEE Std 802.16.1a-2013

IEEE Standard for WirelessMAN-Advanced Air Interface for Broadband Wireless Access Systems – Amendment 2: Higher Reliability Networks

This amendment updates and expands IEEE Std 802.16.1, specifying enhanced mechanisms to support Higher Reliability Networks. As of the publication date, the current version of IEEE Std 802.16.1 is IEEE Std 802.16.1-2012, as amended by IEEE Std 802.16.1b-2012 and IEEE Std 802.16.1a-2013.

3.1.2 Transposed standards

3.1.2.1 Transpositions: IEEE

	Base standard per IEEE Std 802.16.1-2012	Amendment per IEEE Std 802.16.1b-2012	Amendment per IEEE Std 802.16.1a-2013
Transposing Organization	IEEE	IEEE	IEEE
Document Number	IEEE Std 802.16.1-2012	IEEE Std 802.16.1b-2012	IEEE Std 802.16.1a-2013
Version	2012	2012	2013
Issued Date	8 June 2012	30 August 2012	6 March 2013
Document	IEEE transposition of IEEE Std 802.16.1-2012	IEEE transposition of IEEE Std 802.16.1b-2012	IEEE transposition of IEEE Std 802.16.1a-2013

3.1.2.2 Transpositions: ARIB

Reserved.

3.1.2.3 Transpositions: TTA

	Base standard per IEEE Std 802.16.1-2012	Amendment per IEEE Std 802.16.1b-2012	Amendment per IEEE Std 802.16.1a-2013
Transposing Organization	TTA	TTA	TTA
Document Number	TTAE.IE-802.16.1-2012	TTAE.IE-802.16.1b-2012	<i>Not applicable</i>
Version	1.0	1.0	<i>Not applicable</i>
Issued Date	21 December 2012	26 June 2013	<i>Not applicable</i>
Document	http://committee.tta.or.kr/include/Download.jsp?filename=stnfile/TTAE_[1].IE-802.16.1-2012.pdf (TTA transposition of IEEE Std 802.16.1-2012)	http://committee.tta.or.kr/include/Download.jsp?filename=stnfile/TTAE.IE-802.16.1b-2012.zip (TTA transposition of IEEE Std 802.16.1b-2012)	<i>Not applicable</i>

3.1.2.4 Transpositions: WiMAX Forum

Reserved.

3.1.2.5 Transpositions: ITRI

	Base standard per IEEE Std 802.16.1-2012	Amendment per IEEE Std 802.16.1b-2012	Amendment per IEEE Std 802.16.1a-2013
Transposing Organization	ITRI	ITRI	ITRI
Document Number	ITRI-2013-Std-001	ITRI-2013-Std-001	ITRI-2013-Std-001
Version	2013	2013	2013
Issued Date	6 September 2013	6 September 2013	6 September 2013
Document	http://std-share.itri.org.tw/Content/Files/Stdlink/ITRI-BWA-001.pdf	http://std-share.itri.org.tw/Content/Files/Stdlink/ITRI-BWA-001.pdf	http://std-share.itri.org.tw/Content/Files/Stdlink/ITRI-BWA-001.pdf

**Attachment
to Annex 2****Abbreviations**

AAS	Active antenna system
ARQ	Automatic repeat request
CMAS	Commercial mobile alert system
CoMP	Coordinated multipoint
CQI	Channel quality identifier
CTC	Convolutional turbo code
DFTS	Discrete Fourier transform-spread
DLC	Data link control layer
DRX	Discontinuous reception
EMC	ElectroMagnetic compatibility
ETWS	Earthquake and tsunami warning system
FEC	Forward error correction
FFR	Fractional frequency reuse
FSTD	Frequency switched transmit diversity
GCS	Global core specifications
GNSS	Global navigation satellite system
GPS	Global positioning system
H-ARQ	Hybrid – ARQ
ICIC	Inter-cell interference coordination

IMEI	International Mobile station Equipment Identities
IMS	IP multimedia subsystems
LAA	Licensed-assisted access
LBT	Listen before talk
LWA	LTE-WLAN aggregation
MAC	Medium access control
MBMS	Multimedia broadcast/multicast service
MIMO	Multiple-input/multiple-output
MME	Mobility management entity
MTC	Machine-type communications
NB-IOT	Narrow-band Internet of Things
OAM	Operation and maintenance
OFDM	Orthogonal frequency-division multiplexing
OFDMA	Orthogonal frequency-division multiple access
OTDOA	Observed time difference of arrival
PAPR	Peak-to-average power ratio
PDCP	Packet data convergence protocol
PDU	Protocol data unit
PHS	Payload header suppression
PHY	Physical layer
ProSe	Proximity based Services
RRM	Radio resource management
PWS	Public warning system
QoS	Quality of service
RIT	Radio interface technology
RLC	Radio link control
RRC	Radio resource control
SDP	Session description protocol
SDU	Service data unit
SIP	Session initiation protocol
SFBC	Space-frequency block coding
SFH	Super frame header
SIM	Subscriber identity module
SON	Self-organizing networks
SPS	Semi-persistent scheduling
SRIT	Set of RIT
TTI	Transmission time interval
UE	User equipment
V2V	Vehicle to vehicle
