



INTERNATIONAL TELECOMMUNICATION UNION

ITU-T

TELECOMMUNICATION
STANDARDIZATION SECTOR
OF ITU

X.76

(02/2003)

SERIES X: DATA NETWORKS AND OPEN SYSTEM
COMMUNICATIONS

Public data networks – Transmission, signalling and
switching

**Network-to-network interface between public
networks providing PVC and/or SVC frame relay
data transmission service**

ITU-T Recommendation X.76

ITU-T X-SERIES RECOMMENDATIONS
DATA NETWORKS AND OPEN SYSTEM COMMUNICATIONS

PUBLIC DATA NETWORKS	
Services and facilities	X.1–X.19
Interfaces	X.20–X.49
Transmission, signalling and switching	X.50–X.89
Network aspects	X.90–X.149
Maintenance	X.150–X.179
Administrative arrangements	X.180–X.199
OPEN SYSTEMS INTERCONNECTION	
Model and notation	X.200–X.209
Service definitions	X.210–X.219
Connection-mode protocol specifications	X.220–X.229
Connectionless-mode protocol specifications	X.230–X.239
PICS proformas	X.240–X.259
Protocol Identification	X.260–X.269
Security Protocols	X.270–X.279
Layer Managed Objects	X.280–X.289
Conformance testing	X.290–X.299
INTERWORKING BETWEEN NETWORKS	
General	X.300–X.349
Satellite data transmission systems	X.350–X.369
IP-based networks	X.370–X.399
MESSAGE HANDLING SYSTEMS	X.400–X.499
DIRECTORY	X.500–X.599
OSI NETWORKING AND SYSTEM ASPECTS	
Networking	X.600–X.629
Efficiency	X.630–X.639
Quality of service	X.640–X.649
Naming, Addressing and Registration	X.650–X.679
Abstract Syntax Notation One (ASN.1)	X.680–X.699
OSI MANAGEMENT	
Systems Management framework and architecture	X.700–X.709
Management Communication Service and Protocol	X.710–X.719
Structure of Management Information	X.720–X.729
Management functions and ODMA functions	X.730–X.799
SECURITY	X.800–X.849
OSI APPLICATIONS	
Commitment, Concurrency and Recovery	X.850–X.859
Transaction processing	X.860–X.879
Remote operations	X.880–X.899
OPEN DISTRIBUTED PROCESSING	X.900–X.999

For further details, please refer to the list of ITU-T Recommendations.

ITU-T Rec. X.76

Network-to-network interface between public networks providing PVC and/or SVC frame relay data transmission service

Summary

This Recommendation describes the frame relay network-to-network interface intended for the interconnection of public networks providing PVC and/or SVC frame relay data transmission service. The signalling at the NNI for frame relay SVC is applicable to public data networks supporting ITU-T Rec. X.36 at the DTE/DCE interface. Details of physical layer, data transfer and signalling procedures for SVC and PVC at the network-to-network interface are defined. PVC signalling procedures have been enhanced with a new segmentation capability procedure to increase the number of PVC status reports.

Recognizing that frame relay bearer services and signalling are not supported by ISDN local exchanges, Case B has been removed from ITU-T Rec. Q.933 (2003). Consequently this version of ITU-T Rec. X.76 no longer supports the NNI signalling capabilities specific to ITU-T Rec. Q.933 (1995) Case B.

This revision replaces ITU-T Rec. X.76 (2000). This revised ITU-T Rec. X.76 (2003) is in alignment with the latest release of ITU-T Recs Q.933 (2003) and X.36 (2003).

Source

ITU-T Recommendation X.76 was approved by ITU-T Study Group 17 (2001-2004) under the ITU-T Recommendation A.8 procedure on 13 February 2003.

FOREWORD

The International Telecommunication Union (ITU) is the United Nations specialized agency in the field of telecommunications. The ITU Telecommunication Standardization Sector (ITU-T) is a permanent organ of ITU. ITU-T is responsible for studying technical, operating and tariff questions and issuing Recommendations on them with a view to standardizing telecommunications on a worldwide basis.

The World Telecommunication Standardization Assembly (WTSA), which meets every four years, establishes the topics for study by the ITU-T study groups which, in turn, produce Recommendations on these topics.

The approval of ITU-T Recommendations is covered by the procedure laid down in WTSA Resolution 1.

In some areas of information technology which fall within ITU-T's purview, the necessary standards are prepared on a collaborative basis with ISO and IEC.

NOTE

In this Recommendation, the expression "Administration" is used for conciseness to indicate both a telecommunication administration and a recognized operating agency.

Compliance with this Recommendation is voluntary. However, the Recommendation may contain certain mandatory provisions (to ensure e.g. interoperability or applicability) and compliance with the Recommendation is achieved when all of these mandatory provisions are met. The words "shall" or some other obligatory language such as "must" and the negative equivalents are used to express requirements. The use of such words does not suggest that compliance with the Recommendation is required of any party.

INTELLECTUAL PROPERTY RIGHTS

ITU draws attention to the possibility that the practice or implementation of this Recommendation may involve the use of a claimed Intellectual Property Right. ITU takes no position concerning the evidence, validity or applicability of claimed Intellectual Property Rights, whether asserted by ITU members or others outside of the Recommendation development process.

As of the date of approval of this Recommendation, ITU [had/had not] received notice of intellectual property, protected by patents, which may be required to implement this Recommendation. However, implementors are cautioned that this may not represent the latest information and are therefore strongly urged to consult the TSB patent database.

© ITU 2003

All rights reserved. No part of this publication may be reproduced, by any means whatsoever, without the prior written permission of ITU.

CONTENTS

	Page
1	Scope 1
2	References..... 1
3	Terms and definitions 2
4	Abbreviations..... 3
5	Conventions 3
6	Physical layer..... 3
7	Reference configuration..... 4
8	Service parameters and service quality..... 4
8.1	Scope 4
8.2	Service parameters..... 4
8.3	Service quality 5
9	Data link transfer control 6
9.1	General 6
9.2	Frame format 6
9.3	Addressing 7
9.4	Transmission considerations 9
10	Frame relay SVC signalling 11
10.1	General 11
10.2	Signalling channel 12
10.3	State definitions 14
10.4	Message definitions 14
10.5	General message format and information element coding 20
10.6	Call establishment 44
11	Additional procedures for PVCs using unnumbered information frames 60
11.1	Overview 60
11.2	Message definition..... 61
11.3	Message specific information elements..... 62
11.4	Description of procedures..... 64
11.5	Bidirectional aspects of operation 69
11.6	Asynchronous PVC STATUS message..... 70
11.7	System parameters..... 71
12	Congestion control..... 72
Annex A	– Signalling for switched PVC (SPVC) 72
A.1	Messages needed for SPVC establishment..... 74
A.2	Called party SPVC information element..... 74
A.3	Calling party SPVC information element..... 75
A.4	SPVC Procedures 76

	Page
Annex B – Usage of cause and location	81
B.1 Location field generation.....	81
B.2 Cause values	82
B.3 Coding of the diagnostic field	91
Annex C – Enhancements to PVC management procedures	93
C.1 Introduction	93
C.2 List of changes to clause 11.....	93
Appendix I – Network congestion scenarios	94
Appendix II – International network identification according to ITU-T Rec. X.125 for networks providing frame relay services and numbered under the E.164 numbering plan	95
II.1 Introduction	95
II.2 Assignment and notification process.....	95
Appendix III – Call state diagrams at one STE side of the NNI.....	95
III.1 Symbol definition of the call state diagrams	95
Appendix IV – Action taken by the STE on receipt of a message in a given call state at one side of NNI.....	98

Network-to-network interface between public networks providing PVC and/or SVC frame relay data transmission service

1 Scope

Recognizing that public networks are offering the frame relay data transmission service, there is a need for a standard network-to-network interface to enable interworking. This Recommendation provides the structural details required to implement such an interface. Procedures for PVC and SVC operation are provided.

2 References

The following ITU-T Recommendations and other references contain provisions which, through reference in this text, constitute provision of this Recommendation. At the time of publication, the editions indicated were valid. All Recommendations and other references are subject to revision; users of this Recommendation are therefore encouraged to investigate the possibility of applying the most recent edition of the Recommendations and other references listed below. A list of the currently valid ITU-T Recommendations is regularly published. The reference to a document within this Recommendation does not give it, as a stand-alone document, the status of a Recommendation.

- ITU-T Recommendation E.164/I.331 (1997), *The international public telecommunication numbering plan.*
- ITU-T Recommendation E.166/X.122 (1998), *Numbering plan interworking for the E.164 and X.121 numbering plans.*
- ITU-T Recommendation G.703 (2001), *Physical/electrical characteristics of hierarchical digital interfaces.*
- ITU-T Recommendation G.704 (1998), *Synchronous frame structures used at 1544, 6312, 2048, 8448 and 44 736 kbit/s hierarchical levels.*
- ITU-T Recommendation I.122 (1993), *Framework for frame mode bearer services.*
- ITU-T Recommendation I.233.1 (1991), *Frame mode bearer services: ISDN frame relaying bearer service.*
- ITU-T Recommendation I.370 (1991), *Congestion management for the ISDN frame relaying bearer service.*
- ITU-T Recommendation I.372 (1993), *Frame relaying bearer service network-to-network interface requirements.*
- ITU-T Recommendation I.430 (1995), *Basic user-network interface – Layer 1 specification.*
- ITU-T Recommendation I.431 (1993), *Primary rate user-network interface – Layer 1 specification.*
- ITU-T Recommendation Q.850 (1998), *Usage of cause and location in the Digital Subscriber Signalling System No. 1 and Signalling System No. 7 ISDN User Part.*
- ITU-T Recommendation Q.920 (1993), *ISDN user-network interface data link layer – General aspects.*
- ITU-T Recommendation Q.921 (1997), *ISDN user-network interface – Data link layer specification.*

- ITU-T Recommendation Q.922 (1992), *ISDN data link layer specification for frame mode bearer services.*
- ITU-T Recommendation Q.931 (1998), *ISDN user-network interface layer 3 specification for basic call control.*
- ITU-T Recommendation Q.933 (2003), *ISDN Digital subscriber Signalling System No. 1 (DSS1) – Signalling specifications for frame mode switched and permanent virtual connection control and status monitoring.*
- ITU-T Recommendations Q.951.x-series, *Stage 3 service description for number identification supplementary services using DSS1.*
- ITU-T Recommendation T.50 (1992), *International Reference Alphabet (IRA) (Formerly International Alphabet No. 5 or IA5) – Information technology – 7-bit coded character set for information interchange.*
- ITU-T Recommendation X.36 (2003), *Interface between Data Terminal Equipment (DTE) and Data Circuit-terminating Equipment (DCE) for public data networks providing frame relay data transmission service by dedicated circuit.*
- ITU-T Recommendation X.37 (1995), *Encapsulation in X.25 packets of various protocols including frame relay.*
- ITU-T Recommendation X.92 (1988), *Hypothetical reference connections for public synchronous data networks.*
- ITU-T Recommendation X.121 (2000), *International numbering plan for public data networks.*
- ITU-T Recommendation X.124 (1999), *Arrangements for the interworking of the E.164 and X.121 numbering plans for frame relay and ATM networks.*
- ITU-T Recommendation X.125 (1998), *Procedure for the notification of the assignment of international network identification codes for public frame relay data networks and ATM networks numbered under the E.164 numbering plan.*
- ITU-T Recommendation X.212 (1995) | ISO/IEC 8886:1996, *Information technology – Open Systems Interconnection – Data link service definition.*
- ITU-T Recommendation X.213 (2001) | ISO/IEC 8348:2002, *Information technology – Open Systems Interconnection – Network service definition.*

3 Terms and definitions

This Recommendation defines the following terms:

- a) Committed Information Rate (CIR) as in 8.2.4;
- b) Committed Burst Size (Bc) as in 8.2.2;
- c) Excess Burst Size (Be) as in 8.2.3;
- d) Committed Rate Measurement Interval (Tc) as in 8.2.5;
- e) Access Rate (AR) as in 8.2.1;
- f) Maximum octet length of frame relay information field (N203) as in 8.2.6;
- g) N391 as in 11.4 and Table 32;
- h) N392 as in 11.4 and Table 32;

- i) N393 as in 11.4 and Table 32;
- j) T391 as in 11.4 and Table 33;
- k) T392 as in 11.4 and Table 33.

NOTE – The names of the timers and counters in items g) to k) are aligned with Annex A/Q.933 terminology.

4 Abbreviations

This Recommendation uses the following abbreviations:

AR	Access Rate
Bc	Committed Burst Size
Be	Excess Burst Size
BECN	Backward Explicit Congestion Notification
C/R	Command/Response
CIR	Committed Information Rate
D/C	DLCI Extension/Control Indication Bit
DCE	Data Circuit-terminating Equipment
DE	Discard Eligibility indicator
DLCI	Data Link Connection Identifier
DTE	Data Terminal Equipment
EA	Address Field Extension
FCS	Frame Check Sequence
FECN	Forward Explicit Congestion Notification
FRDTS	Frame Relay Data Transmission Service
LAPF	Link Access Procedure for Frame mode bearer service
PDN	Public Data Network
PVC	Permanent Virtual Circuit
SPVC	Switched Permanent Virtual Circuit
STE	Signalling Terminal
SVC	Switched Virtual Circuit
Tc	Committed Rate Measurement Interval
VC	Virtual Circuit

5 Conventions

No special conventions are employed within this Recommendation.

6 Physical layer

The characteristics of the network-to-network interface, defined as the physical layer element, shall be in accordance with ITU-T Rec. G.703. When used, the frame structure conforms to ITU-T Rec. G.704. In the case of 2 Mbit/s, time slot 0 is used to perform fault detection (see ITU-T Rec. G.732). Time slot 16 may either be used or not used, resulting in an access rate of 1984 kbit/s or 1920 kbit/s respectively.

Other recognized rates may also be used, in which case the signalling terminal/physical circuit interface shall be in accordance with the appropriate V or X-series Recommendations, for example:

- V.24;
- V.35;
- V.36;
- X.21.

Each physical circuit must be able to support duplex operation.

In the case of international interworking between public data networks providing FRDTS, the link is assumed to be data link A1 and/or data link G1 in terms of the hypothetical reference connections defined in ITU-T Rec. X.92.

NOTE – The use of SDH Interface is for further study.

7 Reference configuration

Figure 1 illustrates the possible locations of the network-to-network interface. The interfaces connect public data networks providing FRDTS.

8 Service parameters and service quality

8.1 Scope

This clause describes the service parameters needed to define the necessary service requirements and control management for handling congestion during the data transmission phase in a public data network providing frame relay data transmission services.

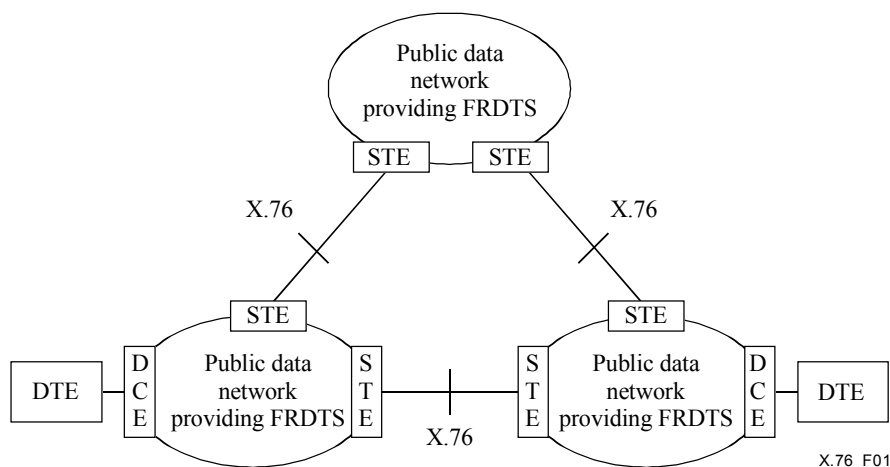

Figure 1/X.76 – Locations of network-to-network interface

8.2 Service parameters

8.2.1 access rate (AR): The access rate is the maximum data rate at which data can be injected into or extracted from the network. It is determined by the speed of the access channel. The access rate is bilaterally agreed between the two connecting networks for a period of time. The access rate parameter is provisioned once per STE.

8.2.2 committed burst size (Bc): The committed burst size is the amount of data for a particular virtual circuit that the network agrees to transfer under normal conditions during interval Tc (see 8.2.5 (Tc)). The values used for this parameter are bilaterally agreed between the two connecting networks for a period of time. The values used at each STE should be chosen to provide the desired

end-to-end service. This service parameter is provisioned once for each VC at an STE. The value of this parameter can be different for each direction of transmission. That is, each STE on a network-to-network interface can support a different value of this parameter for a particular VC.

8.2.3 excess burst size (Be): The excess burst size is the amount of uncommitted data that the network shall endeavour to deliver in addition to the Committed Burst Size (Bc) for a particular virtual circuit during interval Tc (see 8.2.5 (Tc)). The values used for this parameter are bilaterally agreed between the two connecting networks for a period of time. The values used at each STE should be chosen to provide the desired end-to-end service. This service parameter is provisioned once for each VC at an STE. The value of this parameter can be different for each direction of transmission. That is, each STE on a network-to-network interface can support a different value of this parameter for a particular VC.

8.2.4 committed information rate (CIR): The information transfer rate which the network is committed to transfer for a particular virtual circuit under normal conditions. The rate is the average committed burst size over the time interval of Tc. The values used for this parameter are bilaterally agreed between the two connecting networks for a period of time. The values used at each STE should be chosen to provide the desired end-to-end service. This service parameter is provisioned once for each VC at an STE. The value of this parameter can be different for each direction of transmission. That is, each STE on a network-to-network interface can support a different value of this parameter for a particular VC.

8.2.5 committed rate measurement interval (Tc): The Committed Rate Measurement Interval (Tc) is the time interval during which the network may expect committed burst size and excess burst size data. It is calculated according to the following formula:

- 1) if $CIR > 0$, $Tc = Bc/CIR$;
- 2) if $CIR = 0$, Tc is set to a network dependent value. The values used for this parameter are bilaterally agreed between the two connecting networks for a period of time. The values used at each STE should be chosen to provide the desired end-to-end service. This service parameter is provisioned once for each VC at an STE.

The value of this parameter can be different for each direction of transmission. That is, each STE on a network-to-network interface can support a different value of this parameter for a particular VC.

8.2.6 maximum octet length of frame relay information field (N203): The maximum octet length of the frame relay information field is the maximum supportable number of user octets. Octets are counted from the octet immediately following the address field to the octet immediately preceding the FCS field inclusive (see Figure 2). The count is done prior to zero-bit insertion on the transmitting side and following zero-bit extraction at the receiving side. This parameter is determined at subscription time. All networks shall support at least a value of 1600 octets. In addition, maximum information field sizes less than or greater than 1600 octets may be agreed to between networks during VC provisioning. The value of N203 is bilaterally agreed between the two connecting networks for a period of time. This service parameter is provisioned once for each PVC at an STE. The value of this parameter can be different for each direction of transmission. That is, each STE on a network-to-network interface can support a different value of this parameter for a particular VC.

8.3 Service quality

The QoS level for committed traffic characterized by the CIR, Bc and Tc parameters may be delivered within a certain probability. The QoS level excess traffic characterized by the parameter Be may also be delivered within a certain probability. (More details on this aspect can be found in ITU-T Rec. X.144.)

9 Data link transfer control

9.1 General

This clause describes the frame structure, elements of procedure, format of fields and procedures for the operation of the frame relay data transmission service at layer 2 on the network-to-network interface. The core attributes of LAPF (as described in Annex A/Q.922) used to support the frame relay data transmission service are:

- frame delimiting, alignment and transparency;
- frame multiplexing/demultiplexing using the address field;
- inspection of the frame to ensure that it consists of an integral number of octets prior to zero-bit insertion or following zero-bit extraction;
- inspection of the frame to ensure that it is neither too long nor too short;
- detection of (but not recovery from) transmission errors;
- congestion control functions.

9.2 Frame format

The frame format used for individual frame is shown in Figure 2.

9.2.1 Flag sequence

All frames shall start and end with the flag sequence consisting of one 0 bit followed by six contiguous 1 bits and one 0 bit. The flag preceding the address field is defined as the opening flag. The flag following the Frame Check Sequence (FCS) field is defined as the closing flag. The closing flag may also serve as the opening flag of the following frame.

9.2.2 Address field

The address field shall consist of at least two octets and may optionally be extended up to four octets by bilateral agreement. The format of the address field is defined in 9.3.2.

9.2.3 Information field

The information field of a frame follows the address field (see 9.3.2) and precedes the frame check sequence field (see 9.2.4). The contents of the frame relay information field shall consist of an integral number of octets. The maximum length of the frame relay information field is defined in 8.2.6.

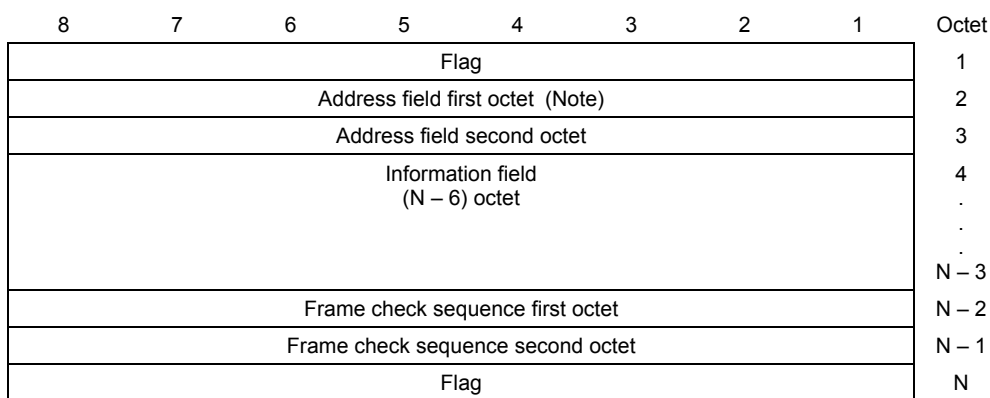

NOTE – The default address field length is 2 octets. It may be extended to 4 octets.

Figure 2/X.76 – Frame format with 2-octet address

9.2.4 Frame Check Sequence (FCS) field

The FCS field shall be a 16-bit sequence. It shall be the ones complement of the sum (modulo 2) of:

- 1) the remainder of $x^k (x^{15} + x^{14} + x^{13} + x^{12} + x^{11} + x^{10} + x^9 + x^8 + x^7 + x^6 + x^5 + x^4 + x^3 + x^2 + x + 1)$ divided (modulo 2) by the generator polynomial $x^{16} + x^{12} + x^5 + 1$, where k is the number of bits in the frame existing between, but not including, the final bit of the opening flag and the first bit of the FCS, excluding bits inserted for transparency; and
- 2) the remainder of the division (modulo 2) by the generator polynomial $x^{16} + x^{12} + x^5 + 1$ of the product of x^{16} by the content of the frame existing between, but not including, the final bit of the opening flag and the first bit of the FCS, excluding bits inserted for transparency.

9.3 Addressing

9.3.1 General

This subclause describes the field format and procedures used by FRDTS services for data link transfer. Data link connection is governed by the address field elements which support optional procedures such as congestion management which are found in clause 12. The field information is set in accordance with the address field defined by the FRDTS frame format (see Figure 3).

9.3.2 Address field format

The address field format shown in Figure 3 contains the address field extension bits, a command/response indication, 3 bits reserved for explicit congestion notification and discard eligibility indication and a Data Link Connection Identifier (DLCI). The support of 2-octet address field is mandatory. A bit is also included to indicate whether the final octet of a 4-octet address field is the low order part of the DLCI or control information.

9.3.3 Address field elements

9.3.3.1 Address Field Extension bit (EA bit)

The address field range is extended by reserving bit 1 of the address field octets to indicate the final octet of the address field. The presence of a 0 in bit 1 of an address field octet signals that another octet of the address field follows this one. The presence of a 1 in bit 1 of an address field octet signals that it is the final octet of the address field.

9.3.3.2 Command/Response bit (C/R bit)

The C/R bit is conveyed transparently across network-to-network interfaces.

9.3.3.3 Forward Explicit Congestion Notification bit (FECN bit)

This bit may be set by a congested network to notify the receiving STE that congestion avoidance procedures should be initiated, where applicable for traffic in the direction of the frame carrying the FECN indication. This bit is set to 1 to indicate to the receiving STE that the frames it receives have encountered congested resources. This bit may be used by the destination DTE to initiate transmitter rate adjustment. While setting this bit by an STE is optional, no STE shall ever clear (set to 0) this bit. An STE that does not provide FECN shall pass this bit unchanged. Explanations of the use of this bit can be found in clause 12/X.36. See Figure 3.

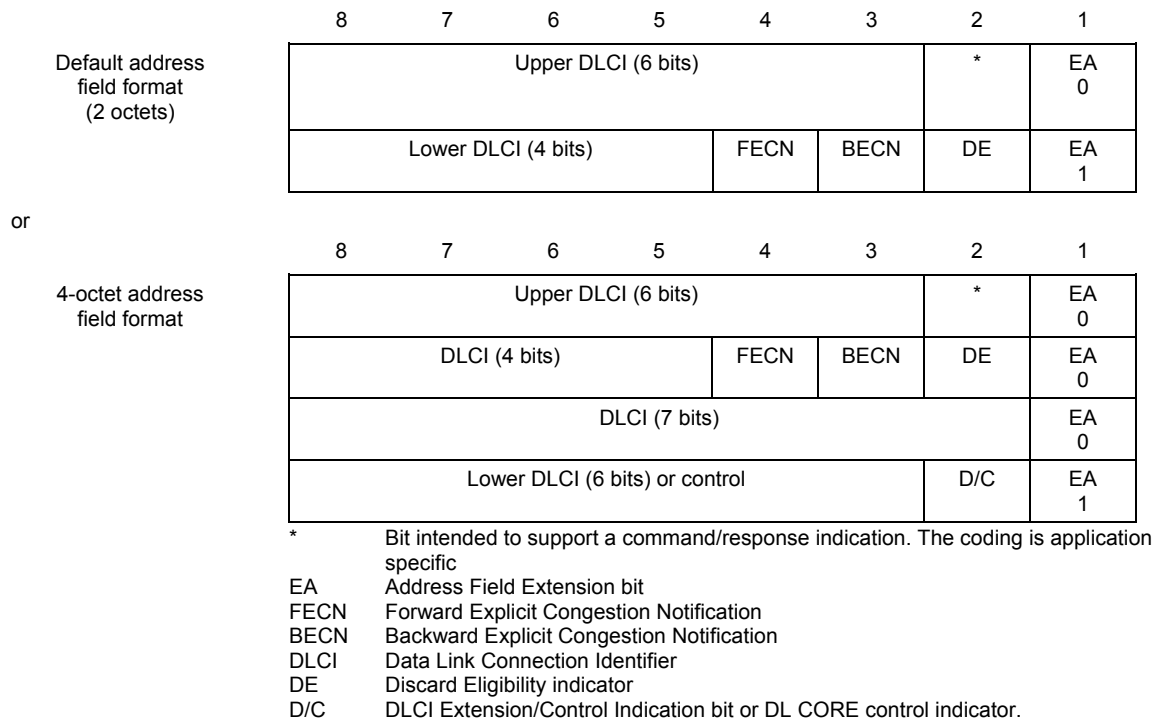

Figure 3/X.76 – Address field format

9.3.3.4 Backward Explicit Congestion Notification bit (BECN bit)

This bit may be set by a congested network to notify the receiving STE that congestion avoidance procedures should be initiated, where applicable for traffic in the opposite direction of the frame carrying the BECN indication. This bit is set to 1 to indicate to the receiving STE that the frames it transmits may encounter congested resources. This bit may be used by the source DTE to initiate transmitter rate adjustment. While setting this bit by an STE is optional, no STE shall ever clear (set to 0) this bit. An STE that does not provide BECN shall pass this bit unchanged. Explanation of the use of this bit can be found in clause 12/X.36.

9.3.3.5 Discard Eligibility indicator bit (DE bit)

This bit, if used, is set to 1 to indicate a request that a frame should be discarded in preference to other frames in a congestion situation. Setting of this bit by the network is optional. No network shall ever clear (reset to 0) this bit. Networks are not constrained to discard only frames with DE = 1 in the presence of congestion.

9.3.3.6 Data Link Connection Identifier (DLCI)

Depending on the length of the address field, the DLCI can be 10 bits or 23 bits. When the length of the address field is 2 octets, the DLCI is 10 bits and appears in octets 1 and 2. When the length of the address field is 4 octets, the DLCI is 23 bits and appears in octets 1, 2, 3 and 4. See Figure 3.

The DLCI identifies a virtual circuit at the network-to-network interface. Its value is determined either at subscription time for permanent virtual circuits or at call set-up time for switched virtual circuits. The maximum number of virtual circuits supported for a network-to-network interface is dependent on a bilateral agreement between the two networks involved.

Specific values of the DLCI are also used for:

- the signalling for switched virtual circuits (see clause 10);
- the additional procedures for permanent virtual circuits (see clause 11);
- layer 2 management.

The various values for DLCI are specified in Table 1.

Table 1a/X.76 – DLCI value range when 2-octet address field is used

DLCI range (10 bits)	Function
0	Signalling
1-15	Reserved
16-991	Virtual circuit identification
992-1007	Layer 2 management
1008-1022	Reserved
1023	Reserved for in channel layer 2 management, if required

Table 1b/X.76 – DLCI value range when 4-octet address field is used with D/C bit = 0

DLCI range (23 bits)	Function
0	Signalling
1-15	Reserved
16-991	Virtual circuit identification
992-1007	Layer 2 management
1008-1022	Reserved
1023-8388607	Reserved for in channel layer 2 management, if required
1024-8388607	Virtual circuit identification

9.3.3.7 DLCI Extension/Control Indication bit (D/C bit)

The D/C bit is bit 2 of the last octet of the address field when a 4-octet format is used. This bit indicates whether the remaining six usable bits of the octet are to be interpreted as the lower DLCI bits or as control bits. The bit is set to 0 to indicate that the octet contains DLCI information. When the bit is set to 1, bits 3 to 8 of the last octet are no longer interpreted as DLCI bits and their use is for further study.

9.4 Transmission considerations

9.4.1 Order of bit transmission

The bits are grouped into octets. The bits of an octet are shown horizontally and are numbered from 1 to 8. Multiple octets are shown vertically and are numbered from 1 to n. See Figure 4.

The octets are transmitted in ascending numerical order. For each octet, bit 1, which is the least significant bit, is transmitted first and bit 8, which is the most significant bit, is transmitted last.

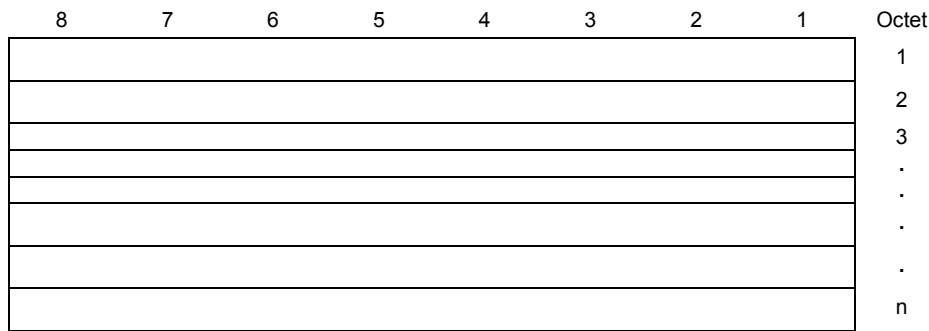

Figure 4/X.76 – Format convention

9.4.2 Order of bits in frame fields

When a field is contained within a single octet, the lowest bit number of the field represents the lowest order value.

When a field spans more than one octet, the order of bit values progressively decreases as the octet number increases within each octet. The lowest bit number associated with the field represents the lowest order value.

For example, in an address field with length of two octets, the order of the values of the DLCI bits is as shown in Figure 5.

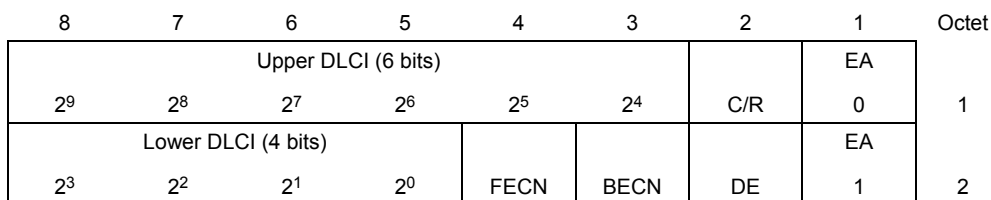

Figure 5/X.76 – Order of values of the DLCI bits

There are two exceptions to the preceding convention:

- 1) The order of the values of the bits within the information field is not specified in this Recommendation.
- 2) The order of the values of FCS bits is as follows: bit 1 of the first octet is the high-order bit and bit 8 of the second octet is the low-order bit. See Figure 6.

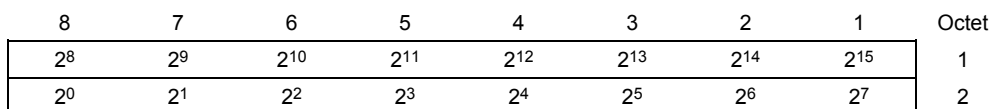

Figure 6/X.76 – Order of values of the FCS bits

9.4.3 Transparency

Each transmitting data link entity shall examine the frame content between the opening and closing flag sequences, (address, information, and FCS fields) and shall insert a 0 bit after all sequences of five contiguous 1 bits (including the last five bits of the FCS) to ensure that a flag or an abort sequence is not simulated within the frame. The receiving data link entity shall examine the frame contents between the opening and closing flag sequences and shall discard any 0 bit which directly follows five contiguous 1 bits.

9.4.4 Interframe fill

For interframe fill flag sequence must also be used.

9.4.5 Invalid frame

An invalid frame is a frame which:

- a) is not properly bounded by two flags; or
- b) has fewer than three octets between the address field and the closing flag; or
- c) does not consist of an integral number of octets prior to a 0 bit insertion or following 0 bit extraction; or
- d) contains a frame check sequence error; or
- e) contains a single octet address field; or
- f) contains a DLCI which is not supported by the receiver; or
- g) contains seven or more continuous bits set to 1 after 0 bit insertion or before 0 bit extraction ("transparency violation" or "frame abort"); or
- h) has an information field longer than N203 (see 8.2.6).

NOTE – Item b) above means that frames with an information field length equal to 0 are invalid frames. In case there is no traffic in a given transmission direction, the STE may use such invalid frames to send information about congestion in the opposite direction by means of the BECN bit set to 1 or 0. This use of invalid frames with an information field length equal to 0 is determined by bilateral agreement between the two networks involved. Further, these frames are used locally between the two STEs involved and will not be transferred to the DTE/DCE interfaces.

In case h) above, the network may send part of the frame toward the remote DTE, then abort the frame.

Invalid frames shall be discarded without notification to the transmitting STE.

9.4.6 Frame abortion

Aborting a frame is performed by transmitting at least seven contiguous 1 bits (with no inserted 0 bits). The receipt of seven or more contiguous 1 bits by an STE is interpreted as an abort and the STE ignores the frame currently being received.

10 Frame relay SVC signalling

10.1 General

This clause defines the signalling to support frame relay Switched Virtual Circuits (SVC) at the Network-to-Network Interface (NNI), and is independent of the existing PVC signalling procedures defined in this Recommendation. It defines also the following additional facilities:

- transit network identification;
- call identification;
- closed user group interlock code;
- reverse charging indication;
- clearing network identification;
- transit network selection;
- frame transfer priority;
- frame discard priority;
- frame relay service class.

The signalling at the NNI for frame relay SVC is applicable to public data networks supporting ITU-T Rec. X.36 at the DTE/DCE interface.

NOTE – As ITU-T Rec. Q.933 (2003) no longer supports Case B Frame Mode Bearer Service provided by an ISDN local exchange, the specific states, messages, information elements, procedures and timers required to support ITU-T Rec. Q.933 have been deleted in this revision of ITU-T Rec. X.76.

The following terminology is used within this Recommendation:

- The calling user/DTE is connected to a public network at the calling UNI or DTE-DCE interface.
- The called user/DTE is connected to a public network at the called UNI or DTE-DCE interface.
- At the NNI, an originating network is the network to which the calling DTE/user is attached.
- A terminating network is a network to which the called DTE/user is attached.
- A transit network is an intermediate network connected to at least two other networks.
- A calling STE is an STE initiating a frame relay SVC or call establishment and a called STE is an STE receiving a request to establish a frame relay call.
- The forward direction is the direction from the calling to the called user/DTE. The backward direction is the direction from the called to the calling user/DTE. This convention is shown in Figure 7.

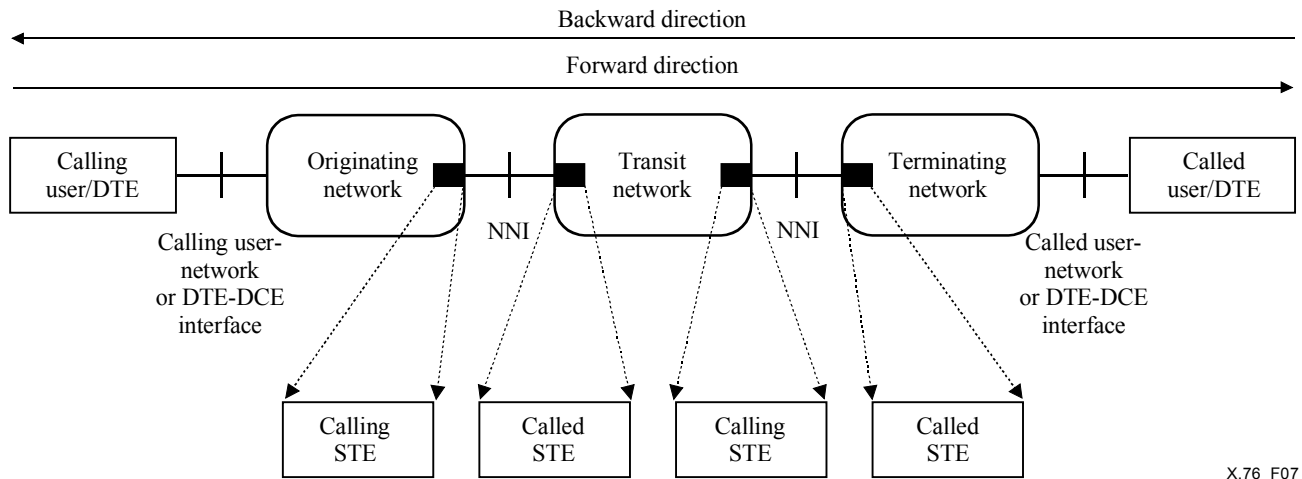

X.76_F07

Figure 7/X.76 – Convention used for SVC signalling

10.2 Signalling channel

ITU-T Rec. Q.922 defines the link layer protocol known as LAPF to provide a reliable data link connection for the exchange of SVC signalling messages defined in this clause across a frame relay NNI. See Figure 8.

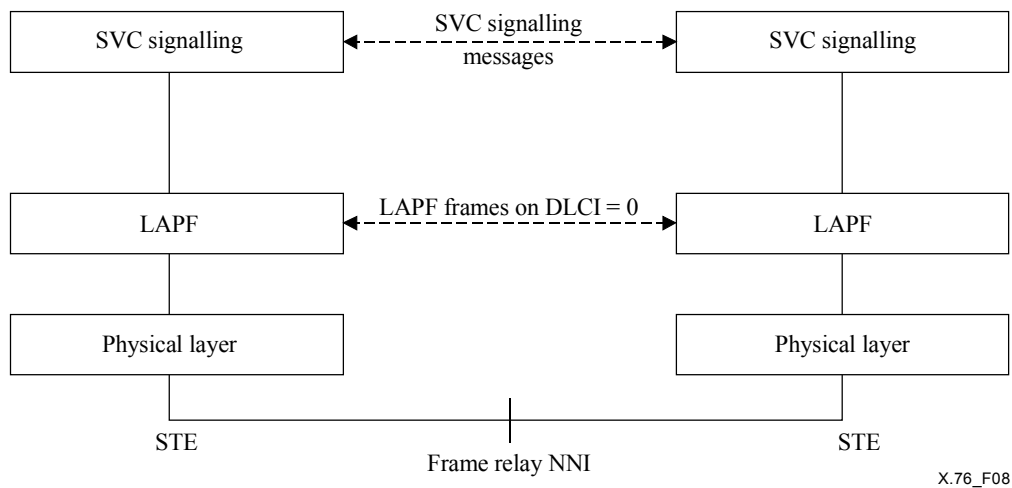

Figure 8/X76 – STE/STE protocol layers for signalling

The following frame types identified in ITU-T Rec. Q.922 and defined in ITU-T Rec. Q.921 must be supported:

- Set Asynchronous Balanced Mode Extended (SABME) command;
- Disconnect (DISC) command;
- Receive Ready (RR) command and response;
- REject (REJ) command/response;
- Receive Not Ready (RNR) command/response;
- I frames;
- Unnumbered Acknowledgment (UA) response;
- Disconnected Mode (DM) response;
- Frame Reject (FRMR) response.

XID frames are not used and Unnumbered Information (UI) frames are used for PVC signalling. SVC signalling does not affect PVC signalling since, for SVC signalling, I frames are used whereas, for PVC signalling, UI frames are used.

In order to exchange SVC signalling messages across the NNI, a LAPF link has to be established using DLCI = 0. After establishment of a LAPF link, the data link connection identified with DLCI = 0 is automatically ready for the exchange of the signalling messages across the NNI. This LAPF link is known as the signalling channel.

On the signalling channel, FECN, BECN and DE bits are not used. They must be set to 0 upon transmission and must not be interpreted upon reception.

The values of the link layer parameters of the link layer protocol on the signalling channel are as follows:

- 1) Timer T200: The default value for the retransmission timer T200, at the end of which transmission of a frame may be initiated according to the procedures of ITU-T Rec. Q.922 is 1 second;
- 2) Timer T203: The idle timer T203 represents the maximum time allowed without frames being exchanged and has a value 30 seconds;
- 3) Counter N200: The retransmission counter (N200) identifies the maximum number of retransmissions of a frame and has a value of 3;

- 4) Maximum number of outstanding I frames (k): The maximum number (k) of sequentially numbered I frames that may be outstanding (that is, unacknowledged) at any given time is a system parameter which shall not exceed 127. This parameter is also called "maximum window size". For a 16 kbit/s link, the default value shall be 3. For a 64 kbit/s link, the default value shall be 7. For a 384 kbit/s link, the default value shall be 32. For a 1.536 Mbit/s or 1.920 Mbit/s link, the default value shall be 40;
- 5) Maximum number of octets in an information field (N201): The default value of N201 for the maximum number of octets in an information field is 1600 octets. All other maximum values are negotiated between networks.

10.3 State definitions

10.3.1 Frame relay call states at the NNI

The following states are the states that may exist at either side of a frame relay NNI. These states are derived from X.36 states used at the network side of a UNI and use the equivalent state numbers.

- **Null state (NN0):** No switched virtual circuit exists.
- **Call initiated (NN1):** This state exists for a called STE after it has received a call establishment request from the calling STE but has not responded yet.
- **Call proceeding sent (NN3):** This state exists for a called STE when it has acknowledged the receipt of the information necessary to establish a call.
- **Call present (NN6):** This state exists for a calling STE after it has sent a call establishment request to the called STE but has not received a response.
- **Call proceeding received (NN9):** This state exists for a calling STE when it has received an acknowledgment that the called STE received the call establishment request.
- **Active (NN10):** This state exists when the frame relay SVC has been established and data transfer phase may begin.
- **Release request (NN11):** This state exists for an STE when it has sent a request to release the SVC.
- **Release indication (NN12):** This state exists for an STE when it has received a request to release the SVC and is waiting for a response.

10.3.2 States associated with restart

The following states are associated with restart:

- **Restart null (Rest0):** No restart request exists.
- **Restart request (Rest1):** This state exists for one STE after it has sent a restart request to the other STE and is waiting for an acknowledgment.
- **Restart (Rest2):** This state exists for one STE when it has received a request for a restart and has not returned an acknowledgment indicating the outcome of the restart.

10.4 Message definitions

The following messages are used at the frame Relay NNI:

- Call proceeding.
- Connect.
- Release.
- Release complete.
- Restart.
- Restart acknowledge.

- Setup.
- Status.
- Status enquiry.

Each message is described in this clause as follows:

- A brief definition of the purpose of the message.
- The message structure and content.
- The "significance" of the message:
 - local significance means that the message is applicable only at the NNI;
 - global significance means that the message is applicable to the two UNIs and the NNIs involved in the call.
- The direction in which the message may be sent: "Both" means the message can be sent by either side of the NNI. "Forward" means the message is sent only by the calling STE to the called STE and "backward" refers to the opposite direction.
- A table listing the information elements in the order of their appearance in the message – For each information element, the table indicates:
 - The clause describing the information element.
 - Whether the information element inclusion in the message is mandatory (M), or optional (O), with a reference to notes explaining the circumstances under which the information element shall be included.
 - The length of the information element (or permissible range of length) in octets – the character * denotes an undefined length which may be network or service dependent.
 - Further explanatory notes as necessary.

10.4.1 Alerting

The Alerting message is no longer supported in this Recommendation (see Note in 10.1).

Table 2/X.76 – ALERTING message content

(No longer supported)

10.4.2 Call proceeding

This message is sent by the called STE to the calling STE to indicate that the requested call establishment has been initiated. This message acknowledges the receipt of the SETUP message. See Table 3.

Table 3/X.76 – CALL PROCEEDING message content

Message type: CALL PROCEEDING		Direction: Backward	
Significance: Local			
Information element	Reference	Type	Length
Protocol discriminator	10.5.1	M	1
Call reference	10.5.2	M	3
Message type	10.5.3	M	1
Data link connection identifier	10.5.16	M	4-6

10.4.3 Connect

This message is sent by the called STE to the calling STE to indicate that the called user/DTE has accepted the call. See Table 4.

Table 4/X.76 – CONNECT message content

Message type: CONNECT		Direction: Backward	
Significance: Global			
Information element	Reference	Type	Length
Protocol discriminator	10.5.1	M	1
Call reference	10.5.2	M	3
Message type	10.5.3	M	1
Called party SPVC	A.2	O (Note 2)	5-7
Link layer core parameters	10.5.19	M (Note 3)	2-31
Connected number	10.5.14	O (Note 4)	2-19
Connected subaddress	10.5.15	O (Note 2)	2-23
Transit network identification	10.5.26	O (Note 5)	5-11
Low layer compatibility	10.5.21	O (Note 2)	2-16
Generic application transport	10.5.17 bis	O (Note 6)	2-257
User-user	10.5.28	O (Note 2)	2-131

NOTE 1 – Information elements specific to Q.933 (1995) Case B have been deleted (see Note in 10.1).

NOTE 2 – This information element is passed on transparently at the NNI.

NOTE 3 – Included to indicate the final link layer core parameters to use for the SVC.

NOTE 4 – Included if it was included by the called user/DTE at the called UNI/DTE-DCE interface.

NOTE 5 – This information element may be repeated to identify multiple networks. See 10.6.9.1.

NOTE 6 – A maximum of 10 instances of this information element may be present.

10.4.4 Progress

The Progress message is no longer supported in this Recommendation (see Note in 10.1).

Table 5/X.76 – PROGRESS message content

(No longer supported)

10.4.5 Release

This message is sent to indicate that the SVC has been cleared and the data link connection identifier and call reference are being released. See Table 6.

Table 6/X.76 – RELEASE message content

Message type: RELEASE		Direction: Both	
Significance: Global			
Information element	Reference	Type	Length
Protocol discriminator	10.5.1	M	1
Call reference	10.5.2	M	3
Message type	10.5.3	M	1
Cause	10.5.11	M (Note 1)	2-32
Transit network identification	10.5.26	O (Note 5)	5-11
Clearing network identification	10.5.12	O	5-11
Generic application transport	10.5.17 <i>bis</i>	O (Note 6)	2-257
NOTE 1 – This information element may occur twice to indicate multiple release causes.			
NOTE 2 – Information elements specific to Q.933 (1995) Case B have been deleted (see Note in 10.1).			
NOTE 5 – This information element may be repeated to identify multiple networks. See 10.6.9.1.			
NOTE 6 – A maximum of 10 instances of this information element may be present.			

10.4.6 Release complete

This message is sent to indicate that the SVC has been cleared and the data link connection identifier and call reference has been released. Normally this message is sent as a reply to a RELEASE message. See Table 7.

Table 7/X.76 – RELEASE COMPLETE message content

Message type: RELEASE COMPLETE		Direction: Both	
Significance: Local (Note 7)			
Information element	Reference	Type	Length
Protocol discriminator	10.5.1	M	1
Call reference	10.5.2	M	3
Message type	10.5.3	M	1
Cause	10.5.11	O (Note 1)	2-32
Transit network identification	10.5.26	O (Note 5)	5-11
Clearing network identification	10.5.12	O	5-11
Generic application transport	10.5.17 <i>bis</i>	O (Note 6)	2-257
NOTE 1 – Mandatory if this message is the first clearing message. This information element may occur twice to indicate multiple release causes.			
NOTE 2 – Information elements specific to Q.933 (1995) Case B have been deleted (see Note in 10.1)			
NOTE 5 – This information element may be repeated to identify multiple networks. See 10.6.9.1.			
NOTE 6 – A maximum of 10 instances of this information element may be present if the RELEASE COMPLETE is sent as the first clearing message.			
NOTE 7 – This message has local significance. However, its content has global significance when used as the first call clearing message.			

10.4.7 Restart

This message is sent to initiate restart (i.e., return to an idle condition) the NNI. See Table 8.

Table 8/X.76 – RESTART message content

Message type: RESTART		Direction: Both	
Significance: Local			
Information element	Reference	Type	Length
Protocol discriminator	10.5.1	M	1
Call reference	10.5.2	M (Note)	3
Message type	10.5.3	M	1
NOTE – Only the global call reference value is used with this message.			

10.4.8 Restart acknowledge

This message is sent to indicate that the requested restart has been completed. See Table 9.

Table 9/X.76 – RESTART ACKNOWLEDGE message content

Message type: RESTART ACKNOWLEDGE		Direction: Both	
Significance: Local			
Information element	Reference	Type	Length
Protocol discriminator	10.5.1	M	1
Call reference	10.5.2	M (Note)	3
Message type	10.5.3	M	1
NOTE – Only the global call reference value is used with this message.			

10.4.9 Setup

This message is sent by the calling STE to the called STE to initiate SVC establishment. See Table 10.

Table 10/X.76 – SETUP message content

Message type: SETUP		Direction: Forward	
Significance: Global			
Information element	Reference	Type	Length
Protocol discriminator	10.5.1	M	1
Call reference	10.5.2	M	3
Message type	10.5.3	M	1
Bearer capability	10.5.4	M	5
Called party SPVC	A.2	O	5-7
Calling party SPVC	A.3	O	5-6
Data link connection identifier	10.5.16	M	4-6
Link layer core parameters	10.5.19	M	2-31
Link layer protocol parameters	10.5.20	O (Note 2)	2-9
Reverse charging indication	10.5.25	O	3
Priority and service class parameters	10.5.23	O	4-8

Table 10/X.76 – SETUP message content

Message type: SETUP		Direction: Forward	
Significance: Global			
Information element	Reference	Type	Length
Transit network identification	10.5.26	O (Note 3)	5-11
CUG interlock code	10.5.13	O	12-16
Call identification	10.5.5	M	6
Calling party number	10.5.9	M	2-19
Calling party subaddress	10.5.10	O (Note 2)	2-23
Called party number	10.5.7	M	2-18
Called party subaddress	10.5.8	O (Note 2)	2-23
Low layer compatibility	10.5.21	O (Notes 2, 5)	2-16
Generic application transport	10.5.17 bis	O (Note 6)	2-257
User-user	10.5.28	O (Note 2)	2-131
NOTE 1 – Information elements specific to Q.933 (1995) Case B have been deleted (see Note in clause 10.1).			
NOTE 2 – This information element is passed on transparently at the NNI.			
NOTE 3 – Information elements specific to Q.933 (1995) Case B have been deleted (see Note in 10.1).			
NOTE 4 – Information elements specific to Q.933 (1995) Case B have been deleted (see Note in 10.1).			
NOTE 5 – Up to three low layer compatibility information elements may be present.			
NOTE 6 – A maximum of 10 instances of this information element may be present.			

10.4.10 Status

This message is sent in response to a STATUS ENQUIRY or at any time during a call to report certain error conditions. See Table 11.

Table 11/X.76 – STATUS message content

Message type: STATUS		Direction: Both	
Significance: Local			
Information element	Reference	Type	Length
Protocol discriminator	10.5.1	M	1
Call reference	10.5.2	M (Note)	3
Message type	10.5.3	M	1
Cause	10.5.11	M	4-32
Call State	10.5.6	M	3
NOTE – The global call reference may be used with this message.			

10.4.11 Status Enquiry

This message is sent at any time to solicit a STATUS message. See Table 12.

Table 12/X.76 – STATUS ENQUIRY message content

Message type: STATUS ENQUIRY		Direction: Both	
Significance: Local			
Information element	Reference	Type	Length
Protocol discriminator	10.5.1	M	1
Call reference	10.5.2	M (Note)	3
Message type	10.5.3	M	1
NOTE – The global call reference may be used with this message.			

10.5 General message format and information element coding

This clause describes the information elements which are included in the signalling messages defined in the previous subclause.

Every message of this protocol shall consist of the following parts:

- a) protocol discriminator;
- b) call reference;
- c) message type;
- d) other information elements.

Information elements a), b), c) are common to all the messages and shall always be present. Each message will have additional information elements. This organization is shown in Figure 9.

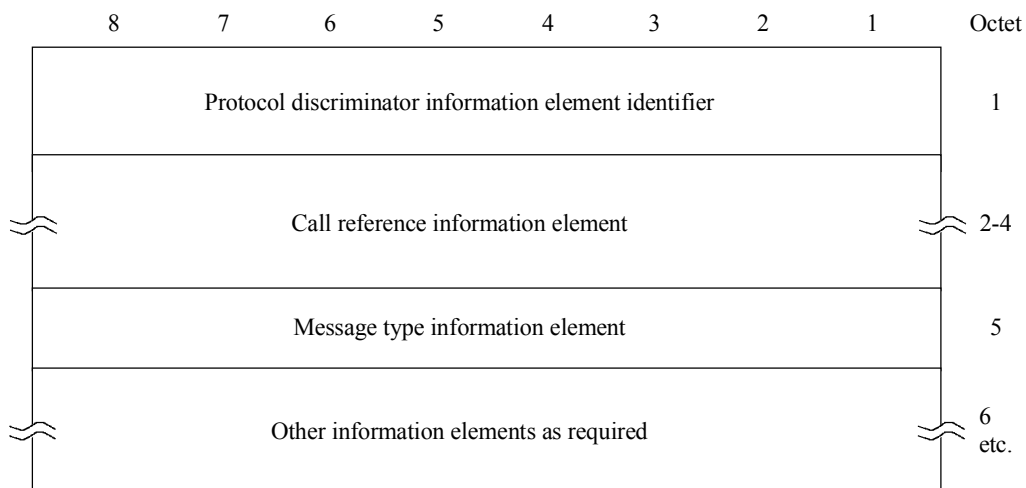

X.76_F09

Figure 9/X.76 – General message organization example

Unless specified otherwise, a particular information element may be present only once in a given message.

The following variable length information elements are used for frame relay switched virtual circuit:

Information element	I.E. identifier coding
Bearer capability	0000 0100
Call identification	0110 1001
Call state	0001 0100
Called party number	0111 0000
Called party SPVC	0000 1010
Called party subaddress	0111 0001
Calling party number	0110 1100
Calling party SPVC	0000 1011
Calling party subaddress	0110 1101
Cause	0000 1000
Clearing network identification	0110 1011
Closed user group interlock code	0110 1000
Connected number	0100 1100
Connected subaddress	0100 1101
Data Link Connection Identifier (DLCI)	0001 1001
Generic application transport (Note)	0110 1110
Link layer core parameters	0100 1000
Link layer protocol parameters	0100 1001
Low layer compatibility	0111 1100
Priority and service class parameters	0110 1010
Reverse charging indicator	0100 1010
Transit network identification	0110 0111
User-user	0111 1110

NOTE – Refer to Frame Relay Forum Implementation Agreement FRF.10.1 for the specification of the Generic Application Transport (GAT) information element.

The coding of the information elements other than the first three mandatory information elements (protocol discriminator, call reference and message type) is as follows:

- The information elements used with frame relay call control are of variable length. They are described in alphabetical order. However, there is a particular order of appearance for each information element in a message. The code values of the variable length information element identifiers are assigned in numerical order according to the actual order of appearance of each information element in a message. This allows a receiver to detect the presence or absence of a particular information element without scanning through the entire message.
- Information element identifier values (first octet of a variable length information element) with bits 5-8 coded 0000 are for information elements for which comprehension by the receiver is required.
- When the description of the information elements contains spare bits, these bits are indicated as being set to 0, and are not interpreted on reception.

- The second octet of a variable length information element indicates the total length of the contents starting with octet 3. It is the binary coding of the number of octets of the contents, with bit 1 as the least significant bit.
- Each octet of a variable length information element is numbered.
- Optional octet (s) are marked with asterisks (*).
- An octet group is a self-contained entity, it contains one or more octets. For frame relay information elements, the internal structure of an octet group is defined by using the following extension mechanism:
 - The first octet of an octet group is identified by a number (N). The subsequent octets are identified as Na, Nb, Nc, etc. Bit 8 of each octet is the *extension bit*. The value 0 of bit 8 indicates that the octet group continues to the next octet. The value 1 of bit 8 indicates that this octet is the last octet of the octet group. If one octet (Nc) must be present, the preceding octets (N, Na and Nb) must also be present.
 - In the description of the information elements, bit 8 is marked "0/1 ext." if another octet follows. Bit 8 is marked "1 ext." if this is the last octet of the octet group. In addition to the extension mechanism defined above, an octet N may be extended through the next octets N1, N2, N3, etc. by indications in bits 7-1 of octet N.
- When a field extends over more than one octet, the order of bit values progressively decreases as the octet number increases. The least significant bit of the field is represented by the lowest numbered bit of the highest-numbered octet of the field.

10.5.1 Protocol discriminator

The protocol discriminator is the first part (first octet) of every message. It is coded as shown in Figure 10.

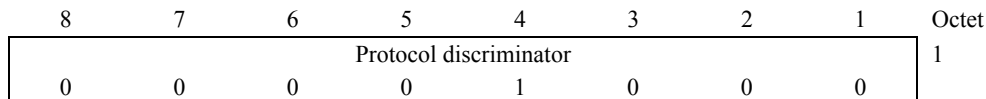

Figure 10/X.76 – Protocol discriminator

10.5.2 Call reference

The purpose of the call reference is to identify the switched virtual circuit to which the particular message applies. The call reference does not have end-to-end significance. The call reference is the second part of every message.

The call reference is coded as shown in Figure 11 and Table 13. Only call reference values of two octets (15 bits) are supported in this Recommendation. The encoding of the call reference value always uses two octets even if the value can be encoded in one octet only. Hence, the length field will always have a binary value of 0010. The most significant bit of the call reference value is bit 7 of octet 2 and the least significant bit is bit 1 of octet 3.

The purpose of the call reference flag is to identify who allocated the call reference value for a call. The call reference flag is used to resolve simultaneous attempts to allocate the same call reference value.

The call reference flag can take the binary values 0 or 1. The call reference flag is used to identify which end of the NNI originated a call reference. The origination side always sets the call reference flag to 0. The recipient side always sets the call reference flag to 1.

The call reference value will always have two octets. The call reference value is coded as a 15-bit binary number. A call reference value equal to zero is reserved for the global call reference value. The global call reference has also a length of 2 octets.

Figure 11 | Table 13/X.76 – Call reference information element

Figure 11 – Call reference information element structure

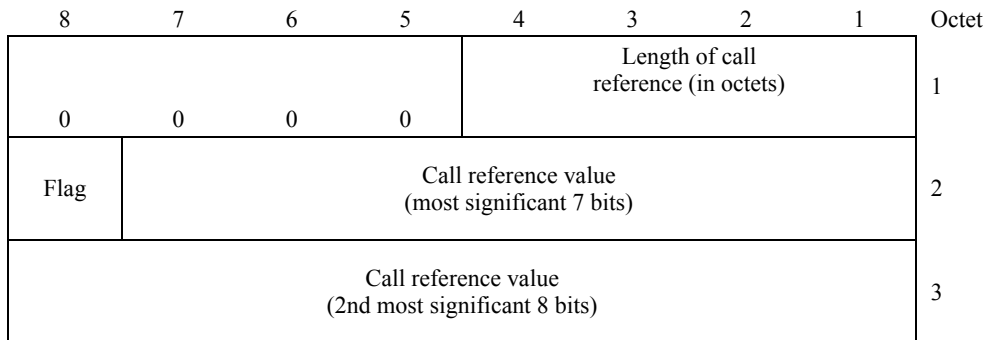

Table 13 – Call reference information element codepoints

<i>Flag (octet 2)</i>	
Bit	
<u>8</u>	
0	The message is sent from the side of the NNI that originates the call reference.
1	The message is sent to the side of the NNI that originates the call reference.

10.5.3 Message type

The following messages are used at the NNI:

<i>Message type</i>	<i>Message type codepoint</i>
CALL PROCEEDING	0000 0010
CONNECT	0000 0111
SETUP	0000 0101
RELEASE	0100 1101
RELEASE COMPLETE	0101 1010
RESTART	0100 0110
RESTART ACKNOWLEDGE	0100 1110
STATUS	0111 1101
STATUS ENQUIRY	0111 0101

10.5.4 Bearer capability

The purpose of the bearer capability information element is to request a bearer service. The only bearer service supported is the frame relay bearer service. The bearer capability information element is coded as shown in Figure 12 and Table 14.

Figure 12 | Table 14/X.76 – Bearer capability information element

Figure 12 – Bearer capability information element structure

8	7	6	5	4	3	2	1	Octet
Bearer capability information identifier								1
0	0	0	0	0	1	0	0	
Length of the bearer capability contents								2
0	0	0	0	0	0	1	1	
ext. 1	Coding standard 0 0		Information transfer capability 0 1 0 0 0					3
ext. 1	Transfer mode 0 1		Reserved 0 0 0 0 0					4
ext. 1	Layer 2 ident. 1 0		User information layer 2 protocol 0 1 1 1 1					6

NOTE – Octet numbering is according to ITU-T Rec. Q.931.

Table 14 – Bearer capability information element codepoints

<i>User information layer 2 protocol (octet 6)</i>							
Bits							
<u>5 4 3 2 1</u>							
0 1 1 1 1 Core aspects of frame mode (see Annex A/Q.922)							
All other values are reserved.							

10.5.5 Call identification

The call identification information element is used to uniquely identify a call. See Figure 13.

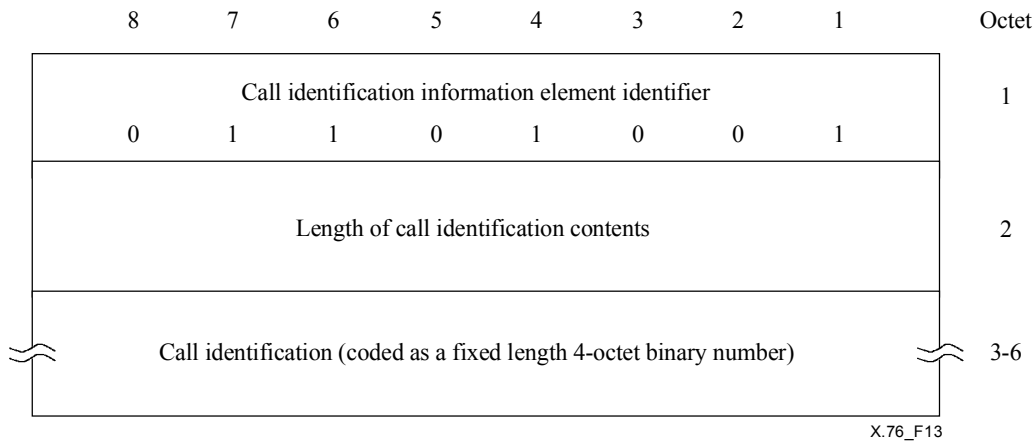

Figure 13/X.76 – Call identification information element

10.5.6 Call state

The call state information element is used to describe the state of a call. See Figure 14 and Table 15.

Figure 14 | Table 15/X.76 – Call state information element

Figure 14 – Call state information element structure

8	7	6	5	4	3	2	1	Octet
Call state information element identifier								
0	0	0	1	0	1	0	0	1
Length of call state contents								2
Coding standard		Call state value (state value is coded in binary)						3
0	0							

Table 15 – Call state information element codepoints

<i>Call state value (octet 3)</i>		
Bits		
<u>6 5 4 3 2 1</u>	<u>State</u>	
0 0 0 0 0 0	NN0	Null
0 0 0 0 0 1	NN1	Call initiated
0 0 0 0 1 1	NN3	Call proceeding sent
0 0 0 1 1 0	NN6	Call present
0 0 1 0 0 1	NN9	Call proceeding received
0 0 1 0 1 0	NN10	Active
0 0 1 0 1 1	NN11	Release request
0 0 1 1 0 0	NN12	Release indication
0 0 0 0 0 0	Rest0	Null
1 1 1 1 0 1	Rest1	Restart request
1 1 1 1 1 0	Rest2	Restart

10.5.7 Called party number

The purpose of the called party number information element is to identify the called party of a call. See Figure 15 and Table 16.

Figure 15 | Table 16/X.76 – Called party number information element

Figure 15 – Called party number information element

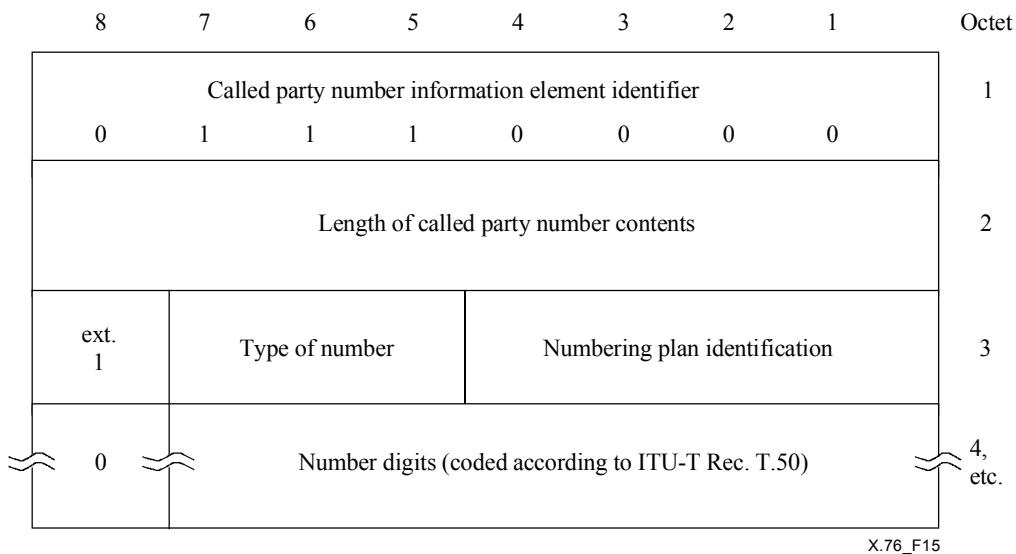

Table 16 – Called party number information element codepoints

<i>Type of number (octet 3)</i>	
Bits	
<u>7 6 5</u>	
0 0 1	International number (Note 1)
1 0 1	Alternative address (Note 2)
All other values are reserved.	
NOTE 1 – Prefix or escape digits shall not be included in the number digits.	
NOTE 2 – This codepoint is used in conjunction with the coding of an NSAP format called party number of an ATM end system. See also numbering plan identification.	
<i>Numbering plan identification (octet 3)</i>	
Bits	
<u>4 3 2 1</u>	
0 0 0 1	ISDN/telephony numbering plan (ITU-T Rec. E.164)
0 0 1 1	Data numbering plan (ITU-T Rec. X.121)
0 0 0 1	When the type of number is alternative address, this codepoint indicates ISO NSAP address coded according to Annex A of ITU-T Rec. X.213 ISO/IEC 8348 and Annex F/X.36.
All other values are reserved.	

Table 16 – Called party number information element codepoints

<i>Valid combinations of type of number and numbering plan fields</i>		
TON	NPI	Format
• International	E.164	CC + N(S)N
• International	X.121	DNIC + NTN
• Alternative address	ISO NSAP	AESA (Note 3)

NOTE 3 – This combination is used to allow the addressing of an AESA coded as an NSAP. The support of this combination is subject to bilateral agreements between networks. It is used to provide interworking of frame relay and ATM networks. The use of this combination does not imply that a frame relay network supports the numbering plans or addressing schemes identified in the AESA. It rather allows the selection of a route towards a frame relay/ATM interworking unit.

Number digits (octet 4, etc.)

The number digits appear in multiple octets starting at octet 4. One digit is coded per octet such that the leftmost digit is coded in octet 4. Each digit is coded according to ITU-T Rec. T.50.

10.5.8 Called party subaddress

The purpose of the called party subaddress information element is to identify the subaddress of the called party of the call. This information element is passed on transparently at the NNI. See Figure 16.

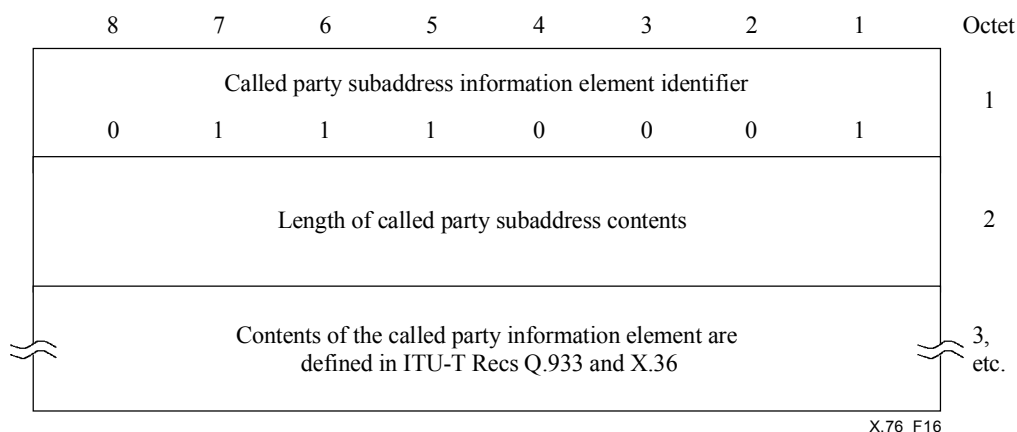

Figure 16/X.76 – Called party subaddress information element

10.5.9 Calling party number

The purpose of the calling party number information element is to identify the origin of a frame relay switched virtual circuit. See Figure 17 and Table 17.

Figure 17 | Table 17/X.76 – Calling party information element

Figure 17 – Calling party information element structure

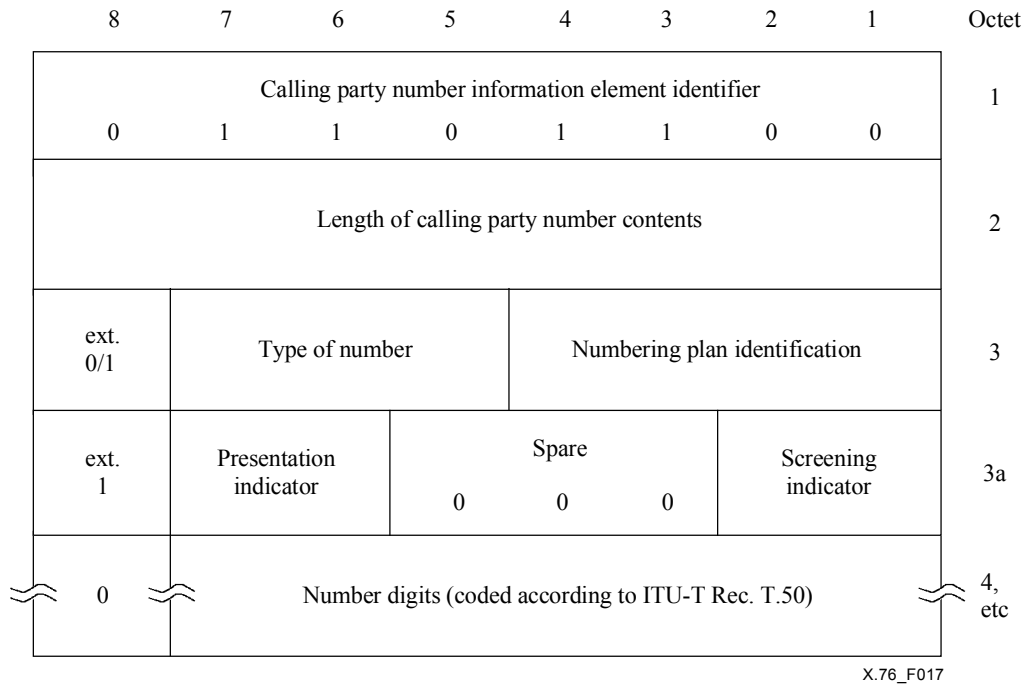

Table 17 – Calling party information element codepoints

<i>Type of Number (octet 3)</i>	
Bits	
<u>7 6 5</u>	
0 0 1	International number (Note 1)
1 0 1	Alternative address (Note 2)
All other values are reserved.	
NOTE 1 – Prefix or escape digits shall not be included in the number digits.	
NOTE 2 – This codepoint is used in conjunction with the coding of an NSAP format calling party number of an ATM end system.	
<i>Numbering plan identification (octet 3)</i>	
Bits	
<u>4 3 2 1</u>	
0 0 0 1	ISDN/telephony numbering plan (ITU-T Rec. E.164)
0 0 1 1	Data numbering plan (ITU-T Rec. X.121)
0 0 0 1	When the Type of Number is alternative address, this codepoint indicates ISO NSAP address coded according to Annex A of ITU-T Rec. X.213 ISO/IEC 8348 and Annex F/X.36.
All other values are reserved.	

Table 17 – Calling party information element codepoints

<i>Valid combinations of type of number and numbering plan fields:</i>		
TON	NPI	Format
• International	E.164	CC + N(S)N
• International	X.121	DNIC + NTN
• Alternative address	ISO NSAP	AESA (Note 3)
NOTE 3 – This combination is used to allow the transport of an ATM end system calling address coded as an NSAP. The support of this combination is subject to bilateral agreements between networks.		
The other combinations are invalid.		
<i>Presentation indicator (octet 3a)</i>		
Bits		
<u>7 6</u>		
0 0	Presentation allowed	
All other values are reserved.		
<i>Screening indicator (octet 3a)</i>		
Bits		
<u>2 1</u>		
0 1	User provided verified and passed (Note 4)	
1 1	Network provided	
All other values are reserved.		
NOTE 4 – Since in some cases the network cannot guarantee that the complete number identifies the calling DTE, the term "verified" implies matching the user provided number or part of this number with the range(s) of numbers stored at the network. It implies also at least a valid format of user provided number information.		
<i>Number digits (octet 4, etc.)</i>		
The number digits appear in multiple octets starting at octet 4. One digit is coded per octet such that the leftmost digit is coded in octet 4. Each digit corresponds to a character coded according to ITU-T Rec. T.50.		

10.5.10 Calling party subaddress

The purpose of the calling party subaddress information element is to identify the subaddress of the originator of the frame relay call. This information element is passed on transparently at the NNI. See Figure 18.

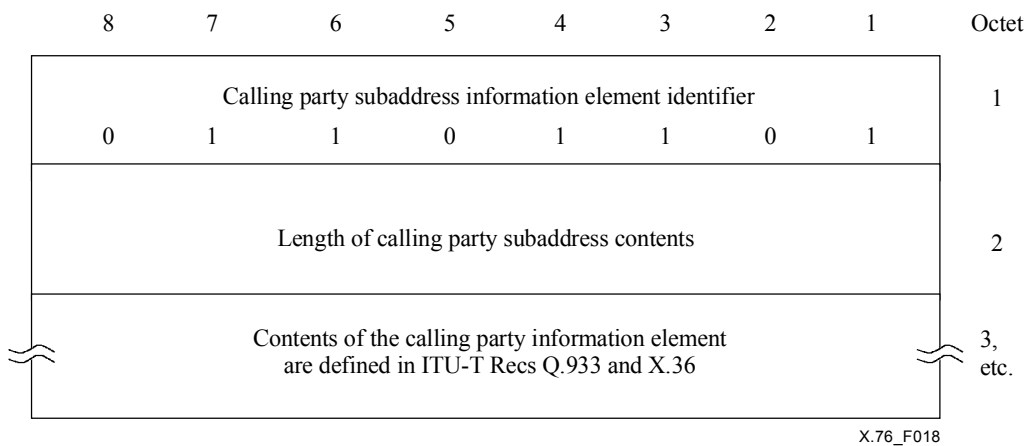

Figure 18/X.76 – Calling party subaddress information element

10.5.11 Cause

The purpose of the cause information element is to identify an event that occurred to a frame relay SVC, a DTE/DCE interface or the frame relay network and to provide a reason for clearing a frame relay SVC. The cause information element is coded as shown in Figure 19 and Table 18. Annex B provides detailed information on the use and coding of the cause information element fields. The cause information element may be repeated once.

Figure 19 | Table 18/X.76 – Cause information element

Figure 19 – Cause information element structure

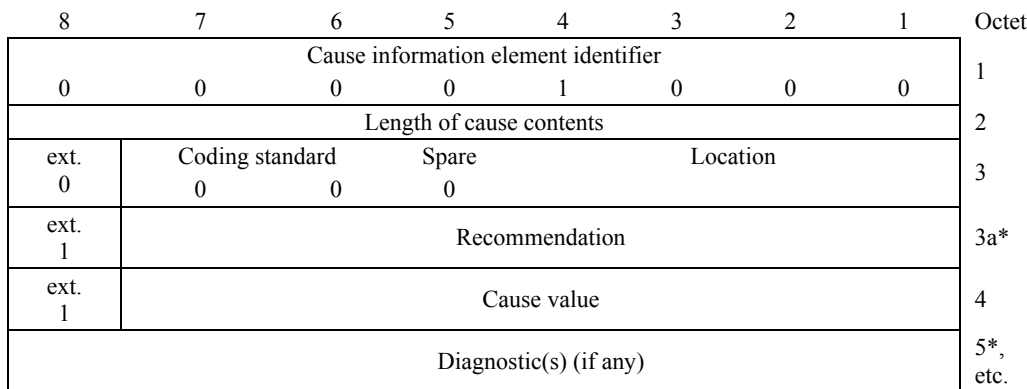

Table 18 – Cause information element codepoints

Location (octet 3) (see B.1 on Location field generation)

Bits

4 3 2 1

- 0 0 0 0 User (U)
- 0 0 0 1 Private network serving the local user (LPN)
- 0 0 1 0 Public network serving the local user (LN)
- 0 0 1 1 Transit network (TN)
- 0 1 0 0 Public network serving the remote user (RLN)
- 0 1 0 1 Private network serving the remote user (RPN)
- 0 1 1 1 International network (INTL)
- 1 0 1 0 Network beyond interworking point (BI)

All other values are reserved.

Mapping cause location at the NNI (octet 3)

The location "Private network serving the local user" or "Public network serving the local user" should not be sent across the frame relay NNI. The conversion from "Private network serving the local user" to "Private network serving the remote user" or "Public network serving the local user" to "Public network serving the remote user" shall take place in the network generating the cause.

In all other cases the location indicator shall be passed unchanged.

Recommendation (octet 3a, bits 1 to 7)

Bits

7 6 5 4 3 2 1

- 0 0 0 0 0 0 0 ITU-T Rec. Q.931
- 0 0 0 0 1 1 1 ITU-T Rec. X.76

All other values are reserved

NOTE – If octet 3a is not present, the Recommendation is assumed to be ITU-T Rec. X.76.

Cause value (octet 4, bits 1 to 7)

The cause value is divided into two fields, a class (bit 5 to 7) and a value within the class (bits 1 to 4). The class indicates the general nature of the event:

Bits

7 6 5

- 0 0 0 Normal event
- 0 0 1 Normal event
- 0 1 0 Resource unavailable
- 0 1 1 Service or option not available
- 1 0 0 Service or option not implemented
- 1 0 1 Invalid message
- 1 1 0 Protocol error
- 1 1 1 Interworking

See Annex B for the cause values.

- **Diagnostic(s)** (octet 5): See Annex B on Coding of the diagnostic field for the relevant diagnostic codes.

10.5.12 Clearing network identification

The purpose of this information element is to identify the network responsible for clearing of a call. See Figure 20 and Table 19.

Figure 20 | Table 19/X.76 – Clearing network identification information element

Figure 20 – Clearing network identification information element structure

8	7	6	5	4	3	2	1	Octet
Clearing network identification information element identifier								
0	1	1	0	1	0	1	1	1
Length of clearing network identification								2
ext.	Type of network identification			Network identification plan				
1	0	1	1					3
0	Network identification (coded according to ITU-T Rec. T.50)							4, etc.

Table 19 – Clearing network identification information element codepoints

<p><i>Network identification plan (octet 3)</i></p> <p>Bits</p> <p><u>4 3 2 1</u></p> <p>0 0 1 0 Network identification using E.164 country code (Note)</p> <p>0 0 1 1 Data network identification code (ITU-T Rec. X.121)</p> <p>All other values are reserved.</p> <p>NOTE – This codepoint is used to identify public frame relay networks numbered under the E.164 numbering plan (see Appendix II). The network identification consists of an E.164 country code followed by a network number. The maximum size is 8 octets.</p> <p><i>Network identification (octet 4)</i></p> <p>These characters coded according to ITU-T Rec. T.50 are organized according to the network identification plan specified in octet 3.</p>
--

10.5.13 Closed user group interlock code

The purpose of the closed user group interlock code information element is to indicate the interlock code of the closed user group to be used for the call and the type of access selection. See Figure 21 and Table 20.

Figure 21 | Table 20/X.76 – Closed user group interlock code information element

Figure 21 – Closed user group interlock code information element structure

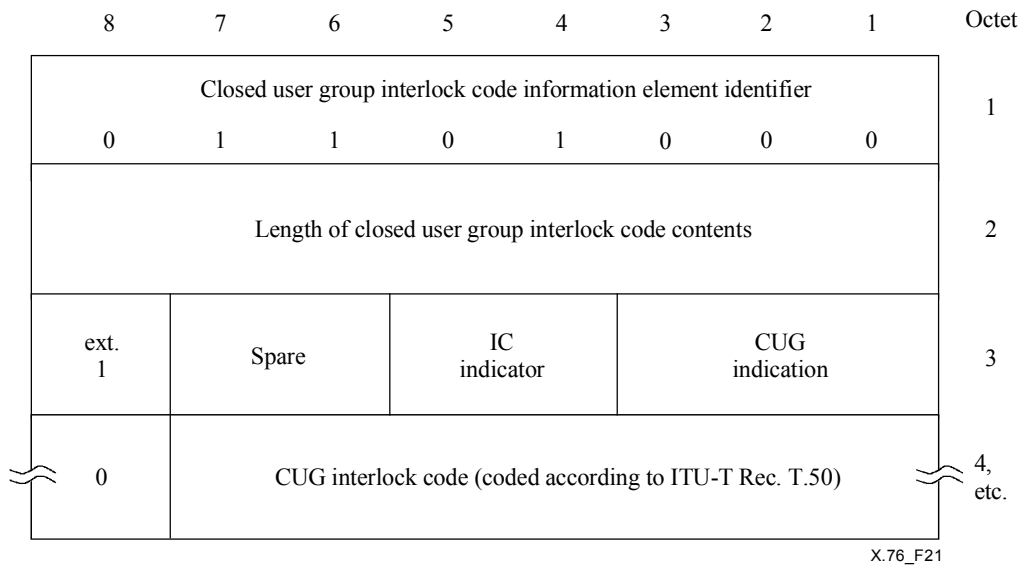

Table 20 – Closed user group interlock code information element codepoints

<p><i>CUG indication (octet 3)</i></p> <p>Bits</p> <p><u>3 2 1</u></p> <p>0 0 1 Closed user group selection</p> <p>0 1 0 Closed user group with outgoing access selection and indication</p> <p><i>Interlock Code (IC) indicator (octet 3)</i></p> <p>Bits</p> <p><u>5 4</u></p> <p>0 1 DNIC interlock code</p> <p>1 0 Interlock coded using E.164 country code</p> <p><i>CUG interlock code (octet 4, etc.)</i></p> <p>The CUG interlock code is represented by a variable number of octets encoded according to ITU-T Rec. T.50. The CUG interlock code consists of a network identification as specified in the clearing network identification information element and a closed user number with fixed length of 5 octets. Only T.50 characters 0-9 shall be used to represent a closed user group number. The closed user group number shall not be greater than 65535. These two components guarantee the uniqueness of the interlock code globally and within the assigning network.</p>

10.5.14 Connected number

The purpose of the connected number is to identify the responding party of the call. The coding of the connected number information element is the same as the coding of the calling party number information element. See Figure 22.

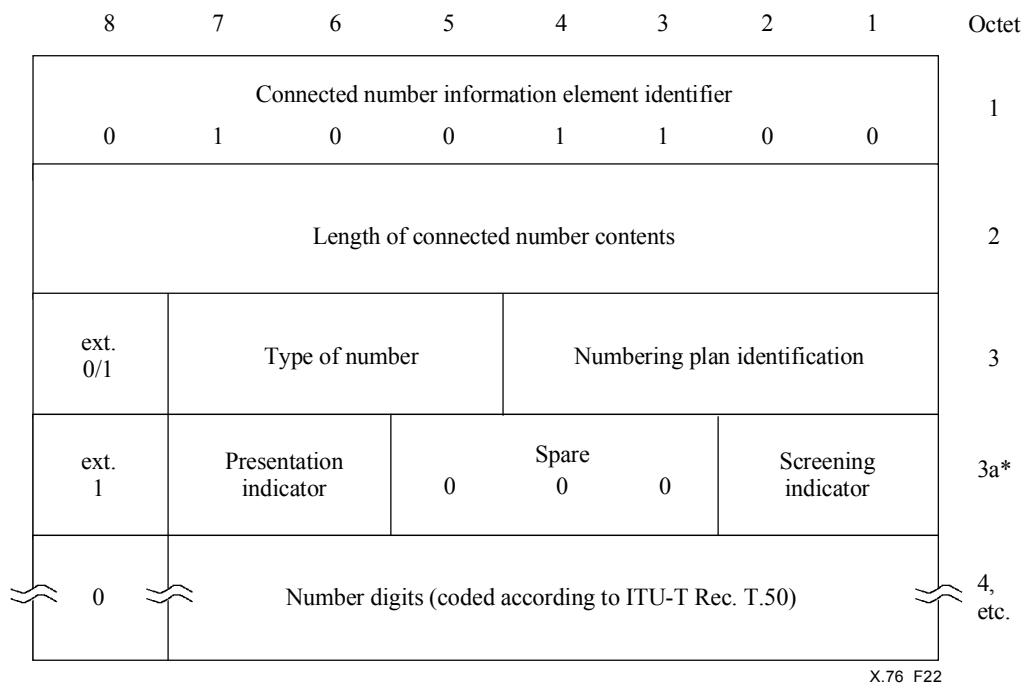

Figure 22/X.76 – Connected number information element

10.5.15 Connected subaddress

The purpose of the connected subaddress is to identify the subaddress of the responding user/DTE of a call. This information element is carried transparently at the NNI. See Figure 23.

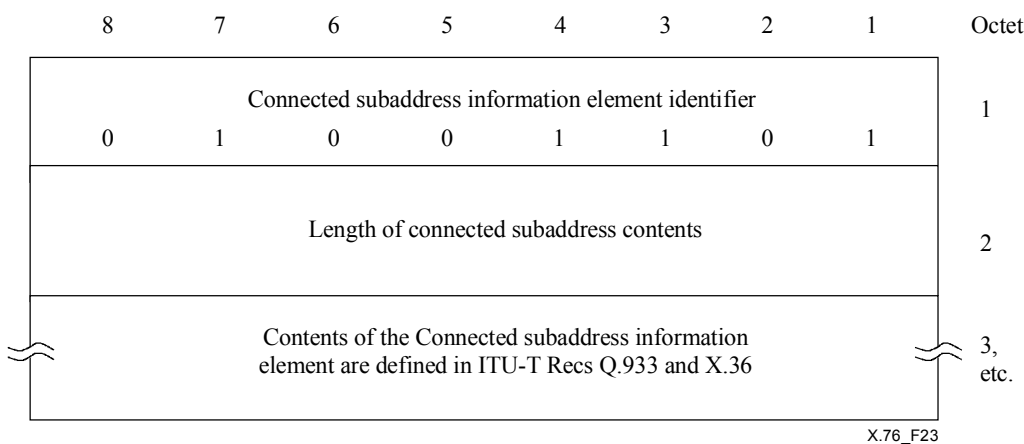

Figure 23/X.76 – Connected subaddress information element

10.5.16 Data link connection identifier

The data link connection identifier information element identifies the Data Link Connection Identifier (DLCI) selected or assigned and the selection option.

The DLCI is coded as shown in Figure 24 and Table 21. The default length of the DLCI values is two octets (16 bits). By bilateral agreements, some networks may support DLCI length of four octets.

Figure 24 | Table 21/X.76 – Data link connection identifier information element

Figure 24 – Data link connection identifier information element structure

8	7	6	5	4	3	2	1	Octet
Data link connection identifier information element identifier								1
0	0	0	1	1	0	0	1	
Length of data link connection identifier contents								2
ext. 0	Pref/ Excl	Data link connection identifier (Most significant 6 bits)						3 (Note 1) (Note 2)
ext. 0/1	Data link connection identifier (2nd most significant 4 bits)				(Reserved) 0 0 0			3a
ext. 0	Data link connection identifier (3rd most significant 7 bits)							3b* (Note 3)
ext. 1	Data link connection identifier (4th most significant 6 bits)						Res. 0	3c* (Note 3)

NOTE 1 – The standard default length of the DLCI is two octets.

NOTE 2 – Bit 6 of octet 3 is the most significant bit in the DLCI.

NOTE 3 – These octets shall both be included only when bilateral agreements allow a four-octet DLCI (23 bits).

Table 21 – Data link connection identifier information element codepoints

<p><i>Pref/Excl (octet 3)</i></p> <p>Bit</p> <p><u>7</u></p> <p>1 Exclusive, only the indicated DLCI is acceptable</p> <p>All other values are reserved.</p> <p><i>Data link connection identifier (octet 3 and 3a, optionally 3b and 3c)</i></p> <p>Data link connection identifier is coded as a binary number.</p>

10.5.17 End-to-end transit delay

This information element is no longer supported in this Recommendation (see Note in 10.1).

(Figure deleted)

Figure 25/X.76 – End-to-end transit delay

10.5.17 bis Generic application transport

(Refer to Frame Relay Forum FRF10.1 Annex A)

10.5.18 High layer compatibility

This information element is no longer supported in this Recommendation (see Note in 10.1).

(Figure deleted)

Figure 26/X.76 – High layer compatibility information element

10.5.19 Link layer core parameters

The purpose of the link layer parameters information element is to indicate the requested frame relay quality of service parameters to be used for the frame relay SVC. The term "outgoing" used at the UNI should be interpreted to mean "forward direction" at the NNI and "incoming" should be interpreted to mean "backward direction" at the NNI. See Figure 27 and Table 22.

Figure 27 | Table 22/X.76 – Link layer core parameters information element

Figure 27 – Link layer core parameters information element structure

	8	7	6	5	4	3	2	1	Octet
Link layer core parameters information element identifier									1
	0	1	0	0	1	0	0	0	
Length of link layer core parameters contents									2 (Note)
ext. 0	Maximum frame relay information field (FRIF) size								3
ext. 0	Outgoing maximum FRIF size								3a
ext. 0/1	Outgoing maximum FRIF size (cont.)								3b
ext. 0	Incoming maximum FRIF								3c*
ext. 1	Incoming maximum FRIF size (cont.)								3d*
ext. 0	Throughput								4
	0	0	0	1	0	1	0		
ext. 0	Outgoing magnitude			Outgoing multiplier					4a
ext. 0/1	Outgoing multiplier (cont.)								4b
ext. 0	Incoming magnitude			Incoming multiplier					4c*
ext. 1	Incoming multiplier (cont.)								4d*
ext. 0	Minimum acceptable throughput								5*
	0	0	0	1	0	1	1		
ext. 0	Outgoing magnitude			Outgoing multiplier					5a*
ext. 0/1	Outgoing multiplier (cont.)								5b*
ext. 0	Incoming magnitude			Incoming multiplier					5c*
ext. 1	Incoming multiplier (cont.)								5d*
ext. 0	Committed burst size								6
	0	0	0	1	1	0	1		
ext. 0	Outgoing committed burst size value								6a
ext. 0/1	Outgoing committed burst size value (cont.)								6b
ext. 0	Incoming committed burst size value								6c*
ext. 1	Incoming committed burst size value (cont.)								6d*
ext. 0	Excess burst size								7
	0	0	0	1	1	1	0		
ext. 0	Outgoing excess burst size value								7a
ext. 0/1	Outgoing excess burst size value (cont.)								7b
ext. 0	Incoming excess burst size value								7c*
ext. 1	Incoming excess burst size value (cont.)								7d*
ext. 0	Committed burst size magnitude								8*
	0	0	1	0	0	0	0		
ext. 1	Spare	Incoming Bc magnitude		Outgoing Bc magnitude					8a*
ext. 0	Excess burst size magnitude								9*
	0	0	1	0	0	0	1		
ext. 1	Spare	Incoming Be magnitude		Outgoing Be magnitude					9a*

X.76_F27

NOTE – All parameters are position independent.

Table 22 – Link layer core parameters information element codepoints

Maximum frame mode information field (octet group 3)

The maximum frame mode information field, when present, follows the address field and precedes the frame check sequence field. The default maximum size is 1600 octets.

If the maximum frame mode information field is symmetrical (same size in the incoming and outgoing directions), octets 3c and 3d are not coded and the value in octets 3a and 3b are used for both directions.

Throughput (octet group 4)

The throughput (also known as CIR or Committed Information Rate) is the average number of bits of the frame mode information field transferred per second across the NNI in one direction. The throughput is measured over an interval of duration "T" known also as the Committed rate measurement interval (Tc).

The throughput can be asymmetrical if the values in the incoming and outgoing directions differ. If the throughput is symmetrical, octets 4c and 4d are not coded and the value in octets 4a and 4b are used for both directions.

Minimum acceptable throughput (octet group 5)

The purpose of the minimum acceptable throughput is to negotiate the throughput of the call. Minimum acceptable throughput is the lowest throughput value the calling user is willing to accept for the call.

This field which is present only in the SETUP message is carried unchanged through the network(s). Its value may not be greater than the requested throughput (octet group 4).

The minimum acceptable throughput can be asymmetrical (the values in the incoming and outgoing directions differ). If the minimum acceptable throughput is symmetrical, octets 5c and 5d are not coded and the value in octets 5a and 5b are used for both directions.

Throughput and minimum acceptable throughput are expressed as an order of magnitude (in powers of 10) and an integer multiplier. The multiplier shall be encoded as the smallest possible number. For example a throughput of 64 kbit/s shall be expressed as 64×10^3 and not 640×10^2 .

Magnitude (octet 4a, 4c, 5a and 5c)

Bits

7 6 5

0 0 0 10^0

0 0 1 10^1

0 1 0 10^2

0 1 1 10^3

1 0 0 10^4

1 0 1 10^5

1 1 0 10^6

All other values are reserved.

Multiplier (octet 4a, 4b, 4c, 4d, 5a, 5b, 5c, and 5d)

This field indicates in binary the value by which the magnitude shall be multiplied to obtain the throughput and the minimum acceptable throughput.

Committed burst size (octet group 6)

This field indicates the maximum amount of data (in bits) that the network agrees to transfer over the measurement interval T. This data may appear in one or more frames possibly with interframe idle flags.

This field specifies a number of octets. Therefore the committed burst size is $8 \times$ the contents of this field. If the committed burst size is symmetrical, octets 6c and 6d are not coded and the value in octets 6a and 6b are used for both directions.

Table 22 – Link layer core parameters information element codepoints

Excess burst size (octet group 7)

This field indicates the maximum amount of uncommitted data (in bits) that the network will attempt to deliver over the measurement interval T. This data may appear in one or more frames possibly with interframe idle flags. Excess burst may be marked discard eligible (DE) by the network.

This field specifies a number of octets. Therefore the excess burst size is $8 \times$ the contents of this field. If the excess burst size is symmetrical, octets 7c and 7d are not coded and the value in octets 7a and 7b are used for both directions.

NOTE – The same range of values for the CIR, burst size, excess burst size, committed measurement interval and algorithms used for PVC should also be used in the case of SVC.

Committed burst size magnitude (octet 8 and 8a)

The committed burst size magnitude field indicates the magnitude of the committed burst size. It is expressed as a power of 10. It is multiplied by the committed burst size value (octet group 6) to give the actual value of the committed burst size. When the incoming committed burst size field is not included (in octet group 6), the incoming magnitude has no significance.

The outgoing and incoming Bc magnitudes are coded as a power of 10 as follows:

Bits

3 2 1

0 0 0 10^0

0 0 1 10^1

0 1 0 10^2

0 1 1 10^3

1 0 0 10^4

1 0 1 10^5

1 1 0 10^6

All other values are reserved.

The values coded in octet 8a shall be the smallest values required to represent the outgoing and incoming committed burst sizes.

Excess burst size magnitude (octet 9 and 9a)

The excess burst size magnitude field indicates the magnitude of the excess burst size. It is expressed as a power of 10. It is multiplied by the excess burst size value (octet group 7) to give the actual value of the excess burst size. When the incoming excess burst size field is not included (in octet group 7), the incoming magnitude has no significance.

The outgoing and incoming Be magnitudes are coded as a power of 10 as follows:

Bits

3 2 1

0 0 0 10^0

0 0 1 10^1

0 1 0 10^2

0 1 1 10^3

1 0 0 10^4

1 0 1 10^5

1 1 0 10^6

All other values are reserved.

The values coded in octet 9a shall be the smallest values required to represent the outgoing and incoming excess burst sizes.

10.5.20 Link layer protocol parameters

The purpose of the link layer protocol parameters information element is to indicate the requested layer 2 parameter values. The link layer protocol parameters information element is passed on transparently at the NNI. See Figure 28.

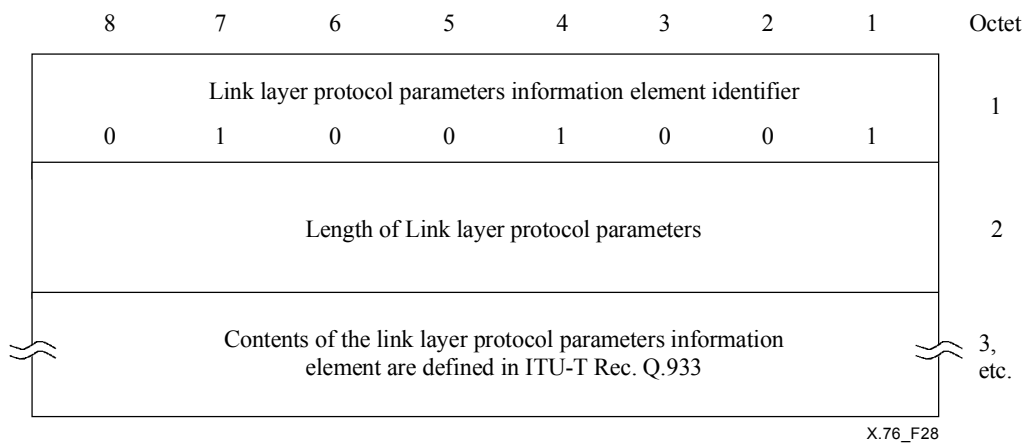

Figure 28/X.76 – Link layer protocol parameters information element

10.5.21 Low layer compatibility

The purpose of the low layer compatibility information element is to provide a means which should be used for compatibility checking by an addressed entity (e.g., remote DTE or an interworking unit or a high layer function of a DCE node addressed by the calling DTE). The low layer compatibility information element is transferred transparently by a frame relay network between the calling DTE and the addressed entity. See Figure 29.

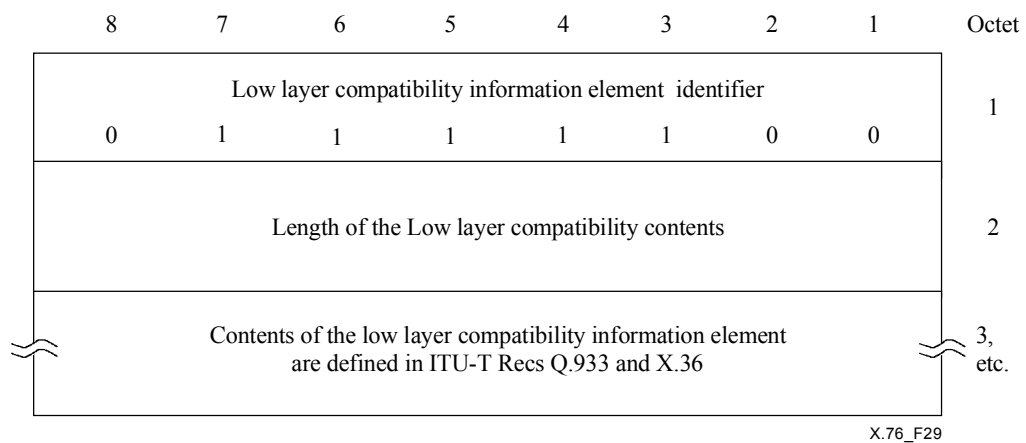

Figure 29/X.76 – Low layer compatibility information element

10.5.22 Packet layer binary parameters

This information element is no longer supported in this Recommendation (see Note in 10.1).

(Figure deleted)

Figure 30/X.76 – Packet layer binary parameters information element

10.5.23 Priority and service class parameters information element

The purpose of the priority and service class parameters information element is to convey information in the setup message on the priorities or service class applicable to the call.

The priority and service class parameters information element is shown in Figure 31 and in Table 23.

Figure 31 | Table 23/X.76 – Priority and service class parameters information element

Figure 31 – Priority and service class parameters information element structure

8	7	6	5	4	3	2	1	Octet
Priority and service class parameters information element identifier								1
0	1	1	0	1	0	1	0	
Length of priority and service class parameters information element contents								2
Frame transfer priority identifier								3*
0	0	0	0	0	0	0	1	
Outgoing transfer priority index				Incoming transfer priority index				3.1*
Frame discard priority identifier								4*
0	0	0	0	0	0	1	0	
Outgoing frame discard priority index				Incoming frame discard priority index				4.1*
Service class identifier								5
0	0	0	0	0	0	1	1	
Service class value								5.1*

Table 23 – Priority and service class parameters information element codepoints

Outgoing transfer priority index (octet 3.1 bits 5-8) (Notes 1, 2)

A binary number in the range of 0 to 15 indicating the frame transfer priority index for the outgoing direction. 0 denotes the lowest priority and 15 the highest.

Incoming requested transfer priority (octet 3.1 bits 1-4) (Notes 1, 2)

A binary number in the range of 0 to 15 indicating the frame transfer priority index for the incoming direction. 0 denotes the lowest priority and 15 the highest.

NOTE 1 – A frame transfer priority index has a local significance.

NOTE 2 – The term outgoing refers to the calling to called DTE direction and the term incoming refers to the direction from the called to calling DTE.

Outgoing frame discard priority index (octet 4.1 bits 5-8) (Notes 3, 4)

A binary number in the range of 0 to 7 indicating the frame discard priority index in the outgoing direction. 0 denotes the lowest priority (first to be discarded) and 7 the highest. Other values (8 to 15) are reserved.

Incoming frame discard priority index (octet 4.1 bits 1-4) (Notes 3, 4)

A binary number in the range of 0 to 7 indicating the frame discard priority index in the incoming direction. 0 denotes the lowest priority (first to be discarded) and 7 the highest. Other values (8 to 15) are reserved.

NOTE 3 – A frame discard priority index has local significance.

NOTE 4 – The term outgoing refers to the calling to called DTE direction and the term incoming refers to the direction from the called to calling DTE.

Table 23 – Priority and service class parameters information element codepoints

<p><i>Service class value</i></p> <p>A binary number in the range 0 to 4 indicating the specified service class. Other values are reserved. Service classes and their associated quality of service characteristics are standardized – see Table 28 and ITU-T Rec. X.146.</p> <p>NOTE 5 – Priorities and service class parameters may not both be present in the same priority and service class parameters information element. In this case, the receiving STE will treat only the service class parameter as valid and shall discard the priority parameters.</p>
--

10.5.24 Progress indicator

This information element is no longer supported in this Recommendation (see Note in 10.1).

(Figure deleted)

Figure 32/X.76 – Progress indicator information element

10.5.25 Reverse charging indicator

The purpose of the reverse charging information element is to indicate that reverse charging has been requested for that call. The use of this information element is governed by bilateral agreements between the networks involved. See Figure 33 and Table 24.

Figure 33 | Table 24/X.76 – Reverse charging indicator information element

Figure 33 – Reverse charging indicator information element structure

8	7	6	5	4	3	2	1	Octet
Reverse charging indicator information element identifier								
0	1	0	0	1	0	1	0	1
Length of reverse charging indicator contents								
0	0	0	0	0	0	0	1	2
ext.	Spare			Reverse charging indicator				
1	0	0	0	0				3

Table 24 – Reverse charging information element codepoints

<p><i>Reverse charging indicator (octet 3)</i></p> <p>Bits</p> <p><u>3 2 1</u></p> <p>0 0 1 Reverse charging requested</p> <p>All other values are reserved.</p>
--

10.5.26 Transit network identification

The purpose of this information element is to identify a transit network along the path of call. See Figure 34 and Table 25.

Figure 34 | Table 25/X.76 – Transit network identification information element

Figure 34 – Transit network identification information element structure

8	7	6	5	4	3	2	1	Octet
Transit network identification information element identifier								1
0	1	1	0	0	1	1	1	
Length of transit network identification contents								2
ext.	Type of network identification			Network identification plan				3
1	0	1	1					
0	Network identification (coded according to ITU-R Rec. T.50)							4, etc.

Table 25 – Transit network identification information element codepoints

<p><i>Network identification plan (octet 3)</i></p> <p>Bits</p> <p><u>4 3 2 1</u></p> <p>0 0 1 0 Network identification using E.164 country code (Note)</p> <p>0 0 1 1 Data network identification code (ITU-T Rec. X.121)</p> <p>All other values are reserved.</p> <p>NOTE – This codepoint is used to identify public frame relay networks numbered under the E.164 numbering plan (see Appendix II). The network identification consists of an E.164 country code followed by a network number. The maximum size is 8 octets.</p> <p><i>Network identification (octet 4)</i></p> <p>These characters coded according to ITU-T Rec. T.50 are organized according to the network identification plan specified in octet 3.</p>
--

10.5.27 Transit network selection

This information element is no longer supported in this Recommendation (see Note in 10.1). However, the transit network selection facility is still supported (see 10.6.9.6).

(Figure deleted)

Figure 35/X.76 – Transit network selection information element

Table 26/X.76 – Transit network selection information element

(Table deleted)

10.5.28 User-user

The purpose of the user-user information element is to convey information between the users/DTEs. This information is carried transparently at the NNI. The user-user information element is coded as shown in Figure 36.

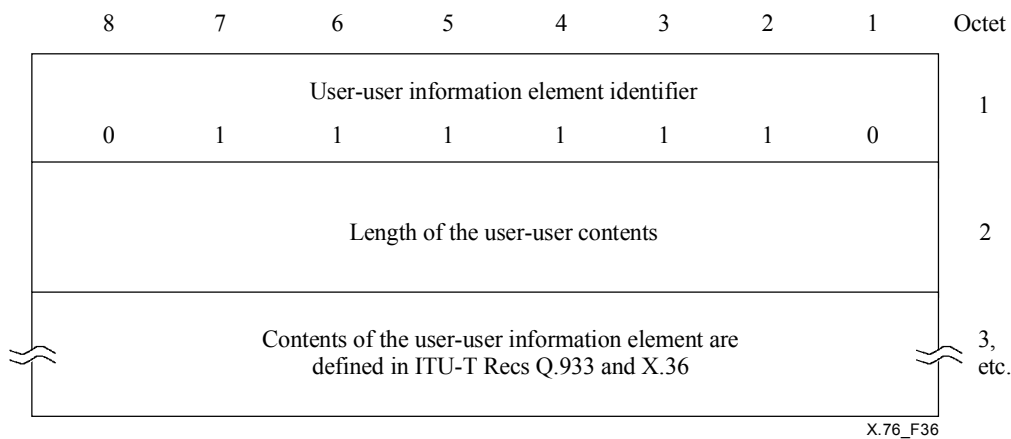

Figure 36/X.76 – User-to-user information element

10.5.29 X.213 priority

This information element is no longer supported in this Recommendation (see Note in 10.1).

(Figure deleted)

Figure 37/X.76 – X.213 priority information element

10.6 Call establishment

10.6.1 Call establishment at the calling STE

10.6.1.1 Initiating a call setup request

The calling STE initiates the establishment of a SVC by transferring a SETUP message across the NNI on DLCI = 0. Following the transmission of the SETUP message, the calling STE shall start timer T303 and enter the call present state (NN6). If no response to the SETUP is received from the called STE before the first expiry of timer T303, the SETUP message shall be retransmitted and timer T303 restarted. At the second expiry, the calling STE shall perform clearing procedure in the backward direction with cause No. 102 *Recovery on timer expiry*.

Traffic parameters negotiation

The link layer core parameter: maximum frame information, throughput, committed and excess burst sizes selected by the calling STE shall be coded in the link layer core parameters information element and shall reflect any reduction performed by the calling STE while progressing the SVC setup request.

Data link connection identifier selection

The calling STE shall select a DLCI to be included in the SETUP message according to 10.6.7. In the SETUP message, the data link connection identifier information element shall indicate an exclusive DLCI with no acceptable alternative.

The calling STE shall include the calling party number information element in the SETUP message. Octet 3a shall be coded according to the information supplied by the DCE at the calling UNI or DTE/DCE interface. This implies that all originating networks supporting ITU-T Recs X.36 or Q.933 must conform to the coding specified in Table 17.

10.6.1.2 Call proceeding

At the receipt of a CALL PROCEEDING message, the calling STE node shall stop timer T303 and start timer T310. At the expiry of timer T310, the call shall be cleared with the called STE by following the procedure of 10.6.3 *Normal call clearing* with cause No. 102 *Recovery on timer expiry* and shall initiate call clearing in the backward direction with cause No. 102 *Recovery on timer expiry*.

10.6.1.3 Alerting and call progressing

The contents of this subclause are no longer applicable (see Note in 10.1).

10.6.1.4 Call established

Upon receiving a CONNECT message from the called STE indicating that the called user/DTE has accepted the call, the calling STE shall stop timer T310, perform the connect establishment process in the backward direction and enter the Active state (NN10).

10.6.2 Call establishment at the called STE

10.6.2.1 Receiving a call setup request

Call establishment is performed by the called STE as a response to a call request received from a calling STE. The following procedures are followed by the called STE to set up the frame relay SVC.

At the receipt of a SETUP message, the called STE shall enter the call initiated state (NN1). It shall then determine that the request to set up a frame relay SVC can be granted and that a route is available toward the called user. After examining the traffic parameters received from the calling STE node, the called STE node can take one of the following actions:

- If it is able to provide the requested traffic parameter values, it will progress the call to the called user with the original parameters received.
- If unable to provide the requested traffic parameters but able to provide at least the lowest acceptable parameters, it will progress the call to the called user after adjusting the appropriate parameters. The adjusted parameters will support at least the lowest acceptable values.
- If unable to provide at least the lowest acceptable traffic parameters, the calling STE will reject the call with cause No. 49 *Quality of Service not available* and perform the clearing process in the backward direction towards the calling user/DTE. After that the called STE shall return to the Null state (NN0).

If the called STE determines that it can set up the call, it shall reply with a CALL PROCEEDING to acknowledge the receipt of the SETUP message and to indicate that the call is being processed. After sending the CALL PROCEEDING message, the called STE node shall enter the Call proceeding sent state (NN3).

10.6.2.2 Alerting and call progressing

The contents of this subclause are no longer applicable (see Note in 10.1).

10.6.2.3 Call established

Upon receiving an indication that the called user accepted the call, the called STE node sends a CONNECT message to the calling STE node and enter the active state (NN10). The link layer core parameters information element contains the final negotiated values.

If the connected number information element is present in the CONNECT message, then octet 3a of the connected number information element shall be coded according to the information supplied by the network at the called UNI or DTE/DCE interface.

10.6.3 Normal call clearing

Normal clearing is usually initiated at a UNI. At the NNI, call clearing may be initiated by either side of the NNI as a response to a call clearing request initiated at a UNI or for other reasons.

10.6.3.1 Initiation of the clearing of a call

To clear a call at the NNI, a network shall transfer a RELEASE message, start timer T308, release the DLCI and enter the release request state (NN11).

At the receipt of a RELEASE COMPLETE message as a response to the RELEASE message, the receiving network shall stop timer T308, release the call reference for future use and enter the null state (NN0).

NOTE – The RELEASE COMPLETE message has only local significance and does not imply an acknowledgement of end-to-end clearing.

If timer T308 expires for the first time, the STE shall retransmit the RELEASE message with a cause number originally contained in the first RELEASE message; restart timer T308 and remain in the release request state (NN11). In addition, the STE may indicate a second cause information element with cause No. 102 *Recovery on timer expiry*. If no RELEASE COMPLETE message is received from the other STE before timer T308 expires a second time, the STE shall: release the call reference and return to the null state (NN0). This event may be logged as an abnormal event, the actions taken are network dependent.

10.6.3.2 Receipt of a RELEASE message

At the receipt of the RELEASE message, the receiving STE shall enter the release indication state (NN12). This message then prompts the receiving STE to release the DLCI and to initiate procedures for clearing the SVC towards the DTE. Then the receiving STE shall send a RELEASE COMPLETE message to the initiating STE, free the call reference and return to the null state (NN0).

10.6.3.3 Clearing in the null state

In the Null state (NN0) a network shall perform the clearing procedure by a sending RELEASE COMPLETE message, release any allocated resource and remain in the Null state (NN0).

10.6.3.4 Clearing collision

A call clearing collision happens when the two sides of the NNI simultaneously send each other a RELEASE message with the same call reference identifier.

When a network detects a clearing collision, it shall consider the receipt of the RELEASE message a reply to the RELEASE message sent previously. It shall therefore release the call reference for future use and enter the null state (NN0).

10.6.4 Restart procedure

The restart procedure is used to return a frame relay NNI to an idle or null state. The restart procedure may be used to recover from internal failure, after power-up or after internal re-initialization. The restart procedure affects only the switched virtual circuits and has no effect on the permanent virtual circuits. As a result of the execution of the restart procedure, the switched virtual circuits will be cleared and will return to the null state.

10.6.4.1 Sending a RESTART message

A RESTART message is sent by a network across the NNI in order to return the whole interface to the null or idle state. Upon transmitting the RESTART message the sender enters the restart request state, starts timer T316 and waits for the a RESTART ACKNOWLEDGE message. Also, no further RESTART messages shall be sent until a RESTART ACKNOWLEDGE message is received or timer T316 expires. Receipt of a RESTART ACKNOWLEDGE message stops timer T316, frees the DLCI and call reference values for reuse.

If a RESTART ACKNOWLEDGE message is not received prior to the expiry of timer T316, one or more subsequent RESTART messages may be sent until a RESTART ACKNOWLEDGE message is returned. Meanwhile, no calls shall be placed or accepted over the interface. The number of unsuccessful restart attempts is limited to a default value of two.

When this limit is reached, the STE originating the restart attempt shall record an error, initiate a notification to the management system and consider that the interface is available for new calls. The RESTART and RESTART ACKNOWLEDGE messages shall contain the global call reference value. The call reference flag of the global call reference applies to restart procedures. In the case where both STEs initiate restart requests simultaneously, they shall be handled independently. The interface shall not be considered for reuse until all relevant restart procedures are completed.

10.6.4.2 Receipt of a RESTART message

Upon receiving a RESTART message, the recipient shall enter the restart state associated to the global call reference and start timer T317; it shall then initiate the appropriate internal actions to clear all calls on the interface and to return the interface to the idle state. Upon completion of internal clearing, timer T317 shall be stopped and a RESTART ACKNOWLEDGE message transmitted to the originator, and the null state entered. If timer T317 expires prior to completion of internal clearing, an indication shall be sent to the maintenance entity.

Even if all call references are in the null state and all data link connections are in the idle condition, the receiving entity shall transmit a RESTART ACKNOWLEDGE message to the originator upon receiving a RESTART message.

10.6.5 Status enquiry and status procedures

10.6.5.1 Status enquiry procedure

Whenever a network wishes to check the correctness of a call state at the other network, a STATUS ENQUIRY message may be sent. Upon sending the STATUS ENQUIRY message, timer T322 shall be started in anticipation of receiving a STATUS message. While timer T322 is running, only one outstanding request for call state information shall exist per call reference. If switched virtual circuit clearing is received while timer T322 is running, it shall be stopped and clearing shall continue.

Upon receipt of a STATUS ENQUIRY message, the receiver shall respond with a STATUS message, reporting the current call state and cause No. 30 *Response to STATUS ENQUIRY*. Sending or receiving a STATUS message does not result in a state change.

The side having received the STATUS message shall inspect the cause information element. If it is not cause No. 30 *Response to STATUS ENQUIRY*, timer T322 shall continue to time for an explicit response to the STATUS ENQUIRY message. If a STATUS message is received with the cause No. 30, timer T322 shall be stopped and the appropriate action taken based on the information in that STATUS message about the call state of the sender and the current call state of the receiver.

If timer T322 expires and a STATUS was received with another cause value other than No. 30, appropriate actions based on the cause received and the call state of the sender shall be taken.

If timer T322 expires and no STATUS was received, the STATUS ENQUIRY message may be retransmitted one or more times until a response is received. The number of times a STATUS ENQUIRY is retransmitted is an implementation dependent value.

The switched virtual circuit shall be cleared with cause No. 41 *Temporary failure*, if the STATUS ENQUIRY message is retransmitted the maximum number of times without receiving a STATUS reply.

10.6.5.2 Receiving a STATUS message

On receipt of a STATUS message reporting an incompatible state, the receiving entity shall:

- clear the call by sending the appropriate clearing message with cause No. 101 *Message not compatible with call state*; or
- take other actions which attempt to recover from a mismatch and which are an implementation option.

Except for the following rules, the determination of which states are incompatible is left as an implementation decision:

- If the receiver is in the null state and the STATUS message indicates the null state, then no action shall be taken by the receiver other than discarding the message and staying in the null state.
- If the receiver is in any state except the null state and the STATUS message indicates the null state, then the receiver shall release all resources, the DLCI and the call reference and move to the null state.
- If the receiver is in the release request state (NN11) and the STATUS message indicates any state except the null state, then no action shall be taken.
- If the receiver is in the null state and the STATUS message indicates any state except the null state, the receiver shall send a RELEASE COMPLETE message with cause No. 101 *Message not compatible with call state*, and remain in the null state.

If a STATUS message is received in a compatible state but contains one of the following causes:

- No. 96 *Mandatory information element is missing*;
- No. 97 *Message type non-existent or not implemented*;
- No. 99 *Information element/parameter non-existent or not implemented*;
- No. 100 *Invalid information element contents*,

the actions to be taken are an implementation option. If no other procedure is defined, the receiver shall clear the call with the appropriate procedure defined in 10.6.3 using the cause value specified in the received STATUS message.

10.6.5.3 Receipt of the STATUS message with the global call reference

On receipt of a STATUS message specifying the global call reference and reporting an incompatible state in the restart request or restart state, the receiving entity shall inform layer management and take no further action on this message. When in the null (Rest0) state, on receipt of a STATUS message with the global call reference, no action shall be taken.

NOTE – Further actions as a result of higher layer activity (e.g., system or layer management) are implementation dependent (including the retransmission of RESTART). Except for the above case, the error handling procedures when receiving a STATUS message specifying the global call reference are an implementation option.

10.6.6 Handling of error conditions

Detailed error handling procedures are implementation dependent. This clause provides general rules facilitating the orderly treatment of error conditions required by each implementation to support. These general rules do not take precedence over applicable procedures as specified in other clauses of this Recommendation. The order of precedence of these rules is defined by the order of description in this clause.

10.6.6.1 Protocol discriminator error

When a message is received with a protocol discriminator coded other than *Q.931 user-network call control message "00001000"*, the message shall be ignored (discarded) and no further action will be taken.

10.6.6.2 Message too short

When a message is received that is too short to contain a complete message type information element, that message shall be ignored.

10.6.6.3 Invalid call reference format

- a) If the call reference information element octet 1, bits 5-8 do not equal 0000, then the message shall be ignored.
- b) If the call reference information element octet 1, bits 1-4 indicate a length greater than the maximum length supported by the receiving equipment, then the message shall be ignored.
- c) When a message is received with a dummy call reference, it shall be ignored.

10.6.6.4 Call reference procedural errors

- a) Whenever a message (CALL PROCEEDING, CONNECT or RELEASE) except SETUP, RELEASE COMPLETE, STATUS OR STATUS ENQUIRY is received specifying a call reference which it does not recognize as related to an active call or a call in progress, normal call clearing is initiated by sending a RELEASE COMPLETE message with cause No. 81 *Invalid call reference value* and remains in the null state (NN0).
- b) When a RELEASE COMPLETE is received that specifies a call reference which it does not recognize as related to an active call or a call in progress, no action should be taken.
- c) When a SETUP message is received that specifies a call reference which is recognized as related to an active call or a call in progress or with a call reference flag incorrectly set to 1, that message shall be ignored.
- d) When any message except RESTART, RESTART ACKNOWLEDGE or STATUS is received using the global call reference, no action should be taken on this message and a STATUS message using the global call reference with cause No. 81 *Invalid call reference value* and a call state indicating Rest0 shall be returned.
- e) When a STATUS message is received that specifies a call reference which is not recognized as relating to an active call or a call in progress, the procedures of 10.6.5.2 shall apply.
- f) When a STATUS ENQUIRY message is received that specifies a call reference which is not recognized as related to an active call or a call in progress, the procedures of 10.6.5.1 shall apply.

10.6.6.5 Message type or message sequence errors

- Whenever an unexpected RELEASE COMPLETE message is received, the receiving STE shall stop all timers, release the DLCI and the call reference and return to the null state (NN0).
- Whenever an unexpected message, except RELEASE, RELEASE COMPLETE, or an unrecognized message (including ALERTING and PROGRESS messages) is received in any state other than the null state, a STATUS message shall be returned with cause No. 98 *Message not compatible with call state or message type non-existent or not implemented* and the corresponding diagnostic.

Instead of cause No. 98, the following cause values may be returned depending on the message received (unrecognized/not implemented or unexpected in the current state):

- a) cause No. 97 *Message type non-existent or not implemented*; or
- b) cause No. 101 *Message not compatible with call state*.

Alternatively instead of sending a STATUS message, a STATUS ENQUIRY message may be sent requesting the call state of the sender. This alternative is not applicable to messages using the global call reference.

No state change shall be made after sending either the STATUS or STATUS ENQUIRY message.

10.6.6.6 Information element out of sequence

A variable length information element, which has a code value lower than the code value of the variable length information element preceding it, shall be considered as out of sequence information element.

If the network or the user receives a message containing an out of sequence information element, it may ignore this information element and continue to process the message. If the network or user chooses to ignore this out of sequence information element and the information element is mandatory, then the error handling procedure for missing mandatory information elements as described below shall apply. If the out of sequence information element is non-mandatory, the receiver continues to process the message.

NOTE – Some implementations may choose to process all the information elements received in a message regardless of the order in which they are placed.

10.6.6.7 Duplicated information elements

- If an information element is repeated in a message in which repetition of the information element is not permitted, only the contents of the first instance of the information element shall be considered and all subsequent instances shall be ignored.
- When repetition of an information element is permitted and if the limit of repetition of the information element is exceeded, the contents of the instances of the information element appearing up to the limit of repetition shall be handled and all subsequent repetitions of the information element shall be ignored.

10.6.6.8 Mandatory information element missing

- When a RELEASE COMPLETE message is received with the cause information element missing, it will be assumed that cause No. 31 *Normal, unspecified* was received.
- When a RELEASE message is received with the cause information element missing, it will be assumed that cause No. 31 *Normal, unspecified* was received. However the reply, RELEASE COMPLETE, shall be sent to the other side of the NNI with the cause value No. 96, *Mandatory information element is missing*.
- When a SETUP or RELEASE message is received which has one or more mandatory information elements missing, the receiving STE shall clear the SVC by following the clearing procedures as described in 10.6.3.1 with cause No. 96 *Mandatory information element is missing* shall be returned.
- When a message other than SETUP, RELEASE or RELEASE COMPLETE is received which has one or more mandatory information elements missing, no action should be taken on the message and no state change should occur. A STATUS message shall be returned with cause No. 96 *Mandatory information element is missing*.

10.6.6.9 Mandatory information element content error

- An implementation should consider as invalid an information element with a length exceeding the maximum length defined in 10.5.
- When a RELEASE COMPLETE message is received with an invalid content of the cause information element, it will be assumed that cause No. 31 *Normal, unspecified* was received.
- When a RELEASE message is received with an invalid content of the cause information element, it will be assumed that cause No. 31 *Normal, unspecified* was received. However the reply, RELEASE COMPLETE, shall be sent to the other side of the NNI with the cause value No. 100 *Invalid information element contents*.
- When a SETUP message is received which has one or more mandatory information element with an invalid content, the receiving entity shall clear the SVC by following the clearing procedures as described in 10.6.3.1 with cause value No. 100 *Invalid information element contents* shall be returned.
- When a message other than SETUP, RELEASE or RELEASE COMPLETE is received which has one or more mandatory information elements with an invalid content, no action should be taken on the message and no state change should occur. A STATUS message with cause No. 100 *Invalid information element contents* shall be returned.

10.6.6.10 Unrecognized information element

- When a RELEASE COMPLETE message is received which has one or more unrecognized information elements, no action shall be taken on the unrecognized information elements.
- When a RELEASE message is received which has one or more unrecognized information element, a RELEASE COMPLETE message is returned with cause No. 99 *Information element/parameter non-existent or not implemented*, the diagnostic field, if present, shall contain the information element identifier for each information element which was unrecognized.
- When a message is received which has one or more unrecognized information elements, the receiving entity shall check whether any are encoded to indicate "comprehension required" (refer to 10.5 for information element identifiers reserved with this meaning). If any unrecognized information element is encoded to indicate "comprehension required", then the procedures in 10.6.6 for mandatory information element missing, are followed, i.e., as if a "missing mandatory information element" error condition had occurred. If all unrecognized information elements are not encoded to indicate "comprehension required", then the receiving entity shall proceed as follows:
 - When a message is received which has one or more unrecognized information elements action shall be taken on the message and those information elements which have a valid content. When the received message is other than a RELEASE or RELEASE COMPLETE message, a STATUS message may be returned indicating the call state of the sender before taking action on the valid information elements of the message. The cause information element shall contain cause No. 99 *Information element/parameter non-existent or not implemented*, and the diagnostic field, if present, shall contain the information element identifier for each information element which was unrecognized. Subsequent actions are determined by the sender of the faulty message.

NOTE – The diagnostic of cause No. 99 facilitates the decision in selecting an appropriate recovery procedure at the reception of a STATUS message. Therefore, it is recommended to provide cause No. 99 with diagnostic information.

10.6.6.11 Non-mandatory information element content error

When a message is received which has one or more non-mandatory information elements with invalid content, action shall be taken on the message and those information elements which have a valid content. An implementation may either discard or truncate an information element with a length exceeding the maximum length defined in 10.5. A STATUS message may be returned indicating the call state of the sender before taking action on the valid information elements of the message. The cause information element shall contain cause No. 100 *Invalid information element contents* which shall be returned and the diagnostic field, if present, shall contain the information element identifier for each information element which has content error. Subsequent actions are determined by the sender of the faulty message.

10.6.6.12 Unexpected recognized information element

When a message is received with a recognized information element not defined to be contained in that message, the receiving entity shall treat the information element as an unrecognized information element and follow the procedures for handling non-mandatory unrecognized information elements.

10.6.6.13 Data link reset

Whenever a signalling entity is informed of a data link reset, no special actions shall be taken, the appropriate procedures (normal procedures or error handling procedures) described above shall be performed.

10.6.6.14 Data link failure

Data link failure resulting in disconnect and re-establishment shall result in a restart procedure between the STEs and any SVCs shall be cleared.

10.6.7 DLCI management

10.6.7.1 DLCI allocation between SVCs and PVCs

The range of usable DLCIs is partitioned into two subranges: one for PVC and the other for SVC. By bilateral agreement between networks, it shall be determined which range of DLCIs will be allocated to PVCs. The remaining DLCIs are available for SVC.

10.6.7.2 DLCI collision at the NNI

By bilateral agreement one network will select DLCI starting from the highest end of unused DLCI value and the other from the lowest end. When both networks select the same DLCI value, a DLCI collision occurs. To resolve a DLCI collision both, networks will clear the call using cause No. 44 *Requested circuit/channel not available*.

10.6.8 List of timers at the NNI

The following mandatory timers are used at the FR NNI: T303, T308, T310, T316, T317 and T322. See Table 27.

Table 27/X.76 – Timers

Timer No.	Default value	Cause for start	Normal stop	1st expiry	2nd expiry
T303	4 s	SETUP sent	CALL PROCEEDING, CONNECT or clearing message received	Retransmit SETUP. Restart T303 unless a clearing message was received.	Not restarted. Clear call
T308	4 s	RELEASE sent	Clearing message received	Retransmit RELEASE. Restart T308.	Not restarted. Release call reference
T310	30-40 s	CALL PROCEEDING received	CONNECT or clearing message received	Clear call	Not restarted
T316	120 s	RESTART sent	RESTART ACK received	RESTART may be transmitted several times	
T317	Implementation dependent, advised to be less than T316	RESTART received	Internal clearing of call references	Maintenance notification. Timer is not restarted.	
T322	4 s	STATUS ENQUIRY sent	STATUS or a clearing message received	STATUS ENQUIRY retransmitted	May be transmitted several times

10.6.9 Frame relay NNI facilities

Categorization of the support for frame relay NNI facilities is as follows:

- Transit network identification (mandatory for originating, terminating and transit networks);
- Call identification (mandatory);
- Closed user group interlock code (mandatory);
- Reverse charging indication (optional);
- Clearing network identification (mandatory);
- Transit network selection (optional);
- Frame transfer priority (optional);
- Frame discard priority (optional);
- Frame relay service class (optional);
- Generic application transport (optional).

10.6.9.1 Transit network identification

Transit network identification is used to identify a transit network traversed by a frame relay SVC. It is used to record the path taken by the SVC for inter-network accounting, operations and routing control purposes. It is mandatory for all networks to support this facility. Only networks operating as transit networks are required to add their transit network identification in a SETUP message. Networks may record and check the transit network identification codes present in any message.

The transit network identification is a unique network identification code allocated to the network (see Appendix I). Networks may choose to request the allocation of a network identification which is either an X.121 DNIC, or is derived from an E.164 country code (see Appendix II). The same network identification code applies to clearing network identification (see 10.6.9.5).

Transit network identification information in the CONNECT message is used to record the inter-network path taken by each call for inter-network accounting, routing and fault diagnosis purposes. Transit network identification information in either or both SETUP and CONNECT messages is used to prevent inter-network routing loops and to check that such routing loops are not created.

Each transit network shall include its transit network identification information element in the SETUP message. When the SVC being established traverses multiple transit networks, there will be multiple transit network identification information elements in the SETUP message. The order of inclusion of transit network identification information elements in the SETUP message corresponds to the order of traversal of transit networks by the SVC being established in the forward direction.

A transit network identification information element is present for each transit network in the CONNECT message returned in the backward direction. It is mandatory for the terminating network to ensure that all transit network identification elements received in the SETUP message are included in the responding CONNECT message. The order of transit network identification information elements in the CONNECT message is the same as the order of traversal of transit networks by the SVC being established in the forward direction.

Transit networks shall pass transit network identification information elements in the CONNECT message unchanged and in the same order in which they were received. Transit networks may check and record the transit network identification information elements. If a transit network checks the transit network information elements in the CONNECT message and determines that its own transit network identification information element is not present, the call shall be cleared with cause No. 96 *Mandatory information element is missing*. The diagnostic shall include the transit network identification information element identifier.

The originating network shall accept and may check and record the received transit network identification elements in the CONNECT message.

Transit network identification information elements may also be present in the first clearing message (RELEASE or RELEASE COMPLETE) only if the RELEASE or RELEASE COMPLETE message is in direct response to a SETUP message. If present, the order of transit network identification information elements is the same as the order of transit networks up to the point at which the first clearing message was sent.

The presence of a duplicate transit network identification information element parameter in any message may be treated as an error and in this case the call shall be cleared with cause No. 100. The diagnostic will contain the duplicate transit network identification information element.

The maximum number of transit networks involved in a call is limited to six. As a result all networks will treat the presence of more than six transit network identification information elements as an error. If the maximum number of network identification information elements is reached, the transit network not able to add its transit network identification will clear the call in the backward direction with cause No. 3 *No route to destination* and diagnostic containing the transit network identification information element code. If the maximum number of transit network identification information elements exceeds 6 in any message, the call shall be cleared with cause No. 104 *Excess repetitions of information element* and diagnostic containing the transit network identification information element identifier.

10.6.9.2 Call identification

Call identification provides a method to uniquely identify each inter-network call. All networks involved in a call may record the call identification information element in the SETUP message so that it can be used for inter-network accounting and problem investigation/operations purposes.

Call identification is an information element which is always present in the SETUP message. The call identification information element is passed unchanged from the originating network to the terminating network. The call identification value is established by each originating network and is used as a unique identifying information for each inter-network call. The call identification parameter shall be a unique value for an extended period of time, for instance, corresponding to the accounting period of the network.

The coding of the call identification is a fixed length octets of binary coded data. The contents of the call identification information element are determined by the originating network and are not specified in this Recommendation.

10.6.9.3 Closed user group interlock code

The closed user group interlock code is a facility used for enabling the establishment of virtual calls by DTEs which are members of inter-network closed user groups.

When the closed user group interlock code information element is present in the SETUP message, it indicates that the inter-network call is requested on the basis of a valid inter-network closed user group membership. The network of the calling DTE supplies the relevant inter-network closed user group interlock code in the SETUP message. It may also signal an associated outgoing access capability.

The closed user group interlock code information element is passed unchanged by any transit network to the terminating network in the SETUP message. The terminating network is responsible for determining whether the call is presented to the called DTE based on the contents of the closed user group interlock code information element.

Administrative arrangements for closed user group interlock codes are according to ITU-T Rec. X.180.

10.6.9.4 Reverse charging indication

Reverse charging indication is an optional facility used for enabling inter-network calls to be established for which reverse charging applies. Its use between networks is subject to a bilateral agreement between the originating network and the adjacent network, which may be a transit network or the terminating network.

If a network receives a reverse charging indication information element and does not support this service or has no bilateral agreement with the adjacent network sending this information element, it shall clear the call with cause No. 69 *Requested facility not implemented*, and shall not use the error procedures applicable to optional information elements. The diagnostic will indicate the reverse charging information element identifier.

The reverse charging indication information element is only present in the call SETUP message when reverse charging is requested by the calling user to apply to the call.

The reverse charging indication information element is passed unchanged by any transit network to the terminating network in the SETUP message.

10.6.9.5 Clearing network identification

Clearing network identification is a facility used to identify the network responsible for requesting the release of a SVC. The clearing network identification may be recorded by networks and used for inter-network operations and fault management. It is mandatory for all networks to include this information when clearing a call and to accept this information when received from another network. Transit networks shall pass the clearing network identification information element unchanged.

The clearing network identification is a unique identification code allocated to the network (see 10.6.9.1 and Appendix I). Networks may choose to request the allocation of a network identification which is either an X.121 DNIC, or is derived from an E.164 country code (see Appendix II). The same network identification code applies to transit network identification (see 10.6.9.1).

The clearing network identification information element is included in the first clearing message (RELEASE or RELEASE COMPLETE) only when the network initiates the release of a SVC. When the clearing network is a transit network, the clearing network identification information element will be present in the first clearing message sent in each direction.

Clearing network identification is not present when a DTE or private network initiates the clearing of a call.

NOTE – In the case where two or more networks clear a call simultaneously, each clearing network will include its own clearing network identification in the first clearing message. In this case, a received clearing network identification may not have end-to-end significance across all of the networks involved in the call.

10.6.9.6 Transit network selection

Transit network selection is an optional facility used for selection of transit networks according to the request of the calling DTE. The use of transit network selection is subject to bilateral agreements between the networks.

A network receiving a SETUP message containing a transit network selection information element will route the call directly to the network as identified by the transit network selection information element received in the SETUP and will remove this information element before sending the SETUP message to that network. If it is not possible to route directly to the requested network, or if a network does not recognize a specified transit network, the call shall be cleared with cause No. 2 *No route to specified transit network*. The diagnostic shall contain a copy of the contents of the transit network selection information element in question.

A network may screen the transit network selection information element to:

- a) avoid routing loops;
- b) ensure an appropriate inter-network relationship exists between selected network;
- c) ensure compliance with national and local regulations.

If the transit network selection is of an incorrect format or fails to meet criteria a), b) or c), the network shall clear the call with cause No. 91 *Invalid transit network selection*. The diagnostic shall contain a copy of the contents of the transit network selection information element in question.

10.6.9.7 Frame relay priority and service class

10.6.9.7.1 Frame transfer priority

10.6.9.7.1.1 General description

The frame transfer priority is a network facility used by bilateral agreements between networks. The frame transfer priority allows networks the possibility to apply different priorities to virtual circuits. During the data transfer phase, a virtual circuit with a higher frame transfer priority will have, in general, its frames serviced (processed and transmitted) before the frames of virtual circuits assigned

a lower priority resulting in a lower end-to-end delay. Frame transfer priorities are assigned per virtual circuit and possibly for each direction of the data transmission. Frame transfer priority provides frame relay networks with a capability allowing them to support and meet the time-sensitivity requirements of real-time applications.

A frame transfer priority class corresponds to a distinct frame transfer priority supported by the network. The number and characteristics of frame transfer priority classes rely highly on internal network capabilities and as such are not standardized. When interconnecting their networks, service providers will describe their own mapping between frame transfer priority indices and frame transfer priority classes. In addition, to have a uniform service, by bilateral agreements, service providers will agree to support the same number of frame transfer priority classes and agree on the meaning of each class.

A frame transfer priority index is an integer from zero to fifteen used at the frame relay NNI to identify a frame transfer priority class. Zero is the lowest priority index and fifteen the highest. A frame transfer priority index has a local significance, its meaning is established according to the receiving network.

For permanent virtual circuits, frame transfer priority classes are assigned at subscription time. For switched virtual circuits, the assignment of frame transfer priority classes is done using the signalling protocol defined in this subclause.

10.6.9.7.2 Frame discard priority

10.6.9.7.2.1 General description

The frame discard priority is a network facility used by bilateral agreements between networks. The frame discard priority allows networks and DTEs the ability to apply different priorities to virtual circuits. Each frame discard priority can be associated with a different frame loss ratio. When frame relay frames have to be discarded under adverse network conditions, frames belonging to a virtual circuit assigned a lower discard priority will be discarded by the network prior to those belonging to virtual circuits assigned higher frame discard priorities. Frame discard priorities are assigned per virtual circuit at the NNI and may be assigned for each direction of data transmission.

A frame discard priority class corresponds to a distinct frame discard priority supported by the network. The number and characteristics of frame discard priority classes rely highly on internal network capabilities and as such are not standardized. When interconnecting their networks, service providers will describe their own mapping between frame discard priority indices and frame discard priority classes. In addition, to have a uniform service, by bilateral agreements, service providers will agree to support the same number of frame discard priority classes and agree on the meaning of each class.

A frame discard priority index is an integer from zero to seven used at the frame relay NNI to identify a frame discard priority class. Zero is the lowest priority index (first to be discarded, that is highest frame loss ratio) and seven the highest (last to be discarded, that is lowest frame loss ratio). Service providers when interconnecting their networks will agree on the mapping between frame discard priority indices and frame discard priority classes. A frame discard priority index has a local significance, its meaning is established according to the receiving network.

For permanent virtual circuits, frame discard priority classes are assigned at subscription time. For switched virtual circuits, the assignment of frame discard priority classes is done using the signalling protocol defined in this subclause.

10.6.9.7.3 Procedures for priorities

10.6.9.7.3.1 Action by the calling STE applicable to frame transfer and frame discard priorities

Before including frame transfer and frame discard priorities parameters in the priority and service class parameters information element in a setup message, the calling STE shall check whether a bilateral agreement exists at the NNI for the use of priorities. If no bilateral agreement exists, and the calling STE received a request formulated in terms of priorities, the action to be taken by the calling STE, is clearing of the SVC call in the backward direction with cause No. 63 *Service or option not available, unspecified* and diagnostic as the priority and service class parameters information element identifier.

If there is a bilateral agreement authorizing the use of priorities, and the calling STE received a request formulated in terms of priorities, the calling STE will signal priority parameters in the setup message.

If there is a bilateral agreement authorizing only the use of priorities, and the calling STE received a request with no priority indication, the calling STE will signal a setup message with no priority and service class parameters information element.

If there is a bilateral agreement authorizing only the use of service class, and the calling STE received a request formulated in terms of priorities, the calling STE will map the priority parameter values to the equivalent service class and signal the service class parameter in the setup message. If no standardized service class is equivalent to the transfer and/or discard priority request, then the calling STE shall clear the call in the backward direction with cause No. 49 *Quality of Service not available*.

NOTE – The calling STE shall not include both priority and service class parameters in the same priority and service class parameters information element.

If the calling STE receives a request formulated either in terms of a standardized service class, or priorities, and it is not possible for the calling STE to establish the call with the specified values, the calling STE shall clear the call in the backward direction with cause No. 49 *Quality of Service not available*.

After sending a setup message with a priority and service class parameters information element as required, the calling STE shall follow the normal SVC procedures of clause 10.

10.6.9.7.3.2 Action by the called STE applicable to frame transfer and frame discard priorities

If the called STE receives a setup message containing priorities parameters, in addition to the SVC procedures in clause 10, it shall take one of the following actions:

If the called STE recognizes the priority and service class parameters information element, and priority parameters, the called network will establish the call on the basis of the requested priority parameters. If it is not possible to establish the call with the specified values, the called STE shall clear the call in the backward direction with cause No. 49 *Quality of Service not available*.

If the called STE receives a priority and service class information element when no bilateral agreement exists (due to an error of the calling STE), the priority and service class IE will be discarded by the called STE.

10.6.9.7.4 Frame relay service class

10.6.9.7.4.1 General description

Frame relay service class is an optional facility allowing frame relay networks to apply different quality of service classes to frame relay virtual circuits to meet delay and loss requirements for different applications on a consistent basis between different networks. During the data transfer phase, frames will be processed such that the performance characteristics of the subscribed or requested service class will be met.

The use of frame relay service class at the NNI by subscription for PVCs, or by signalling for SVCs, is subject to bilateral agreements between the networks. Bilateral agreements may be made to use either or both service class and priorities. For switched virtual circuits, the service class is requested by the calling STE by signalling at the time of call establishment.

In the case of frame relay SVC, a service class number will be signalled by the originating network's calling STE in the Setup message. The service class number will be as signalled by the calling DTE in a service class parameter in the setup message at the UNI, or is mapped from priority parameter(s) in the setup message at the UNI. Subsequent transit networks will signal the same service class parameter value to the called network.

Networks not offering any defined frame relay service classes will treat the priority and service class parameters information element as an optional information element and discard it. Such networks effectively support either service class 0 or service class 1, or both.

Defined service classes are specified in Table 28. Each service class has associated maximum end-to-end delay and loss values as appropriate for the requirements of applications for each class. Service classes and their defined delay and loss parameter values are as specified in ITU-T Rec. X.146.

Table 28/X.76 – Frame relay service classes

Service class number	Support requirement	Description
0	Mandatory	Moderate frame loss and unspecified delay requirements
1	Mandatory (Default class)	Default service class. All frame relay networks offering service classes will provide this service class and the signalling of this service class for SVCs if supported. Moderate frame loss and moderate delay requirements
2	Optional	Stringent frame loss and moderate delay requirements
3	Optional	Stringent frame loss and stringent delay requirements
NOTE – Information on the optional service classes supported by each network is to be exchanged as part of bilateral inter-network connection arrangements.		

10.6.9.7.4.2 Action by the calling STE

Before including a service class parameter in the priority and service class parameters information element in the setup message, the calling STE shall check whether a bilateral agreement exists at the NNI for the use of service class. If no bilateral agreement exists, and the calling STE received a request formulated in terms of a service class, the action to be taken by the calling STE, is clearing of the SVC call in the backward direction with cause No. 63 *Service or option not available; unspecified*.

If there is a bilateral agreement authorizing the use of service class, and the calling STE received a request with no priority or service class parameter, the network's default service class (service class 1) will be signalled by the calling STE in the setup message.

If there is a bilateral agreement authorizing the use of service class, and the calling STE received a request formulated in terms of a service class, the calling STE will signal a service class parameter in the setup message with the same service class value.

NOTE – The calling STE shall not include both service class and priority parameters in the same service class and priority parameters information element.

If the calling STE receives a request formulated either in terms of a standardized service class, or priorities, and it is not possible for the calling STE to establish the call with the specified values, the calling STE shall clear the call in the backward direction with cause No. 49 *Quality of Service not available*.

After sending a setup message with a service class and priority parameters information element as required, the calling STE shall follow the normal SVC procedures of clause 10.

10.6.9.7.4.3 Action by the called STE

If the called STE receives a setup message containing a service class parameter, in addition to the SVC procedures in clause 10, it shall take one of the following actions:

If the called STE recognizes the priority and service class parameters information element, and service class parameter, the called network will establish the call on the basis of the requested service class. If it is not possible to establish the call with the specified values, the called STE shall clear the call in the backward direction with cause No. 49 *Quality of Service not available*.

If the called STE receives a priority and service class parameters information element when no bilateral agreement exists (due to an error of the calling STE), the priority and service class parameters IE will be discarded by the called STE.

10.6.9.7.4.4 Interaction between service class and priorities

If there is a bilateral agreement authorizing only the use of service class, and the calling STE received a request formulated in terms of priorities, the calling STE will map the priority parameter values to the equivalent service class and signal the service class parameter in the setup message. If no standardized service class is equivalent to the transfer and/or discard priority request, then the calling STE shall clear the call in the backward direction with cause No. 49 *Quality of Service not available*.

If there is a bilateral agreement authorizing only the use of priorities, and the calling STE received a request formulated in terms of service classes, the calling STE will map the service class to equivalent priority parameters and signal the priority parameters in the setup message. If no priority parameters are equivalent to the requested service class, then the calling STE shall clear the call in the backward direction with cause No. 49 *Quality of Service not available*.

10.6.9.8 Generic application transport

Refer to Frame Relay Forum Implementation Agreement FRF.10.1 Annex A.

11 Additional procedures for PVCs using unnumbered information frames

11.1 Overview

These procedures described in 11.2 to 11.7 provide the following functionality:

- link integrity verification;
- notification of the addition of a PVC;

- detection of the deletion of a PVC;
- notification of the status of a PVC (active or inactive).

These procedures are based on the periodic exchange of STATUS ENQUIRY and STATUS messages over the network-to-network interface.

In addition to the capabilities defined in this clause, Annex C defines optional PVC signalling enhancements procedures to increase the number of PVCs status reports. The enhanced procedures add a new report type in order to segment the STATUS message when the number of PVC status reporting cannot fit into one STATUS message.

11.2 Message definition

Messages are transferred on DLCI = 0 with bits C/R, DE, BECN and FECN set to 0 upon transmission. Bits C/R, DE, BECN and FECN are not interpreted upon reception.

The 3 octets following the address field have fixed values:

- the first octet is the control field of a UI frame with the poll bit set to 0;
- the 2nd octet is the protocol discriminator information element of the message;
- the 3rd octet is the dummy call reference information element of the message.

Consequently, the first octets of the frame are as described in Figure 38.

The other information elements are described in 11.2.1 and 11.2.2 below.

	8	7	6	5	4	3	2	1	Octet
	Flag								1
Address field	0	0	0	0	0	0	0	0	2
DLCI = 0	0	0	0	0	0	0	0	1	3
UI, poll bit = 0	0	0	0	0	0	0	1	1	4
Protocol discriminator	0	0	0	0	1	0	0	0	5
Dummy call reference	0	0	0	0	0	0	0	0	6
See 11.2.1 and 11.2.2	Message specific information elements								
	FCS								
	FCS								
	Flag								

Figure 38/X.76 – PVC management frame format (for 2-octet address)

11.2.1 STATUS ENQUIRY message

This message is sent to request the status of PVCs or to verify link integrity. Message specific information elements for this message are described in Table 29, and must appear in the order indicated in this table.

Table 29/X.76 – Message specific information elements in STATUS ENQUIRY message

Message type: STATUS ENQUIRY Significance: Local		
Information element	Type	Length
Message type	Mandatory	1
Report type	Mandatory	3
Link integrity verification	Mandatory	4

11.2.2 STATUS message

This message is sent in response to a STATUS ENQUIRY message to indicate the status of permanent virtual circuits or for a link integrity verification. Optionally, it may be sent at any time to indicate the status of a single PVC. Message specific information elements for this message are described in Table 30, and are in the order indicated in this table. The PVC status information element may be repeated in this message.

Table 30/X.76 – Message specific information elements in STATUS message

Message type: STATUS Significance: Local		
Information element	Type	Length
Message type	Mandatory	1
Report type	Mandatory	3
Link integrity verification	Optional/Mandatory (Note 1)	4
PVC status (Note 2)	Optional/Mandatory (Note 3)	5-7
NOTE 1 – Mandatory if the type of report is "full status" or "link integrity verification only". Not included in the optional asynchronous status message (report type equal to "single asynchronous PVC status").		
NOTE 2 – Included in the case of a full status message. This is a STATUS message that contains the status of all PVCs on the interface. There is one PVC status information element for each PVC configured. The PVC status information elements are arranged in the messages in ascending order of DLCIs; the PVC with the lowest DLCI is first, the second lowest DLCI is second, and so on. The maximum number of PVCs that can be indicated in a message is limited by the maximum frame size. The optional asynchronous STATUS message contains a single PVC status information element.		
NOTE 3 – Mandatory if the report type information element indicated "full status" or "single asynchronous PVC status" and there are PVCs configured.		

11.3 Message specific information elements

11.3.1 Message type

The coding of message type is defined in Table 31.

Table 31/X.76 – Message type coding

<i>Message type coding for PVC management</i>									
Bits									
8	7	6	5	4	3	2	1		
0	1	1	-	-	-	-	-		
		1	0	1	0	1	STATUS ENQUIRY		
		1	1	1	0	1	STATUS		

11.3.2 Report type

The purpose of the report type information element is to indicate the type of enquiry requested when included in a STATUS ENQUIRY message or the contents of the STATUS message. The length of this information element is 3 octets. The format and encoding of the report type information element is defined in Figure 39.

8	7	6	5	4	3	2	1	Octet
Length of report type contents = 1								1
0	1	0	1	0	0	0	1	2
Type of report								3

Type of report (octet 3)

Bits

8 7 6 5 4 3 2 1

0 0 0 0 0 0 0 0

Full status (status of all PVCs at the interface)

0 0 0 0 0 0 0 1

Link integrity verification only

0 0 0 0 0 0 1 0

Single PVC asynchronous status

All other values are reserved.

Figure 39/X.76 – Report type information element

11.3.3 Link integrity verification

The purpose of the link integrity verification information element is to exchange sequence numbers across the network-to-network interface on a periodic basis. The length of this information element is 4 octets. It is binary encoded.

The format of the link integrity verification information element is defined in the Figure 40, where send sequence number in octet 3 indicates the current send sequence number of the originator of the message, and receive sequence number in octet 4 indicates the send sequence number received in the last received message. The send sequence number is binary encoded in octet 3. The receive sequence number is binary encoded in octet 4.

8	7	6	5	4	3	2	1	Octet
Length of link integrity verification contents = 2								1
0	1	0	1	0	0	1	1	2
Send sequence number								3
Receive sequence number								4

Figure 40/X.76 – Link integrity verification information element

11.3.4 PVC status

The purpose of the PVC status information element is to indicate the status of existing PVCs at the interface. The information element can be repeated, as necessary, in a message to indicate the status of all PVCs on the network-to-network interface. The length of this information element depends on the length of the DLCIs being used on the network-to-network interface. The length of this information element is 5 octets when a default address format (2 octet) is used. The format of the PVC status information element is defined in Figure 41, where a default address format is used. Bit 6 of octet 3 is the most significant bit in the data link connection identifier.

The format of the PVC status information element is defined in Figure 41b, where a 4-octet address format is used.

Bit 2 of the last octet for each PVC status information element is the active bit which is coded 1 to indicate the PVC is active, and coded 0 to indicate the PVC is inactive. An active indication means that the PVC is available to be used for data transfer. An inactive indication means that the PVC is configured but is not available for data transfer.

Bit 4 of the last octet for each PVC status information element is the new bit which is coded 1 to indicate the PVC is newly configured, and coded 0 to indicate the PVC is already configured.

Bit 3 of the last octet for each PVC status information element is the delete bit which is coded 1 to indicate the PVC is deleted, and coded 0 to indicate the PVC is configured.

The PVC status information elements are arranged in the messages in ascending order of DLCIs; the PVC with the lowest DLCI is first, the second lowest DLCI is second, and so on. The maximum number of PVCs that can be indicated in a message is limited by the frame size.

The delete bit is only applicable for timely notification using the optional single PVC asynchronous status report. When the delete bit is set to 1, the new and active bits have no significance and shall be set to 0 upon transmission and not interpreted upon reception. When the new or active bits have significance, the delete bit shall be set to 0 upon transmission and not interpreted upon reception.

8	7	6	5	4	3	2	1	Octet
0	1	0	1	0	1	1	1	1
Length of PVC status contents = 3								2
ext. 0	Spare 0	Data link connection identifier (Most significant 6 bits)						3
ext. 1	Data link connection identifier (2nd most significant 4 bits)				Spare 0 0 0			3a
ext. 1	Spare 0 0 0			New	Delete	Active	Reserved 0	4

Figure 41a/X.76 – PVC status information element with 2-octet address format

8	7	6	5	4	3	2	1	Octet
0	1	0	1	0	1	1	1	1
Length of PVC status contents = 5								2
ext. 0	Spare 0	Data link connection identifier (Most significant 6 bits)						3
ext. 0	Data link connection identifier (2nd most significant 4 bits)				Spare 0 0 0			3a
ext. 0	Data link connection identifier (3rd most significant 7 bits)							3b
ext. 1	Data link connection identifier (4th most significant 6 bits)						Spare 0	3c
ext. 1	Spare 0 0 0			New	Delete	Active	Reserved 0	4

Figure 41b/X.76 – PVC status information element with 4-octet address format

11.4 Description of procedures

These procedures use periodic polling, as described in 11.4.1 to verify the integrity of the link (see 11.4.2) and to report the status of PVCs (see 11.4.3, 11.4.4 and 11.4.5).

Bidirectional signalling procedures are employed at the network-to-network interface. Each Signalling Terminal (STE) on either side of the network-to-network interface employs procedures for both polling initiation and polling response (see Figure 42).

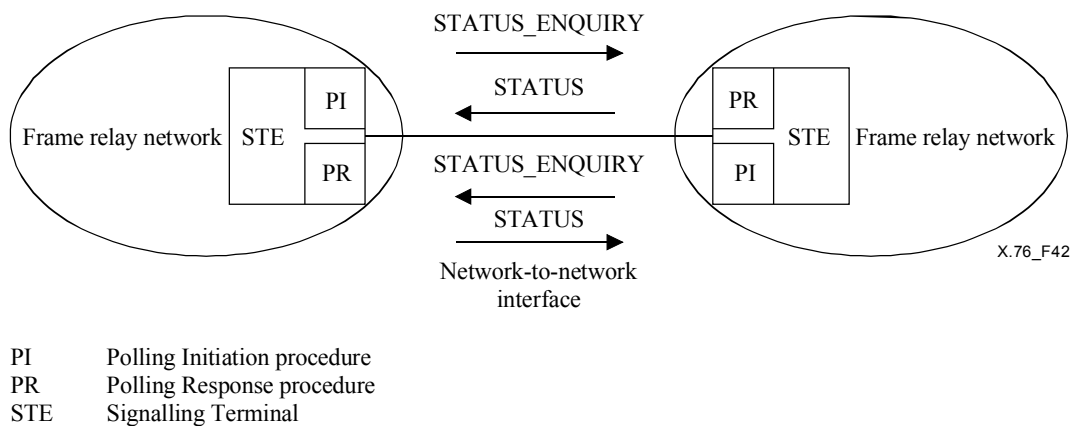

Figure 42/X.76 – Bidirectional signalling procedures

11.4.1 Periodic polling

Polling is initiated as described below:

- 1) A STATUS ENQUIRY message is sent and the polling timer T391 started. When T391 expires, this action is repeated. The T391 interval between such messages is called the polling interval. This STATUS ENQUIRY message typically requests a link integrity verification exchange only (report type equal "0000 0001"). However, every N391 polling cycles, the polling initiation procedures request full status of all PVCs (report type equal "0000 0000").
- 2) The polling response procedure responds to each STATUS ENQUIRY message with a STATUS message and (re) starts the polling verification timer T392. If the STATUS ENQUIRY requests full status, the STE must respond with a STATUS message with the type of report specifying full status. The STATUS message sent in response to a STATUS ENQUIRY contains the link integrity verification and report type information elements. If the content of the report type information element specifies full status, then the STATUS message must contain one PVC status information element for each PVC configured on the interface.
- 3) The polling initiation procedure shall interpret the STATUS message based on the type of report contained in this STATUS message. The polling response procedure may respond to any poll with a full status message in case of a PVC status change or to report the addition or deletion of a PVC on the interface. If it is a full status message, the STE should update the status of each configured PVC as reported by the remote STE.

11.4.2 Link integrity verification

The purpose of the link integrity verification information element is to allow the connected STEs to determine the status of the signalling link (DLCI 0). This is necessary since these procedures use Unnumbered Information (UI) frames.

An STE maintains the following internal counters:

- The send sequence counter maintains the value of the send sequence number field of the last link integrity verification information element sent.
- The receive sequence counter maintains the value of the last received send sequence number field in the link integrity verification information element. This represents the value to be placed in the next transmitted received sequence number field.

A separate pair of counters (send sequence counter and receive sequence counter) is kept for the polling initiation procedure and the polling response procedure. These two sets of procedures coexist within a single STE.

The polling initiation procedure consists of those procedures which generate STATUS ENQUIRY messages and process the received, corresponding STATUS messages.

The polling response procedure consists of those procedures which process STATUS ENQUIRY messages and generate the required STATUS messages.

The following procedure is used:

- 1) Before any messages are exchanged, an STE must set both pairs of send sequence counters and receive sequence counters to zero.
- 2) Each time the polling initiation procedure sends a STATUS ENQUIRY message, it increments the send sequence counter and places its value into the send sequence number field of the link integrity verification information element. It also places the current value of the receive sequence counter into the receive sequence number field of the link integrity verification information element. The polling initiation procedure increments the send sequence counter using modulo 256. The value zero is skipped.
- 3) When the STE receives a STATUS ENQUIRY, the polling response procedure of the STE checks the receive sequence number sent by the remote STE against its send sequence counter. The handling of error conditions is described in 11.4.6.

The received send sequence number is stored in the receive sequence counter. The polling response procedure then increments its send sequence counter and places its current value in the send sequence number field and the value of the receive sequence counter (the last received send sequence number) into the receive sequence number field of the outgoing link integrity verification information element. The polling response procedure then transmits the completed STATUS message back to the remote STE which performed the polling initiation. The polling response procedure increments the send sequence counter using modulo 256. The value zero is skipped.

- 4) When the polling initiation procedure receives a STATUS from the remote STE in response to a STATUS ENQUIRY, it checks the receive sequence number received from the remote STE against its send sequence counter. The handling of error conditions is described in 11.4.6. The received send sequence number from the STATUS message is stored in the receive sequence counter.

NOTE – The value zero in the receive sequence number indicates that the field contents are undefined; this value is normally used after initialization. The value zero shall not be sent in the send sequence number field so that the receive sequence number shall never contain the value zero to differentiate the undefined condition from the normal modulo round off.

11.4.3 Signalling of the presence or absence of a PVC

The STE will signal the presence of a PVC by including a PVC STATUS information element with the appropriate DLCI in a STATUS message with full status report. A PVC should be considered as present when it is configured in the network in which the STE is located. Note that this presence indication does not have an end-to-end significance in the case of a multi-network PVC. An STE shall interpret the omission of a previously reported PVC from the full STATUS message as an indication that the PVC is no longer provisioned for the interface in the remote network.

11.4.4 Signalling that a PVC is new

One of the functions of periodic polling is to notify the remote STE of newly added permanent virtual circuits using a full status message. The PVC reporting procedure using a full status message ensures that a permanent virtual circuit cannot be deleted and another added using the same DLCI without the remote STE detecting the change. The PVC reporting procedures are defined as follows:

- 1) When a new permanent virtual circuit has been added, the STE sets the new bit to 1 in the PVC status information element for that PVC in a full STATUS message.

- 2) The STE shall not clear the new bit in the PVC status information element until it receives a STATUS ENQUIRY message containing a receive sequence number equal to the send sequence counter (i.e., the send sequence number transmitted in the last STATUS message).

Note that when the new bit is set to 1, the delete bit must be set to 0 on transmission. On reception, the delete bit is not interpreted when the new bit is set to 1.

For a given PVC, when the new bit is received set to 1 at an STE, this means that the PVC has been newly added or re-configured in the adjacent network or in a subsequent network beyond the adjacent network. This information shall be propagated across the network on which this STE exists to the other end of the PVC segment (i.e., X.76 or X.36 interface).

NOTE – This procedure ensures the DTE does not miss the fact that a transit network deleted a PVC and then quickly used the same DLCI for a new PVC to a new destination.

11.4.5 Signalling the active/inactive status of PVCs

In response to a STATUS ENQUIRY message sent by an STE containing a report type information element set to "full status", the polling response procedures of the remote STE report in a STATUS message the activity status of each PVC configured on the interface with PVC status information elements (one per PVC).

The report type information element in this STATUS message is set to "full status". Also, in response to a STATUS ENQUIRY message containing a report type information element set to "link integrity verification only", the STE may respond with a STATUS message containing a report type information element set to "full status" in case of a PVC status change. Each PVC status information element contains an active bit indicating whether that PVC is active (set to 1) or inactive (set to 0).

The action that an STE takes based on the value of the active bit is independent of the action based on the new bit. An STE could receive a PVC status information element with the new bit set to 1 and the active bit set to 0.

If an STE receives a PVC status information element with the active bit set to 0, the STE shall stop transmitting frames on the PVC until it receives a PVC status information element for that PVC with the active bit set to 1. When the active bit is set to 1, the delete bit must be set to 0 on transmission. The delete bit is not interpreted in the full status reporting STATUS message. When the delete bit is set to 1 in the optional asynchronous status message, the active bit has no significance. Other action taken by the STE is implementation dependent.

Since there is a delay between the time the network makes a PVC active and the time the STE transmits a PVC status information element notifying the remote STE, there is a possibility of an STE receiving frames on a PVC marked as inactive. The action the STE takes on receipt of frames on an inactive PVC is implementation dependent.

Since there is a delay between the time the network detects that a PVC has become inactive and the time the STE transmits a PVC status information element notifying the remote STE, there is a possibility of an STE receiving frames on an inactive PVC. The action an STE takes on receipt of frames for an inactive PVC is network dependent and may include the dropping of frames on the inactive PVC.

An STE indicates that a PVC is active if the following criteria are met:

- The PVC is configured and available for data transfer in the network on which the STE exists.
- There is no service affecting condition at the STE (see 11.4.6) or at the other STE (or DCE) traversed by this PVC on the network on which the STE exists.
- The other STE (or DCE supporting bidirectional procedures) traversed by this PVC on the network on which the STE exists indicates that the PVC is present and active.

Note that the indication sent by an STE is independent of the indication received across the network-to-network interface from the remote STE.

See 11.4.6 for conditions under which the network sets the active bit to zero.

11.4.6 Error conditions

The polling initiation and polling response procedures use the information provided by periodic polling for error monitoring.

The polling initiation and polling response procedures detect the following error conditions:

- *Procedure errors*: Non-receipt of STATUS/STATUS ENQUIRY messages, or invalid receive sequence number in a link integrity verification information element.
- *Protocol errors*: Protocol errors are handled according to 10.6.6.

In the case of protocol errors both the polling initiation and polling response procedures shall ignore such messages: no response shall be made, no error counted and no use shall be made of the content of the link integrity verification information.

11.4.6.1 Polling response procedure actions

Several kinds of errors have to be taken into account by the polling response procedures within an STE:

1) *Errors within the network*

The STE shall set the active bit to 0 for a PVC if a service affecting condition occurs within the network (implementation dependent, e.g., switching node or internal link out of order, etc.).

2) *Errors at the network-to-network interface*

For the purposes of determining a service affecting condition at the network-to-network interface, an event is defined as:

- receipt of a STATUS ENQUIRY message with no protocol errors; or
- expiration of timer T392.

The first type of event is considered as an error if the contents of the link integrity verification information element is invalid. This consists of an invalid receive sequence number. The received receive sequence number is not valid when it is not equal to the last transmitted send sequence number.

NOTE – The polling response procedures continue with the periodic polling procedure regardless of the value of the received receive sequence number (i.e. the polling response procedures respond to every STATUS ENQUIRY message which does not contain a protocol error). However, if the STATUS ENQUIRY contains an invalid receive sequence number, an error is logged.

The second type of event is always considered as an error. Detecting that N392 of the last N393 events is an error indicates a service affecting condition. At the detection of a service affecting condition at the network-to-network interface by the STE, the STE should notify the remote STE for each PVC whose service is affected by setting the active bit to 0 in a full status STATUS message or optionally in the single PVC asynchronous STATUS message.

11.4.6.2 Polling initiation procedure actions

For the purpose of determining a service affecting condition at the network-to-network interface, an event is defined as the transmission of a STATUS ENQUIRY message.

This event is considered as an error in the following cases:

- Non-receipt of a STATUS message with no protocol errors with report type equal to "full status" or "link integrity verification only" before T391 expiry.

- Receipt of a STATUS message with no protocol errors and with report type equal to "full status" or "link integrity verification only", with invalid contents of a link integrity verification information element. This consists of detecting an invalid receive sequence number. The received receive sequence number is not valid when it is not equal to the last transmitted send sequence number.

NOTE – When the polling initiation procedures receive a STATUS message with no protocol errors but with an invalid receive sequence number, this message (including its send sequence number) is ignored. Using the send sequence number of such a STATUS message may cause the polling initiation procedures to acknowledge a STATUS message with report type equal to "full status" that has, in fact, been ignored (this could cause the incorrect acknowledgement of a new and/or delete indication).

Detecting that N392 of the last N393 events is an error indicates a service affecting condition. The STE also may use other methods for detecting service affecting conditions.

At the detection of a service affecting condition at the network-to-network interface, the STE should stop transmission of frames on all PVCs on the network-to-network interface. The STE should continue link integrity verification procedures to detect service restoration.

When the STE detects that the service affecting conditions is cleared, it resumes normal operation of active PVCs on the network-to-network interface. One method to detect service restoration is by detecting that N392 consecutive events have occurred without error.

If a PVC status information element is received for a PVC not currently defined and the new bit is set to 0, this is recorded as an error. Other actions taken are implementation dependent.

This procedure detects problems with the signalling link (DLCI = 0) and does not detect problems with individual PVCs.

11.5 Bidirectional aspects of operation

Bidirectional procedures mean that there is symmetrical operation on the network-to-network interface.

Two sets of signalling parameters are administered for each STE at a given network-to-network interface as shown below:

- polling initiation procedure: T391, N391;
- polling response procedure: T392.

One set of parameters is used when the STE is providing the "polling initiation procedure" which sends the polling message (STATUS ENQUIRY). The other set of parameters is used when the STE is providing the "polling response procedure" which sends a response (STATUS) to each polling message.

The location of these system parameters is indicated in Figure 43 below.

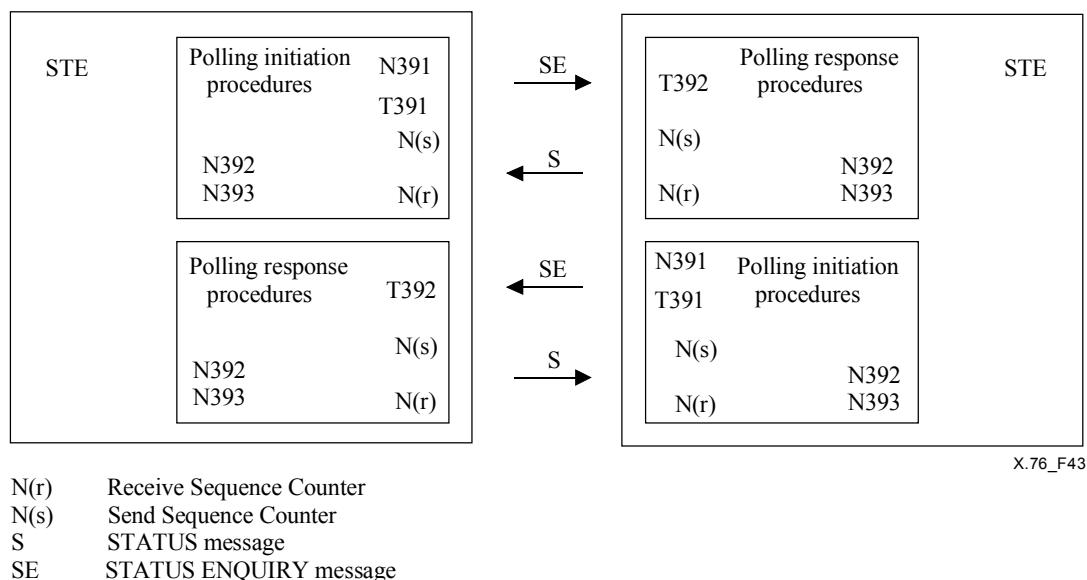

Figure 43/X.76 – Location of system parameters and variables

Each side of the network-to-network interface is required to initiate polling using a STATUS ENQUIRY message based on its own T391 timer. A full status report is required every N391 (default 6) polling cycles. This periodic polling procedure is defined in 11.4.

When it is first activated, the STE shall consider the network-to-network interface to be non-operational. When the STE observes one of the following conditions on the network-to-network interface, it shall consider that network-to-network interface to be operational:

- N393 consecutive valid polling cycles occur. These polling cycles may be counted from: polling initiation cycles, polling response cycles or a combination of both.
- As an alternative, one valid polling cycle occurs. That is, if the first polling cycle constitutes a valid exchange of sequence numbers, then the network-to-network interface shall be considered operational. If the first polling cycle results in an error, then the network-to-network interface shall be considered non-operational until N393 consecutive valid polling cycles occur at the network-to-network interface. These polling cycles may be counted from: polling initiation cycles, polling response cycles or a combination of both.

Later (after it has once been considered operational), the interface is considered non-operational following detection of a service affecting condition at the network-to-network interface, and it is considered operational following detection of service restoration.

An STE implements two sets of parameters N392 and N393 for monitoring errors and events respectively. One set is used by the polling initiation procedures and one set by the polling response procedures. It is recognized that, within an STE, the polling initiation procedures and the polling response procedures may detect different states. The determination of the state of the network-to-network interface from these states is implementation dependent.

11.6 Asynchronous PVC STATUS message

Whenever a PVC status has changed, optionally, a STATUS message with report type set to single PVC asynchronous status is sent to inform the remote STE of the new PVC status. If sent, this message is sent immediately after the occurrence of the PVC status change.

When a PVC is deleted, the STE may send an asynchronous PVC STATUS message to the STE that contains the report type information element set to "single PVC asynchronous status" and the PVC status information element. In the PVC status information element, the delete bit is set to 1. When the delete bit is set to 1, the new bit and the active bit have no significance. They must be set to 0 on transmission and should not be interpreted on reception.

The procedures for the reporting of new PVCs are not supported by asynchronous STATUS messages. In an asynchronous PVC STATUS message, the new bit has no significance. It must be set to 0 on transmission and should not be interpreted on reception. Asynchronous STATUS messages do not satisfy the requirements for a STATUS message in a given polling interval. STEs which are not able to interpret a STATUS message with report type set to single PVC asynchronous status must ignore this message.

11.7 System parameters

Tables 32 and 33 summarize the acceptable values for the configurable parameters described in these procedures. Parameter values other than the default values are a subscription option.

Table 32/X.76 – System parameters – Counters

Counter	Description	Range	Default/threshold	Usage
N391	Full status (status of all PVCs) polling counter	1-255	6	Polling cycles
N392	Error/recovery counter	1-10 (Note 1)	3	Errored events/ Non-errored events
N393	Monitored events counter	1-10 (Note 2)	4	Events

NOTE 1 – N392 should be less than or equal to N393.
NOTE 2 – If N393 is set to a value much less than N391, then the link could go in and out of error condition without the user equipment or network being notified.

Table 33/X.76 – System parameters – Timers

Timer	Description	Range	Default (seconds)	Started	Stopped	Action taken when expired
T391	Link integrity verification polling timer	5-30	10	Transmit STATUS ENQUIRY	–	Transmit STATUS ENQUIRY. Record error if STATUS message not received
T392	Polling verification timer	5-30 (Note)	15	Transmit STATUS	Receive STATUS ENQUIRY	Record error by incrementing N392. Restart T392

NOTE – T392 should be greater than T391.

12 Congestion control

As defined in ITU-T Rec. I.370, congestion states are classified as one of either mild or severe congestion. In times of mild congestion, the network must implement procedures to detect congestion, notify users, and control excess traffic so as to avoid as far as possible the actual discarding of frames. The network can send congestion notifying indications to adjacent networks via frame relay network-to-network interfaces if it has been determined that traffic with these networks is encountering congested resources.

Each network should generate Forward Explicit Congestion Notification (FECN), Backward Explicit Congestion Notification (BECN) and may support rate enforcement using the DE indicator in accordance with ITU-T Rec. I.370.

Each network is responsible for protecting itself against congestion scenarios at the network-to-network interface (e.g., a given network should not rely solely on the prior network's setting of the DE bit).

Under normal operating conditions, every effort should be made not to discard Bc committed data at the NNI. One method of assuring this is to set an upper limit to the sum of the subscribed CIRs (egress from the network) of all PVCs taking into account the NNI access rate. Each STE sets its own upper limit.

The Committed Information Rate (CIR), Committed Burst Size (Bc) and Excess Burst Size (Be) values are administratively coordinated at the network-to-network interface. The values of these parameters are chosen to provide a consistent service along the multi-network PVC. CIR, Bc and Be may be uniquely defined in the forward and backward directions.

The Access Rates (AR) of all NNIs involved in a multi-network PVC do not have to be equal. The access rate at one NNI may be substantially higher than at another NNI. Therefore, continuous input of Be frames at one NNI may lead to persistent congestion of the network buffers at another NNI, and a substantial amount of the input Be data may be discarded.

The generation and signalling of explicit congestion control information is further described in Appendix I.

Annex A

Signalling for switched PVC (SPVC)

This annex describes optional procedures which provide a means of establishing a PVC using PVC segments at the UNIs and SVCs at the NNIs. This mapping is provided by establishment of a switched connection between two endpoints that support PVCs. This connection is referred to as a switched PVC (SPVC). The SPVC appears to the DTE as a PVC, but is connected through multiple networks as a SVC. The SVC is utilized to achieve a high degree of resiliency between networks along with a reduction in provisioning requirements at the NNI.

The endpoints of an SPVC provide the mapping between the PVCs at the network edges and the SVCs that transit the networks. The mechanisms for achieving this mapping are internal to the networks. Each endpoint of the SPVC will service the PVC signalling on its respective UNI and will logically act as a proxy DTE for purposes of the network's signalling. These endpoints, the first network nodes encountered after the UNI, are configured by the network management entity (e.g., loading of parameters such as CIR, Bc, Be, called address). Figure A.1 provides a reference model.

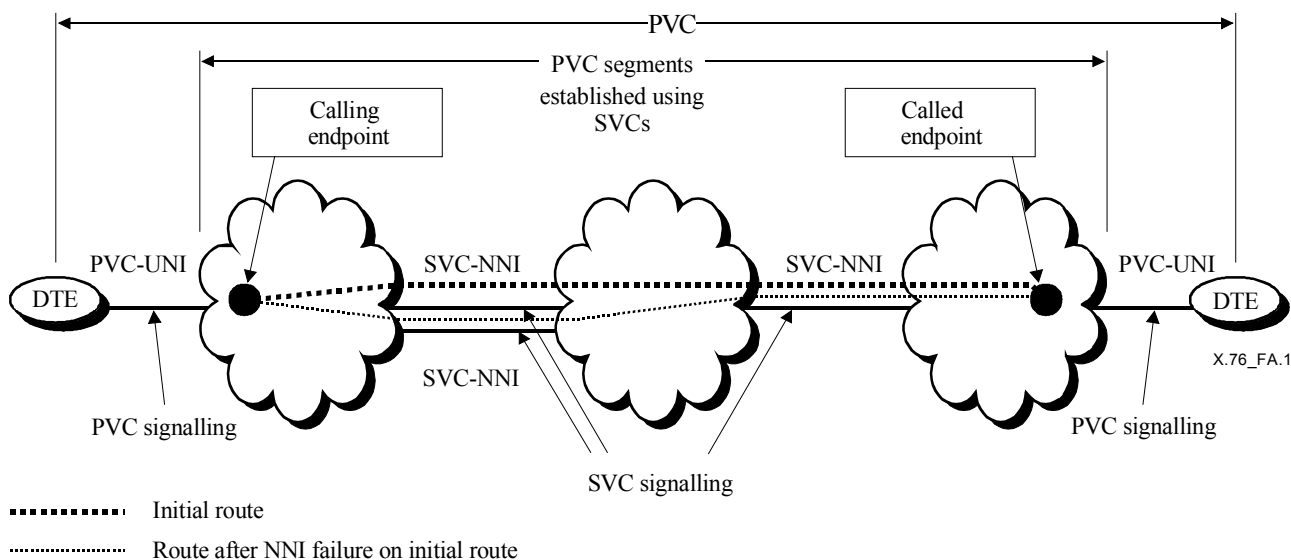

Figure A.1/X.76 – SPVC reference configuration

Endpoints of the SPVC have the ability to set up the SPVC. The endpoint sending the SETUP message is referred to as the calling endpoint. The endpoint that receives a SPVC connection request is referred to as the called endpoint.

The PVC UNIs serviced by the endpoints are identified by unique frame relay addresses (e.g., E.164 and X.121) which are assigned by the network management entity. The address of the origin PVC UNI is encoded in the calling party number information element of the SETUP message that establishes the SPVC. The address of the destination PVC UNI is encoded in the called party number information element of the SETUP message that establishes the SPVC.

The calling endpoint selects the data link connection at the destination PVC UNI with the called party SPVC information element. A data link connection can be selected for:

- a specific DLCI value at the called endpoint's PVC UNI;
- a logical data link connection at the called endpoint's PVC UNI;
- any available DLCI at the called endpoint's PVC UNI.

A logical data link connection is mapped to a specific DLCI by the called endpoint following receipt of a setup request. The logical data link connection is indicated when the called party SPVC IE is encoded using a called endpoint selection type of "specific SPVC correlator". Both endpoints must be provisioned to support the same specific SPVC correlator. Support of the specific SPVC correlator is optional.

NNI facilities applicable to SVCs are also applicable at the NNI when the endpoints are SPVCs. These NNI facilities are: transit network identification, call identification and clearing network identification. Facilities that may be configurable to be used at the SPVC endpoint are: reverse charging and transit network selection. Closed user group indication is not applicable to SPVC endpoints.

The SPVC procedures include:

- SPVC establishment;
- interworking with the X.36 PVC procedures (see Note).

NOTE – These procedures also apply to the PVC procedures of Annex A/Q.933.

A.1 Messages needed for SPVC establishment

The following information elements are used to carry end-to-end information in the SETUP and CONNECT messages: Called party SPVC information element and link layer core parameters. The user-user information is required when supporting the specific SPVC correlator. The SETUP and CONNECT messages used to establish an SPVC shall contain the called party SPVC information element.

A.2 Called party SPVC information element

The purpose of the called party SPVC information element is to identify the DLCI used for a PVC at the destination UNI. The called party SPVC information element specifies either a specific DLCI, a specific SPVC correlator, or any available DLCI at the destination may be used. The length of this information element is variable. See Figure A.2 and Table A.1.

Although the called party SPVC information element is included in the SETUP and CONNECT messages at the NNI during SPVC establishment, this information element is not processed at the NNI. The NNI ensures that the called party SPVC information element is forwarded to the adjacent network where it is processed by the called and calling endpoints.

Figure A.2 | Table A.1/X.76 – Called party SPVC information element

Figure A.2 – Called party SPVC information element structure

8	7	6	5	4	3	2	1	Octet
Called party SPVC information element identifier								1
0	0	0	0	1	0	1	0	
Length of called party SPVC information element contents								2
ext. 1	Spare			New 0 ffs	Called endpoint selection type			3
ext. 0	Spare 0	DLCI (Most significant 6 bits)						4* (Note 2)
ext. 0/1	DLCI (2nd most significant 4 bits)			Spare				4a*
ext. 0	DLCI (3rd most significant 7 bits)							4b*
ext. 1	DLCI (4th most significant 6 bits)						Res. 0	4c*
ATM called endpoint selection type								5* (Note 3)
VPI identifier								6*
1	0	0	0	0	0	0	1	6*
VPI value (coded according to ITU-T Rec. Q.2931 Connection identification information element)								6.1* 6.3*
VCI identifier								7*
1	0	0	0	0	0	1	0	7* (Notes 3 & 4)
VCI value (coded according to ITU-T Rec. Q.2931 Connection identification information element)								7.1* 7.2*

NOTE 1 – This information element is encoded as "comprehension required".

NOTE 2 – This octet group is included when the called endpoint selection type indicates specific DLCI or assigned DLCI.

NOTE 3 – This octet group is only included when the called endpoint selection type indicates ATM endpoint and the ATM called endpoint selection type indicates required value or assigned value.

NOTE 4 – This octet group is only present in the case of a soft PVCC.

Table A.1 – Called party SPVC information element codepoints

<p><i>Called endpoint selection type (octet 3)</i></p> <p>Bits</p> <p><u>3 2 1</u></p> <p>0 0 1 Any DLCI (Note 1)</p> <p>0 1 0 Specific DLCI</p> <p>0 1 1 Assigned DLCI</p> <p>1 0 0 Specific SPVC correlator (Note 2)</p> <p>1 1 1 ATM Endpoint (Note 3)</p> <p>NOTE 1 – When the "Any DLCI" codepoint is used, it is assumed that the user equipment supports peer discovery at the protocol layers above the frame relay layer.</p> <p>NOTE 2 – Support of this is optional and must be bilaterally agreed between the two endpoints.</p> <p>NOTE 3 – When the called endpoint selection field is coded "ATM endpoint", octet group 4 is not coded and additional endpoint selection information is coded in octet 5.</p> <p><i>New bit (octet 3), for further study</i></p> <p>This bit is reserved for future use as a "new bit" indication. It is set to zero on transmission and should not be interpreted on reception.</p> <p><i>Data Link Connection Identifier (octet 4-4c)</i></p> <p>See 9.3.3.6/X.76 (Data link connection identifier).</p> <p><i>ATM called endpoint selection type (octet 5) (Note 4)</i></p> <p>Bits</p> <p><u>8 7 6 5 4 3 2 1</u></p> <p>0 0 0 0 0 0 0 0 Any value</p> <p>0 0 0 0 0 0 1 0 Required value</p> <p>0 0 0 0 0 1 0 0 Assigned value</p> <p>NOTE 4 – This octet is allowed only when in octet 3 the called endpoint selection field indicates "ATM endpoint".</p> <p><i>VPI value (octets 6.1 and 6.2)</i></p> <p>A two-octet binary number assigned to the ATM connection identifying the virtual path connection. The VPI value is coded according to ITU-T Rec. Q.2931 connection identification information elements.</p> <p><i>VCI value (octets 7.1 and 7.2)</i></p> <p>A two-octet binary number assigned to the ATM connection identifying the virtual channel connection. The VCI value is coded according to ITU-T Rec. Q.2931 connection identification information elements.</p>
--

A.3 Calling party SPVC information element

The purpose of the calling party SPVC information element is to identify the calling endpoint of a PVC. Figure A.3 shows the coding of the calling party SPVC information element.

8	7	6	5	4	3	2	1	Octet
Calling party SPVC information element identifier								
0	0	0	0	1	0	1	1	
Length of calling party SPVC information element contents								2
DLCI identifier								3*
0	0	0	0	0	0	1	1	
ext. 0	Spare 0	DLCI (Most significant 6 bits)						3.1*
ext. 0/1	DLCI (2nd most significant 4 bits)			Spare				3.2*
ext. 0	DLCI (3rd most significant 7 bits)							3.4*
ext. 1	DLCI (4th most significant 6 bits)						Res. 0	3.5*
VPI identifier								4* (Note 2)
0	0	0	0	0	0	0	1	
VPI value (coded according to ITU-T Rec. Q.2931 Connection identification information element)								4.1-4.2*
VCI identifier								5* (Note 2)
0	0	0	0	0	0	1	0	
VCI value (coded according to ITU-T Rec. Q.2931 Connection identification information element)								5.1-5.2*

NOTE 1 – This information element is coded as "comprehension required".

NOTE 2 – Either a frame layer connection identification is coded (DLCI) or an ATM connection identification is coded (VPI/VCI).

Figure A.3/X.76 – Calling party SPVC information element

A.4 SPVC Procedures

The procedures of this annex utilize the basic SVC connection control procedures for frame relay. Additional procedures are described below.

A.4.1 Initiating SPVC establishment

The SPVC endpoint may initiate SPVC establishment when all of the following conditions are met at the endpoint:

- the PVC UNI data link layer is operational;
- the PVC UNI LIV procedures detect no service affecting condition;
- the PVC UNI includes the DLC information element in a full status response with the Active bit asserted.

NOTE – This condition applies when the PVC UNI operates the user-to-network interface bidirectional procedures.

SPVCs provisioned to request connection to a specific DLCI or a correlated connection can attempt SPVC establishment from either one or both endpoints.

SPVCs provisioned to request connection to any DLCI must attempt SPVC establishment from a single endpoint chosen through bilateral agreement.

The called party SPVC information element is included in the SETUP message. The called party number information element shall contain the address of the called endpoint and the calling party number information element shall contain the address of the calling endpoint.

When the SETUP message is sent across the X.76 interface, it contains the calling party number with the screening indicator codepoint set to either network provided, verified, passed, or user provided, verified, passed.

A.4.2 Receiving a SETUP message at the called endpoints

When a SETUP message is received at the called endpoint, the called endpoint must screen the received SETUP message for the called party SPVC IE. If the called party SPVC information element is present, the SETUP is for an SPVC. When a called party SPVC information element is present in the SETUP message, the called endpoint shall validate the incoming setup request as described below and in the following subclauses. The called endpoint shall verify also the calling party number to determine if the calling party is authorized to establish the SPVC.

A.4.2.1 Call collision

Call setup collisions are detected for SPVCs provisioned to initiate connections to specific or correlated DLCIs. A collision is detected when an incoming setup request identifies a specific or correlated data link connection on a remote endpoint for which a setup has already been sent.

In the event of call setup collision, the incoming call is confirmed and the endpoint starts a clearing timer with a value randomly determined. If the clearing timer expires, the endpoint clears the incoming call with cause No. 8 *Preemption*. The clearing timer is stopped on clearing message reception either on the incoming or the outgoing call.

When both incoming and outgoing calls are cleared with cause No. 8 *Preemption*, each endpoint starts a calling timer with a value randomly determined. Upon calling timer expiry, the endpoint tries to establish the SPVC. The calling timer is stopped if an incoming call is received for the corresponding SPVC.

NOTE – The range of such random timers should be an order of magnitude greater than the round trip setup delay. The number of possible random values shall be sufficient to have a small probability that endpoints select values resulting in both calls being cleared. To achieve this, the difference between the two values should be of an order of magnitude less than the round trip setup delay.

A.4.2.2 Confirmation of SPVC to configured peer

If the called party SPVC IE indicates "specific DLCI" or "specific SPVC correlator", the calling party number IE in the SETUP message shall be examined by the called endpoint. If the called party SPVC IE indicates "Any DLCI", the calling party number may optionally be examined by the called endpoint. If the calling endpoint identified in the calling party number information element in the SETUP message is not authorized by the called endpoint, the call shall be cleared with cause No. 21 *Call rejected*. In addition, if the called party SPVC IE indicates "specific DLCI" or "specific SPVC correlator", the called endpoint shall verify that the calling number is authorized to connect to the requested DLCI at the called end.

A.4.2.3 Allocation of DLCI at called PVC UNI

In the SETUP message, the called party SPVC information element indicates one of the following for the PVC:

- a) any DLCI;
- b) specific DLCI;
- c) specific SPVC correlator.

In case a), an unused DLCI will be selected by the called endpoint for use on the PVC UNI. A call will be cleared with cause No. 21 *Call rejected*, when the called endpoint is not able to connect the call.

In case b), the requested DLCI is checked against the available DLCI values at the called endpoint. If the DLCI is not available for use, the call shall be cleared with cause No. 21 *Call rejected*. In addition if a calling party SPVC information element is included in the SETUP message, the calling party DLCI shall be validated at the called DCE/DTE interface against the provisioned value, when the called endpoint selection type of the called party SPVC information element is coded as "specific DLCI". If the validation fails the call is rejected. If the calling party is an ATM endpoint, the validation shall be performed for the VPI/VCI included in the calling party information element against the provisioned values of the calling party VPI/VCI stored at the called endpoint.

Some reasons why the called DLCI may not be available are:

- The DLCI is in use;
- The calling party does not have authorization to use the DLCI.

In case c), the DLCI is not included in the called party SPVC information element. In the event the called party does not support the specific SPVC correlator option, the call will be cleared with cause No. 21 *Call rejected*. When supported, the SETUP message will include the user-user information element which will contain octets bilaterally agreed between the two endpoints. The value of the octets is used at each endpoint to determine which DLCI to use at the local PVC interface. These octets are referred to as the SPVC correlator. It is required that both endpoints use the same bilaterally agreed value to identify the SPVC when sending a SETUP message.

The DLCI used at the called endpoint is indicated in the called party SPVC IE of the CONNECT message. The called endpoint selection type will indicate assigned DLCI and the data link connection identifier will contain the selected DLCI value.

A.4.2.4 Called endpoint availability

When the called endpoint operating the X.36 bidirectional procedures receives a STATUS message indicating the DLCI is inactive or not provisioned, the SPVC shall be cleared with cause No. 27 *Destination out of order*, with diagnostic No. 1 for DLCI inactive and diagnostic No. 2 for not provisioned.

When the called endpoint operating the link integrity verification procedures determines the link has failed, the SPVC shall be cleared with cause No. 27 *Destination out of order*, with diagnostic No. 3 *Link Integrity Verification failure*.

When the called endpoint physical layer is not established or is out of service, the SPVC has to be cleared with cause No. 27 *Destination out of order*, with diagnostic No. 4 *Physical layer problem*.

A.4.2.4.1 Incompatible destination error case

If the called party SPVC information element in the SETUP message specifies a VPI/VCI, the call shall be rejected by sending a RELEASE COMPLETE message with cause No. 88 *Incompatible destination*.

A.4.3 Receiving a CONNECT message

If a specific DLCI value was requested in the called party SPVC information element of the SETUP message, then the corresponding CONNECT message must contain the same DLCI value in the called party SPVC information element coded with the "assigned DLCI" codepoint. If the DLCI values are the same, the calling endpoint signals the PVC is active. Otherwise the calling endpoint shall release the SPVC with cause No. 21 *Call rejected*.

A.4.4 Receiving a RELEASE or RELEASE COMPLETE message

Following reception of a RELEASE or RELEASE COMPLETE, the SPVC connection is cleared. The connection may be retried. The clear cause received shall affect the frequency of connection establishment as follows:

- Cause No. 34 *No circuit/channel available*: Wait a random number of seconds before retry.
- Cause No. 27 *Destination out of order*:
 - If both ends initiate:
 - i) Do not attempt to retry until a setup message is received for the associated SPVC from the far end; or
 - ii) optionally, wait a minimum of 60 seconds before retry;
 - If single end initiates: Wait a minimum of 60 seconds before retry.
- All other causes: Perform an immediate retry.

The maximum number of SPVC establishment attempts is a local matter. Upon consecutively receiving the same cause value, the time interval between SPVC establishment should be increased.

A.4.5 Coordination with PVC signalling procedures

An SPVC endpoint may be coordinated with the X.36 PVC UNI procedures to exchange status information regarding the operational state of the PVC UNI or an individual virtual connection. The PVC UNI associated with the SPVC endpoint will operate the network side polling response procedures described in 11.4/X.36. The PVC UNI may also operate the optional bidirectional procedures described in 11.5/X.36. When operating the bidirectional procedures, the PVC UNI shall provide a polling initiation procedure to obtain status information.

If the X.36 procedures are used, then the following coordination procedures will be provided.

A.4.5.1 PVC addition – Poll response (network side) procedures

The following procedures shall be followed when a new SPVC is configured by network management. The DCE uses the X.36 DTE-DCE PVC signalling procedures to signal the addition of the new PVC when a STATUS ENQUIRY is received from the DTE.

The X.36 PVC signalling procedures shall be performed at the calling endpoint when the management entity creates a new SPVC.

If the SPVC is to be established using the "specific DLCI" or "specific SPVC correlator" codepoint, the X.36 PVC signalling procedures shall be performed at the called endpoint in conjunction with the procedures of A.4.5.3, PVC availability. This occurs when the management entity configures the called endpoint.

If the SPVC is to be established using the "Any DLCI" codepoint, the X.36 PVC signalling procedures shall be performed when the call is established to the called endpoint in conjunction with the procedures of A.4.5.3.

Table A.2/X.76 – SPVC

New bit generation for SPVCs established with:	New bit is sent in the PVC signalling at the called PVC UNI
Specific DLCI or specific DLCI correlator	When the SPVC is configured by network management
Any DLCI	When the SPVC call is accepted by the called endpoint

A.4.5.2 PVC deletion – Poll response (network side) procedures

The following procedure will be followed when an SPVC is deleted by network management. The DCE uses the procedures of 11.4.1.3/X.36 to signal the deletion of the PVC when a STATUS ENQUIRY is received from the DTE.

A PVC is considered deleted for purposes of 11.4.1.3/X.36 when one of the following events occur:

- a) the management entity deletes an SPVC with a configured DLCI at the calling endpoint;
- b) the release of a connection supporting a DLCI value assigned during call establishment at the called endpoint.

A.4.5.3 PVC availability

A.4.5.3.1 Poll response (network side) procedures

The following procedures will be followed when SPVC availability changes. The DCE uses the X.36 PVC signalling procedures to signal the availability of the PVC when a STATUS ENQUIRY is received from the DTE.

A PVC is active when both DCE interfaces are available as established by the X.36 PVC signalling procedures and a connection (SPVC) is successfully established between the endpoints.

The calling endpoint shall indicate that a DLCI is active using the procedures of 11.4.1.5/X.36 following receipt of a CONNECT message. The called endpoint shall indicate that a DLCI is active using the X.36 PVC signalling procedures following transmission of a CONNECT message.

At the called and calling endpoints of an SPVC established with the "specific DLCI" or "specific SPVC correlator" codepoint, a PVC is considered inactive when the endpoint transmits or receives a RELEASE or RELEASE COMPLETE message.

At the called and calling endpoints of an SPVC established with the "any DLCI" codepoint, a PVC is considered deleted when the endpoint transmits or receives a RELEASE or RELEASE COMPLETE message.

NOTE – When an SPVC, which was established with the "Any DLCI" codepoint is released, the corresponding PVC must be deleted. This is done to indicate to the user that the DLCI no longer is associated with the same endpoint.

A.4.5.3.2 Poll initiation (user side) procedures

This subclause applies only when the optional bidirectional procedures of 11.5/X.36 are utilized. The following procedures are applied when a STATUS response is received by the DCE.

When a STATUS response indicates that a PVC has transitioned from inactive-to-active at the calling PVC UNI, the calling endpoint shall initiate a connection to the called endpoint by sending SETUP message.

When the endpoints receive an indication that a PVC is inactive or deleted, the SPVC shall be cleared with cause No. 39 *Permanent frame mode connection out of service* with diagnostic No. 1 for DLCI inactive and diagnostic No. 2 for deleted. In case of link integrity verification failure, all SPVC will be cleared with cause No. 27 *Destination out of order* with diagnostic No. 3 *Link Integrity Verification failure*.

When a clearing message is sent for one of the previous reasons, the clearing endpoint will indicate PVC active to the adjacent network attached to the NNI interface. This ensures that if the PVCs in the adjacent network are configured last, the SPVCs will be triggered to be established by the propagation of the active bit.

Annex B

Usage of cause and location

B.1 Location field generation

This annex defines the encoding of the cause value, the location and diagnostic fields of the cause information element. It also defines the semantics of each cause value to be used for frame relay SVC signalling at the DTE/DCE and NNI interfaces. See Figure B.1 and Table B.1.

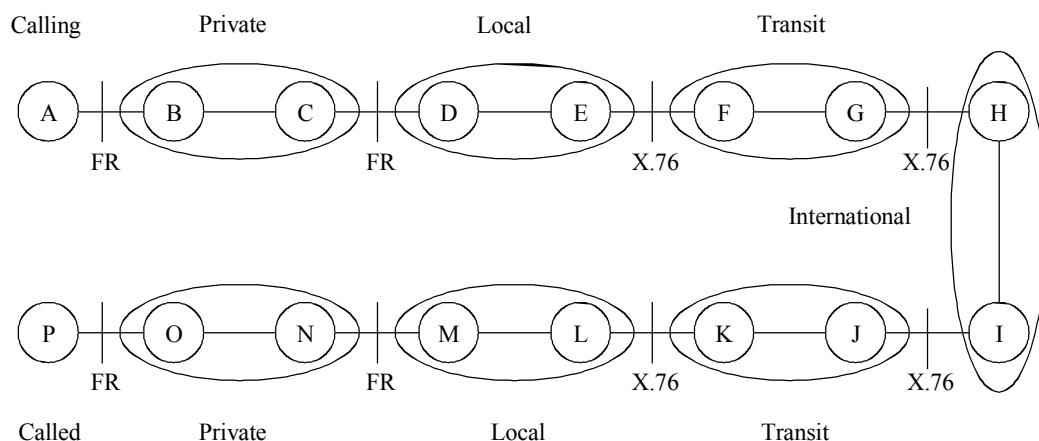

NOTE 1 – The interfaces A-B, C-D, M-N and O-P are assumed to be frame relay UNI.

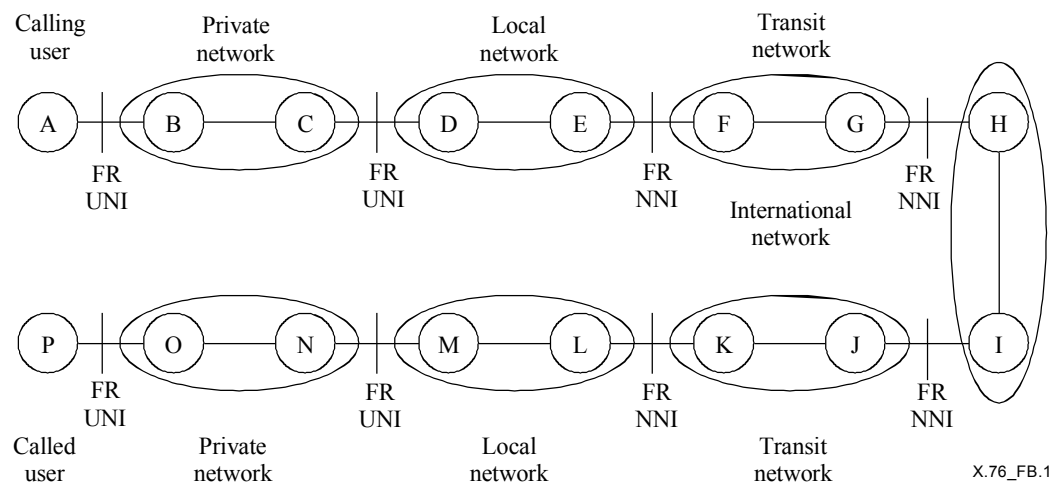

NOTE 2 – The interfaces A-B, C-D, M-N and O-P are assumed to be frame relay UNI.

Figure B.1/X.76 – Reference configuration for location field generation

Table B.1/X.76 – Location field values

Node generating location field	Location field setting	Location setting expected by user A
B	LPN	LPN
C	LPN	LPN
D	LN	LN
E	LN	LN
F	TN	TN
G	TN	TN
H	INTL	INTL
I	INTL	INTL
J	TN	TN
K	TN	TN
L	LN or RLN	RLN
M	LN or RLN	RLN
N	LPN or RPN	RPN
O	LPN or RPN	RPN
P	U	U

B.2 Cause values

The listed cause values are those defined in ITU-T Rec. Q.850. They are applicable to different protocols and services. The cause values relevant to frame relay switched virtual circuits are provided below.

NOTE 1 – Additional cause values are under consideration for introduction as new causes specific to ITU-T Rec. X.76 (and ITU-T Rec. X.36).

Cause value: No. 1 – Unallocated (unassigned) number

Class (octet 4 bits 7 6 5): 0 0 0

Value (octet 4 bits 4 3 2 1): 0 0 0 1

Definition: This cause indicates that the called party cannot be reached because, although the number is in a valid format, it is not currently allocated (assigned).

Diagnostic: Condition

Cause value: No. 2 – No route to specified transit network (national use)

Class (octet 4 bits 7 6 5): 0 0 0

Value (octet 4 bits 4 3 2 1): 0 0 1 0

Definition: This cause indicates that the equipment sending this cause has received a request to route the call to a particular transit network which it does not recognize, either because the transit network does not exist or, because while it does exist, does not serve the equipment which is sending this cause.

Diagnostic: Transit network identity

Cause value: No. 3 – No route to destination

Class (octet 4 bits 7 6 5): 0 0 0

Value (octet 4 bits 4 3 2 1): 0 0 1 1

Definition: This cause indicates that the called party cannot be reached because the network through which the call has been routed does not serve the destination.

Diagnostic: Condition

Cause value: No. 6 – Channel unacceptable

Class (octet 4 bits 7 6 5): 0 0 0

Value (octet 4 bits 4 3 2 1): 0 1 1 0

Definition: This cause indicates that the channel identified is not acceptable to the sender of this cause value. This cause value is used with an ISDN access.

Diagnostic: Not defined

Cause value: No. 7 – Call awarded and being delivered in an established channel

Class (octet 4 bits 7 6 5): 0 0 0

Value (octet 4 bits 4 3 2 1): 0 1 1 1

Definition: This cause indicates that the user has been awarded the incoming call and that the incoming call is being connected to a channel already established to that user for similar calls. This cause is used when the frame relay service is accessed through an ISDN circuit mode connection.

Diagnostic: Not defined

Cause value: No. 16 – Normal call clearing

Class (octet 4 bits 7 6 5): 0 0 1

Value (octet 4 bits 4 3 2 1): 0 0 0 0

Definition: This cause indicates that the call is being cleared because one of the users has requested that the call be cleared.

Diagnostic: Condition

Cause value: No. 17 – User busy

Class (octet 4 bits 7 6 5): 0 0 1

Value (octet 4 bits 4 3 2 1): 0 0 0 1

Definition: This cause indicates that the called party is unable to accept another call because a busy condition has been encountered. This cause value may be generated by either the called user or the network.

Diagnostic: Not applicable the frame relay service

Cause value: No. 18 – No user responding

Class (octet 4 bits 7 6 5): 0 0 1

Value (octet 4 bits 4 3 2 1): 0 0 1 0

Definition: This cause indicates that the called user does not respond to a call establishment message within the prescribed period of time allocated.

Diagnostic: Not defined

Cause value: No. 21 – Call rejected

Class (octet 4 bits 7 6 5): 0 0 1

Value (octet 4 bits 4 3 2 1): 0 1 0 1

Definition: This cause indicates that the equipment sending this cause does not wish to accept this call, although it could have accepted the call because it is neither busy nor incompatible.

Diagnostic: Call rejected condition

Cause value: No. 27 – Destination out of order

Class (octet 4 bits 7 6 5): 0 0 1

Value (octet 4 bits 4 3 2 1): 1 0 1 1

Definition: This cause indicates that the destination cannot be reached because the interface is not functioning correctly. The phrase *not functioning correctly* indicates that a signalling message was unable to be delivered to the called user.

Diagnostic: Not defined

Cause value: No. 28 – Invalid number format (address incomplete)

Class (octet 4 bits 7 6 5): 0 0 1

Value (octet 4 bits 4 3 2 1): 1 1 0 0

Definition: This cause indicates that the called party cannot be reached because the called party number is not in a valid format or is not complete.

Diagnostic: Not defined

Cause value: No. 29 – Facility rejected

Class (octet 4 bits 7 6 5): 0 0 1

Value (octet 4 bits 4 3 2 1): 1 1 0 1

Definition: This cause is returned when a supplementary service requested by the user cannot be provided by the network.

Diagnostic: Facility identification

Cause value: No. 30 – Response to STATUS ENQUIRY

Class (octet 4 bits 7 6 5): 0 0 1

Value (octet 4 bits 4 3 2 1): 1 1 1 0

Definition: This cause is included in the STATUS message when the reason for generating the STATUS message was the receipt of a STATUS ENQUIRY message.

Diagnostic: Not defined

Cause value: No. 31 – Normal, unspecified

Class (octet 4 bits 7 6 5): 0 0 1

Value (octet 4 bits 4 3 2 1): 1 1 1 1

Definition: This cause is used to report a normal event only when no other cause in the normal call applies.

Diagnostic: Not defined

Cause value: No. 34 – No circuit/channel available

Class (octet 4 bits 7 6 5): 0 1 0

Value (octet 4 bits 4 3 2 1): 0 0 1 0

Definition: This cause indicates that there is no appropriate circuit/channel presently available to handle the call.

Diagnostic: Not defined

Cause value: No. 38 – Network out of order

Class (octet 4 bits 7 6 5): 0 1 0

Value (octet 4 bits 4 3 2 1): 0 1 1 0

Definition: This cause indicates that the network is not functioning correctly and that the condition is likely to last a relatively long period of time. Immediately reattempting the call is not likely to be successful.

Diagnostic: Not defined

Cause value: No. 39 – Permanent frame mode connection out of service

Class (octet 4 bits 7 6 5): 0 1 0

Value (octet 4 bits 4 3 2 1): 0 1 1 1

Definition: This cause is included in a STATUS message to indicate that a permanently established frame mode connection is out of service due to equipment.

Diagnostic: Not defined

Cause value: No. 40 – Permanent frame mode connection operational

Class (octet 4 bits 7 6 5): 0 1 0

Value (octet 4 bits 4 3 2 1): 1 0 0 0

Definition: This cause is included in a STATUS message to indicate that a permanently established frame mode connection is operational and capable of carrying user information.

Diagnostic: Not defined

Cause value: No. 41 – Temporary failure

Class (octet 4 bits 7 6 5): 0 1 0

Value (octet 4 bits 4 3 2 1): 1 0 0 1

Definition: This cause indicates that the network is not functioning correctly and that the condition is not likely to last a long period of time. The user may wish to try another call attempt almost immediately.

Diagnostic: Not defined: Not provided in ITU-T Rec. Q.850

Cause value: No. 42 – Switching equipment congestion

Class (octet 4 bits 7 6 5): 0 1 0

Value (octet 4 bits 4 3 2 1): 1 0 1 0

Definition: This cause indicates that the switching equipment generating this cause is experiencing a period of high traffic.

Diagnostic: Not defined

Cause value: No. 43 – Access information discarded

Class (octet 4 bits 7 6 5): 0 1 0

Value (octet 4 bits 4 3 2 1): 1 0 1 1

Definition: This cause indicates that the network could not deliver access information to the remote user as requested (subaddress, low layer compatibility, etc.) as indicated in the diagnostic. It is noted that the particular type of access information discarded is optionally included in the diagnostic.

Diagnostic: Discarded information element identifier

Cause value: No. 44 – Requested circuit/channel not available

Class (octet 4 bits 7 6 5): 0 1 0

Value (octet 4 bits 4 3 2 1): 1 1 0 0

Definition: This cause is returned when the circuit or channel indicated by the requesting entity cannot be provided by the other side of the interface.

Diagnostic: Not defined

Cause value: No. 47 – Resource unavailable, unspecified

Class (octet 4 bits 7 6 5): 0 1 0

Value (octet 4 bits 4 3 2 1): 1 1 1 1

Definition: This cause is used to report a resource unavailable event, when no other cause in the resource unavailable class is applicable.

Diagnostic: Not defined

Cause value: No. 49 – Quality of Service not available

Class (octet 4 bits 7 6 5): 0 1 1

Value (octet 4 bits 4 3 2 1): 0 0 0 1

Definition: This cause indicates that the requested quality of service (specified in the link layer core parameters information element) cannot be provided.

Diagnostic: Condition

Cause value: No. 50 – Requested facility not subscribed

Class (octet 4 bits 7 6 5): 0 1 1

Value (octet 4 bits 4 3 2 1): 0 0 1 0

Definition: This cause indicates that the user has requested a supplementary service which is implemented by the equipment which generated this cause, but the user is not authorized to use.

Diagnostic: Facility identification

Cause value: No. 57 – Bearer capability not authorized

Class (octet 4 bits 7 6 5): 0 1 1

Value (octet 4 bits 4 3 2 1): 1 0 0 1

Definition: This cause indicates that the user has requested a bearer capability which is implemented but for which he is not authorized to use.

Diagnostic: Attribute identity

Cause value: No. 58 – Bearer capability not presently available

Class (octet 4 bits 7 6 5): 0 1 1

Value (octet 4 bits 4 3 2 1): 1 0 1 0

Definition: This cause indicates that the user has requested a bearer capability which is implemented but which is not available at this time.

Diagnostic: Attribute identity

Cause value: No. 63 – Service or option not available, unspecified

Class (octet 4 bits 7 6 5): 0 1 1

Value (octet 4 bits 4 3 2 1): 1 1 1 1

Definition: This cause is used to report a *service or option not available event* only when no other cause in the *service or option not available class* (class 011) applies.

Diagnostic: Not defined

Cause value: No. 65 – Bearer capability not implemented

Class (octet 4 bits 7 6 5): 1 0 0

Value (octet 4 bits 4 3 2 1): 0 0 0 1

Definition: This cause indicates that the equipment sending this cause does not support the bearer capability requested.

Diagnostic: Attribute identity

Cause value: No. 66 – Channel type not implemented

Class (octet 4 bits 7 6 5): 1 0 0

Value (octet 4 bits 4 3 2 1): 0 0 1 0

Definition: This cause indicates that the equipment sending this cause does not support the channel type requested. This cause is used with an ISDN access to the frame relay network.

Diagnostic: Not applicable to a non-ISDN access to the frame relay

Cause value: No. 70 – Only restricted digital information bearer capability is available

Class (octet 4 bits 7 6 5): 1 0 0

Value (octet 4 bits 4 3 2 1): 0 1 1 0

Definition: This cause indicates that the calling party has requested an unrestricted bearer service but that the equipment sending this cause only supports the restricted version of the requested bearer capability.

Diagnostic: Not defined

Cause value: No. 79 – Service or option not implemented, unspecified

Class (octet 4 bits 7 6 5): 1 0 0

Value (octet 4 bits 4 3 2 1): 1 1 1 1

Definition: This cause is used to report a *service or option not implemented event* only when no other cause in the *service or option not implemented class* (class 100) applies.

Diagnostic: Not defined

Cause value: No. 81 – Invalid call reference value

Class (octet 4 bits 7 6 5): 1 0 1

Value (octet 4 bits 4 3 2 1): 0 0 0 1

Definition: This cause indicates that the equipment sending this cause has received a message with a call reference which is not currently in use on the UNI.

Diagnostic: Not defined

Cause value: No. 82 – Identified channel does not exist

Class (octet 4 bits 7 6 5): 1 0 1

Value (octet 4 bits 4 3 2 1): 0 0 1 0

Definition: This cause indicates that the equipment sending this cause has received a request to use a channel not activated on the interface. This cause is mainly used when an ISDN circuit mode connection is used to access the frame relay network. This cause is used, for example, when a user has subscribed to those channels on a primary rate interface numbered from 1 to 12 and the user equipment or the network attempts to use channels 13 to 23.

Diagnostic: For further study

Cause value: No. 87 – User not member of CUG

Class (octet 4 bits 7 6 5): 1 0 1

Value (octet 4 bits 4 3 2 1): 0 1 1 1

Definition: This cause indicates that the called user for the incoming CUG call is not a member of the specified CUG or that the calling user is an ordinary subscriber calling a CUG subscriber.

Diagnostic: Not defined

Cause value: No. 88 – Incompatible destination

Class (octet 4 bits 7 6 5): 1 0 1

Value (octet 4 bits 4 3 2 1): 1 0 0 0

Definition: This cause indicates that the equipment sending this cause has received a request to establish a call which has compatibility attributes (information element) which cannot be accommodated.

Diagnostic: (Incompatible) information element identifier

Cause value: No. 90 – Non-existent CUG

Class (octet 4 bits 7 6 5): 1 0 1

Value (octet 4 bits 4 3 2 1): 1 0 1 0

Definition: This cause indicates that the specified CUG does not exist.

Diagnostic: Not defined

Cause value: No. 91 – Invalid transit network selection (national use)

Class (octet 4 bits 7 6 5): 1 0 1

Value (octet 4 bits 4 3 2 1): 1 0 1 1

Definition: This cause indicates that a transit network identification was received which is of an incorrect format as defined in Annex C/Q.931.

Diagnostic: Not defined

Cause value: No. 95 – Invalid message, unspecified

Class (octet 4 bits 7 6 5): 1 0 1

Value (octet 4 bits 4 3 2 1): 1 1 1 1

Definition: This cause is used to report an *invalid message event* only when no other cause in the *invalid message class* (class 101) applies.

Diagnostic: Not defined

Cause value: No. 96 – Mandatory information element is missing

Class (octet 4 bits 7 6 5): 1 1 0

Value (octet 4 bits 4 3 2 1): 0 0 0 0

Definition: This cause indicates that the equipment sending this cause has received a message which is missing a mandatory information element.

Diagnostic: Information element identifier

Cause value: No. 97 – Message type non-existent or not implemented

Class (octet 4 bits 7 6 5): 1 1 0

Value (octet 4 bits 4 3 2 1): 0 0 0 1

Definition: This cause indicates that the equipment sending this cause has received a message type it does not recognize either because it is not defined or it is defined but not implemented.

Diagnostic: Message type

Cause value: No. 98 – Message not compatible with call state or message type non-existent or not implemented

Class (octet 4 bits 7 6 5): 1 1 0

Value (octet 4 bits 4 3 2 1): 0 0 1 0

Definition: This cause indicates that the equipment sending this cause has received a message not expected in the current call state. This cause is also sent when a STATUS message was received indicating an incompatible call state.

Diagnostic: Message type

Cause value: No. 99 – Information element/parameter non-existent or not implemented

Class (octet 4 bits 7 6 5): 1 1 0

Value (octet 4 bits 4 3 2 1): 0 0 1 1

Definition: This cause indicates that the equipment sending this cause has received a message which includes information element(s) not defined or not implemented. This cause indicates that the information element(s) was (were) discarded and not required to process the message.

Diagnostic: Information element identifier

Cause value: No. 100 – Invalid information element contents

Class (octet 4 bits 7 6 5): 1 1 0

Value (octet 4 bits 4 3 2 1): 0 1 0 0

Definition: This cause indicates that the equipment sending this cause has received an information element which it has implemented; however, the encoding of one or more fields of the information element is not supported or implemented.

Diagnostic: Information element identifier

Cause value: No. 101 – Message not compatible with call state

Class (octet 4 bits 7 6 5): 1 1 0

Value (octet 4 bits 4 3 2 1): 0 1 0 1

Definition: This cause indicates that a message has been received which is incompatible with the call state.

Diagnostic: Message type

Cause value: No. 102 – Recovery on timer expiry

Class (octet 4 bits 7 6 5): 1 1 0

Value (octet 4 bits 4 3 2 1): 0 1 1 0

Definition: This cause indicates that a procedure has been initiated by the expiry of a timer in association with error handling procedures.

Diagnostic: Timer number

Cause value: No. 104 – Excess repetitions of information element

Class (octet 4 bits 7 6 5): 1 1 0

Value (octet 4 bits 4 3 2 1): 1 0 0 0

Definition: This cause indicates that the maximum permitted number of permitted repeated information elements has been exceeded.

Diagnostic: Information element identifier

NOTE 2 – This is a cause value that is specific to ITU-T Rec. X.76.

Cause value: No. 111 – Protocol error, unspecified

Class (octet 4 bits 7 6 5): 1 1 0

Value (octet 4 bits 4 3 2 1): 1 1 1 1

Definition: This cause is used to report a *protocol error event* only when no other cause in the *protocol error class* (110) applies.

Diagnostic: Not defined

Cause value: No. 127 – Interworking, unspecified

Class (octet 4 bits 7 6 5): 1 1 1

Value (octet 4 bits 4 3 2 1): 1 1 1 1

Definition: This cause indicates that there has been interworking with a network which does not provide causes for actions it takes. Thus, the precise cause for a message which is being sent cannot be ascertained.

Diagnostic: Not defined

B.3 Coding of the diagnostic field

B.3.1 Coding of condition

The condition diagnostic (octet 5) is coded as follows:

Bit

8
1

Bits

7 6 5
0 0 0

Bit

4

0 Network service provider

1 Network service user

Bit

3

0 Normal

1 Abnormal

Bits

2 1

0 0 Unknown

0 1 Permanent

1 0 Transient

B.3.2 Coding of transit network identity

The diagnostic field contains the entire transit network selection information element.

B.3.3 Coding of call rejected diagnostic

The format of the diagnostic field for cause No. 21 is shown in Figure B.2 and Table B.2.

Figure B.2 | Table B.2/X.76 – Coding of diagnostic field for cause No. 21

Figure B.2 – Coding of diagnostic field for cause No. 21 structure

8	7	6	5	4	3	2	1	Octet
ext. 1	Rejection reason					Condition		5
IE type	Information element identifier							7

Table B.2 – Coding of diagnostic field for cause No. 21 codepoints

<p><i>Rejection reason (octet 5)</i></p> <p>Bits</p> <p><u>7 6 5 4 3</u></p> <p>0 0 0 0 1 Information element missing</p> <p>0 0 0 1 0 Information element contents are not sufficient</p> <p>All other values are reserved.</p> <p><i>Condition (octet 5)</i></p> <p>Bits</p> <p><u>2 1</u></p> <p>0 0 Unknown</p> <p>0 1 Permanent</p> <p>1 1 Transient</p> <p><i>IE type (octet 7)</i></p> <p>Bit</p> <p><u>8</u></p> <p>0 Variable length information element</p> <p>1 Fixed length information element</p> <p><i>IE identifier (octet 7)</i></p> <p>Bits 7-1 are encoded with the information element identifier of the missing or insufficient information element (see 10.5 for the information element code values).</p>
--

B.3.4 Coding of timer value

The timer number is coded using characters defined in ITU-T Rec. T.50, one character per decimal digit. The following coding is used in each octet starting with octet 5 of the diagnostic field:

Bit 8: Spare B'0'

Bits 7-1: IA5 character

NOTE – The most significant decimal digit of the timer is coded first (in octet 5), the other digits are coded in subsequent octets.

B.3.5 Coding of message type

The message type is coded as specified in 10.5.3.

B.3.6 Coding of the facility type

The codepoint of the information element associated with the facility rejected. Except for the simple CUG since it is not possible to code the codepoint of an information element.

Annex C

Enhancements to PVC management procedures

C.1 Introduction

The PVC management procedures, as defined in clause 11, impose a limit on the number of PVC reporting status. This limit is caused by the maximum frame size that can be supported at the frame relay NNI. This annex defines optional enhanced PVC management procedures to increase the number of PVCs in Full Status reports. The enhanced procedures add a new Full Status Continued report type to the Report Type Information Element in order to segment the Full Status message when the number of PVC status reporting cannot fit in one STATUS message.

NOTE – This annex shows only the changes to clause 11.

General requirements concerning the use of the segmentation capability:

- 1) It is optional for a network to support the segmentation capability.
- 2) The use of the segmentation capability is determined by bilateral agreement between networks.
- 3) The segmentation capability is used only to overcome the limitation caused by the frame size. It is used when it is not possible to include all full status reports in a single message.

C.2 List of changes to clause 11

C.2.1 Clause 11.3.2 – Report type

A new codepoint is added to the report type (octet 3):

0000 0100 Full status continued (Note)

NOTE – This codepoint is used when the status of all PVCs cannot fit in a single STATUS message.

C.2.2 Procedures

- 1) The following is added to clause 11.4.1, Periodic polling item 1):

When a polling STE requests a *full status report* in a STATUS ENQUIRY message, the responding STE may respond with a *full status continued* STATUS message. This indicates that the message contains only a partial list of PVC Status information elements. Upon receipt of a *full status continued* STATUS message, the polling STE must continue to request PVC status by sending *full status continued* STATUS ENQUIRY messages (without waiting for the next T391 interval). The polling STE will restart timer T391 each time it receives a *full status continued* STATUS message and subsequently transmits a *full status continued* STATUS ENQUIRY message. When the responding STE responds with a *full status* STATUS message, all PVC Status information elements have been reported.

The polling STE is responsible for "pacing" of multiple *full status continued* STATUS ENQUIRY messages to control the rate of the request/response messaging.

- 2) The following is added to item 2):

The expiry of T391 will initiate sending of either the *link integrity verification status only* or the *full status* STATUS ENQUIRY. That is, every N391 expiries of T391 will initiate sending of the *full status* STATUS ENQUIRY – the remaining (N391–1) expiries will initiate sending of the *link integrity verification only* STATUS ENQUIRY. Sending of the *full status continued* STATUS ENQUIRY has no effect on the N391 count.

3) The following is added as a new item 4) after item 3):

If a responding STE cannot fit the status for all PVCs in a single *full status* STATUS message, it will respond to a *full status* STATUS ENQUIRY message with a *full status continued* STATUS message. The responding STE responds with a *full status* STATUS or *full status continued* STATUS message starting at the next DLCI that follows the last PVC Status information element reported in the previous STATUS message. (The *full status* STATUS response is sent when the network can fit all remaining PVC Status information elements in the message.)

For each *full status continued* STATUS message, the polling STE shall interpret omission of a previously reported PVC up to the last DLCI received in the last PVC Status information element of that *full status continued* STATUS message as an indication that the PVC is no longer provisioned. Once the final *full status* STATUS message is received, DLCIs with values greater than the last PVC Status information element can be considered no longer provisioned at the frame relay NNI between the polling and responding STEs.

Appendix I

Network congestion scenarios

In Figure I.1 a single PVC passing through three networks is shown. The PVC consists of three segments and traverses two separate NNI links. The PVC carries traffic between two end users; user X and user Y.

If network B becomes congested in a manner which reduces its capacity to carry traffic on this PVC in the direction X to Y, network B must signal this explicitly to users X and Y. Network B achieves this by setting the FECN bit in the address field in frames passing towards user Y and setting the BECN bit in the address field in frames passing towards user X. The responsibility of networks A and C in this case is to transport these congestion notification bits towards the UNIs unchanged.

In principle, on receiving congestion notification, end-user equipment should reduce the offered load on the indicated PVC. This may, in fact, result in an increase in the effective throughput available to the end-user under congestion conditions. However, as the behaviour of each end user cannot be guaranteed, networks should have the ability to protect themselves and other users from congestion. In the case shown, network B may protect itself by the use of a rate enforcement mechanism at ingress from an NNI which would involve the discarding of frames, beginning with those marked discard eligible, in times of congestion.

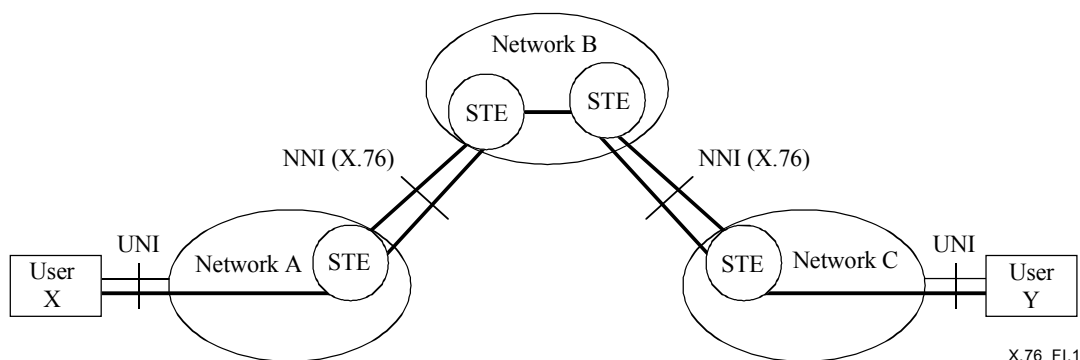

Figure I.1/X.76 – Multi-segment PVC to illustrate congestion scenarios

Appendix II

International network identification according to ITU-T Rec. X.125 for networks providing frame relay services and numbered under the E.164 numbering plan

II.1 Introduction

For those public frame relay networks numbered under the E.164 numbering plan, the international identifier will consist of the E.164 country code followed by a network identifier code. The maximum length of the international identifier is 8 digits coded according to ITU-T Rec. T.50. Only numeric values (0-9) shall be used.

Whilst the assignment of these network identification codes is a national matter, regular publication of such information is required to be made available to both users and operators of public frame relay networks.

II.2 Assignment and notification process

ITU-T Rec. X.125 defines the procedure for the assignment by a national authority, and notification to the ITU-T of the network identification codes, in order that this information can be maintained in a central register and published on a regular basis.

The assignment of network identification codes to frame relay networks numbered under the E.164 numbering plan, in order to create an international identifier, is a purely national matter and will be made by a national authority in accordance with national laws and regulations or agreed national arrangements. The allocating authority will notify TSB of any new or revised assignments. Assignments of frame relay network identification codes will be published in the ITU Operational Bulletin. A recapitulatory list is published annually in the Operational Bulletin.

Appendix III

Call state diagrams at one STE side of the NNI

III.1 Symbol definition of the call state diagrams

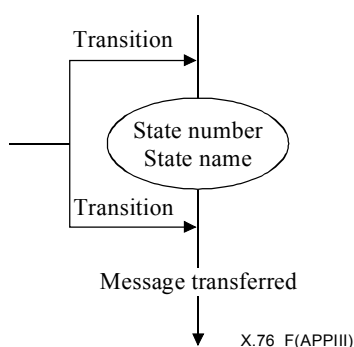

NOTE 1 – Each call state is represented by an ellipse wherein the state name and number are indicated.

NOTE 2 – Each state transition is represented by an arrow. The action on the arrow is the action at one side of NNI.

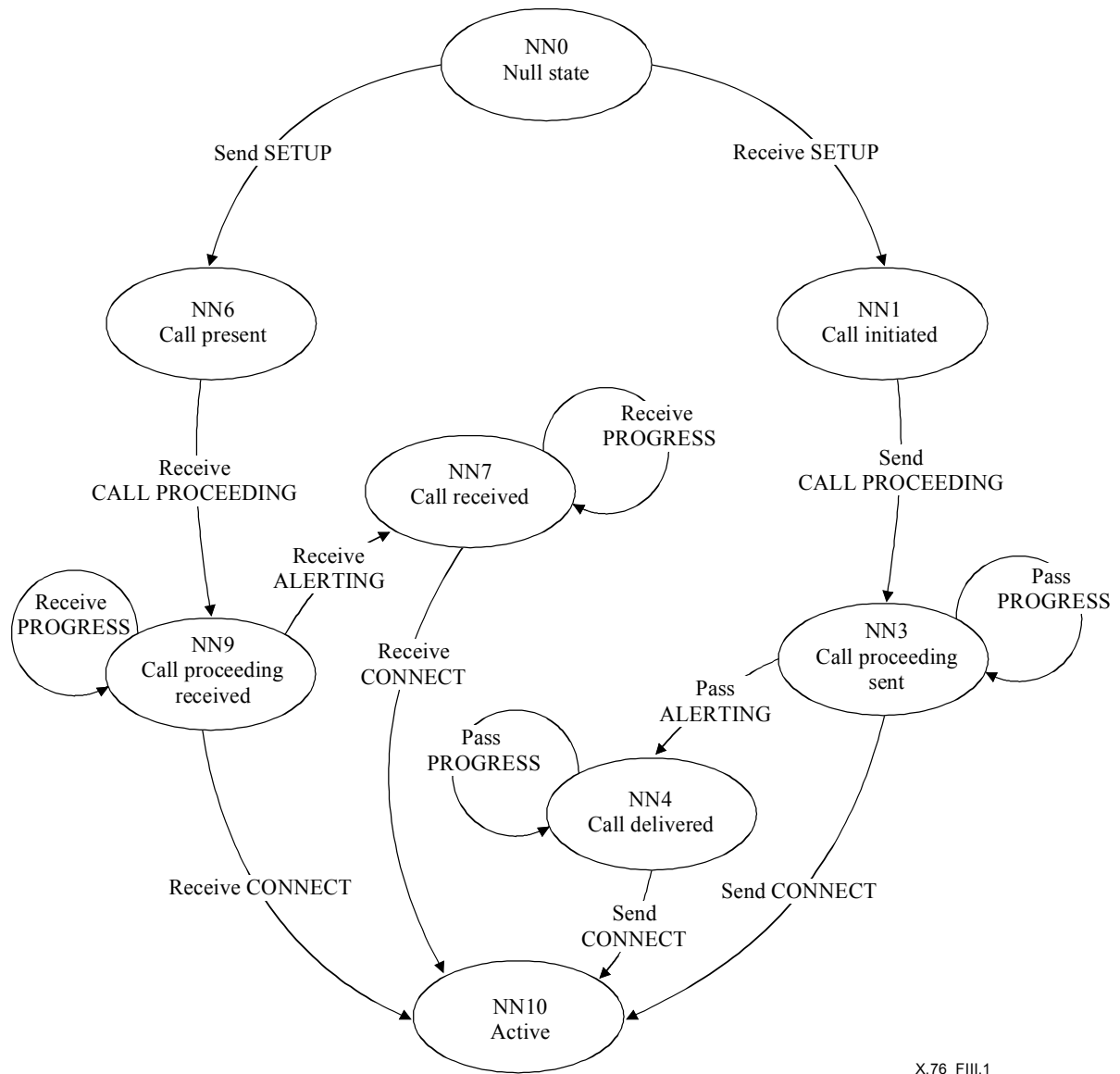

X.76_FIII.1

Figure III.1/X.76 – Diagram of call states for the transfer of call establishment messages at one side of NNI

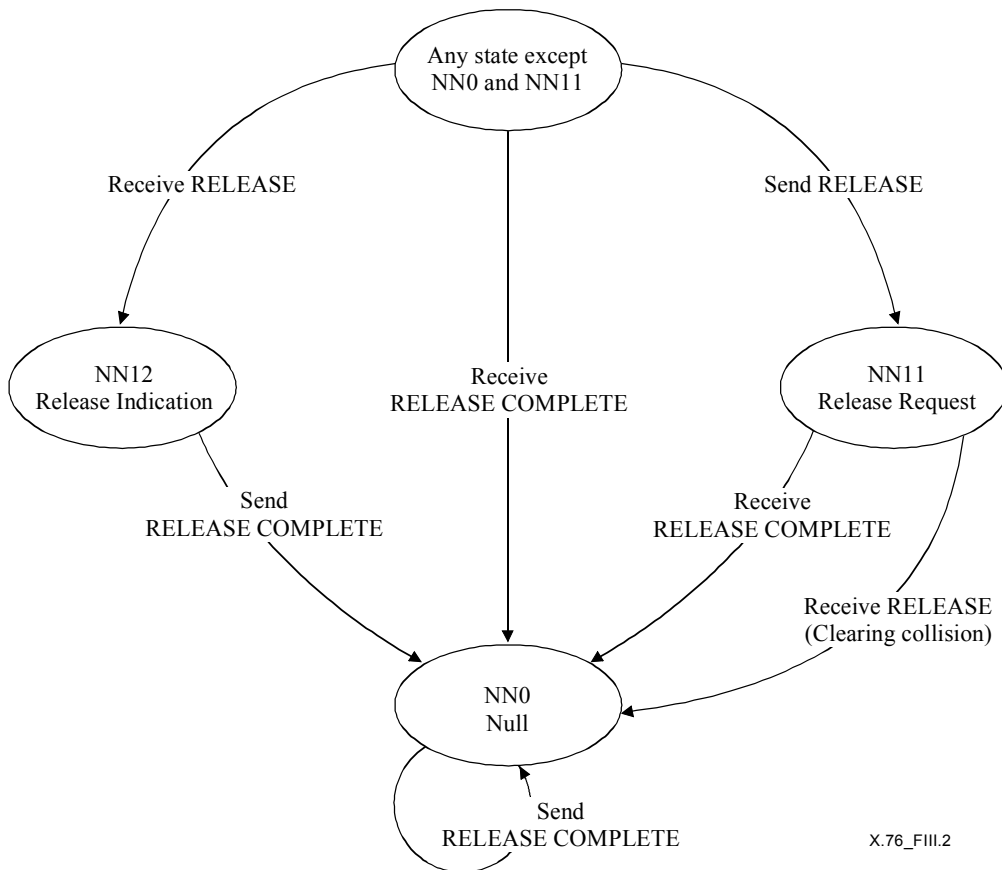
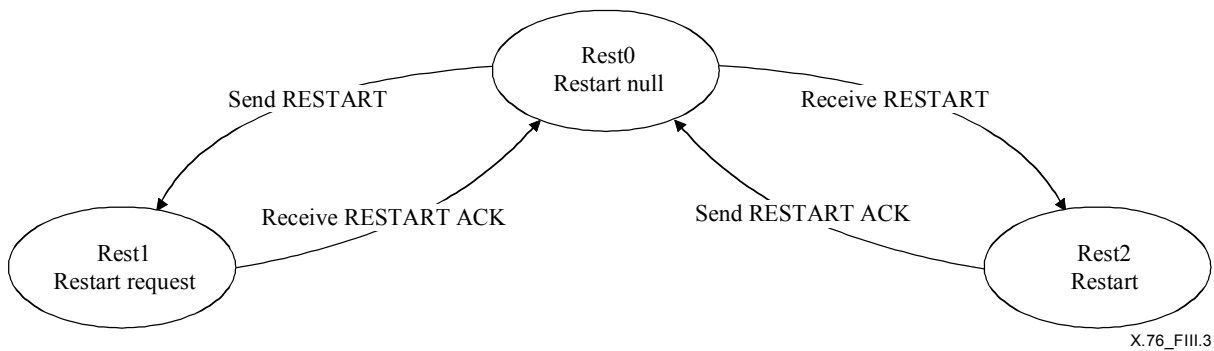

Figure III.2/X.76 – Diagram of call states for the transfer of call clearing messages at one side of NNI



NOTE – The case of restart collision is handled independently by each side of the NNI according to 10.6.4.1.

Figure III.3/X.76 – Diagram of call states for the transfer of restart messages at one side of NNI

Appendix IV

Action taken by the STE on receipt of a message in a given call state at one side of NNI

Table IV.1/X.76 – Action taken by the STE on receipt of message in a given call state at one side of NNI: call setup and clearing procedure

State at the STE B Message from STE A	NN0 (Null State)	NN1 (Call initiated)	NN3 (Call proceeding sent)	NN4 (Call delivered)	NN6 (Call present)	NN7 (Call received)	NN9 (Call proceeding received)	NN10 (Active)	NN11 (Release request)	NN12 (Release indication)
SETUP	NORMAL (NN1)	DISCARD	DISCARD	DISCARD	DISCARD	DISCARD	DISCARD	DISCARD	DISCARD	DISCARD
CALL PROCEEDING	ERROR #81	ERROR #98	ERROR #98	ERROR #98	NORMAL (NN9)	ERROR #98	ERROR #98	ERROR #98	ERROR #98	ERROR #98
ALERTING	ERROR #81	ERROR #98	ERROR #98	ERROR #98	NORMAL (NN7)	ERROR #98	NORMAL (NN7)	ERROR #98	ERROR #98	ERROR #98
PROGRESS	ERROR #81	ERROR #98	ERROR #98	ERROR #98	NORMAL (NN6)	NORMAL (NN7)	NORMAL (NN9)	ERROR #98	ERROR #98	ERROR #98
CONNECT	ERROR #81	ERROR #98	ERROR #98	ERROR #98	ERROR #98	NORMAL (NN10)	NORMAL (NN10)	ERROR #98	ERROR #98	ERROR #98
RELEASE	ERROR #81	NORMAL (NN12)	NORMAL (NN12)	NORMAL (NN12)	NORMAL (NN12)	NORMAL (NN12)	NORMAL (NN12)	NORMAL (NN12)	NORMAL (NN12)	NORMAL (NN12)
RELEASE COMPLETE	NORMAL (NN0)	NORMAL (NN0)	NORMAL (NN0)	NORMAL (NN0)	NORMAL (NN0)	NORMAL (NN0)	NORMAL (NN0)	NORMAL (NN0)	NORMAL (NN0)	NORMAL (NN0)
STATUS ENQUIRY	NORMAL #30	NORMAL #30	NORMAL #30	NORMAL #30	NORMAL #30	NORMAL #30	NORMAL #30	NORMAL #30	NORMAL #30	NORMAL #30
STATUS STATUS	NORMAL STATUS	NORMAL STATUS	NORMAL STATUS	NORMAL STATUS	NORMAL STATUS	NORMAL STATUS	NORMAL STATUS	NORMAL STATUS	NORMAL STATUS	NORMAL STATUS

Table IV.2/X.76 – Action taken by the STE on receipt of message in a given state at one side of NNI: restart procedure

Message from STE A \ State at the STE B	Rest0 (Restart null)	Rest1 (Restart request)	Rest2 (Restart)
RESTART	NORMAL (Rest2)	Initiate independent restart procedure as in 10.6.4.1	NORMAL (Rest2)
RESTART ACK	DISCARD	NORMAL (Rest0)	DISCARD

The actions taken by the STE are indicated in the following way:

- **NORMAL (NNi):** The action taken by the STE follows the procedure as defined in 10.6 and the STE enters state NNi.
- **DISCARD:** The STE discards the received message and takes no subsequent action as a direct result of receiving that message; the STE remains in the same state.
- **ERROR #98:** The STE discards the received message, returns a STATUS message with cause No. 98 and the STE remains in the same state.
- **ERROR #81:** The STE discards the received message, returns a RELEASE COMPLETE message with cause No. 81 and the STE remains in the Null state (NN0).
- **NORMAL #30:** The STE returned a STATUS message, reporting the current call state with cause No. 30 and the STE remains in the same state.
- **NORMAL STATUS:** The action taken by the STE follows the procedure as defined in 10.6.5.2.

SERIES OF ITU-T RECOMMENDATIONS

Series A	Organization of the work of ITU-T
Series B	Means of expression: definitions, symbols, classification
Series C	General telecommunication statistics
Series D	General tariff principles
Series E	Overall network operation, telephone service, service operation and human factors
Series F	Non-telephone telecommunication services
Series G	Transmission systems and media, digital systems and networks
Series H	Audiovisual and multimedia systems
Series I	Integrated services digital network
Series J	Cable networks and transmission of television, sound programme and other multimedia signals
Series K	Protection against interference
Series L	Construction, installation and protection of cables and other elements of outside plant
Series M	TMN and network maintenance: international transmission systems, telephone circuits, telegraphy, facsimile and leased circuits
Series N	Maintenance: international sound programme and television transmission circuits
Series O	Specifications of measuring equipment
Series P	Telephone transmission quality, telephone installations, local line networks
Series Q	Switching and signalling
Series R	Telegraph transmission
Series S	Telegraph services terminal equipment
Series T	Terminals for telematic services
Series U	Telegraph switching
Series V	Data communication over the telephone network
Series X	Data networks and open system communications
Series Y	Global information infrastructure and Internet protocol aspects
Series Z	Languages and general software aspects for telecommunication systems