



INTERNATIONAL TELECOMMUNICATION UNION

ITU-T

TELECOMMUNICATION
STANDARDIZATION SECTOR
OF ITU

X.30

(03/93)

**PUBLIC DATA NETWORKS:
INTERFACES**

**SUPPORT OF X.21, X.21 *bis* AND X.20 *bis*
BASED DATA TERMINAL EQUIPMENTS
(DTEs) BY AN INTEGRATED SERVICES
DIGITAL NETWORK (ISDN)**

ITU-T Recommendation X.30

(Previously "CCITT Recommendation")

FOREWORD

The ITU Telecommunication Standardization Sector (ITU-T) is a permanent organ of the International Telecommunication Union. The ITU-T is responsible for studying technical, operating and tariff questions and issuing Recommendations on them with a view to standardizing telecommunications on a worldwide basis.

The World Telecommunication Standardization Conference (WTSC), which meets every four years, established the topics for study by the ITU-T Study Groups which, in their turn, produce Recommendations on these topics.

ITU-T Recommendation X.30 was revised by the ITU-T Study Group VII (1988-1993) and was approved by the WTSC (Helsinki, March 1-12, 1993).

NOTES

1 As a consequence of a reform process within the International Telecommunication Union (ITU), the CCITT ceased to exist as of 28 February 1993. In its place, the ITU Telecommunication Standardization Sector (ITU-T) was created as of 1 March 1993. Similarly, in this reform process, the CCIR and the IFRB have been replaced by the Radiocommunication Sector.

In order not to delay publication of this Recommendation, no change has been made in the text to references containing the acronyms "CCITT, CCIR or IFRB" or their associated entities such as Plenary Assembly, Secretariat, etc. Future editions of this Recommendation will contain the proper terminology related to the new ITU structure.

2 In this Recommendation, the expression "Administration" is used for conciseness to indicate both a telecommunication administration and a recognized operating agency.

© ITU 1993

All rights reserved. No part of this publication may be reproduced or utilized in any form or by any means, electronic or mechanical, including photocopying and microfilm, without permission in writing from the ITU.

CONTENTS

		<i>Page</i>
1	Reference configurations.....	2
1.1	Customer access configuration.....	2
1.2	Network configuration.....	2
1.3	Interworking situation.....	3
2	Terminal adaption functions.....	4
2.1	Terminal adaption functions for DTEs conforming to X.1 user classes of service 3 to 6.....	5
2.2	Terminal adaption functions for DTEs conforming to X.1 user class of service 7.....	23
2.3	Terminal adaption functions for DTEs conforming to X.1 user class of service 19.....	24
2.4	Terminal adaption functions for DTEs conforming to X.1 user classes of service 1, 2, 14, 15, 16, 17 and 18.....	27
3	Test loops.....	31
3.1	Test loop reference configuration.....	31
3.2	Test loop characteristics.....	32
3.3	Loop activation/deactivation mechanism.....	32
3.4	Coding of activation/deactivation control message.....	32
Annex A – SDL diagrams.....		33
A.1	General.....	33
A.2	Some remarks about the formal description.....	33
Appendix I – Universal terminal adaptor.....		41
I.1	User rate identification.....	41
I.3	Loss of alignment/recovery.....	41
I.4	Ready for data alignment.....	42
Appendix II – Inslot identification of intermediate bit rate.....		43
II.1	Identification of intermediate rate.....	43
II.2	Restitution of the intermediate rate.....	43
II.3	User rate identification.....	43

Recommendation X.30¹⁾

**SUPPORT OF X.21, X.21 *bis* AND X.20 *bis* BASED DATA
TERMINAL EQUIPMENTS (DTEs) BY AN INTEGRATED
SERVICES DIGITAL NETWORK (ISDN)**

(Malaga-Torremolinos, 1984; amended at Melbourne, 1988 and Helsinki, 1993)

The CCITT,

considering

- (a) that the Integrated Services Digital Network (ISDN) will offer the universal interfaces to connect subscriber terminals according to the reference configurations described in Recommendation I.411;
- (b) that during the evolution of ISDN, however, there will exist for a considerable period DTEs conforming to Recommendations X.21, X.21 *bis* and X.20 *bis* which have to be connected to the ISDN;
- (c) that the D-channel signalling protocol is described in Recommendations I.430, Q.920, Q.921, Q.930 and Q.931;
- (d) that the X.21 *bis* DTEs are an evolution of V-Series DTEs, which also provide interworking capability with X.21 DTEs over PDN services, and which use the network provided signal element timing and may have specific call control features to comply with the X.21 calling protocol²⁾;
- (e) that the X.20 *bis* based DTEs are an evolution of V-Series DTEs, which are operating in the asynchronous mode and which may have call control features to comply with the X.20 calling protocol,

unanimously declares

- 1) that the scope of this Recommendation covers the connection of X.21 and X.21 *bis* based terminals of user classes of service 3 to 7 and 19 to the ISDN operating in accordance with circuit-switched or leased circuit services;
- 2) that the scope of this Recommendation also covers the connection of X.20 *bis* based terminals of user classes of service 1, 2, 14, 15, 16, 17 and 18;
- 3) that the reference configurations of clause 1 shall apply;
- 4) that the terminal adaptor (TA) functions to support X.21, X.21 *bis* and/or X.20 *bis* based DTEs including:
 - rate adaption functions,
 - call establishment functions,
 - mapping functions,
 - ready for data alignment,

shall be performed as outlined in clause 2;

- 5) that the scope of this Recommendation covers the rate adaption requirements which are caused by the connection of existing terminals to the ISDN user/network interface, but does not cover the requirements on bit rate conversion caused by the inter-operation of terminals with different bit rates (ISDN-CSPDN interworking).

¹⁾ This Recommendation is also included in the Recommendations of the I-Series under the number I.461.

²⁾ See Recommendation V.110.

1 Reference configurations

Figures 1-1 and 1-2 show examples of possible configurations and are included simply as an aid to describing the TA functions.

1.1 Customer access configuration

For the connection of X.21, X.21 *bis* or X.20 *bis* based DTEs to the ISDN, Figure 1-1 shows a possible reference configuration.

1.2 Network configuration

The specification of terminal adaption functions takes account of the network configuration and the end-to-end connection types shown in Figure 1-2 in which the associated terminal equipment TE1 and TE2 may be involved.

The TA functions for this scenario are described in 2.

The terminals TE1 and TE2 are physically and logically connected to the ISDN where the call is handled.

The TA performs the necessary rate adaption, the signalling conversion from the X.21 signalling to the Q.931 signalling and vice-versa (X.21 mapping) and ready for data alignment. Interworking with dedicated networks, e.g. a CSPDN, will be provided on the basis of trunk lines interconnection by using Interworking Functions (IWF).

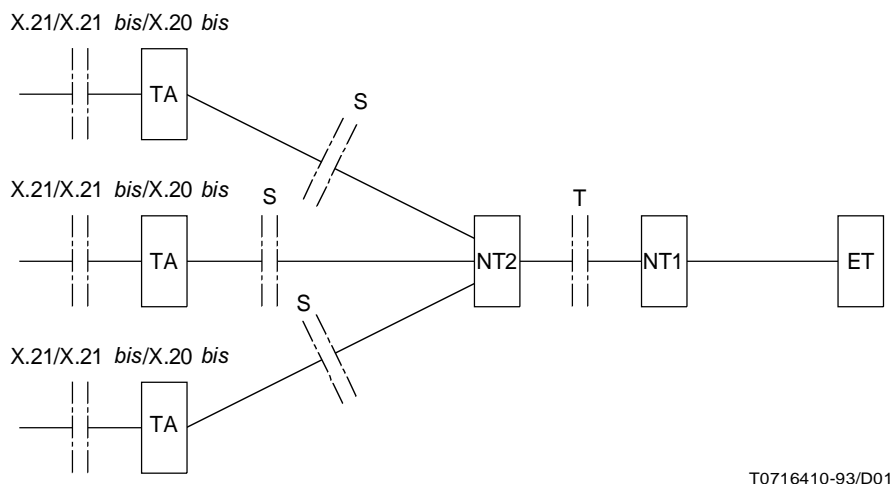

TA Terminal adaptor
NT Network termination
ET Exchange termination

NOTES

- 1 For ISDN reference configurations, see Recommendation I.430.
- 2 The ISDN signalling protocol is described in Recommendations Q.921 and Q.931.

FIGURE 1-1/X.30

Customer access configuration example

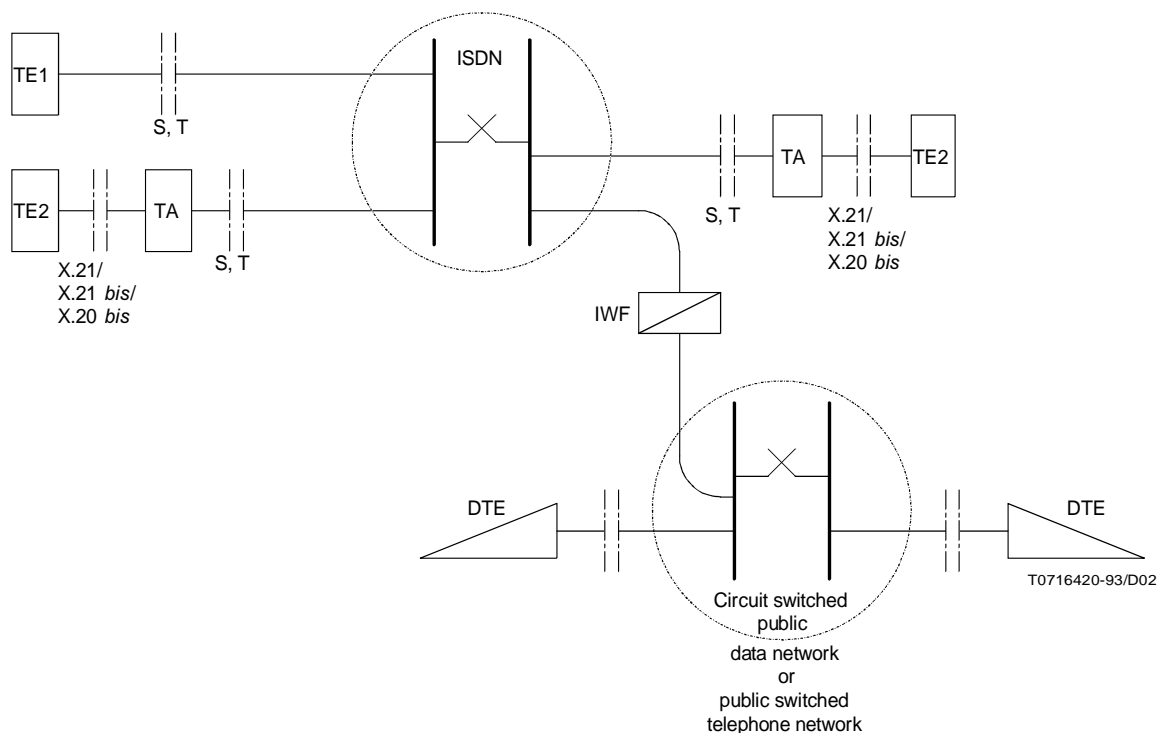

IWF Interworking functions

FIGURE 1-2/X.30
Network interworking configuration example

The following principles shall apply:

- a) The non-voice services within the ISDN should basically not diverge from what is being developed in X-Series Recommendations. This refers to the various aspects concerning quality of service, user facilities, call progress signals (see the X-Series Recommendations, e.g. X.2 and X.96). However, existing features would be enhanced and additional features would also be developed if account were taken of the new ISDN customer capabilities (e.g. multi-terminal arrangement, user rate at 64 kbit/s simultaneous multi-media access as well as the possible solution of compatibility checking).
- b) Integration of X.21 based services into the ISDN is applicable to user classes of services 3 to 7, and 19. Integration of X.20 *bis* based services into the ISDN is applicable to user classes of service 1, 2, 14, 15, 16, 17 and 18.
- c) Terminals TE1 and TE2 connected to an ISDN shall use the ISDN numbering scheme (see Recommendation E.164).

1.3 Interworking situation

Bearing in mind that this Recommendation defines the functions performed by the X.21 terminal adaptors (TA X.21) and X.21 *bis* terminal adaptors (TA X.21 *bis*) and X.20 *bis* terminal adaptors (TA X.20 *bis*), the following cases of

interworking between these terminal adaptors and DTEs connected to CSPDN and PSTN may appear:

- a) For user classes of service 3 to 7:
- (1) TA X.21 --- TA X.21
 - (2) TA X.21 --- TA X.21 *bis*
 - (3) TA X.21 *bis* --- TA X.21 *bis*
 - (4) TA X.21 --- DTE X.21
 - (5) TA X.21 --- DTE X.21 *bis*
 - (6) TA X.21 --- V-Series DTE
 - (7) TA X.21 *bis* --- DTE X.21
 - (8) TA X.21 *bis* --- DTE X.21 *bis*
 - (9) TA X.21 *bis* --- V-Series DTE
- b) For user class of service 19:
- (10) TA X.21 --- TA X.21
 - (11) TA X.21 --- TA X.21 *bis*
 - (12) TA X.21 *bis* --- TA X.21 *bis*
 - (13) TA X.21 --- TE1 (S/T reference point)
 - (14) TA X.21 *bis* --- TE1 (S/T reference point)
- c) For user classes of service 1 and 2:
- (15) TA X.20 *bis* --- TA X.20 *bis*
 - (16) TA X.20 *bis* --- DTE X.20 *bis*
 - (17) TA X.20 *bis* --- V-Series DTE

NOTES

1 This Recommendation is intended to cover all TA-functions necessary to allow interworking as listed above. Currently, this Recommendation covers all TA-functions necessary to allow interworking between DTEs connected to ISDN and to CSPDN with the following exceptions:

- for X.21 *bis* only, the call control procedure with direct call has been explicitly covered, but other interface arrangements of X.21 *bis* and X.20 *bis* are not precluded;
- for X.21 *bis*, the half-duplex mode of operation is for further study.

This applies to all the cases listed above, where at least one X.21 *bis* or X.20 *bis* terminal is involved. Alignment with the interworking functions may be necessary when the relevant Recommendations are available.

2 Within the interworking cases 1-17 mentioned above, the functions provided by TA X.21 *bis*, TA X.20 *bis* and the functions provided by TA V.110 should be compatible.

2 Terminal adaption functions

The terminal adaption functions to support X.21, X.21 *bis* and/or X.20 *bis* based DTEs can be subdivided into three areas, namely:

- rate adaption functions;
- X.21/Q.931 mapping functions for call control;
- ready for data alignment.

Some Administrations may provide separate TAs either for each Recommendation X.1 user class of service or for a group of user classes of service. Other Administrations may provide a universal TA for all user classes of service 3 to 7 or 19 or 1, 2, 14, 15, 16, 17 and 18.

2.1 Terminal adaption functions for DTEs conforming to X.1 user classes of service 3 to 6

2.1.1 Rate adaption functions

2.1.1.1 General approach

The rate adaption functions within the TA are shown in Figure 2-1. The function RA1 adapts the X.1 user rate to the next higher rate expressed by 2^k times 8 kbit/s (where $k = 0$ or 1). RA2 performs a second conversion to 64 kbit/s.

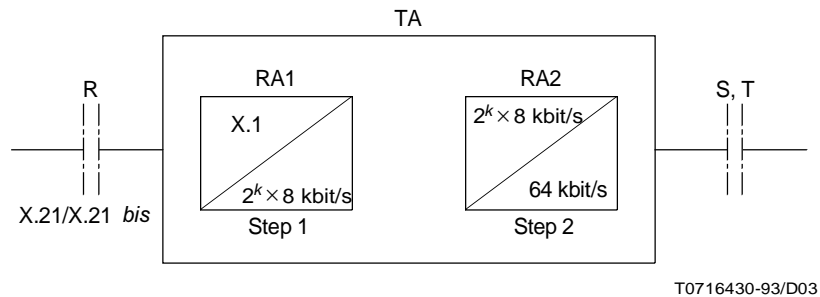

FIGURE 2-1/X.30

2.1.1.2 First step of rate adaption (RA1) of X.1 rates to the intermediate rates of 8/16 kbit/s

2.1.1.2.1 Frame structure

The conversion of the X.1 rates for user classes 3, 4 and 5 to 8 kbit/s, and for user class of service 6 to 16 kbit/s, shall be implemented by means of the 40 bit frame structure shown in Figure 2-2.

		Bit number							
		1	2	3	4	5	6	7	8
Octet 0	Odd frames –	0	0	0	0	0	0	0	0
	Even frames –	1	E1	E2	E3	E4	E5	E6	E7
Octet 1		1	P1	P2	P3	P4	P5	P6	SQ
Octet 2		1	P7	P8	Q1	Q2	Q3	Q4	X
Octet 3		1	Q5	Q6	Q7	Q8	R1	R2	SR
Octet 4		1	R3	R4	R5	R6	R7	R8	SP

FIGURE 2-2/X.30

Figure 2-2 shows that, in addition to the basic frame, a two frame multiframe is employed. In odd frames, octet 0 contains all zeros, whilst in even frames octet 0 consists of a one followed by seven E bits (see 2.1.1.2.4). The order of bit transmission of the 40 bit frame is from left-to-right and from top-to-bottom.

2.1.1.2.2 Frame synchronization

The 17 bit frame alignment pattern consists of all 8 bits (set to zero) of octet 0 in odd frames and bit 1 (set to 1) of the following consecutive 9 octets of the 80 bit long multiframe (see also 2.1.1.4.2). The first bit of octet 0 alternates between one and zero in consecutive frames and therefore provides a multiframe synchronization bit.

2.1.1.2.3 Status bits SP, SQ, SR and X

The bits SP, SQ, SR and X are used to convey channel associated status information. The mapping of the information on circuit C of the X.21 interface to the S bits and the circuit I in the distant interface should be done in such a way that the SP, SQ and SR bits are associated with the bit groups P, Q and R. To assure proper and secure operation the mapping scheme has to be consistent with Recommendations X.21 and X.24.

The mechanism for mapping is as follows:

- In all cases where X.21 byte timing interchange circuit B is not provided, the status bits SP, SQ and SR of the bit groups P, Q and R are evaluated by sampling the C lead in the middle of the 8th bit of the respective preceding bit group. On the other hand, the conditions of the status bits SP, SQ and SR are adopted by the I lead beginning with the transition of the respective 8th bit of a bit group R, P and Q to the 1st bit of the consecutive bit group P, Q and R on the R lead (see Figure 2-3).
- In the case where X.21-byte timing interchange circuit B is provided for character alignment, circuit C is sampled together with the bit 8 of the preceding character and circuit I is changing its state at the boundaries between old and new characters at circuit R. This operation is defined in Recommendation X.24.

2.1.1.2.4 Additional signalling capacity (E bits)

The E bits provide the additional signalling capacity for the conveyance of information relating to the user rate. The coding of these bits is shown in Table 2-1.

2.1.1.2.5 Data bits

Data is conveyed in P, Q and R bits, i.e. 24 bits per frame.

2.1.1.2.6 Repetition strategy

For the adaption of user rates 600, 2400, 4800 bit/s to the 8 kbit/s intermediate rate and of the 9600 bit/s user rate to the 16 kbit/s intermediate rate, the sequence of even and odd octet 0 shall be maintained as defined in Figure 2-4. In order to achieve both short frame synchronization as well as short transfer delay times, a user-bit-repetition method is proposed. Figures 2-4a and 2-4b contain a scheme for the adaption of the 600 bit/s user rate and of the 2400 bit/s user rate respectively into the 8 kbit/s bearer rate. Figures 2-4c and 2-4d show the adaption of the 4800 bit/s user rate to the 8 kbit/s bearer rate and of the 9600 bit/s user rate to the 16 kbit/s bearer rate.

In the case of a 600 bit/s user rate, an explicit frame group synchronization pattern using bit E7 is provided to ensure preservation of user octet boundaries and associated status bit. The coding for the E7 bit shall be as follows:

... 1110111011101 ...

where the value 0 is marking the last 40 bit frame of each 8×40 bit frame group which contains three integer user octets.

2.1.1.3 Second step of rate adaption (RA2)

As rate adaption of a single substream (8/16 kbit/s) to 64 kbit/s and multiplexing of several substreams to 64 kbit/s have to be compatible to enable interworking, a common approach is needed for second step rate adaption and for subchannel multiplexing. It is described in Recommendation I.460.

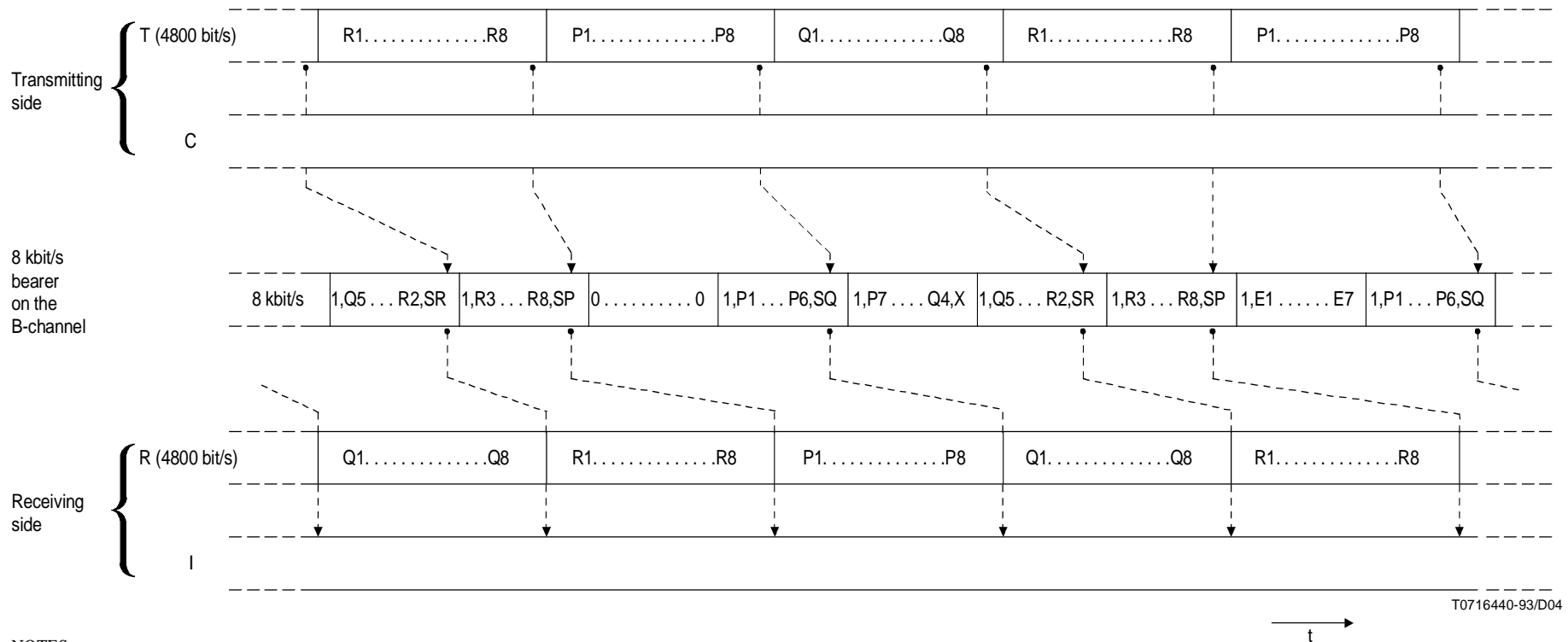

NOTES

- 1 According to Recommendation X.21 the provision of the byte timing interchange circuit B is not mandatory.
- 2 The status bits may be used to transfer, during the data transfer phase, information for half-duplex operation between TA X.21bis and TA X.21 or TA X.21 bis (i.e. mapping of the condition of the C lead of the TA X.21, of the 105 lead of the TA X.21 bis, to the condition on the 109 lead of the remote TA X.21bis, and mapping of the condition of the 105 lead of the TA X.21bis to the condition of the I lead on the remote TA X.21).
- 3 For bits SP, SQ, SR and X, a ZERO corresponds to the ON condition, a ONE to the OFF condition.
- 4 The S and X bits are also used for other purposes, e.g. for synchronization of entry to and exit from the data transfer state, see 2.1.2.3/V.110.

FIGURE 2-3/X.30
Mapping of status-information to the bit stream

TABLE 2-1/X.30

User rate (bit/s)	E1	E2	E3	E4	E5	E6	E7
600	1	0	0	X	X	X	0 or 1 (Note 1)
2400	1	1	0	X	X	X	X
4800	0	1	1	X	X	X	X
9600	0	1	1	X	X	X	X

X indicates spare bits which are reserved for future use and should be set to 1.

NOTES

- 1 For the 600 bit/s user rate E7 is coded to enable the 8×40 bit frame group synchronization. To this aim, E7 in those 40 bit frames which terminate a frame group are set to zero (see 2.1.1.2.6 and Figure 2-4a).
- 2 Different user rates with the same coding are distinct by different intermediate rates.
- 3 The coding of the user rates provides also for user rates specified for the TA recommended in Recommendation V.110.
- 4 It should be noted that bits E4 to E6 may be used in Recommendation V.110 for the transport of network independent clocking information.
- 5 Asynchronous rate information must be determined by the use of Q.931 signalling. Synchronous rate information may be determined by the use of E1, E2, E3 bit in conjunction with the intermediate rate.

2.1.1.4 Framing/reframing method and user rate identification

For framing/reframing and user rate identification the following strategies shall be applied.

2.1.1.4.1 Search for frame alignment

The following 17 bit alignment pattern is searched for:

```

00000000 1XXXXXXXX 1XXXXXXXX 1XXXXXXXX 1XXXXXXXX
1XXXXXXXX 1XXXXXXXX 1XXXXXXXX 1XXXXXXXX 1XXXXXXXX

```

No errors shall be tolerated in the defined bit positions (i.e. all bit positions excluding those denoted by “X”).

To ensure a reliable synchronization, it is suggested that at least two 17 bit alignment patterns in consecutive frames be detected.

In the case of X.1 user class of service 3 (600 bit/s), a further search for the frame group synchronization pattern contained in bit position E7 shall be performed.

2.1.1.4.2 Alignment monitoring/recovery

The monitoring of the alignment shall be a continuous process using the same procedures as for initial detection.

Loss of alignment is assumed following the detection of three consecutive multiframes each with at least one alignment bit error.

Following a loss of alignment the TA shall enter a recovery state, which is indicated at the X.21 interface by $r = 1$ and $i = ON$. In the transmitted frame, bit X shall be set to OFF.

If the recovery of alignment is achieved, r and i present again the data and the status information respectively from the received frames. Bit X in the transmitted frames must be in the ON condition.

If the recovery of alignment is not achieved within a fixed period, the TA shall indicate “DCE not ready” (state 22) by signalling $r = 0$, $i = OFF$. The duration of this period is network dependent (as in 2.6.2/X.21). In case of a circuit-switched service this leads to a clearing of the connection.

In the case of a X.21 *bis* TA, the signalling procedure in 4/V.110 should be used.

0	0	0	0	0	0	0	0
1	P1	P1	P1	P1	P1	P1	SP
1	P1	P1	P2	P2	P2	P2	X
1	P2	P2	P2	P2	P3	P3	SP
1	P3	P3	P3	P3	P3	P3	SP
1	1	0	0	E4	E5	E6	1
1	P4	P4	P4	P4	P4	P4	SP
1	P4	P4	P5	P5	P5	P5	X
1	P5	P5	P5	P5	P6	P6	SP
1	P6	P6	P6	P6	P6	P6	SP
0	0	0	0	0	0	0	0
1	P7	P7	P7	P7	P7	P7	SP
1	P7	P7	P8	P8	P8	P8	X
1	P8	P8	P8	P8	Q1	Q1	SQ
1	Q1	Q1	Q1	Q1	Q1	Q1	SQ
1	1	0	0	E4	E5	E6	1
1	Q2	Q2	Q2	Q2	Q2	Q2	SQ
1	Q2	Q2	Q3	Q3	Q3	Q3	X
1	Q3	Q3	Q3	Q3	Q4	Q4	SQ
1	Q4	Q4	Q4	Q4	Q4	Q4	SQ
0	0	0	0	0	0	0	0
1	Q5	Q5	Q5	Q5	Q5	Q5	SQ
1	Q5	Q5	Q6	Q6	Q6	Q6	X
1	Q6	Q6	Q6	Q6	Q7	Q7	SQ
1	Q7	Q7	Q7	Q7	Q7	Q7	SQ
1	1	0	0	E4	E5	E6	1
1	Q8	Q8	Q8	Q8	Q8	Q8	SR
1	Q8	Q8	R1	R1	R1	R1	X
1	R1	R1	R1	R1	R2	R2	SR
1	R2	R2	R2	R2	R2	R2	SR
0	0	0	0	0	0	0	0
1	R3	R3	R3	R3	R3	R3	SR
1	R3	R3	R4	R4	R4	R4	X
1	R4	R4	R4	R4	R5	R5	SR
1	R5	R5	R5	R5	R5	R5	SR
1	1	0	0	E4	E5	E6	0
1	R6	R6	R6	R6	R6	R6	SR
1	R6	R6	R7	R7	R7	R7	X
1	R7	R7	R7	R7	R8	R8	SR
1	R8	R8	R8	R8	R8	R8	SP

FIGURE 2-4a/X.30

Adaption of the 600 bit/s user rate to the 8 kbit/s bearer rate

0	0	0	0	0	0	0	0
1	P1	P1	P2	P2	P3	P3	SP
1	P4	P4	P5	P5	P6	P6	X
1	P7	P7	P8	P8	Q1	Q1	SQ
1	Q2	Q2	Q3	Q3	Q4	Q4	SQ
1	1	1	0	E4	E5	E6	E7
1	Q5	Q5	Q6	Q6	Q7	Q7	SR
1	Q8	Q8	R1	R1	R2	R2	X
1	R3	R3	R4	R4	R5	R5	SR
1	R6	R6	R7	R7	R8	R8	SP

FIGURE 2-4b/X.30

Adaption of the 2400 bit/s user rate to the 8 kbit/s bearer rate

0	0	0	0	0	0	0	0
1	P1	P2	P3	P4	P5	P6	SQ
1	P7	P8	Q1	Q2	Q3	Q4	X
1	Q5	Q6	Q7	Q8	R1	R2	SR
1	R3	R4	R5	R6	R7	R8	SP
1	0	1	1	E4	E5	E6	E7
1	P1	P2	P3	P4	P5	P6	SQ
1	P7	P8	Q1	Q2	Q3	Q4	X
1	Q5	Q6	Q7	Q8	R1	R2	SR
1	R3	R4	R5	R6	R7	R8	SP

FIGURE 2-4c/X.30

Adaption of the 4800 bit/s user rate to the 8 kbit/s bearer rate

0	0	0	0	0	0	0	0
1	P1	P2	P3	P4	P5	P6	SQ
1	P7	P8	Q1	Q2	Q3	Q4	X
1	Q5	Q6	Q7	Q8	R1	R2	SR
1	R3	R4	R5	R6	R7	R8	SP
1	0	1	1	E4	E5	E6	E7
1	P1	P2	P3	P4	P5	P6	SQ
1	P7	P8	Q1	Q2	Q3	Q4	X
1	Q5	Q6	Q7	Q8	R1	R2	SR
1	R3	R4	R5	R6	R7	R8	SP

FIGURE 2-4d/X.30

Adaption of the 9600 bit/s user rate to the 16 kbit/s bearer rate

2.1.1.4.3 Identification of intermediate bit rate

As a basic approach the intermediate bit rate is derived from the X.1 user rate contained in the Q.931 SETUP message.

As an alternative solution the intermediate bit rate may optionally be identified by relying solely on B-channel information (see Appendix II).

2.1.2 X.21/X.21 bis to Q.931 protocol mapping

The D-channel signalling capabilities of the ISDN-customer-access as defined in Recommendation Q.931 have to include the requirements arising from the mapping of the X.21 and X.21 *bis* interface signalling procedures to the Q.931 protocol at the S/T reference point.

The logical representation of these mapping functions is shown in Figure 2-5.

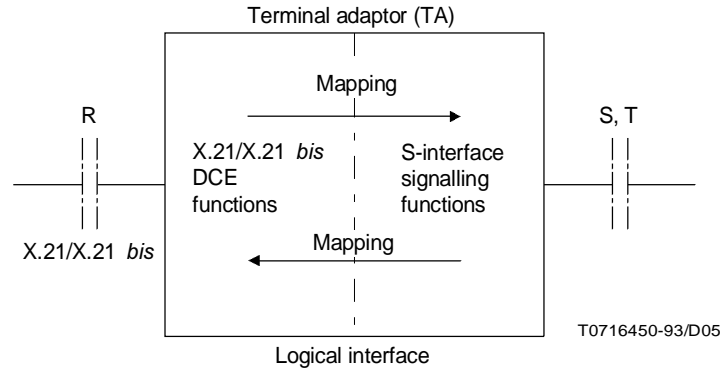

FIGURE 2-5/X.30

The D-channel signalling capabilities provided to X.21 and X.21 *bis* based terminals shall comprise the signalling messages as defined in Recommendation Q.931.

The following description and drawings depict examples of X.21 and X.21 *bis* mapping to the ISDN call control procedures. It is recognized that other possibilities and user options exist but this clause is intended to provide general guidelines on X.21 and X.21 *bis* support. Only the normal call establishment and clearing procedures are shown.

NOTES

1 Annex A contains an SDL description of the mapping of the procedures at the R-reference point to procedures at the S/T reference point and vice versa. However, the TA internal processes and states contained in the SDL diagrams are understood not to be binding for implementation.

2 Manual direct or address calls and manual disconnection from the TA should also be possible through the mapping of standard DTE/TA interface procedures with manual operations at the TA. In addition, automatic address calls may also be possible by the DTE employing a V.25 interface between the DTE and TA.

2.1.2.1 Q.931/X.21 mapping (see Figures 2-6 and 2-7)

The following clauses are titled with the names of the Q.931 signalling messages at the S/T reference point.

2.1.2.1.1 SETUP (from TA)

In ready state (state 1) both DTE and TA transmit $r = 1$, $i = \text{OFF}$ via the X.21 interface.

When the calling DTE indicates a call request (state 2, $r = 0$, $i = \text{ON}$) at the X.21 interface, the TA transmits a proceed to select signal to the DTE (state 3, $r = +$, $i = \text{OFF}$). The DTE begins to send selection signals to the TA (state 4, $r = +$, $i = \text{OFF}$).

When an end of selection signal ($r = +$, $i = \text{ON}$) is received at the X.21 interface, the TA transmits a SETUP message via the D-channel at the S/T reference point.

The Bearer capability information element included in the SETUP message shall be coded with:

- information transfer capability set to either:
 - a) “unrestricted digital information”; or
 - b) “restricted digital information”;
- transfer mode set to “circuit mode”;
- information transfer rate set to “64 kbit/s”.

NOTE – Bearer capability information element octets 4a and 4b shall not be included.

The user may also specify the layer 1 (e.g. rate adaption), layer 2 (e.g. LAPB) and layer 3 (e.g. X.25) information transfer protocols in the Low layer compatibility information element in the SETUP message. (See Q.931, Annex entitled, “Low layer information coding principles”).

The Called party address information element shall be encoded en-block, i.e. with the complete address of the called party as received from the X.21 interface.

Afterwards, the state DCE waiting (state 6A, $r = \text{SYN}$, $i = \text{OFF}$) is entered at the X.21 interface.

2.1.2.1.2 SETUP ACKNOWLEDGE/CALL PROCEEDING (from ET)

The network reaction on the SETUP message received from the TA can be either:

- a) sending of a CALL PROCEEDING message to the TA; when the CALL PROCEEDING message is received on the D-channel at the S/T reference point, the B-channel will be allocated and the TA transmits $r = 1$, $i = \text{OFF}$ (within 80 bit multiframes in the case of user classes 3-6) via the B-channel at the S/T reference point; or
- b) sending of a SETUP ACKNOWLEDGE message to the TA; when the SETUP ACKNOWLEDGE message is received on the D-channel at the S/T reference point, the B-channel will be allocated and the TA transmits 1, OFF (within 80 bit multiframes in the case of user classes 3-6) via the B channel at the S/T reference point.

In this case subsequent reception of CALL PROCEEDING does not entail any further actions in the TA.

2.1.2.1.3 ALERTING (from ET)

ALERTING message is only used with manual answering.

When an ALERTING message is received on the D-channel at the S/T reference point, the TA transmits the call progress signal (state 7, $r = \text{IA5}$, $i = \text{OFF}$) to the calling DTE.

Afterwards the state DCE waiting (state 6A, $r = \text{SYN}$, $i = \text{OFF}$) is entered at the X.21 interface.

2.1.2.1.4 CONNECT (from ET)

When a CONNECT is received on the D-channel at the S/T reference point, the TA transmits any DCE provided information (state 10, $r = \text{IA5}$, $i = \text{OFF}$) to the calling DTE. Afterwards the state connection in progress (state 11) is entered at the X.21 interface.

When the frame alignment pattern of the 80 bit multiframe (in the case of Recommendation X.1 user classes 3-6) is received on the B-channel at the S/T reference point, the TA performs switch-through.

When the calling DTE receives (1, ON) via the through-connected B-channel at the X.21 interface, the calling DTE enters the state ready for data (state 12) and data transfer (state 13) can begin.

2.1.2.1.5 SETUP (from ET)

The TA shall not accept a SETUP message unless the X.21 interface is in the ready state (state 1). When a SETUP message is received on the D-channel at the S/T reference point, the TA shall follow the procedures for determining compatibility checking (e.g. data signalling rate) found in Recommendation Q.931. If the TA determines that it can respond to the incoming call, it follows the procedures of Recommendation Q.931. It is expected that ALERTING message would only be used with terminals that answer manually.

The TA transmits an incoming call (r = BEL, i = OFF) via the X.21 interface to the called DTE, and the incoming call state (state 8, r = BEL, i = OFF) entered.

Call offering procedure in a multiterminal configuration is described in 2.1.3.

2.1.2.1.6 CONNECT (from TA)

When a call accepted (state 9, t = 1, c = ON) is received from the called DTE, the TA transmits a CONNECT message via the D-channel of the S-interface.

2.1.2.1.7 CONNECT ACKNOWLEDGE (from ET)

When a CONNECT ACKNOWLEDGE message is received on the D-channel at the reference point, the TA, selected by this message, transmits 1/OFF via the allocated B-channel and signals connection in progress (state 11, r = 1, i = OFF) to the DTE after delivering DCE provided information if any.

The TA performs switch-through after the frame alignment pattern (80 bit multiframe in the case of user classes 3-6) has been received via the B-channel at the S/T reference point.

When the called DTE receives 1, ON via the switched through B-channel on the X.21 interface, the ready for data state (state 12, r = 1, i = ON) is entered and data transfer (state 13, r = D, i = ON) can begin.

2.1.2.1.8 RELEASE (from ET)

In the case of a multiterminal configuration, the exchange termination sends a RELEASE message to each TA that had signalled CALL PROCEEDING, ALERTING or CONNECT but which was not selected for the call. Subsequently the TA performs the DCE clear indication procedure at the X.21 interface and sends a RELEASE COMPLETE message to the exchange.

2.1.2.1.9 DISCONNECT (from TA)

A DTE clear request (state 16, t = 0, c = OFF) is transmitted via the B-channel from the clearing to the cleared DTE.

The TA at the clearing DTE recognizes the state 16 at the X.21-interface, separates the R- and I-leads from the B-channel and transmits a DCE clear confirmation (state 17, = 0, OFF) to the clearing DTE. It transmits also a DISCONNECT message via the D-channel of the S/T reference point (see Figure 2-6).

After reception of the RELEASE message on the D-channel, the TA tears down the B-channel, sends RELEASE COMPLETE to the exchange, transmits DCE ready (r = 1, i = OFF) to the DTE, and the DTE enters the state DTE ready (state 1, t = 1, c = OFF).

2.1.2.1.10 DISCONNECT (between TA)

When the DTE initiates DTE clear request (t = 0, c = OFF) this status is transmitted in slot within the B-channel and received as DCE clear indication (r = 0, i = OFF) in the DTE (see Figure 2-7).

The TA recognizes the clear request received in slot via the B-channel at the S/T reference point, separates the R- and I-leads from the B-channel and transmits a DCE clear indication (state 19, = 0, OFF) to the DTE to be cleared.

After the TA to be cleared has received DTE clear confirmation (t = 0, c = OFF) from the DTE, it transmits the DISCONNECT message via the D-channel, and clears the B-channel.

After reception of a RELEASE message on the D-channel, the TA releases the call reference, sends RELEASE COMPLETE message to the exchange, transmits DCE ready (state 2, r = 1, i = OFF) to the DTE, and the DTE enters the state DTE ready (t = 1, c = OFF).

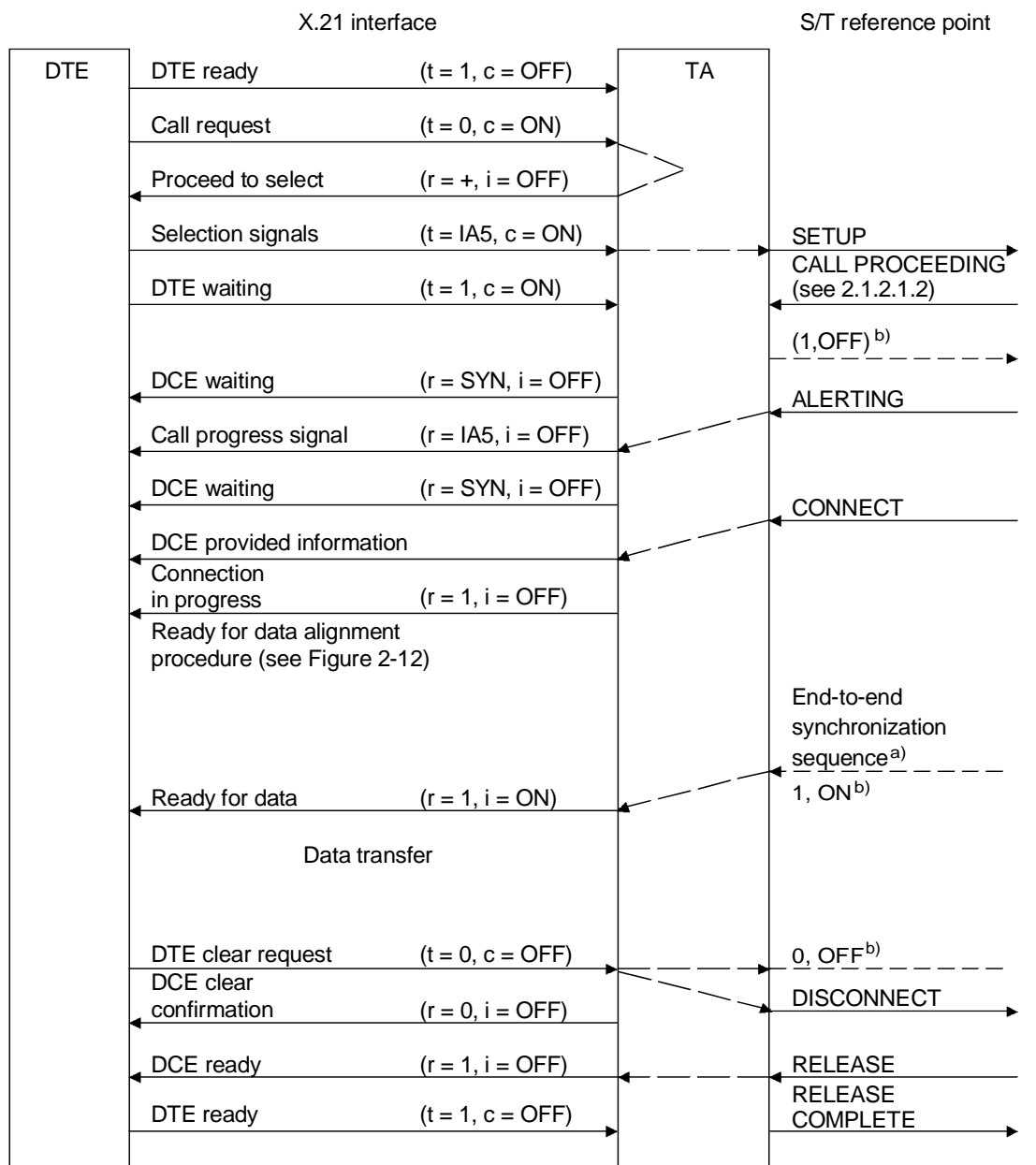

T0716460-93/D06

————— D-channel } at S/T reference point
 - - - - - B-channel }

^{a)} For user class 19, see Figure 2-13.

^{b)} Not applicable for user class 19.

NOTE – The case of outgoing/incoming call collision is described in 2.1.6.

FIGURE 2-6/X.30
X.21 – Example of DTE call establishment and clearing

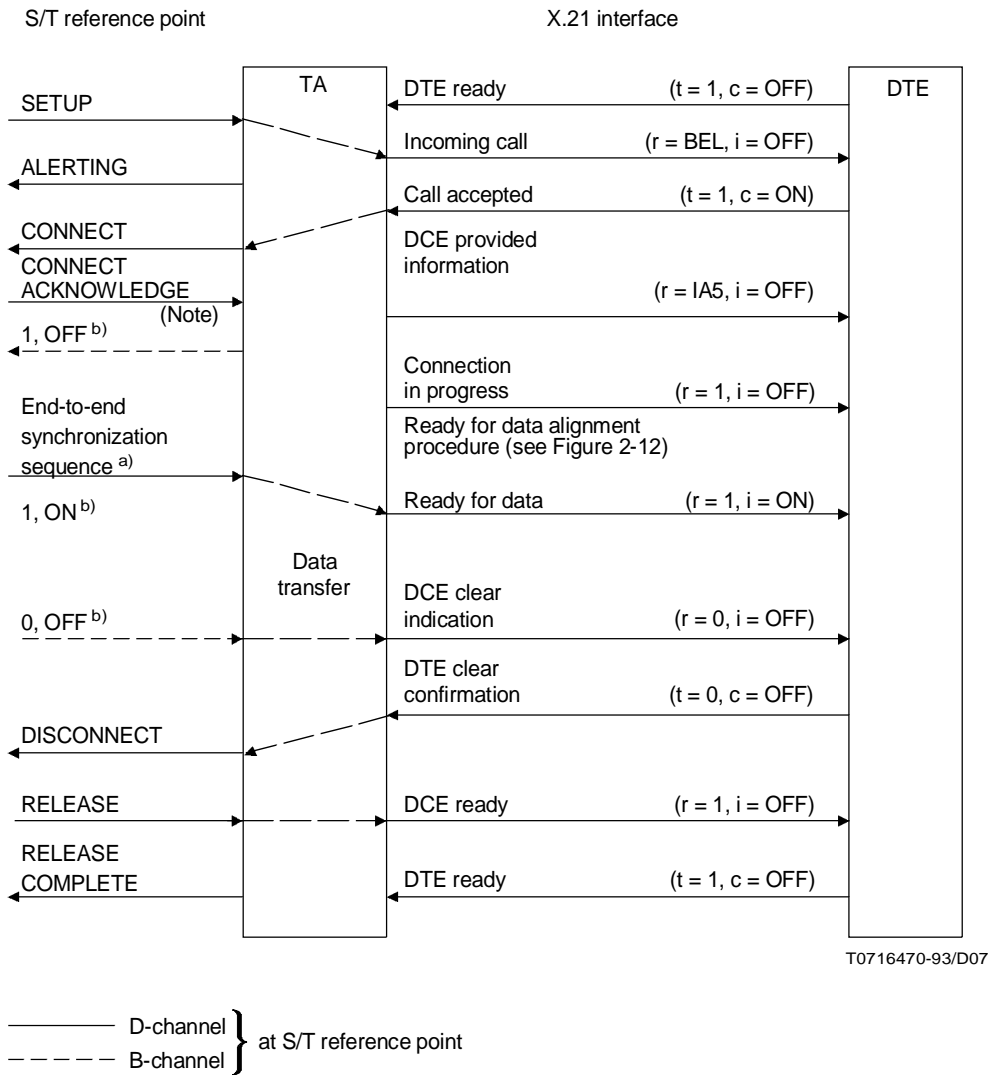

- a) For user class 19, see Figure 2-13.
 b) Not applicable for user class 19.

NOTE – In the case of a multi-terminal configuration, the exchange sends a RELEASE message to each TA that had signalled CALL PROCEEDING, ALERTING or CONNECT, but which was not selected for the call.

FIGURE 2-7/X.30
X.21 – Example of DTE call which is established and cleared

2.1.2.1.11 DISCONNECT (from ET)

In the case of clearing by the network, the local exchange transmits the DISCONNECT message via the D-channel to the terminal which has to be cleared. After reception of the DISCONNECT message in the TA, the TA transmits a RELEASE message on the D-channel to the exchange.

If the X.21 interface is in the call establishment phase and has not yet reached state 11 or 12, and if the DISCONNECT message contains the reasons for clearing, the TA moves to state 7 and transmits the corresponding call progress signal prior to signalling the DCE clear indication (see 2.1.5).

Otherwise the TA transmits the state $r = 0, i = \text{OFF}$ (DCE clear indication) via the X.21 interface to the DTE, which sends back to the TA the state $t = 0, c = \text{OFF}$ (DTE clear confirmation).

The procedure described above is not shown in the Figures 2-6 and 2-7.

2.1.2.1.12 RELEASE COMPLETE (from ET)

When the RELEASE COMPLETE message is received via the D-channel at the S/T reference point in the TA of the cleared DTE, the DCE ready state (state 21, = 1, OFF) and the DTE ready state (state 1, = 1, OFF) are entered.

2.1.2.2 X.21 bis (direct call)

See Figures 2-8 and 2-9.

NOTE – The Figures 2-8 and 2-9 depict some examples of X.21 bis support. Only the conditions on principal interchange circuits have been shown and options such as the use of circuits 105/109, 108.2, etc., have not been included. X.21 bis/Q.931 mapping is for further study. For operational sequences of the interface at reference point R and end-to-end TA signalling, see 4/V.110.

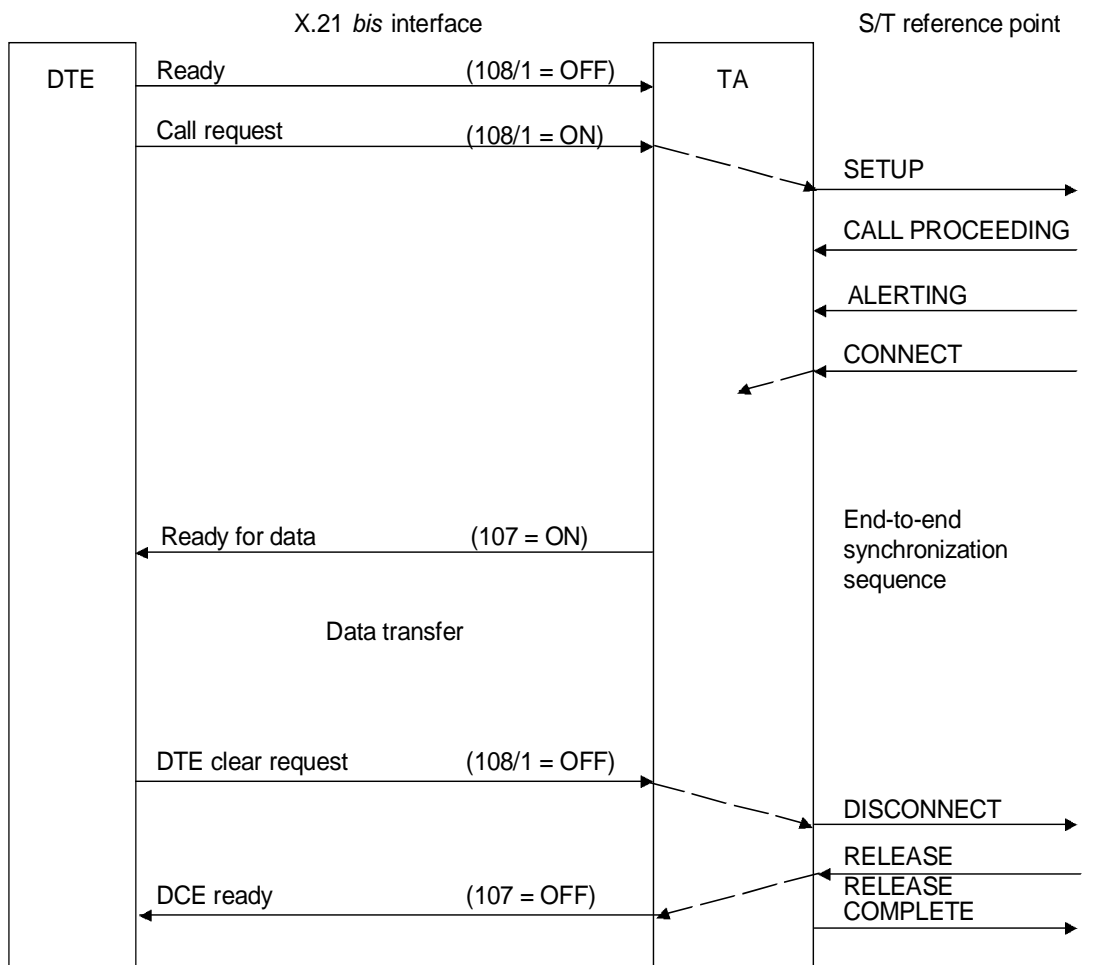

T0716480-93/D08

FIGURE 2-8/X.30

X.21 bis – Example of DTE call establishment and clearing

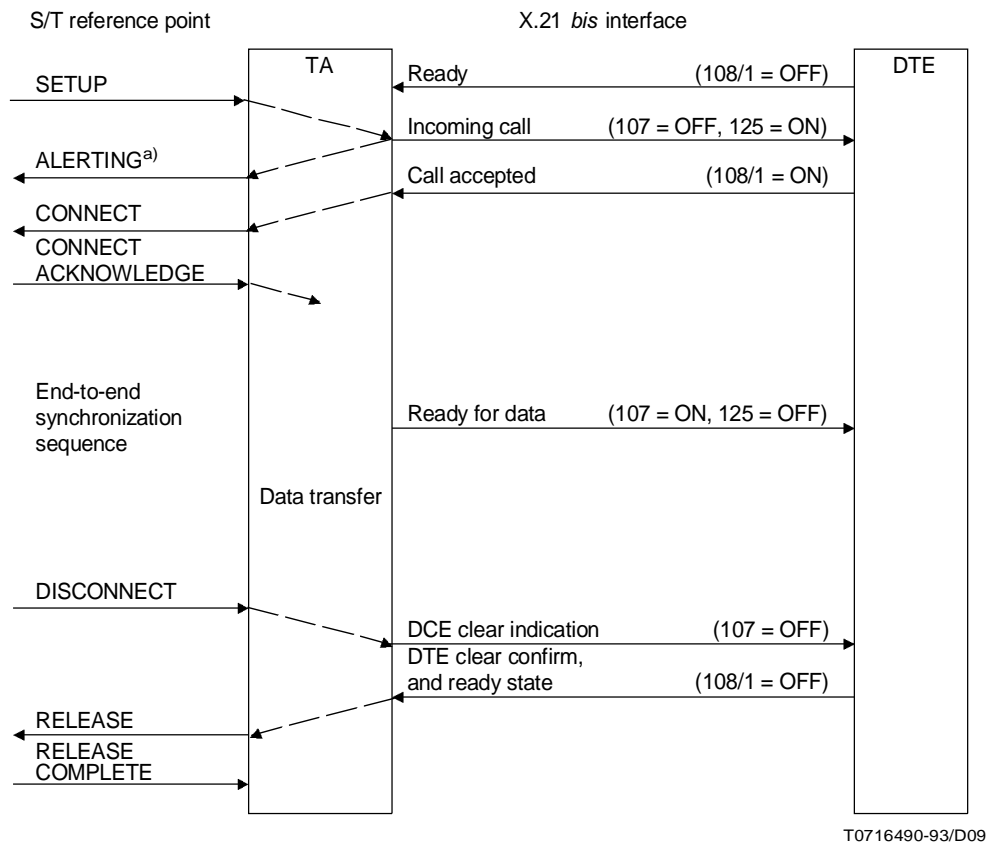

FIGURE 2-9/X.30

X.21 bis – Example of DTE call which is established and cleared

2.1.3 Call offering procedure in a multiterminal configuration

For a call offering procedure in a multiterminal configuration, the following general description applies (see also Figure 2-10).

In case of a multiterminal configuration, an incoming call (SETUP message containing appropriate service indication information) is offered according to Recommendation Q.931.

When a SETUP message is received on the D-channel of the S/T reference point the TA shall follow the procedures for determining compatibility checking (e.g. data signalling rate) found in Recommendation Q.931. If the TA determines that it can respond to the incoming call, it follows the procedures of Recommendation Q.931. It is expected that the ALERTING message would only be used by terminals that answer manually.

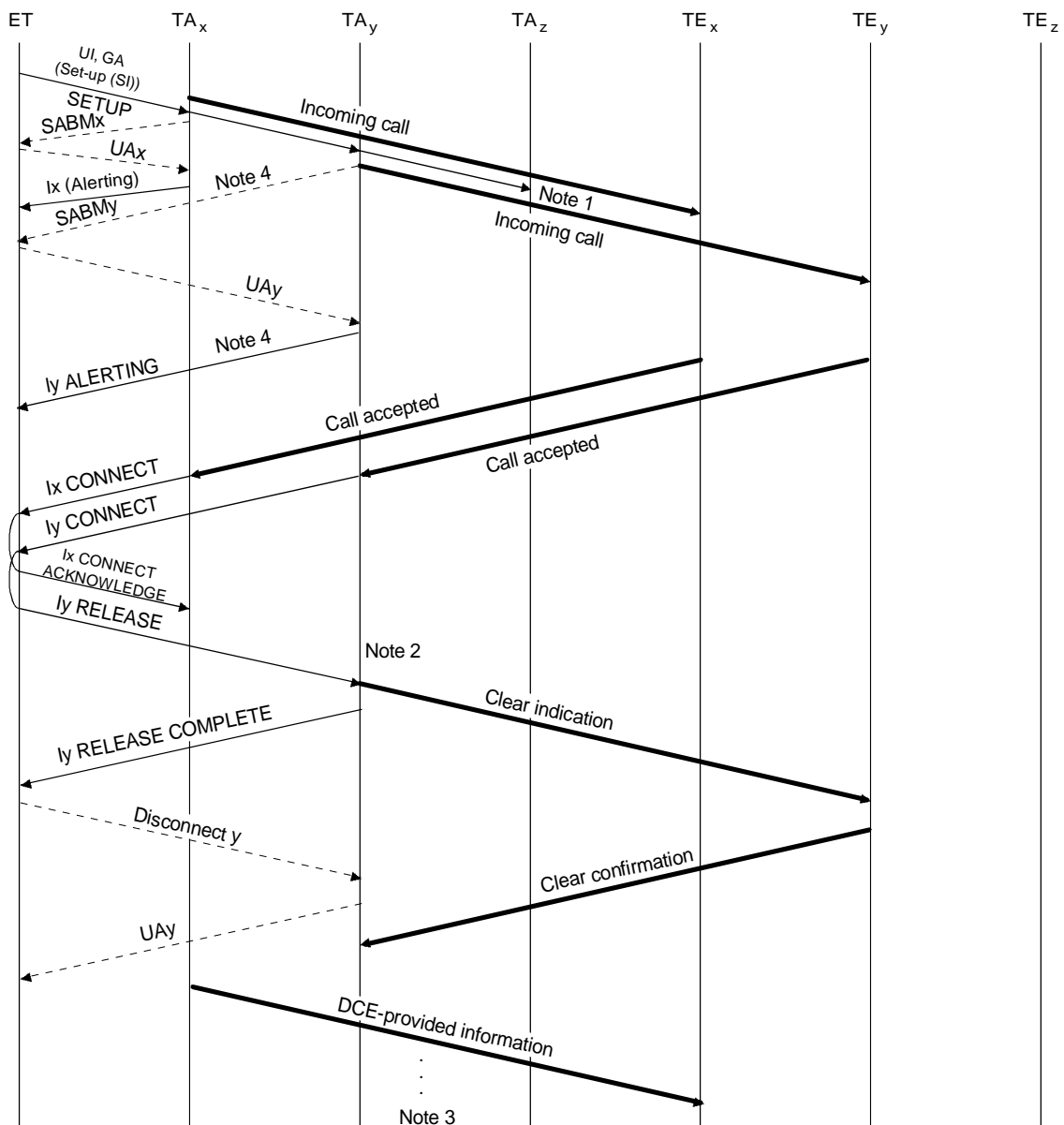

T0716500-93/D10

----- D-channel protocol (layer 2): LAP-D

————— D-channel protocol (layer 3)

————— X.21

GA Global address

NOTES

- 1 TA_z does not respond to the SETUP message because it is supporting a terminal which is not compatible with the calling terminal. However, TA_z may alternatively respond with a RELEASE COMPLETE message with the cause "incompatible destination" (# 88).
- 2 The TAs which had sent an ALERTING or CONNECT message but were not selected for the call by the exchange are notified by a RELEASE message.
- 3 For further mapping of X.21 to D-channel protocol refer to Figure 2-7.
- 4 ALERTING messages are only used for the manual answering case.

FIGURE 2-10/X.30

Call offering procedure in a multiterminal configuration (example)

If the TA supports a compatible terminal, but cannot accept the call, because the terminal is not in the ready state, a RELEASE COMPLETE message has to be returned by the TA (see Figure 2-11). If the state of the terminal is:

- a) controlled not ready, then the RELEASE COMPLETE message has cause 21, "call rejected";
- b) uncontrolled not ready, then the RELEASE COMPLETE message has cause 27, "destination out of order";
- c) busy, then the RELEASE COMPLETE message has cause 17, "user busy".

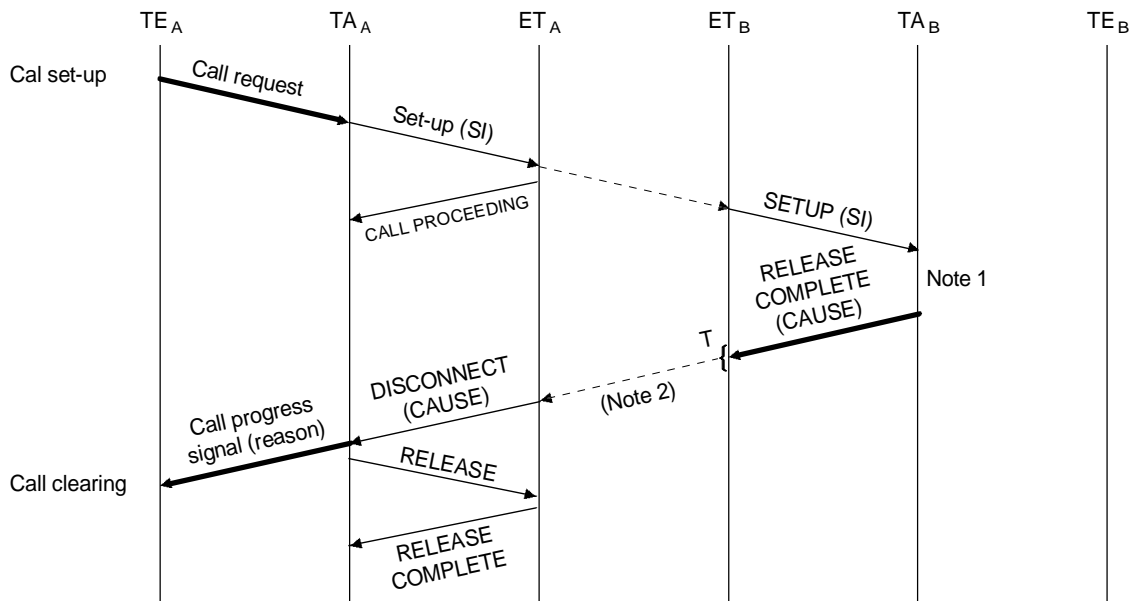

T0716510-93/D11

———— D-channel protocol (layer 3)

———— X.21

NOTES

1 RELEASE COMPLETE message including the appropriate case code, is sent by a TA supporting a terminal which is compatible with information contained in the SETUP message, to indicate that the call cannot be accepted at this time for the following reasons: controlled not ready, uncontrolled not ready, busy condition of the called terminal, etc. ET_B will follow the procedures of Recommendation Q.931, giving priority to causes as follows (as defined in Q.931):

- 1) cause # 17, "user busy";
- 2) cause # 21, "call rejected";
- 3) any other cause.

FIGURE 2-11/X.30

Negative response to incoming call (example)

This message is forwarded to the calling side to provide the appropriate X.21 call progress signals. Its mapping in the calling TA is described in 2.1.5.

If more than one TA has responded, the message to be forwarded, including the cause to be indicated, is derived according to the priority rules of Recommendation Q.931.

In case several TAs have accepted the incoming call by returning a CONNECT message, the TA selected by the network receives the CONNECT ACKNOWLEDGE message. The TAs not selected for the call are cleared by the network by means of a RELEASE message

In a multiterminal configuration, a number of terminals and terminal adaptors can be contending for access to the D-channel. The contention resolution mechanism may result in delays of the outgoing signalling messages and could therefore affect the call set-up time. Call failure information transmission to the calling side may be delayed also by the priority rule procedure mentioned above.

2.1.4 Ready for data alignment

The task of synchronizing the entry to and exit from the data transfer phase between two subscriber terminals shall be performed by the terminal adaptors and subscriber terminals. For this purpose the X.21 procedure with inslot handshaking shall be used.

Two cases exist, one where the called TA supports only one data user rate and the other where the called TA will adapt to the data user rate of the calling TA.

In the following only the case of single rate TA is described.

The functions necessary for multiple rate TA (universal TA) are described in Appendix I.

For a single rate TA a symmetrical procedure is performed (see Figure 2-12).

Both TAs shall check the signal of their receive B-channel for the frame alignment bit pattern.

After frame alignment detection in the B-channel, the TA shall connect the B-channel through to its terminal (DTE) immediately before the C-lead is scanned. From this point onwards the 1/ON condition from the DTE will be transmitted towards the distant DTE. Depending on the state of the distant end, either 1/OFF is received from the distant TA or 1/ON from the distant DTE. Reception of $r = 1, i = \text{OFF}$ denotes the state "connection in progress" (state 11), reception of $r = 1, i = \text{ON}$ denotes the state "ready for data" (state 12).

"Ready for data" (state 12) is signalled to the DTE by the TA only after detection the frame alignment and 1/ON condition from the B-channel.

After switching through the B-channel by the TA, transmission of data and status in the data phase is continued and clearing down can be synchronized between the subscriber terminals by means of clear request.

For ready for data procedures in case of X.21 *bis* and X.20 *bis* interfaces, see 4.1.2/V.110.

2.1.5 Mapping of Q.931 causes to X.21 call progress signals

In several cases it will be necessary to map causes from Q.931 to X.21. The TA shall use Table 2-2 to map the causes from Q.931 messages to X.21 call progress signals.

NOTE – Since one-to-one mapping of Q.931 causes and X.21 call progress signals is not possible in all cases, some of the entries in Table 2-2 may not convey exactly the same meaning.

2.1.6 Additional information for handling of exception situations

When the call is cleared prematurely or a call failure occurs, the rules of 5.8/Q.931 and of Recommendation X.21 apply. The following procedures are derived for the mutual mapping between the R and the S/T reference points.

2.1.6.1 Call collision

Call collision may occur at both sides of the TA, at the X.21 interface and at the S/T reference point.

NOTE – Call collision for the X.21 *bis* and X.20 *bis* interfaces is for further study.

2.1.6.1.1 Call collision at the X.21 interface

The TA shall accept an incoming SETUP message when the X.21 interface is in the READY state.

When at the X.21 interface a call collision is detected (TA sends incoming call, X.21 DTE sends call request) the TA will indicate proceed-to-select and cancel the incoming call.

NOTE – As an alternative the TA may send a DCE clear indication and when in the READY state resend the incoming call.

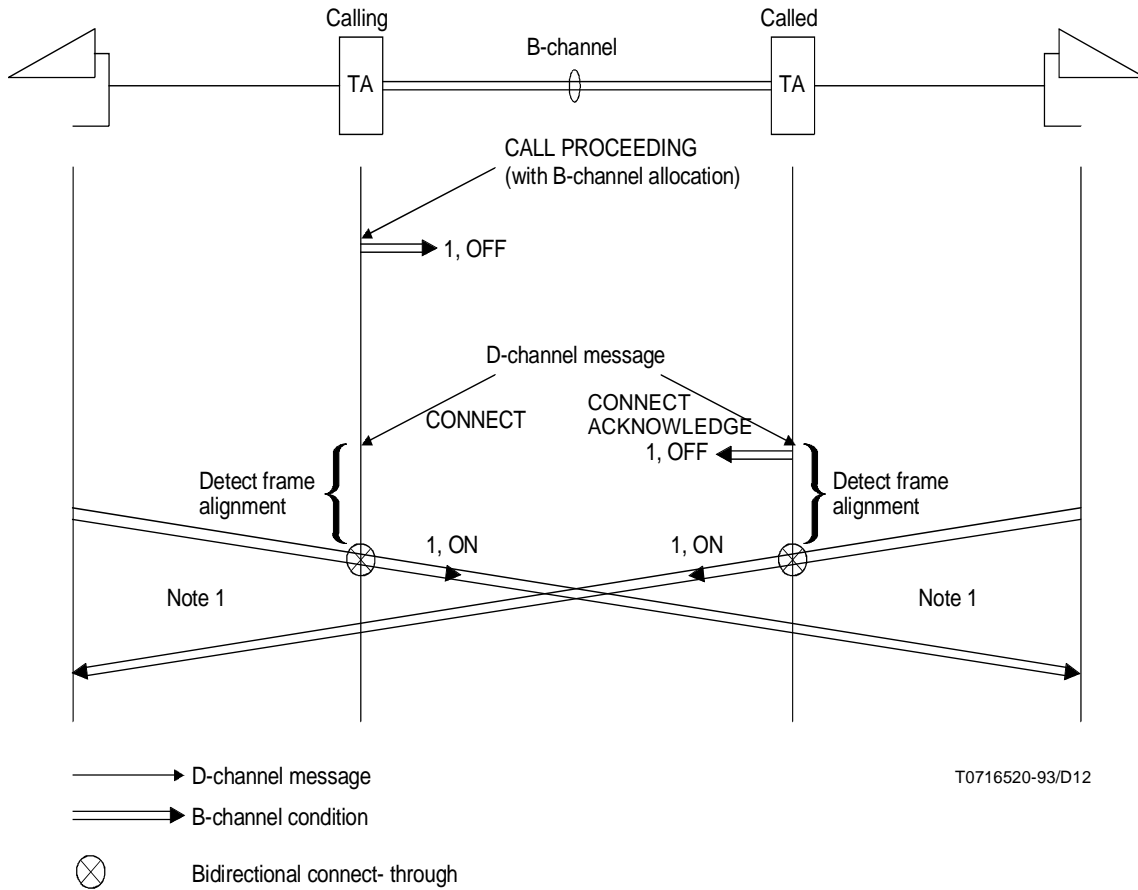

NOTES

- 1 The TA will perform connect-through after detecting frame alignment and completing delivery to the terminal of any DCE-provided information. To guarantee the correct ready for data alignment, through-connection must be performed immediately before the C lead is scanned.
- 2 Only those conditions necessary to effect ready for data alignment are shown.
- 3 The bidirectional switch through in the TA can also be performed in transition of state 12 to 13 in Recommendation X.21, if the TA is transmitting 1, ON during state 12.

FIGURE 2-12/X.30

Single rate TA operation to effect ready for data alignment at rates < 64 kbit/s

TABLE 2-2/X.30

Mapping of Q.931 cause fields to X.21 call progress signals

Item	Q.931 cause	Code	X.21 call progress signal significance	Code
1	Unassigned or unallocated number	1	Not obtainable	43
2	No route to destination	3	Not obtainable	43
3	Channel unacceptable	6	Not obtainable	43
4	Normal clearing	16	Not applicable	
5	User busy	17	Number busy	21
6	No user responding	18	No connection	20
7	User alerting, no answer	19	No connection	20
8	Call rejected	21	Controlled not ready	45
9	Number changed	22	Changed number	42
10	Destination out of order	27	Uncontrolled not ready	46
11	Invalid number format (incomplete number)	28	Selection signals procedure error	22
12	Normal, unspecified	31	Not applicable	
13	No circuit/channel available	34	No connection	20
14	Network out of order	38	Out of order	44
15	Temporary failure	41	Out of order	44
16	Switching equipment congestion	42	Network congestion	61
17	Requested circuit or channel not available	44	No connection	20
18	Resources unavailable, unspecified	47	Network congestion	61
19	Quality of service unavailable	49	Not applicable	
20	Bearer capability not authorized	57	Incompatible user class of service	52
21	Bearer capability not presently available	58	Network congestion	61
22	Service or option not available, unspecified	63	No connection	20
23	Bearer service not implemented	65	Invalid facility request	48
24	Channel type not implemented	66	Invalid facility request	48
25	Service or option not implemented, unspecified	79	Invalid facility request	48
26	Invalid call reference value	81	Not obtainable	43
27	Identified channel does not exist	82	Not obtainable	43
28	Incompatible destination	88	Not obtainable	43
29	Invalid message	95	Selection signal transmission error	23
30	Mandatory information element is missing	96	Selection signal procedure error	22

TABLE 2-2/X.30 (end)

Item	Q.931 cause	Code	X.21 call progress signal significance	Code
31	Message type non existent or not implemented	97	Selection signal procedure error	22
32	Message not compatible with call state, message type non existent or not implemented	98	Selection signal procedure error	22
33	Information element non existent or not implemented	99	Selection signal procedure error	22
34	Invalid information element contents	100	Selection signal transmission error	23
35	Message not compatible with call state	101	Selection signal procedure error	22
36	Recovery on timer expiry	102	Not obtainable	43
37	Protocol error, unspecified	111	Selection signal procedure error	42
38	Interworking, unspecified	127	ROA out of order	72

2.1.6.1.2 Call collision at the S/T reference point

In the event of call collision at the S/T reference point the procedures defined in Q.931 shall apply.

2.1.6.2 No channel available

If no channel including no B-channel at the S/T reference point is available for connection establishment, an outgoing SETUP message is answered from the ET by a RELEASE COMPLETE message with the cause 34 = no channel available. This is mapped at the X.21 interface into the call progress signal 20 = no connection, followed by DCE clear indication.

2.1.6.3 Premature clearing

A DTE may initiate the clearing procedure at any time by transmitting a DTE clear request at the X.21 interface, as described in 2.1.2.1.9. If no connection exists between DTEs, at the distant station, the procedure described in 2.1.2.1.11 will apply.

2.1.6.4 No answer to outgoing SETUP

If an outgoing SETUP is not answered by the ET, the DTE will, after the time-out of timer T2 (20 s), initiate the clearing procedure by transmitting DTE clear request. The TA, in its S/T reference point, will send a RELEASE COMPLETE message (cause code 31: normal, unspecified). On its X.21 interface, it will transmit DCE clear confirmation.

On the other hand, if a TA is provided with the optional timer T303 (Q.931) it may start the clearing procedure at the S/T reference point as above by transmitting RELEASE COMPLETE (cause code 102: recovery on timer expiry). At the X.21 interface, the TA sends the call progress signal 43 = not obtainable, followed by DCE clear indication.

2.2 Terminal adaptation functions for DTEs conforming to X.1 user class of service 7

2.2.1 Rate adaptation functions

For rate adaptation from X.1 user classes of services 3-6 to 64 kbit/s a 40 bit frame has been adopted (see Figure 2-2). Within this frame 24 data bits can be transmitted which may be allocated to three bit groups P, Q and R each bit group containing 8 bits.

An equivalent approach, with the optional possibility of character alignment also for the X.1 user rate of 48 kbit/s, shall be used. To implement this approach an appropriate frame structure for this rate is defined. Table 2-3 shows this frame which contains the octets 1, 2, 3 and 4 (framing of 24 data bits).

Octet alignment is performed by means of the 8 kHz timing.

TABLE 2-3/X.30

	Bit number							
	1	2	3	4	5	6	7	8
Octet 1	1	P1	P2	P3	P4	P5	P6	SQ
Octet 2	0	P7	P8	Q1	Q2	Q3	Q4	X
Octet 3	1	Q5	Q6	Q7	Q8	R1	R2	SR
Octet 4	1	R3	R4	R5	R6	R7	R8	SP

The frame alignment pattern consists of 10111011 in bit 1 of consecutive octets which are received from the 64 kbit/s stream. This frame alignment pattern also will be used for ready for data alignment (see 2.1.4) and for user rate identification (see Appendix II). To ensure a reliable synchronization it is suggested that at least two 8 bit alignment patterns in consecutive frames be detected.

For the user rate identification the following algorithm shall apply (see also Recommendation V.110):

- search for the bit pattern . . . 10111011 . . . in bit 1 of consecutive octets which are received from the 64 kbit/s stream;
- if this search is successful then the user rate is 48 kbit/s.

NOTE – For international interworking over restricted 64 kbit/s bearer capabilities, bit X must be set to 1.

2.2.2 X.21/X.21 bis to D-channel protocol mapping

The X.21/X.21 bis mapping functions are given in 2.1.2.

2.2.3 Call offering procedure in a multiterminal configuration

As per 2.1.3.

2.2.4 Ready for data alignment

As per 2.1.4.

2.2.5 Mapping of Q.931 causes to X.21 call progress signals

As per 2.1.5.

2.2.6 Additional information for handling of exception situations

As per 2.1.6.

2.3 Terminal adaption functions for DTEs conforming to X.1 user class of service 19

2.3.1 Rate adaption functions

It is assumed that in the case of a TA supporting only 64 kbit/s, no rate adaption and no user rate identification is necessary. The procedure in the case of a universal TA is for further study (see Appendix I).

NOTE – It is recognized that the all ones condition could be produced by the alarm indication signal (AIS). The implication of this on D-channel signalling requires further study.

2.3.2 X.21/X.21 bis to D-channel protocol mapping (see Figures 2-6 and 2-7)

The following clauses are titled with the names of the Q.931 signalling messages at the S/T reference point.

2.3.2.1 SETUP (from TA)

In ready state (state 1) both DTE and TA transmit (1, OFF) via the X.21-interface.

When the calling DTE indicates a call request (state 2, $r = 0$, $i = ON$) at the X.21-interface, the TA transmits a proceed to select signal (state 3) to the DTE ($r = +$, $i = OFF$). The DTE begins to send selection signals to the TA (state 4).

When an end of selection ($r = +$, $i = ON$) is received at the R-interface, the TA transmits a SETUP message via the D-channel of the S-interface.

2.3.2.2 CALL PROCEEDING/SETUP ACKNOWLEDGE

When the CALL PROCEEDING or SETUP ACKNOWLEDGE message is received on the D-channel of the S-interface, the B-channel will be allocated and the TA transmits all zeros via the B-channel at the S/T reference point.

2.3.2.3 ALERTING (from ET)

ALERTING is generally used with manual answering.

When an ALERTING message is received on the D-channel of the S-interface, the TA transmits call progress signals (state 7) to the calling DTE.

Afterwards the state DCE waiting (state 6A, $r = SYN$, $i = OFF$) is entered at the X.21-interface.

2.3.2.4 CONNECT (from ET)

When a CONNECT message is received on the D-channel at the S/T reference point, the TA may transmit DCE-provided information (state 10) to the calling DTE. Afterwards the state connection in progress (state 11) is entered at the X.21-interface.

The alignment pattern procedure is entered as described in 2.3.4.1.

2.3.2.5 SETUP (from ET)

The TA shall not accept a SETUP message unless the X.21-interface is in the ready state (state 1).

When a SETUP message is received on the D-channel of the S-interface, the TA shall follow the procedures for determining compatibility checking (e.g. data signalling rate) found in Recommendation Q.931. If the TA determines that it can respond to the incoming call, it follows the procedures of Recommendation Q.931. It is expected that the ALERTING message would only be used by terminals that answer manually.

The TA transmits an incoming call (BEL, OFF) via the X.21-interface to the called DTE, and the incoming call state (state 8) is entered.

In the case of a multiterminal configuration the incoming call point-to-multipoint operation is described in 2.1.3.

2.3.2.6 CONNECT (from TA)

When a call accepted (state 9 = 1, ON) is received from the called DTE, the TA transmits a CONNECT message via the D-channel at the S/T reference point.

2.3.2.7 CONNECT ACKNOWLEDGE (from ET)

When a CONNECT ACKNOWLEDGE message is received on the D-channel of the S reference point the TA, selected by this message, signals connection in progress (1, OFF, state 11) to the DTE after delivering DCE-provided information if any.

The alignment pattern procedure is entered as described in 2.3.4.1.

2.3.2.8 RELEASE (from ET)

In the case of a multiterminal configuration the exchange sends the RELEASE message to each TA that had signalled CALL PROCEEDING, ALERTING or CONNECT but which was not selected for the call. Subsequently the TA performs the DCE clear indication procedure at the X.21-interface and sends a RELEASE COMPLETE message to the exchange.

2.3.2.9 DISCONNECT (from TA)

When a DTE indicates DTE clear request (r = 0, i = OFF, state 16), the TA transmits DCE clear confirmation (r = 0, i = OFF, state 17) via the X.21-interface and transmits a DISCONNECT message via the D-channel of the S-interface and tears down the B-channel.

After reception of RELEASE on the D-channel, the TA releases the call reference, sends RELEASE ACKNOWLEDGE to the exchange on the D-channel and transmits DCE ready (r = 1, i = OFF) to the DTE. The DTE then enters the DTE ready state (t = 1, c = OFF).

2.3.2.10 DISCONNECT (from ET)

In the case of clearing by the network the local exchange transmits the DISCONNECT message via the D-channel to the terminal which has to be cleared. After reception of the DISCONNECT message in the TA, the TA transmits a RELEASE message on the D-channel to the exchange.

On the other hand the TA transmits the state 19, r = 0, i = OFF (DCE clear indication) via the X.21-interface to the DTE, which sends back to the TA the state 20, t = 0, c = OFF (DTE clear confirmation).

2.3.2.11 RELEASE COMPLETE (from ET)

When the RELEASE COMPLETE message is received via the D-channel of the S/T reference point in the TA, the DCE ready state (state 21, = 1, OFF) and the DTE ready state (state 1, r = 1, i = OFF) is entered.

The procedure described above is not shown in Figures 2-6 and 2-7.

2.3.3 Call offering procedure in a multiterminal configuration

As per 2.1.3.

2.3.4 Ready for data alignment

For ready for data alignment on entering and leaving the data transfer phase between two terminals operating at 64 kbit/s the following procedure shall apply (see Figure 2-13).

2.3.4.1 Entering the data transfer phase

At the time the called TA has received the CONNECT ACKNOWLEDGE message and delivered the DCE provided information, if any, the called terminal is in the state 11 (connection in progress). The ready for data alignment procedure begins by continuous sending of the alignment pattern all ones at the called side.

All zeros should be returned via the allocated B-channel to the calling party while DCE provided information is sent to the called party. Following the completion of DCE provided information the all ones signals should be transmitted via the B-channel.

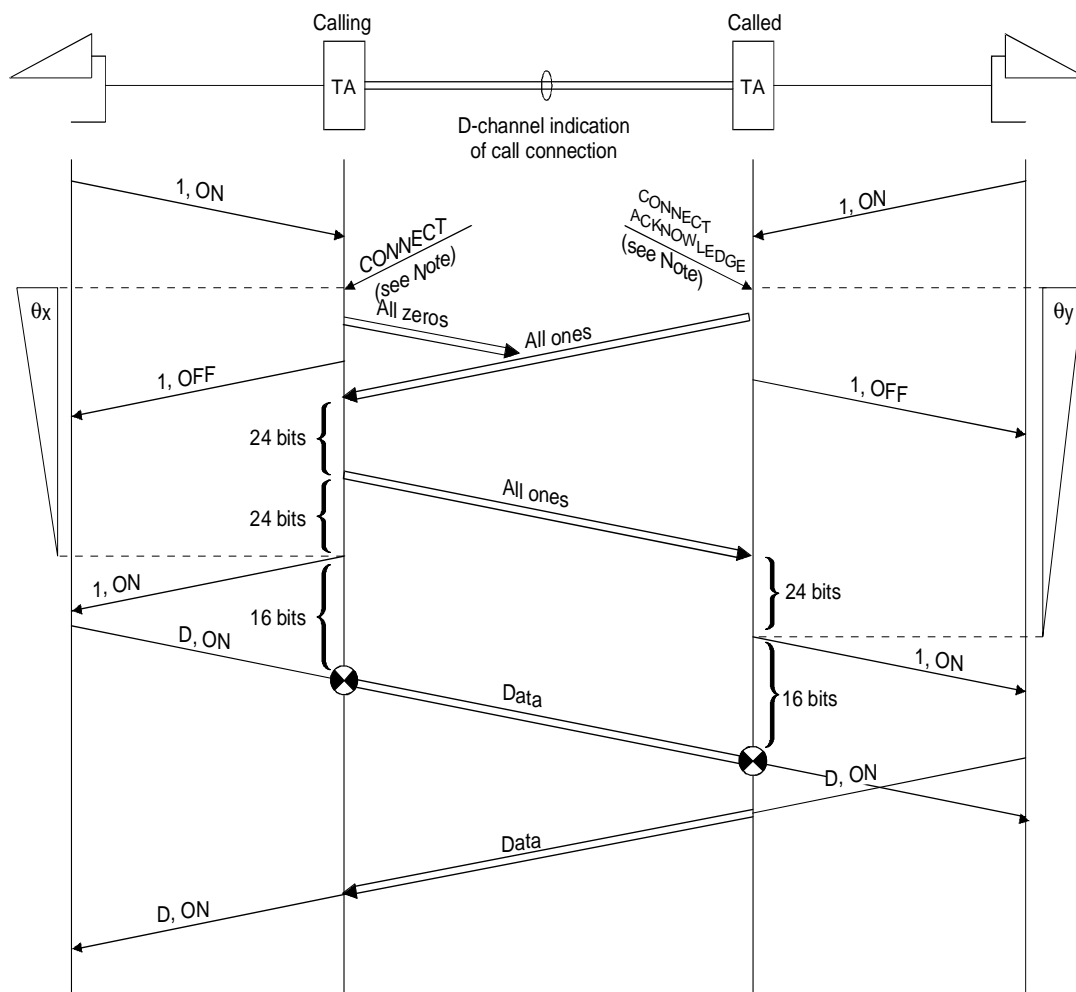

T0716530-93/D13

- D-channel message
- ⇒ B-channel message
- ⊗ Bidirectional connection (T- and R-leads connected to the B-channel)

NOTE – The TA will only indicate ready for data after completing delivery to the DTE of any DCE provided information.
 The receipt of a CONNECT message by the calling TA may occur before or after the receipt of a CONNECT ACKNOWLEDGE message by the called TA.

FIGURE 2-13/X.30

**The operational sequence to effect ready for data alignment
 at a user rate of 64 kbit/s**

After the calling adaptor has received a CONNECT message and delivered the DCE provided information to the calling DTE, if any, the X.21-interface is in the state connection in progress (state 11). If the calling adaptor now has recognized 24 bits of the alignment pattern, it knows that the through-connections are established in the network and it sends the same pattern in the forward direction. After 24 bits have been sent, the calling TA indicates ready for data (state 12, $r = 1, i = ON$) for exact 16 bits, then performs the connection of the B-channel to the T- and R-leads.

When the called adaptor, while sending the alignment pattern, has recognized 24 bits of the alignment pattern from the calling adaptor, it indicates to the DTE ready for data (state 12, $r = 1, ON$) for exact 16 bits, then performs the connection of the B-channel to the T- and R-leads.

When the byte timing is provided at the X.21-interface, the transition from OFF to ON on the I-lead is performed on an octet boundary, complying with Recommendation X.24.

If the alignment pattern has not been received by the calling adaptor before end of time-out θ_x the calling adaptor indicates ready for data ($r = 1, i = ON$) for exact 16 bits, then performs the connection of the B-channel to T- and R-leads.

If the alignment pattern has not been received by the called adaptor before end of time-out θ_y the called adaptor indicates ready for data ($r = 1, i = ON$) for exact 16 bits, then performs the connection of the B-channel to T- and R-leads.

The values of θ_x (provisional value 1 s) and θ_y (provisional value 2 s) should cater for time propagation delays on the longest hypothetical reference connection and require further study.

Optionally, earlier switch-through may occur in the TAs (i.e. the TA does not wait for the expiry of time-outs θ_x and θ_y). In this case DTE information sent after the ready for data on the X.21-interface may be lost due to the lack of end-to-end alignment. Since no ready for data alignment takes place after the connect-through in the TAs, a DTE to DTE synchronization must be performed by an end-to-end procedure between the two DTEs at higher layers.

2.3.4.2 Leaving the data transfer phase

It is not possible to leave the data transfer phase using the synchronization method, because transparency is needed. The cleared terminal should see the end of its communication before the clear message is received. However, anything it sends at this stage would be ignored. Higher level protocols are necessary to resolve these problems.

2.3.5 Mapping of Q.931 causes to X.21 call progress signals

As per 2.1.5.

2.3.6 Additional information for the handling of exceptional situations

As per 2.1.6, with the exception of 2.1.6.3 "premature clearing".

2.4 Terminal adaption functions for DTEs conforming to X.1 user classes of service 1, 2, 14, 15, 16, 17 and 18

2.4.1 Rate adaption functions

2.4.1.1 General approach

The rate adaption functions within the TA are shown in Figure 2-14. A three-stage method is employed with the functional blocks RA0, RA1 and RA2. The RA0 function is an asynchronous-to-synchronous conversion stage using the same technique as defined in Recommendation V.14 for support of X.1 user rates. It produces a synchronous bit stream defined by 2^n times 600 bit/s (where $n = 0$ to 4). The function RA1 adapts the intermediate RA0 user rate to the next higher rate expressed by 2^k times 8 kbit/s (where $k = 0$ or 1). RA2 performs a second conversion to 64 kbit/s.

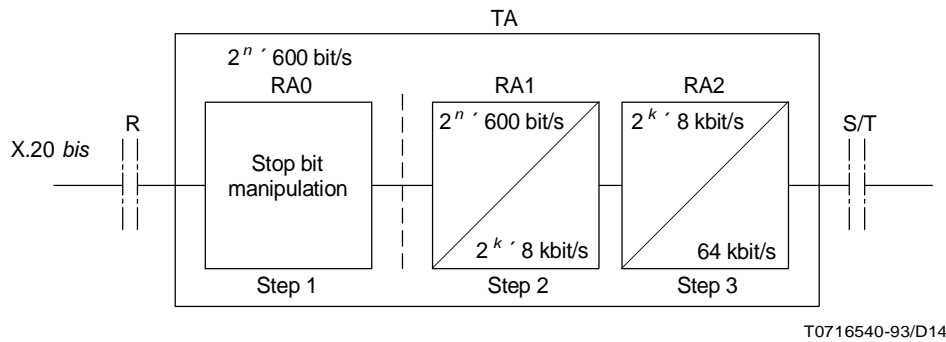

FIGURE 2-14/X.30

2.4.1.2 Supported asynchronous user rates

See Table 2-4.

TABLE 2-4/X.30

Asynchronous user rates

User class of service	Data rate bit/s	Rate tolerance in %	No. of data bits ^{b)}	No. of stop bits	RA0/RA1 rate (bit/s)	RA1/RA2 rate (kbit/s)
2	50 ^{a)}	+/-2.5	5	1.5	600	8
	75 ^{a)}	+/-2.5	5, 7 or 8	1, 1.5 or 2	600	8
	110 ^{a)}	+/-2.5	7 or 8	1 or 2	600	8
	150 ^{a)}	+/-2.5	7 or 8	1 or 2	600	8
	200 ^{a)}	+/-2.5	7 or 8	1 or 2	600	8
1	300 ^{a)}	+/-2.5	7 or 8	1 or 2	600	8
14	600 ^{a)}	+1/-2.5	7 or 8	1 or 2	600	8
15	1200 ^{a)}	+1/-2.5	7 or 8	1 or 2	1200	8
16	2400 ^{a)}	+1/-2.5	7 or 8	1 or 2	2400	8
17	4800 ^{a)}	+1/-2.5	7 or 8	1 or 2	4800	8
18	9600 ^{a)}	+1/-2.5	7 or 8	1 or 2	9600	16
^{a)} Implies that these data rate should be supported by an Universal TA. ^{b)} Number of data bits includes possible parity bits.						

2.4.1.3 Asynchronous-to-synchronous conversion (RA0)

The RA0 function is only used with asynchronous V-Series (X.20 bis) interfaces. Incoming asynchronous data is padded by the addition of stop elements to fit the nearest channel defined by 2^n times 600 bit/s. Thus a 300 bit/s user data signalling rate shall be adapted to a synchronous 600 bit/s stream. The resultant synchronous stream is fed to RA1.

2.4.1.4 2nd step, RA1: Adaption of RA0 to the intermediate rates at 8/16 kbit/s, see 2.1.1.2.

3rd step, RA2: Adaption of intermediate rate, to the bearer rate 64 kbit/s, see 2.1.1.3.

2.4.1.5 Break signal

The terminal adaptor shall detect and transmit the break signal in the following fashion:

If the convertor detects M to $2M + 3$ bits, all of Start polarity, where M is the number of bits per character in the selected format including Start and Stop bits, the converter shall transmit $2M + 3$ bits of Start polarity.

If the convertor detects more than $2M + 3$ bits all of Start polarity, the converter shall transmit all these bits as Start polarity.

The $2M + 3$ or more bits of Start polarity received from the transmitting side shall be output to the receiving terminal.

The terminal must transmit on Circuit 103 at least $2M$ bits Stop polarity after the Start polarity break signal before sending further data characters. The convertor shall then regain character synchronism from the following Stop to Start transition.

2.4.1.6 Overspeed/Underspeed

A Terminal Adaptor shall insert additional Stop elements when its associated terminal is transmitting with a lower than nominal character rate. If the terminal is transmitting characters with an overspeed of up to 1% (or 2.5% in the case of nominal speeds lower than 600 bit/s), the asynchronous-synchronous converter may delete Stop elements as often as is necessary to a maximum of one for every eight characters at 1% overspeed. The converter on the receiving side shall detect the deleted Stop elements and re-insert them in the received data stream (Circuit 104).

The nominal length of the Start and Data elements shall be the same for all characters. The length of the Stop elements may be reduced by as much as 12.5% for nominal speeds exceeding 300 bit/s to allow for overspeed in the transmitting terminal. For nominal speeds less than or equal to 300 bit/s a 25% reduction in Stop element is allowed.

2.4.1.7 Parity bits

Possible parity bits included in the user data are considered as data bits by the RA0 function.

2.4.2 Flow control

A flow control option, for use with TA supporting asynchronous DTEs, is described in this clause. Flow control allows the connection of asynchronous DTEs operating at different user data rates by reducing the character output of the faster to that of the slower. Support of flow control will require the use of the end-to-end (TA-to-TA) protocol defined in 2.4.2.2 and an incoming line (from network) buffer in addition to a selected local protocol employed. There will also be a requirement for character buffering from the DTE interface. The size of this buffer is not defined in this Recommendation because it is dependent upon implementation.

Local flow control of the DTE interface is required where the DTE operates at a rate higher than the synchronous rate established between TAs. End-to-end flow control is required where the synchronous rate established between TAs is consistent with the operating rate of one DTE (or interworking function) and higher than the synchronous rate consistent with the operating rate of the other DTE (or interworking function). Both local and end-to-end flow control could be required in some applications.

2.4.2.1 Local flow control: TA to DTE

Connection may be made between TAs connected to asynchronous DTEs operating at two different speeds. It is the responsibility of the TA connected to the faster DTE to execute a local flow control protocol to reduce the character rate to that of the slower DTE. This operation will require some buffer storage in the TA. A TA may support several different local flow control protocols, although only one will be selected at any one time. There are a number of such protocols in use, some of which are detailed in the following text.

2.4.2.1.1 105/106 operation

This is an out-of-band flow control mechanism, utilizing two of the interchange Circuits specified in V.24. If a DTE requires to transmit a character, it turns ON Circuit 105 (request to send). The DTE can only begin transmission when it receives in return Circuit 106 ON (ready for sending). If, during transmission of a block of characters Circuit 106 goes OFF, the DTE must cease transmission (after completing the transmission of any character of which transmission has started) until Circuit 106 turns ON again.

2.4.2.1.2 X-ON/X-OFF operation

This is an in band flow control mechanism using two characters of the IA5 set for X-ON and X-OFF operation. If a DTE receives an X-OFF character, it must cease transmission. When it receives an X-ON character, it may resume transmission. The characters typically used for X-ON and X-OFF are DC1 and DC3 (bit combination 1/1 and 1/3 in Recommendation T.50) respectively, although alternative bit-combinations can be used.

2.4.2.1.3 Other methods

Alternative and non-standard methods of asynchronous flow control are in use, and these may be mapped onto the TA flow control protocol.

2.4.2.2 End-to-end (TA to TA) flow control

Matching (by reduction) of the transmitted character rate of the DTE to the rate of the TA is not sufficient in all cases to guarantee correct operation, and end-to-end flow control may be required.

The X bit is used to carry flow control information. A TA will buffer incoming characters. When the number of buffered characters exceeds a threshold TH1, depending upon implementation, the TA will set the X bit of its outgoing frames to OFF.

Upon receipt of a frame containing an X bit set to OFF, a TA will execute its selected local flow control procedure indicating that the attached DTE must stop sending characters, and cease the transmission of data after transmitting completely the characters in progress by setting the data bits in the outgoing frames to ones.

When the buffer contents of a TA which has initiated an end-to-end flow control drops below threshold TH2, the TA will reset the outgoing X bit to ON.

When the far-end TA receives a frame with the X bit set to ON, it will recommence data transmission and, by use of the local flow control procedure, indicate to the attached DTE that it may continue.

NOTE – There may be a delay between initiation of the end-to-end flow control protocol and termination of the incoming character stream. The characters arriving during this time must be buffered, and the total buffer size will depend upon the character rate, round trip delay and the buffer threshold.

2.4.2.3 Use of channel capacity

Upon accepting a call from a TA supporting flow control and operating at a different user rate and/or intermediate rate, the called TA will adopt the identical intermediate rate and bit repetition factor. This will override the parameters normally selected. In such cases, the TA connected to the faster DTE will execute a local flow control procedure to reduce the character rate to that of the slower DTE.

Thus, if a faster DTE calls a slower DTE, the faster intermediate channel rate and bit repetition factor will be adopted by the TAs on both ends. To reduce the character rate received by the slower DTE, its TA will exercise end-to-end flow control and cause the TA on the calling side to utilize local flow control.

If a slower DTE calls a faster DTE, the slower intermediate channel rate and bit repetition factor will be adopted by the TAs on both ends. To reduce the character rate transmitted by the faster DTE, its TA will exercise local flow control.

If the called TA does not implement the intermediate rate and bit repetition factor used by the calling TA, the call shall be rejected.

2.4.2.4 Requirements of a TA supporting flow control

The following are general requirements for a TA supporting flow control:

- i) A TA supporting flow control shall be capable of operating with an intermediate rate and bit repetition factor that is independent of the asynchronous speed used at its DTE interface.
- ii) A TA supporting flow control shall be capable of recognizing the intermediate rate and bit repetition factor required for an incoming call, and adopting it. User rate information will be obtained from signalling.
- iii) A TA supporting flow control shall be capable of executing a local flow control protocol to reduce the character rate to that of the far-end DTE.
- iv) A TA supporting flow control will support the use of end-to-end (TA-to-NA) flow control using the X bit, and will contain a character buffer.

2.4.3 Ready for data alignment

The adaption functions relevant to bit rate adaption for steps RA1 and RA2 and the READY FOR DATA ALIGNMENT remain as described in 2.1.4.

3 Test loops

The maintenance concept of the X.30 TA shall comply with the maintenance concept of the ISDN subscriber access and subscriber installation as defined in Recommendations of the I.600-Series and in Recommendation I.430 on ISDN subscriber access and installation maintenance. The test loops are specified in those Recommendations.

The ISDN communication architecture enables communication of maintenance information over bearer connections between network service access points (NSAPs). Accordingly, a bearer service may be used on either a B- or D-channel to transport the protocol.

Maintenance entities can choose to communicate information about performance management, fault management, configuration and naming management, etc., using an OSI application layer protocol. The specification of these management capabilities to be supported by TAs is for further study. The following concepts shall apply:

3.1 Test loop reference configuration

Figure 3-1 shows the location of test loops within the TA.

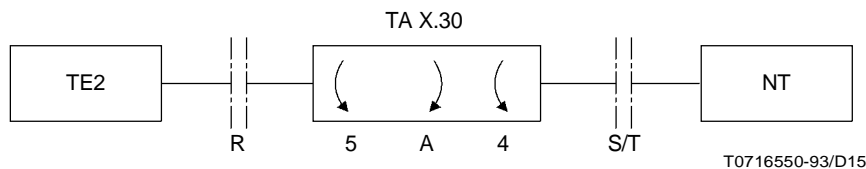

FIGURE 3-1/X.30
Location of test loops

Loop 4 shall be located close to the S/T reference point. Loop 5 shall be located close to the R-reference point. Loop A shall be located close to the S/T reference point.

3.2 Test loop characteristics

The test loop characteristics for loops 4, 5 and A are defined in Recommendations I.430 and the I.600-Series.

3.3 Loop activation/deactivation mechanism

a) Test loop 4

Test loop 4 being controlled from the network side of the TA is activated either via a layer 3 message on the D-channel or via a layer 1 message on the selected B-channel after a connection has been established from the control point to the TA. Selection of the B-channel to be looped is part of the call set-up procedure.

When the loop is established the following states shall apply at the R-reference point:

1) for the X.21 interface towards the terminal

R = 0/1 . . . , i = OFF (DCE controlled not ready);

2) for the X.21 *bis* interface towards the terminal;

- circuit 104 is placed in the binary 1 condition;
- circuits 106, 107, 109 and 125 are placed in the OFF condition;
- circuit 142 is placed in the ON condition;
- timing information is placed on circuits 114 and 115.

b) Test loop 5

For activation/deactivation of test loop 5, the definitions as under (a) apply. Since the loop 5 is close to the R-reference point, the loop point is located within the R-interface circuitry and not within the B-channel. Due to the rate adaption mechanism the composition of the bit stream received at the TA and the composition of the bit stream which is looped and sent back on the B-channel may not be identical at the S/T interface. At the loop point, however, the incoming and outgoing (logged) bits streams are identical.

When the loop is established the states as defined in X.21 for loop 2b shall apply.

c) Test loop A

Test loop A is activated/deactivated by procedures defined in Recommendation X.21/X.21 *bis*.

NOTE – Since selection of a specific B-channel is not specified in Recommendation X.21/X.21 *bis*, the subject of B-channel selection within test loop A, if required, remains for further study.

NOTE – Loop activation/deactivation (for the above 3 test loops) can optionally as an alternative be provided manually.

3.4 Coding of activation/deactivation control message

- loop 4 control via B- or D-channel application layer protocol: for further study;
- loop 4 control via B-channel layer 1 message: for further study;
- loop 5 control via B- or D-channel application layer protocol: for further study;
- loop 5 control via B-channel layer 1 message: as in X.21/X.21 *bis*;
- loop A: as in X.21/X.21 *bis*.

NOTE – The protocols and procedures for communicating between the two system management application processes (SMAPs) are for further study.

Annex A

(to Recommendation X.30)

SDL diagrams

(This annex forms an integral part of this Recommendation)

A.1 General

In order to provide a clear and unambiguous understanding of the protocol mapping in the TA (X.21 procedures to the ISDN signalling procedures) a formal method is used. This annex presents a formal description using SDL (specification and description language) which is recommended by CCITT (Recommendations Z.101-Z.104).

The description supplements Figures 8 and 9.

A.2 Some remarks about the formal description

- a) Because of fundamental differences in the formal description techniques used in Recommendation X.21 (Annex A) and the one used to describe the X.21 TA, it was not possible to realize a one-to-one translation of the "states" as described in Recommendation X.21 into the "states" as described in the X.21 TA.

However, as SDL is a method recommended by CCITT, it is still felt appropriate to use this language.

Corresponding states from Recommendation X.21 are indicated as comment in the X.21 TA description.

- b) Only the regular call control phase and the clearing phase of the X.21 TA are described. No time-outs, etc. are included.
- c) The following tasks are not shown in detail in the SDL diagrams:
 - switch-through at the R-side of the TA (on the R-interface, data is internally mapped to the B-channel handler);
 - end-to-end synchronization;
 - the rate adaption and frame/envelope (dis)assembly processes.
- d) In order to describe the TA, the TA is divided in three parts, which can act simultaneously:
 - the R-interface side;
 - the D-channel handler on the S-interface side.
 - the B-channel handler on the S-interface side.

The (ordering of the) interacting signals between R-side and S-side represent the actual mapping of the R-interface procedures to the S-interface procedures.

An explanation of the symbols used in the SDL diagrams is given in Figure A.1.

The protocol mapping of the X.21 TA is given in Figures A.2/X.30 to A.6.

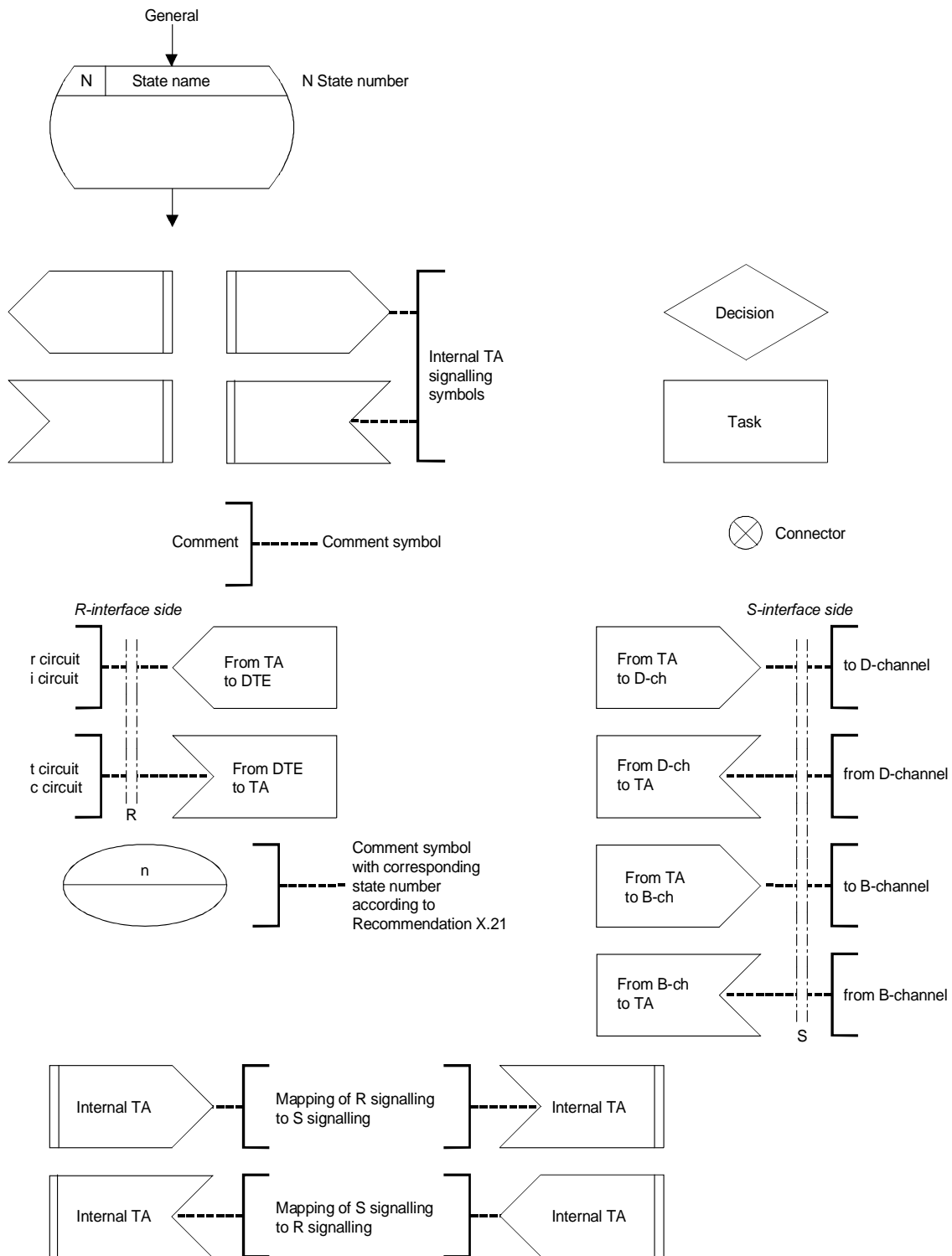

T0716560-93/D16

NOTE – Two-process representation at R-interface side and S-interface side employed in the following figures does not imply two-process implementation.

FIGURE A.1/X.30

Use of symbols in SDL diagrams for X.21 terminal adaptor (TA) signalling [1]

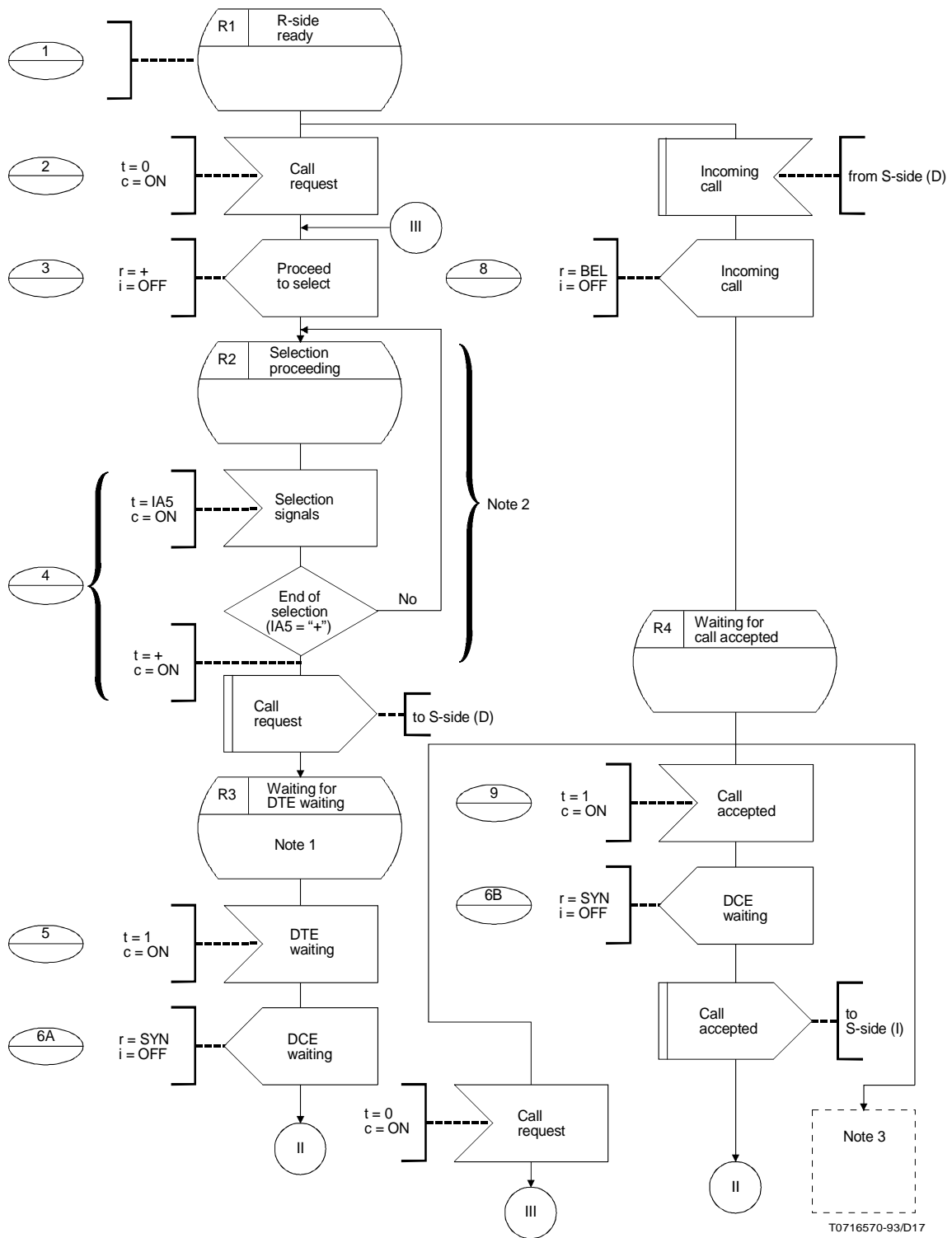

T0716570-93/D17

NOTES

- 1 Manual answering terminals are not considered in this figure.
- 2 If an internal *incoming call* signal is received while in this state, it should be ignored by the R-side.
- 3 X.21 extended address procedure is left for further study.

FIGURE A.2/X.30 (sheet 1 of 2)
R-interface side of the X.21 TA; call control phase

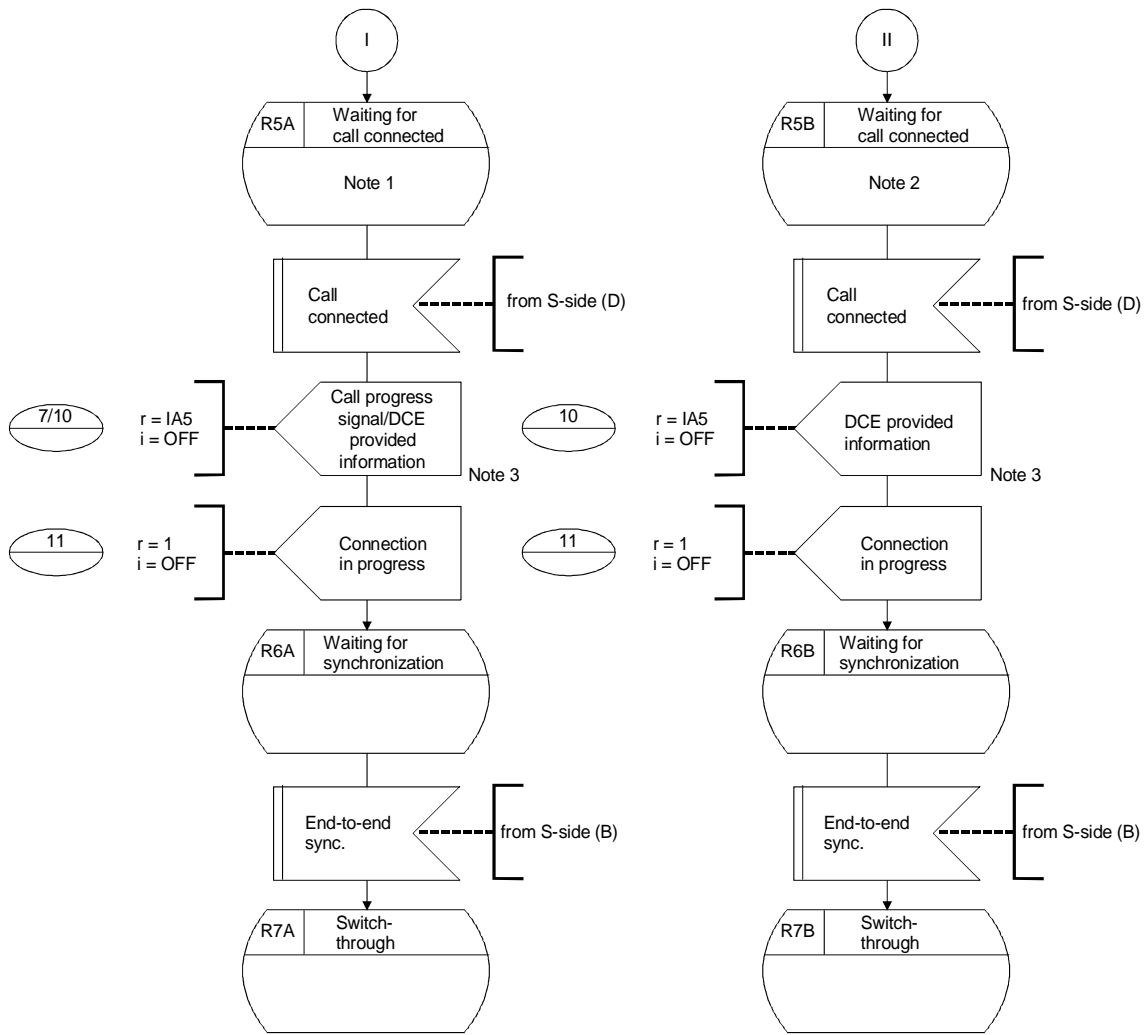

T0716580-93/D18

NOTES

- 1 If an internal *incoming call* signal is received while in this state, it should be ignored by the R-side.
- 2 X.21 extended address procedure is left for further study.
- 3 DCE waiting states (6A or 6B; see Recommendation X.21, Figure A.2/X.21) may be bypassed.
- 4 The X.21 states *controlled* and *uncontrolled not ready* are not shown in these diagrams. However, if an internal incoming call is received from the S-side during these states, the R-side will respond with an *internalclear request* to the S-side with the appropriate reason.

FIGURE A.2/X.30 (sheet 2 of 2)
R-interface side of the X.21 TA; call control phase

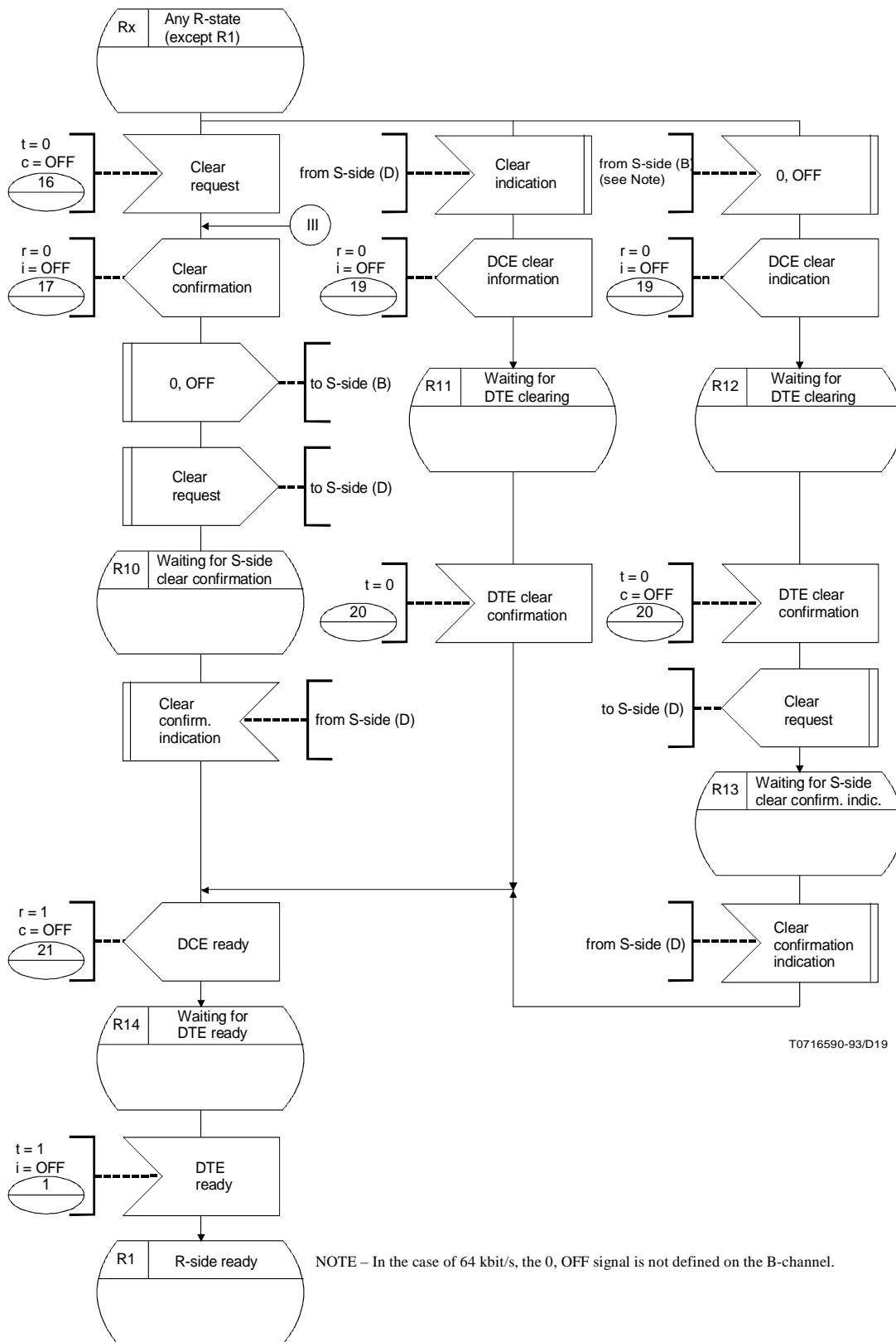

FIGURE A.3/X.30
R-interface side of the X.21 TA; clearing phase

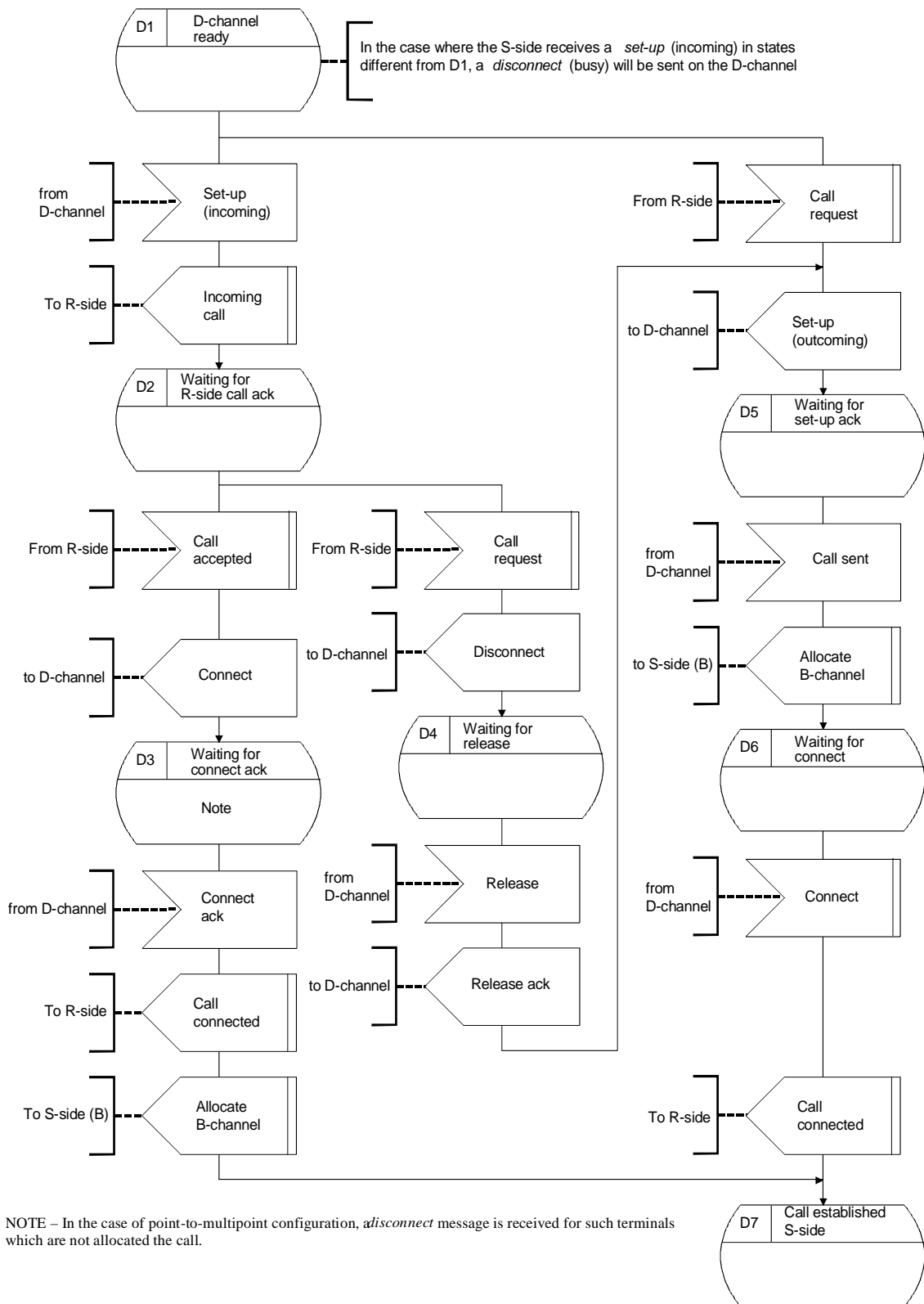

FIGURE A.4/X.30
S-interface side of the X.21 TA; call control phase of the D-channel handler

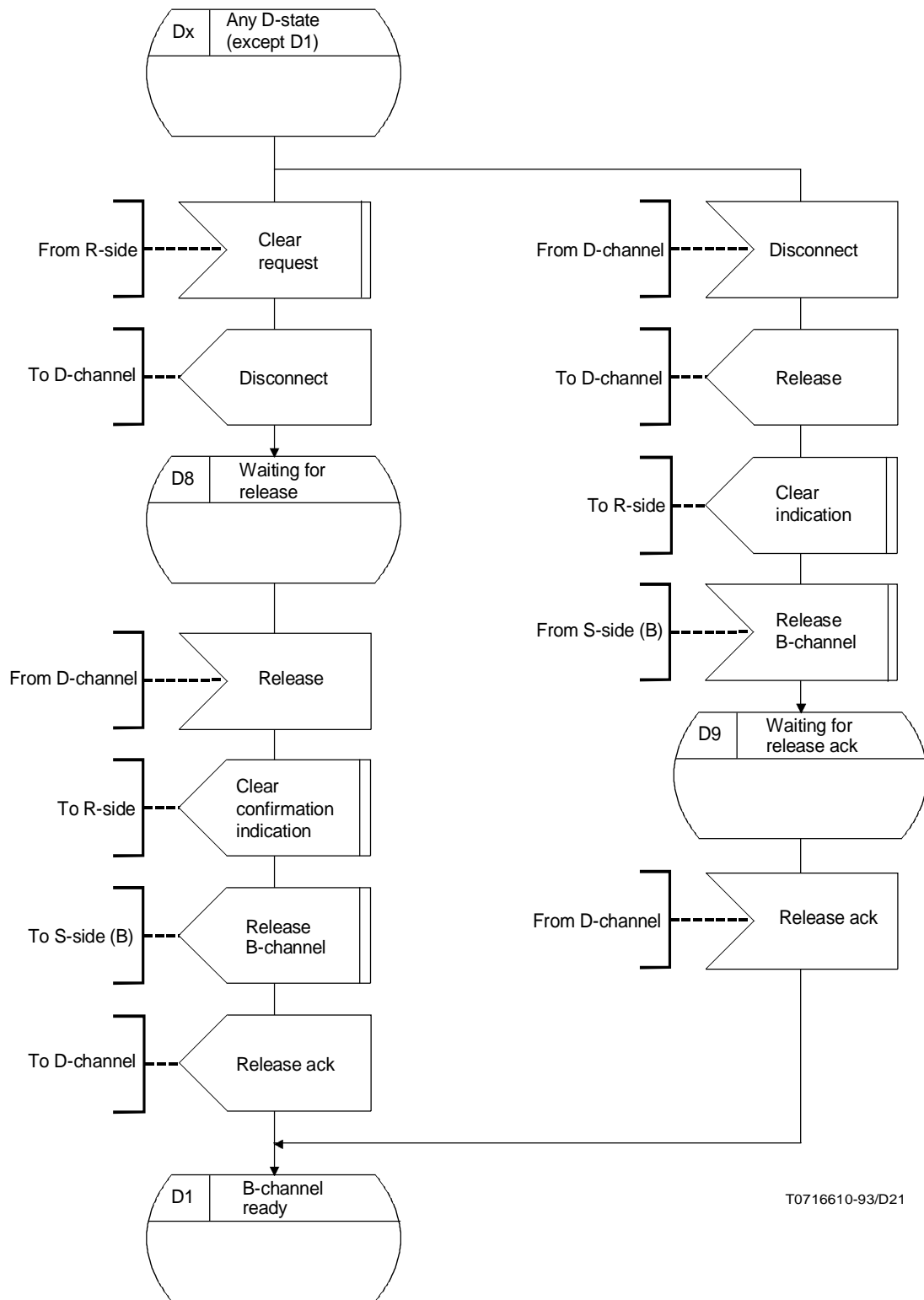
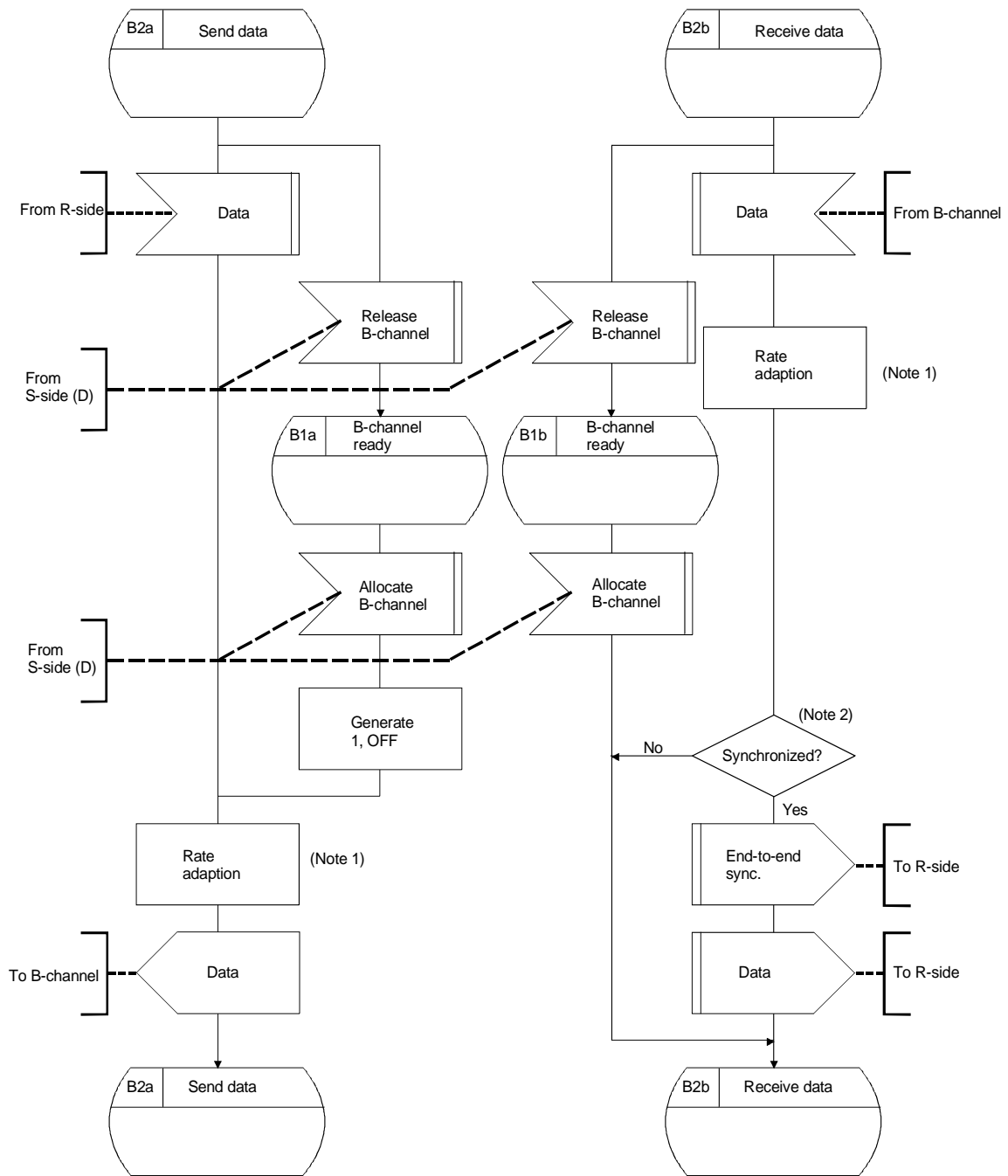

FIGURE A.5/X.30
S-interface side of the X.21 TA; clearing phase of the D-channel handler



NOTES

- 1 Only required for user classes 3 to 7.
- 2 See 2.1.4, 2.2.4 and 2.3.4.

FIGURE A.6/X.30
S-interface side of the X.21 TA; B-channel handler

Appendix I

(to Recommendation X.30)

Universal terminal adaptor

(This appendix does not form an integral part of this Recommendation)

Some Administrations may provide universal TAs for all user rates from 600 bit/s to 64 kbit/s. In this case, the called TA will adapt to the data user rate of the calling TA.

I.1 User rate identification

I.1.1 Search for the bit pattern . . . 10111011 . . . in bit 1 of successive octets which are received from the 64 kbit/s stream.

If the search is positive, then the user rate is 48 kbit/s.

I.1.2 Identification of intermediate rate

See II.1.

I.1.3 User rate identification at rates less than 48 kbit/s

See II.3.

I.1.4 The procedures for detection of a 64 kbit/s unstructured path by a universal TA requires further study. However, it is recognised that in the case of a TA supporting only 64 kbit/s, such a procedure is not needed.

NOTES

- 1 Operations I.1.1, I.1.2 and I.1.3 may be performed in parallel.
- 2 The procedure to be undertaken if user rate detections is not successful requires further study.

I.2 Search for frame alignment at user rates less than 48 kbit/s, after restitution of the intermediate rate, using the following strategy:

Look for the following 17 bit alignment pattern:

0000000	1XXXXXXX	1XXXXXXX	1XXXXXXX	1XXXXXXX
1XXXXXXX	1XXXXXXX	1XXXXXXX	1XXXXXXX	1XXXXXXX

No errors will be tolerated in the defined bit position shown above.

NOTE – “X” indicates that the condition of this bit position has no significance for the purpose of alignment.

To ensure a reliable synchronization, it is suggested that at least two 17 bit alignment patterns in consecutive frames be detected.

In the case of X.1 user class of service 3 (600 bit/s) a further search for the frame group synchronization pattern contained in bit position E7 shall be performed.

I.3 Loss of alignment/recovery

Loss of alignment will be assumed following the detection of three consecutive frames, each with at least one alignment bit error.

The monitoring of the alignment signal shall be a continuous process using the same procedure as for initial alignment detection.

Following loss of the alignment, the TA shall enter a recovery state.

If the recovery of alignment is not achieved within a fixed period, the TA shall indicate DCE not ready by signalling $r = 0$, $i = \text{OFF}$. The duration of this period is network dependent (as in 2.6.2/X.21).

If recovery is not successful further maintenance procedures might be used.

NOTES

1 The implication of a user rate changing during a call requires further study, particularly since it is not currently accommodated by Recommendation X.21.

2 It is recognized that procedures for universal TA operation cannot be implemented without a change to Recommendation X.21.

I.4 Ready for data alignment

The called TA transmits all zeros until it has identified the user rate of the calling DTE (see Figure I.1). Thus a handshaking procedure is performed where the calling TA will be the last to switch through. After switching through of the calling TA, both X.21 terminals enter the ready for data state.

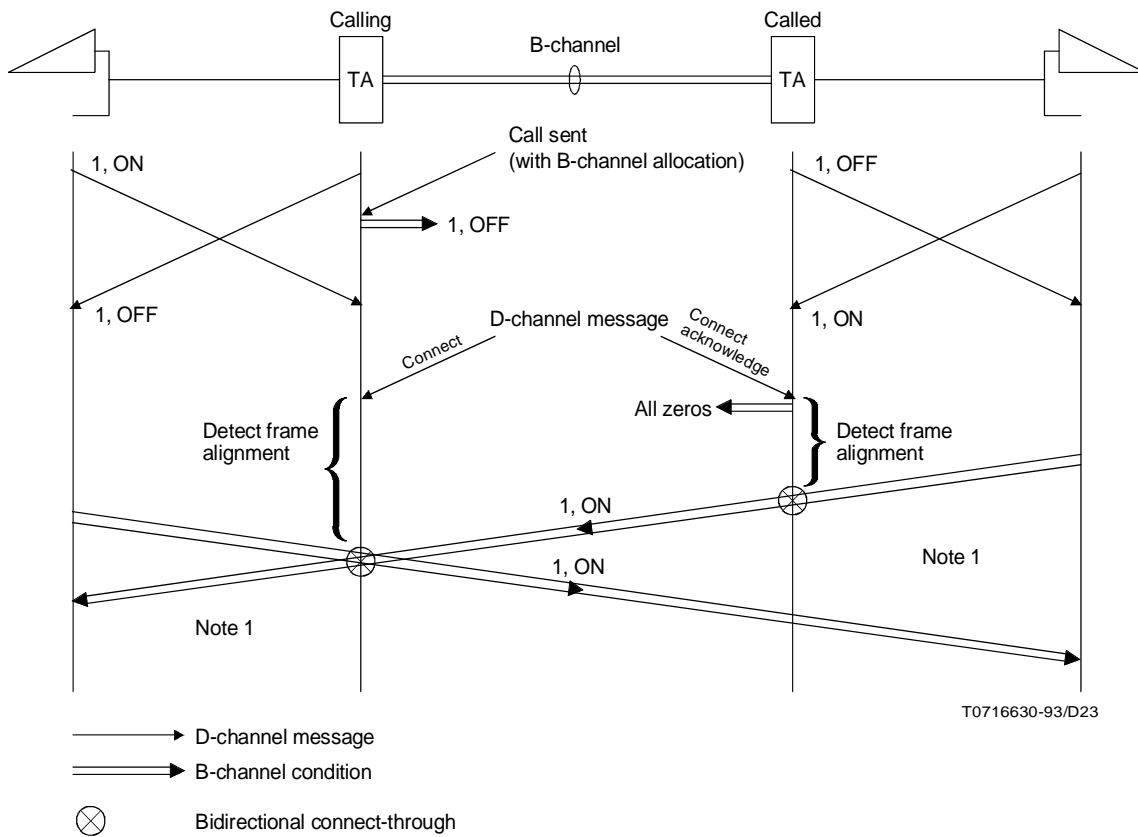

T0716630-93/D23

NOTES

1 The TA shall perform connect-through after detecting frame alignment and completing delivery to the terminal of any DCE-provided information.

2 Only those conditions necessary to effect ready for data alignment are shown.

FIGURE I.1/X.30

Universal TA operation to effect ready for data alignment at rates < 64 kbit/s

Appendix II

(to Recommendation X.30)

Inslot identification of intermediate bit rate

(This appendix does not form an integral part of this Recommendation)

II.1 Identification of intermediate rate

The intermediate rate (16 or 8 kbit/s) is identified by inspecting the bit sequence of position 1 and the bit sequence of position 2 of the 64 kbit/s octets.

If the bit sequence of position 1 contains strings of 8 to 15 continuous 0-bits and the bit sequence of position 2 contains no 0-bits, the intermediate bit rate is 8 kbit/s.

If the bit sequences of positions 1 and 2 both contain strings of continuous 0-bits with lengths of 4 or more bits, the intermediate bit rate is 16 kbit/s.

Irrelevant of the intermediate bit rate, positions 3 to 8 of the 64 kbit/s octets must contain only 1-bits.

II.2 Restitution of the intermediate rate

The 16 kbit/s intermediate rate can be restituted by mapping the bits of positions 1 and 2 of each 64 kbit/s octet onto two subsequent bits of the 16 kbit/s intermediate rate.

The 8 kbit/s intermediate rate can be restituted by mapping the first bit of each 64 kbit/s octet onto one bit of the 8 kbit/s rate.

II.3 User rate identification

For an intermediate bit rate of 16 kbit/s the user rate is 9.6 kbit/s.

For an intermediate rate of 8 kbit/s the user rate is identified by the coding of the E-bit pattern (see 2.1.1.2.4).

Reference

- [1] CCITT Recommendations Z.101-Z.104 *Functional specification and description language (SDL)*.