

International Telecommunication Union

ITU-T

TELECOMMUNICATION
STANDARDIZATION SECTOR
OF ITU

P.57

(12/2011)

SERIES P: TERMINALS AND SUBJECTIVE AND
OBJECTIVE ASSESSMENT METHODS

Objective measuring apparatus

Artificial ears

Recommendation ITU-T P.57



ITU-T P-SERIES RECOMMENDATIONS

TERMINALS AND SUBJECTIVE AND OBJECTIVE ASSESSMENT METHODS

Vocabulary and effects of transmission parameters on customer opinion of transmission quality	Series	P.10
Voice terminal characteristics	Series	P.30 P.300
Reference systems	Series	P.40
Objective measuring apparatus	Series	P.50 P.500
Objective electro-acoustical measurements	Series	P.60
Measurements related to speech loudness	Series	P.70
Methods for objective and subjective assessment of speech quality	Series	P.80 P.800
Audiovisual quality in multimedia services	Series	P.900
Transmission performance and QoS aspects of IP end-points	Series	P.1000
Communications involving vehicles	Series	P.1100

For further details, please refer to the list of ITU-T Recommendations.

Recommendation ITU-T P.57

Artificial ears

Summary

Recommendation ITU-T P.57 specifies the electro-acoustical characteristics of artificial ears to be used for telephometric measurements. Three devices are specified: a telephone band type for measurements on traditional telephone sets, an insert earphone type and a type faithfully reproducing the characteristics of the human ear.

The latter type (type 3) is specified in four configurations. The requirements of the third one (type 3.3 – Pinna simulator) have been slightly modified in this revision of Recommendation ITU-T P.57 by specifying its construction by a softer elastomer.

Besides this, the description of the applicability of all couplers has been changed, now allowing for an overlap in their usability according to the receiver type under test.

History

Edition	Recommendation	Approval	Study Group
1.0	ITU-T P.57	1993-03-12	XII
2.0	ITU-T P.57	1996-08-30	12
3.0	ITU-T P.57	2002-07-14	12
3.1	ITU-T P.57 (2002) Cor. 1	2005-01-27	12
4.0	ITU-T P.57	2005-11-29	12
5.0	ITU-T P.57	2009-04-29	12
6.0	ITU-T P.57	2011-12-14	12

FOREWORD

The International Telecommunication Union (ITU) is the United Nations specialized agency in the field of telecommunications, information and communication technologies (ICTs). The ITU Telecommunication Standardization Sector (ITU-T) is a permanent organ of ITU. ITU-T is responsible for studying technical, operating and tariff questions and issuing Recommendations on them with a view to standardizing telecommunications on a worldwide basis.

The World Telecommunication Standardization Assembly (WTSA), which meets every four years, establishes the topics for study by the ITU-T study groups which, in turn, produce Recommendations on these topics.

The approval of ITU-T Recommendations is covered by the procedure laid down in WTSA Resolution 1.

In some areas of information technology which fall within ITU-T's purview, the necessary standards are prepared on a collaborative basis with ISO and IEC.

NOTE

In this Recommendation, the expression "Administration" is used for conciseness to indicate both a telecommunication administration and a recognized operating agency.

Compliance with this Recommendation is voluntary. However, the Recommendation may contain certain mandatory provisions (to ensure, e.g., interoperability or applicability) and compliance with the Recommendation is achieved when all of these mandatory provisions are met. The words "shall" or some other obligatory language such as "must" and the negative equivalents are used to express requirements. The use of such words does not suggest that compliance with the Recommendation is required of any party.

INTELLECTUAL PROPERTY RIGHTS

ITU draws attention to the possibility that the practice or implementation of this Recommendation may involve the use of a claimed Intellectual Property Right. ITU takes no position concerning the evidence, validity or applicability of claimed Intellectual Property Rights, whether asserted by ITU members or others outside of the Recommendation development process.

As of the date of approval of this Recommendation, ITU had received notice of intellectual property, protected by patents, which may be required to implement this Recommendation. However, implementers are cautioned that this may not represent the latest information and are therefore strongly urged to consult the TSB patent database at <http://www.itu.int/ITU-T/ipr/>.

© ITU 2012

All rights reserved. No part of this publication may be reproduced, by any means whatsoever, without the prior written permission of ITU.

Table of Contents

	Page	
1	Scope and object.....	1
1.1	Scope	1
1.2	Object	1
2	References.....	1
3	Definitions	1
3.1	Terms defined elsewhere	1
3.2	Terms defined in this Recommendation.....	2
4	Abbreviations and acronyms	4
5	Artificial ear types	4
5.1	Type 1 artificial ear	5
5.2	Type 2 artificial ear	6
5.3	Type 3.....	8
5.4	Calibration of the artificial ears type 1 and type 3.2	19
5.5	Performance verification of the artificial ears types 2, 3.1, 3.3 and 3.4.....	22
5.6	Atmospheric reference conditions	22
5.7	General requirements.....	22
5.8	Ear-drum reference point to ear reference point correction	22
Annex A	A – A practical procedure for determination of the acoustic input impedance of artificial ears	23
A.1	Introduction	23
A.2	Calibration of the impedance probe	24
A.3	Artificial ear calibration	25
Appendix I	– Comparative acoustical input impedance measurements on the artificial ears Types 3.3 and 3.4 and on human ears.....	26
I.1	Introduction	26
I.2	Data overview.....	26
I.3	Artificial ear measurements.....	27
I.4	Human ear measurements.....	28
I.5	Comparison between human and artificial ear measurements	36
Appendix II	– Illustration of the mobile phone-shaped impedance probe used in Appendix I	44
Bibliography	46

Recommendation ITU-T P.57

Artificial ears

1 Scope and object

1.1 Scope

This Recommendation specifies the artificial ears for telephonometric use. Three types are recommended, covering the different transducers, types, sizes and technologies.

The methods of use of the artificial ears are outside the scope of this Recommendation; however, some general rules are provided about the application force and the positioning of transducers.

1.2 Object

Three types of artificial ears are defined:

- 1) a telephone-band type for measurements on traditional telephone sets;
- 2) a type for measuring insert earphones;
- 3) a type which faithfully reproduces the characteristics of the median human ear.

2 References

The following ITU-T Recommendations and other references contain provisions which, through reference in this text, constitute provisions of this Recommendation. At the time of publication, the editions indicated were valid. All Recommendations and other references are subject to revision; users of this Recommendation are therefore encouraged to investigate the possibility of applying the most recent edition of the Recommendations and other references listed below. A list of the currently valid ITU-T Recommendations is regularly published. The reference to a document within this Recommendation does not give it, as a stand-alone document, the status of a Recommendation.

- [ITU-T P.79] Recommendation ITU-T P.79 (2007), *Calculation of loudness ratings for telephone sets*.
- [ITU-T P.380] Recommendation ITU-T P.380 (2003), *Electro-acoustic measurements on headsets*.
- [IEC 60318-1] IEC 60318-1 (2009), *Electroacoustics – Simulators of human head and ear – Part 1: Ear simulator for the measurement of supra-aural and circumaural earphones*.
<http://webstore.iec.ch/webstore/webstore.nsf/ArtNum_PK/43309?OpenDocument>
- [IEC 60318-4] IEC 60318-4 (2010), *Electroacoustics – Simulators of human head and ear – Part 4: Occluded-ear simulator for the measurement of earphones coupled to the ear by means of ear inserts*.
<http://webstore.iec.ch/webstore/webstore.nsf/ArtNum_PK/43703?OpenDocument>
- [IEC 61260] IEC 61260 (1995), *Electroacoustics – Octave-band and fractional-octave-band filters*.
<http://webstore.iec.ch/webstore/webstore.nsf/ArtNum_PK/19426?OpenDocument>

3 Definitions

3.1 Terms defined elsewhere

None.

3.2 Terms defined in this Recommendation

This Recommendation defines the following terms:

3.2.1 acoustically closed earphones (nominally sealed): Earphones which are intended to prevent any acoustic coupling between the external environment and the ear canal.

3.2.2 acoustically open earphones (nominally unsealed): Earphones which intentionally provide an acoustic path between the external environment and the ear canal.

3.2.3 artificial ear: A device for the calibration of earphones incorporating an acoustic coupler and a calibration microphone for the measurement of sound pressure, and having an overall acoustic impedance similar to that of the average human ear over a given frequency band.

3.2.4 circum-aural earphones: Earphones which enclose the pinna and seat on the surrounding surface of the head. Contact to the head is normally maintained by compliant cushions. Circum-aural earphones may touch but not significantly compress the pinna (see Figure 1).

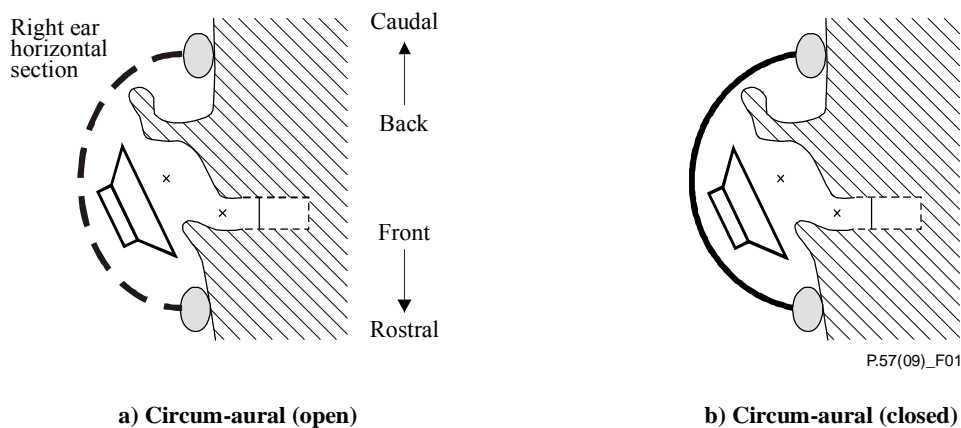

Figure 1 – Circum-aural earphones

3.2.5 ear canal entrance point (EEP): A point located at the centre of the ear canal opening.

3.2.6 ear canal extension: Cylindrical cavity extending the simulation of the ear canal provided by the occluded-ear simulator out of the concha cavity.

3.2.7 ear reference point (ERP): A virtual point for geometric reference located at the entrance to the listener's ear, traditionally used for calculating telephonometric loudness ratings.

3.2.8 ear simulator: Device for measuring the output sound pressure of an earphone under well-defined loading conditions in a specified frequency range. It consists essentially of a principal cavity, acoustic load networks and a calibrated microphone. The location of the microphone is chosen so that the sound pressure at the microphone corresponds approximately to the sound pressure existing at the human ear-drum.

3.2.9 ear-drum reference point (DRP): A point located at the end of the ear canal, corresponding to the ear-drum position.

3.2.10 insert earphones: Earphones which are intended to partially or completely enter the ear canal (see Figure 2).

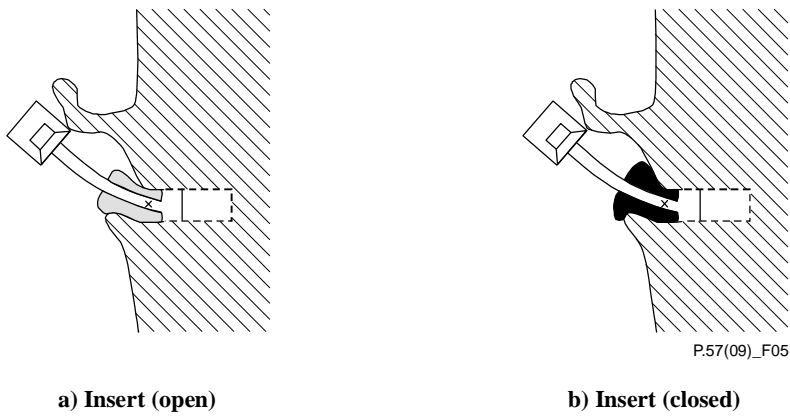

Figure 2 – Insert earphones

3.2.11 intra-concha earphones: Earphones which are intended to rest within the concha cavity of the ear. They have an external diameter (or maximum dimension) of less than 25 mm but are not made to enter the ear canal (see Figure 3).

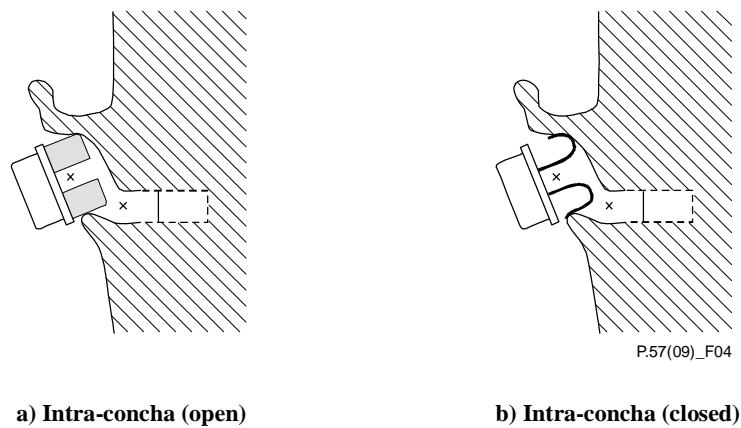

Figure 3 – Intra-concha earphones

3.2.12 occluded-ear simulator: Ear simulator which simulates the inner part of the ear canal, from the tip of an ear insert to the ear-drum.

3.2.13 pinna simulator: A device which has the approximate shape of dimensions of a median adult human pinna.

3.2.14 supra-aural earphones: Earphones which rest upon the pinna and have an external diameter (or maximum dimension) of at least 45 mm (see Figure 4).

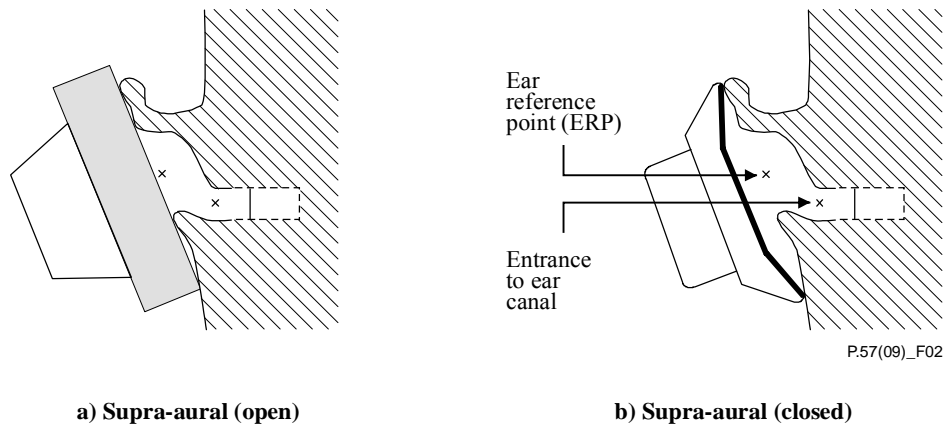

Figure 4 – Supra-aural earphones

3.2.15 supra-concha earphones: Earphones which are intended to rest upon the ridges of the concha cavity and have an external diameter (or maximum dimension) greater than 25 mm and less than 45 mm (see Figure 5).

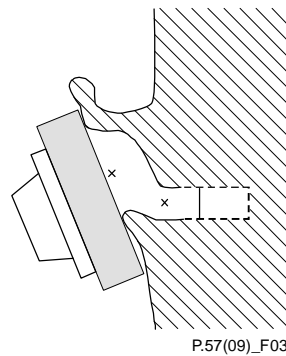

Figure 5 – Supra-concha (open) earphones

4 Abbreviations and acronyms

This Recommendation uses the following abbreviations and acronyms:

ANOVA	ANalysis Of VAriance
DRP	ear-Drum Reference Point
EEP	Ear canal Entrance Point
ERP	Ear Reference Point
HATS	Head And Torso Simulator
LRGP	Loudness Rating Guard-ring Position

5 Artificial ear types

The fundamental purpose of an artificial ear is to test a receiver under conditions that most closely approximate actual use by real persons. The recommendations that follow are based upon the manner in which the receivers are intended to be used. Modifications to an artificial ear or test procedure shall not be made. To avoid alteration of the specified concha volume and/or leak, flexible sealing material, such as putty, shall not be used.

Of the artificial ears defined below, those with a flexible pinna are intended to most closely resemble the manner in which the receivers are intended to be used.

In the narrow-band (100 Hz to 4 kHz), the type 3.3 artificial ear resembles the human ear most closely and is the preferred choice, irrespective of the device to be tested.

Use of artificial ears type 1 and 3.2 is limited to their scope of usability, described below.

Comparative acoustic impedance measurements of the artificial ear types and human ears were conducted on a large scale and are shown in Appendix I.

For wider-band applications, further study is still needed.

5.1 Type 1 artificial ear

The type 1 artificial ear is specified in [IEC 60318-1].

It is recommended that the type 1 artificial ear should only be used as a legacy ear simulator for measurements on large, supra-aural or supra-concha, hard-cap, conically symmetrical receivers, which naturally seal to the simulator rim, intended for narrow-band telephony applications (100 Hz to 4 kHz). The type 1 artificial ear should not be used for receivers that do not meet these specifications.

The acoustic input impedance and the frequency sensitivity response of the type 1 artificial ear are determined with reference to the ERP as specified in clause 5.4. The nominal modulus of the impedance curve and the corresponding tolerance limits are given in Table 1.

Table 1 – Acoustical impedance for type 1 artificial ear (IEC 60318)

Frequency (Hz)	Acoustical imp. (dB re 1 Pa s/m ³)	Tolerance (± dB)	Frequency (Hz)	Acoustical imp. (dB re 1 Pa s/m ³)	Tolerance (± dB)
100	145.6	1	950	134.5	1
106	145.3	1	1000	134.0	1
112	145.0	1	1060	133.4	1
118	144.6	1	1120	132.8	1
125	144.3	1	1180	132.2	1
132	144.0	1	1250	131.7	1
140	143.7	1	1320	131.1	1
150	143.4	1	1400	130.6	1
160	143.2	1	1500	130.1	1
170	143.0	1	1600	129.6	1
180	143.0	1	1700	129.4	1
190	142.9	1	1800	129.2	1
200	142.8	1	1900	129.2	1
212	142.9	1	2000	129.3	1
224	142.9	1	2120	129.5	1
236	143.1	1	2240	129.7	1
250	143.2	1	2360	129.8	1
265	143.4	1	2500	129.8	1
280	143.5	1	2650	129.6	1
300	143.7	1	2800	129.2	1
315	143.6	1	3000	128.6	1
335	143.7	1	3150	127.9	1

Table 1 – Acoustical impedance for type 1 artificial ear (IEC 60318)

Frequency (Hz)	Acoustical imp. (dB re 1 Pa s/m ³)	Tolerance (± dB)	Frequency (Hz)	Acoustical imp. (dB re 1 Pa s/m ³)	Tolerance (± dB)
355	143.6	1	3350	127.0	1
375	143.3	1	3550	125.9	1
400	143.0	1	3750	124.8	1
425	142.7	1	4000	123.2	1
450	142.2	1	4250	121.5	1
475	141.7	1	4500	119.5	1
500	141.3	1	4750	117.1	1
530	140.7	1	5000	114.2	1
560	140.1	1	5300	109.6	1
600	139.4	1	5600	104.7	1
630	138.9	1	6000	109.6	1
670	138.3	1	6300	113.6	1
710	137.6	1	6700	117.0	1
750	137.1	1	7100	119.5	1
800	136.4	1	7500	121.3	1
850	135.7	1	8000	123.2	1
900	135.1	1			

NOTE 1 – The type 1 artificial ear is not suitable for measuring low acoustic-impedance earphones.

NOTE 2 – The type 1 artificial ear is defined for simulating the acoustic load of the human ear under no leakage conditions. For receive loudness rating calculations according to [ITU-T P.79], it is recommended that measured data be corrected using the real ear loss correction L_E provided in Table 2 of [ITU-T P.79].

NOTE 3 – It is recommended to use an application force between 5 N and 10 N for placing ear-caps against type 1 artificial ears. The force applied in measurements shall always be reported.

5.2 Type 2 artificial ear

The type 2 artificial ear is specified in [IEC 60318-4].

It is recommended that the type 2 artificial ear should be used for measurements on insert earphones, both sealed and unsealed.

The sound pressure measured by the type 2 artificial ear is referred to the ear-drum reference point (DRP). The correction function given in Tables 2-a (1/3 octave band measurements) and 2-b (1/12 octave band and sine measurements) shall be used for converting data to the ear reference point (ERP) when it is required to calculate loudness ratings or check results against specifications based on measurements referring to the ERP.

NOTE – For receive loudness rating calculations according to [ITU-T P.79], the real ear loss correction L_E should be as specified in [ITU-T P.380].

Table 2-a – S_{DE} – Third octave measurements

Frequency (Hz)	S _{DE} (dB)	Frequency (Hz)	S _{DE} (dB)
100	0.0	1000	-1.7
125	0.0	1250	-2.6
160	0.0	1600	-4.2
200	0.0	2000	-6.5
250	-0.3	2500	-9.4
315	-0.2	3150	-10.3
400	-0.5	4000	-6.6
500	-0.6	5000	-3.2
630	-0.7	6300	-3.3
800	-1.1	8000	-16.0
		(10 000)	(-14.4)

S_{DE} The transfer function DRP to ERP
 $S_{DE} = 20 \log_{10} (P_E/P_D)$
 where: P_E Sound pressure at the ERP
 P_D Sound pressure at the DRP
 NOTE – The values in this table apply to 1/3 octave band measurements only.

Table 2-b – S_{DE} – Twelfth octave measurements

Frequency (Hz)	S _{DE} (dB)	Frequency (Hz)	S _{DE} (dB)	Frequency (Hz)	S _{DE} (dB)	Frequency (Hz)	S _{DE} (dB)
92	0.1	290	-0.3	917	-1.3	2901	-11.0
97	0.0	307	-0.2	972	-1.4	3073	-10.5
103	0.0	325	-0.2	1029	-1.8	3255	-10.2
109	0.0	345	-0.2	1090	-2.0	3447	-9.1
115	0.0	365	-0.4	1155	-2.3	3652	-8.0
122	0.0	387	-0.5	1223	-2.4	3868	-6.9
130	0.0	410	-0.4	1296	-2.6	4097	-5.8
137	0.0	434	-0.6	1372	-3.1	4340	-5.0
145	0.0	460	-0.3	1454	-3.3	4597	-4.2
154	0.0	487	-0.7	1540	-3.9	4870	-3.3
163	0.0	516	-0.6	1631	-4.4	5158	-2.7
173	-0.1	546	-0.6	1728	-4.8	5464	-2.4
183	-0.1	579	-0.6	1830	-5.3	5788	-2.4
193	0.0	613	-0.6	1939	-6.0	6131	-2.5
205	0.1	649	-0.8	2053	-6.9	6494	-3.3
218	0.0	688	-0.8	2175	-7.5	6879	-4.5
230	-0.1	729	-1.0	2304	-8.1	7286	-5.9

Table 2-b – S_{DE} – Twelfth octave measurements

Frequency (Hz)	S _{DE} (dB)	Frequency (Hz)	S _{DE} (dB)	Frequency (Hz)	S _{DE} (dB)	Frequency (Hz)	S _{DE} (dB)
244	-0.2	772	-1.1	2441	-9.1	7718	-9.0
259	-0.3	818	-1.1	2585	-9.5	8175	-14.2
274	-0.3	866	-1.2	2738	-10.4	8659	-20.7

NOTE – The frequencies listed are the 1/12 octave centre frequencies specified in [IEC 61260]. The values apply to 1/12 octave band measurements as well as sine-based measurements. S_{DE} may be determined for immediate frequencies by interpolation on a (log f) versus (lin dB) basis.

5.3 Type 3

The type 3 artificial ear consists of the IEC 60318-4 occluded-ear simulator, to which is added an ear canal extension terminated with a pinna simulation device. Three pinna simulators are recommended, providing the suitable coupling arrangements for measuring different transducer types. The type 3 artificial ear configurations are classified as follows:

- Type 3.1 Concha bottom simulator.
- Type 3.2 Simplified pinna simulator.
- Type 3.3 Pinna simulator (anatomically shaped).
- Type 3.4 Pinna simulator (simplified).

NOTE – Acoustically, open earphones equipped with soft cushions should be positioned against the type 3 artificial ear with the same force as applied in normal use. The force applied in measurements shall always be reported.

5.3.1 Type 3.1 – Concha bottom simulator

The concha bottom simulation is realized in the type 3.1 artificial ear by a flat plate termination of the 10.0 mm ear canal extension.

It is recommended that the type 3.1 artificial ear should be used for measurements on intra-concha earphones, designed for sitting on the bottom of the concha cavity.

The sound pressure measured by the type 3.1 artificial ear is referred to the ear-drum reference point (DRP). The correction function given in Tables 2-a (1/3 octave band measurements) and 2-b (1/12 octave band and sine measurements) shall be used for converting data to the ear reference point (ERP) when it is required to calculate loudness ratings or check results against specifications based on measurements referred to the ERP.

NOTE – For receive loudness rating calculations according to [ITU-T P.79], the real ear loss correction L_E should be set to zero.

5.3.2 Type 3.2 – Simplified pinna simulator

The pinna simulation is realized in the type 3.2 artificial ear by a cavity terminating the 10.0 mm ear canal extension. A well-defined leak from the cavity to the exterior simulates the average human ear loss for telephone handsets which are held either firmly (low leak version) or loosely (high leak version) against the human ear. The construction of the leak may differ depending on the specific application of the type 3.2 artificial ear (see Figure 6 and Tables 3-a and 3-b).

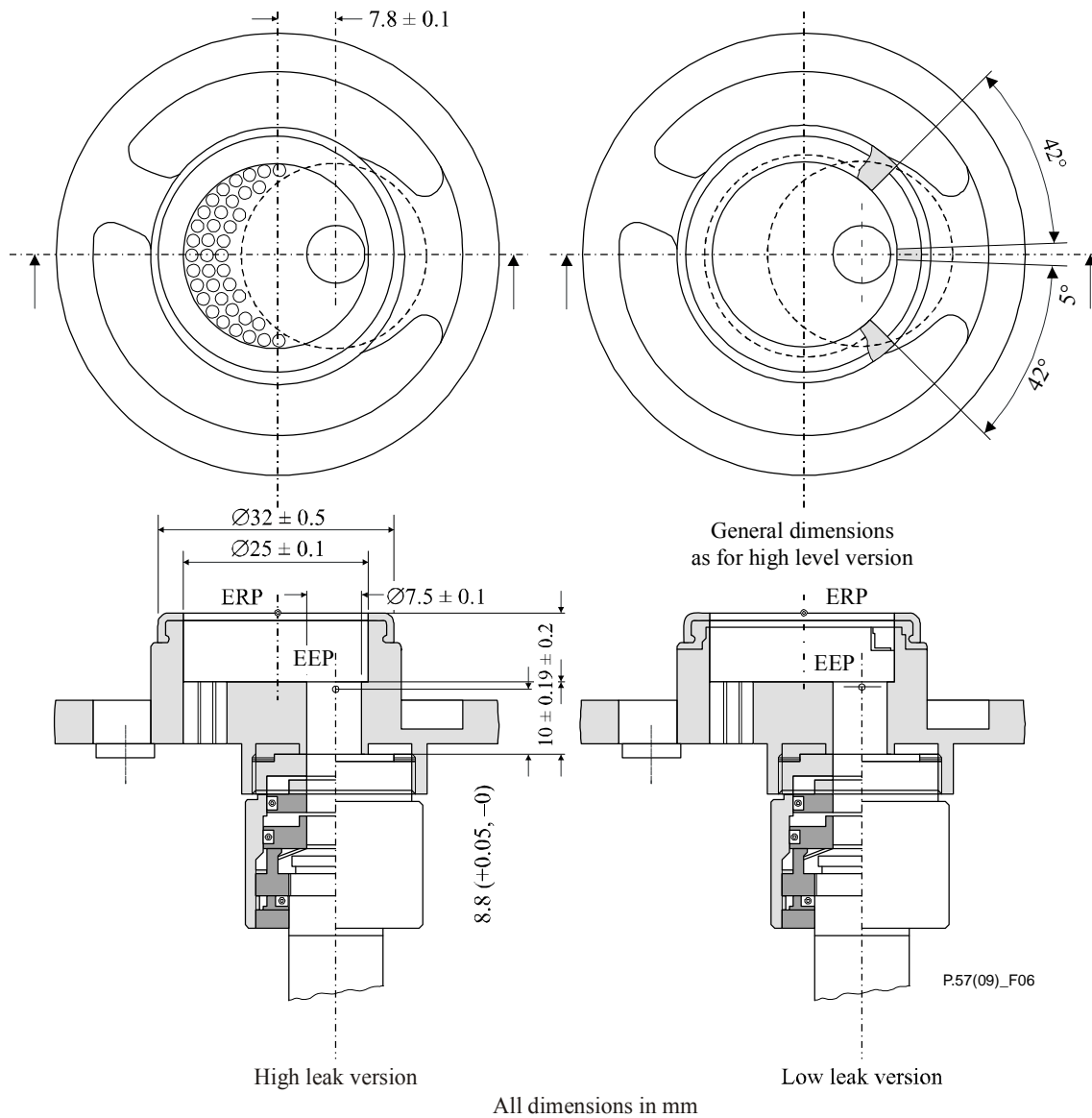

Figure 6 – Example of high leak and low leak simplified pinna simulators for use in an LRGP test head

Table 3-a – Leakage simulation, realized using a slit (type 3.2 artificial ear)

Leakage grade	Use	Slit depth (mm)	Slit height (mm)	Opening angle (degrees)
Low	LRGP/HATS	2.8 ± 0.2	0.26 ± 0.01	84 ± 1
High	HATS	1.9 ± 0.2	$0.50 + 0.01 - 0.03$	240 ± 1

**Table 3-b – Leakage simulation, realized using cylindrical holes
(type 3.2 artificial ear)**

Leakage grade	Use	Number of holes	Diameter (mm)	Depth (mm)
High	LRGP	33	1.7	8.5 ± 0.2
		6	1.8	8.5 ± 0.2

It is recommended that the type 3.2 artificial ear with a high- or low-grade leak should be used for measurements on supra-aural or supra-concha, hard-cap receivers, which naturally seal to the simulator rim, intended for both narrow-band and wideband telephony applications (100 Hz to 8 kHz). It is also recommended for measurements on low acoustic impedance receivers.

The acoustic input impedance and the frequency sensitivity response of the type 3.2 artificial ear are determined with reference to the ERP as specified in clause 5.4. The nominal modulus of the impedance curve and the corresponding tolerance limits are given in Tables 4-a, 4-b and 4-c.

NOTE 1 – The leakage grade ("high" or "low") adopted in measurements shall be reported. The low-grade leak intends to simulate real ear loss for a receiver pressed firmly to the ear, while the high-grade leak intends to simulate real ear loss for a loosely coupled receiver.

NOTE 2 – The type 3.2 artificial ear emulates the human ear canal, with the microphone diaphragm at the eardrum position. Hence, in addition to the particular microphone characteristics, the frequency sensitivity response of the artificial ear includes an individual ERP to DRP transfer function. It is essential, therefore, that measurement values are corrected for the frequency sensitivity response calibration data (open ear condition) provided with the particular artificial ear used.

NOTE 3 – For receive loudness rating calculations according to [ITU-T P.79], the real ear loss correction L_E should be set to zero.

NOTE 4 – The ERP to DRP transfer function depends significantly on the acoustic loading of the ear. For diagnostic purposes (e.g., to interpret differences to measurements made using the type 1 artificial ear), the type 3.2 artificial ear may be supplied with calibration data recorded under closed-ear conditions or other well-defined acoustical terminations.

NOTE 5 – The flat plate termination of the ear canal extension provided by the type 3.2 artificial ear is a possible implementation of the type 3.1 artificial ear.

NOTE 6 – The type 3.2 artificial ear is only intended for use with earphones designed to operate in close contact with the real pinna.

NOTE 7 – All dimensions determining the acoustic leak are for guidance only. They may be modified slightly for different commercial designs in order to obtain the nominal acoustic input impedance.

NOTE 8 – It is recommended to use an application force between 5 N and 10 N for placing hard ear-caps against the type 3.2 artificial ear. The force applied in the measurements shall always be reported.

NOTE 9 – For receivers that do not naturally seal to the simulator rim, an adaptor may be created for the specific geometry of the receiver. This adaptor may be machined or injection moulded and shall not alter the specified concha volume or leak. The adaptor shall be made from a material which cannot be altered, shaped or modified by the person performing the testing.

All leakage-related dimensions are for guidance only – see also Figure 6. Practical implementation must always be optimized with respect to the acoustical specifications.

**Table 4-a – Acoustical impedance, resonance, and Q-factors
(type 3.2 – low and high leak)**

	Q-factor	Resonance (Hz)	Magnitude (dB)
Low leak	1.81	713.8	140.4
Tolerance (±)	0.18	25.0	1.0
High leak	3.5	1570.0	138.8
Tolerance (±)	0.35	50.0	1.5

Table 4-b – Acoustical impedance (type 3.2 – low leak)

Frequency (Hz)	Acoustical imp. (dB re 1 Pa s/m³)	Tolerance (± dB)	Frequency (Hz)	Acoustical imp. (dB re 1 Pa s/m³)	Tolerance (± dB)
100	125.77	4.00	950	137.18	1.00
106	126.07	4.00	1000	136.33	1.00
112	126.18	4.00	1060	135.34	1.00
118	126.28	4.00	1120	134.40	1.00
125	126.44	4.00	1180	133.48	1.00
132	126.60	4.00	1250	132.46	1.00
140	126.74	4.00	1320	131.48	1.00
150	127.26	4.00	1400	130.40	1.00
160	127.27	4.00	1500	129.10	1.00
170	127.42	3.73	1600	127.85	1.00
180	127.79	3.47	1700	126.69	1.00
190	127.89	3.23	1800	125.58	1.00
200	128.10	3.00	1900	124.46	1.00
212	128.44	3.00	2000	123.45	1.00
224	128.71	3.00	2120	122.38	1.26
236	129.01	3.00	2240	121.22	1.51
250	129.31	3.00	2360	119.99	1.74
265	129.66	2.75	2500	118.69	2.00
280	130.08	2.51	2650	117.60	2.00
300	130.46	2.21	2800	116.99	2.00
315	130.92	2.00	3000	117.47	2.00
335	131.50	2.00	3150	117.91	2.00
355	132.02	2.00	3350	118.74	2.00
375	132.52	2.00	3550	119.23	2.00
400	133.23	2.00	3750	118.77	2.00
425	133.95	1.73	4000	116.22	2.00
450	134.72	1.47	4250	111.62	2.27
475	135.32	1.23	4500	108.19	2.53

Table 4-b – Acoustical impedance (type 3.2 – low leak)

Frequency (Hz)	Acoustical imp. (dB re 1 Pa s/m ³)	Tolerance (± dB)	Frequency (Hz)	Acoustical imp. (dB re 1 Pa s/m ³)	Tolerance (± dB)
500	136.08	1.00	4750	111.36	2.77
530	136.97	1.00	5000	114.89	3.00
560	137.78	1.00	5300	117.80	3.00
600	138.75	1.00	5600	119.87	3.00
630	139.45	1.00	6000	121.93	3.00
670	140.13	1.00	6300	123.19	3.00
710	140.32	1.00	6700	124.61	3.00
750	140.30	1.00	7100	125.81	3.00
800	139.76	1.00	7500	126.90	3.00
850	138.99	1.00	8000	128.12	3.00
900	138.09	1.00			

Table 4-c – Acoustical impedance (type 3.2 – high leak)

Frequency (Hz)	Acoustical imp. (dB re 1 Pa s/m ³)	Tolerance (± dB)	Frequency (Hz)	Acoustical imp. (dB re 1 Pa s/m ³)	Tolerance (± dB)
100	105.4	4.0	950	127.7	1.5
106	105.9	4.0	1000	128.4	1.5
112	106.2	4.0	1060	129.4	1.5
118	106.7	4.0	1120	130.5	1.5
125	107.3	4.0	1180	131.7	1.5
132	107.7	4.0	1250	133.3	1.5
140	108.3	4.0	1320	134.9	1.5
150	108.9	4.0	1400	137.2	1.5
160	109.6	4.0	1500	138.1	1.5
170	110.1	3.7	1600	138.1	1.5
180	110.6	3.5	1700	137.1	1.5
190	111.1	3.2	1800	135.8	1.5
200	111.5	3.0	1900	134.0	1.5
212	112.1	3.0	2000	133.0	1.5
224	112.4	3.0	2120	130.7	2.0
236	113.0	3.0	2240	128.3	2.0
250	113.4	3.0	2360	126.3	2.0
265	114.0	2.8	2500	124.2	2.0
280	114.5	2.5	2650	122.6	2.0
300	115.0	2.2	2800	121.5	2.0
315	115.5	2.0	3000	121.7	2.0

Table 4-c – Acoustical impedance (type 3.2 – high leak)

Frequency (Hz)	Acoustical imp. (dB re 1 Pa s/m ³)	Tolerance (± dB)	Frequency (Hz)	Acoustical imp. (dB re 1 Pa s/m ³)	Tolerance (± dB)
335	116.1	2.0	3150	121.9	2.0
355	116.6	2.0	3350	122.6	2.0
375	117.1	2.0	3550	123.3	2.0
400	117.7	2.0	3750	123.4	2.0
425	118.4	1.5	4000	121.7	2.0
450	118.8	1.5	4250	118.2	2.3
475	119.3	1.5	4500	113.8	2.5
500	120.0	1.5	4750	110.9	2.8
530	120.6	1.5	5000	113.6	3.0
560	121.1	1.5	5300	116.6	3.0
600	121.9	1.5	5600	118.9	3.0
630	122.3	1.5	6000	121.3	3.0
670	123.0	1.5	6300	122.7	3.0
710	123.6	1.5	6700	124.3	3.0
750	124.4	1.5	7100	125.7	3.0
800	125.2	1.5	7500	126.9	3.0
850	126.1	1.5	8000	128.3	3.0
900	126.9	1.5			

5.3.3 Type 3.3 – Pinna simulator

The type 3.3 artificial ear is realized by terminating the real ear canal extension with the pinna simulator defined in this Recommendation (see Figures 7-a, 7-b, 7-c and 7-d). The dots in Figure 7-b are located on a vertical axis through the ear canal entrance point. The pinna simulator shall be made from a high-quality elastomer, the hardness of which – measured at the surface 15 mm forward to the ear canal opening – should be $35 \pm 6^\circ$ Shore-OO. Measurement techniques are described in [b-DIN 53505] and [b-ASTM D2240].

It is recommended that the type 3.3 artificial ear be used for measurements on all types of devices.

The sound pressure measured by the type 3.3 artificial ear is referring to the ear-drum reference point (DRP). The correction function given in Tables 2-a (1/3 octave band measurements) and 2-b (1/12 octave band and sine measurements) shall be used for converting data to the ear reference point (ERP) when it is required to calculate loudness ratings or check results against specifications based on measurements referring to the ERP.

NOTE 1 – For receive loudness rating calculations according to [ITU-T P.79], the real ear loss correction L_E should be set to zero.

NOTE 2 – The application force of hard ear-caps against the type 3.3 pinna simulator should preferably be about 10 N. The force applied in the measurements shall always be reported.

NOTE 3 – HATS with flexible pinna simulators are the only artificial ears recommended for headset measurements as described in [ITU-T P.380]. However, in case other types of artificial ears are used and draw different measurement results against type 3.3 artificial ears, the results from type 3.3 artificial ears shall take precedence.

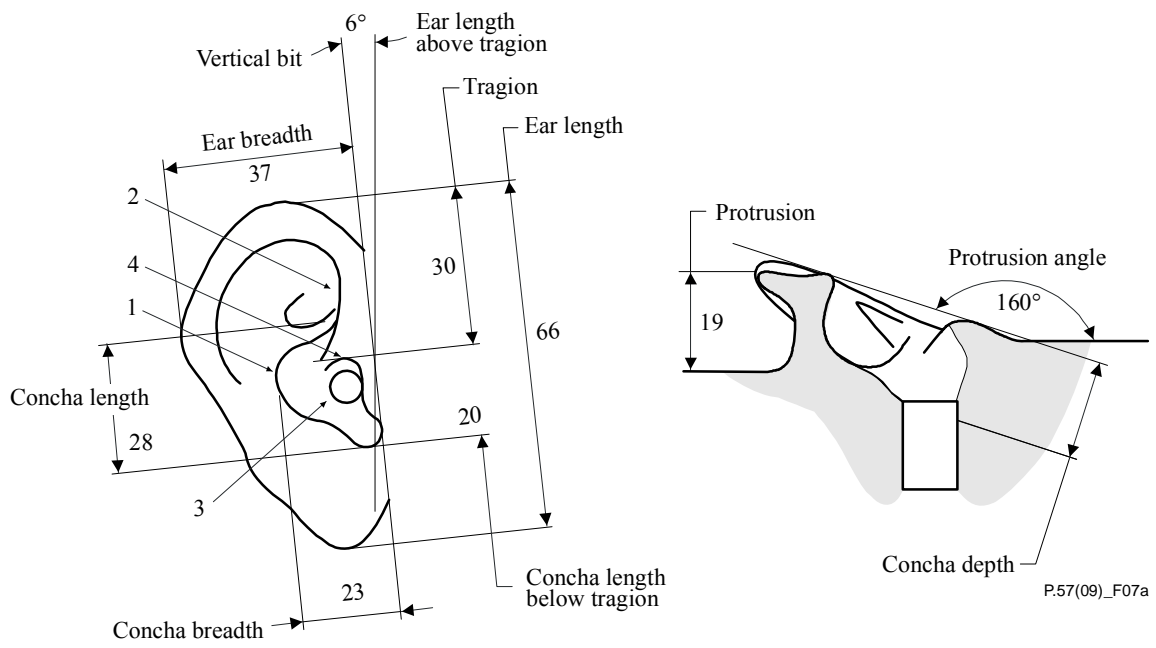

a) Cross-view

b) Cross section

- 1 Anti-helix
- 2 Crus of helix
- 3 Concha
- 4 Tragion

NOTE – Not to scale; units in mm.

Figure 7-a – Anatomically shaped pinna simulator

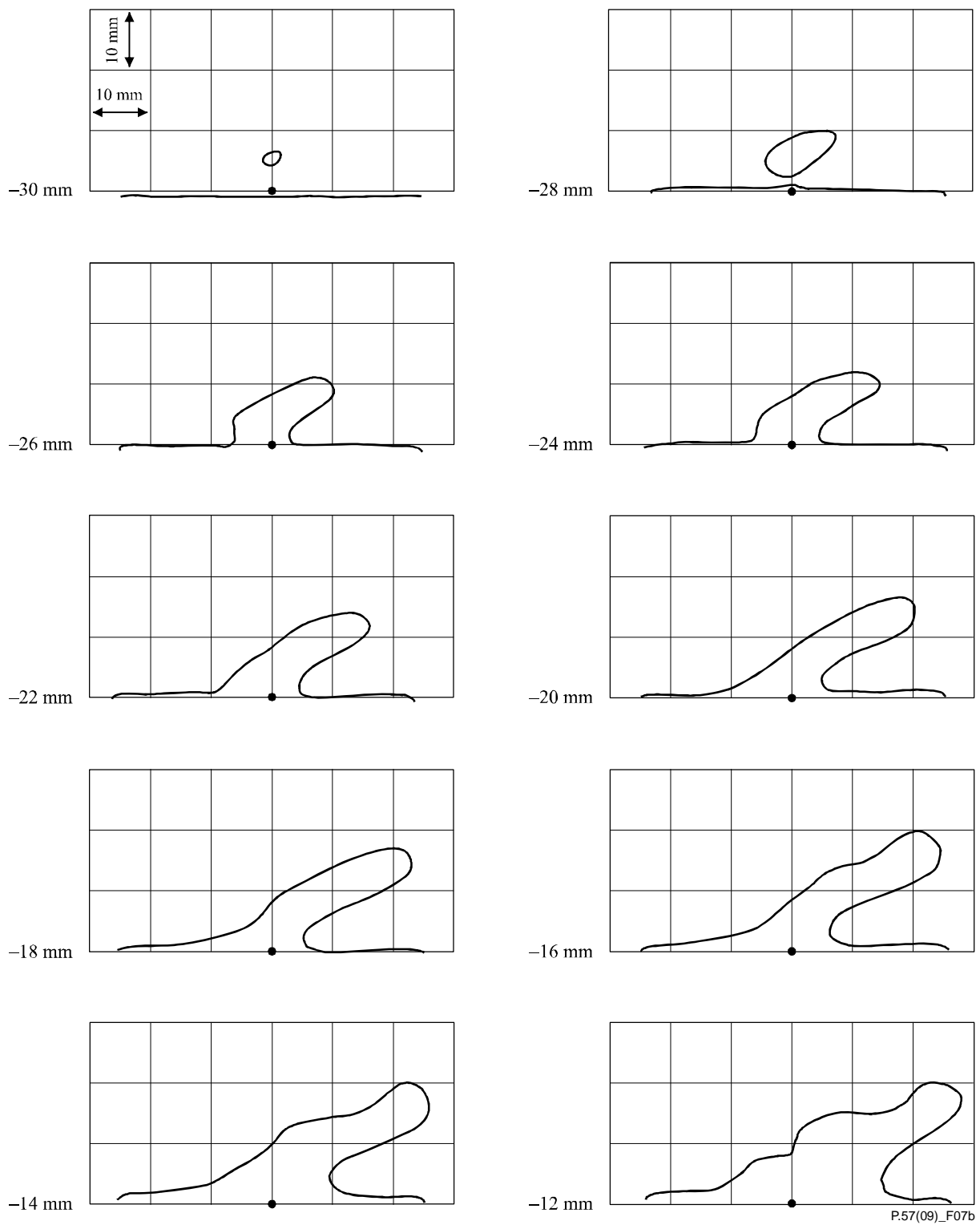

P.57(09)_F07b

Figure 7-b – Pinna simulator cross-sections

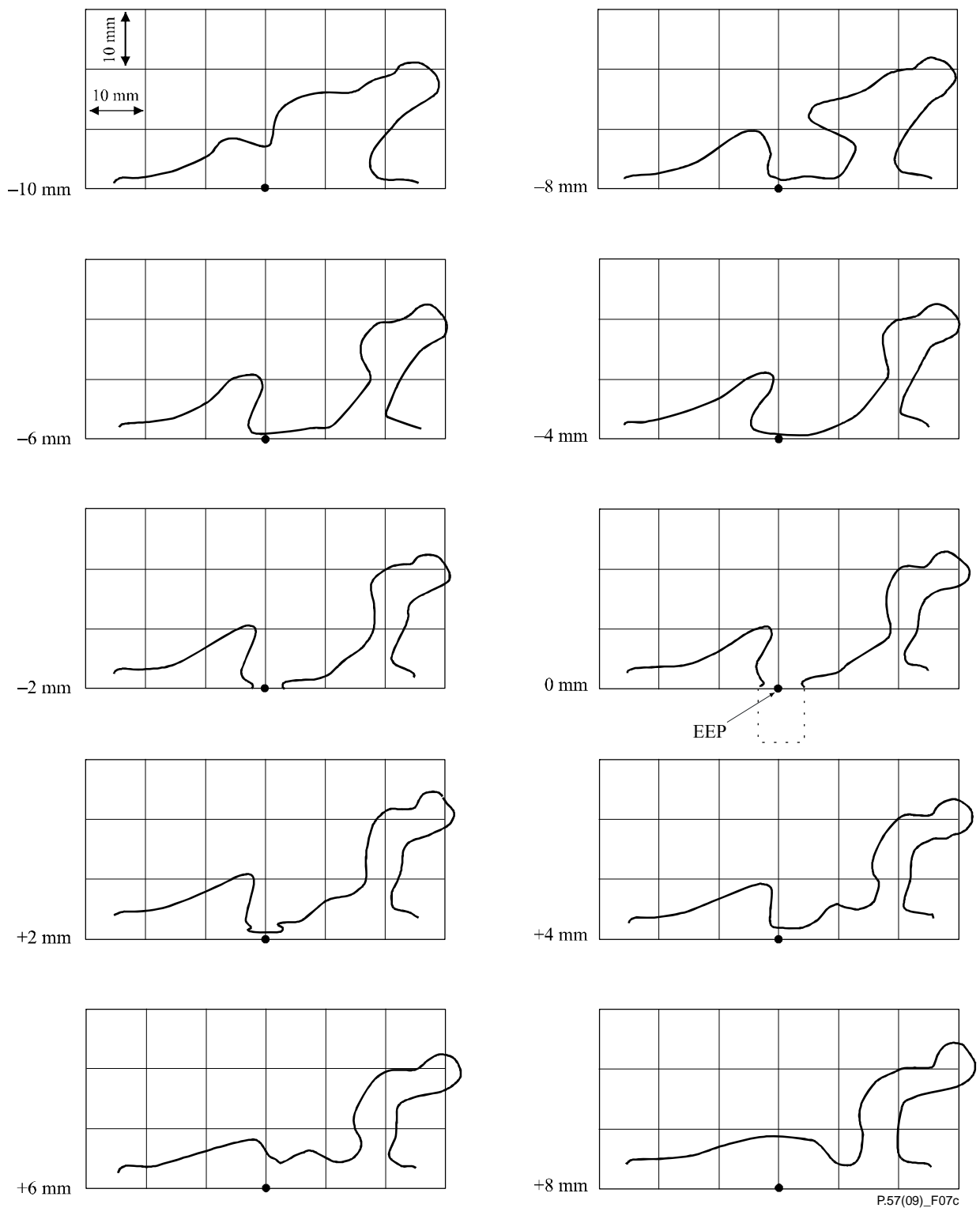
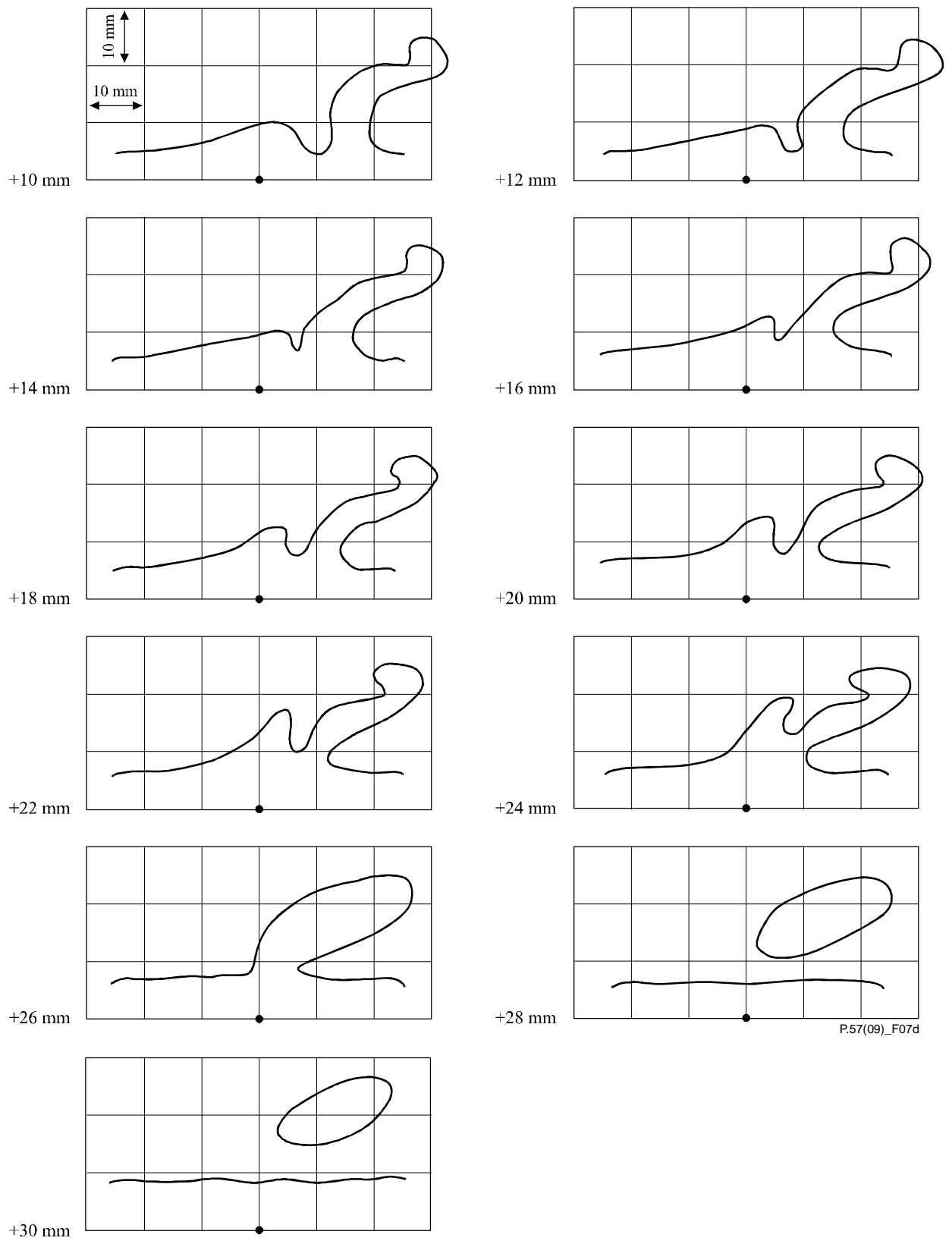

Figure 7-c – Pinna simulator cross-sections



P.57(09)_F07d

Figure 7-d – Pinna simulator cross-sections

5.3.4 Type 3.4 – Pinna simulator (simplified)

The pinna simulation is realized in the type 3.4 artificial ear by terminating the drum reference plane of the type 2 artificial ear with an ear canal extension and a simplified pinna (see Figure 8). The pinna shall be made from an elastomer with a Shore-A hardness of 25 ± 2 at $20^\circ \text{C} \pm 2^\circ \text{C}$.

It is recommended that the type 3.4 artificial ear be used as an alternative to the type 3.3 for measurements on all types of devices except supra-concha headsets, supra-aural headsets and forward facing intra-concha headsets (acoustic outlets that do not face the ear canal). The type 3.4 artificial ear is intended to reproduce the typical handset leakage occurring in real use for pressure forces in the range of 1 N and 13 N.

The sound pressure measured by the type 3.4 artificial ear is referred to the ear-drum reference point (DRP). The correction function given in Tables 2-a (1/3 octave band measurements) and 2-b (1/12 octave bands and sine measurements) shall be used for converting data to the ear reference point (ERP) when it is required to calculate loudness ratings or check results against specifications based on measurements referred to the ERP.

NOTE – For receive loudness rating calculations according to [ITU-T P.79], the real ear loss correction L_E should be set to zero.

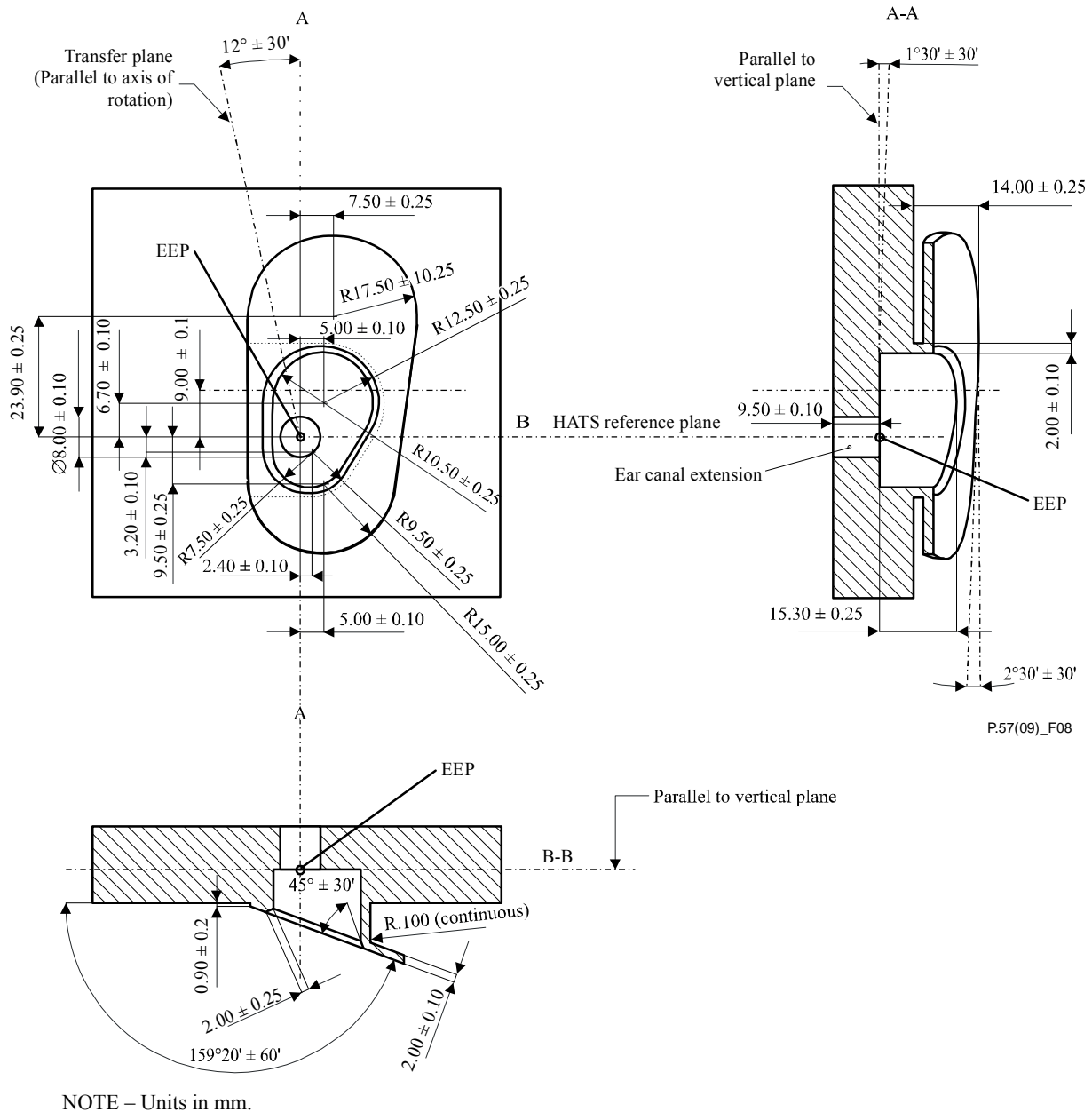

Figure 8 – Type 3.4 artificial ear

5.4 Calibration of the artificial ears type 1 and type 3.2

5.4.1 Performance testing of the IEC 60318-4 occluded-ear simulator (type 3.2 only)

The proper performance of the IEC 60318-4 occluded-ear simulator, which is an integral part of the type 3.2 artificial ear, is essential to the performance of the complete artificial ear.

NOTE – Performance testing and calibration of the occluded-ear simulator are specified in [IEC 60318-4].

5.4.2 Frequency sensitivity response

The artificial ear to be calibrated is mounted in a large plane baffle. The sound pressure is measured immediately in front of the ERP using a probe microphone with its probe tip (diameter less than 1.5 mm) positioned at the ear reference plane as indicated in Figure 9.

The frequency sensitivity response (open ear condition) is then defined as the ratio between the output of the artificial ear and the corresponding sound pressure at the ERP recorded by the probe microphone when subjected to a plane incident wave perpendicular to the baffle.

NOTE 1 – The frequency sensitivity response has a very low sensitivity to the positioning of the sound source. In practice, therefore, more compact calibration set-ups may be realized with or without correction of the results, depending on the required calibration accuracy.

NOTE 2 – The frequency sensitivity response under closed ear conditions may be measured using the calibration set-up for acoustic input impedance described in clause 5.4.3. It is determined as the ratio between the output of the artificial ear and the sound pressure recorded by the probe microphone at the ERP.

NOTE 3 – The frequency sensitivity response shall normally be determined within the range of atmospheric reference conditions given in clause 5.6 at the frequencies listed in Table 2-b. The actual atmospheric conditions shall be reported. When the artificial ear operating conditions are significantly different from the reference conditions, the calibration of the frequency sensitivity response should, if possible, be performed under the operating conditions.

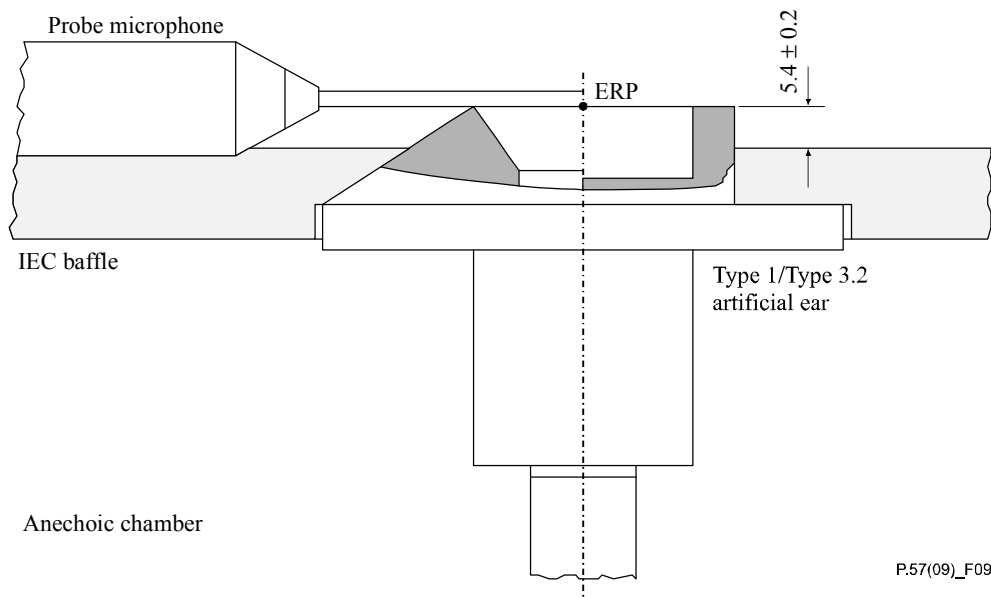

P.57(09)_F09

Figure 9 – Set-up for measuring the frequency sensitivity response (open ear conditions) of type 1 and type 3.2 artificial ears

5.4.3 Acoustic input impedance

A 1/2" working-standard pressure microphone (IEC WS2P) with its protection grid mounted is placed in a flat surface and concentrically applied and sealed to the artificial ear for use as a constant volume velocity source, driving the artificial ear at the ERP. The corresponding sound pressure at the ERP shall be measured using a probe microphone with its probe tip (diameter less than 1.5 mm) positioned at the ERP. The distance between the microphone grid and the pickup point of the ear simulator shall be less than 1 mm. A practical implementation of a calibration device is shown in Figure 10.

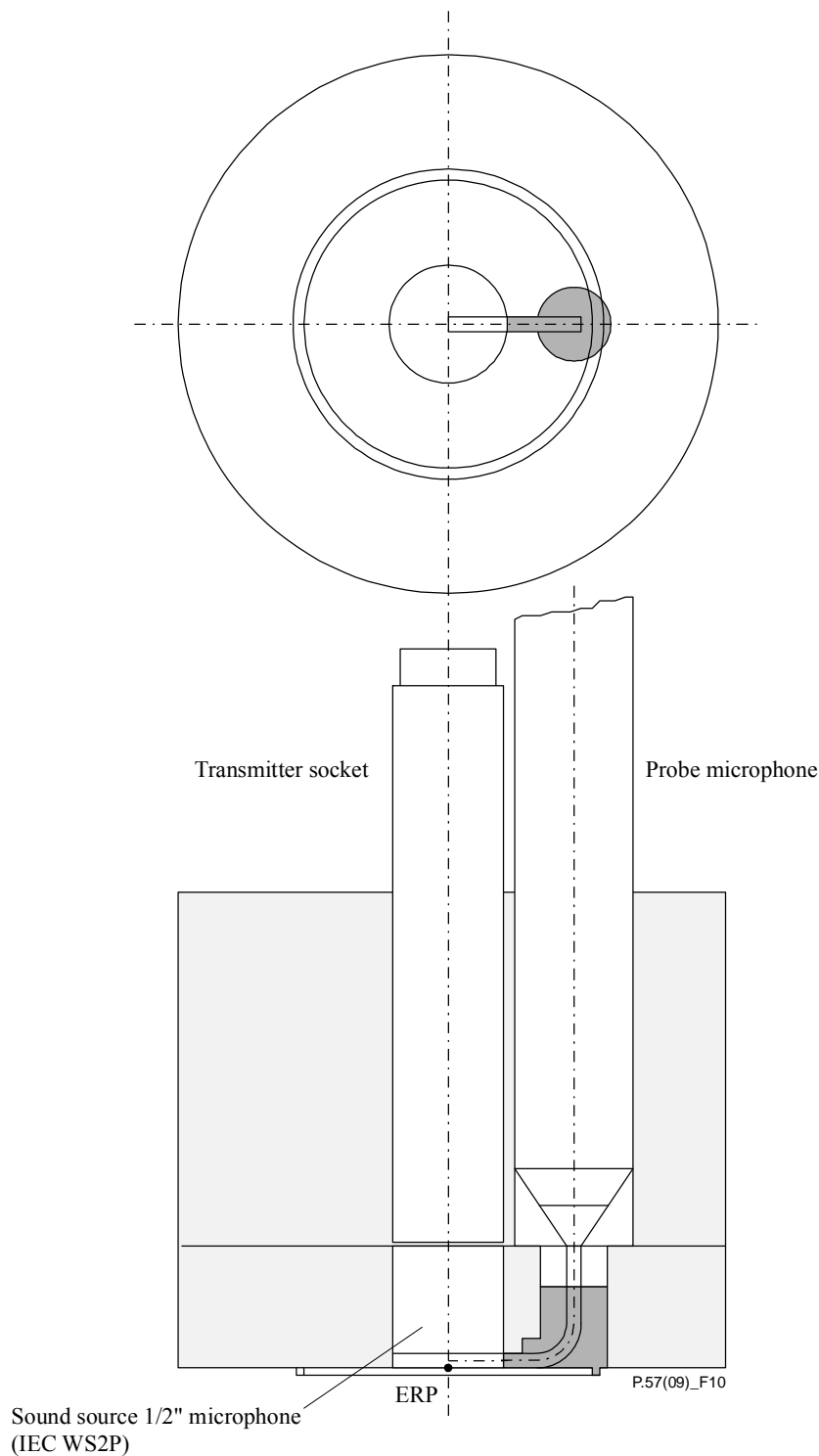

Figure 10 – Practical implementation of a calibration device (impedance probe) for measuring acoustical input impedance of type 1 and type 3.2 artificial ears

The acoustic input impedance is then defined as the ratio between the sound pressure recorded by the probe microphone and the volume velocity generated by the 1/2" microphone.

NOTE – The acoustic input impedance shall be determined within the range of atmospheric reference conditions given in clause 5.6. The actual conditions shall be reported.

Annex A contains a practical description of a procedure which allows complete calibration based on a calibrated reference microphone and a calibrated volume.

5.5 Performance verification of the artificial ears types 2, 3.1, 3.3 and 3.4

These types of artificial ears do not provide a well-defined ERP, as they either do not simulate the pinna or feature a flexible pinna which may cause the frequency sensitivity response and acoustical input impedance to change as a function of application pressure. Thus, an actual calibration with respect to frequency sensitivity response as well as acoustic input impedance is not relevant.

The performance verification of these artificial ears, therefore, relies exclusively on the performance testing and calibration of the occluded ear simulator as specified in [IEC 60318-4] in combination with a verification of the mechanical properties of the pinna simulator (Types 3.3 and 3.4 only).

5.6 Atmospheric reference conditions

It is recommended that measurements using artificial ears be performed under the following reference conditions:

Static pressure: 101.3 ± 3.0 kPa

Temperature: $23 \pm 3^\circ$ C

Humidity: $60 \pm 20\%$

NOTE – When it is required to perform measurements under other atmospheric conditions, the actual conditions shall be reported.

5.7 General requirements

The metallic parts composing the artificial ears shall be made of non-magnetic material.

NOTE – The IEC WS2P microphones used in the artificial ears may contain magnetic material.

5.8 Ear-drum reference point to ear reference point correction

While type 2, 3.3 and 3.4 artificial ears are calibrated by applying a known acoustic pressure to the DRP, Types 1 and 3.2 are calibrated by applying a known acoustic pressure to the ERP. As a consequence, the acoustic pressure measured by means of Types 2, 3.3 and 3.4 shall be referred to the ERP by means of the standardized correction functions reported in Tables 2-a and 2-b, while the pressure measured by Types 1 and 3.2 is directly referring to the ERP.

NOTE – The individual calibration of Types 1 and 3.2 can either be provided by the manufacturer in terms of the overall electro-acoustic sensitivity from the ERP to the electric output of the measurement microphone built into the artificial ear, or in terms of the level correction between the acoustic pressure measured by the built-in microphone and the pressure at the ERP. The latter approach is preferable as it allows for an easier routine check of the artificial ear's calibration.

Annex A

A practical procedure for determination of the acoustic input impedance of artificial ears

(This annex forms an integral part of this Recommendation.)

A.1 Introduction

The procedure described in this annex allows accurate and traceable calibration of the acoustic input impedance of artificial ears type 1 and type 3.2 as required in clause 5.4.3. Additionally, the calibration set-up allows determination of the closed condition frequency sensitivity response of the artificial ears.

The procedure relies on the availability of a laboratory-standard 1/2" pressure microphone (IEC LS2P) calibrated with respect to its frequency sensitivity response, and a calibrated reference volume.

The set-up required to perform the measurements is shown in Figure A.1. It is based upon an audio frequency response analyser and an impedance probe consisting of a 1/2" working-standard pressure microphone (IEC WS2P) used as transmitter, and a probe microphone used as receiver (see Figure 10).

The reference microphone and the reference volume are used to determine the relative frequency sensitivity responses of the transmitter and probe microphones in the impedance probe prior to the calibration of the artificial ear itself. For this purpose, the reference microphone is mounted in a calibration unit, positioned as closely as possible to the probe tip integrated in the impedance probe.

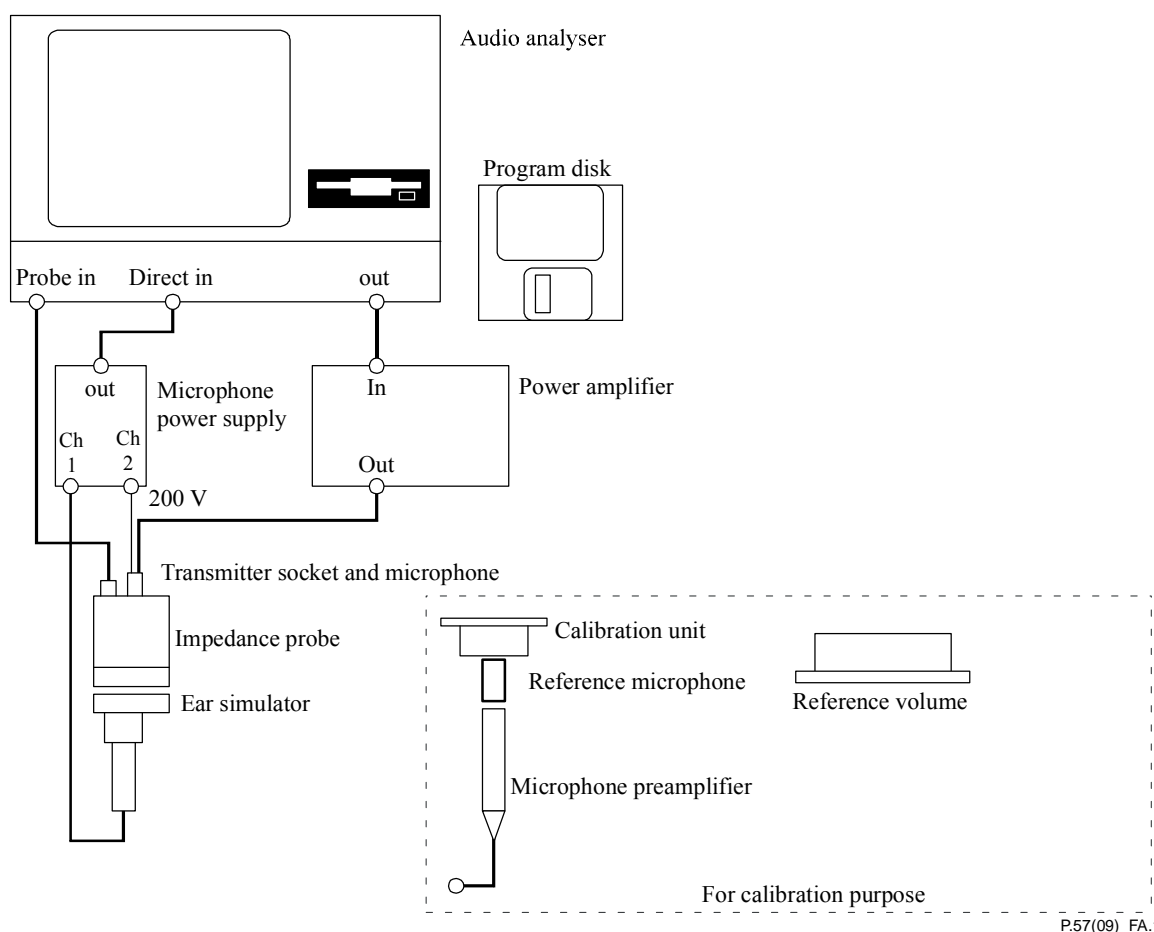

Figure A.1 – Measurement set-up

A.2 Calibration of the impedance probe

A.2.1 Frequency response of the probe microphone

The reference microphone (Figure A.1) is mounted in the calibration unit and the calibration unit is placed in a suitable test bench. The impedance probe is attached to the calibration unit and the reference microphone is now used to calibrate the probe microphone. This is done by measuring the frequency response of the probe microphone relative to the frequency response of the reference microphone. The signal is delivered by the transmitter microphone of the impedance probe. The absolute frequency response of the probe microphone in [V/Pa] is then obtained as follows:

$$H_{\text{Prb.Abs}}(f) = \left[\frac{V_{\text{O,Prb}}(f)}{V_{\text{O,Ref}}(f)} \right] \cdot H_{\text{RefCal}}(f)$$

where:

- $H_{\text{Prb.Abs}}(f)$ = Absolute frequency response of the probe microphone
- $V_{\text{O,Prb}}(f)$ = Probe microphone output voltage in calibration unit
- $V_{\text{O,Ref}}(f)$ = Reference microphone output voltage in calibration unit
- $H_{\text{RefCal}}(f)$ = Absolute calibrated reference microphone response

A.2.2 Relative frequency response of the transmitter microphone

Apart from a constant factor, the transmitter microphone capsule in the impedance probe has the same frequency sensitivity when used as a volume source as it does during its normal use as a receiver. Hence, the same method and set-up used for the probe microphone calibration is used to calibrate the transmitter microphone of the impedance probe. The only difference is that now the reference microphone delivers the signal, and the calibrated probe microphone is used to calibrate the transmitter microphone which, in this case, is used as a receiver:

$$H_{\text{Tr.Abs.Mic}}(f) = \left[\frac{V_{\text{O,Tr}}(f)}{V_{\text{O,Prb}}(f)} \right] \cdot H_{\text{Prb.Abs}}(f)$$

where:

- $H_{\text{Tr.Abs.Mic}}(f)$ = Absolute microphone frequency response of the transmitter microphone
- $V_{\text{O,Prb}}(f)$ = Probe microphone output voltage in calibration unit
- $V_{\text{O,Tr}}(f)$ = Transmitter microphone output voltage in calibration unit
- $H_{\text{Prb.Abs}}(f)$ = Absolute frequency response of the probe microphone (as measured above)

The frequency response of the transmitter microphone, relative to the sensitivity at a reference frequency (f_0), when used as a volume velocity source is then:

$$H_{\text{Tr.Rel.Src}}(f) = \frac{H_{\text{Tr.Abs.Mic}}(f)}{H_{\text{Tr.Abs.Mic}}(f_0)} \cdot (f/f_0)$$

where the term (f/f_0) relates to the fact that the transmit sensitivity is expressed in terms of volume velocity rather than volume.

A.2.3 Absolute sensitivity of the transmitter microphone as a volume velocity source

The additional factor describing the absolute sensitivity of the transmitter microphone, when used as a volume velocity source, remains to be determined. This factor is found by measuring the sound pressure level produced by the transmitter microphone in the reference volume. The reference volume is placed in the test bench and the impedance probe is attached to the reference volume. The

nominal acoustical impedance in [Pa s/m³] equals one divided by the acoustic compliance (C_a) of the reference volume:

$$Z_{a,Ref.Vol} = \frac{1}{j\omega_a} = \frac{\rho c^2}{j\omega V}$$

It is recommended that the reference volume has a size comparable to the volume of the artificial ears. For a known excitation voltage, $V_{i,Tr.Mic}$, the sound pressure, $p_{Pr.Mic}$, is measured at a low frequency (f_0) where the frequency response of the transmitter microphone is frequency independent and the reference volume behaves as an ideal compliance. The absolute sensitivity factor of the transmitter microphone in [m³/Vs] is calculated as follows:

$$S_{Tr.Src} = \frac{p_{Pr.Mic}(f_0)}{[Z_{a,Ref.Vol}(f_0) \cdot V_{i,Tr.Mic}(f_0)]}$$

Thus the absolute sensitivity of the transmitter microphone, when used as a volume velocity source, is:

$$H_{Tr.Abs.Src}(f) = H_{Tr.Rel.Src}(f) \cdot S_{Tr.Src}$$

A.3 Artificial ear calibration

A.3.1 Determination of acoustical impedance

During the measurements, the artificial ear is placed in a suitable test bench (not shown in Figure A.1). Referring to Figure A.1 the impedance probe is attached to the artificial ear. With the transmitter microphone providing the volume velocity $q(f)$, the sound pressure $p_{ERP}(f)$ at the ERP is measured by the probe microphone of the impedance probe:

$$Z_{Ear,ERP}(f) = \frac{p_{ERP}(f)}{q(f)} = \frac{\left[\frac{V_{O,PrbMic}(f)}{H_{Prb.Abs}(f)} \right]}{\left[\frac{V_{i,Tr.Src}(f)}{H_{Tr.Abs.Src}(f)} \right]}$$

where:

$V_{i,Tr.Src}(f)$ = Input voltage to the transmitter microphone used as a volume velocity source

$V_{O,PrbMic}(f)$ = Output voltage of the probe microphone

A.3.2 Determination of closed condition sound pressure sensitivity

The same set-up is used as for the determination of acoustic input impedance, but the output voltage of the artificial ear relative to the sound pressure at the ERP is measured:

$$H_{Ear,Closed Cond.}(f) = \frac{V_{O,Ear}(f)}{\left[\frac{V_{O,PrbMic}(f)}{H_{Prb.Abs}(f)} \right]}$$

Appendix I

Comparative acoustical input impedance measurements on the artificial ears Types 3.3 and 3.4 and on human ears

(This appendix does not form an integral part of this Recommendation.)

I.1 Introduction

This appendix presents an analysis of the ear impedance measurements made in the ITU-T round-robin test. An overview of the data from this test is presented in clause I.2 followed by a presentation of the measurements made on the type 3.3 and 3.4 artificial ears in clause I.3. Clause I.4 covers the analysis of the human ear measurements which includes two different approaches. A set of univariate analyses is applied first to assess the impedance variable in terms of variability and influence of the different factors for each frequency bin separately. A bivariate parametric analysis is then applied to describe the variability of the impedance and frequency variables for a set of frequency response extrema derived from the human ear measurements. Finally, a comparison between the set of human ear impedance measurements and the impedance measurements made on the type 3.3 and type 3.4 artificial ears is presented in clause I.5 for the two perspectives of univariate and the bivariate structural analyses.

I.2 Data overview

The data from the round-robin test comprised acoustic impedance measured using a phone-like impedance probe at each R40 (1/12th octave), as defined in [b-ISO 3], centre frequencies between 0.2-8 kHz for each test case.

Measurements made on artificial ear types according to this Recommendation at the standard measurement position according to [b-ITU-T P.64] included:

- 1) Measurements by Brüel & Kjær on a type 3.3 right artificial ear with separate test cases for application forces between 2 and 18 N increasing by 2 N steps.
- 2) Measurements by HEAD acoustics on a type 3.4 right artificial ear with separate test cases for application forces between 2 and 18 N increasing by 2 N steps.

This resulted in a total of 18 individual test cases from the 2 ear types (3.3, 3.4) \times 9 application forces (2 N, 4 N, 6 N, 8 N, 10 N, 12 N, 14 N, 16 N, 18 N).

Measurements were also made on the ears of 60 male and 46 female human adult subjects, split between the organizations contributing to the tests. The organizational, geographical and age distribution of the human subjects are:

Contributor (country):

- Lab #1 – Nokia (Finland): 24 subjects
- Lab #2 – Brüel & Kjær (Denmark): 30 subjects
- Lab #3 – HEAD acoustics (Germany): 16 subjects
- Lab #4 – Motorola (USA): 16 subjects
- Lab #5 – Uniden (USA): 20 subjects

Age:

- 20-34 yrs: 38 subjects
- 35-49 yrs: 51 subjects
- \geq 50 yrs: 17 subjects

Two separate measurements were made for each of the 106 human test subjects.

- 'Normal' application force of the handset against the users' ear, inferred from placement in a quiet environment (< 30 dBA background noise).
- 'Firm' application force of the handset against the users' ear, inferred from placement in a noisy environment (< 70 dBA hot noise present).

In both measurement cases, the user defined what application force was required.

This resulted in a total of 212 individual test cases from the 106 subjects (60 male, 46 female) × 2 inferred application forces ('normal', 'firm').

No repetitions of test cases for the artificial or human ears were included.

I.3 Artificial ear measurements

Presented in this clause are the results of measurement on type 3.3 and type 3.4 artificial ears.

NOTE – Although not part of the planned test comparisons, results of measurement on type 3.2 low leak and 3.2 high leak ears are supplied as normative references in clause I.5.3.

I.3.1 HATS 3.3 ear

The set of measurements, made by Brüel & Kjær on a type 3.3 right artificial ear shown in Figure I.1, includes separate test cases for application forces between 2 and 18 N increasing by 2 N steps.

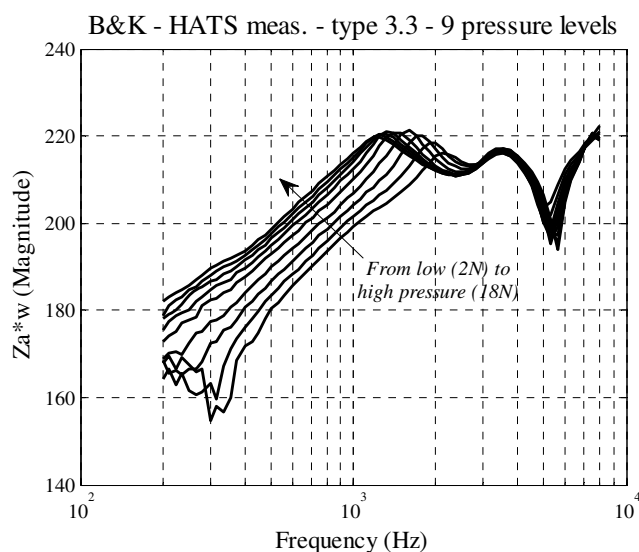

Figure I.1 – Measurement by Brüel & Kjær on a type 3.3 artificial ear with separate test cases for application forces between 2 and 18 N increasing by 2 N steps

I.3.2 HATS 3.4 ear

The set of measurements, made by HEAD acoustics on a type 3.4 artificial ear shown in Figure I.2, includes separate test cases for application forces between 2 and 18 N increasing by 2 N steps.

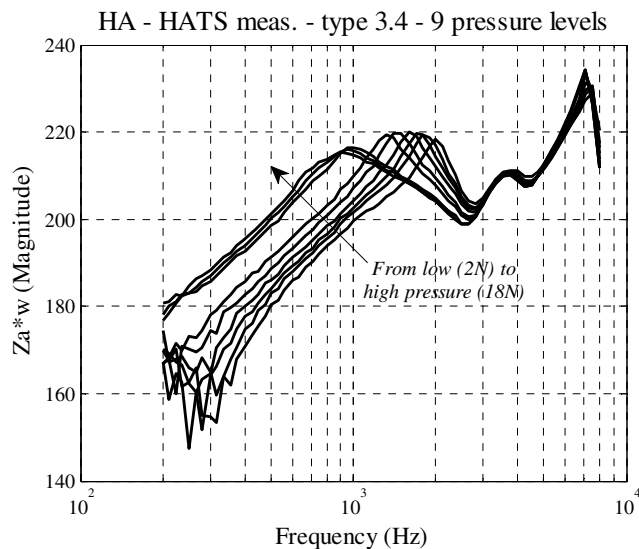

Figure I.2 – Measurement by HEAD acoustics on a type 3.4 artificial ear with separate test cases for application forces between 2 and 18 N increasing by 2 N steps

I.4 Human ear measurements

I.4.1 Univariate analysis of the human ear measurements

I.4.1.1 Descriptive statistics

Figure I.3 presents a statistical summary plot of the impedance versus 1/12th octave band for the normal (a) and firm (b) application force cases separately. Each of these graphs includes a box plot with potential outliers in red and extreme outliers in blue for each of the frequency bins individually. Figure I.3-a shows that the normal application force case contains a set of extreme outlying points, which have been identified as originating from two individual measurements (subjects #12 and #50). The firm application force case does not include any extreme outlying point. An identification of the outlier points from both cases (see graphs in clause I.5.4) highlighted that the outlier points in the two measurement sets are not due to one or several isolated measurements that would be clearly inconsistent with the general shape of this set of impedance measurements.

Figures I.4 and I.5 present an impedance versus frequency bin line chart of the raw data (left plot) and the mean and sample standard deviation (right plot) for the normal and firm application force cases separately. The graph of the raw data for the normal application force clearly shows the two extreme outlying cases highlighted above. Note that these two subjects (#12 and #50) were removed from the analysis presented in subsequent clauses. The standard deviation of the human ear measurements represented by the grey area in the right plots of Figures I.4 and I.5 illustrates the large variability in individual impedance at the different frequency bands.

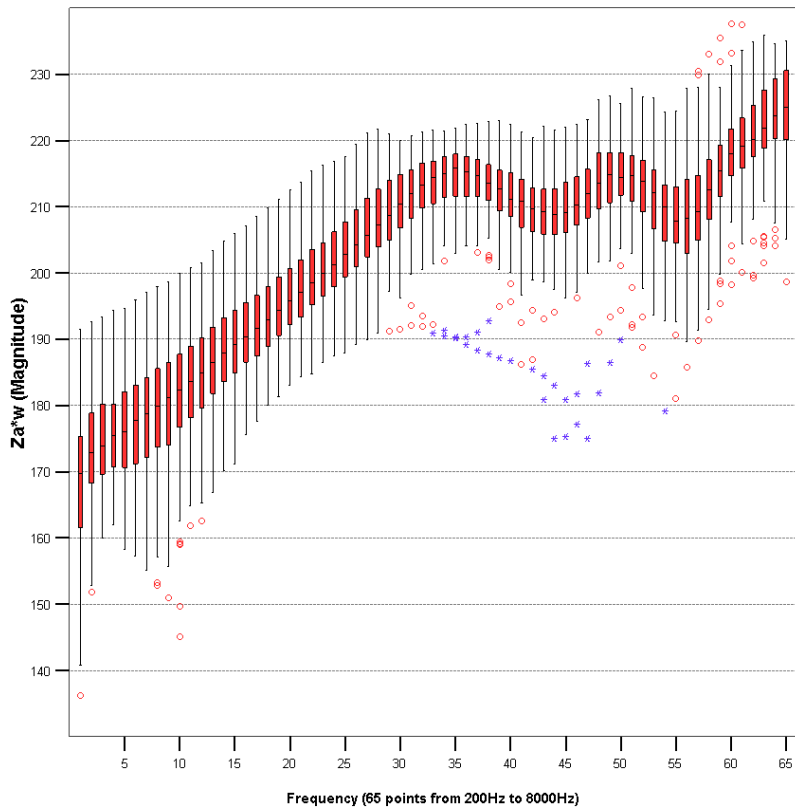

a)

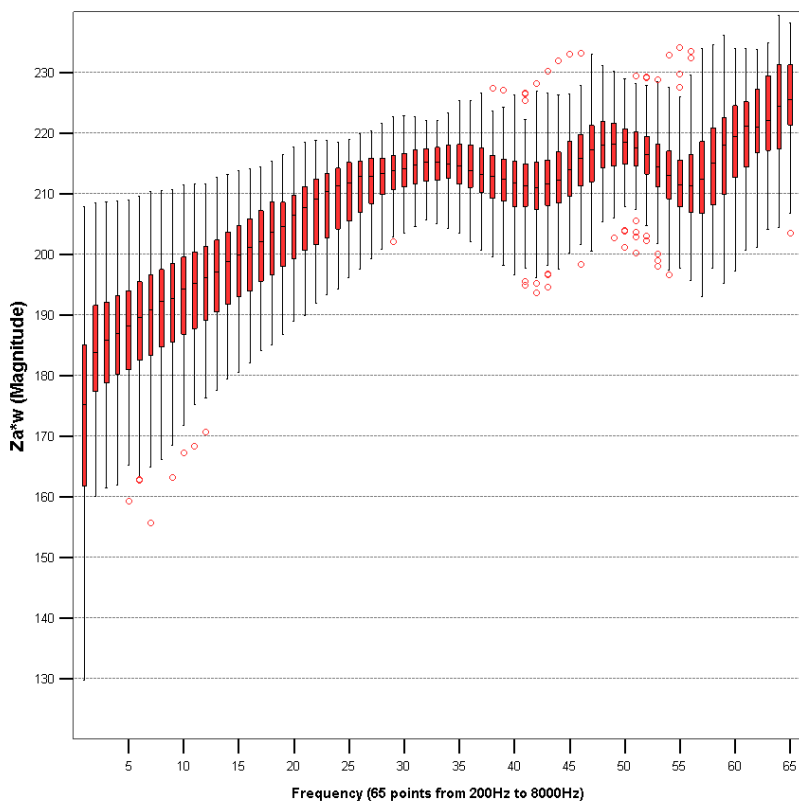

b)

Figure I.3 – Box plot with potential outliers (red circles) and extremes (blue stars) of the impedance versus 1/12th octave band for the normal (a) and firm (b) application force cases

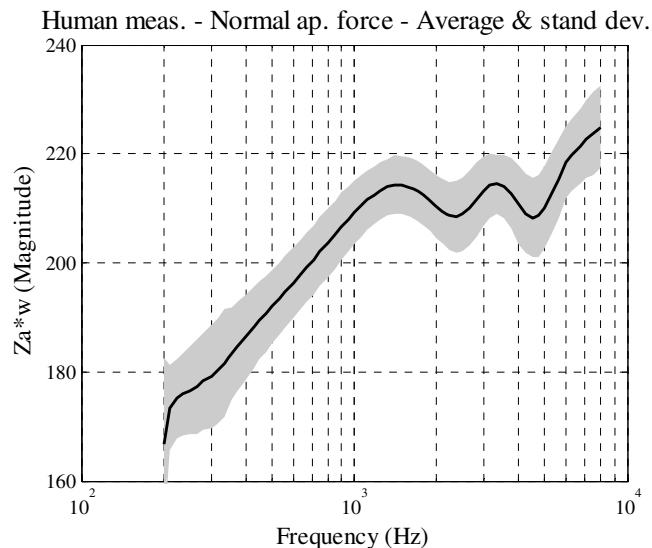
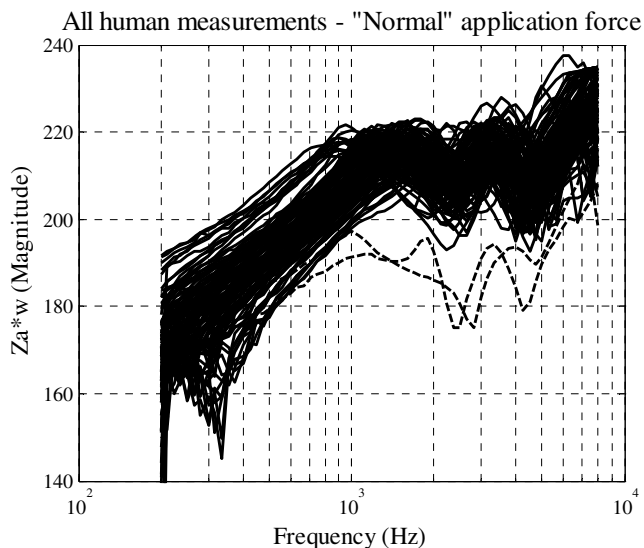

Figure I.4 – Impedance versus frequency bin line chart of the raw data (left plot) and the mean and sample standard deviation (right plot) for the normal application force case

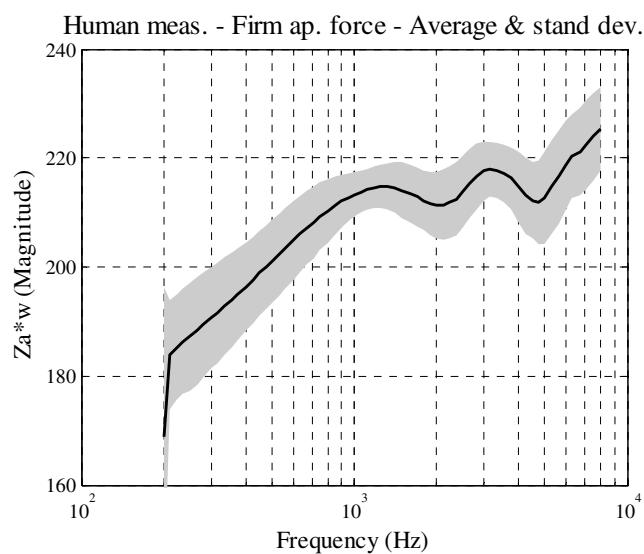
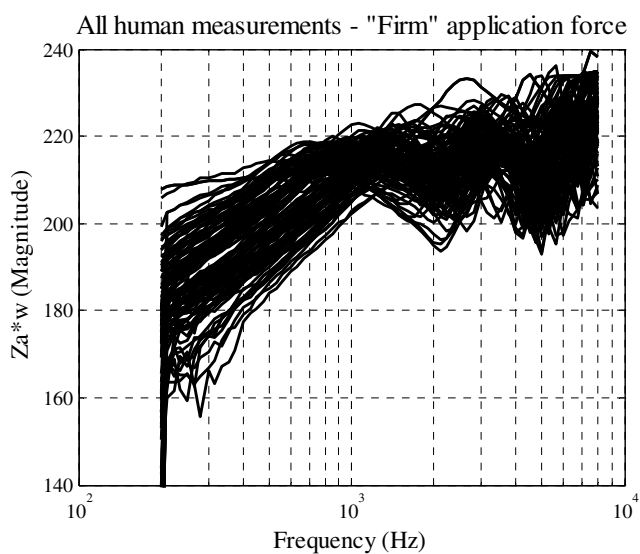

Figure I.5 – Impedance versus frequency bin line chart of the raw data (left plot) and the mean and sample standard deviation (right plot) for the firm application force case

I.4.1.2 Significance testing of experimental factors

An analysis of variance (ANOVA) was applied to each of 65 frequency bins separately considering the four following factors: Lab (five contributing organizations); Force (normal and firm application forces); Subject (104 measured individuals); Gender (male and female). The fact that a given individual was only measured in one laboratory and has one of the two genders has to be accounted for in the ANOVA by considering a nesting of factors. Two separate ANOVA models were considered to handle the nesting of the factor Subject in the factor Lab, on one hand, and the nesting of the factor Subject in the factor Gender, on the other side. The first set of ANOVA models includes the factors Lab, Force, Subject (Lab) and the interaction Lab * Force. The second ANOVA model includes the factors Gender, Force, Subject (Gender) and the interaction Gender * Force. For

each of these two ANOVA models, a summary table of the F-ratios and associated levels of significance for the different factors and interactions is presented for each frequency point in clause I.5.5. In this clause, impedance versus frequency bin line charts are used to display the impedance means and associated 95% confidence intervals about these means for the different factors. Also, significant levels for each ANOVA table in clause I.5.5 are shown to assess the confidence of the differences observed in these graphs.

Figure I.6 illustrates the effect of the factor Force, which is by far the largest for most frequency bins as can be seen from the ANOVA results shown in Tables I.2 and I.3 (clause I.5.5). The difference is clearly visible in Figure I.6 for the frequency range below 1.3 kHz and the range 2.1 kHz to 5 kHz.

The factor Lab (the five contributing organizations) has a much smaller effect than the factor Force as illustrated in the left plot of Figure I.7. The ANOVA results of Table I.2 also highlight some significant differences for this factor in the frequency range 1.9-2.3 kHz and around the frequency 4.2 kHz. Note, however, that the F-ratios are smaller than for the factor Force overall. The right plot of Figure I.7 illustrates the most salient example of the difference observed for this factor when comparing the laboratories Lab #2 and Lab #5. An additional plot is presented in Figure I.8 to compare human ear measurement means per region, i.e., between the three European laboratories (blue line) and the two North American laboratories (red line). This plot illustrates that differences between the two regions are not significant based on the overlapping 95% confidence intervals. The interaction Lab * Force in the ANOVA results shown in Table I.2 (clause I.5.5), shows a significant effect for the same frequency regions as those found for the factor Force. This effect is less important though, as can be seen from the relatively small F-ratios, but it indicates that the application force used by subjects for the two cases might have differed from one laboratory to another.

Considering finally the factor Gender, it appears that human ear measurements made on male and female subjects do not follow the exact same pattern. This difference is illustrated in the left plot of Figure I.9 and is also visible from the ANOVA results of Table I.3 in clause I.5.5. The factor Gender is significant in the region 1.5-2.3 kHz and 3.5-4.5 kHz with relatively high F-ratios. It can be seen however from Table I.3 that the interaction Gender * Force is not significant, except for a few isolated frequency bins, which indicates that the gender difference is not clearly related to a difference in application force. The right plot of Figure I.9 compares human ear measurement means per gender and per application force. This graph illustrates that differences seen between the two genders follow roughly the same pattern for the normal and firm application force cases.

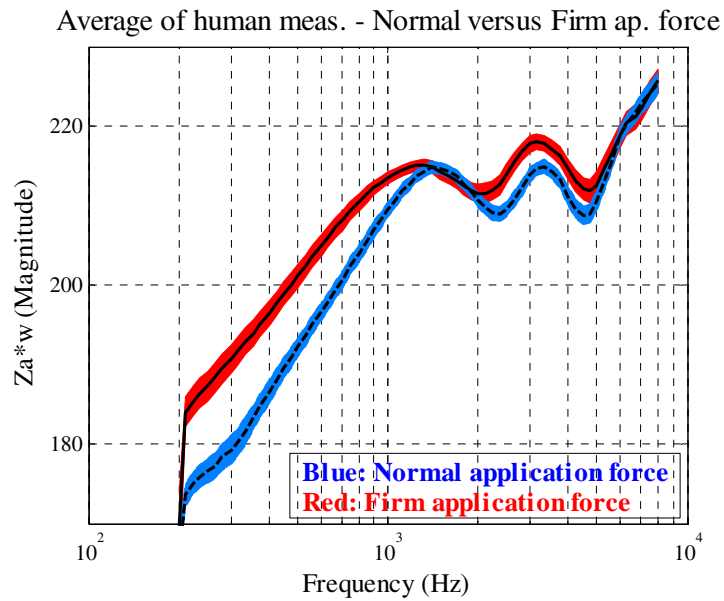
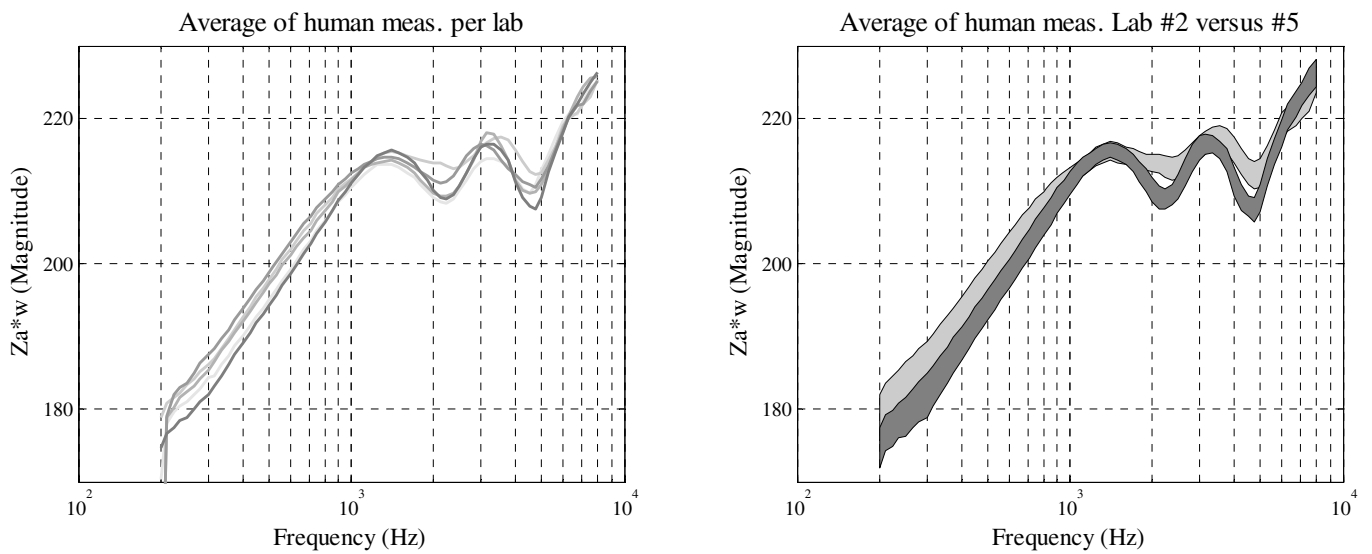
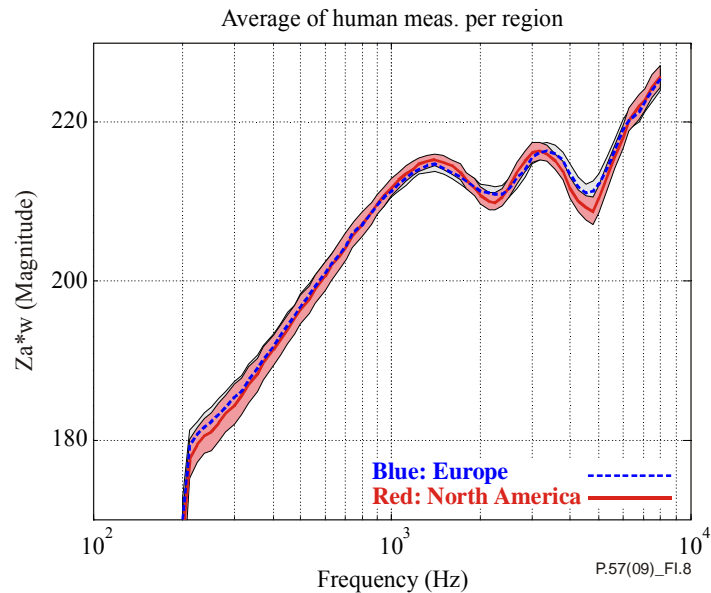

Figure I.6 – Comparison of human ear measurement means for the normal (blue curve) and firm (red curve) application force cases



NOTE – The left plot illustrates the level of differences between the five laboratories. The ANOVA table given in Table 1.3 indicates that the factor Lab is significant for few frequency bins, which is visible when comparing the means and 95% confidence intervals of, e.g., the Labs #2 and #5, as illustrated in the right plot.

Figure I.7 – Comparison of human ear measurement means for the five contributing organizations (factor Lab)



NOTE – This plot illustrates that differences between the two regions are not significant based on the overlapping 95% confidence intervals.

Figure I.8 – Comparison of human ear measurement means per region, i.e., between the three European laboratories (blue line) and the two North American laboratories (red line)

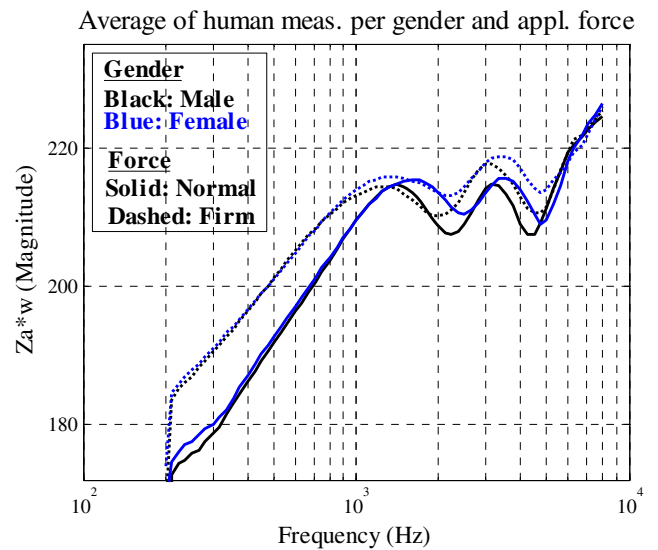
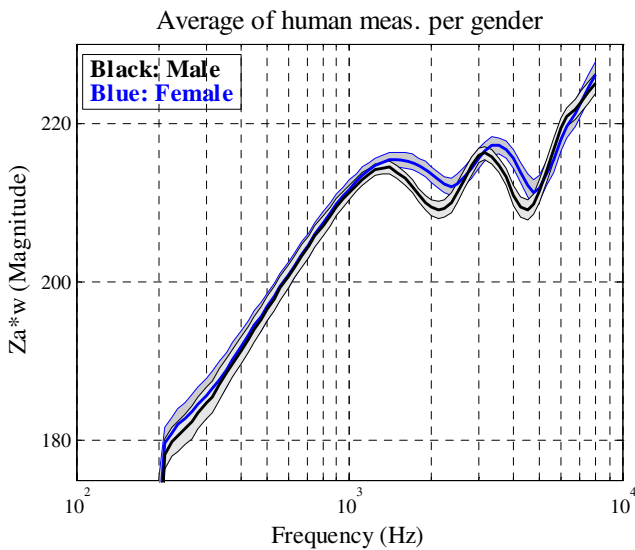

NOTE – Human ear measurement means per gender and application force (shown in the right plot) follow roughly the same pattern for the normal and firm application forces.

Figure I.9 – Comparison of human ear measurement means per gender (shown on the left plot) illustrating a significant difference between male and female measurements based on the non-overlapping 95% confidence intervals

I.4.2 Bivariate parametric analysis of the human ear measurements

I.4.2.1 Presentation of the analysis method

An inspection of the large set of human ear measurements made in this round-robin test reveals a common structure in the shape of the impedance response as a function of frequency. The curve formed by most of the individual impedance measurements shows a series of extrema which can be used as a basis for applying a structural analysis on this dataset. For this purpose, a routine to detect curve extrema was applied to all human ear measurements and a bivariate parametric analysis was then considered to describe the variability of the impedance and frequency variables for this set of frequency response extrema.

The routine used for the detection of curve extrema consists of an identification of maxima (response minima) in the curve, i.e., points that are preceded and followed by lower (response higher) values. The number of extrema detected from the set of 104 individual measurements in each of the two cases is reported in Table I.1. The automatic peak detection routine did not work 100% of the time because some curves did not follow the general shape of the dataset. Such curves lead to detected points that could be identified visually as clear outliers and were therefore removed from the dataset of extremum points. Table I.1 shows that the first two minima and maxima cover more than 90% of the individual measurements, except for the second minimum of the firm application force case, which includes only 70% of the individual measurements. The low values seen for the third maximum relates to the fact that this maximum lies around the 6-8 kHz region. As the impedance measurement was limited to 8 kHz in the present study, any maximum occurring above 8 kHz cannot be detected in this set of measurements. Therefore the information presented here for the third maximum should be interpreted with caution.

Table I.1 – Number of extrema detected from the set of 104 individual measurements for the normal and firm application force cases

Extremum index	Application force case			
	Normal		Firm	
	Maximum	Minimum	Maximum	Minimum
1	102	98	94	87
2	99	96	91	72
3	44		54	

I.4.2.2 Results of the parametric analysis

The resulting set of data points comprises the impedance and frequency values of each detected point; and the bivariate distribution of this dataset was studied for each extrema and application force case separately. A scatter plot of the extremum points is presented in Figure I.10 for the normal application force case (left plot) and the firm application force case (right plot). Three individual impedance responses are also included in this graph to illustrate how these clouds of points relate to the structural shape of the human ear impedance. To describe statistically each cloud of points, a bivariate mean was computed and an ellipse covering 95% of the data points was derived based on the Hotelling T-squared statistic. Figure I.11 illustrates the resulting structural representation of the individual human ear measurements for the normal application force case (left plot) and the firm application force case (right plot). This graph shows that the different clouds are relatively well discriminated. In Figure I.12, a comparison of the structural mean and the arithmetic mean is shown for the normal application force case (left plot) and the firm application force case (right plot). In these two plots, the size of the ellipses represents now the 95% confidence level for the mean value of the extrema, which can be compared to the 95% confidence interval of the arithmetic mean represented by the width of the blue and red curves in this figure. These two plots

illustrate some differences in the characteristics of the structural and arithmetic means for both the normal and firm application force cases. The frequency of the extrema relate relatively well with the two methods, except perhaps for the first maximum of the firm application force which shows a slight shift in frequency. However, the amplitude between two successive extrema (i.e., maximum impedance to minimum impedance) is about twice larger for the structural mean.

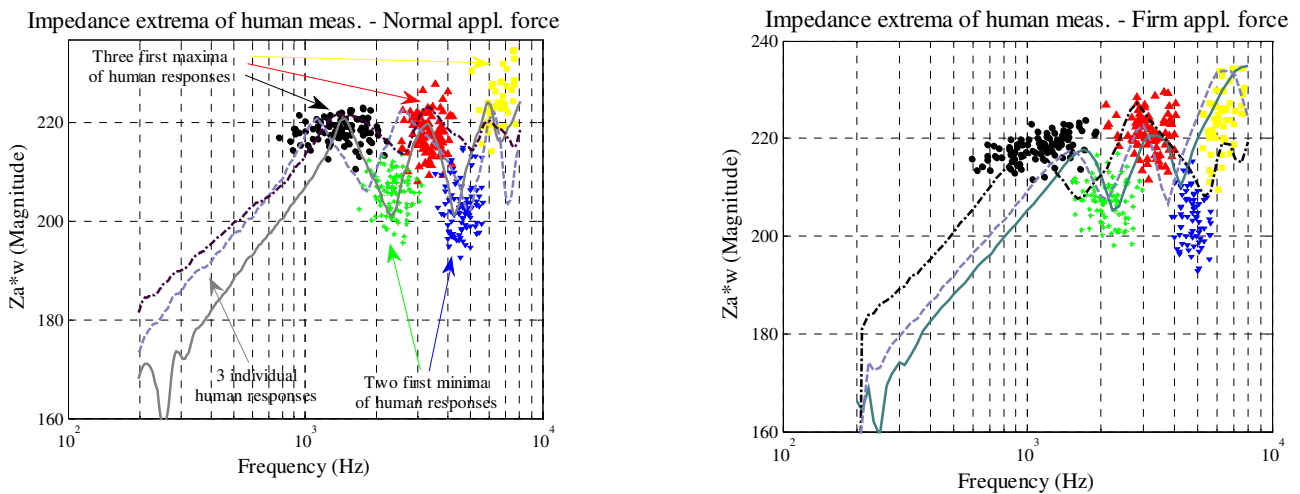

NOTE – The three individual impedance responses shown in these graphs illustrate how the clouds of points relate to the structural shape of the human ear impedance.

Figure I.10 – Scatter plot of the extremum points derived from the individual human ear impedance measurements for the normal application force case (left plot) and the firm application force case (right plot)

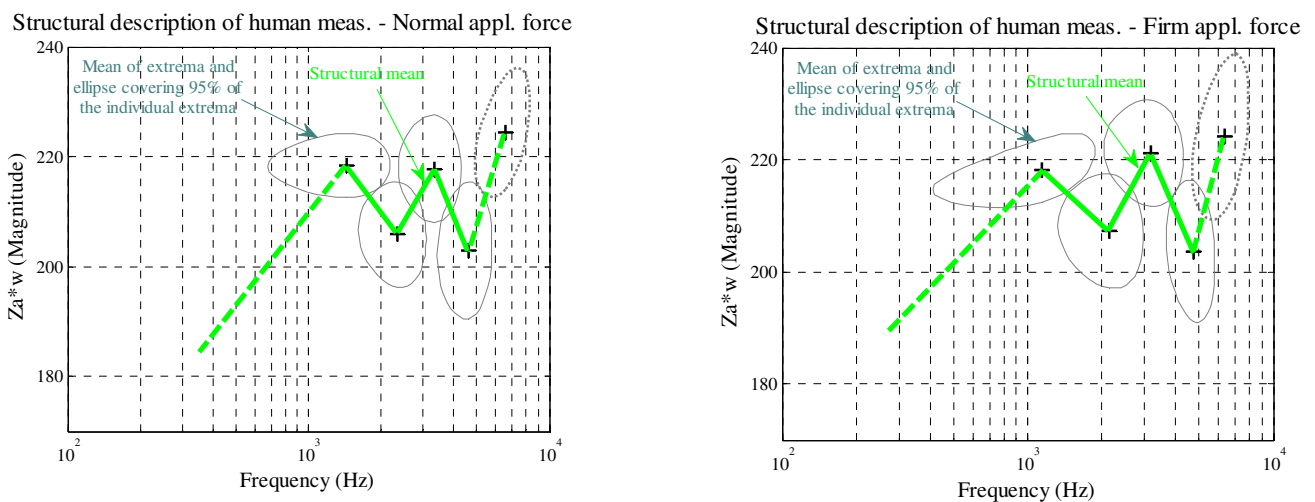

NOTE – The clouds of points shown in Figure I.10 are now represented by a bivariate mean and an ellipse covering 95% of the data points.

Figure I.11 – Structural representation of the individual human ear measurements for the normal application force case (left plot) and the firm application force case (right plot)

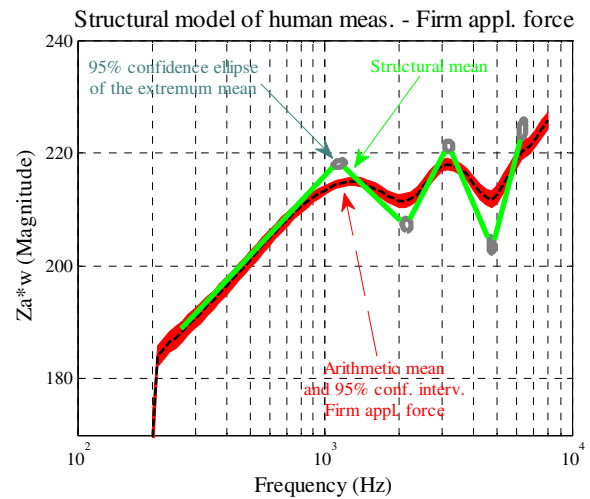
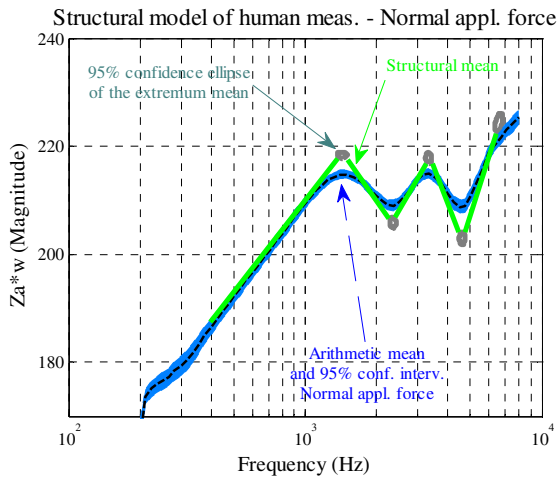

NOTE – The size of the ellipses represents now the 95% confidence level for the mean value of the extrema, which can be compared to the 95% confidence interval of the arithmetic mean represented by the width of the blue and red curves.

Figure I.12 – Comparison of the structural and arithmetic means of the individual human ear measurements for the normal application force case (left plot) and the firm application force case (right plot)

I.5 Comparison between human and artificial ear measurements

I.5.1 Univariate comparison of human and artificial ear measurements

The series of graphs presented in this clause summarizes the results of the set of round-robin test measurements made in this study from a univariate viewpoint. The graphs presented in Figures I.13 and I.14 compare the arithmetic means of the human ear measurements with the set of measurements made on the two artificial ear types at nine different application forces (from 2 to 18 N increasing by 2 N steps). Figure I.13 focuses on the measurements made on the artificial ear type 3.3 while Figure I.14 focuses on the type 3.4 ear. The curve shown on the left plot of each figure (blue curve) corresponds to the mean of the human ear measurements made with a normal application force and the curve shown on the right plot (red curve) corresponds to the mean of the human ear measurements made with a firm application force. The width of the red and blue curves represents the 95% confidence interval about the human ear measurement mean per frequency bin.

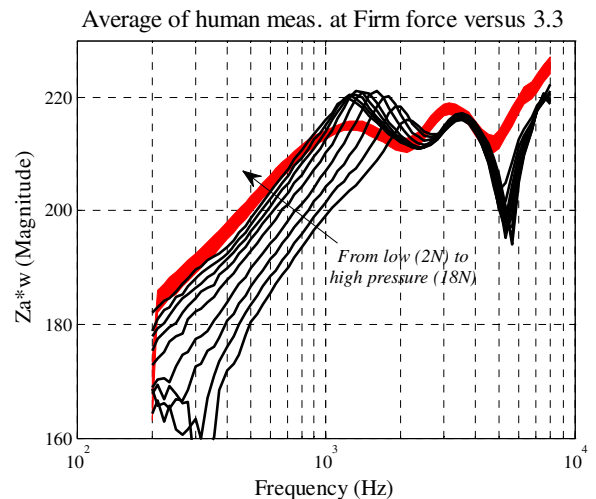
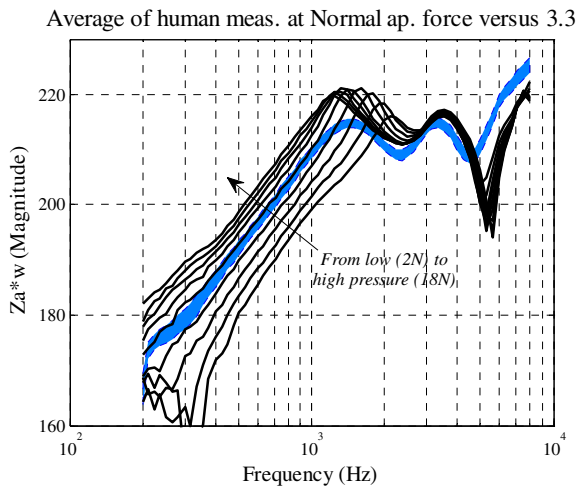

NOTE – The width of the red and blue curves represents the 95% confidence interval about the human ear measurement mean per frequency bin.

Figure I.13 – Comparison between the human ear measurements made with normal application force (left plot) and with firm application force (right plot) and the measurements made on the artificial ear type 3.3 at nine different application forces

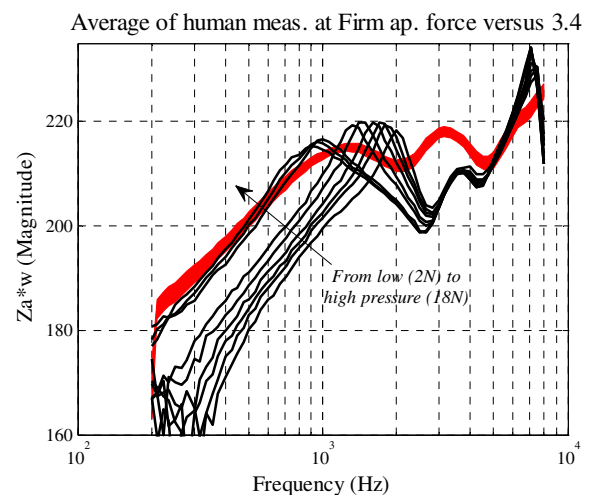
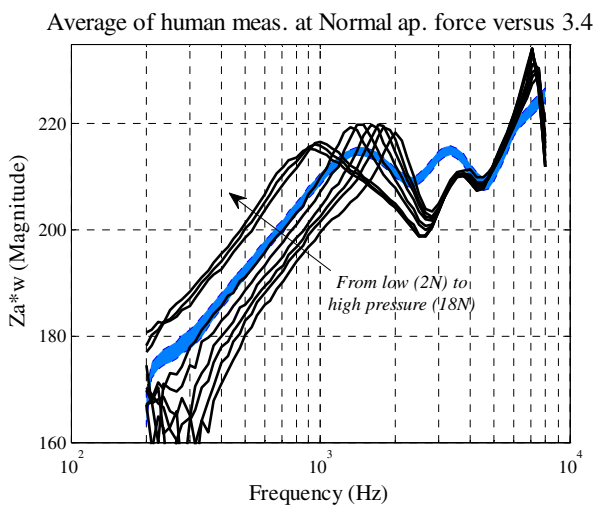

NOTE – The width of the red and blue curves represents the 95% confidence interval about the human ear measurement mean per frequency bin.

Figure I.14 – Comparison between the human ear measurements made with normal application force (left plot) and with firm application force (right plot) and the measurements made on the artificial ear type 3.4 at nine different application forces

I.5.2 Bivariate parametric comparison of human and artificial ear measurements

The series of graphs presented in this clause summarizes the results of the set of round-robin test measurements made in this study from a bivariate structural analysis viewpoint. The graphs presented in Figures I.15 and I.16 compare the structural model of the human ear measurements with the amplitude extrema of the two artificial ear types at nine different application forces (from 2 to 18 N increasing by 2 N steps). Figure I.15 focuses on the measurements made on the artificial ear type 3.3, while Figure I.16 focuses on the type 3.4 ear. The structural means shown in these graphs have been described in clause I.4.2, but it should be noted that the ellipses presented here describe

the distribution of the detected extrema, as in Figure I.11, and not the 95% confidence ellipse of the mean as in Figure I.12. These ellipses are better suited to visually check how well the amplitude extrema of a given artificial ear type and application force relates to the associated distribution of individual ear impedance extrema.

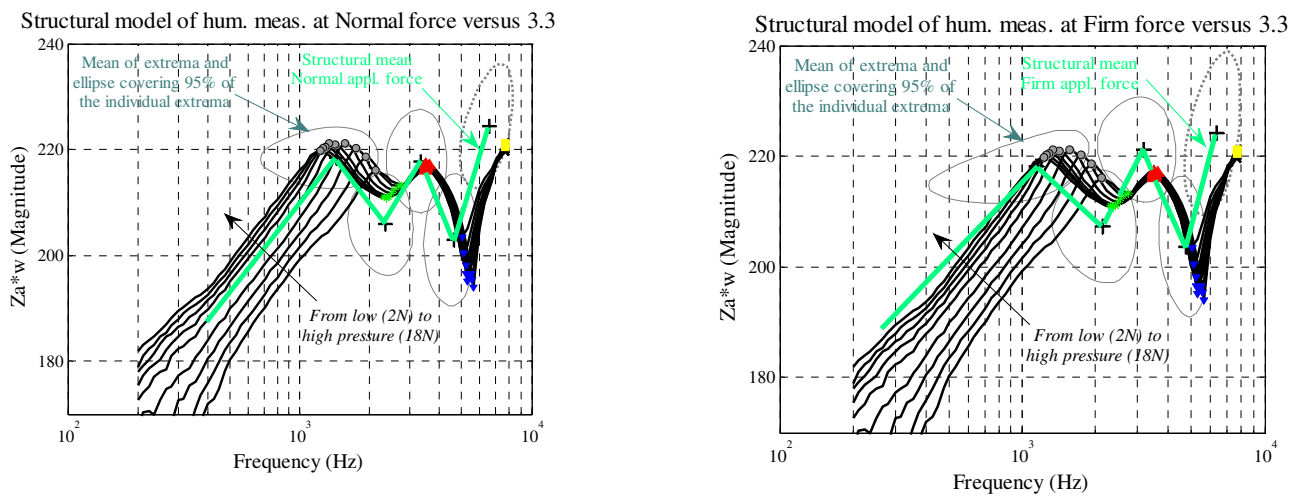

Figure I.15 – Comparison between the human ear measurements made with normal application force (left plot) and with firm application force (right plot) and the measurements made on the artificial ear type 3.3 at nine different application forces

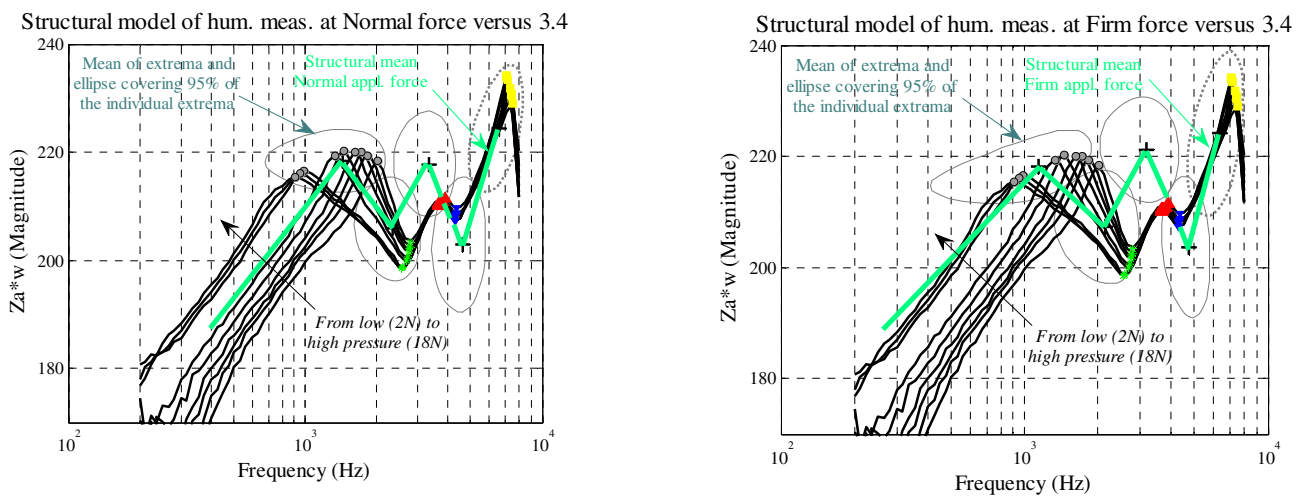
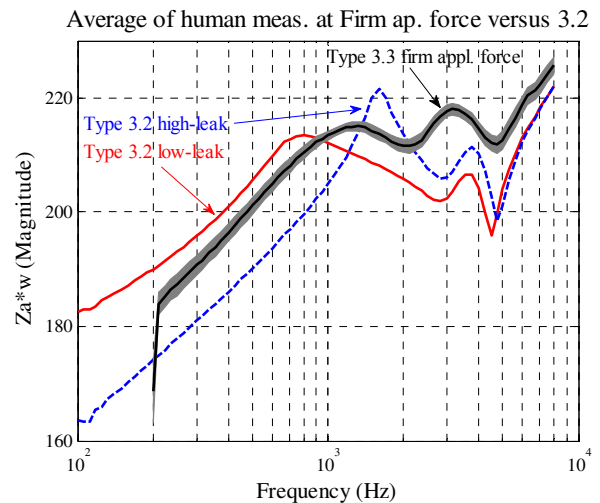
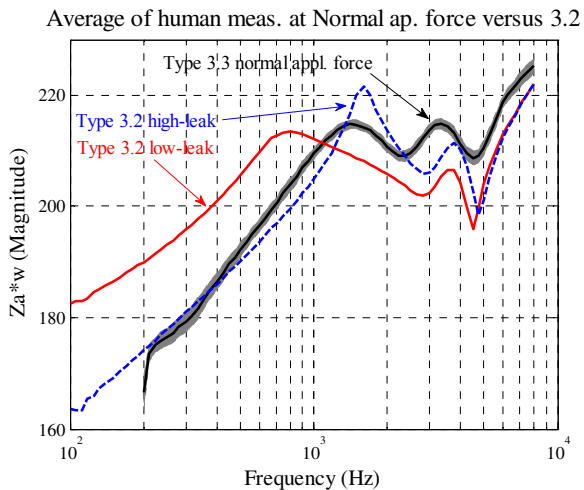

Figure I.16 – Comparison between the human ear measurements made with normal application force (left plot) and with firm application force (right plot) and the measurements made on the artificial ear type 3.4 at nine different application forces

I.5.3 Comparison between human measurements and type 3.2 artificial ear measurements

Included in this clause are the results of the human ear analysis described herein presented with the results of equivalent measurement on a type 3.2 low-leak (Figure I.17) and type 3.2 high-leak (Figure I.18) artificial ear. Artificial ear measurement data are supplied by Brüel & Kjær as a normative reference to the round-robin study results.



NOTE – The width of the gray curves represents the 95% confidence interval of the human ear measurement mean per frequency bin.

Figure I.17 – Comparison between the measurements made on the type 3.2 artificial ear and the human ear measurements made at normal application force (left plot) and at firm application force (right plot)

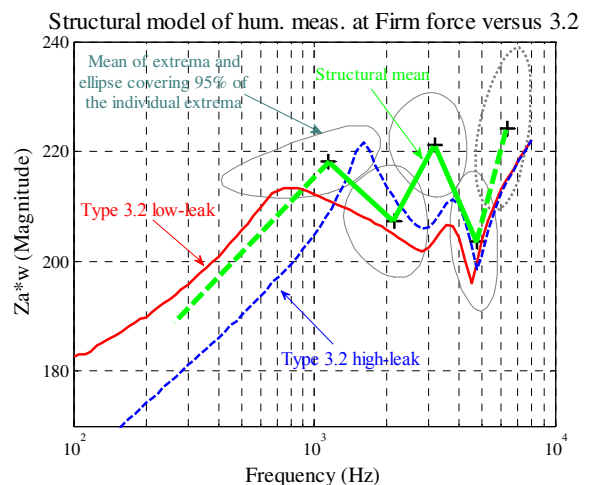
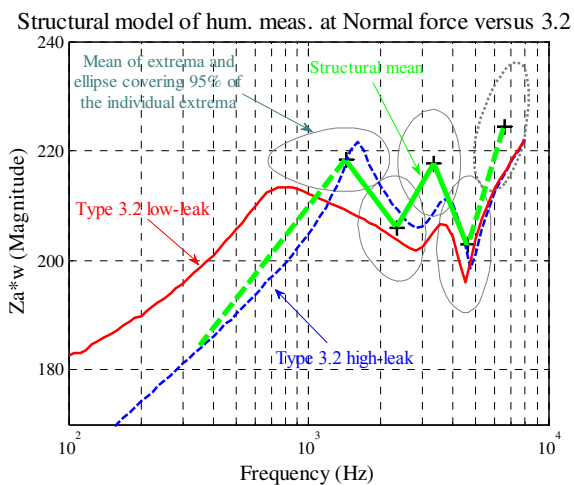

Figure I.18 – Comparison between the measurements made on the type 3.2 artificial ear and the structural model derived from the human ear measurements made at normal application force (left plot) and at firm application force (right plot)

I.5.5 Study of factor effects by univariate analysis of variance

Table I.2 – ANOVA applied separately to each frequency bin with the factors Lab (5 levels), Force (normal or firm), Subject (nested in Lab) and the interaction Lab × Force

Frequency	Lab		Force		Subject(Lab)		Lab*Force	
	F-ratio	Sig. Level	F-ratio	Sig. Level	F-ratio	Sig. Level	F-ratio	Sig. Level
200	14.05	***	0.07		2.42	***	9.52	***
212	0.87		194.66	***	4.14	***	6.09	***
224	1.19		252.54	***	5.48	***	7.37	***
236	1.09		262.33	***	5.72	***	7.04	***
250	1.17		266.93	***	6.13	***	8.42	***
265	1		292.44	***	6.54	***	8.07	***
280	1.16		289.59	***	6.77	***	7.08	***
300	1.15		312.74	***	7.06	***	6.27	***
315	1.03		318.61	***	7.5	***	6.8	***
335	1		271.04	***	6.53	***	5.53	***
355	1.19		303.78	***	6.76	***	6.13	***
375	1.27		306.91	***	6.9	***	6.67	***
400	1.44		314.48	***	6.68	***	6.72	***
425	1.51		307.64	***	6.61	***	6.08	***
450	1.57		313.85	***	6.63	***	6.74	***
475	1.64		311.82	***	6.55	***	6.53	***
500	1.74		313.5	***	6.53	***	6.32	***
530	1.74		309.54	***	6.48	***	6.22	***
560	1.79		295.51	***	6.32	***	5.58	***
600	1.82		280.43	***	6.02	***	5.04	***
630	1.79		276.86	***	5.92	***	4.46	**
670	1.69		253.77	***	5.73	***	3.67	**
710	1.56		230.31	***	5.44	***	3.34	*
750	1.45		204.23	***	5.08	***	2.78	*
800	1.26		168.08	***	4.46	***	2.02	
850	1.11		131.66	***	3.84	***	1.54	
900	0.98		98.74	***	3.24	***	1.17	
950	0.77		75.06	***	2.79	***	1.05	
1000	0.67		53.26	***	2.3	***	0.97	
1060	0.53		33.56	***	1.75	**	0.86	
1120	0.5		20.49	***	1.43	*	1.04	
1180	0.46		11.22	**	1.22		1.03	
1250	0.72		4.26	*	1.1		1.12	
1320	1.14		0.85		1.14		1.03	
1400	1.37		0.06		1.36		1.02	
1500	1.33		1.4		2.02	***	0.95	
1600	1.35		3.24		3.1	***	1.04	
1700	1.5		3.32		4.06	***	1.1	
1800	1.94		1.62		4.56	***	1.06	
1900	2.92	*	0.01		4.57	***	0.91	
2000	4.19	**	2.72		4.27	***	0.6	
2120	5.13	***	15.03	***	4.14	***	0.66	
2240	4.52	**	37.25	***	4.19	***	1.71	
2360	3.03	*	61.49	***	4.4	***	2.47	*
2500	1.9		90.8	***	4.99	***	3.08	*
2650	1.16		112.9	***	5.69	***	3.46	*
2800	0.81		110.26	***	5.61	***	3.92	**
3000	1		93.99	***	5.3	***	3.97	**
3150	1.74		73.31	***	4.75	***	3.08	*
3350	2.16		54.39	***	4.87	***	2.87	*
3550	2.16		52.21	***	6.13	***	3	*
3750	2.09		59.8	***	7.4	***	3.33	*
4000	2.45		59.15	***	6.77	***	4.02	**
4250	2.67	*	40.23	***	4.37	***	3.25	*
4500	2.46		24.17	***	2.62	***	2.6	*
4750	1.92		12.35	***	2.39	***	2.91	*
5000	1.15		5.11	*	2.24	***	1.83	
5300	0.44		2.61		2.51	***	0.66	
5600	0.26		0.97		2.65	***	0.4	
6000	0.24		0.01		2.86	***	0.47	
6300	0.05		0.28		2.69	***	0.71	
6700	0.41		0.1		3.05	***	1.07	
7100	0.42		0.29		3.5	***	1.01	
7500	0.49		0.04		3.55	***	1.02	
8000	0.11		0		3.64	***	1.36	

Significant levels are represented as follows: *, $P < 0.05$; **, $P < 0.01$; ***, $P < 0.001$.

Table I.3 – ANOVA applied separately to each frequency bin with the factors Gender (male or female), Force (normal or firm), Subject (nested in Gender) and the interaction Gender × Force

Frequency	Gender		Force		Subject(Gender)		Gender*Force	
	F-ratio	Sig. Level	F-ratio	Sig. Level	F-ratio	Sig. Level	F-ratio	Sig. Level
200	3.11		1.12		2.7	***	1.39	
212	0.83		154.63	***	3.43	***	0.37	
224	0.5		197.02	***	4.42	***	0.4	
236	0.88		212.18	***	4.66	***	1.02	
250	0.62		203.99	***	4.77	***	0.25	
265	0.71		227.42	***	5.17	***	1.54	
280	0.47		233.91	***	5.52	***	0.66	
300	0.28		261.01	***	5.9	***	0.31	
315	0.33		264.12	***	6.13	***	0.31	
335	0.12		237.12	***	5.55	***	0.01	
355	0.1		258.66	***	5.68	***	0.01	
375	0.13		256.6	***	5.72	***	0.23	
400	0.15		259.98	***	5.58	***	0.45	
425	0.12		259.59	***	5.64	***	0.39	
450	0.13		256.59	***	5.56	***	0.47	
475	0.07		256.78	***	5.56	***	0.62	
500	0.05		260.17	***	5.61	***	0.81	
530	0.05		256.53	***	5.61	***	1.2	
560	0.04		250.63	***	5.58	***	1.01	
600	0.01		242.4	***	5.43	***	1.13	
630	0.02		244.32	***	5.43	***	0.93	
670	0.04		231.23	***	5.37	***	0.85	
710	0.04		211.97	***	5.13	***	0.68	
750	0.06		191.94	***	4.84	***	0.31	
800	0.09		163.45	***	4.33	***	0.07	
850	0.12		131.71	***	3.77	***	0	
900	0.11		102.02	***	3.21	***	0.13	
950	0.15		80.16	***	2.76	***	0.43	
1000	0.22		58.52	***	2.29	***	0.78	
1060	0.42		38.46	***	1.73	**	1.13	
1120	0.56		24.14	***	1.41	*	1.33	
1180	0.78		14.14	***	1.19		1.21	
1250	1.07		6.24	*	1.08		1.57	
1320	1.19		1.94		1.16		1.97	
1400	1.93		0.08		1.38		2.41	
1500	4.29	*	0.42		2.01	***	2.1	
1600	8.97	**	1.68		2.91	***	0.95	
1700	14.81	***	1.93		3.61	***	0.15	
1800	20.78	***	0.94		3.92	***	0.07	
1900	23.28	***	0.01		4.05	***	1.01	
2000	21.04	***	2.67		4.16	***	2.96	
2120	15.19	***	13.44	***	4.43	***	4.69	*
2240	8.93	**	31.54	***	4.43	***	4.09	*
2360	3.93	*	52.23	***	4.41	***	2.08	
2500	1.06		79.06	***	4.75	***	0.53	
2650	0.11		99.94	***	5.22	***	0.01	
2800	0.06		96.8	***	5.01	***	0.1	
3000	0.13		84.83	***	4.78	***	0.89	
3150	0.05		71.82	***	4.58	***	1.58	
3350	2.7		55.36	***	4.65	***	0.57	
3550	7.42	**	52.43	***	5.55	***	0.13	
3750	11.98	***	55.3	***	6.33	***	0.02	
4000	16.43	***	48.86	***	5.54	***	0.64	
4250	15.9	***	34.94	***	3.71	***	0.26	
4500	8.05	**	23.84	***	2.42	***	0.26	
4750	1.46		14.56	***	2.35	***	3.54	
5000	0.09		7.59	**	2.32	***	6.23	*
5300	0.08		4.64	*	2.61	***	5.2	*
5600	0.91		1.48		2.65	***	1.42	
6000	1.14		0.01		2.81	***	0.08	
6300	1		0.03		2.62	***	0.98	
6700	0.22		0.59		3.02	***	1.61	
7100	0		0.72		3.46	***	1.2	
7500	0.19		0		3.49	***	0.67	
8000	0.83		0.18		3.46	***	0.75	

Significant levels are represented as follows: *, $P < 0.05$; **, $P < 0.01$; ***, $P < 0.001$.

Appendix II

Illustration of the mobile phone-shaped impedance probe used in Appendix I

(This appendix does not form an integral part of this Recommendation.)

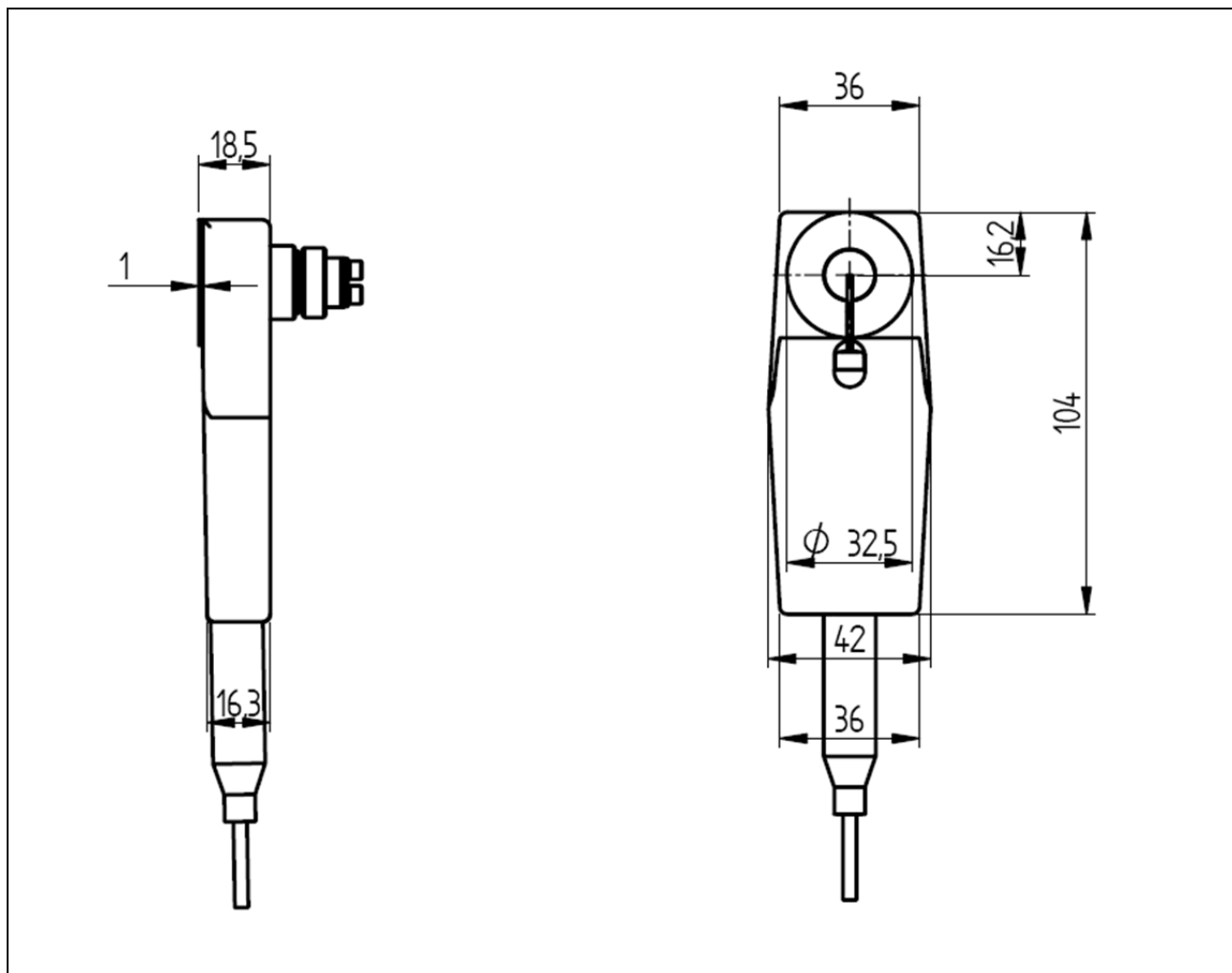

NOTE – All numbers indicate measures in mm.

Figure II.1 – The mobile phone shaped impedance probe viewed from the side and from the front

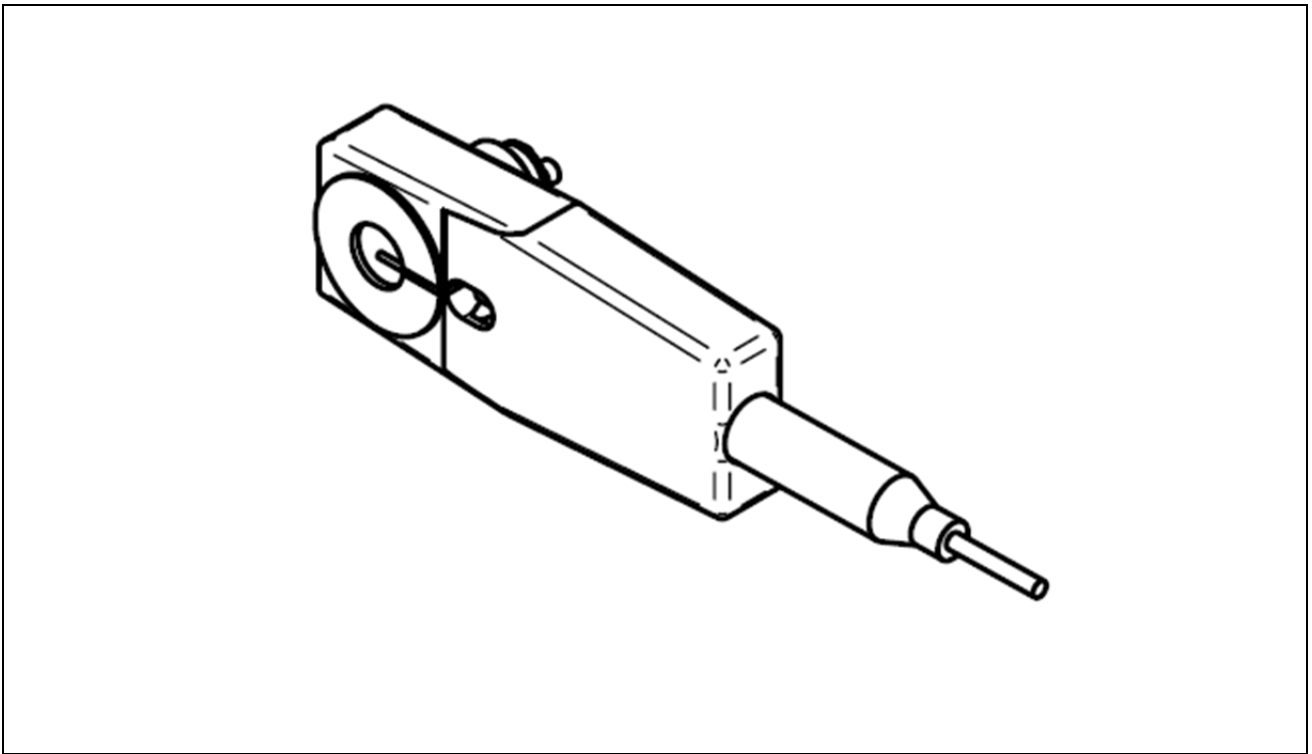

Figure II.2 – 3D view of the mobile phone-shaped impedance probe

Bibliography

- [b-ITU-T P.64] Recommendation ITU-T P.64 (2007), *Determination of sensitivity/frequency characteristics of local telephone systems.*
- [b-ASTM D2240-5] ASTM D2240-5 (2010), *Standard Test Method for Rubber Property – Durometer Hardness.*
<<http://www.astm.org/Standards/D2240.htm>>
- [b-DIN 53505] DIN 53505 (2000), *Testing of rubber – Shore A and Shore D hardness test.*
- [b-ISO 3] ISO 3:1973, *Preferred numbers – Series of preferred numbers.*
<http://www.iso.org/iso/iso_catalogue/catalogue_tc/catalogue_detail.htm?csnumber=3564>

SERIES OF ITU-T RECOMMENDATIONS

Series A	Organization of the work of ITU-T
Series D	General tariff principles
Series E	Overall network operation, telephone service, service operation and human factors
Series F	Non-telephone telecommunication services
Series G	Transmission systems and media, digital systems and networks
Series H	Audiovisual and multimedia systems
Series I	Integrated services digital network
Series J	Cable networks and transmission of television, sound programme and other multimedia signals
Series K	Protection against interference
Series L	Construction, installation and protection of cables and other elements of outside plant
Series M	Telecommunication management, including TMN and network maintenance
Series N	Maintenance: international sound programme and television transmission circuits
Series O	Specifications of measuring equipment
Series P	Terminals and subjective and objective assessment methods
Series Q	Switching and signalling
Series R	Telegraph transmission
Series S	Telegraph services terminal equipment
Series T	Terminals for telematic services
Series U	Telegraph switching
Series V	Data communication over the telephone network
Series X	Data networks, open system communications and security
Series Y	Global information infrastructure, Internet protocol aspects and next-generation networks
Series Z	Languages and general software aspects for telecommunication systems