



INTERNATIONAL TELECOMMUNICATION UNION

**ITU-T**

TELECOMMUNICATION  
STANDARDIZATION SECTOR  
OF ITU

**E.166/X.122**

(10/96)

SERIES E: TELEPHONE NETWORK AND ISDN

Operation, numbering, routing and mobile services –  
International operation – Numbering plan of the  
international telephone service

SERIES X: DATA NETWORKS AND OPEN SYSTEM  
COMMUNICATION

Public data networks – Network aspects

---

**Numbering plan interworking for the E.164 and  
X.121 numbering plans**

ITU-T Recommendation E.166/X.122

(Previously CCITT Recommendation)

---

ITU-T E-SERIES RECOMMENDATIONS  
**TELEPHONE NETWORK AND ISDN**

<b>OPERATION, NUMBERING, ROUTING AND MOBILE SERVICES</b>	
INTERNATIONAL OPERATION	E.100–E.229
Definitions	E.100–E.103
General provisions concerning Administrations	E.104–E.119
General provisions concerning users	E.120–E.139
Operation of international telephone services	E.140–E.159
<b>Numbering plan of the international telephone service</b>	<b>E.160–E.169</b>
International routing plan	E.170–E.179
Tones in national signalling systems	E.180–E.199
Maritime mobile service and public land mobile service	E.200–E.229
OPERATIONAL PROVISIONS RELATING TO CHARGING AND ACCOUNTING IN THE INTERNATIONAL TELEPHONE SERVICE	E.230–E.299
Charging in the international telephone service	E.230–E.249
Procedures for remuneration of Administrations for facilities made available	E.250–E.259
Measuring and recording call durations for accounting purposes	E.260–E.269
Establishment and exchange of international accounts	E.270–E.299
UTILIZATION OF THE INTERNATIONAL TELEPHONE NETWORK FOR NON-TELEPHONY APPLICATIONS	E.300–E.329
General	E.300–E.319
Phototelegraphy	E.320–E.329
ISDN PROVISIONS CONCERNING USERS	E.330–E.399
<b>QUALITY OF SERVICE, NETWORK MANAGEMENT AND TRAFFIC ENGINEERING</b>	
NETWORK MANAGEMENT	E.400–E.489
TRAFFIC ENGINEERING	E.490–E.799
QUALITY OF TELECOMMUNICATION SERVICES: CONCEPTS, MODELS, OBJECTIVES AND DEPENDABILITY PLANNING	E.800–E.899

*For further details, please refer to ITU-T List of Recommendations.*

## **ITU-T RECOMMENDATION E.166/X.122**

### **NUMBERING PLAN INTERWORKING FOR THE E.164 AND X.121 NUMBERING PLANS**

#### **Summary**

This Recommendation defines the procedures applicable for the purpose of numbering plan interworking between networks which use the E.164 numbering plan and networks which use the X.121 numbering plan. The principles for interworking between the E.164 and X.121 numbering plans covered in this Recommendation are illustrated by various examples of packet mode calls. Although both the escape code method and the Numbering Plan Identifier (NPI) method are described, the recommended solution is use of the NPI method.

#### **Source**

ITU-T Recommendation E.166/X.122 was revised by ITU-T Study Groups 2 and 7 (1993-1996) and was approved under the WTSC Resolution No. 1 procedure on the 8th of October 1996.

## FOREWORD

ITU (International Telecommunication Union) is the United Nations Specialized Agency in the field of telecommunications. The ITU Telecommunication Standardization Sector (ITU-T) is a permanent organ of the ITU. The ITU-T is responsible for studying technical, operating and tariff questions and issuing Recommendations on them with a view to standardizing telecommunications on a worldwide basis.

The World Telecommunication Standardization Conference (WTSC), which meets every four years, establishes the topics for study by the ITU-T Study Groups which, in their turn, produce Recommendations on these topics.

The approval of Recommendations by the Members of the ITU-T is covered by the procedure laid down in WTSC Resolution No. 1 (Helsinki, March 1-12, 1993).

In some areas of information technology which fall within ITU-T's purview, the necessary standards are prepared on a collaborative basis with ISO and IEC.

## NOTE

In this Recommendation, the expression "Administration" is used for conciseness to indicate both a telecommunication administration and a recognized operating agency.

© ITU 1997

All rights reserved. No part of this publication may be reproduced or utilized in any form or by any means, electronic or mechanical, including photocopying and microfilm, without permission in writing from the ITU.

# CONTENTS

	<b>Page</b>
1 Introduction .....	1
2 Scope .....	1
3 References .....	2
4 Definitions .....	3
5 Abbreviations .....	4
6 Interworking .....	4
6.1 Numbering plans .....	4
6.1.1 Escape codes .....	4
6.1.2 Prefixes .....	5
6.1.3 Allocation of a DNIC to an ISDN or PSTN .....	5
6.2 Methods .....	5
6.2.1 Dial-in method .....	5
6.2.2 Escape code method .....	6
6.2.3 NPI method .....	6
6.3 Subscriber dialling procedures .....	6
6.3.1 Single stage dialling .....	6
6.3.2 Double stage dialling .....	7
6.4 Escape code method versus NPI method .....	7
6.5 Reconciliation between the escape code method and the NPI method .....	8
6.6 Internetwork implementation .....	9
6.7 Man-machine interface procedures .....	9
7 Interworking diagrams .....	9
7.1 Conventions used in the interworking diagrams (Figures 2 through 28) .....	9
7.2 Index of interworking diagrams .....	10
7.2.1 Section A: Scenarios for interworking .....	10
7.2.2 Section B: Bearer capability interworking that requires no numbering plan interworking .....	10
7.2.3 Section C: Numbering plan interworking .....	11
7.2.4 Section D: Interworking with terminals that have dual numbers .....	11
7.3 Interworking diagrams .....	12
8 Recommendation history .....	40



## **Recommendation E.166/X.122**

### **NUMBERING PLAN INTERWORKING FOR THE E.164 AND X.121 NUMBERING PLANS**

*(revised in 1996)*

#### **1 Introduction**

Various public networks such as Integrated Services Digital Networks (ISDNs) and Public Switched Telephone Networks (PSTNs) utilize the E.164 numbering plan, whilst Packet Switched Public Data Networks (PSPDNs) are generally numbered under the X.121 numbering plan. A call from an ISDN (or PSTN) to a PSPDN, a PSPDN to an ISDN and calls routed through networks using a different numbering plan to that of the originating or destination network are examples of the need for numbering plan interworking. Numbering plan interworking is a fundamental requirement for the successful completion of calls between networks utilizing different numbering plans.

This Recommendation defines the general procedures applicable to numbering plan interworking between:

- ISDNs and PSPDNs;
- ISDNs and PSTNs; and
- PSPDNs and PSTNs.

The numbering and addressing principles for PSTNs/ISDNs are described in Recommendation I.330. The numbering principles for public data networks are defined in Recommendation X.121.

#### **2 Scope**

**2.1** The scope of this Recommendation is to define the procedures applicable for the purpose of numbering plan interworking between networks which use the E.164 numbering plan and networks which use the X.121 numbering plan.

**2.2** Although both the E.164 and X.121 numbering plans accommodate both circuit switched and packet switched networks, the principles for interworking between the E.164 and X.121 numbering plans covered in this Recommendation are illustrated by various examples which involve only packet mode calls. Although not illustrated, the numbering plan interworking principles, using the Numbering Plan Identifier (NPI) method are also applicable to frame relay networks.

**2.3** Interworking involving two or more networks is included in the scope of this Recommendation.

**2.4** This Recommendation applies to numbering plan interworking across international boundaries. Its applicability to calls within a single country is a national matter.

**2.5** The sample call flows shown in the figures are from terminal to terminal. For those situations that involve escape codes, it should be noted that the interworking arrangements within a national network are a national matter.

**2.6** The application of this Recommendation includes the following numbering plan interworking and bearer capability interworking scenarios:

- a) calls from/to a speech terminal on an ISDN, to/from a voice terminal on a PSTN (see Figures 2 and 3);

- b) calls from/to an X.25 terminal on an ISDN, to/from an X.25 terminal using X.32 procedures on a PSTN (see Figures 4 and 5);
- c) calls from/to an X.25 terminal on an ISDN, to/from an X.25 terminal on another ISDN (see Figure 6);
- d) calls from/to an X.25 terminal on a PSPDN, to/from an X.25 terminal using X.32 procedures on a PSTN (see Figures 7, 8, 27 and 28);
- e) calls from/to an X.25 terminal on a PSPDN, to/from an X.25 terminal using X.31 procedures (BC = PS) on an ISDN (see Figures 11 and 12);
- f) calls from/to an X.25 terminal on a PSPDN utilizing an ISDN packet switch as a transit network for calls to/from an X.25 terminal on a PSPDN (see Figure 13);
- g) calls from/to an X.25 terminal using X.31 procedures (BC = PS) on an ISDN utilizing a PSPDN as a transit network for calls to/from an X.25 terminal using X.31 procedures (BC = PS) on another ISDN (see Figure 16);
- h) calls from/to an X.25 terminal using X.31 procedures (BC = PS) on an ISDN utilizing a PSPDN as a transit network for calls to/from an X.25 terminal using X.31 procedures (BC = 64) on another ISDN (see Figures 14, 15, 17 and 18);
- i) calls from/to an X.25 terminal using X.31 procedures (BC = PS) on an ISDN utilizing a PSPDN as a transit network for calls to/from an X.25 terminal using X.32 procedures on a PSTN (see Figures 19, 20, 21 and 22);
- j) calls from/to an X.25 terminal using X.31 procedures (BC = PS) on an ISDN utilizing a PSPDN and an ISDN packet switch as transit networks for calls to/from an X.25 terminal using X.32 procedures on a PSTN (see Figures 23 and 24);
- k) calls from/to an X.25 terminal on a PSPDN to/from an X.25 terminal using X.31 procedures (BC = 64) on an ISDN (see Figures 9, 10, 25 and 26).

NOTE – None of the scenarios listed above specifically address character mode Data Terminal Equipment (DTE) (i.e. X.28 mode) access to a Packet Assembly/Disassembly (PAD) nor Group 3 FAX (i.e. X.38 mode) access to a Facsimile Packet Assembly/Disassembly (FPAD). The escape code method scenarios for X.25 terminals are in most cases applicable to X.28 and/or X.38 terminals. However, this is not the case for the NPI method scenarios until a Numbering Plan Identifier (NPI)-like facility is defined in Recommendations X.28 and/or X.38.

### 3 References

- 3.1** This Recommendation is related to and is compatible with the following Recommendations:
- ITU-T Recommendation E.160 (1993), *Definitions relating to national and international numbering plans*.
  - CCITT Recommendation E.164 (I.331) (1991), *Numbering plan for the ISDN era*.
  - CCITT Recommendation E.165 (1988), *Timetable for coordinated implementation of the full capability of the numbering plan for the ISDN era (Recommendation E.164)*.
  - ITU-T Recommendation E.165.1 (1996), *The use of escape code "0" within the E.164 numbering plan during the transition period to implementation of NPI mechanism*.
  - CCITT Recommendation E.170 (1992), *Traffic routing*.
  - CCITT Recommendation E.172 (1992), *ISDN routing plan*.
  - CCITT Recommendation E.173 (1991), *Routing plan for interconnection between public land mobile networks and fixed terminal networks*.



- CCITT Recommendation I.330 (1988), *ISDN numbering and addressing principles.*
- ITU-T Recommendations Q.761 to Q.764 (1993), *Integrated services digital network user part.*
- ITU-T Recommendation Q.931 (1993), *ISDN user-network interface layer 3 specification for basic call control.*
- ITU-T Recommendation X.25 (1996), *Interface between Data Terminal Equipment (DTE) and Data Circuit-terminating Equipment (DCE) for terminals operating in the packet mode and connected to public data networks by dedicated circuit.*
- ITU-T Recommendation X.28 (1993), *DTE/DCE interface for start-stop mode data terminal equipment accessing the packet assembly/disassembly facility (PAD) in a public data network situated in the same country.*
- ITU-T Recommendation X.31 (1995), *Support of packet mode terminal equipment by an ISDN.*
- ITU-T Recommendation X.32 (1996), *Interface between Data Terminal Equipment (DTE) and Data Circuit-terminating Equipment (DCE) for terminals operating in the packet mode and accessing a packet switched public data network through a public switched telephone network or an integrated services digital network or a circuit switched public data network.*
- ITU-T Recommendation X.38 (1996), *G3 facsimile equipment/DCE interface for G3 facsimile equipment accessing the Facsimile Packet Assembly/Disassembly facility (FPAD) in a public data network situated in the same country.*
- ITU-T Recommendation X.75 (1993), *Packet-switched signalling system between public networks providing data transmission services.*
- CCITT Recommendation X.110 (1988), *International routing principles and routing plan for public data networks.*
- ITU-T Recommendation X.121 (1996), *International numbering plan for public data networks.*
- ITU-T Recommendation X.123 (1996), *Mapping between escape codes and TOA/NPI for E.164/X.121 numbering plan interworking during the transition period.*
- CCITT Recommendation X.300 (1988), *General principles for interworking between public networks and between public networks, and other networks for the provision of data transmission services.*
- ITU-T Recommendation X.301 (1993), *Description of general arrangements for call control within a subnetwork and between subnetworks for the provision of data transmission services.*

#### **4 Definitions**

Within the integrated service and dedicated network environment, the terms used for all networks and services must be compatible and consistent. A list of terms and their definitions relating to numbering are contained in Recommendations E.160, E.164, and X.121. Additionally, the application of some of the definitions is found in clause 6.

## **5 Abbreviations**

The following abbreviations are used within this Recommendation:

64	64 kbits/s
AF	Address Field
AU	Access Unit
BC	Bearer Capability
CRP	Call Request Packet
CS	Circuit Switched
DCE	Data Circuit-terminating Equipment
DNIC	Data Network Identification Code
DTE	Data Terminal Equipment
EC	Escape Code
FPAD	Facsimile Packet Assembly/Disassembly
ICP	Incoming Call Packet
ISDN	Integrated Services Digital Network
NPI	Numbering Plan Identifier
ONSD	Optional Network-Specific Digit
PAD	Packet Assembly/Disassembly
PDN	Public Data Network
PH	Packet Handler
PS	Packet Switched
PSPDN	Packet Switched Public Data Network
PSTN	Public Switched Telephone Network
ROA	Recognized Operating Agency
SS No. 7	Signalling System No. 7

## **6 Interworking**

### **6.1 Numbering plans**

The two numbering plans included in the arrangements shown in this Recommendation are the E.164 and the X.121 numbering plans. It is strongly suggested that a reader who wishes to obtain maximum benefit from this Recommendation be familiar with the provisions of the indicated numbering plan Recommendations.

#### **6.1.1 Escape codes**

An escape code is an indicator consisting of one or more digits which is defined in a given numbering plan and is used to indicate that the address digits that follow it are from a specific numbering plan different from the given numbering plan. The Escape Codes (ECs) discussed in this Recommendation are one digit in length.

An escape code may be carried through the originating network and across internetwork and international boundaries. Consequently, the different digits that serve as escape codes must be standardized. However, there may be cases when an internationally standardized escape code is the same value as a prefix already in use in a national network. In any such case, an Optional Network-Specific Digit (ONSD) may be used in lieu of the standard escape code. If an ONSD is used, it is the obligation of the national network to convert it to the standard escape code prior to passing it across an internetwork or international boundary unless bilateral agreements exist regarding the use of the ONSD between such networks.

The escape codes from X.121 to E.164 are defined in Recommendation X.121. The escape code 0 is used to escape from E.164 to X.121 for packet mode communications. The use of escape code 0 within the E.164 numbering plan will be discontinued at 2359 hours (UTC) 31 December 2000 (see Recommendation E.165.1).

### **6.1.2 Prefixes**

Definitions of prefixes are contained in Recommendations E.160 and X.121. Prefixes are not to be considered as part of an international number, therefore they are not to be signalled over internetwork or international boundaries. Prefixes are considered to be a national matter that is outside the scope of this Recommendation, consequently, the use of prefixes has not been included in the figures within this Recommendation.

### **6.1.3 Allocation of a DNIC to an ISDN or PSTN**

In some countries (or ROAs) a Data Network Identification Code (DNIC) may be allocated to an ISDN or PSTN. The use of a DNIC for that purpose is the decision of the country (or ROA). In this case, the PSPDN using the DNIC to identify terminals on an interconnected ISDN should be capable of generating escape codes 9 and/or 0 for escaping to an ISDN/PSTN or PSTN that does not use the DNIC solution. The translation of the X.121 number to an E.164 number at the destination is permitted on a national basis. As far as the international subscriber is concerned, the called terminal has an X.121 number and the conversion, if required, is done in the destination country.

## **6.2 Methods**

In the diagrams that are included in this Recommendation, there are two main situations when numbering interworking occurs. One situation is when a subscriber is placing a call and must indicate to the originating switch that numbering plan interworking is involved. The other is when one switching system is passing a call over a trunk to another switching system and must indicate to the receiving switching system that interworking is involved.

Three different methods of accomplishing numbering plan interworking are portrayed in the diagrams in this Recommendation. Any of the three methods may occur at call origination, but only two of the methods will occur between switches.

### **6.2.1 Dial-in method**

The dial-in method of numbering plan interworking occurs when a caller on one network places a call that terminates on an access unit (i.e. entrance port) of another network that uses the numbering plan of the called subscriber. When the call from the originating subscriber reaches the access unit, it appears to the second network simply as a call origination. Thus, the caller places the call by using a two-step process. In the first step, the caller enters a called address in the originating network's numbering plan. The call proceeds to a termination point on the first network which is also an origination point on the second network. The caller receives dial tone or the equivalent of dial tone from the second network and then enters the called address using the numbering plan of the called party. Except for access unit functions, neither network needs to have a switching system that deals with numbering plan interworking.

## **6.2.2 Escape code method**

The escape code method requires the existence of an escape code digit that will indicate to a switching system that the address that follows the escape code is in a different specific numbering plan. An escape code may be input by the caller as part of the called address. Also during call routing, an escape code may be inserted by a network component (e.g. switching system) as a leading digit in the address field when appropriate. Since they are interpreted as part of the address digit string, escape codes offer the advantage of being usable with inband signalling. However, that same characteristic makes them context-dependent and requires that they be uniquely defined within a specific numbering plan.

## **6.2.3 NPI method**

This method requires the use of a call control protocol and the existence of an NPI field within the protocol message that passes the called and calling addresses. The NPI field will contain a code that indicates what numbering plan the called (or calling) address belongs to. It is therefore not applicable to traditional PSTN call set-up methods. The network components (e.g. switching systems) that handle the protocol messages must understand how to properly interpret the NPI field. The NPI method has the advantage of being unambiguous – the numbering plan is clearly and uniquely identified by the coding in the NPI field. Because of its clarity and flexibility, the NPI method is the recommended method for the long term. In this Recommendation, the term "NPI method" in the figures refers to the use of the TOA/NPI address format in CRP/ICP as defined in 5.2/X.25 and 4.2/X.75.

## **6.3 Subscriber dialling procedures**

To the extent reasonably possible, the method used for a numbering plan interworking arrangement should be such that it minimizes the impact on the user. When a subscriber in one numbering plan wishes to call a subscriber whose number is in another numbering plan, there are two basic methods for dialling such a call. The two methods are called the single stage method and the double stage (or two-stage) method. Single stage methods are often considered preferable from the viewpoint of the caller, but the double stage method provides greater flexibility in some situations. Single stage operation also requires considerably greater implementation effort on the part of the network providers. Both single and double stage methods are included in the accompanying diagrams and are described below.

### **6.3.1 Single stage dialling**

Single stage dialling to achieve numbering plan interworking is typically accomplished in one of two ways:

- 1) The first subscriber dialling procedure requires the existence of an escape code arrangement whereby the initial digit(s) dialled by the caller as part of the called address are interpreted by the originating switching system to mean that the subsequent address digits are in a different numbering plan identified by the escape code digit(s).
- 2) The second subscriber dialling procedure requires the existence of a user-to-network protocol that contains an NPI field and an originating terminal that provides some means whereby the caller can specify the appropriate NPI. The caller then enters the called number in an appropriate format. The originating switching system can then use the information in the NPI field to determine the numbering plan of the called address.

In either case, the caller must be aware that the called number is in another numbering plan and must use the proper NPI or escape code when the call is placed.

### **6.3.2 Double stage dialling**

The double stage (or two-stage) method corresponds to an arrangement also commonly known as second dial tone. It derives its name from the fact that a caller must enter called address information in two separate stages. As the first stage or step in the process, the caller enters a called address that corresponds to a port of entry or access unit to a network that uses the numbering plan of the called subscriber. A connection is established between the caller and the access unit.

When the first connection has been established, the access unit sends a response (i.e. second dial tone or equivalent of a second dial tone) to the calling subscriber. At this point, the caller becomes equivalent to a subscriber on the network that has just returned the dial tone-like response. The caller then enters the address of the called subscriber. This second called address information is passed transparently through the originating network to the network that returned the second stage response. The call will then be established to the called subscriber.

Thus, the double stage method is essentially in its simplest form a manual numbering plan interworking arrangement where the caller uses a called address in the native numbering plan to access an entry port on a network that will then allow him to use the address of the called subscriber. Neither an escape code nor an NPI are required for this type of operation.

### **6.4 Escape code method versus NPI method**

The diagrams in this Recommendation refer to either the escape code method or the NPI method for number plan interworking. It must be noted that there is no correlation between the use of escape codes and double stage dialling or between the use of the NPI method and single stage dialling. The NPI method makes use of a specific field in the protocol used for call control. The NPI exists in the Q.931 protocol used for ISDN D-channel signalling and in the X.25 and X.75 packet layer protocols for signalling a call set-up.

Interworking from a terminal on a PSPDN (numbered under X.121) to a terminal on a network numbered under the E.164 number plan can be achieved by use of the escape code method in the calling PSPDN when the called address carried in the X.25 call request packet (including any prefixes and escape codes) is not greater than 15 digits. The escape code method can be used to signal a 14-digit E.164 number if a prefix is not used or a 13-digit E.164 number if a prefix is used. Within the PSPDN domain, the NPI approach is required when the called E.164 address (including prefixes and escape codes) would be greater than 15 digits. When a terminal on a PSPDN receives a call from an ISDN, the length of the calling number also determines which signalling method can be used. In those cases where the calling number is too long to be supported by the signalling method used on the user network interface, the PSPDN will either not provide a calling number or will clear the call (see 5.2.1/X.25). The capabilities in regard to the number of digits able to be carried in the X.25 called or calling address field, for signalling via either method, are summarized in Table 1.

TABLE 1

**Capabilities of the NPI method and the escape code method  
when used in the X.25 call request/incoming call packet**

Signalling method	Number of X.121 prefix digits	Number of X.121 escape code digits	Maximum number of E.164 digits in X.25 CRP/ICP
X.121 escape codes	1	1	13
X.121 escape codes	0	1	14
Use of X.25 TOA/NPI address format	Not applicable TOA field used	Not applicable NPI field used	15

The recommended solution for number plan interworking is the NPI method. It is not context-dependent, it is technically stable and it provides a high degree of flexibility as it has the capability to cater for future developments in number plans (for example the elimination of escape codes). Only the NPI method has the capability to signal a maximum length 15-digit E.164 number in the X.25 or X.75 call set-up packets.

Accordingly, switching equipment in packet switched public data networks, packet handlers within an ISDN and packet mode terminals having a requirement to provide interworking either to or from terminals identified by a 15-digit E.164 number will be required to support the NPI signalling method. Similarly, ISDN packet mode terminals identified by a 15-digit E.164 number and utilizing the X.25 packet layer protocol are also required to support the NPI method.

To enable packet mode terminals and networks (numbered under the X.121 numbering plan), which do not have the capability to support the NPI address format to interwork with packet mode terminals numbered under the E.164 numbering plan, the use of escape codes as part of the X.121 numbering plan format is permitted. However networks and terminals should evolve towards supporting the NPI address format. Packet mode terminals and networks not supporting the NPI address format will be unable to interwork with E.164 numbered networks and services utilizing 15 digits.

The use of digit "0" (zero) as an escape code within the E.164 numbering plan is a temporary arrangement to facilitate interworking prior to the implementation of Numbering Plan Identifier (NPI) based signalling protocols within packet mode terminals identified by an E.164 number.

The universal use of NPI address format will permit the recovery of escape code digits for use as the first digit of a country code identifier. In particular it should be carefully noted that due to the demand for country codes within the E.164 numbering plan, it has been identified that it will be necessary to recover the E.164 escape code "0". The use of escape code "0" within the E.164 numbering plan will be discontinued at 2359 hours (UTC) 31 December 2000 (see Recommendation E.165.1).

Accordingly, packet mode terminals on networks numbered under E.164 should evolve at the earliest opportunity towards support of the NPI mechanism to ensure an ongoing interworking capability beyond the time at which the E.164 escape code "0" is discontinued.

### **6.5 Reconciliation between the escape code method and the NPI method**

The subsequent diagrams in this Recommendation show interworking scenarios in which the originating and destination networks are using the same approach, i.e. both are using the escape code method or both are using the NPI method. There will be cases however in which the two networks will use the different methods available. An example of this is the configuration in which the originating network supports the NPI approach to set up a call, but the destination network supports

the escape method. Such an interworking configuration mandates that a conversion (or mapping) process takes place in the interworking gateway to reconcile the presentation of the address to the receiving network. Recommendation X.123 describes the mapping between the escape code address format and the NPI address format. Additionally reconciliation between a terminal and the network may be required to facilitate use of both methods. The conversion or mapping process is subject to bilateral agreements between the involved networks.

## **6.6 Internetwork implementation**

Because of the additional complexity, it is preferable that the numbering interworking function should not take place between two network nodes that are separated by an international boundary unless no other reasonable interworking possibility exists. In other words, it is preferable that, whenever possible, the network nodes on both ends of a call link that crosses an international boundary use the same native numbering plan. It is recognized that some Administrations may not be able to offer interworking capability for international traffic. Therefore, bilateral arrangements may be required to provide interworking capability. Some networks may select interworking arrangements other than those shown in this Recommendation.

The number analysis capability of a PSPDN for interworking with ISDN or PSTN should be five digits. The need to analyse more than five digits is for further study.

## **6.7 Man-machine interface procedures**

The man-machine interface procedures used with ISDN terminals to indicate the appropriate NPI are for further study.

## **7 Interworking diagrams**

This clause is comprised of three parts. The first part describes the conventions used in the interworking diagrams. The second part includes an index of the interworking diagrams that have been developed for this Recommendation. Finally, the third part contains the interworking diagrams.

### **7.1 Conventions used in the interworking diagrams (Figures 2 through 28)**

**7.1.1** The figures are intended only as examples and are consequently not restrictive unless it is specified.

**7.1.2** A specific set of figures is associated with each direction of interworking, but for both directions, the same reference configuration is used for comparison.

**7.1.3** Addresses are represented in the format applicable to the numbering plan. Prefixes are not included, but an escape code or NPI is shown where appropriate.

Furthermore, the presence and the exact format of the called and calling addresses at the DTE/DCE interface are network-dependent, including possible use of prefixes.

**7.1.4** The diagrams represent either 2, 3 or 4 network interworking cases.

**7.1.5** Where appropriate, bearer capability and relevant Recommendations are shown.

**7.1.6** The connection of networks and terminals, etc., are shown schematically by reference configurations.

**7.1.6.1** Networks are represented by ovals, terminals by triangles, and the path between them by a line.

**7.1.6.2** Vertical dotted arrows denote a place of possible international transit section/network. In cases where such international transit might occur, the diagrams will reflect the addresses signalled. Any part between two vertical dotted lines, or between a vertical dotted line and a terminal is a national matter.

**7.1.6.3** Under each terminal symbol a type of terminal has been indicated. Where an X.31 (called or calling) terminal is shown, this indicates an X.25 terminal using X.31 procedures. Where an X.32 (called or calling) terminal is shown, this indicates an X.25 terminal using X.32 procedures. In addition, under this information is shown the numbering plan(s) in which the terminal is identified.

**7.1.7** The number flows and additional call set-up procedures are shown in block diagram form under the network schematic.

**7.1.7.1** The networks are represented by large vertical rectangles connected by smaller horizontal rectangles in a two-layer structure.

**7.1.7.2** The lower layer shows the called and calling numbers which are associated to the X.25 protocol elements [i.e. Call Request Packet (CRP) and Incoming Call Packet (ICP)]. This lower layer is always entirely present from the calling terminal to the called terminal.

NOTE – Figures 2 and 3 do not conform to this convention because they are not packet mode related.

**7.1.7.3** The upper layer shows, when needed, the additional procedures associated with the establishment of the X.25 connection. This may include: establishment of a B-channel, establishment of an analogue connection, X.31 call offering procedures, etc.

NOTE – Figures 2 and 3 do not conform to this convention because they are not packet mode related.

**7.1.7.4** The rectangles are numbered, indicating the order in which the necessary steps are carried out.

**7.1.7.5** Access unit terminology in the diagrams is defined in Recommendation X.31, case A. This terminology is also used when X.32 is shown in the diagrams, as similarities exist in the two methods.

## **7.2 Index of interworking diagrams**

The diagrams associated with interworking are divided into four sections:

Section A: Scenarios for interworking.

Section B: Bearer capability interworking that requires no numbering plan interworking.

Section C: Numbering plan interworking.

Section D: Interworking with terminals that have dual numbers.

### **7.2.1 Section A: Scenarios for interworking**

Figure 1 Scenarios for interworking.

### **7.2.2 Section B: Bearer capability interworking that requires no numbering plan interworking**

Figure 2 Bearer capability interworking from an ISDN to a PSTN for voice services.

Figure 3 Bearer capability interworking from a PSTN to an ISDN for voice services.

Figure 4 Bearer capability interworking from an ISDN to a PSTN for packet data services.

Figure 5 Bearer capability interworking between a PSTN and an ISDN for packet data services.

Figure 6 Bearer capability interworking between ISDNs for packet data services.



### 7.2.3 Section C: Numbering plan interworking

- Figure 7 Interworking from a PSPDN to a PSTN for the provision of X.32 service.
- Figure 8 Interworking from a PSTN to a PSPDN for the provision of X.32 service.
- Figure 9 Interworking from a PSPDN to an ISDN using X.31 procedures (BC = 64) in a case A environment.
- Figure 10 Interworking from an ISDN using X.31 procedures (BC = 64) in a case A environment to a PSPDN.
- Figure 11 Interworking from a PSPDN to an ISDN using X.31 procedures (BC = PS) in a case B environment.
- Figure 12 Interworking from an ISDN using X.31 procedures (BC = PS) in a case B environment to a PSPDN.
- Figure 13 Interworking from a PSPDN to another PSPDN with an ISDN (BC = PS) as a transit network.
- Figure 14 Interworking from an ISDN using X.31 procedures (BC = PS) to an ISDN using X.31 procedures (BC = 64) with a PSPDN as a transit network.
- Figure 15 Interworking from an ISDN using X.31 procedures (BC = 64) to an ISDN using X.31 procedures (BC = PS) with a PSPDN as a transit network.
- Figure 16 Interworking from an ISDN using X.31 procedures (BC = PS) to an ISDN using X.31 procedures (BC = PS) with a PSPDN as a transit network.
- Figure 17 Interworking from an ISDN using X.31 procedures (BC = PS) (E.164 address) to an ISDN using X.31 procedures (BC = 64) (X.121 address) with a PSPDN as a transit network.
- Figure 18 Interworking from an ISDN using X.31 procedures (BC = 64) (X.121 address) to an ISDN using X.31 procedures (BC = PS) (E.164 address) with a PSPDN as a transit network.
- Figure 19 Interworking from an ISDN using X.31 procedures (BC = PS) to a PSTN for the provision of X.32 service (X.121 address) with a PSPDN as a transit network.
- Figure 20 Interworking from a PSTN using X.32 procedures (X.121 address) to an ISDN using X.31 procedures (BC = PS) (E.164 address), with a PSPDN as a transit network.
- Figure 21 Interworking from an ISDN using X.31 procedures (BC = PS) to a PSTN for the provision of X.32 service with a PSPDN as a transit network.
- Figure 22 Interworking from a PSTN using X.32 procedures to an ISDN using X.31 procedures (BC = PS), with a PSPDN as a transit network.
- Figure 23 Interworking from an ISDN using X.31 procedures (BC = PS) to an ISDN using X.32-like procedures in conjunction with a PSTN, with a PSPDN as a transit network.
- Figure 24 Interworking from a PSTN in conjunction with an ISDN using X.32-like procedures to an ISDN using X.31 procedures (BC = PS) with a PSPDN as a transit network.

### 7.2.4 Section D: Interworking with terminals that have dual numbers

- Figure 25 Interworking from a PSPDN to an ISDN using X.31 procedures (BC = 64) (E.164 and X.121 address).
- Figure 26 Interworking from an ISDN using X.31 procedures (BC = 64) (E.164 and X.121 address) to a PSPDN.
- Figure 27 Interworking from a PSPDN to a PSTN using X.32 procedures (E.164 and X.121 address).

Figure 28 Interworking from a PSTN using X.32 procedures (E.164 and X.121 address) to a PSPDN.

### 7.3 Interworking diagrams

Figure 1 is a representation of the interworking scenarios that are considered and provides a simple graphic depiction of the linkages between networks.

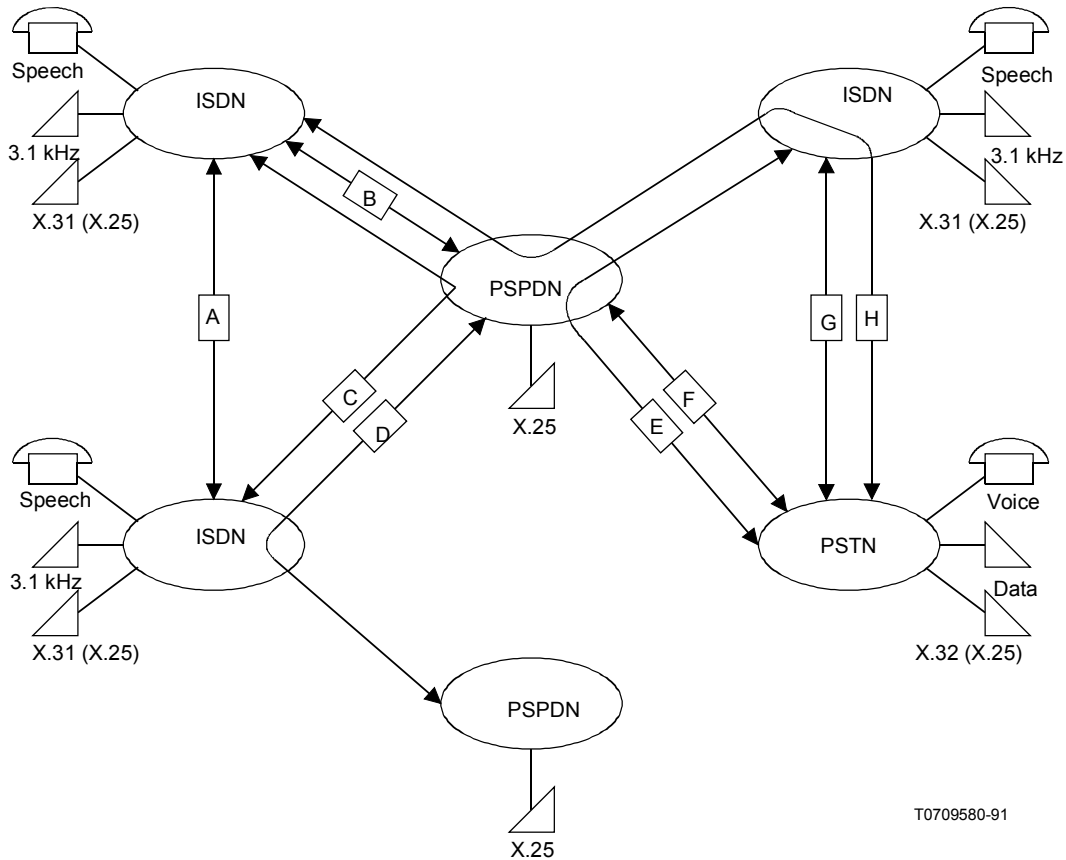

FIGURE 1  
Scenarios for interworking

The following is a listing that describes the links associated with each interworking figure.

- LINK A Figure 6.
- LINK B Figures 9, 10, 11, 12, 25, 26.
- LINK C Figures 14, 15, 16, 17, 18.
- LINK D Figure 13.
- LINK E Figures 19, 20, 21, 22.
- LINK F Figures 7, 8, 27, 28.
- LINK G Figures 2, 3, 4, 5.
- LINK H Figures 23, 24.

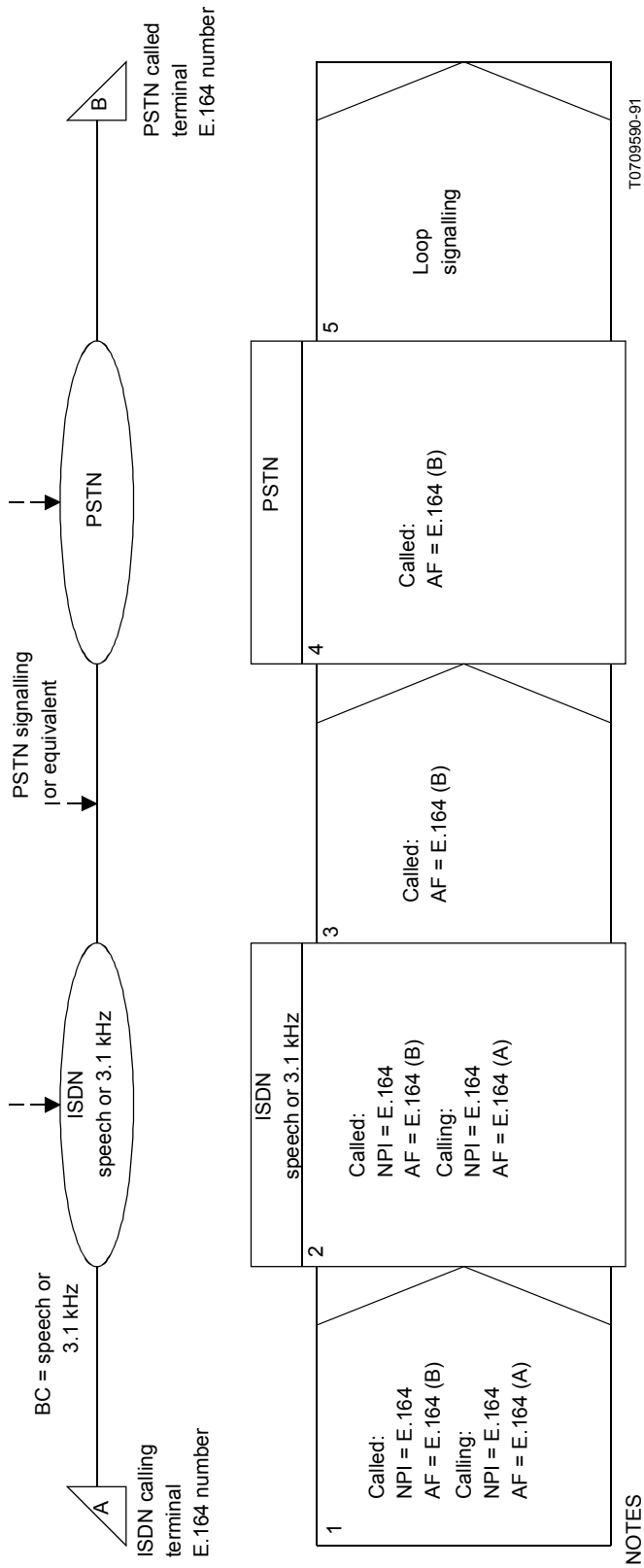
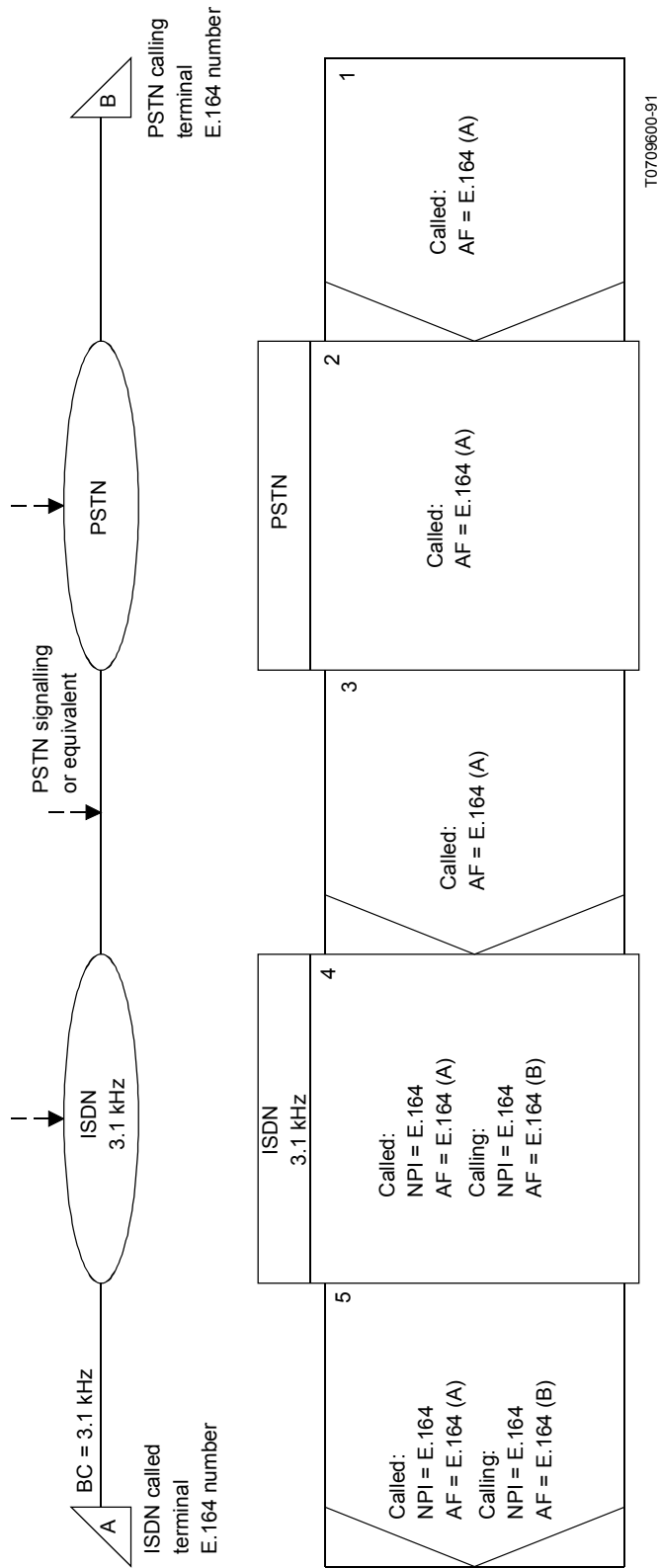

FIGURE 2

**Bearer capability interworking from an ISDN to a PSTN for voice services**



NOTES

- 1 This scenario is single stage dialling.
- 2 The ISDN terminal may be a V-Series terminal used with a terminal adapter.

FIGURE 3  
Bearer capability interworking from a PSTN to an ISDN for voice services

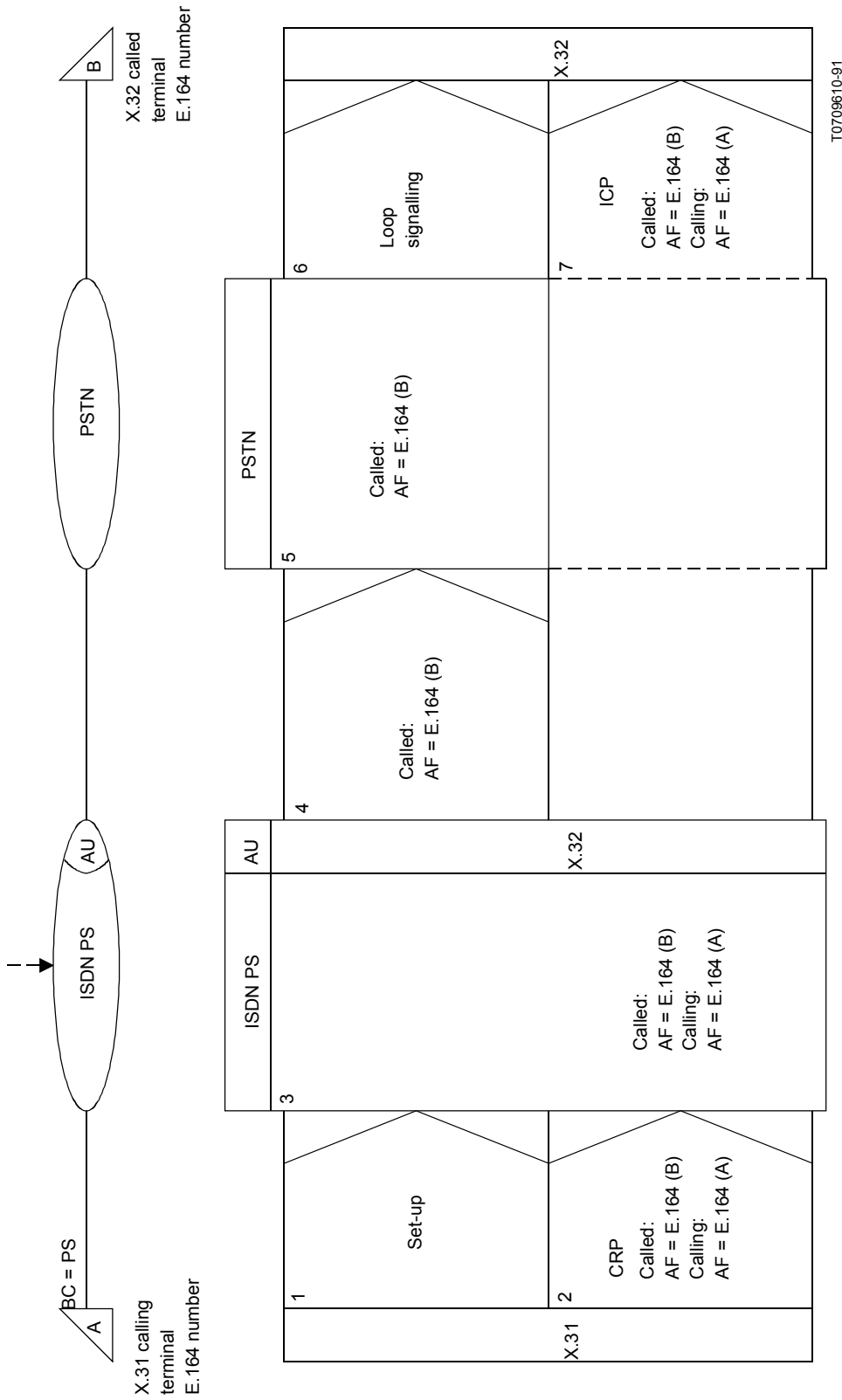

**NOTES**

- 1 This scenario is single stage dialling.
- 2 Steps 4, 5 and 6 are not used when a circuit is already established.
- 3 Step 1 is not used when a circuit is already established.
- 4 X.32-like access from an ISDN PS to a PSTN is not presently defined in ITU-T Recommendations. This is for urgent study by Study Groups 7 and 13.

**FIGURE 4**

**Bearer capability interworking from an ISDN to a PSTN for packet data services**

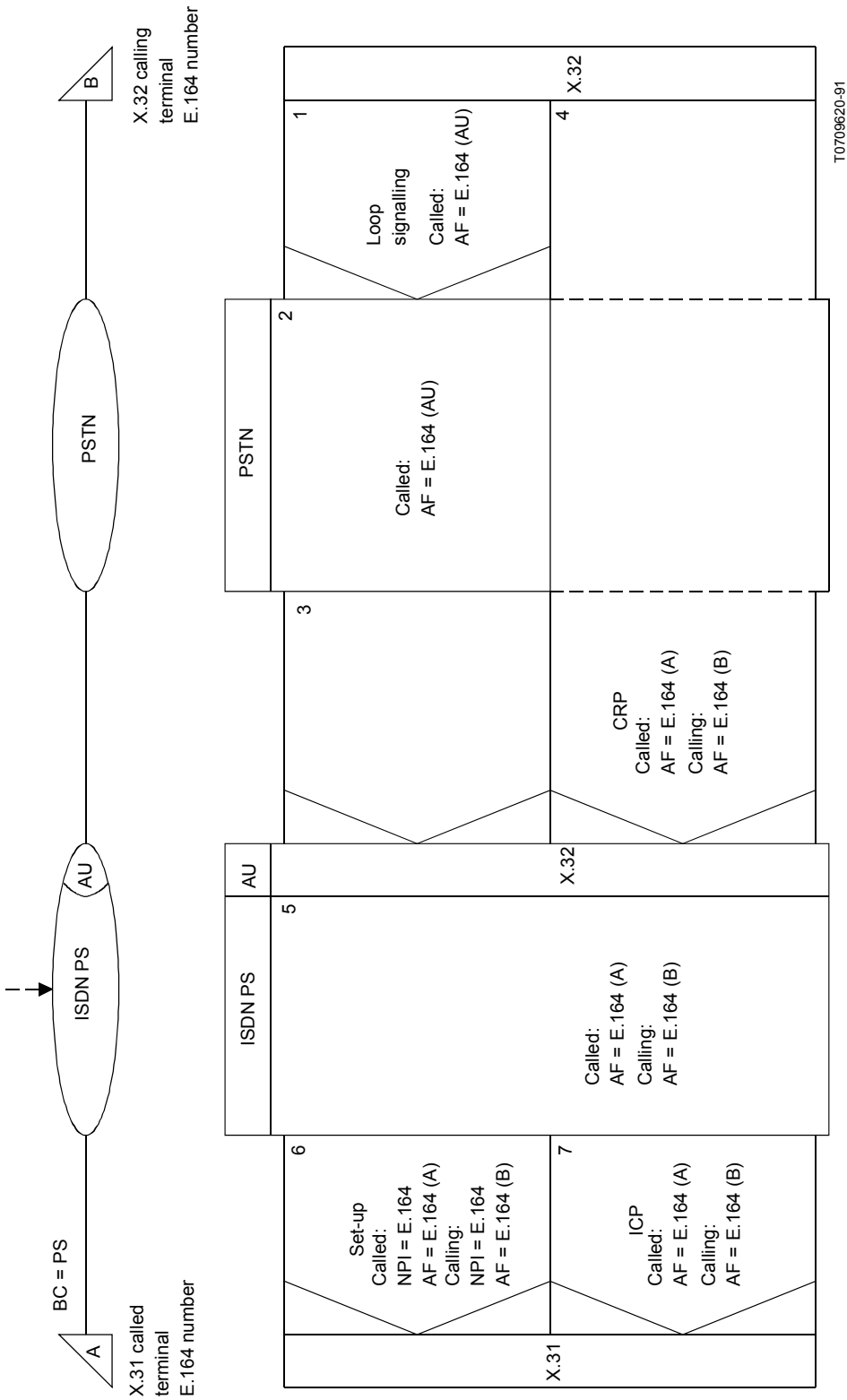

**NOTES**

- 1 This scenario is double stage dialling.
- 2 Steps 1, 2 and 3 are not used when a circuit is already established.
- 3 Step 6 is not used when there is no call offering (see Recommendation X.31). When used, the calling address might not be used.
- 4 X.32-like access form a PSTN to an ISDN PS is not presently defined in ITU-T Recommendations. This is for urgent study by Study Groups 7 and 13.

**FIGURE 5**

**Bearer capability interworking between a PSTN and an ISDN for packet data services**

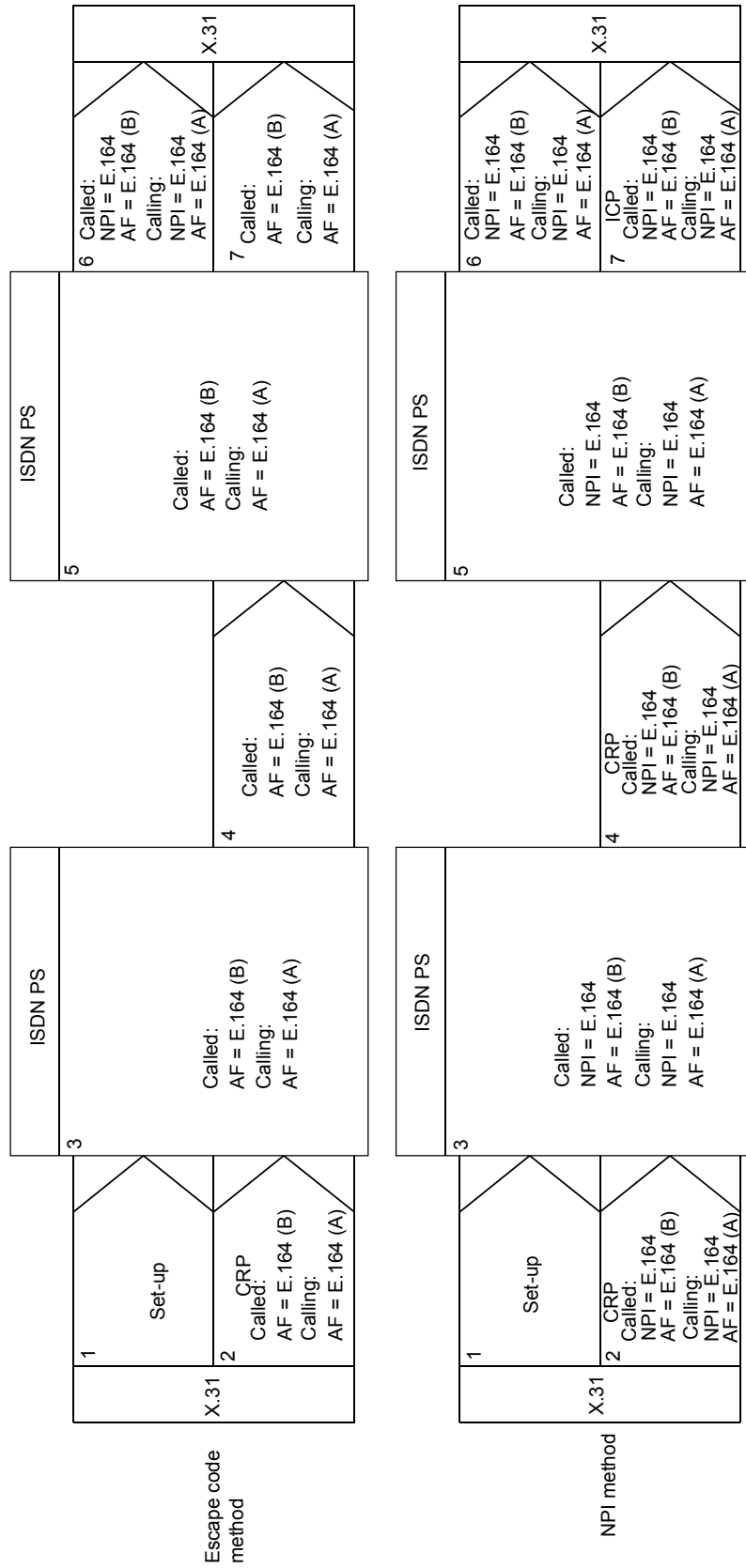
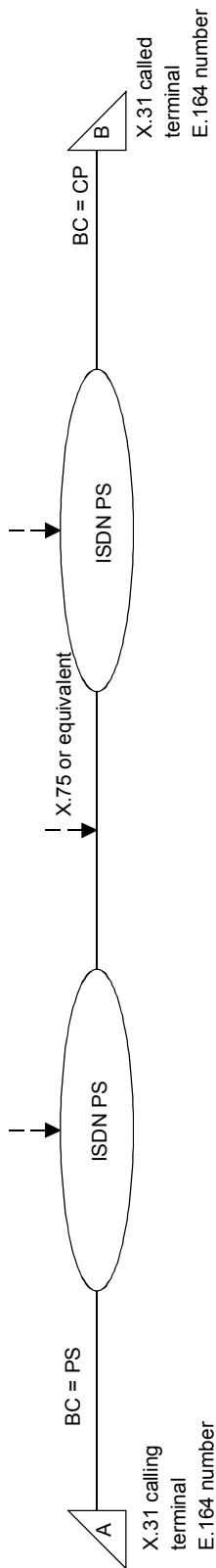

T0709630-91

**NOTES**

- 1 This figure is symmetrical and a call from B to A is made according to the same procedures.
- 2 This scenario is single stage dialling.
- 3 Step 1 is not present when packet mode over the D-channel is used or when a B-channel is already established.
- 4 See Recommendation X.31 for further details.

**FIGURE 6**  
**Bearer capability interworking between ISDNs for packet data services**

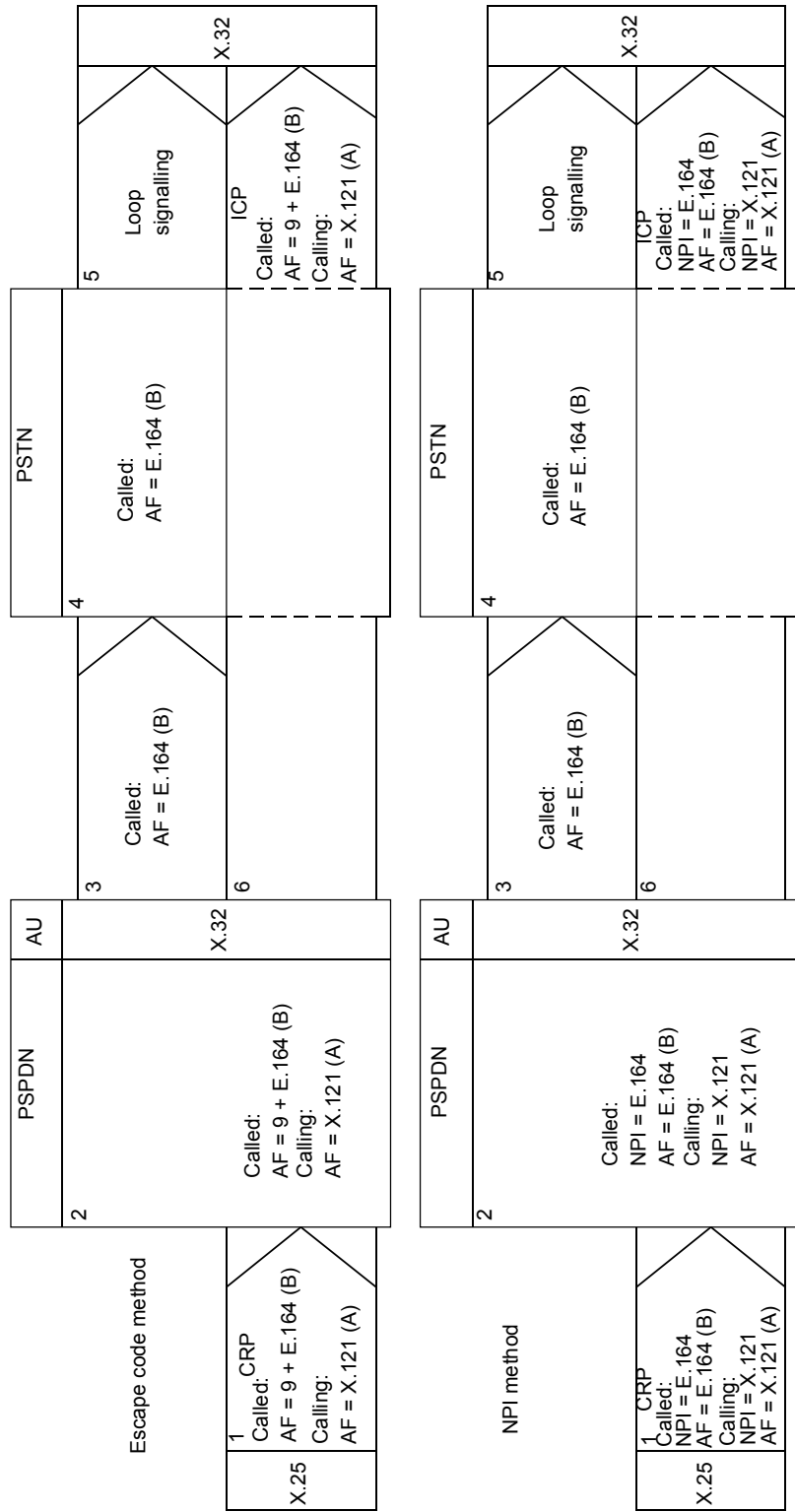
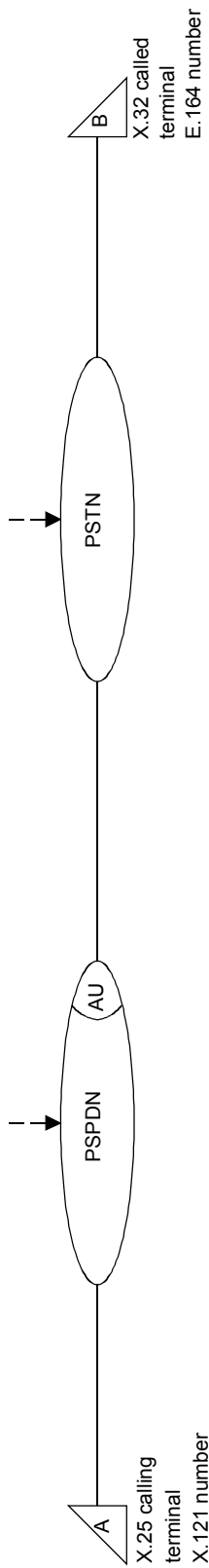

T0709640-91

NOTES

- 1 This scenario is single stage dialling.
- 2 Steps 3, 4 and 5 are not used when a circuit is already established.

FIGURE 7

Interworking from a PSPDN to a PSTN for the provision of X.32 service



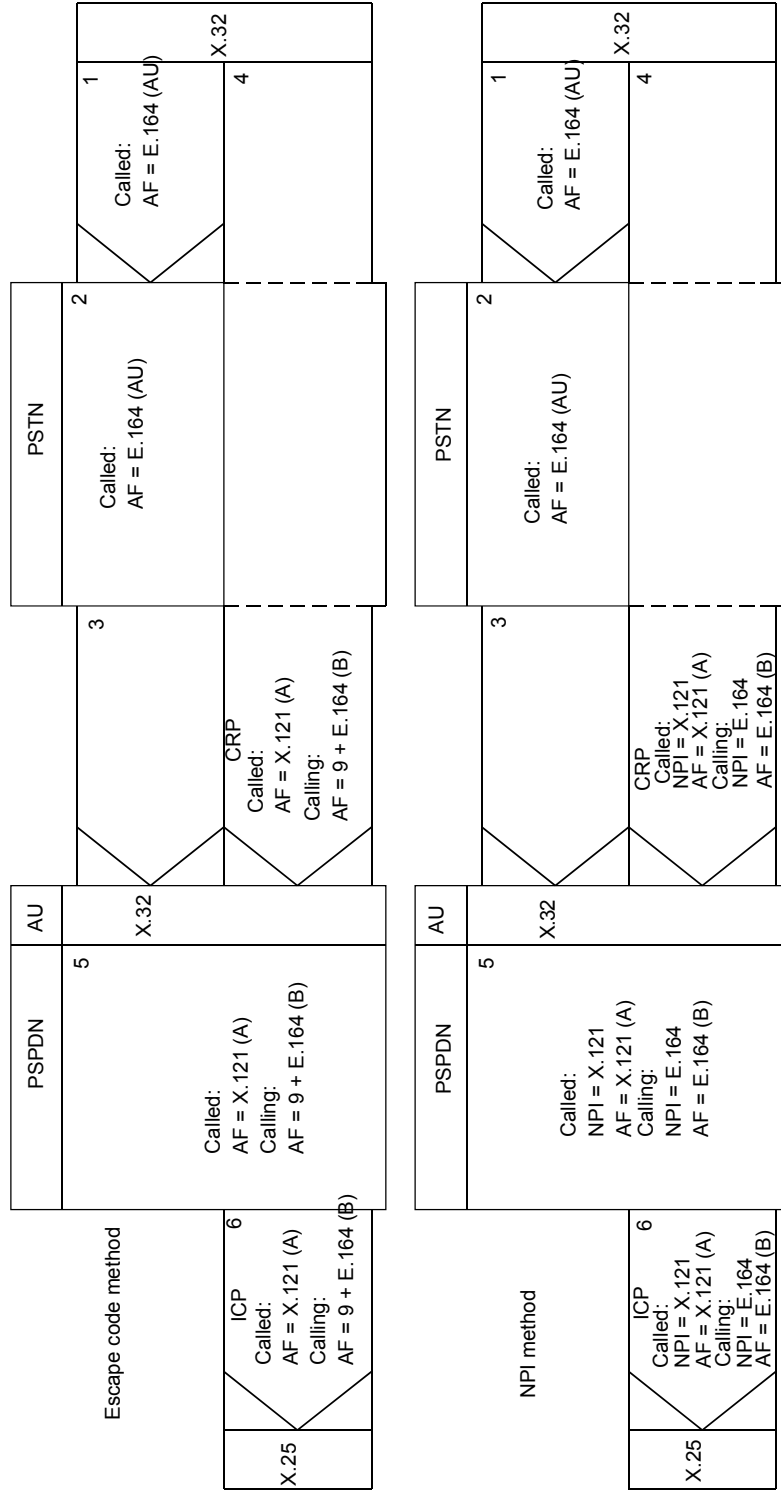
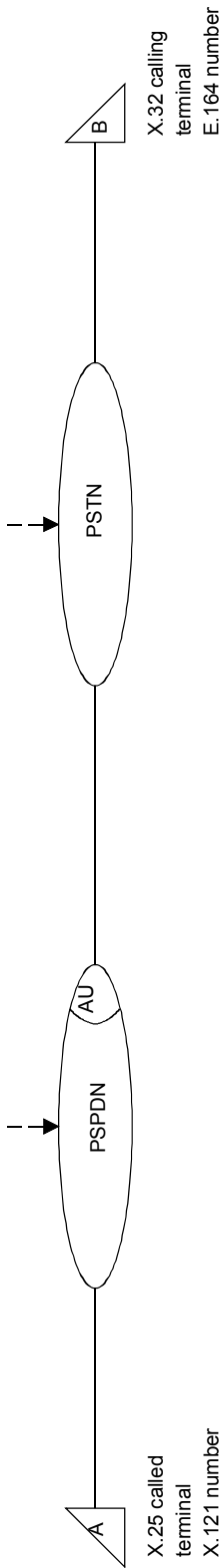

NOTES

- 1 This scenario is double stage dialling.
- 2 Steps 1, 2 and 3 are not used when a circuit is already established.
- 3 Signalling System No. 7 is not excluded in the PSTN network.

FIGURE 8

Interworking from a PSTN to a PSPDN for the provision of X.32 service

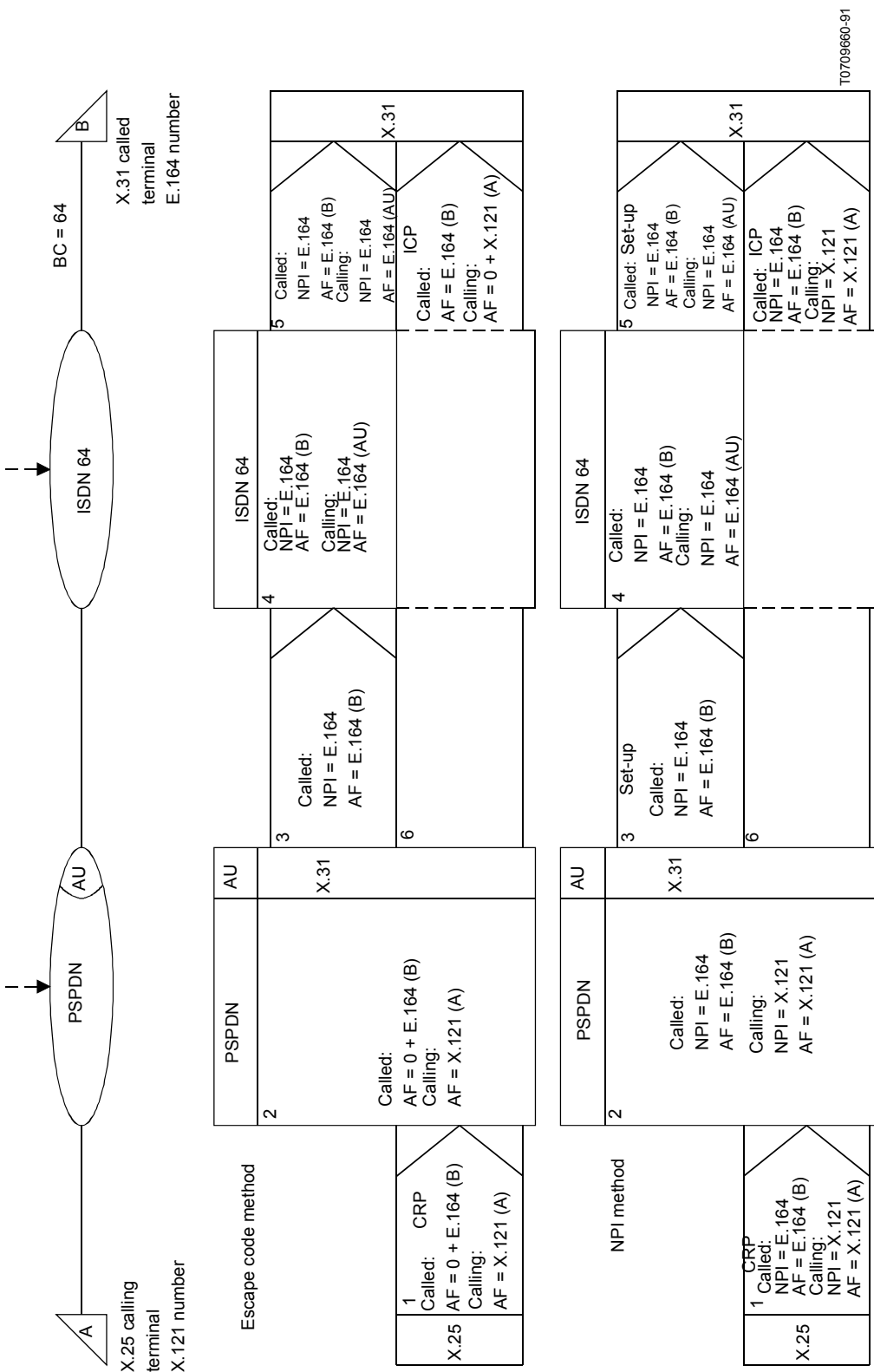

T0709660-91

NOTES

- 1 This scenario is single stage dialling.
- 2 Steps 3, 4 and 5 are not used when a circuit is already established.

FIGURE 9

Interworking from a PSPDN to an ISDN using X.31 procedures (BC = 64) in a case A environment

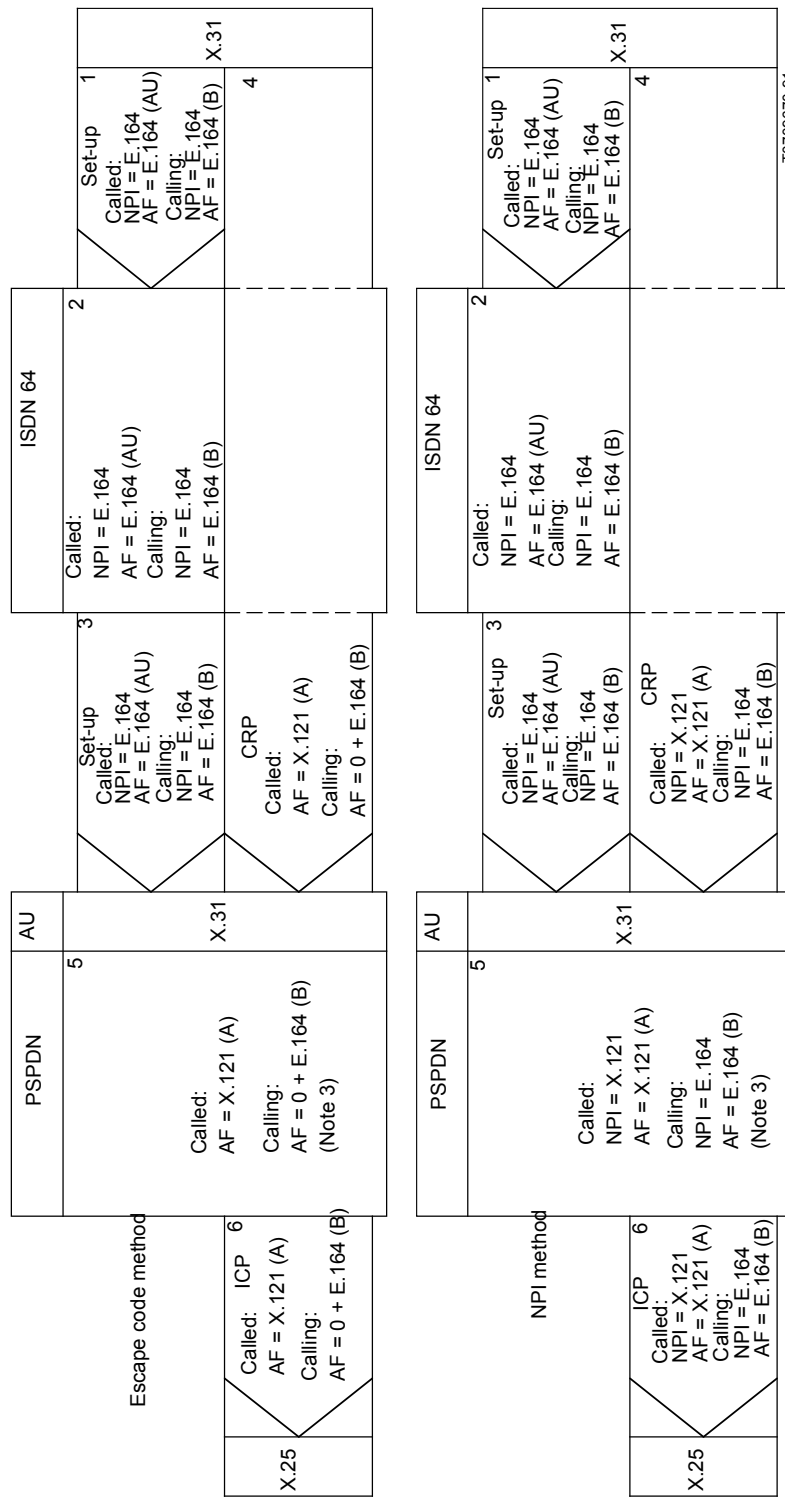
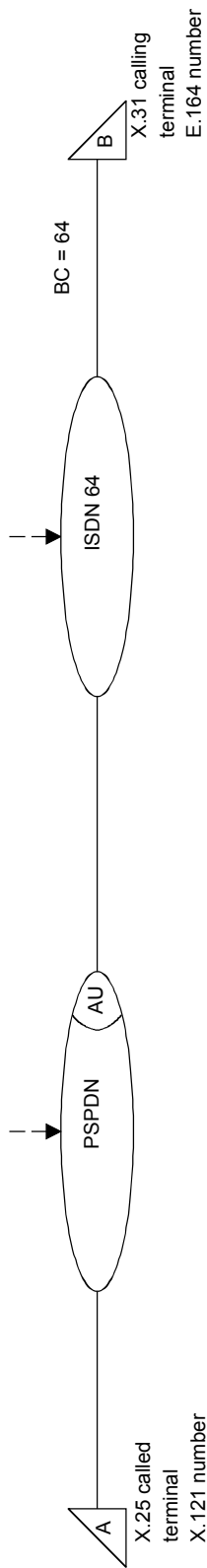

**NOTES**

- 1 This scenario is double stage dialling.
- 2 Steps 1, 2 and 3 are not used when a circuit is already established.
- 3 The identity of B is a compound process of the available calling party identity and is for further study.

FIGURE 10

**Interworking from an ISDN using X.31 procedures (BC = 64) in case A environment to a PSPDN**

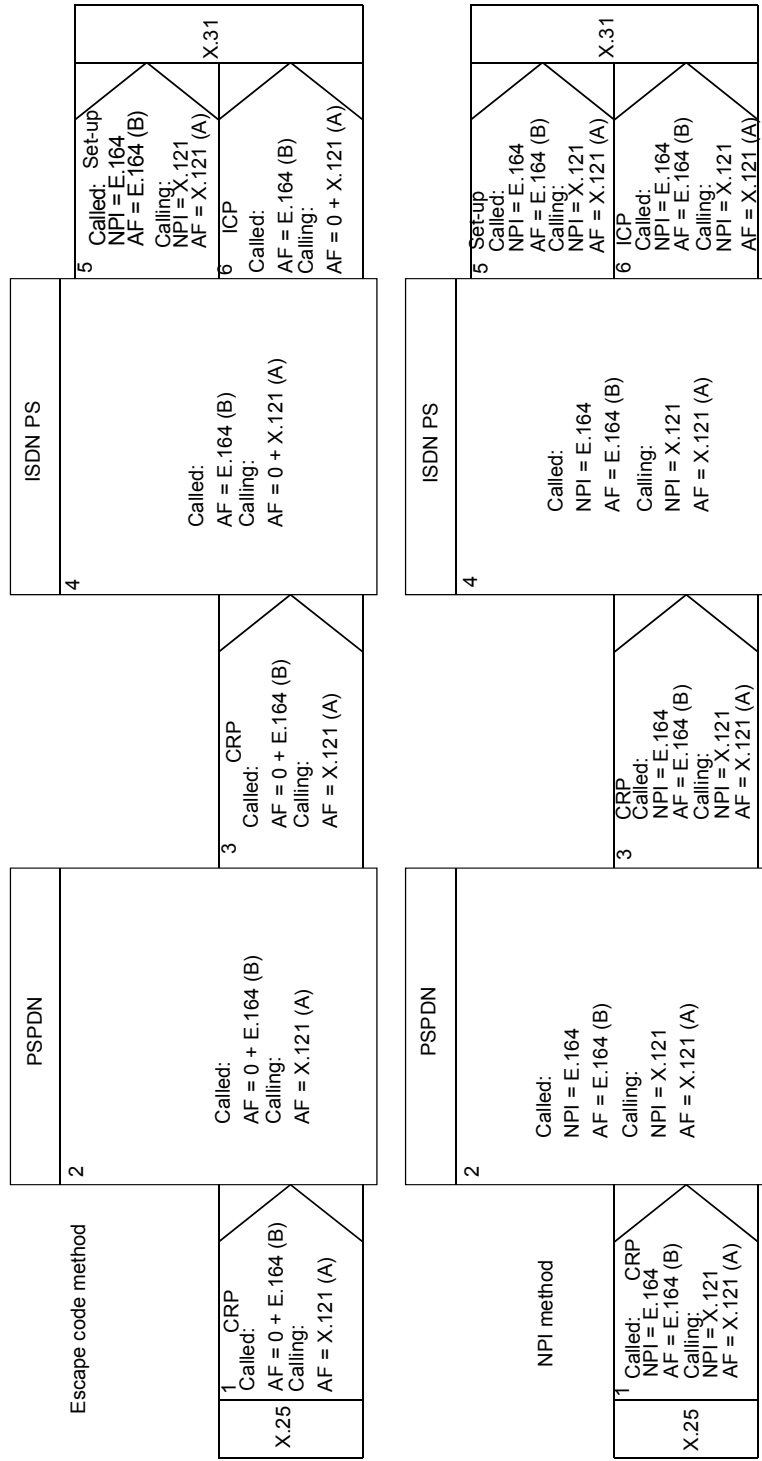
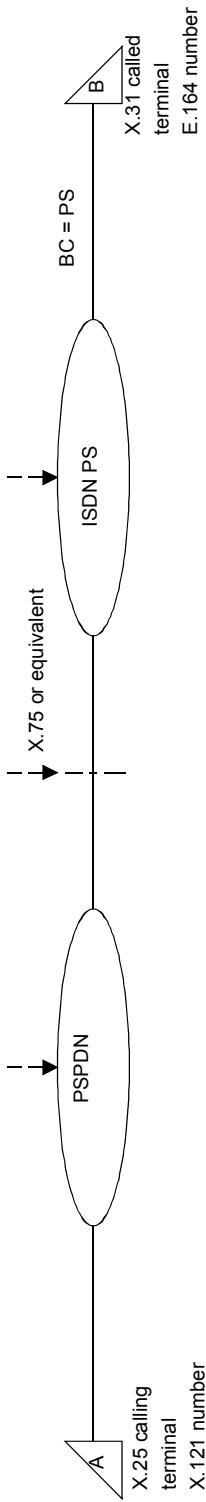

T0709680-91

NOTES

- 1 This scenario is single stage dialling.
- 2 Step 5 is not used when there is no call offering (see Recommendation X.31). When used the calling address might not be present.
- 3 See Recommendation X.31 for further details.

FIGURE 11

Interworking from a PSPDN to an ISDN using X.31 procedures (BC = PS) in a case B environment

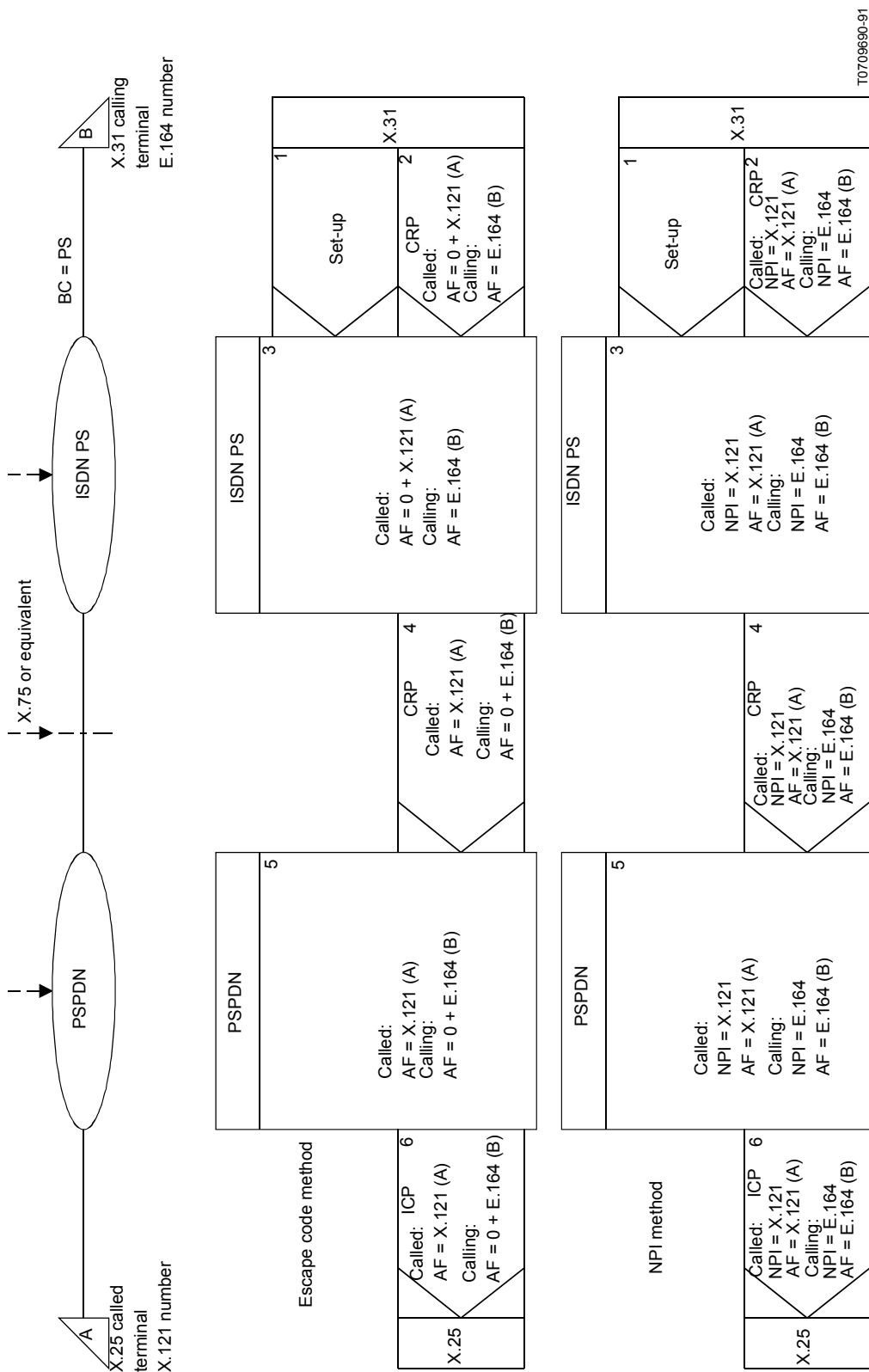

T0709690-91

NOTES

- 1 This scenario is single stage dialling.
- 2 Step 1 is not present when packet mode over the D-channel is used or when a B-channel is already established.
- 3 See Recommendation X.31 for further details.

FIGURE 12

Interworking from an ISDN using X.31 procedures (BC = PS) in a case B environment to a PSPDN

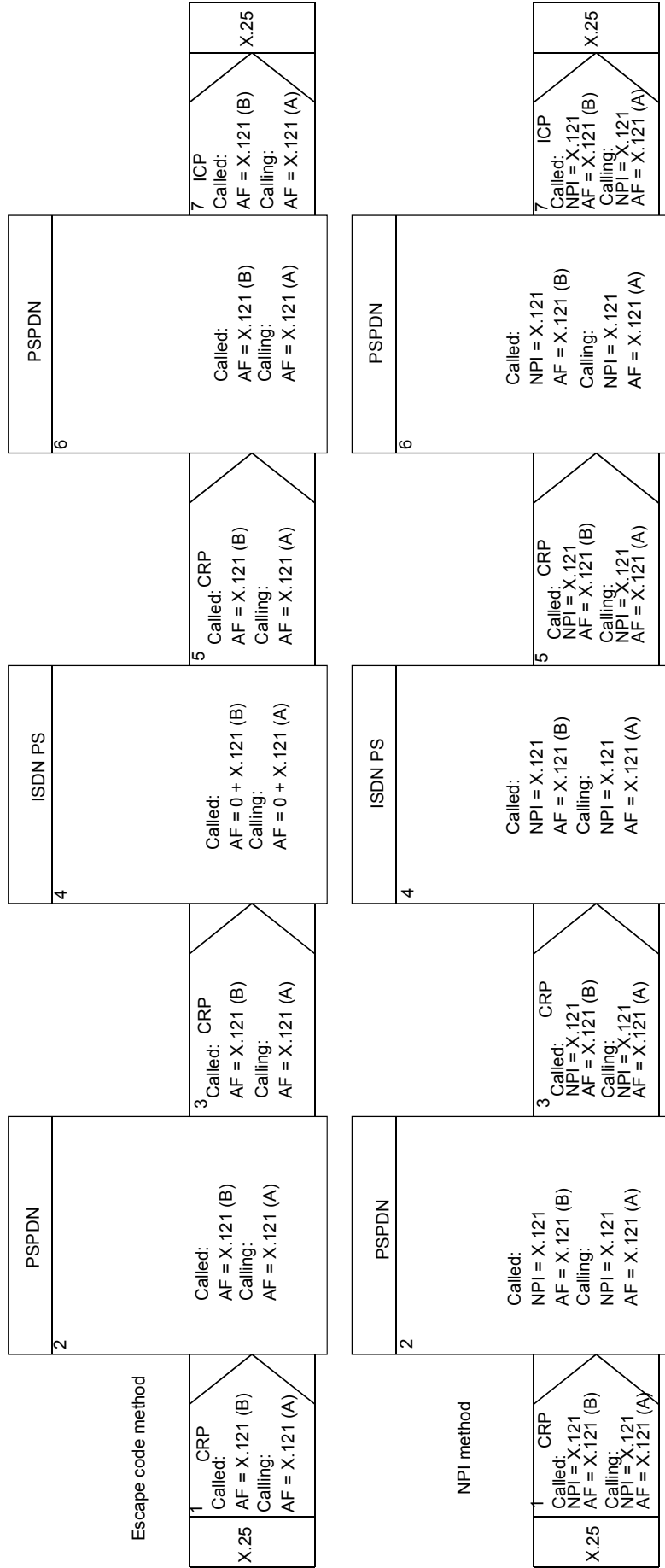
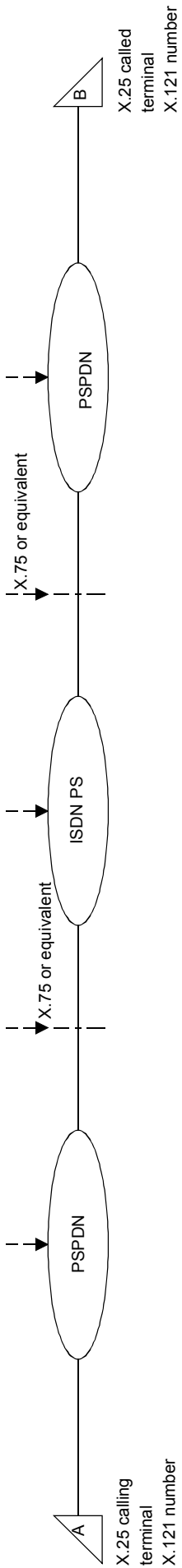

NOTES

- 1 This scenario is single stage dialling.
- 2 This figure is symmetrical and a call from B to A is made according to the same procedures.

FIGURE 13

Interworking from a PSPDN to another PSPDN with an ISDN (BC = PS) as a transit network

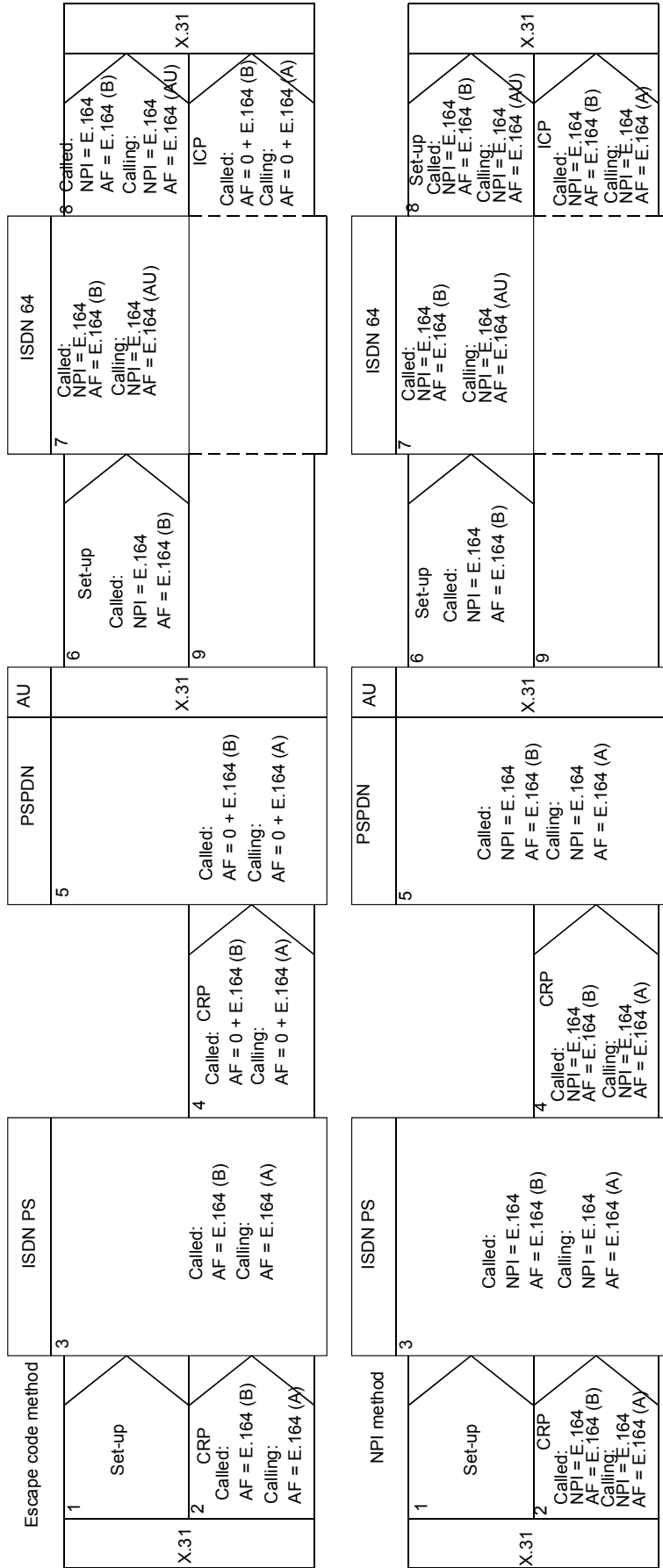
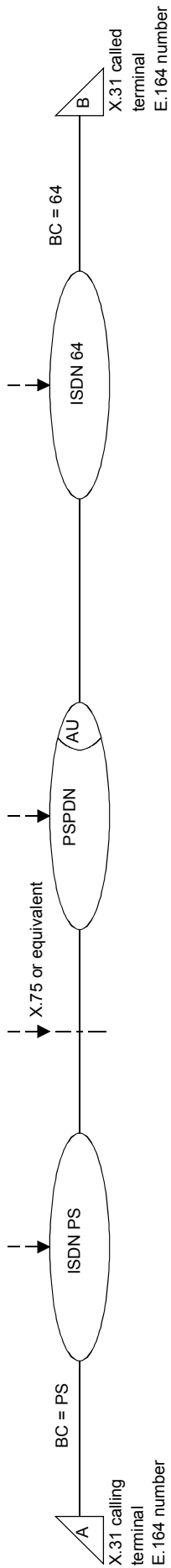

NOTES

- 1 This scenario is single stage dialling.
- 2 Step 1 is not present when packet mode over the D-channel is used or when a B-channel is already established.
- 3 Steps 6, 7 and 8 are not used when a circuit is already established.

T0709710-91

FIGURE 14  
Interworking from an ISDN using X.31 procedures (BC = PS) to an ISDN using X.31 procedures (BC = 64) with a PSPDN as a transit network

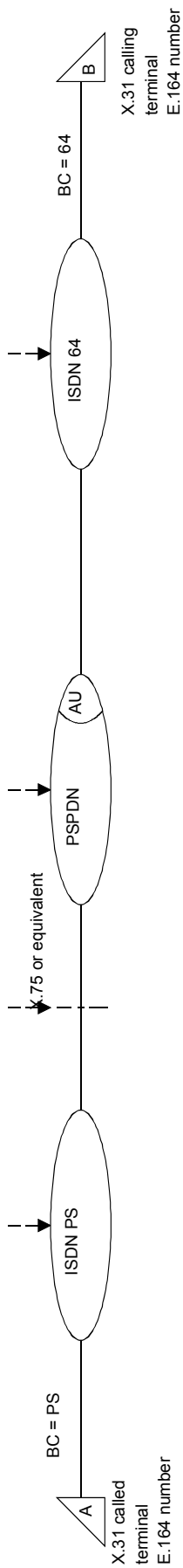

Escape code method	8	Set-up Called: NPI = E.164 AF = E.164 (A) Calling: NPI = E.164 AF = E.164 (B)	ISDN PS	7	Called: AF = E.164 (A) Calling: AF = E.164 (B)
	9	ICP Called: AF = E.164 (A) Calling: AF = E.164 (B)		6	CRP Called: AF = 0 + E.164 (A) Calling: AF = 0 + E.164 (B)
X.31	5	Called: AF = 0 + E.164 (A) Calling: AF = 0 + E.164 (B)	PSPDN	AU	X.31
	3	Called: Set-up NPI = E.164 AF = E.164 (AU) Calling: NPI = E.164 AF = E.164 (B)	ISDN 64	2	Called: Set-up NPI = E.164 AF = E.164 (AU) Calling: NPI = E.164 AF = E.164 (B)

NPI method	8	Set-up Called: NPI = E.164 AF = E.164 (A) Calling: NPI = E.164 AF = E.164 (B)	ISDN PS	7	Called: NPI = E.164 AF = E.164 (A) Calling: NPI = E.164 AF = E.164 (B)
	9	ICP Called: NPI = E.164 AF = E.164 (A) Calling: NPI = E.164 AF = E.164 (B)		6	CRP Called: NPI = E.164 AF = E.164 (A) Calling: NPI = E.164 AF = E.164 (B)
X.31	5	Called: NPI = E.164 AF = E.164 (A) Calling: NPI = E.164 AF = E.164 (B)	PSPDN	AU	X.31
	3	Called: Set-up NPI = E.164 AF = E.164 (AU) Calling: NPI = E.164 AF = E.164 (B)	ISDN 64	2	Called: Set-up NPI = E.164 AF = E.164 (AU) Calling: NPI = E.164 AF = E.164 (B)

**NOTES**

- 1 This scenario is double stage dialling.
- 2 Steps 1, 2 and 3 are not used when a circuit is already established.
- 3 Step 8 is not used when there is no call offering (see Recommendation X.31). When used the calling address may not be present.

**FIGURE 15**  
**Interworking from an ISDN using X.31 procedures (BC = 64) to an ISDN using X.31 procedures (BC = PS)**  
**with a PSPDN as a transit network**

T0709720-91



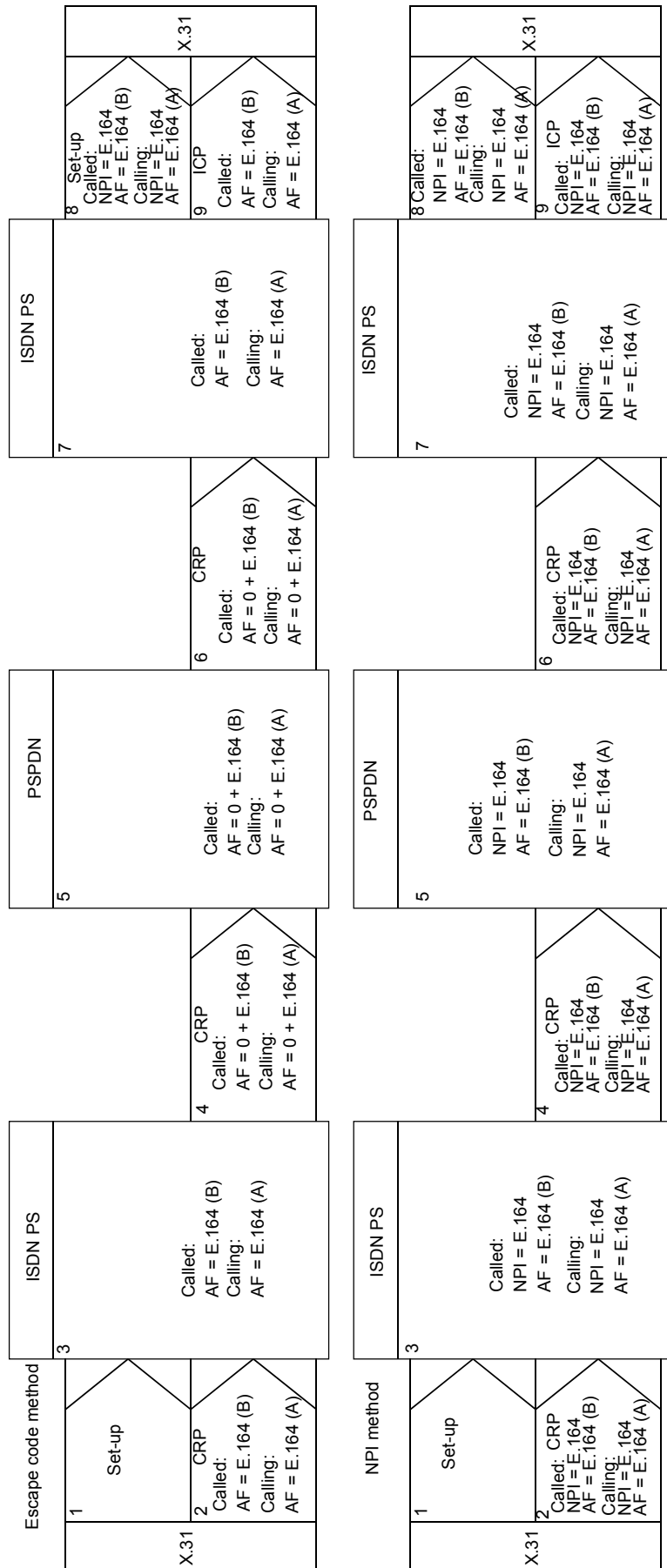
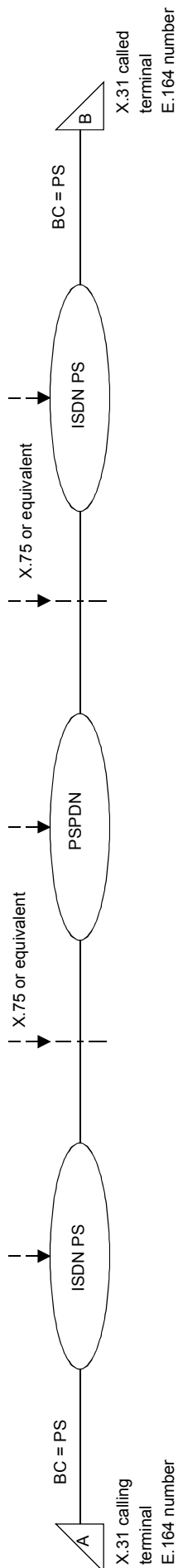

NOTES

- 1 This figure is symmetrical and a call from B to A is made according to the same procedure.
- 2 This scenario is single stage dialling.
- 3 Step 1 is not present when packet mode over the D-channel is already established.
- 4 Step 8 is not used when there is no call offering (see Recommendation X.31). When used the calling address may not be present.

FIGURE 16

**Interworking from an ISDN PS network using X.31 procedures (BC = PS) to an ISDN PS network using X.31 procedures (BC = PS) with a PSPDN as a transit network**

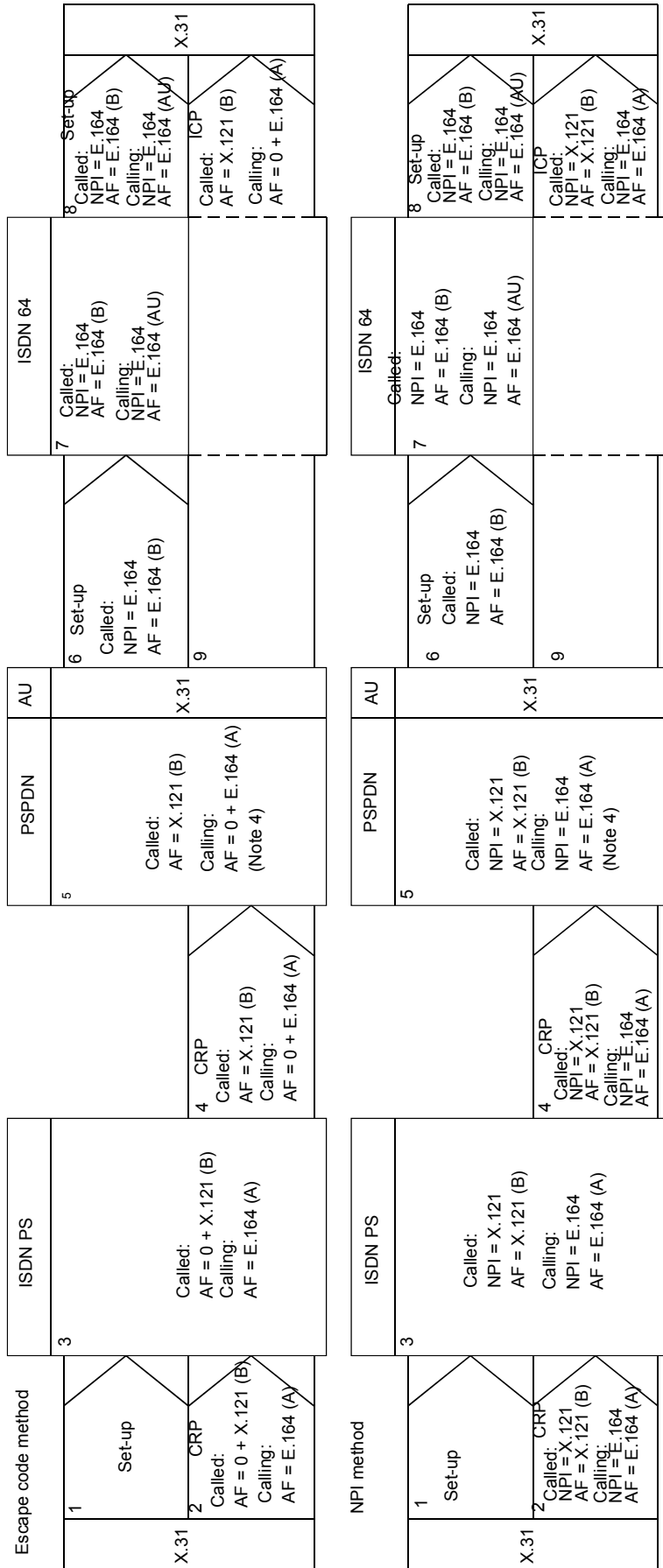
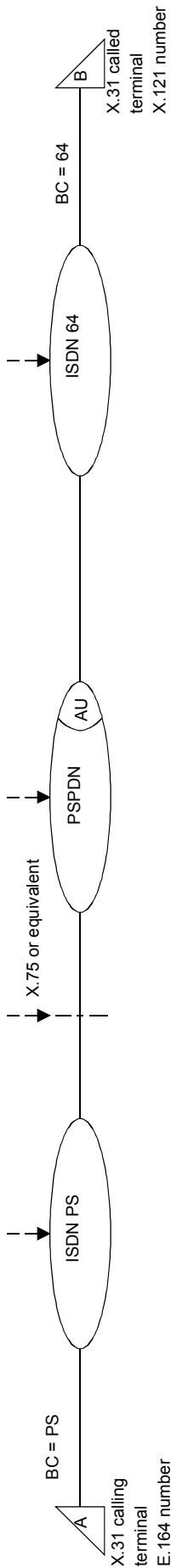

T0709740-91

NOTES

- 1 This scenario is single stage dialling.
- 2 Step 1 is not present when packet mode over the D-channel is used or when a B-channel is already established.
- 3 Steps 6, 7 and 8 might not be used when a circuit is already established.
- 4 The access unit (AU) has to achieve translation to obtain E.164 (B) from X.121 (B).

FIGURE 17

**Interworking from an ISDN using X.31 procedures (BC = PS) (E.164 address) to an ISDN using X.31 procedures (BC = 64) (X.121 address) with a PSPDN as a transit network**

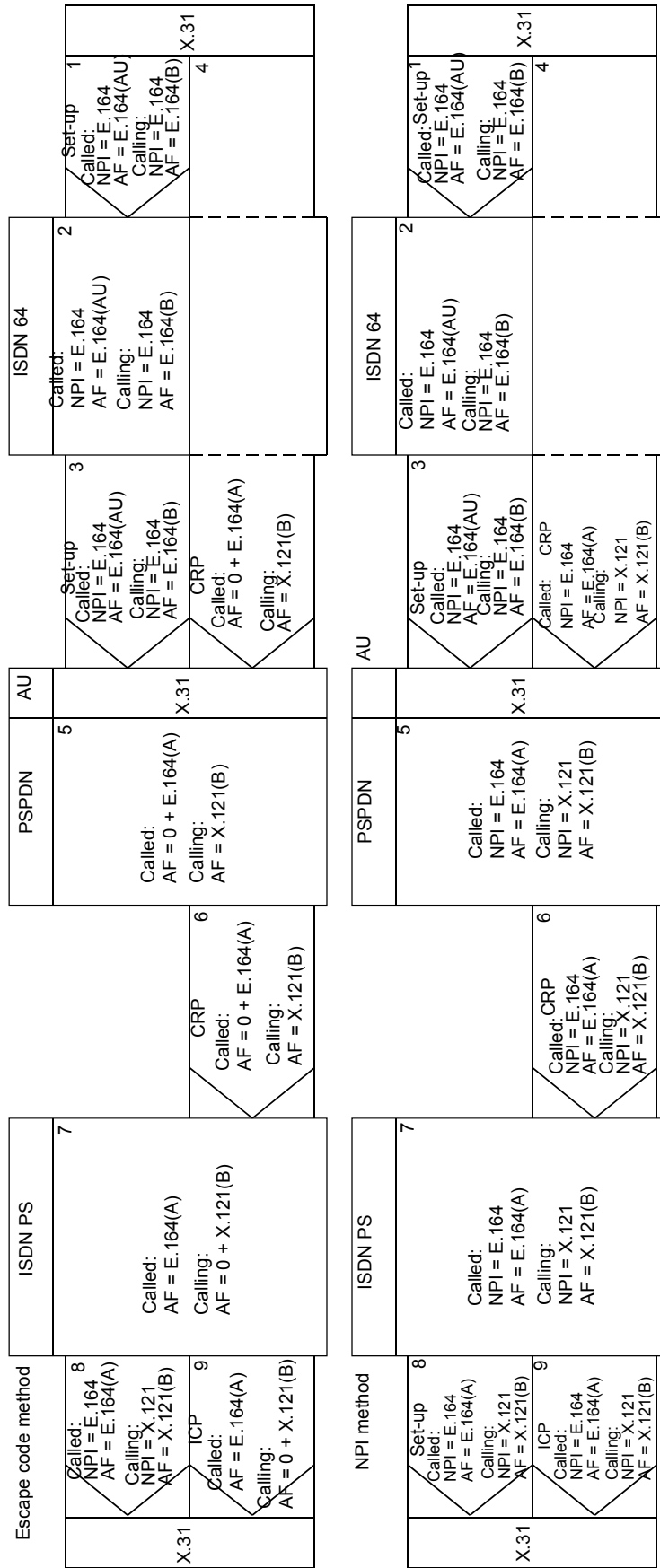
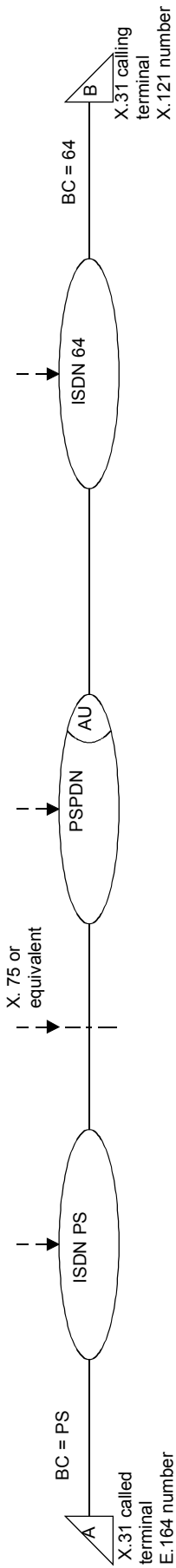

T0709750-91

**NOTES**

- 1 This scenario is double stage dialling.
- 2 Steps 1, 2 and 3 are not used when a circuit is already established.
- 3 Step 8 is not used when there is no call offering (see Recommendation X.31). When used the calling address might not be present.

FIGURE 18

**Interworking from an ISDN using X.31 procedures (BC = 64) (X.121 address) to an ISDN using X.31 procedures (BC = PS) (E.164 address) with a PSPDN as a transit network**

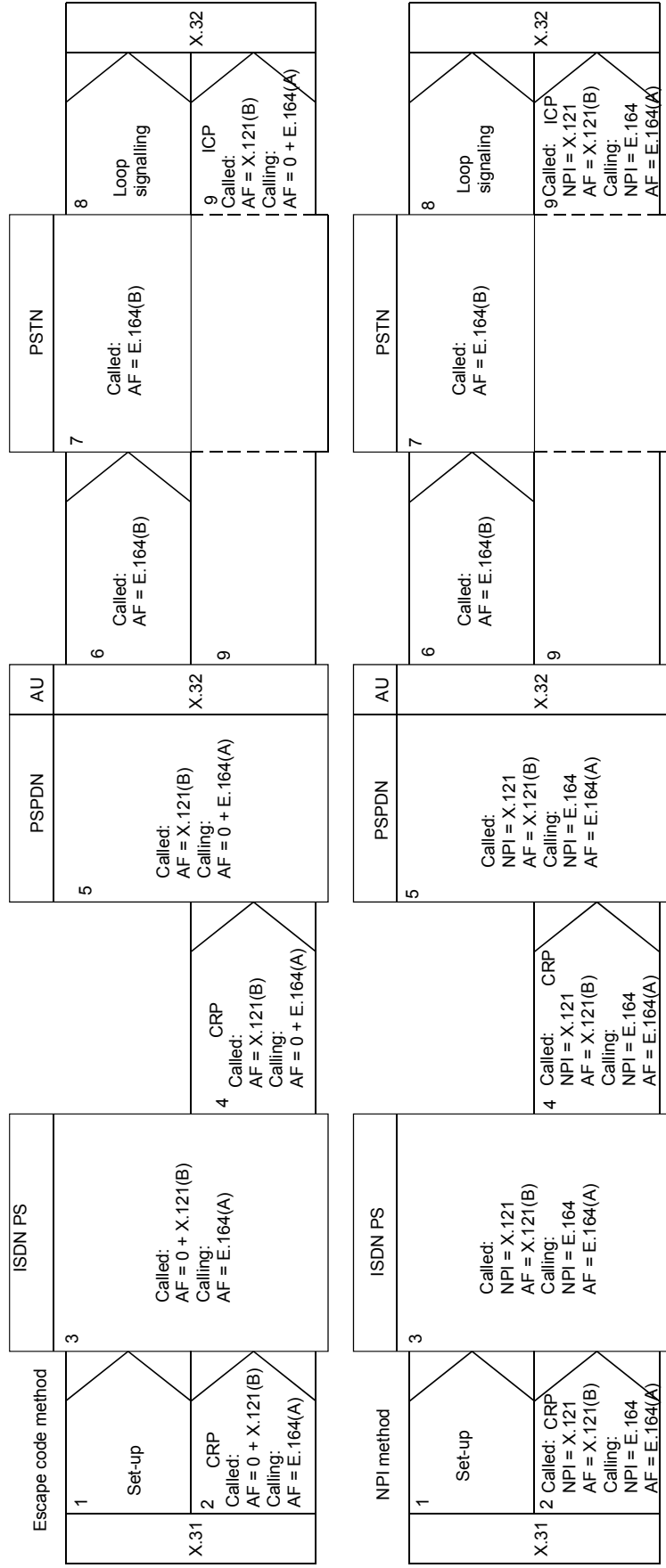
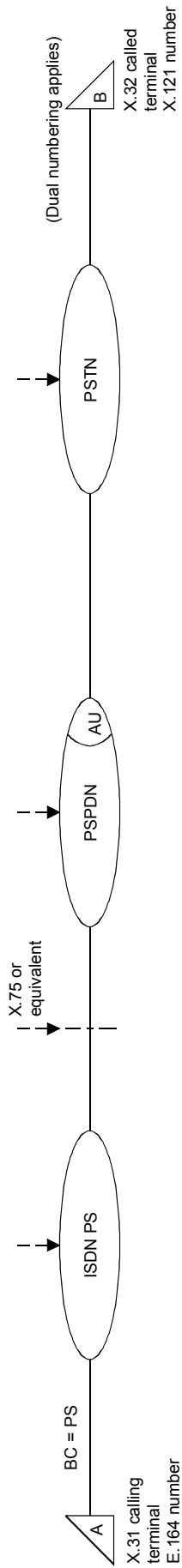

T0709760-91

NOTES

- 1 This scenario is single stage dialling.
- 2 The AU has to achieve some translation to obtain E.164 (B) from X.121 (B).
- 3 Step 1 is not present when packet mode over the D-channel is used or when a B-channel is already in existence.
- 4 Steps 6, 7 and 8 are not used when there is no call offering (see Recommendation X.31). When used the calling address might not be present.

FIGURE 19  
Interworking from an ISDN using X.31 procedures (BC = PS) to a PSTN for the provision of X.32 service (X.121 address) with a PSPDN as a transit network

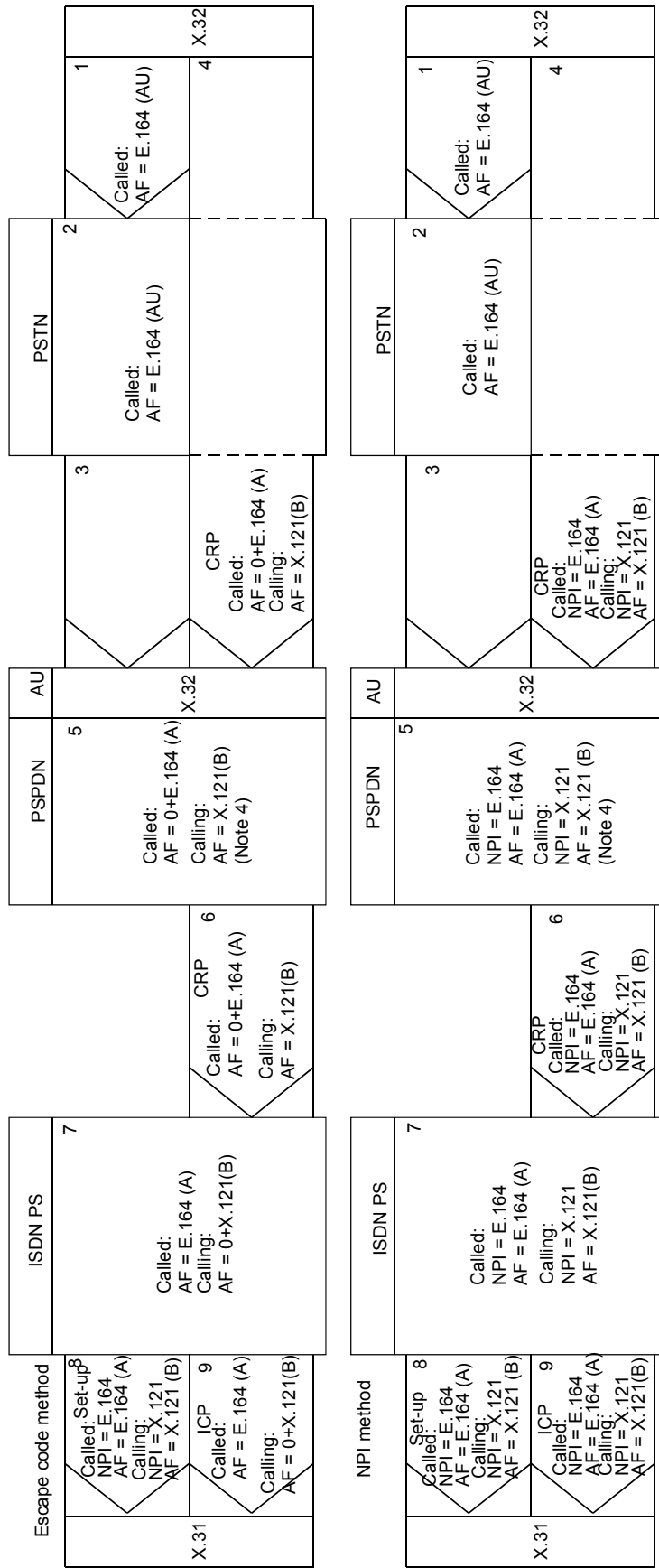
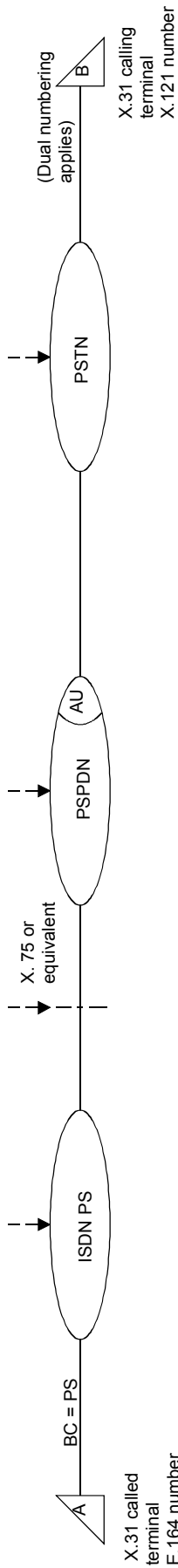

T0709770-91

NOTES

- 1 This scenario is double stage dialling.
- 2 Steps 1, 2 and 3 are not used when a circuit is already established.
- 3 Step 8 is not used when there is no call offering (see Recommendation X.31). When used the calling address might not be present.
- 4 The identity of B is a compound process of the available calling party and is for further study.

FIGURE 20

**Interworking from a PSTN using X.32 procedures (X.121 address) to an ISDN using X.31 procedures (BC = PS) (E.164 address), with a PSPDN as a transit network**

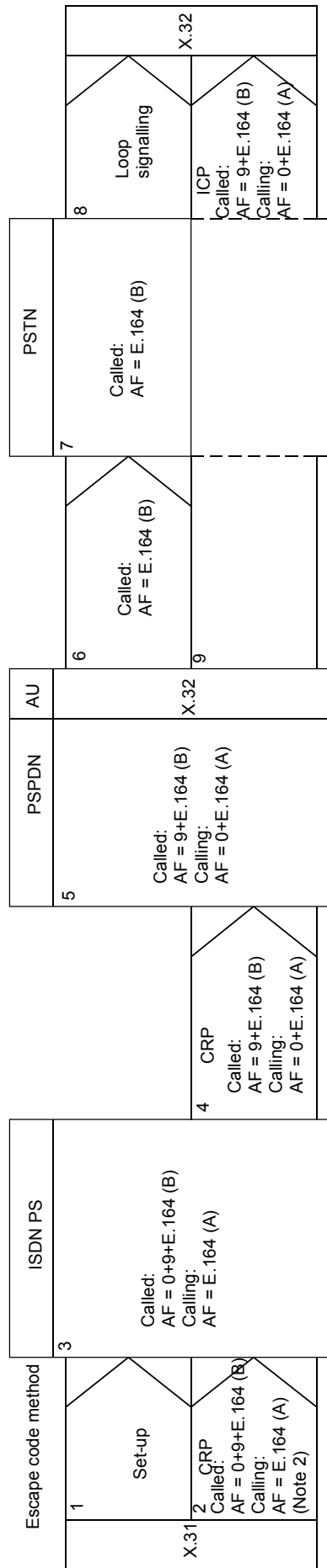
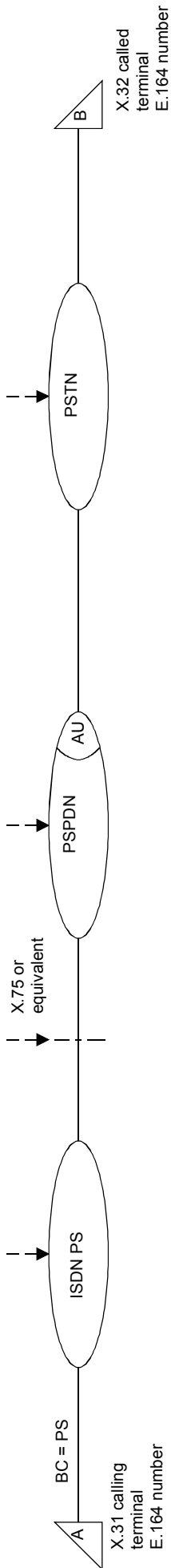

T0709780-91

NOTES

- 1 This scenario is single stage dialling.
- 2 The reverse dialling principles are not observed.
- 3 Step 1 is not present when packet mode over the D-channel is used or when a B-channel is already established.
- 4 Steps 6, 7 and 8 are not used when a circuit is already established.
- 5 Based upon the NPI method, no long-term approach is technically feasible.

FIGURE 21

Interworking from an ISDN using X.31 procedures (BC = PS) to a PSTN for the provision of X.32 service with a PSPDN as a transit network

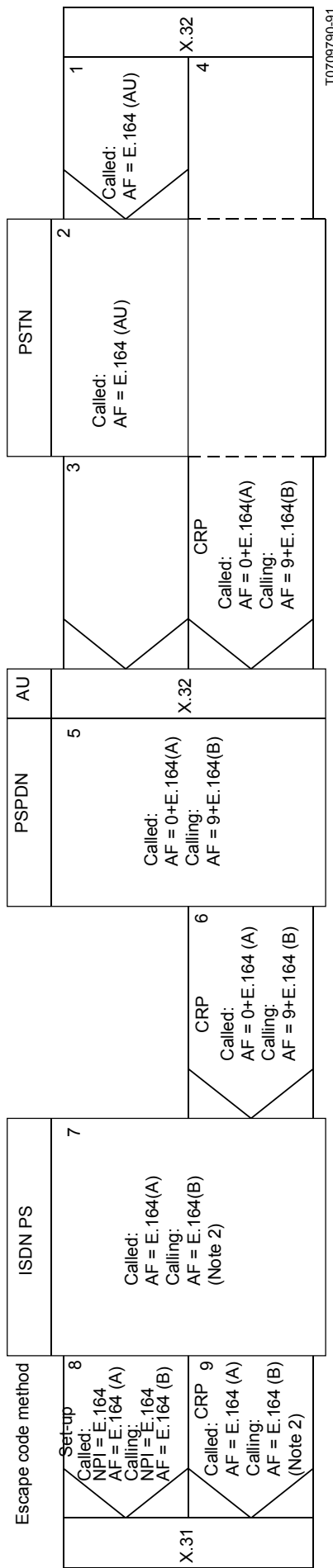
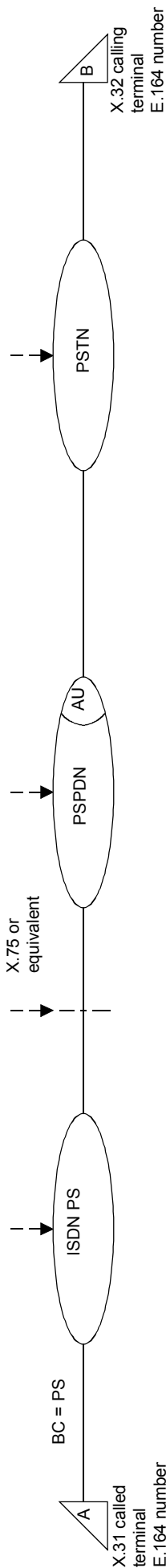

NOTES

- 1 This scenario is double stage dialling.
- 2 The reverse dialling principles are not observed in this example. However, some ISDN PS may be able to generate and offer to the called party the concatenated escape codes 0 + 9 in the calling address to fulfill the reverse dialling principles.
- 3 Steps 1, 2 and 3 are not used when a circuit is already established.
- 4 Step 8 is not used when there is no call offering (see Recommendation X.3.1). When used the calling address might not be present.
- 5 Based upon the NPI method, no long-term approach is technically feasible.

FIGURE 22

Interworking from a PSTN using X.32 procedures to an ISDN using X.31 procedures (BC = PS), with a PSPDN as a transit network

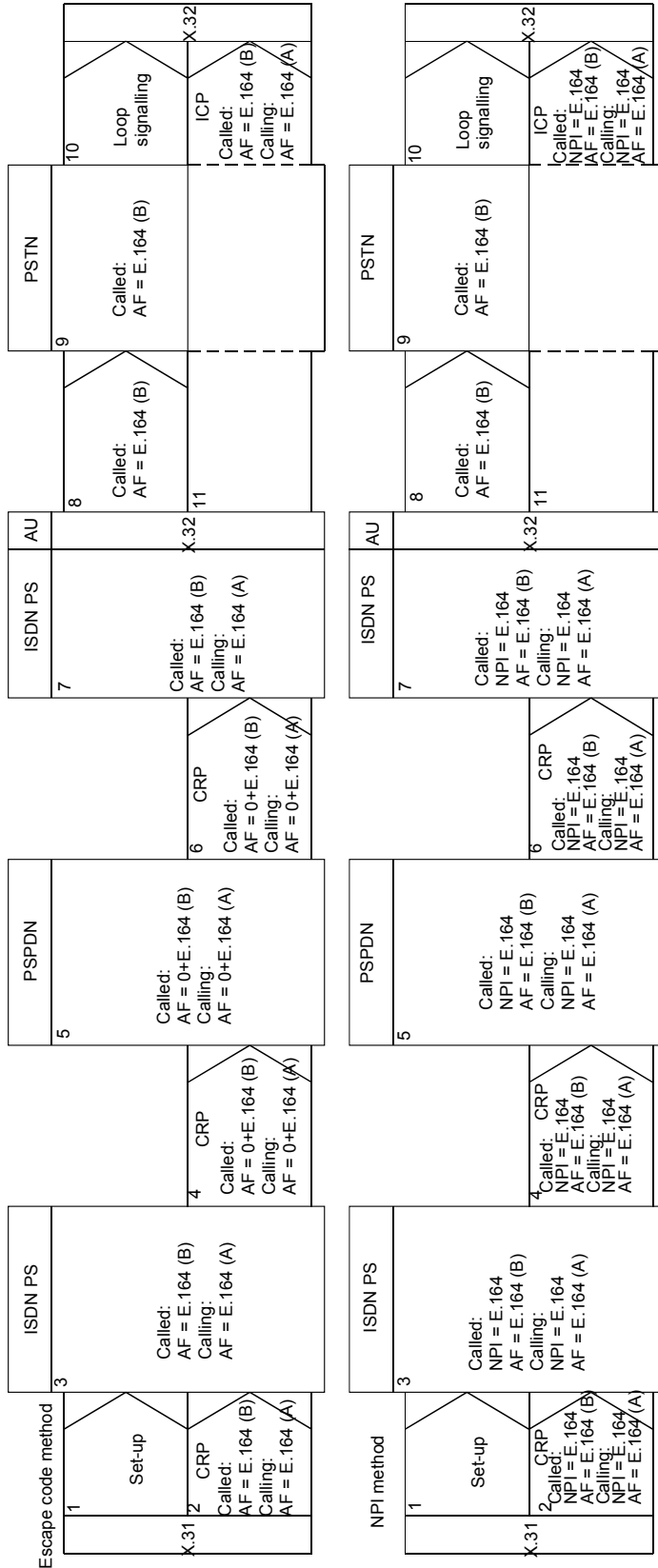
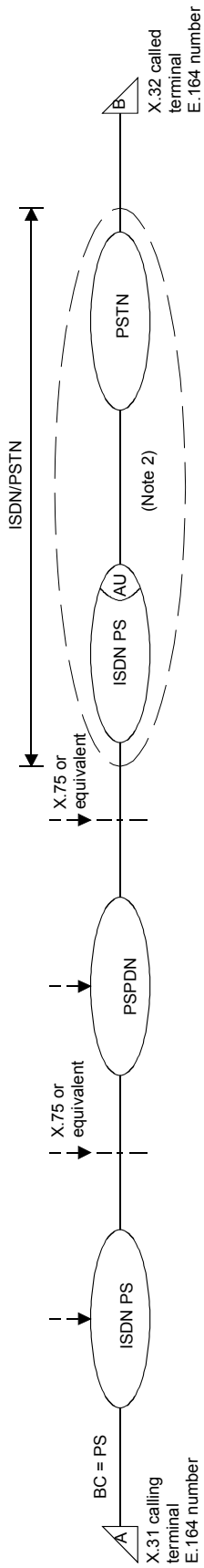

NOTES

- 1 This scenario is single stage dialling.
- 2 X.32-like access from an ISDN PS to a PSTN is not presently defined in ITU-T Recommendations. This is for urgent study by Study Groups 7 and 13.
- 3 Step 1 is not used when a circuit is already established.
- 4 Steps 8, 9 and 10 are not used when a circuit is already established.

FIGURE 23

Interworking from an ISDN using X.31 procedures (BC = PS) to an ISDN using X.32-like procedures in conjunction with a PSTN, with a PSPDN as a transit network



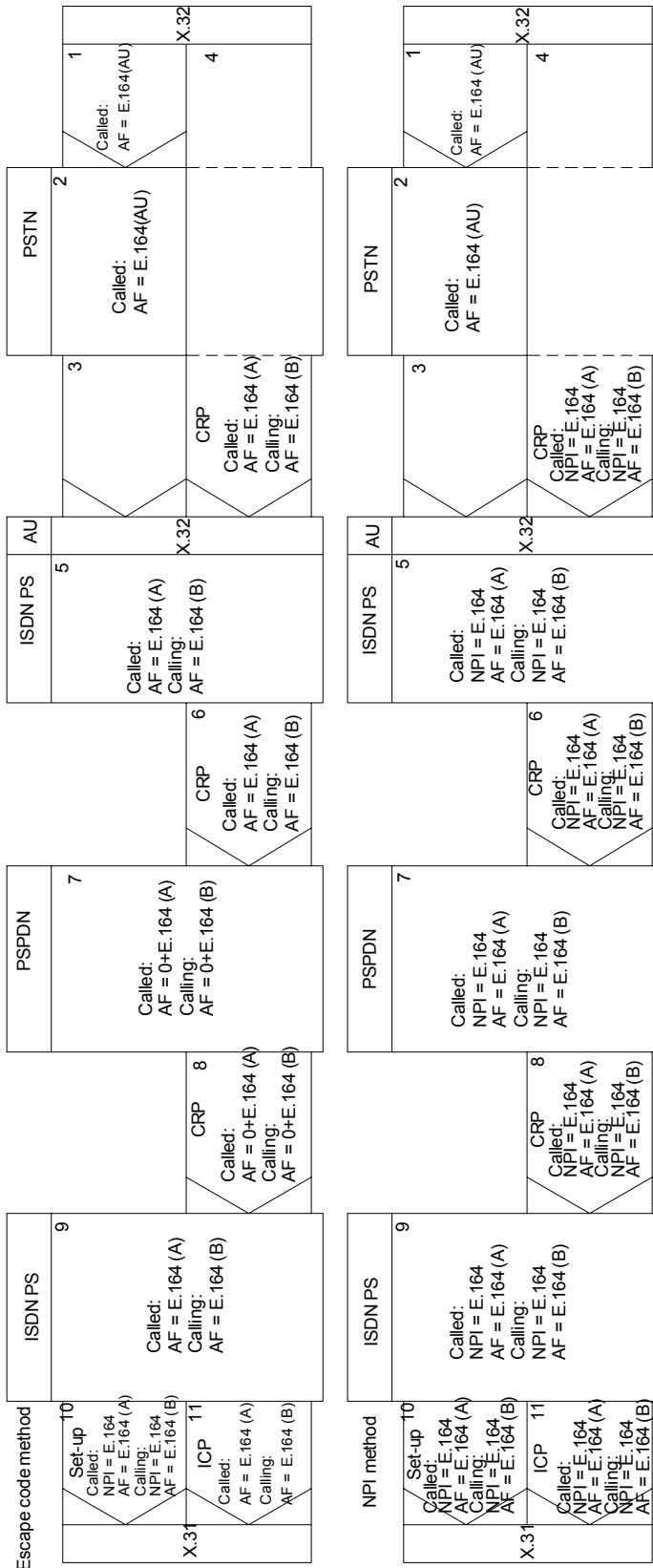
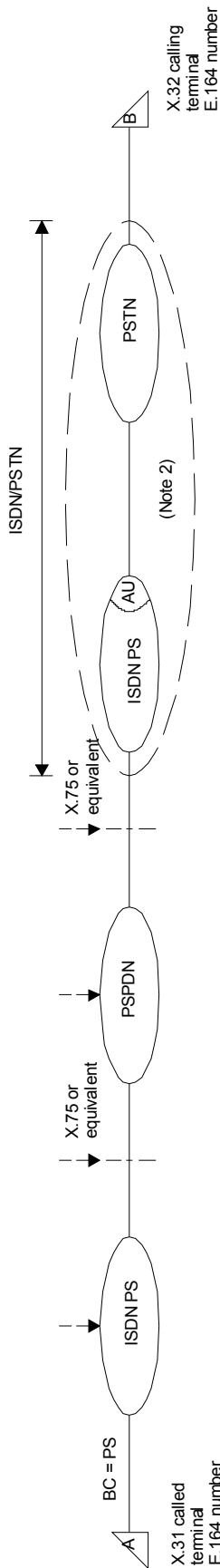

T070881.0-91

NOTES

- 1 This scenario is double stage dialling.
- 2 X.32-like access from a PSTN to an ISDN PS is not presently defined in ITU-T Recommendations. This is for urgent study by Study Groups 7 and 13.
- 3 Steps 1, 2 and 3 are not used when a circuit is already established.
- 4 Step 10 is not used when there is no call offering (see Recommendation X.31), when used the calling address might not be present.

FIGURE 24

**Interworking from a PSTN in conjunction with an ISDN using X.32-like procedures to an ISDN using X.31 procedures (BC = PS) with a PSPDN as a transit network**

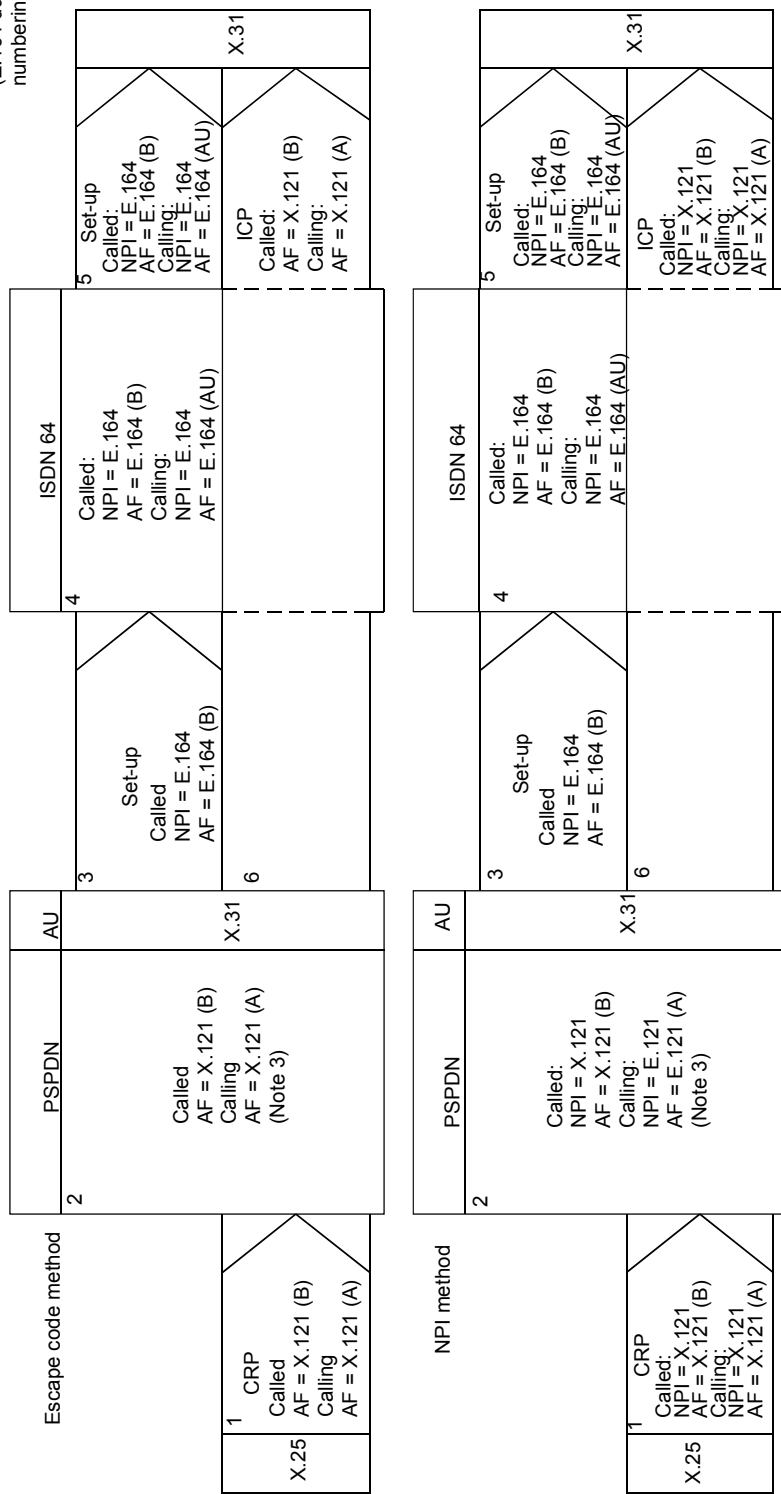
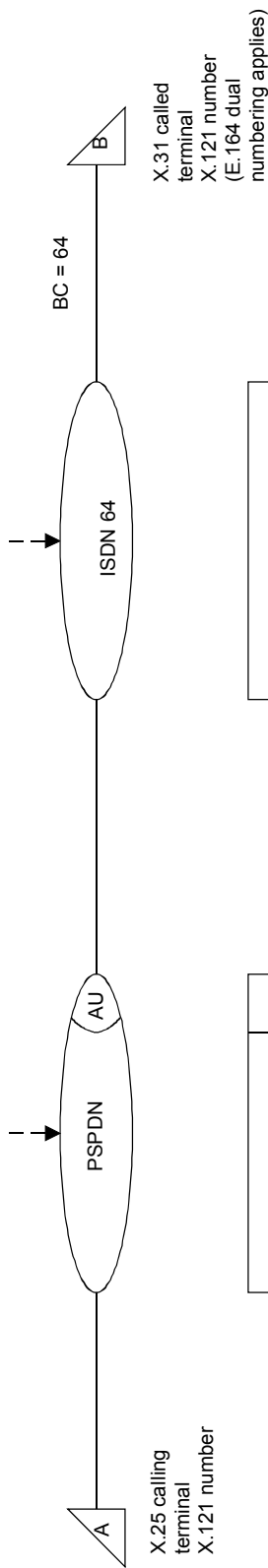

- NOTES
- 1 This scenario is single stage dialling.
  - 2 Steps 3, 4 and 5 are not used when a circuit is already established.
  - 3 The AU has to achieve translation to obtain E.164 (B) from X.121 (B).

FIGURE 25

Interworking from a PSPDN to an ISDN using X.31 procedures (BC = 64) (E.164 and X.121 address)

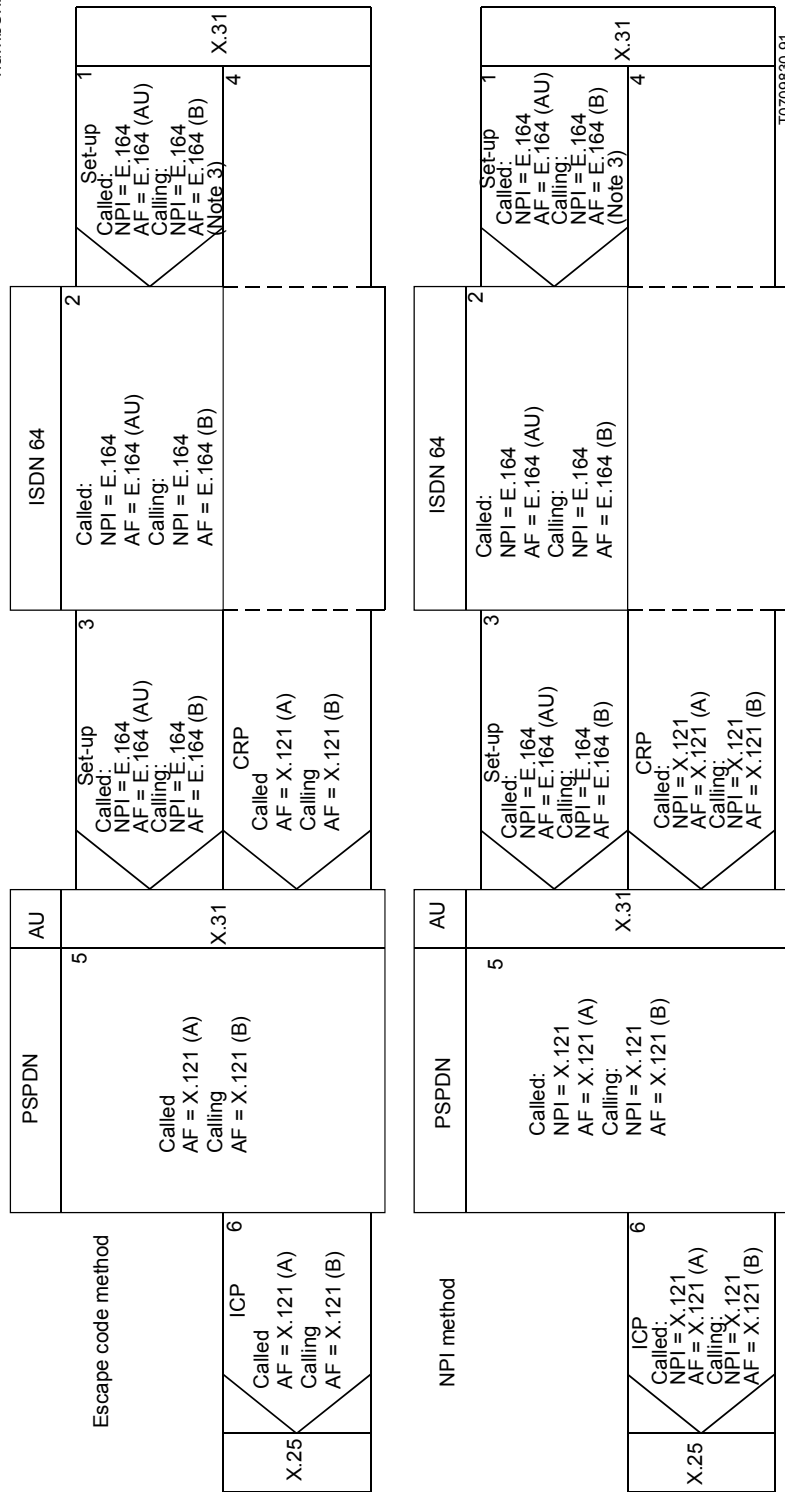
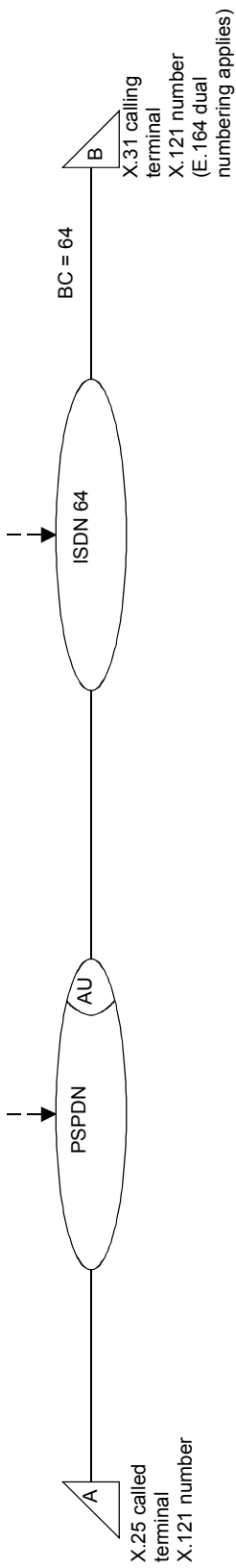

**NOTES**

- 1 This scenario is double stage dialling.
- 2 Steps 3, 4 and 5 are not used when a circuit is already established.
- 3 The calling party identity is optional (see Recommendation X.31).

**FIGURE 26**

**Interworking from an ISDN using X.31 procedures (BC = 64) (E.164 and X.121 address) to a PSPDN**

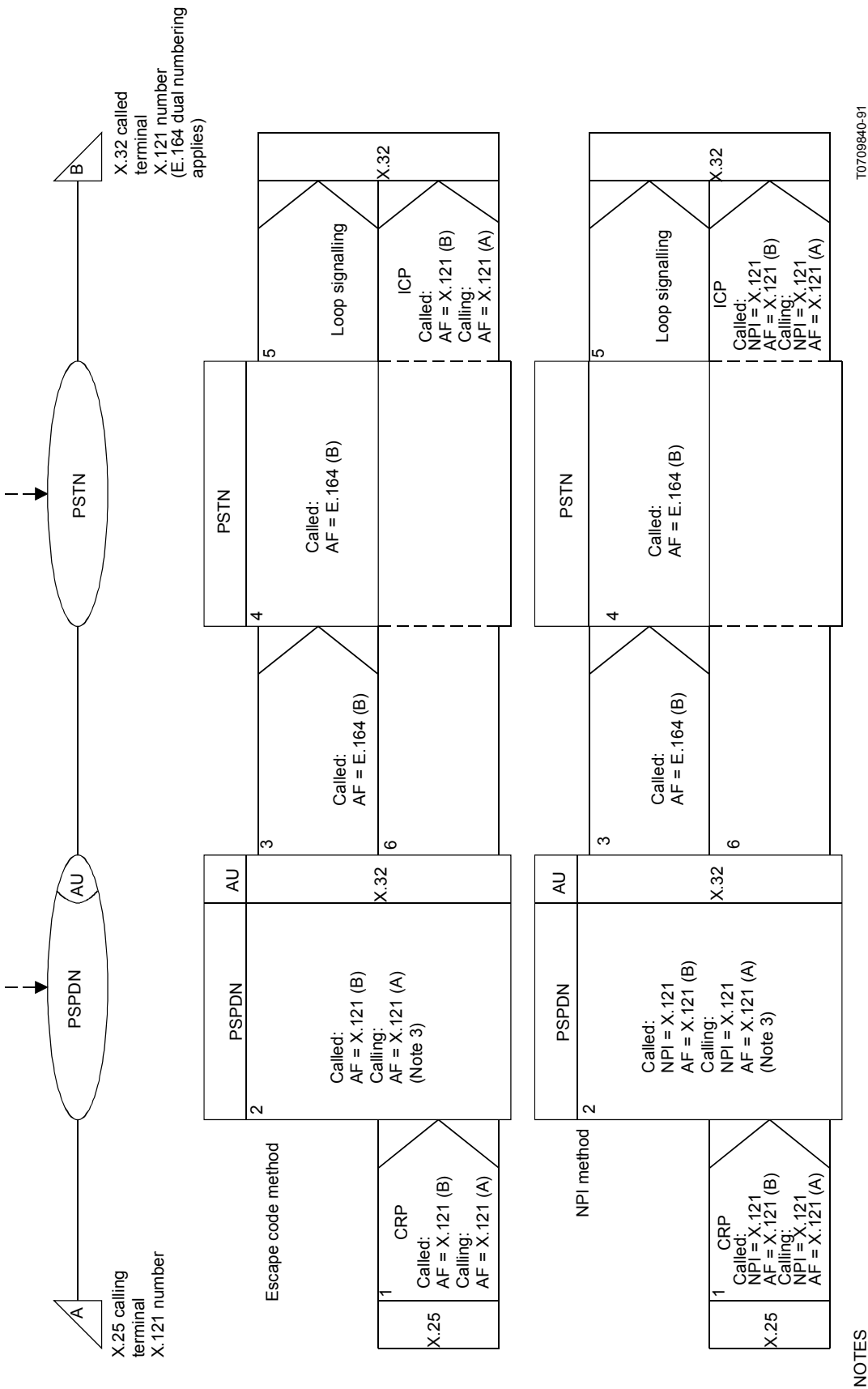

- NOTES
- 1 This scenario is single stage dialling.
  - 2 Steps 3, 4 and 5 are not used when a circuit is already established.
  - 3 The AU has to achieve translation to obtain E.164 (B) from X.121 (B).

FIGURE 27

Interworking from a PSPDN to a PSTN using X.32 procedures (E.164 and X.121 address)

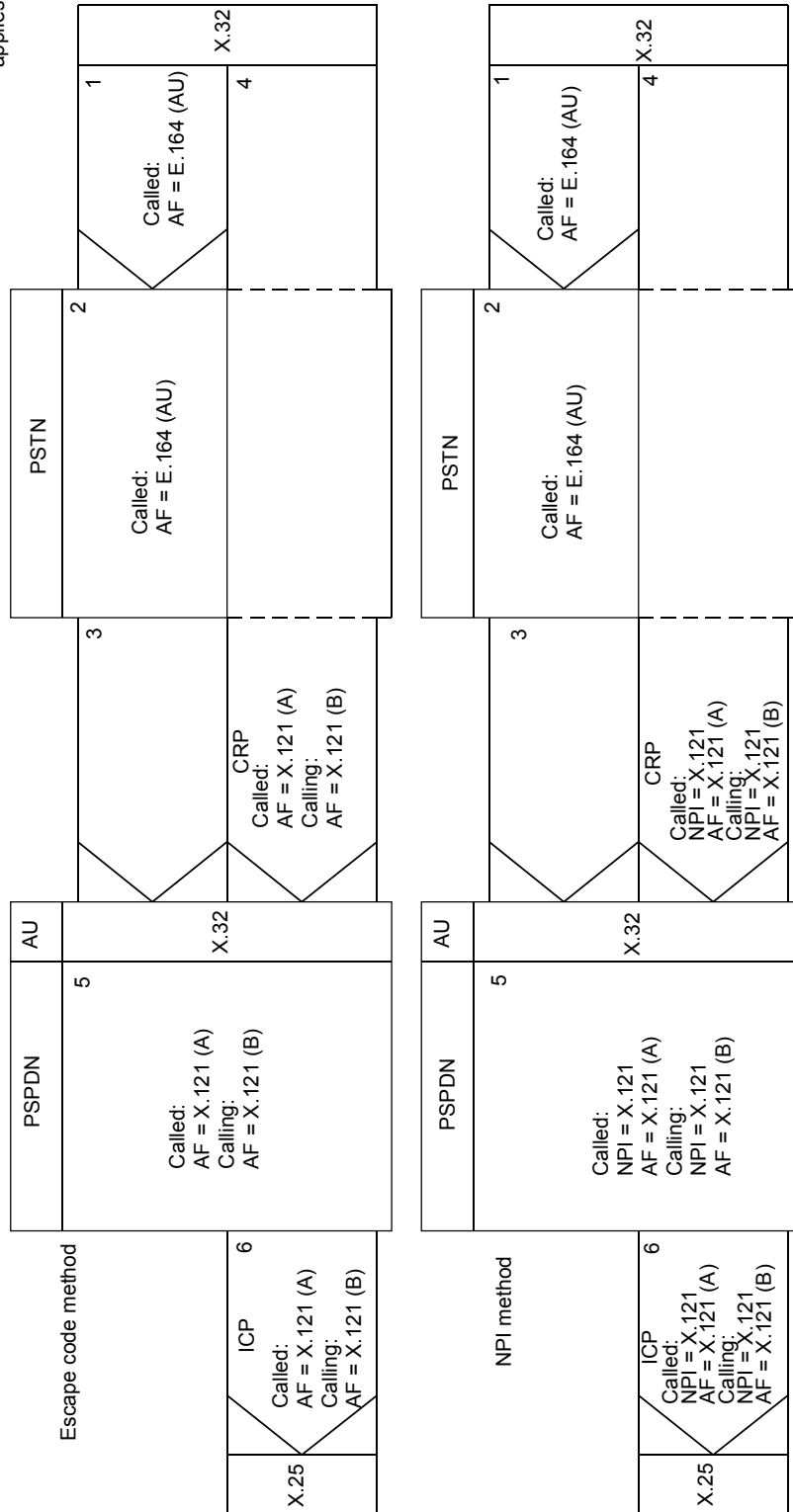
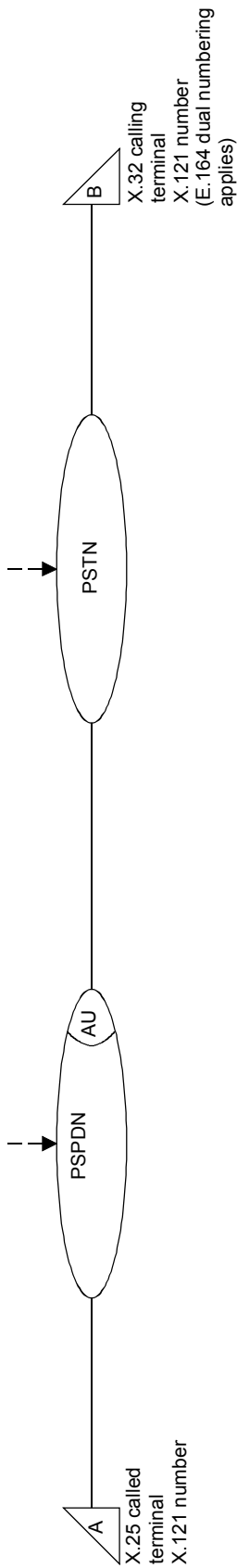

T0709850-91

**NOTES**

- 1 This scenario is double stage dialling.
- 2 Steps 1, 2 and 3 are not used when a circuit is already established.

**FIGURE 28**

**Interworking from a PSTN using X.32 procedures (E.164 and X.121 address) to a PSPDN**

## **8 Recommendation history**

- Recommendation E.166: First issue 1988.
- Recommendation X.122: First issue 1988.
- Recommendation I.332: First issue 1987.
- Recommendation I.332: Second issue 1988.
- Recommendation E.166/X.122: First issue 1992; combined version replacing Recommendations E.166, X.122 and I.332.
- Recommendation E.166/X.122: Second issue 1996.

ITU-T X-SERIES RECOMMENDATIONS  
**DATA NETWORKS AND OPEN SYSTEM COMMUNICATION**

PUBLIC DATA NETWORKS	X.1–X.199
Services and facilities	X.1–X.19
Interfaces	X.20–X.49
Transmission, signalling and switching	X.50–X.89
<b>Network aspects</b>	<b>X.90–X.149</b>
Maintenance	X.150–X.179
Administrative arrangements	X.180–X.199
OPEN SYSTEM INTERCONNECTION	X.200–X.299
Model and notation	X.200–X.209
Service definitions	X.210–X.219
Connection-mode protocol specifications	X.220–X.229
Connectionless-mode protocol specification	X.230–X.239
PICS proformas	X.240–X.259
Protocol Identification	X.260–X.269
Security Protocols	X.270–X.279
Layer Managed Objects	X.280–X.289
Conformance testing	X.290–X.299
INTERWORKING BETWEEN NETWORKS	X.300–X.399
General	X.300–X.349
Satellite data transmission systems	X.350–X.399
MESSAGE HANDLING SYSTEMS	X.400–X.499
DIRECTORY	X.500–X.599
OSI NETWORKING AND SYSTEM ASPECTS	X.600–X.699
Networking	X.600–X.629
Efficiency	X.630–X.649
Naming, Addressing and Registration	X.650–X.679
Abstract Syntax Notation One (ASN.1)	X.680–X.699
OSI MANAGEMENT	X.700–X.799
Systems Management framework and architecture	X.700–X.709
Management Communication Service and Protocol	X.710–X.719
Structure of Management Information	X.720–X.729
Management functions	X.730–X.799
SECURITY	X.800–X.849
OSI APPLICATIONS	X.850–X.899
Commitment, Concurrency and Recovery	X.850–X.859
Transaction processing	X.860–X.879
Remote operations	X.880–X.899
OPEN DISTRIBUTED PROCESSING	X.900–X.999

*For further details, please refer to ITU-T List of Recommendations.*

## ITU-T RECOMMENDATIONS SERIES

- Series A Organization of the work of the ITU-T
- Series B Means of expression
- Series C General telecommunication statistics
- Series D General tariff principles
- Series E Telephone network and ISDN**
- Series F Non-telephone telecommunication services
- Series G Transmission systems and media
- Series H Transmission of non-telephone signals
- Series I Integrated services digital network
- Series J Transmission of sound-programme and television signals
- Series K Protection against interference
- Series L Construction, installation and protection of cables and other elements of outside plant
- Series M Maintenance: international transmission systems, telephone circuits, telegraphy, facsimile and leased circuits
- Series N Maintenance: international sound-programme and television transmission circuits
- Series O Specifications of measuring equipment
- Series P Telephone transmission quality
- Series Q Switching and signalling
- Series R Telegraph transmission
- Series S Telegraph services terminal equipment
- Series T Terminal equipments and protocols for telematic services
- Series U Telegraph switching
- Series V Data communication over the telephone network
- Series X Data networks and open system communication**
- Series Z Programming languages



Printed in Switzerland

Geneva, 1997