

International Telecommunication Union

**ITU-R**  
Radiocommunication Sector of ITU

**Recommendation ITU-R SM.1875-2**  
**(08/2014)**

**DVB-T coverage measurements and  
verification of planning criteria**

**SM Series**  
**Spectrum management**



## Foreword

The role of the Radiocommunication Sector is to ensure the rational, equitable, efficient and economical use of the radio-frequency spectrum by all radiocommunication services, including satellite services, and carry out studies without limit of frequency range on the basis of which Recommendations are adopted.

The regulatory and policy functions of the Radiocommunication Sector are performed by World and Regional Radiocommunication Conferences and Radiocommunication Assemblies supported by Study Groups.

## Policy on Intellectual Property Right (IPR)

ITU-R policy on IPR is described in the Common Patent Policy for ITU-T/ITU-R/ISO/IEC referenced in Annex 1 of Resolution ITU-R 1. Forms to be used for the submission of patent statements and licensing declarations by patent holders are available from <http://www.itu.int/ITU-R/go/patents/en> where the Guidelines for Implementation of the Common Patent Policy for ITU-T/ITU-R/ISO/IEC and the ITU-R patent information database can also be found.

### Series of ITU-R Recommendations

(Also available online at <http://www.itu.int/publ/R-REC/en>)

Series	Title
<b>BO</b>	Satellite delivery
<b>BR</b>	Recording for production, archival and play-out; film for television
<b>BS</b>	Broadcasting service (sound)
<b>BT</b>	Broadcasting service (television)
<b>F</b>	Fixed service
<b>M</b>	Mobile, radiodetermination, amateur and related satellite services
<b>P</b>	Radiowave propagation
<b>RA</b>	Radio astronomy
<b>RS</b>	Remote sensing systems
<b>S</b>	Fixed-satellite service
<b>SA</b>	Space applications and meteorology
<b>SF</b>	Frequency sharing and coordination between fixed-satellite and fixed service systems
<b>SM</b>	<b>Spectrum management</b>
<b>SNG</b>	Satellite news gathering
<b>TF</b>	Time signals and frequency standards emissions
<b>V</b>	Vocabulary and related subjects

*Note: This ITU-R Recommendation was approved in English under the procedure detailed in Resolution ITU-R 1.*

Electronic Publication  
Geneva, 2014

© ITU 2014

All rights reserved. No part of this publication may be reproduced, by any means whatsoever, without written permission of ITU.

## RECOMMENDATION ITU-R SM.1875-2

**DVB-T coverage measurements and verification of planning criteria**

(2010-2013-2014)

**Scope**

This Recommendation describes methods for DVB-T coverage measurements and their evaluation.

**Keywords**

Coverage measurements, DVB-T, monitoring, planning

**Abbreviations/Glossary**

BER – Bit error ratio

$C/N$  – Carrier-to-noise ratio

$C/I$  – Carrier-to-interference ratio also referred to as protection ratio in this Recommendation

FEC – Forward error correction

DVB-T – Terrestrial Digital Video Broadcasting

GE06 Agreement – Regional Agreement and its annexes together with its associated Plans as drawn up by the Regional Radiocommunication Conference 2006 for the planning of the digital terrestrial broadcasting service in Region 1 (parts of Region 1 situated to the west of meridian 170° E and to the north of parallel 40° S, except the territories of Mongolia) and in the Islamic Republic of Iran, in the frequency bands 174-230 MHz and 470-862 MHz (Geneva, 2006)

MFN – Multi-frequency network

QEF – Quasi-error-free

QoS – Quality of service

RF – Radio frequency

SFN – Single frequency network

**Related ITU Recommendations**

Recommendations ITU-R BT.419, ITU-R P.1546 and ITU-R P.1812.

NOTE – In every case the latest edition of the Recommendation/Reports in force should be used.

The ITU Radiocommunication Assembly,

*considering*

a) that the GE06 Agreement defines the receiving conditions, necessary signal-to-noise ratios and minimum field strength values for the reception of DVB-T;

b) that monitoring services have to measure the coverage of DVB-T transmitters and networks to verify compliance with coverage predictions used in the planning process or to assess the receiving condition at a location where interference is reported,

*recommends*

that the method described in Annex 1 together with corrections described in Annex 2 should be used for DVB-T coverage measurements and verification of planning criteria.

## Annex 1

### 1 Introduction

Monitoring services have to measure the coverage of broadcast networks for different purposes:

- To verify predictions of computerized tools used for the planning of the network.
- To verify compliance with license conditions if part of the broadcast license is that a certain area, percentage of an area or percentage of the population is covered by the broadcast service.
- To assess the receiving conditions at certain locations where interference is reported.

Due to certain circumstances and principles inherent in the reception of digitally modulated systems, the coverage of digital terrestrial television networks has to be measured different from analogue networks.

This Recommendation describes the measurement principles, procedure and necessary equipment for fixed and mobile coverage measurements of DVB-T transmitters and networks. However, much of the information provided is also valid for measurements of other digital terrestrial broadcasting systems.

Measurements of the quality of service (QoS) and measurements to verify technical transmitter parameters are not covered in this Recommendation.

### 2 Terms and definitions for the purpose of this Recommendation

The following terms and definitions are used throughout this Recommendation. In case of generally known terms, their definitions are interpreted and specialized only to coverage issues related to the DVB-T system throughout this Recommendation.

#### 2.1 Antenna diagram for fixed reception

The antenna diagram characterizes the relative output level of an antenna when the signal is received under different angles. Recommendation ITU-R BT.419 defines the directivity of a standard antenna used for fixed broadcast reception as in Fig. 1. To reproduce the actual receiving conditions of a customer installation, measurements for fixed coverage should be made with a measurement antenna having the same directivity.

FIGURE 1

Relative antenna directivity for fixed broadcast reception

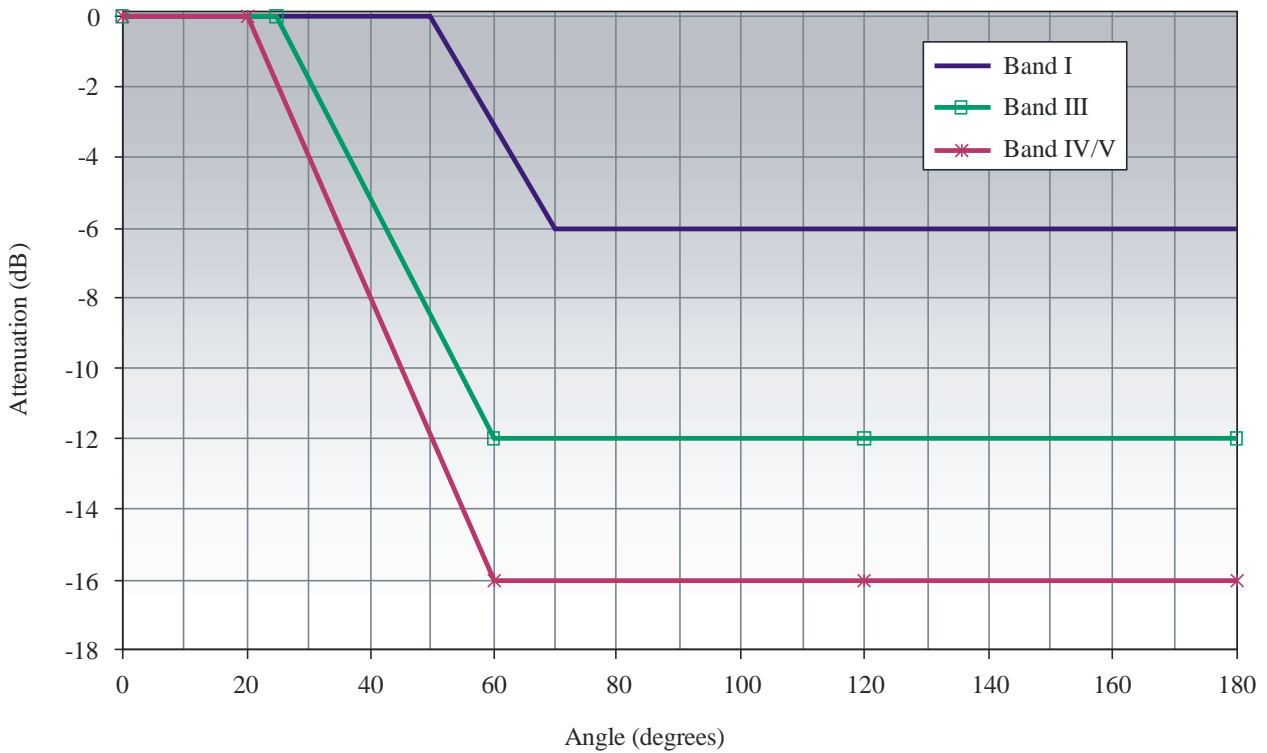

SM.1875-01

Mobile coverage measurements should be made with omnidirectional measurement antennas. The maximum relative loss in any direction is  $\pm 3$  dB.

## 2.2 Antenna factor

The antenna factor is used to calculate the field strength from the antenna output level. Because it is usually specified in dB, the calculation formula is as follows:

$$E = U + K \quad \text{dB}(\mu\text{V/m})$$

where:

$E$ : electrical field strength at the antenna (dB( $\mu\text{V/m}$ ))

$U$ : measured antenna output voltage (dB( $\mu\text{V}$ ))

$K$ : antenna factor (dB(1/m)).

The antenna factor depends on frequency and gain according to the following formula:

$$K = 20 \text{ Log}(f) - G_i - 29.774 \text{ (for } 50 \text{ Ohm systems)}$$

where:

$f$ : frequency (MHz)

$G_i$ : antenna gain relative to an isotropic radiator (dB)

$K$ : antenna factor (dB(1/m)).

Figure 2 shows the antenna factor of the standard antenna used for fixed broadcast reception according to Recommendation ITU-R BT.419 in the direction of the main beam which is the same as the antenna used for measurements of fixed reception.

FIGURE 2

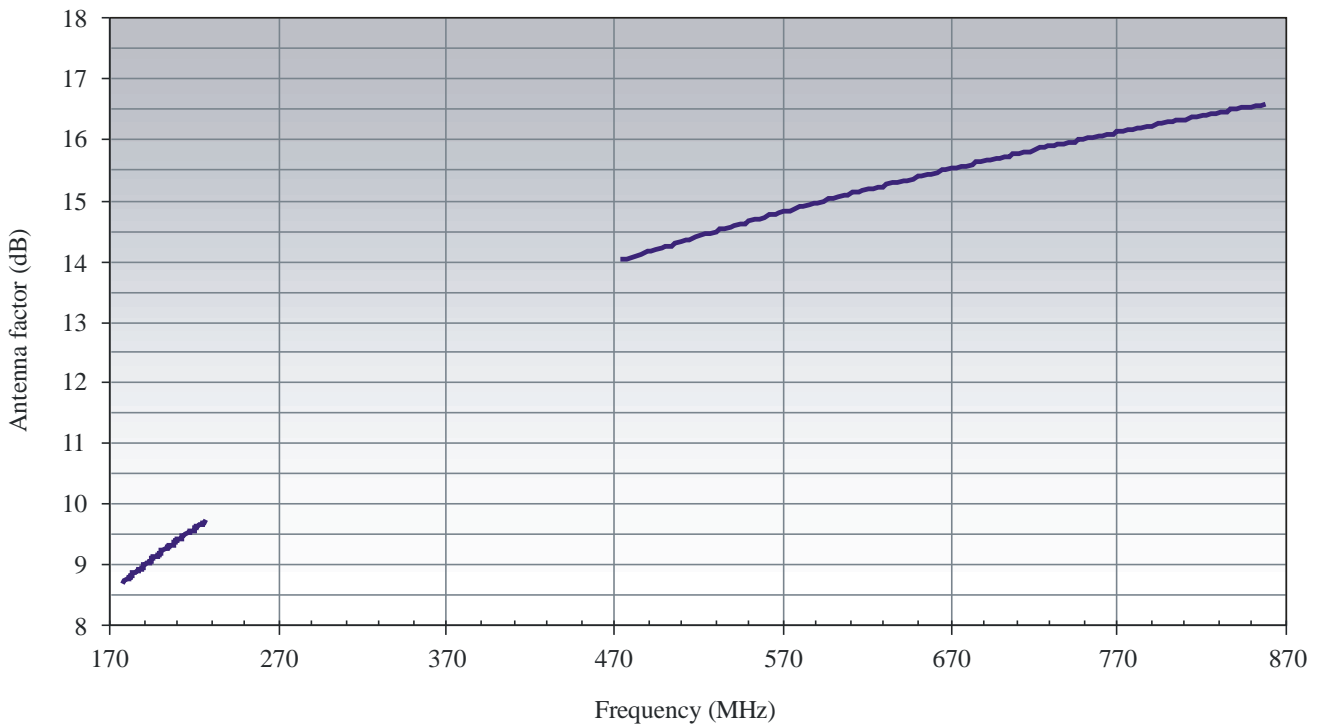
**Antenna factor for fixed broadcast reception**

SM.1875-02

**2.3 Assignment area**

An assignment area is a coverage area, realized by one or more transmitters where all parameters relevant for the planning process such as transmitter power, antenna height and directivity, are known. The assignment area is limited by interference from sources outside this area.

**2.4 Bit error ratio**

Generally, the bit error ratio (BER) is the number of false bits divided by the total number of bits transmitted during a given time. It is a measure of the receiving quality of a digital signal. Because DVB-T uses inner and outer error protection, it is possible to determine the BER after the Viterbi and after the Reed-Solomon decoder off the air.

A BER of  $10^{-4}$  after the Viterbi decoder is regarded sufficient for DVB-T reception.

**2.5 C/N**

See protection ratio.

**2.6 The term “covered”**

A certain area is regarded as being “covered” by DVB-T, when the median field strength for the particular receiving situation in a specified height above ground (often 10 m) and the protection ratio reach or exceed the values given in the relevant planning documents (e.g. the GE06 Agreement).

The fact of a certain area to be covered or not is a result of the calculation process done with a coverage prediction tool that assumes defined conditions and/or values for:

- the receiving condition (e.g. fixed or portable reception);

- the field strength loss with distance due to topography and morphology;
- the receiver model (e.g. sensitivity and selectivity);
- the receiving antenna (height, gain and directivity);
- the reception channel (Gaussian, Rice or Rayleigh).

Attached to the attribute “covered” is also a certain probability in time and location. Using planning tools, the coverage area is calculated for this probability (e.g. 50% of the time and 50% of the locations).

It can therefore not be assumed that DVB-T reception with a standard receiver is possible at every single location inside the area defined as being covered.

Verification of coverage cannot be done with a standard DVB-T receiver by simply checking whether it works at a certain location. Instead, the technical parameters such as field strength have to be measured, preferably under the same receiving conditions as assumed in the planning tool.

## **2.7 The term “reception possible”**

The DVB-T reception is regarded possible if at a certain location a standard receiver can correct (nearly) all errors in 99% of the time and produce a picture. The BER after the Viterbi decoder should be below  $2 \cdot 10^{-4}$ .

The actual necessary field strength for a successful DVB-T reception depends on:

- the DVB-T system variant;
- the receiver performance;
- the antenna gain;
- the type of reception channel (Gaussian, Rice or Rayleigh).

Verification of a general reception possibility can be done by measurement of the following parameters:

- median receiving field strength;
- median interfering field strength;
- type of reception channel.

Alternatively, a reception test with a standard DVB-T receiver can be done. Experience from these tests shows that, for portable reception, sometimes higher field strengths than median values given in the relevant agreements are necessary.

## **2.8 Coverage prediction**

Coverage prediction is a procedure to calculate the geographical area inside which reception of the service is possible. It is based on transmitter parameters, terrain and propagation models and is done with computerized tools. The result represents a defined location and time probability.

In the GE06 Agreement, the minimum field strength values for DVB-T to be reached at the coverage border are valid in 10 m height above ground and assume fixed reception with a directional antenna according to Figs 1 and 2. They are medians of the minimum equivalent field strength values and depend on the system variant and the reception channel.

## **2.9 Crest factor**

The crest factor is the ratio between the peak and r.m.s. level value of an RF emission. Usually, it is given in dB and is then the difference between peak and r.m.s. levels (dB).

## 2.10 Guard interval

To make use of all incoming signal components from co-channel transmissions and reflections that arrive at different times at the receiver, and to prevent interference of two subsequent symbols, each symbol is transmitted longer as would be necessary to decode the signal. The additional time is called guard interval. The actual decoding process inside the receiver can start after the guard interval has passed. The length of the guard interval depends on the system variant and the maximum distance between neighbouring transmitters in a single frequency network (SFN).

## 2.11 Height loss

This is the field strength difference in 10 m above ground (reference for DVB-T planning) and the receiving field strength at an antenna being closer to the ground (e.g. 1.5 m for portable reception). Its value is statistical.

## 2.12 Interfering field strength

The interfering field strength is produced by signals from transmitters on the same frequency that are not part of the investigated SFN or transmitter, by signals from neighbour channel transmitters and by signals from transmitters of the investigated SFN that are received outside the guard interval. It is formed by the vector addition of the directly received signal component from the interferer and reflections due to obstructions in the field. It varies with the location of the receiver, and because the reflecting obstacles may not be stationary, it also varies with time. The actual interfering field strength inside a certain area can therefore only be described statistically by a median value and a standard deviation.

Practical measurement of the interfering field strength can be difficult, especially if its level is well below the wanted signal level and both interferer and wanted transmitter are received from the same direction. Possible ways of improving the measurement conditions for the interfering field strength are:

- Use of a measurement antenna with a high directivity to separate wanted and interfering signals by changing the azimuth.
- Measurement of a signal on a different frequency that is emitted from the same location as the interfering transmitter. In this case, corrections for different attenuation loss from the frequency difference and for different transmitter power on the measurement frequency may have to be applied.
- Switch off the wanted transmitter or SFN during the measurement.

When the interfering signal is more than 30 dB below the wanted field strength, its influence on the reception of the wanted transmitter or SFN can be neglected.

## 2.13 Median

The median is calculated from a total of many samples (e.g. a series of measured field strengths) so that 50% of all samples exceed the median value, the other 50% of the samples are lower. The median is a statistical value and specifies a 50% confidence or probability.

*Example:* The field strength is measured at 100 locations inside a certain area. The median of all measurement values is 42 dB( $\mu$ V/m). This means that the probability of the actual field strength at **any** location in this area being at least 42 dB( $\mu$ V/m) is 50%.

The advantage of using the median when specifying field strength statistically is that single values far off do not influence the result as much as the average or mean.



### 2.14 Minimum median field strength ( $E_{med}$ )

This is the median field strength based on calculations at a certain percentage of the locations inside a receiving area. In relevant planning texts such as the GE06 Agreement, its values for DVB-T reception are given in 10 m height above ground and for 50% location probability. They are given for each system variant.

Without correction, these values only represent the fixed reception scenario. For portable reception, correction factors have to be applied for the different antenna height, antenna gain, required level of location and time probability, and building penetration loss (where applicable).

Network planning ensures that the minimum wanted field strength is at least theoretically reached for the whole coverage area, depending on radiated transmitter power, transmitter antenna height and topography of the terrain.

### 2.15 MFN

MFN is the abbreviation for multi-frequency network. This is a network where inside the coverage area, each transmitter works on a different frequency.

### 2.16 Minimum equivalent signal level

The minimum level at the receiver input necessary to decode the wanted signal is the minimum system-dependant signal-to-noise ratio ( $S/N$ ) plus the receiver noise figure. The minimum  $S/N$  enables the receiver to decode the signal quasi-error-free (QEF). It depends on the system variant and the reception channel. The receiver noise figure assumes a certain receiver performance and is defined to be 7 dB for a standard DVB-T receiver.

### 2.17 Minimum wanted (equivalent) field strength ( $E_{min}$ )

This is the minimum field strength of a single wanted signal necessary for a standard receiver to decode the signal QEF, in the absence of any interfering signals. It is the minimum equivalent signal level at the input of the receiver plus antenna factor and is valid for a certain receiving location, i.e. without corrections for location and time probability.

### 2.18 Network gain

If signals from multiple wanted transmitters inside an SFN can be received within the guard interval, the reception quality can be improved and the minimum wanted field strength from each transmitter can be lower. The network gain, however, is not the sum of the wanted field strengths from all receivable transmitters. It is merely the increased probability to receive a better signal from an additional direction than from a single transmitter alone.

The network gain is the difference of the receiving field strengths inside SFNs and MFNs necessary for the same location probability.

In an SFN, the increased number of transmitters leads to a more homogeneous distribution of the field strength in the coverage area. The standard deviation  $\sigma$  of the field strength values is lower.

*Example:* The minimum median field strength for a certain system variant according to international agreements  $E_{med}$  is 61.3 dB( $\mu$ V/m). This, per definition, applies to 50% location probability. In an SFN, the minimum wanted field strength  $E_{min}$  for 95% location probability is 66.7 dB( $\mu$ V/m), for an MFN it is 70.3 dB( $\mu$ V/m). The network gain is then 3.6 dB.

FIGURE 3  
Network gain

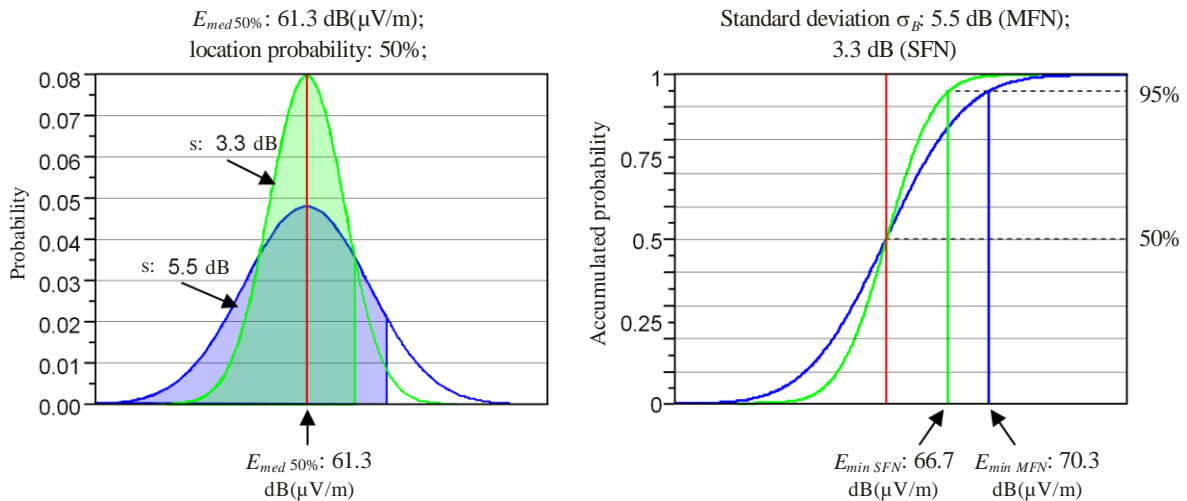

SM.1875-03

### 2.19 Protection ratio

The protection ratio ( $C/I$ ) is the difference between the wanted signal level and the total of all unwanted signal levels, given in dB. For DVB-T, the required protection ratios are given in the GE06 Agreement. They depend on the system variant.

In the absence of interfering signals, the only “interferer” is the noise and  $C/I$  becomes the same as the carrier-to-noise ratio ( $C/N$ ).

### 2.20 Quasi error-free reception

As in many digital systems involving FEC, quasi error-free reception is defined at the point where only one uncorrected error per hour occurs. For DVB-T systems, the corresponding BER are:

- $1 * 10^{-11}$  after the Reed-Solomon decoder;
- $2 * 10^{-4}$  after the Viterbi decoder.

These values are commonly used in international agreements such as the GE06 Agreement.

### 2.21 Receiving field strength

The receiving field strength is formed by the vector addition of the directly received signal component and reflections due to obstructions in the field. It varies with the location of the receiver, and because the reflecting obstacles may not be stationary, it also varies with time. The actual receiving field strength inside a certain area can therefore only be described statistically by a median value and a standard deviation.

### 2.22 Receiving scenario

The following receiving scenarios have been defined for DVB-T in the GE06 Agreement:

- Fixed reception (FX)
- Portable reception outdoor (PO or “portable class A”)
- Portable reception indoor (PI or “portable class B”)
- Mobile reception (MO).

Table 1 lists some of the main characteristics and parameters used for these receiving scenarios.

TABLE 1  
DVB-T receiving scenarios and parameters

	FX	PO	PI	MO
Receiver location	Outside buildings	Outside buildings	Inside buildings	Car roofs, moving
Antenna, gain	Directional, 7 ... 12 dBi	Omnidirectional, −2.2 ... 0 dBi	Omnidirectional, −2.2 ... 0 dBi	Omnidirectional, −2.2 ... 0 dBi
Antenna height	10 m above ground	Minimum 1.5 m above ground	1.5 m above ground floor level	1.5 m above ground
Polarization	Horizontal/vertical	No polarization decoupling	No polarization decoupling	No polarization decoupling
Cable loss	2 ... 5 dB	0 dB	0 dB	0 dB
Building penetration loss	0 dB	0 dB	VHF: 9 dB UHF: 8 dB Standard deviation: VHF 3 dB UHF 5.5 dB	0 dB

### 2.23 Reception channel

Due to reflections, shading and reception of signals from multiple transmitters of an SFN, the received spectrum can be degraded. The order of this degradation determines the reception channel which is specified in Table 2.

The standard deviation of the spectral amplitudes  $\sigma_{sp}$  has an influence on the minimum receiver input level necessary to decode the DVB-T signal.

TABLE 2  
DVB-T reception channels

<p><b>Gauss channel:</b> Only the direct signal from a transmitter within line-of-sight is received. No reflections and co-channel emissions are received. As a result, the OFDM spectrum is rectangular. The standard deviation of the spectral amplitudes over the channel bandwidth <math>\sigma_{sp}</math> is between 0 and 1 dB.</p>	
<p><b>Rice channel:</b> In addition to the direct signal, several smaller co-channel signals and reflections are received. The OFDM spectrum shows slight variations in amplitude over frequency. The standard deviation of the spectral amplitudes over the channel bandwidth <math>\sigma_{sp}</math> is between 1 and 3 dB.</p>	

TABLE 2 (end)

<p><b>Rayleigh channel:</b></p> <p>The received signal is composed only of reflections and components from various co-channel transmitters. No dominant direct signal is received. The OFDM spectrum shows heavy distortion. The standard deviation of the spectral amplitudes over the channel bandwidth <math>\sigma_{sp}</math> is higher than 3 dB.</p>	
---	--

It is important to determine the type of reception channel when measuring DVB-T field strength because the minimum required field strength according to planning standards depends on the reception channel. Rayleigh channels require the highest field strength, Gauss channels the lowest.

Experience shows that the vast majority of practical receiving situations will show Rice and Rayleigh channels. Gauss channels are very rare.

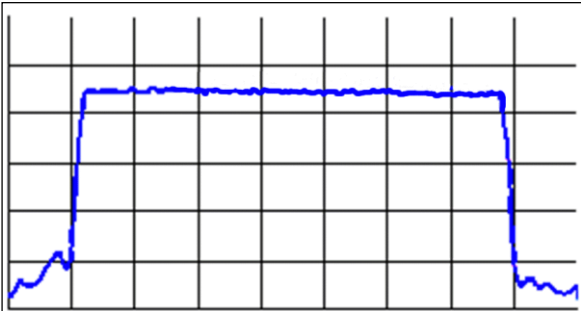
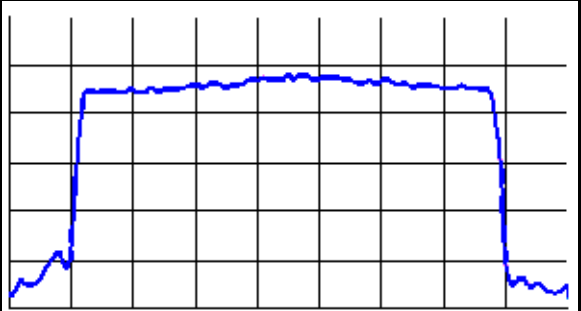
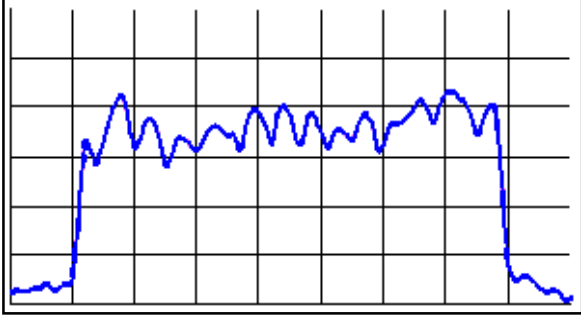
## 2.24 The GE06 Agreement

The Regional Agreement and its annexes together with its associated *Plans* as drawn up by the Regional Radiocommunication Conference 2006 for the planning of the digital terrestrial broadcasting service in Region 1 (parts of Region 1 situated to the west of meridian 170° E and to the north of parallel 40° S, except the territories of Mongolia) and in the Islamic Republic of Iran, in the frequency bands 174-230 MHz and 470-862 MHz (Geneva, 2006) (the GE06 Agreement).

## 2.25 Self-interference inside an SFN

In this context, self-interference inside SFNs is the distortion of the received signal due to the mixing of the directly received signal component and:

- reflections of the signal from the same transmitter;
- signals from other transmitters running on the same frequency and belonging to the same SFN,

that are received **outside** the guard interval.

## 2.26 Single-frequency network

An SFN consists of two or more transmitters that are time-synchronized and transmit the same programme content. The network planning has to ensure that at all receiving locations inside the coverage area of the SFN, the signals of all receivable transmitters participating in the SFN arrive at the receiver within the guard interval. This is done by selection of the system variant and maximum distance between any two neighbouring transmitters inside the SFN.

## 2.27 Standard deviation

The standard deviation is an indicator of the variance in a series of samples. It is the average deviation of all samples from the arithmetical average and can be calculated as follows:

Arithmetical average: 
$$\mu = \frac{P_1 + P_2 + P_3 + \dots + P_n}{n}$$

Standard deviation: 
$$\sigma = \sqrt{\frac{(P_1 - \mu)^2 + (P_2 - \mu)^2 + \dots + (P_n - \mu)^2}{n - 1}}$$

where:

$P_1 \dots P_n$ : sample values.

### 2.28 Standard deviation of the spectral amplitudes ( $\sigma_{sp}$ )

It was established experimentally that the standard deviation levels of the spectral amplitudes (see § 2.27), measured in logarithmic units (dB( $\mu$ V) or dBm), correspond to  $\sigma_{sp}$  values, given in § 2.23 Reception channel.

### 2.29 $\sigma_{sp}$ -correction ( $C_\sigma$ )

The necessary  $C/N$  given in relevant international documents such as the GE06 Agreement depends on the reception channel: Rayleigh channels require a high  $C/N$ , Rice channels a medium and Gauss channels the lowest  $C/N$ . A typical value specifying the reception channel is the standard deviation of the spectral amplitudes over the whole DVB-T bandwidth ( $\sigma_{sp}$ ). With regard to the international texts, it is assumed here that  $\sigma_{sp}$  has the following values:

TABLE 3

Standard deviation of the spectral amplitudes ( $\sigma_{sp}$ )

Reception channel	$\sigma_{sp}$
Gauss	$\sigma_{sp} \leq 1$ dB
Rice	$1$ dB $< \sigma_{sp} < 3$ dB
Rayleigh	$\sigma_{sp} \geq 3$ dB

However, the true value of  $\sigma_{sp}$  at real measurement points will most often be different from these extremes. They usually lie between 1 and 5 dB. To compare the measured field strength with the international texts, it is necessary to determine the reception channel and  $\sigma_{sp}$  for each measurement. A correction value  $C$  is subtracted from each measured value according to the following formula:

$$C_\sigma = \frac{C/N_{Rayleigh} - C/N_{Gauss}}{2} \cdot (\sigma_{sp} - 3)$$

where  $C/N_{Rayleigh}$  and  $C/N_{Gauss}$  are taken from the relevant international texts, such as the GE06 Agreement, for the system variant used. This process is called  $\sigma_{sp}$ -correction.

The formula establishes a linear interpolation between and beyond the  $\sigma_{sp}$  values at the borders between Gauss/Rice (1 dB) and Rice/Rayleigh channels (3 dB). Depending on the reception channel, the value for  $C_\sigma$  can also be negative.

The graphs in Annex 2 show some examples for  $\sigma_{sp}$ -correction values.

### 2.30 Substitution transmitter

This is a transmitter that is operating at the same location as the transmitter that has to be measured, but on a different frequency. The substitution transmitter can be used for the measurement if the original transmitter has not been set up yet or if its signal is too heavily interfered by other, unwanted signals. If no substitution transmitter exists, it is possible to use a test transmitter that is set-up only for the measurements.

### 2.31 System variant

Several parameters of the DVB-T system can be adjusted according to the needs of the network planning. The selected set of parameters determines the system variant. The main variable parameters are:

- RF bandwidth (e.g. 7 or 8 MHz)
- Number of subcarriers (2k or 8k)
- Subcarrier modulation (e.g. QPSK, 16-QAM, 64-QAM)
- Code rate (e.g. 1/2, 2/3, 3/4)
- Guard interval (e.g. 1/4, 1/8).

### 2.32 Wanted field strength

This is the total received field strength of a wanted transmitter or network at any receiving location. When comparing measured field strength values of an SFN with necessary field strength values, the wanted field strength can be increased by the network gain.

## 3 Measurement methods

### 3.1 Verifying the coverage prediction for fixed reception

#### 3.1.1 Selection of measurement locations

To exactly verify the true coverage area, measurements at virtually all locations inside the area would have to be made. To keep the amount of measurements at a practical level, measurements are limited to a certain number of locations only. To find the measurement locations, a grid of 500 m length is placed over cities or villages that are close to the border of the predicted coverage area.

FIGURE 4  
Measurement points (fixed reception)

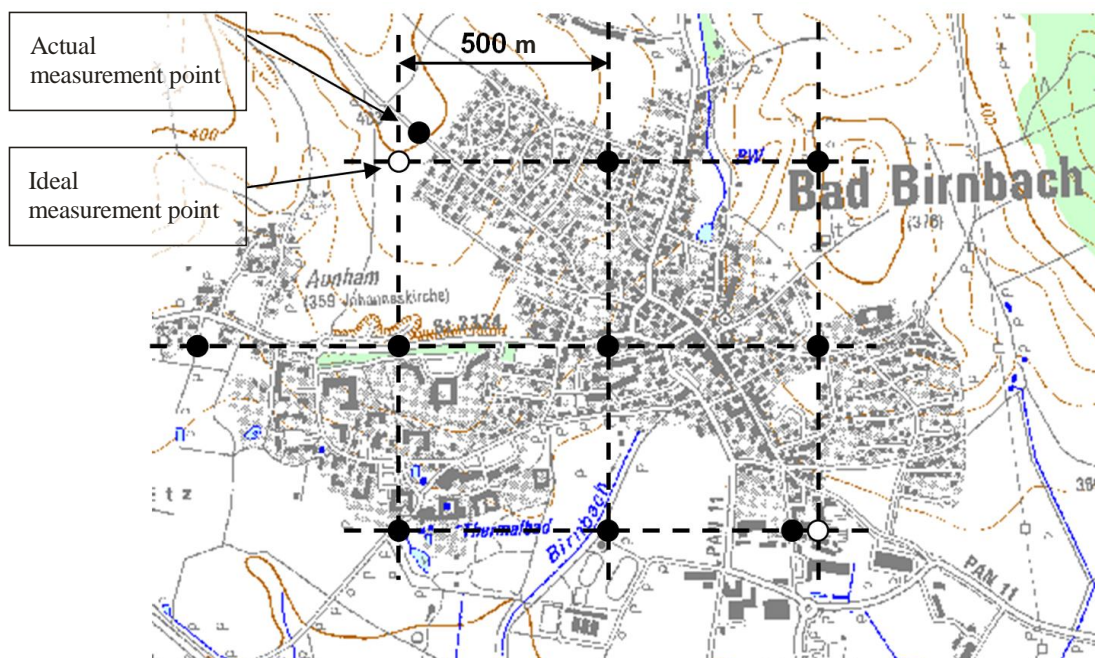

Sometimes the ideal measurement point will not be accessible due to buildings, non-existing roads and other problems. In this case, the nearest accessible measurement point has to be chosen, preferably within a distance of 50 m around the ideal measurement point. If possible, actual measurement points should not be obstructed by buildings that are higher than 10 m. If this is not realizable (especially in big cities) and more than 30 other locations have been measured for the area, the measurement point can be discarded. Otherwise, the best compromise between distance to ideal measurement point and obstruction-free reception has to be chosen. The result may be that the measurement point is not covered but this situation reflects the reality that would also be experienced by the user.

### 3.1.2 Necessary measurement equipment

For the evaluation of planning parameters for fixed DVB-T reception, the following equipment is needed:

TABLE 4

**Necessary equipment for verification of fixed DVB-T reception**

	<b>Equipment type</b>	<b>Required functions, remarks</b>
General setup	Measurement vehicle	Rotatable antenna mast that can be lifted up to 10 m height above ground positioning system (e.g. GPS)
Receiver	Spectrum analyser	Data interface to computers (e.g. LAN, IEEE488.2) Channel power measurement capability Sample detector Preferred function: r.m.s. detector
Antenna	LogPer or Yagi	Mounted on the mast of the measurement vehicle Horizontal and vertical polarization must be possible Antenna factor must be known (calibrated)
Measurement control	Computer program	Store trace data from spectrum analyser Store channel power measurement results Store data from positioning system Preferred function: Automatically adjust the analyser and perform the measurements

### 3.1.3 Measurement procedure

#### 3.1.3.1 Wanted signals

At all of the measurement points, the field strength of all wanted transmitters of the SFN that contribute to the coverage is measured. This is done with a directional measurement antenna in 10 m height above ground that is turned to the true direction of the wanted transmitter (in SFNs for each wanted transmitter separately). The polarization of the measurement antenna has to be the same as used at the transmitter. In SFNs with mixed polarization, the wanted field strength for both horizontal and vertical positions has to be measured separately. The higher result is used.

Then the maximum of the wanted field strength is measured by turning the directional antenna around 360°. The true direction to the wanted transmitter providing the highest wanted field strength and the measured direction of the wanted field strength maximum have to be noted.

#### 3.1.3.2 Unwanted signals

If considerable interference from unwanted co-channel or adjacent channel transmitters is present, the interfering field strength is also measured using the same procedure as described above. If no

separation between wanted and unwanted transmitter signals can be achieved or the signal from the wanted transmitter is too strong, it may have to be switched off during the measurement or a substitution transmitter has to be used.

If considerable interfering signals are received from more than one transmitter, the interfering level for each maximum has to be measured separately using the directivity of the measurement antenna. The evaluation of the result has to be done for each combination of wanted and unwanted signal separately. Only if all combinations pass the evaluation procedure, the point is covered.

If a DVB-T measurement receiver is available, the readout of the cell-ID can help identify the received transmitter, provided it is not a transmitter of the same SFN.

The measurement itself is preferably done with a spectrum analyser using the following settings:

- Measurement mode: channel power
- Channel bandwidth: 7 MHz or 8 MHz
- RBW: 30 kHz or auto (not higher than 100 kHz)
- Detector: r.m.s. or sample
- Trace mode: ClearWrite
- Sweep time: 0.5 ... 1 s
- Unit: dB( $\mu$ V) or dBm.

During a measurement time of at least 1 min, 60 measurements (samples) have to be taken and the median of them has to be stored as the result. This procedure minimizes the influence of EMC interference.

Because in the GE06 Agreement the minimum field strength values for DVB-T are different for Gaussian, Rice and Rayleigh channels, the reception channel has to be determined at each measurement location. This is done by recording one trace of the signal spectrum with a small RBW and calculating the standard deviation  $\sigma_{sp}$  of the resulting spectral densities.

This measurement is done with the following spectrum analyser settings:

- Span: 6.5 MHz (7 MHz channel) or 7.6 MHz (8 MHz channels)
- RBW: 30 kHz
- Detector: r.m.s. (preferred) or sample (if r.m.s. is not available)
- Trace mode: ClearWrite (if r.m.s. detector is used), average over 200 sweeps (if sample detector is used)
- Sweep time: 2 s (if r.m.s. detector is used), 10 ms (if sample detector is used)
- Unit: dB( $\mu$ V) or dBm.

The slow sweep time (or long averaging time) is needed to ensure that the resulting spectral levels are not influenced by the modulation of the signal.

Determination of the reception channel has to be done for each field strength measurement separately.

Depending on the measured wanted field strength and reception channel, the distance to the next measurement point can vary according to Table 5.



TABLE 5  
Distance between neighbouring measurement points

Reception channel	Measured wanted field strength $e$ (dB)	Distance to next measurement point (m)
Gaussian or Rice	$e \geq E_{med} + 10$	1 000
Gaussian or Rice	$e < E_{med} + 10$	500 (standard)
Rayleigh	(any)	250

### 3.1.4 Evaluation of the results

#### 3.1.4.1 Verifying homogeneous field strength distribution

To verify that the field strength inside the measurement area is homogeneous and that, depending on the reception channels, enough measurement samples have been taken, it is helpful to plot the statistical distribution of the measured field strength values as shown in Fig. 5. The plot shows the percentage of measurement samples having a certain field strength value (on the y-axis) against that value (on the x-axis).

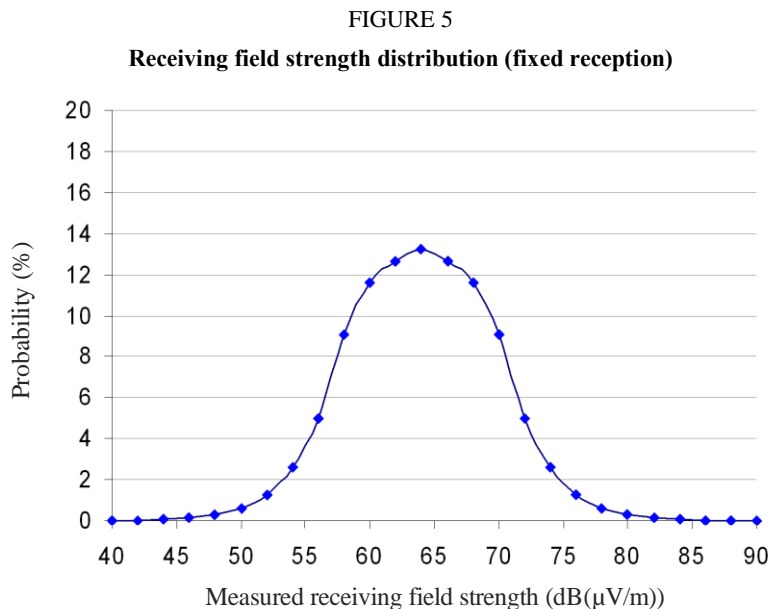

SM.1875-05

In the example shown, 13% of all measured receiving field strength values are 64 dB(µV/m). The curve is relatively narrow and Gaussian. In this case, it can be assumed that the field is relatively homogeneous inside the measurement area. If the curve is flat, broad or does not resemble a Gaussian distribution, the field is cluttered and disturbed. In this case, further measurements with a 250 m grid are necessary.

It must be emphasized that the requirement on field strength distribution given in this section can be used only for study areas located far enough away from the transmitting station and with boundary shapes close to a square or a circle, in other cases this requirement may not be met.

### 3.1.4.2 Correction for the reception channel

As said in § 2.24, the international agreements such as the GE06 Agreement show different  $C/N$  and/or minimum required field strengths depending on the reception channel. These reception channels are idealized in that way that for example, the Rayleigh channel is assumed to have a standard deviation of  $\sigma_{sp}$  of 3 dB. Typically signals of different reception channels are received. To correctly combine the field strengths of these signals, a correction ( $C_\sigma$ ) is added to all measurement values according to § 2.29 and Annex 2 ( $\sigma_{sp}$ -correction). This normalizes all measured field strengths to a  $\sigma_{sp}$  of 3 dB. The result is then only compared with the  $C/N$  and/or minimum median field strength values for Rayleigh channels in international agreements.

### 3.1.4.3 Correction for time probability of interfering signals

If significant interference was received, the measurement values for the interfering field strength made at a random time are regarded to have a 50% time probability. To ensure that due to changing propagation conditions the interfering field strength will not be significantly higher than measured, the measurement values have to be corrected to 99% time probability. The necessary correction value can be determined using Recommendation ITU-R P.1546.

### 3.1.4.4 Decision whether a measurement point is covered

The  $\sigma_{sp}$ -corrected result of the measurement has to be evaluated for each measurement location separately. The following cases are possible and have to be distinguished:

- a) Maximum of wanted field strength comes from the direction of the wanted transmitter and maximum of unwanted emission comes from the direction of the interfering transmitter.
- b) Maximum of wanted field strength comes from the direction of the wanted transmitter and maximum of unwanted emission comes from a reflection of the interfering transmitter.
- c) Maximum of wanted field strength comes from a reflection of the wanted transmitter and maximum of unwanted emission comes from the direction of the interfering transmitter.
- d) Maximum of wanted field strength comes from a reflection of the wanted transmitter and maximum of unwanted emission comes from a reflection of the interfering transmitter.

To determine whether successful reception of the service is possible with a sufficient confidence level, the following three components have to be compared:

- The sum of measured interfering field strength and required protection ratio for the service.
- The measured wanted field strength including  $\sigma_{sp}$ -correction.
- The sum of minimum wanted field strength ( $E_{min}$ ) and correction for required location probability according to Annex 2 ( $C_1$ ).

These components are shown as three blocks in Fig. 6.

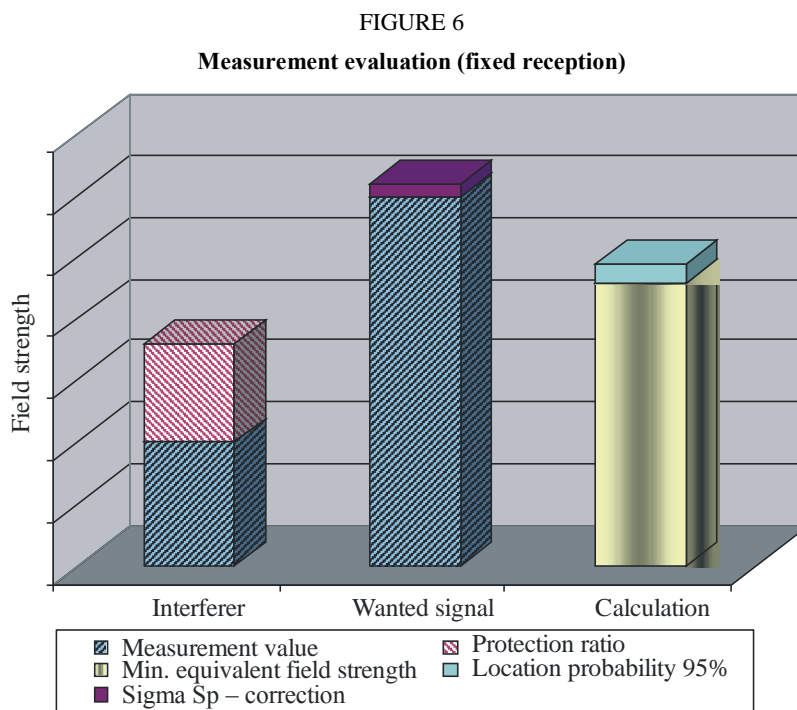

SM.1875-06

If the wanted signal block exceeds the other two blocks, fixed reception is possible with 95% probability for cases a) and b) above. In case coverage is to be assessed for other time probabilities, the correction from 50 to 95% has to be replaced by the equivalent value for the required probability.

For cases c) and d), there is still no guarantee for a successful reception at all times. It is therefore necessary to repeat the measurements at a later time and/or (slightly) different measurement locations to increase the confidence level of the result, or to determine the long-term time probability that a particular point is covered. The results of each measurement at that particular location have to be evaluated separately. If the measurement result is used to guarantee long-term reception at all times, the measurement points for cases c) and d) have to be regarded as not covered. In other cases it may be recorded that the particular locations are only covered at certain times.

### 3.1.5 Result presentation

An evident way of displaying the results is to draw them in a map as shown in Fig. 7. Here, measurement locations where reception is possible are shown as green (bright) dots whereas measurement points where no reception is possible are shown in red (dark). Also to be seen is that between some original measurement locations, additional points were inserted that roughly follow a 250 m grid (see also Fig. 4).

FIGURE 7  
Measurement results (fixed reception)

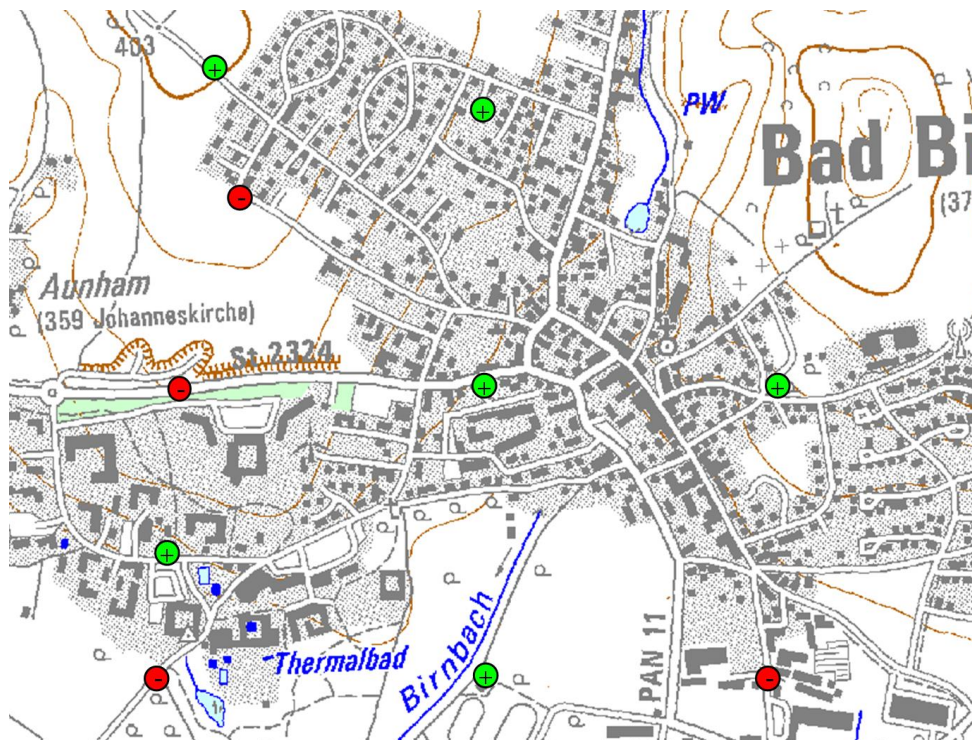

SM.1875-07

Provided enough measurements have been made, it is also possible to determine the location probability with which reception of the service is possible inside the measurement area. This is done by plotting the percentage of  $\sigma_{sp}$ -corrected measurement values exceeding a certain field strength against the value of that field strength. An example is shown in Fig. 8.

The coverage threshold is the higher of:

- the sum of measured interfering field strength plus required protection ratio for the service (this is the “interferer” block in Fig. 6);
- the sum of minimum wanted field strength ( $E_{min}$ ) and correction for required location probability ( $C_1$ ) according to Annex 2 (this is the “calculated” block in Fig. 6).

In the example in Fig. 8, the coverage threshold is 60 dB( $\mu$ V/m) which is reached or exceeded by 70% of the measurement samples. This means that reception will be possible at 70% of the locations inside the measurement area, or, in other words, the measurement area is covered with a probability of 70%.

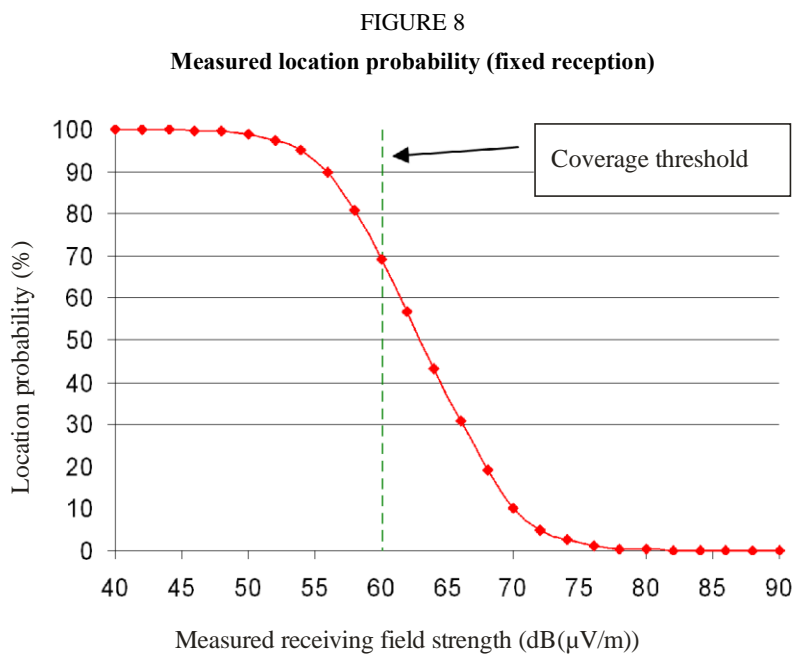

## 3.2 Verifying the coverage prediction for portable reception

### 3.2.1 Measurement principle

To exactly verify the true coverage area, measurements at virtually all locations inside the area would have to be made. To keep the amount of measurements at a practical level, their number has to be limited.

Portable reception is usually defined in a height of 1.5 m above ground. Being so close to the ground, a line-of-sight to the transmitter dominated by the direct signal will be rare, especially in urban surroundings. Most of the reception channels will be Rayleigh. It is therefore necessary to perform mobile measurements in order to gather enough measurement samples for a statistically relevant result.

It is important to note that there are different requirements for portable and mobile reception. Since the measurement method described here focuses on field strength values only, it is still possible to draw conclusions about portable reception when in fact the measurement itself is mobile.

For DVB-T the relevant documentation (e.g. the GE06 Agreement) only specifies minimum median field strengths in 10 m height above ground. To calculate necessary field strengths for portable reception in 1.5 m height, several corrections have to be applied. They are calculated according to Annex 2.

#### *Example:*

The GE06 Agreement specifies a minimum equivalent field strength ( $E_{min}$ ) of 47.3 dB(μV/m) for portable outdoor reception with a standard deviation for the spectral amplitude distribution of  $\sigma_{sp} = 3$  on TV channel 24. This value is clear of all margins and represents the lowest field strength for a successful reception. To calculate the necessary field strength for portable indoor reception, corrections for the building penetration loss and different location probability inside buildings have to be added. For our example, 10.9 dB have to be added for portable indoor reception with a location probability of 70% (see Annex 2), so that the minimum median field strength is 58.2 dB(μV/m).

The measurement is performed while driving along most of the roads inside a measurement area that represents a village or city at the outer rim (or border) of the predicted coverage area. The

results can directly be compared to the calculated minimum median field strength for portable reception.

### 3.2.2 Necessary measurement equipment

For the evaluation of planning parameters for portable DVB-T reception, the following equipment is needed:

TABLE 6  
Necessary equipment for verification of portable DVB-T reception

	Equipment type	Required functions, remarks
General setup	Measurement vehicle	Multiple antennas can be attached to the roof in about 1.5 m above ground positioning system (e.g. GPS)
Receiver (standard)	Spectrum analyser	Data interface to computers (e.g. LAN, IEEE488.2) Channel power measurement mode Sample detector Preferred function: r.m.s. detector
Receiver (optional) <sup>(1)</sup>	Broadband receiver/analyser performing FFT	Min. capture bandwidth: 10 MHz Data interface to computers (e.g. LAN, IEEE488.2) Channel power measurement mode
Antenna	2 omnidirectional antennas <sup>(2)</sup>	Mounted on the roof top of the measurement vehicle One antenna with horizontal and one with vertical polarization Antenna factor must be known (calibrated)
Antenna switch <sup>(2)</sup>	Computer controllable RF switch	Switching speed: $\geq 40/s$
Measurement control	Computer program	Automatically adjustment of the analyser, position the antenna switch, perform the measurements and display live results on screen Store trace data from spectrum analyser Store channel power measurement results Store data from positioning system Live display of the actual standard deviation $\sigma$ of the spectral levels on a digital map

<sup>(1)</sup> Because a broadband FFT receiver/analyser captures the whole signal bandwidth at once it allows faster measurements which gives more accurate results, especially in the determination of the reception channel (see § 3.2.3).

<sup>(2)</sup> For measurements in networks with only one transmitter (MFN) or SFNs using only one polarization, only one omnidirectional antenna and no antenna switch is needed.

The setup for measurements inside SFNs with both polarizations is shown in Fig. 9.

FIGURE 9  
Measurement setup (portable reception inside SFNs)

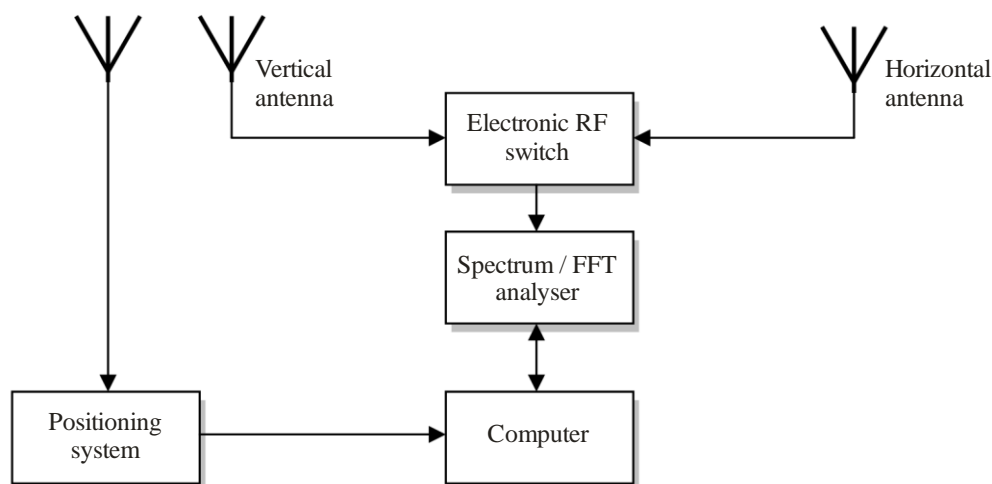

SM.1875-09

### 3.2.3 Measurement procedure

All measurements are taken while driving along the major roads inside the measurement area which is a city or village at the border of the predicted coverage area.

The measurement is triggered once every second (roughly the time a GPS positioning system delivers a new/different coordinate). Then, in a time of 500 ms, 10 samples of the received signal level are taken, converted into field strengths using the antenna factor of the measurement antenna, and the median of the 10 samples is stored together with the geographical coordinate.

The following settings for the spectrum analyser have to be used for the measurement:

- Measurement mode: Channel power
- Channel bandwidth: 7 MHz or 8 MHz
- RBW: 30 kHz or “Auto” (not higher than 100 kHz)
- Detector: r.m.s. (if available), or sample
- Trace mode: ClearWrite
- Sweep time: 20 ... 25 ms.

If a broadband receiver or analyser performing FFT is used, the following settings apply:

- Capture bandwidth:  $\geq 7$  MHz or  $\geq 8$  MHz (channel bandwidth)
- Acquisition time: 1 ms
- Measurement mode: Channel power.

Especially when performing mobile measurements in urban areas and only 1.5 m above ground, the reception channel will often be Rayleigh with fast and significant variations of the receiving conditions. Despite the fact that continuous mobile registration will deliver many measurement values, the number of samples may not be enough to draw conclusions on the coverage situation with reasonable confidence. To get information about the distribution of the field strength in the measurement area, it is necessary to determine the reception channel. This has to be done in each measurement cycle, i.e. once every second, directly after the field strength measurement.

The reception channel is determined by recording the average spectrum over a time of at least 200 ms to level out influences of the DVB modulation.

If this measurement is done with a swept spectrum analyser, the following settings have to be used:

- Span: 6.5 MHz (7 MHz channels) or 7.6 MHz (8 MHz channels)
- RBW:  $\leq 30$  kHz
- Detector: r.m.s. (preferred) or sample (if r.m.s. is not available)
- Trace mode: ClearWrite (if r.m.s. detector is used), average over 20 sweeps (if sample detector is used)
- Sweep time: 200 ms (if r.m.s. detector is used), 10 ms (if sample detector is used)
- Unit: dB( $\mu$ V) or dBm.

Especially in mobile measurements with fast changing receiving conditions, it is important to have the determination of the reception channel as close to the field strength measurement as possible. A broadband receiver/analyser performing FFT can record the whole DVB-T spectrum at once requiring far less measurement time and is therefore recommended. The following settings have to be used:

- Capture bandwidth:  $\geq 7$  MHz or  $\geq 8$  MHz (channel bandwidth)
- Used span: 6.5 MHz (7 MHz channels) or 7.6 MHz (8 MHz channels)
- RBW:  $\leq 30$  kHz
- Acquisition time: 20 ms.

For each of the captured spectra, the standard deviation of the spectral amplitudes  $\sigma_{sp}$  is calculated and stored together with the channel power level and geographical coordinates. Figure 10 shows the basic timing for one measurement cycle.

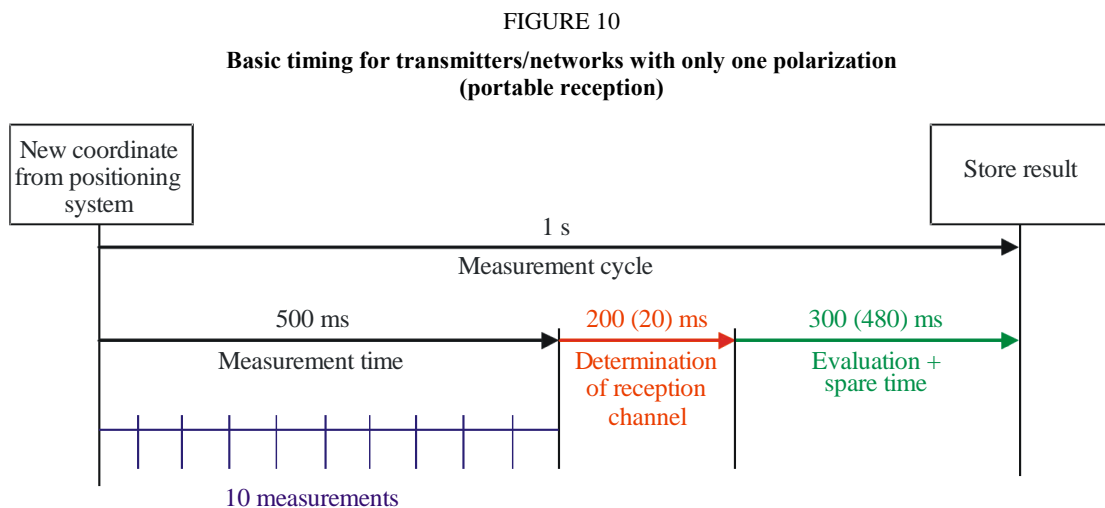

SM.1875-10

In SFNs with mixed polarization, both polarization planes must be measured in the same time. This requires taking 20 measurement samples in 500 ms measurement time. The antenna is switched from vertical to horizontal between each sample. This is necessary to acquire median field strength values for both polarizations referring to the same location. Figure 11 shows the necessary timing (only for the field strength measurement).



FIGURE 11  
Measurement timing for SFNs with mixed polarization (portable reception)

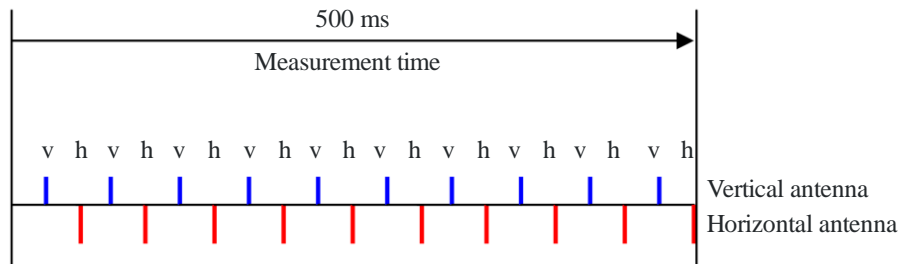

SM.1875-11

In SFNs with mixed polarization, the reception channels also have to be measured in both planes separately. This leaves only 100 ms spare and processing time if a swept spectrum analyser is used, and 460 ms if a broadband FFT receiver/analyser is used.

The equivalent field strength is calculated from the ten samples of each polarization plane separately. The  $\sigma_{sp}$ -correction from the reception channel determination is applied to each of the two medians. The higher of both values is stored as the result.

### 3.2.4 Evaluation of the results

A live evaluation of the measurements is possible by displaying the current value of  $\sigma_{sp}$  on a digital map during the measurement: If in a certain region the value of  $\sigma_{sp}$  frequently is above 3 dB, it is an indication of dominant Rayleigh reception channels. In this case, more measurements are needed which can be achieved by driving more side roads along the route. Figure 12 shows an example of such a live display where green (bright) dots mark Rice channels and red (dark) dots are Rayleigh channels.

FIGURE 12  
Live display of the reception channel during measurement



SM.1875-12

To determine whether portable reception is possible inside the measurement area, it is necessary to compare all measured field strength values with the minimum median field strength for portable reception calculated from the relevant agreements (e.g. the GE06 Agreement). Care should be taken to apply the corrections to the measurement results according to the required reception conditions:

- For portable outdoor reception, only  $\sigma_{sp}$ -correction has to be applied. No additional corrections for location probability are necessary since the measurement was taken under the correct reception conditions and enough samples have been taken. The location probability can directly be derived from the measurement results (see § 3.2.5).
- For portable indoor reception, additional corrections for building penetration loss and the different location probability according to Annex 2 have to be applied.
- Fixed reception cannot be calculated from these mobile coverage measurements at all. Instead, the measurement procedure described under § 3.1 has to be used.

### 3.2.5 Result presentation

The direct way of displaying the coverage situation is to draw the result of the comparison described above on a map in different colours: A green (bright) dot shows measured values plus additional margins exceed the minimum median field strength (reception possible) for portable outdoor situation, blue (dark) dots show points where portable indoor reception is possible.

FIGURE 13

Measurement results (portable reception)



SM.1875-13

If no live display of the reception channel during measurements was possible, it can still be determined afterwards whether the field strength distribution was homogeneous inside the measurement area. This is done by drawing the distribution of the  $\sigma_{sp}$ -corrected measurement results like in Fig. 5. If the curve is Gaussian and relatively narrow, like in the example, the field strength distribution is sufficiently homogeneous. If not, more measurement values are needed by driving along more different roads inside the measurement area.

The disadvantage of the method described here is that this conclusion can only be drawn off-line and may require repeating the measurement. A live display of the reception channel, however, already reveals this result during the measurement when immediate reaction is possible.

From the  $\sigma_{sp}$ -corrected measurement results, it is possible to draw a conclusion about the probability of portable reception inside the measurement area. This is done by plotting the percentage of  $\sigma_{sp}$ -corrected measurement values exceeding a certain field strength against the value of that field strength. An example is shown in Fig. 14.

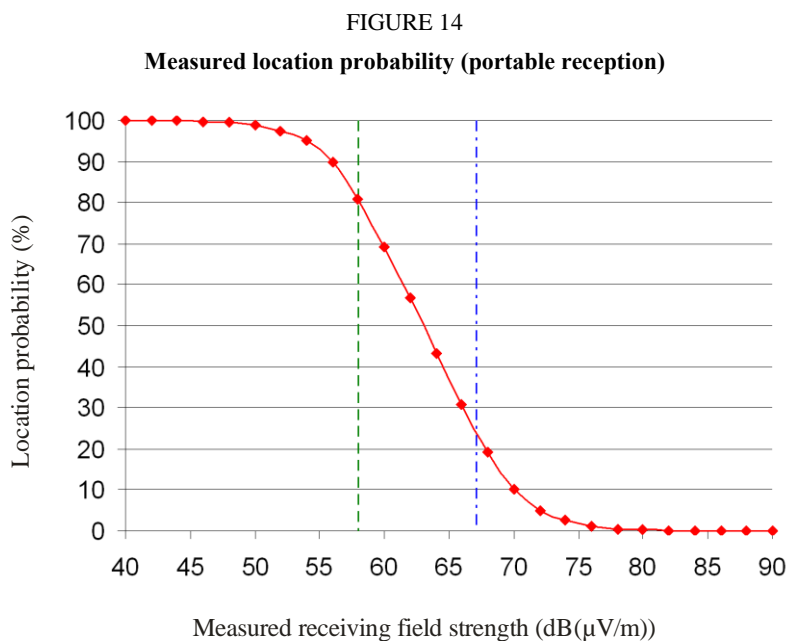

In the example, the calculated minimum median field strength for portable outdoor reception is 58 dB(μV/m) (green dashed line) and for portable indoor reception 67 dB(μV/m) (blue dotted line). The measurement shows that portable outdoor reception is possible in at least 80% of the measurement area and portable indoor reception is possible in at least 25% of the measurement area.

### 3.3 Verifying the coverage prediction for mobile reception

To verify the mobile coverage, field strength measurements along a route have to be performed as described in § 3.2. The only difference is that the minimum required field strength values according to international agreements for mobile reception have to be taken.

This, however, can only give a rough estimation of the true mobile coverage. A major problem especially in 8k-DVB-T systems is that a commercial DVB-T receiver tends to lose synchronization once the received signal becomes too weak or too heavily distorted even for a short time. The necessary time to regain synchronization may be much longer than the duration of the field strength shortage. This effect would lead to a measured coverage area being larger than the area where reception is possible, if only the field strength according to the method for portable reception is measured. To overcome the problem of losing synchronization, DVB-T receivers designed for mobile reception usually deploy antenna diversity.

To correctly assess mobile DVB-T coverage, additional reception quality measurements with a diversity DVB-T measurement receiver have to be made. The detailed measurement procedure is still under development.

## Annex 2

### 1 Reception channel correction ( $\sigma_{sp}$ -correction)

The tables with minimum signal-to-noise ratios ( $C/N$ ) in the GE06 Agreement assume Rice reception channels with a standard deviation  $\sigma_{sp}$  of the spectral amplitudes of 1 dB or Rayleigh channels with a standard deviation of 3 dB. Real measurement results, however, will have standard deviations different from 1 or 3 dB. In these cases, a correction value has to be subtracted from the median of the measured field strength values before comparing them with the relevant tables in the GE06 Agreement according to the following formula:

$$C_{\sigma} = \frac{C/N_{Rayleigh} - C/N_{Gauss} * (\sigma_{sp} - 3)}{2}$$

Figure 15 has examples of the resulting correction for 8k-DVB-T systems with 2/3 and 3/4 code rate.

FIGURE 15  
Corrections due to non-standard reception channels

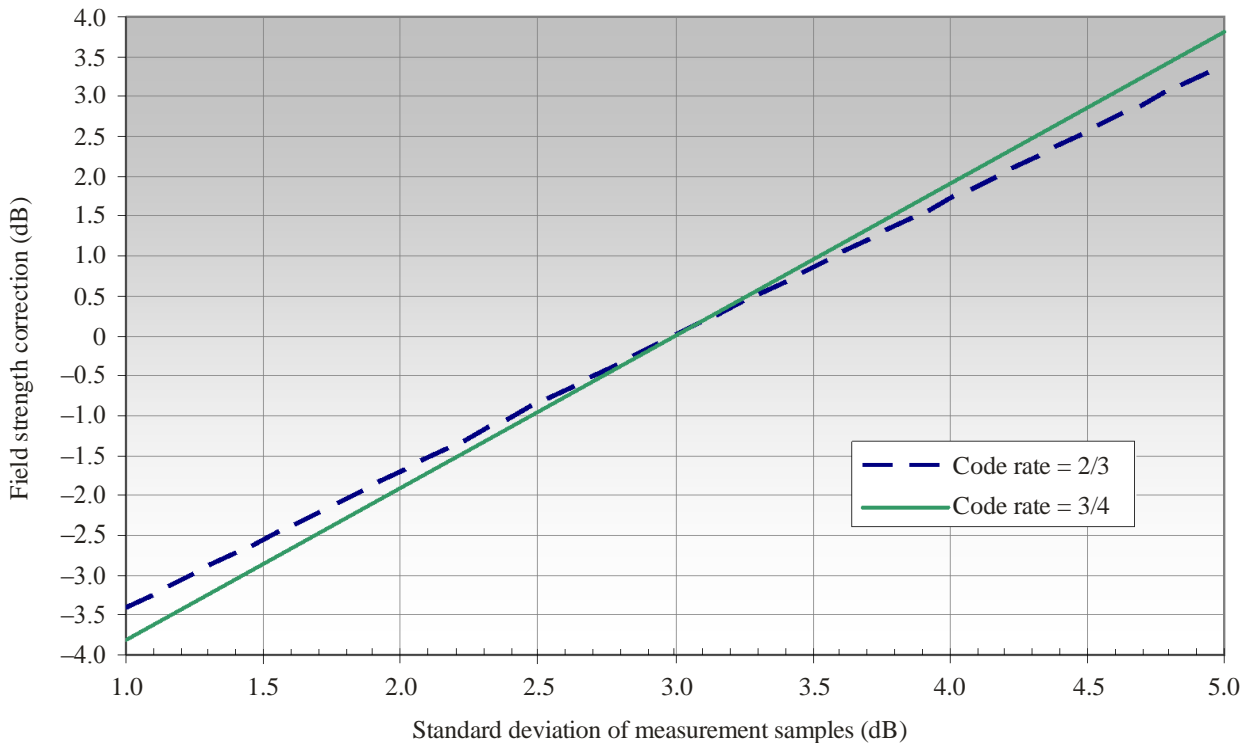

SM.1875-15

### 2 Location probability correction

Calculation of the correction for location probabilities  $C_1$  other than 50% assumes a log-normal distribution of the receiving signal samples.

$$C_1 = \mu * \sigma \quad \text{dB}$$

where:

$\mu$  = distribution factor

$\sigma$  = standard deviation of the measurement samples.

For broadband signals such as DVB-T, the GE06 Agreement specifies the standard deviation inside large areas  $\sigma_1$  as 5.5 dB. With this assumption, the correction for different location probabilities can be calculated according to the values in Table 7.

TABLE 7  
Corrections for different location probabilities

Wanted location probability (%)	$\mu$	$C_1$ (dB)
50	0	0
70	0.52	2.9
95	1.64	9
99	2.33	12.8

For assessment of the indoor coverage, the building attenuation has to be subtracted from measurement values made outside. This building attenuation, however, also has a standard deviation  $\sigma_2$  that has to be added to the standard deviation for broadband signals  $\sigma_1$  as follows:

$$\sigma = \sqrt{\sigma_1^2 + \sigma_2^2}$$

For DVB-T indoor coverage, using the example of Recommendation ITU-R P.1812-2, which specifies the following values for the building attenuation and  $\sigma_2$ :

TABLE 8  
Standard deviation and building attenuation  
for DVB-T indoor coverage

Frequency range (MHz)	Building attenuation (dB)	$\sigma_2$ (dB)
VHF	9	3
UHF	11	6

NOTE – The values are based on Recommendation ITU-R P.1812-2.

### 3 Total correction for indoor coverage

The total correction to be added to field strength values measured at certain fixed locations when indoor coverage is to be assessed is the sum of location probability correction  $C_1$ , the standard deviation  $\sigma_1$  for broadband signal measurements, the building attenuation and its standard deviation  $\sigma_2$ .

TABLE 9

**Total correction for DVB-T indoor coverage when measured at fixed points**

Frequency range (MHz)	Wanted location probability (%)	$\mu$	$\sigma_1$ (dB)	$\sigma_2$ (dB)	$\sigma$ (dB)	$C_1$ (dB)	Building attenuation (dB)	Total correction (dB)
VHF	70	0.52	5.5	3	6.3	3.3	9	12.3
	95	1.64				10.3		19.3
	99	2.33				14.7		23.7
UHF	70	0.52	5.5	6	8.1	4.2	11	15.2
	95	1.64				13.3		24.3
	99	2.33				18.9		29.9

NOTE – The values are based on Recommendation ITU-R P.1812-2.

If, as recommended, the measurement is done mobile, the standard deviation  $\sigma_1$  for broadband signals does not apply for the following reasons:

- the measurement was actually taken where reception is to be assessed;
- the measurement method provides so many samples that the calculated median of all measurement samples already represents the actual median field strength inside the measurement area.

The total correction to be applied to these measurement values are summarized in Table 10.

TABLE 10

**Total correction for DVB-T indoor coverage when measured mobile**

Frequency range (MHz)	Wanted location probability (%)	$\mu$	$\sigma$ (dB)	$C_1$ (dB)	Building attenuation (dB)	Total correction (dB)
VHF	70	0.52	3	1.6	9	10.6
	95	1.64		4.9		13.9
	99	2.33		7.0		16.0
UHF	70	0.52	5.5	2.9	8	10.9
	95	1.64		9.0		17.0
	99	2.33		12.8		20.8