

## RECOMMENDATION ITU-R M.823-2\*

**TECHNICAL CHARACTERISTICS OF DIFFERENTIAL TRANSMISSIONS FOR  
GLOBAL NAVIGATION SATELLITE SYSTEMS FROM MARITIME  
RADIO BEACONS IN THE FREQUENCY BAND 283.5-315 kHz  
IN REGION 1 AND 285-325 kHz IN REGIONS 2 AND 3**

(1992-1995-1997)

**Summary**

Many Administrations are implementing transmissions from radio beacon stations of differential corrections for global navigation satellite systems (GNSS). This Recommendation contains the technical characteristics to which such transmissions should conform for corrections to the GPS and GLONASS Navigation Satellite Systems. The Recommendation also describes the various types of differential correction messages used for those navigation satellite systems and the message format. In addition, it contains details of message transmission schedules.

The ITU Radiocommunication Assembly,

*considering*

- a) Resolution No. 602 of the World Administrative Radio Conference for the Mobile Services (Geneva, 1987) (WARC Mob-87);
- b) that according to No. S5.73 of the Radio Regulations (RR), in the band 285-325 kHz (283.5-325 kHz in Region 1) in the maritime radionavigation service, radio beacon stations may also transmit supplementary navigational information using narrow-band techniques, on condition that the prime function of the beacon is not significantly degraded;
- c) Recommendation ITU-R M.631 on the use of hyperbolic maritime radionavigation systems in the band 283.5-315 kHz;
- d) the technical characteristics set out in the Final Acts of the Regional Administrative Conference for the Planning of the Maritime Radionavigation Service (radio beacons) in the European Maritime Area (Geneva, 1985);
- e) that the navigational accuracy expected to be available from global navigation satellite systems (GNSS) will be 45-100 m (with 95% probability) for general use;
- f) that this accuracy, whilst adequate for most general navigation requirements, will not be enough for some specialized navigation, such as in confined waterways and harbour approaches or for the position sensor in electronic chart systems;
- g) that other specialized maritime applications, such as fishing, navigational surveying, dredging, cable and pipe laying, positioning of buoys and other offshore structures may require higher accuracy than that available from GNSS for general use;
- h) that the navigational accuracy and integrity of GNSS can be improved considerably by the transmission of differential corrections from suitably located reference stations;
- j) that technical, economic and administrative factors indicate that the use of maritime radio beacons would be one feasible solution for the transmission of differential corrections;

---

\* This Recommendation should be brought to the attention of the International Maritime Organization (IMO), the International Civil Aviation Organization (ICAO), the International Association of Lighthouse Authorities (IALA) and the International Maritime Radio Association (CIRM).

- k) that propagation of transmissions from maritime radio beacons is predominantly by ground wave with a usable range that does not exceed the range of applicability of the reference station corrections;
- l) that maritime radio beacons currently provide coverage of coastal waters in many parts of the world, enabling a worldwide standard for these differential transmissions to be introduced efficiently and economically;
- m) that, although present studies have specifically addressed transmission of corrections for GPS/GLONASS, the same principles apply to terrestrial radionavigation systems, such as Loran-C/Chayka,

*recommends*

- 1 that the technical characteristics of a differential correction service for GNSS using maritime radio beacons, in the frequency band 283.5-315 kHz in Region 1 and 285-325 kHz in Regions 2 and 3, and for associated receivers, should be in accordance with the characteristics given in Annex 1.

## ANNEX 1

### System characteristics for differential GNSS

#### 1 Technical characteristics

- 1.1 The carrier frequency of the differential correction signal of a radio-beacon station is an integer multiple of 500 Hz.
- 1.2 Frequency tolerance of the carrier is  $\pm 2$  Hz.
- 1.3 The general message format is as shown in Fig. 1 which details the first two 30 bit words of each frame or message type. Each frame is  $N + 2$  words long,  $N$  words containing the data of the message. The minimum message types available for transmission are as shown in Table 1. Details of these message type contents and formats are as shown in Figs. 2 to 7 for GPS and Figs. 8 to 12 for GLONASS. The parity algorithm used links 30 bit words within and across sub-frames of 10 words, using the (32,26) Hamming Code. Type 6 or 34 ( $N = 0$  or  $N = 1$ ) messages should be used if no other message type is available.

FIGURE 1  
Two-word header for all messages

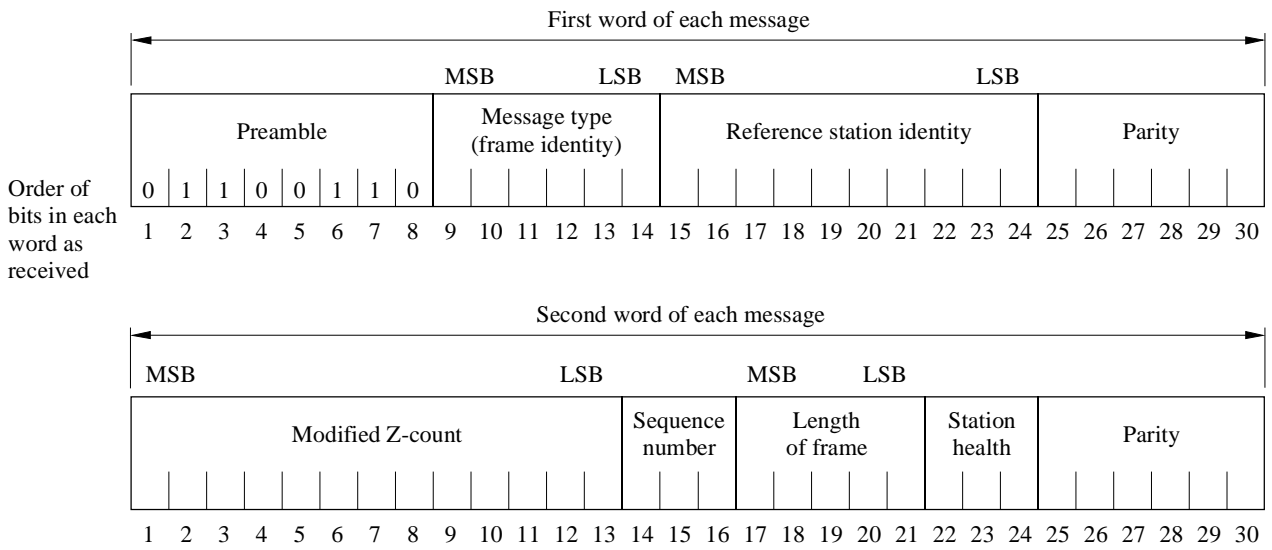

MSB: most significant bit  
LSB: least significant bit

0823-01

Station health bits:

- 111 Shall cause the user equipment to indicate that the reference station is not working properly.
- 110 Shall cause the user equipment to indicate that the transmission is unmonitored.

Other codes are defined by the service provider for healthy broadcasts.

TABLE 1  
Message types

GPS message type number	Title	GLONASS message type number
1	Differential GNSS corrections (full set of satellites)	31
3	Reference station parameters	32
4	Reference Station Datum	4
5	Constellation health	33
6	Null frame	34 ( $N = 0$ or $N = 1$ )
7	Radio beacon almanacs	35
9	Subset differential GNSS corrections (this may replace Types 1 or 31)	34 ( $N > 1$ )
16	Special message	36

FIGURE 2  
Type 1 and Type 9 message formats  
Differential GPS corrections

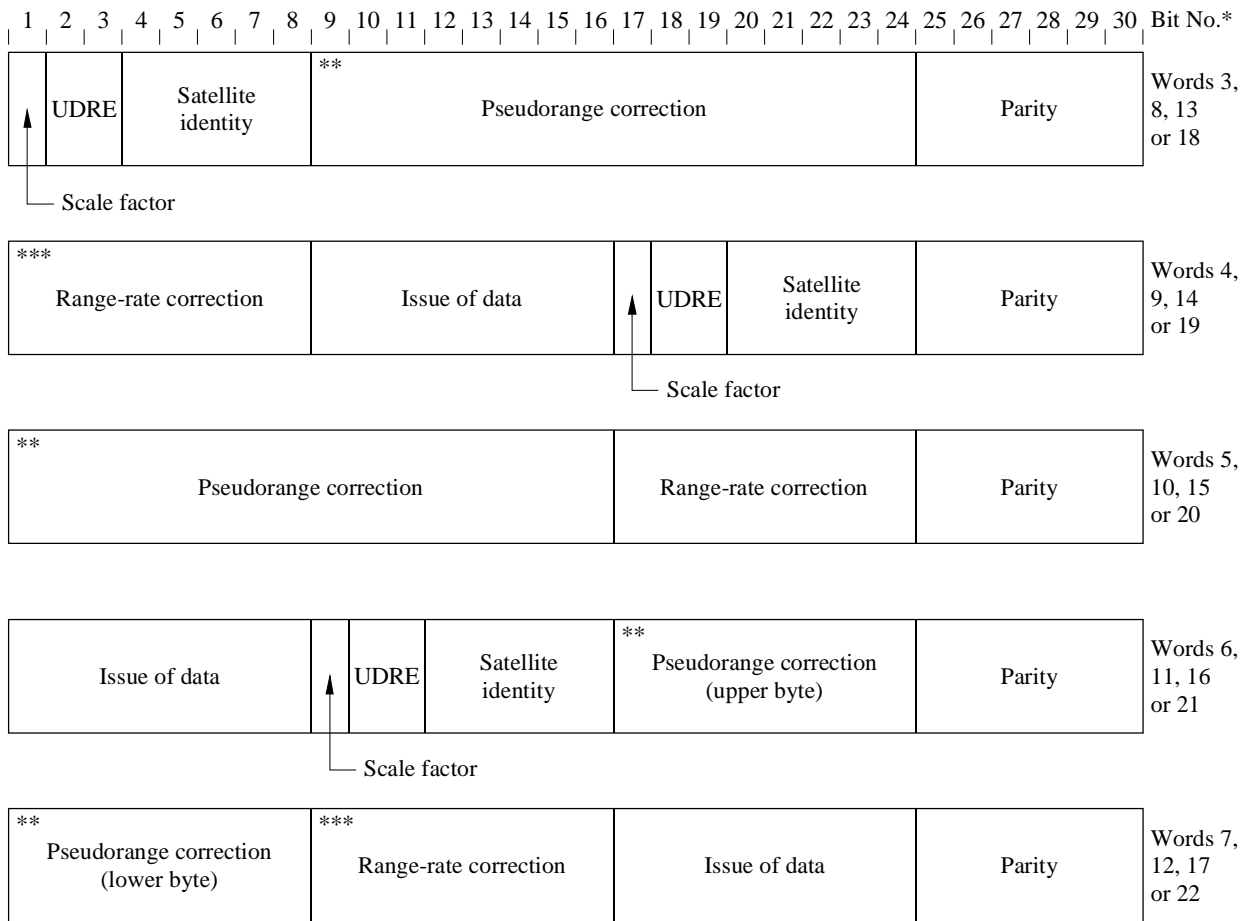

If the number of satellite corrections,  $N_1$ , is not divisible by 3 then one of the two following words is substituted for the last word of this message to complete the data

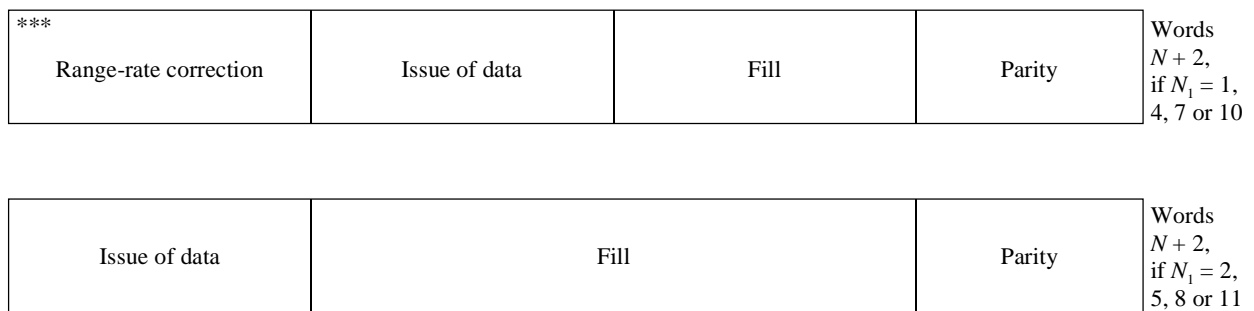

UDRE: user differential range error.

\* As received.

\*\* Binary 1000 0000 0000 0000 indicates a problem and user equipment should immediately stop using this satellite.

\*\*\* Binary 1000 0000 indicates a problem and user equipment should immediately stop using this satellite.

Note 1 - In Type 1 messages the data from all satellites in view are transmitted. In Type 9 messages only the data from a subset of satellites are transmitted.

FIGURE 3  
**Type 3 message format**  
**Reference station parameters (GPS)**

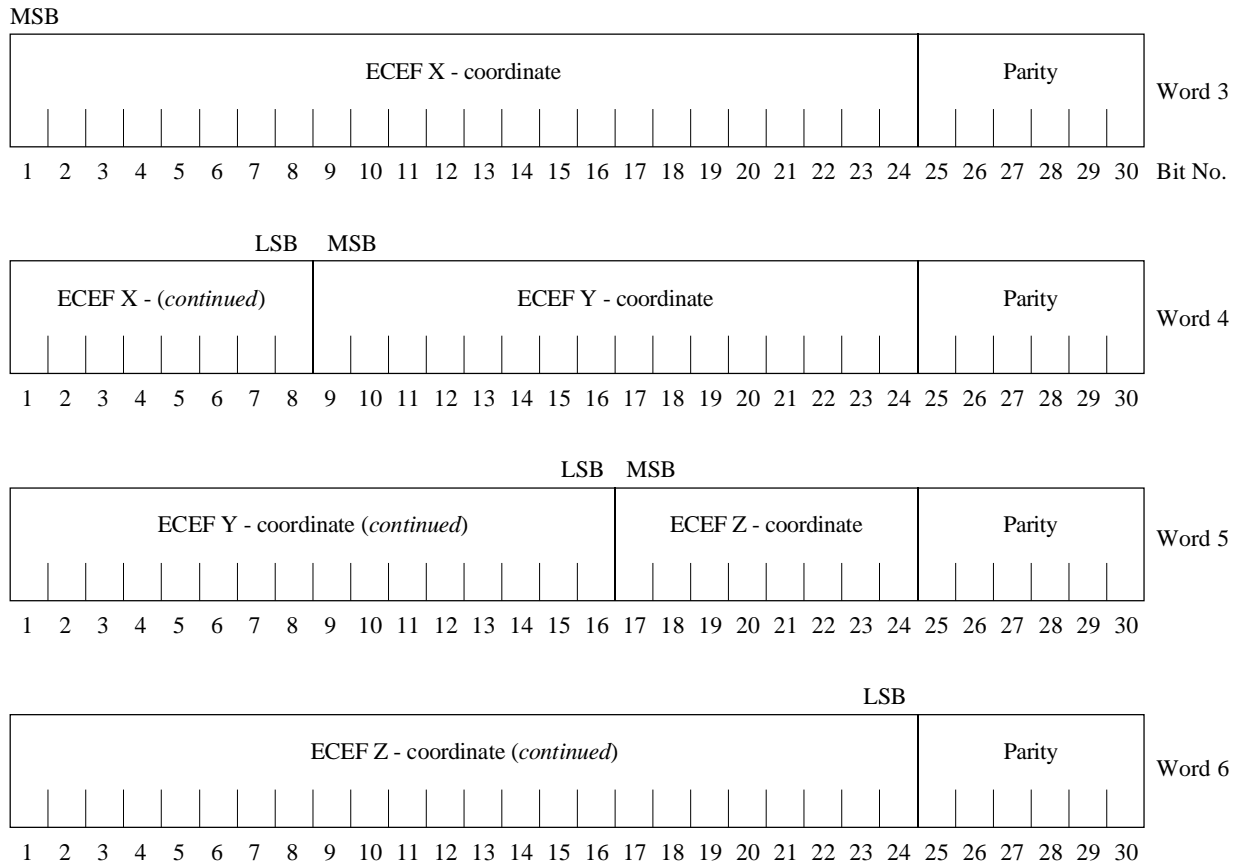

MSB: most significant bit  
 LSB: least significant bit  
 ECEF: Earth-centred, Earth-fixed, WGS-84, unless otherwise specified by service provider

FIGURE 4  
**Type 4 message format**  
**Reference station datum**  
 (see table 2)

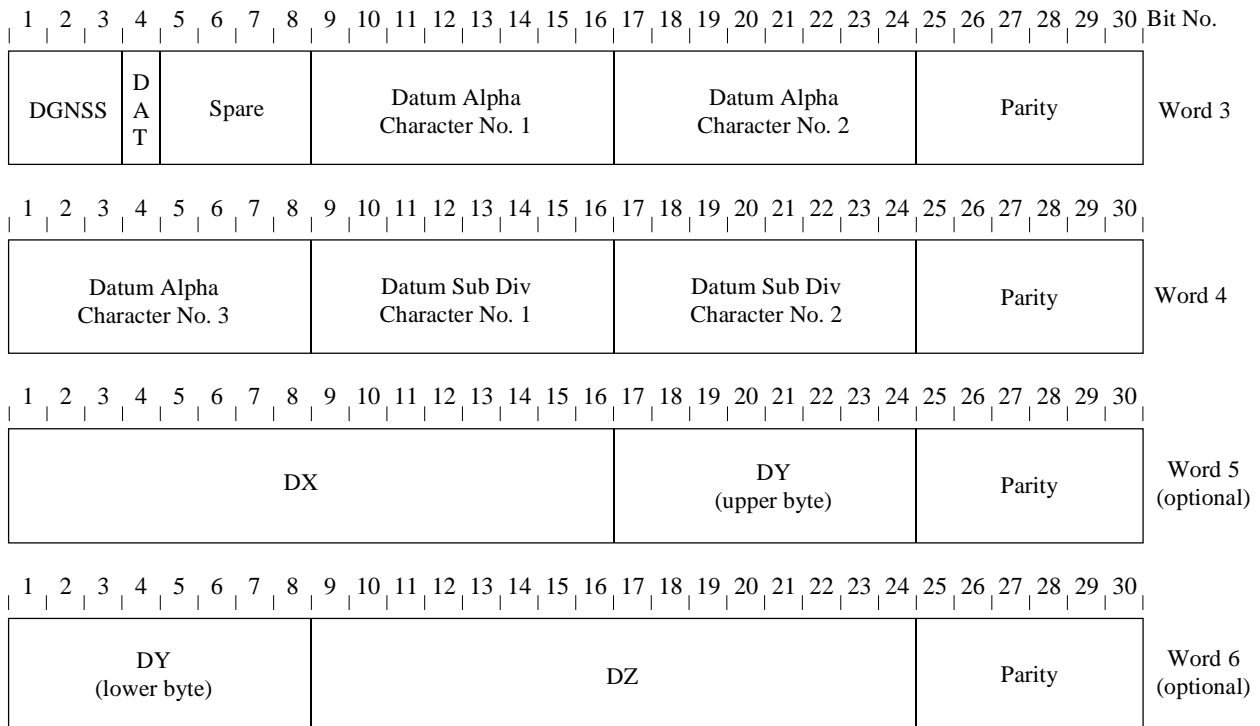

*Note 1* - The three Datum Alpha Code Characters are used to specify the datum used for the selected DGNSS broadcast using the three character alphabetic code for geodetic datum from the International Hydrographic Organization Publication S-60. Publication S-60 does not contain all the geodetic datums in use. If the datum alpha code is unknown, three null characters should be inserted. For a user defined datum, insert 999.

*Note 2* - The parameters DX, DY and DZ specify the ECEF offset of the reference station coordinates. The sense of the shift is defined for DAT = 0 such that if DX, DY and DZ are added to the reference station position expressed in the local ECEF, then the position of the reference station is obtained in GNSS coordinates. The sense of the shift is defined for DAT = 1 such that if DX, DY and DZ are added to the reference station position expressed in WGS-84 (GPS)/PE-90 (GLONASS), then the position of the reference station is obtained in local datum coordinates (Parameters of the Earth-90, formerly called SGS-90). Note that since the differences between datums are not exactly represented by offsets (e.g. coordinate rotational differences are involved), the user positional accuracy may degrade throughout the coverage region of the station.

TABLE 2

Contents of a Type 4 message

Parameter	No. of bits	Scale factor and units	Range
DGNSS	3	1	000 = GPS 001 = GLONASS 010 = Reserved 011 = Reserved 100 = Reserved 101 = Reserved 110 = Reserved 111 = Reserved
DAT	1	1	0 = Local Datum 1 = WGS-84/PE-90
Reserved	4	1	
Datum $\mu$ Code Character No. 1	8	1	
Datum $\mu$ Code Character No. 2	8	1	
Datum $\mu$ Code Character No. 3	8	1	
Datum Sub Div Character No. 1	8	1	
Datum Sub Div Character No. 2	8	1	
DX (optional) <sup>(1)</sup>	16	0.1 m	$\pm 3276.7$ m
DY (optional) <sup>(1)</sup>	16	0.1 m	$\pm 3276.7$ m
DZ (optional) <sup>(1)</sup>	16	0.1 m	$\pm 3276.7$ m

<sup>(1)</sup> Two's complement

NOTE 1 – The field DGNSS identifies the DGNSS system of the reference station. A GPS differential broadcast is identified by 000, and a GLONASS differential broadcast by 001.

FIGURE 5

Type 5 message format  
Constellation health (GPS)

(see Table 3)

One complete word  
for each satellite

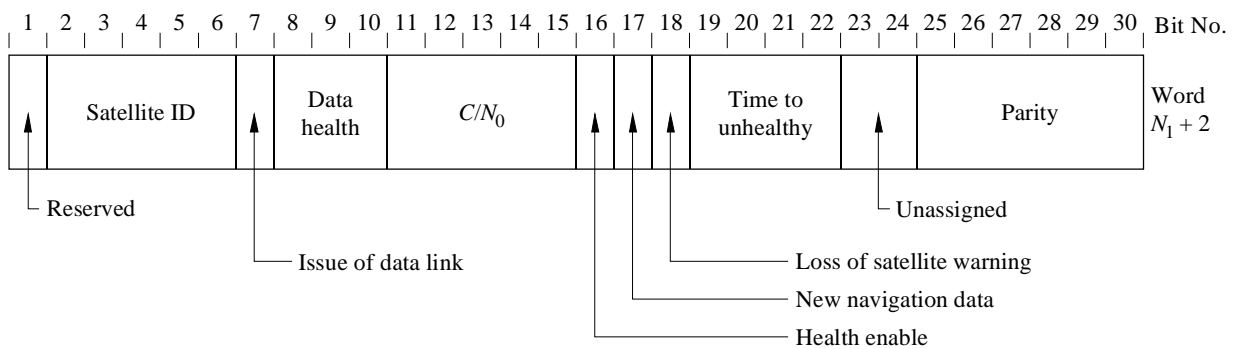

TABLE 3

## Contents of Type 5 and 33 messages

Parameter	Bit No.	Explanation
Reserved	1	A simple bit reserved for possible future expansion of satellite numbers beyond 32
Satellite ID	2-6	Standard format (1-32, 32 is indicated with all zeros)
Issue of data (IOD) link (GPS)	7	Bit set to "0" indicates this information refers to navigation data with IOD or $T_b$ in message Types 1 and 9 (GPS) or 31, 34 (GLONASS)
Issue of data $T_b$ link (GLONASS)		
Data health ( $B_n$ – GLONASS)	8-10	Standard information concerning satellite navigation data health. For GPS three zeros indicate all data is valid, any of the three bits set to "1" indicates a problem with some or all of the data. For GLONASS, bit 8 set to "1" indicates satellite is unhealthy, bit 8 set to "0" indicates satellite is healthy; the second and the third bits are spares and are disregarded by the user equipment
$C/N_0$	11-15	Satellite signal-to-noise ratio as measured at reference station. Scale factor 1 dB(Hz). Range is 25 to 55 dB(Hz). Bit 15 is LSB. The value "00000" indicates that the satellite is not being tracked by the reference station. The value "00001" = 25 dB(Hz) at the low end and the value "11111" = 55 dB(Hz) at the high end
Health enable	16	Bit set to 1 indicates that satellite can be considered healthy by DGPS/DGLONASS user equipment despite the fact that satellite navigation data indicates the satellite is unhealthy
New navigation data	17	Bit set to 1 indicates that new satellite navigation data is being acquired by the reference station and being integrated into the pseudorange correction generation process. There will soon be a new IOD/ $T_b$ indicated in the Type 1/31 or 9/34 messages
Loss of satellite warning	18	Bit set to 1 indicates that a change in the satellite's health to "unhealthy" is scheduled. The "healthy" time remaining is estimated by the following 4 bits
Time to unhealthy	19-22	See bit 18 above. Scale factor is 5 min. Range is 0 to 75 min. Bit 22 is LSB. The value "0000" indicates that the satellite is about to go "unhealthy". The value "1111" indicates the satellite will go "unhealthy" in about 75 min
Unassigned	23-24	
Parity	25-30	

**Type 6 message format**  
**Null frame (GPS)**

The Type 6 message contains no parameters. It will be used as transmission fill, if required. Its purpose is to provide messages when the reference station has no other message ready to send, or to synchronize the beginning of a message to some unspecified epoch.

The message contains the first two words as usual with  $N = 0$  or 1, depending whether an even or odd transmission fill is required. If  $N = 1$ , then the 24 data bits in the extra word should be filled with alternating 1's and 0's. Parity should be tested as usual.



FIGURE 6  
**Type 7 message format**  
**Beacon almanac (GPS)**

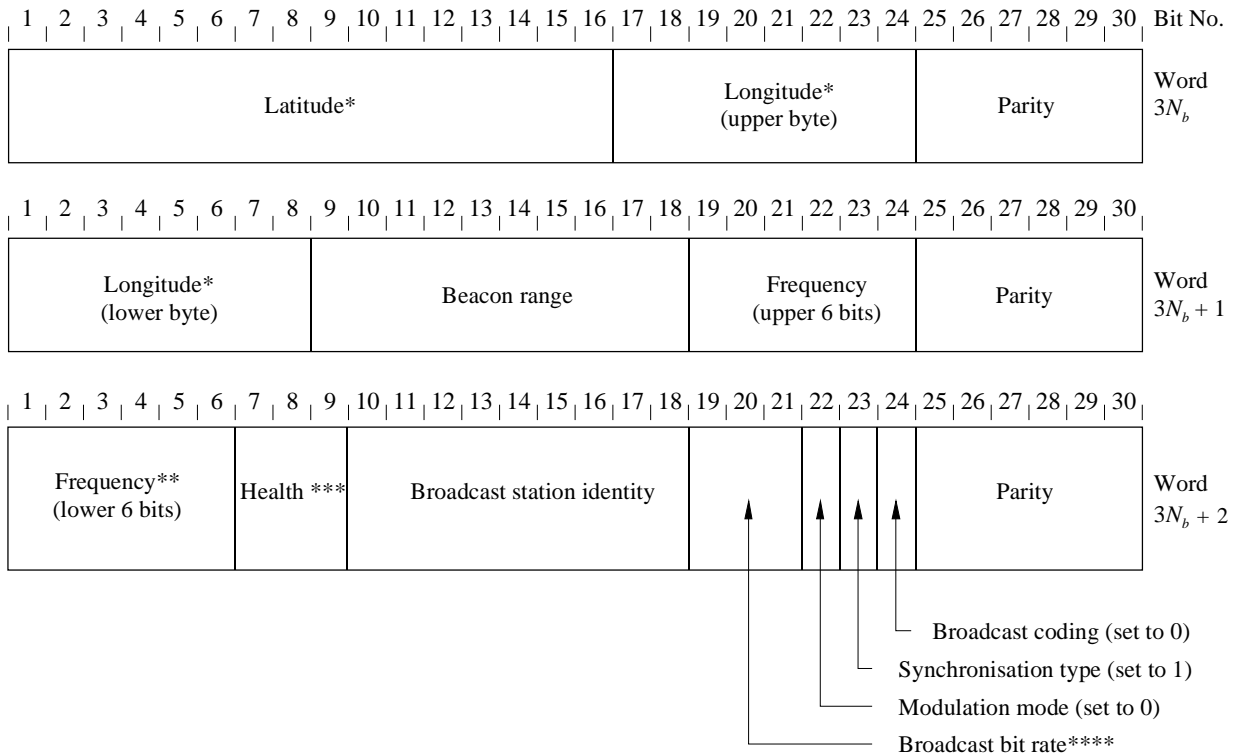

$N_b$ : Number of radiobeacons in the message

\* + values indicate North Latitude or East Longitude

\*\* In 100 Hz steps

\*\*\* Radiobeacon health:

00	(0)	Radiobeacon operation normal
01	(1)	No integrity monitor operating
10	(2)	No information available
11	(3)	Do not use this radiobeacon

\*\*\*\* Broadcasting bit rate:

000	(0)	25 bit/s	100	(4)	150 bit/s
001	(1)	50 bit/s	101	(5)	200 bit/s
010	(2)	100 bit/s	110	(6)	250 bit/s
011	(3)	110 bit/s	111	(7)	300 bit/s

FIGURE 7  
**Type 16 message format**  
**Special message (GPS)**

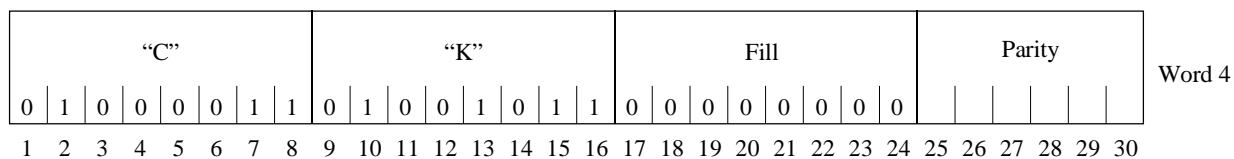
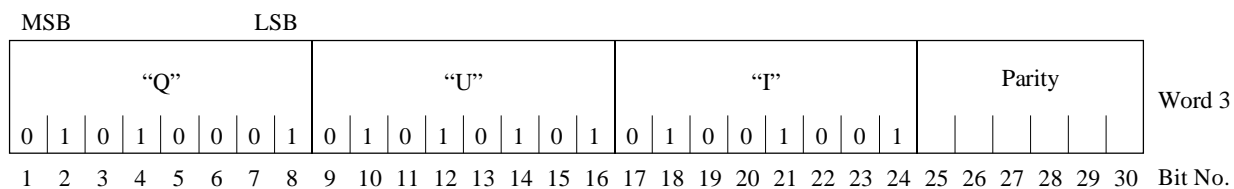

MSB: most significant bit  
 LSB: least significant bit

*Note 1* – This figure shows how the word “quick” would look as a Type 16 message.

*Note 2* – Type 16 message shall be broadcast in English. In addition, the service provider may also broadcast in another language.

FIGURE 8  
**Type 31 and 34\*\*\*\* message formats**  
**Differential GLONASS corrections**

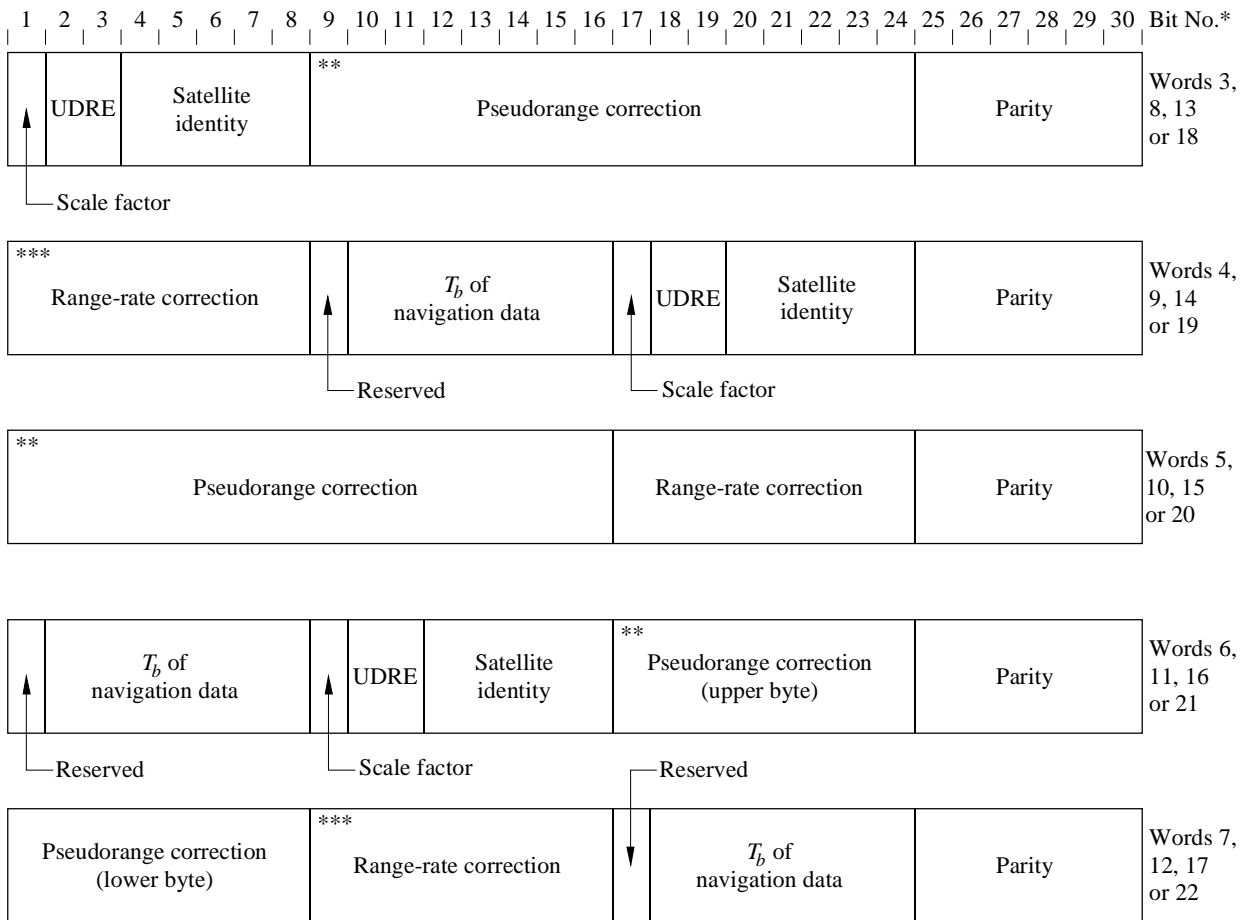

If the number of satellite corrections,  $N_1$ , is not divisible by 3 then one of the two following words is substituted for the last word of this message to complete the data

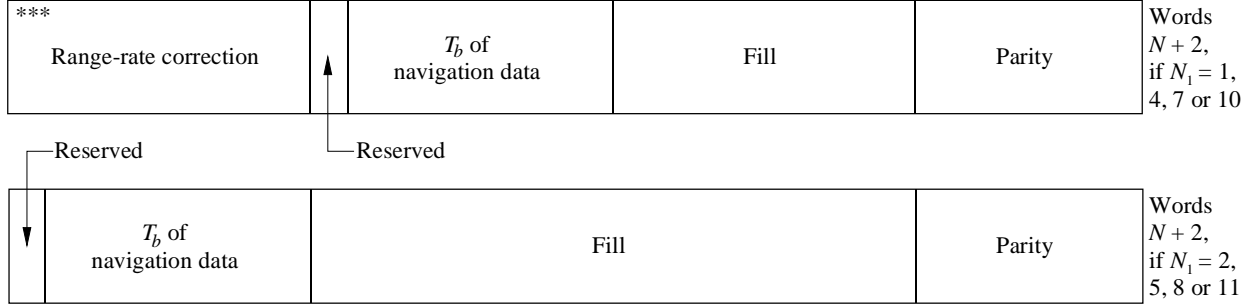

UDRE: user differential range error.

- \* As received.
- \*\* Binary 1000 0000 0000 0000 indicates a problem and user equipment should immediately stop using this satellite.
- \*\*\* Binary 1000 0000 indicates a problem and user equipment should immediately stop using this satellite.
- \*\*\*\* Type 34 message with  $N = 0$  or  $N = 1$  shall be used like DGPS Type 6 message as transmission fill.

Note 1 – In Type 31 messages the data from all satellites in view are transmitted. In Type 34 messages only the data from a subset of satellites are transmitted.

FIGURE 9  
**Type 32 message format**  
**Reference station parameters (GLONASS)**

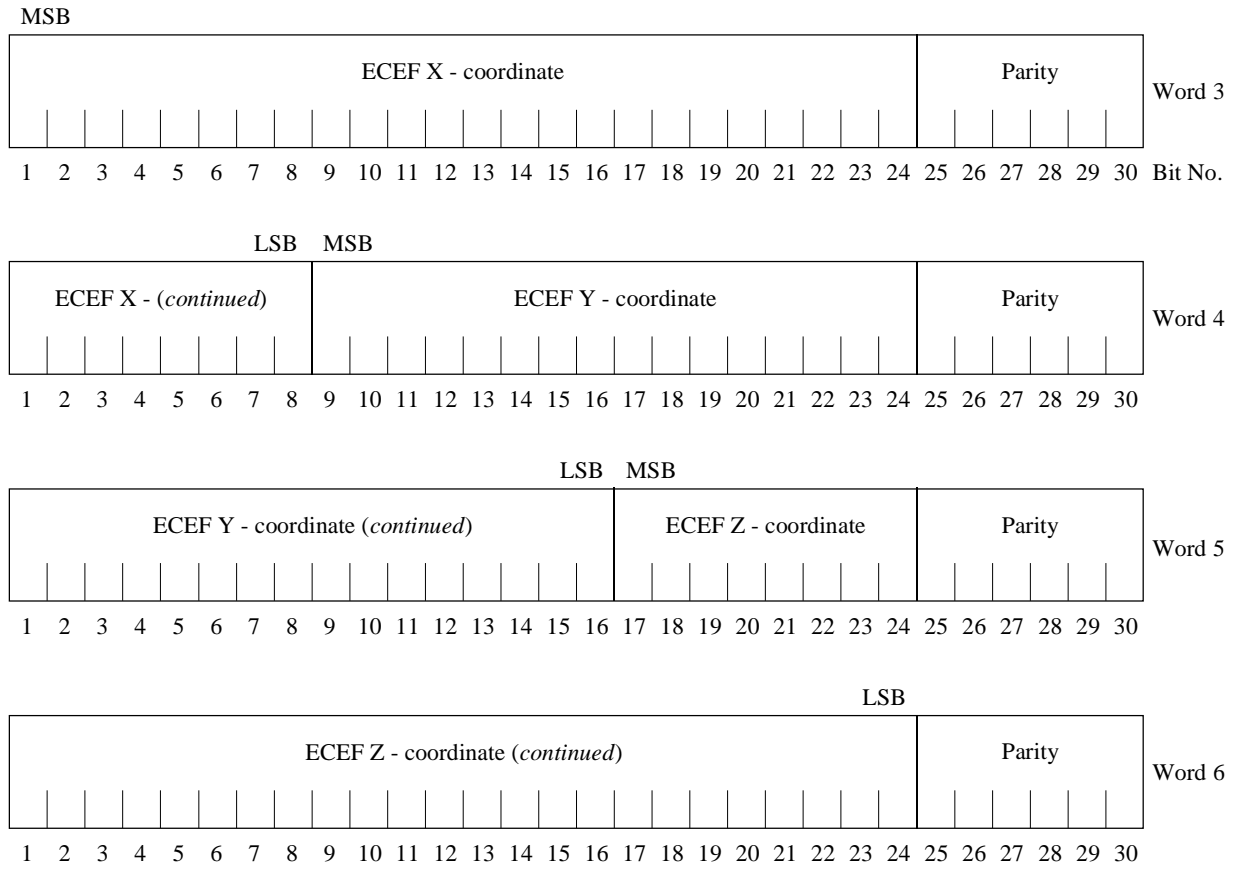

MSB: most significant bit  
 LSB: least significant bit  
 ECEF: Earth-centered, Earth-fixed, PE-90, unless otherwise specified by service provider

0823-09

FIGURE 10  
**Type 33 message format**  
**Constellation health (GLONASS)**  
 (see Table 3)

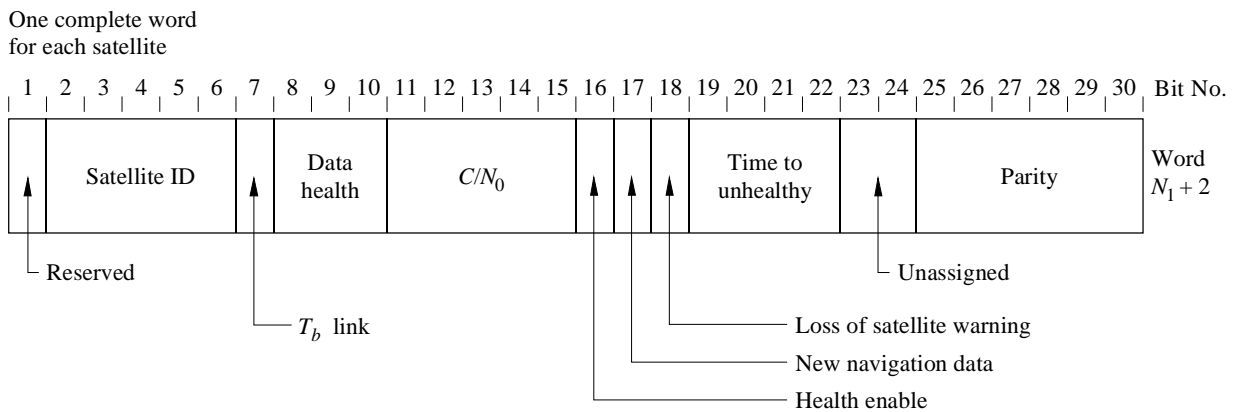

0823-10

FIGURE 11  
**Type 35 message format**  
**Beacon almanac (GLONASS)**

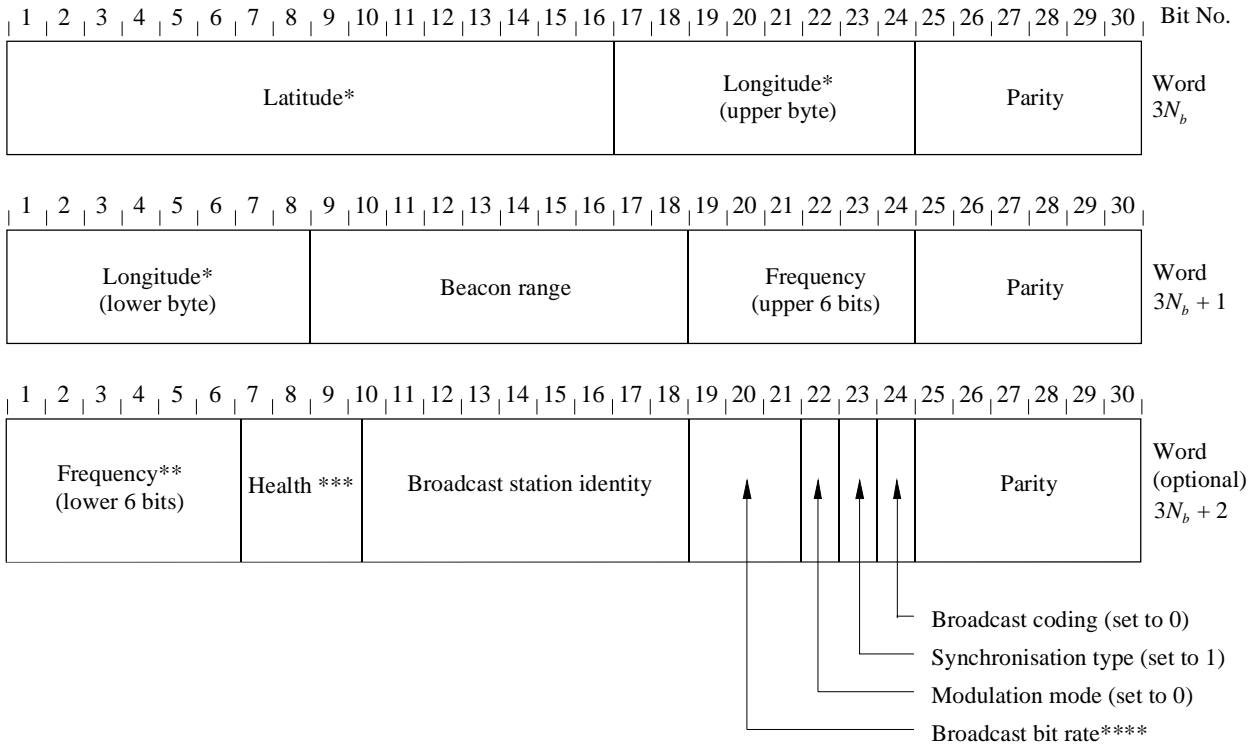

$N_b$ : number of radiobeacons in the message

\* + values indicate North Latitude or East Longitude

\*\* In 100 Hz steps

\*\*\* Radiobeacon health:

00	(0)	Radiobeacon operation normal
01	(1)	No integrity monitor operating
10	(2)	No information available
11	(3)	Do not use this radiobeacon

\*\*\*\* Broadcasting bit rate:

000	(0)	25 bit/s	100	(4)	150 bit/s
001	(1)	50 bit/s	101	(5)	200 bit/s
010	(2)	100 bit/s	110	(6)	250 bit/s
011	(3)	110 bit/s	111	(7)	300 bit/s

0823-11

**1.4** Where Type 9 or Type 34 messages are transmitted in place of Type 1 or Type 31 messages respectively, an equal number of corrections shall be transmitted for each satellite for which corrections are calculated.

**1.5** The transmission of differential data is continuous, synchronous and the most significant bit first.

**1.6** The data transmission rate is selectable from 25 (GLONASS only), 50, 100 and 200 bit/s.

**1.7** Minimum shift keying (class of emission G1D) is used. The form of modulation is 90° phase retard representing binary “0”, 90° phase advance representing binary “1”. The change of phase, relative to the carrier, is linear with a 1 bit duration.

FIGURE 12  
**Message type 36**  
**Special GLONASS message**

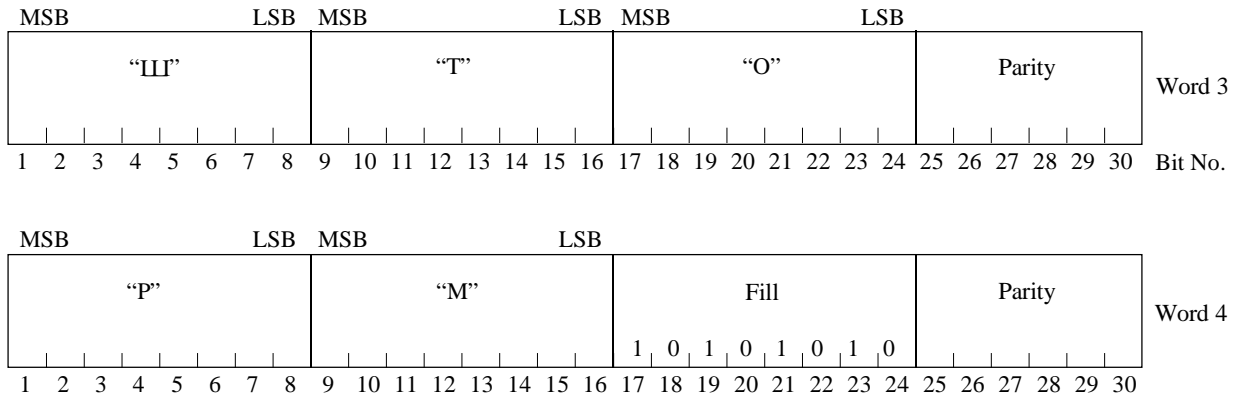

*Note 1* - Type 36 messages provide for characters to be transmitted from a differential GLONASS reference station. To augment the ASCII standard, which is based on English alphabetic characters, Table 4 provides the standard to be employed when transmitting Cyrillic characters to provide Russian language messages. The code is decimal. Codes from 0 to 127 correspond to standard ASCII codes.

*Note 2* - Figure 12 shows how the Russian word ЛИТОПМ would appear.

*Note 3* - Messages of Type 36 shall also be broadcast in English (see Fig. 7 for format).

0823-12

TABLE 4  
**8-bit representation of the Russian alphabet**

Code	Character	Code	Character	Code	Character	Code	Character
128	А	144	Р	160	а	176	р
129	Б	145	С	161	б	177	с
130	В	146	Т	162	в	178	т
131	Г	147	У	163	г	179	у
132	Д	148	Ф	164	д	180	ф
133	Е	149	Х	165	е	181	х
134	Ж	150	Ц	166	ж	182	ц
135	З	151	Ч	167	з	183	ч
136	И	152	Ш	168	и	184	ш
137	Й	153	Щ	169	й	185	щ
138	К	154	Ъ	170	к	186	ъ
139	Л	155	Ы	171	л	187	ы
140	М	156	Ь	172	м	189	ь
141	Н	157	Э	173	н	189	э
142	О	158	Ю	174	о	190	ю
143	П	159	Я	175	п	191	я

**1.8** In the EMA of Region 1, the maximum permitted occupied bandwidth should be 230 Hz.

**1.9** The broadcast and reference station identities are in binary numbers. (The allocation of identities to each radio beacon broadcast and reference station is coordinated by IALA.)

**1.10** The receiver frequency range is at least 283.5-325 kHz, selectable in 500 Hz steps.

- 1.11 The receiver has a dynamic range of 10 μV/m to 150 mV/m.
- 1.12 The receiver operates at a maximum bit error ratio of  $1 \times 10^{-3}$  in the presence of Gaussian noise at a signal-to-noise ratio of 7 dB in the occupied bandwidth.
- 1.13 Partially decoded Type 9 or Type 34 messages can be utilized if both words which contain the corrections for a given satellite have passed parity and no previous words in the message have failed parity.
- 1.14 The receiver has adequate selectivity and frequency stability to operate with transmissions 500 Hz apart having frequency tolerances of  $\pm 2$  Hz and protection ratios given in Table 5.
- 1.15 Where serial data ports are provided, these are to International Electrotechnical Commission (IEC) standards IEC Publication 1162 (Digital Interfaces; Navigational and Radiocommunications equipment on board ships).
- 1.16 The user equipment gives a warning indication of any loss of a valid navigation solution.
- 1.17 Where automatic frequency selection is provided in the receiver, it will be capable of receiving, storing and utilizing beacon almanac information from Type 7 and Type 35 messages.

## 2 Protection ratios

The protection ratios to be applied are as in Table 5.

TABLE 5

**Protection ratios**

Frequency separation between wanted and interfering signal (kHz)	Protection ratio (dB)			
	Radio beacon <sup>(1)</sup> (A1A)	Differential (G1D)	Differential (G1D)	Radio beacon <sup>(1)</sup> (A1A)
Wanted				
Interfering	Differential (G1D)	Radio beacon (A1A)	Differential (G1D)	Radio beacon (A1A)
0	15	15	15	15
0.5	-39	-25	-22	-39
1.0	-60	-45	-36	-60
1.5	-60	-50	-42	-60
2.0	-	-55	-47	-

<sup>(1)</sup> Applicable to radio beacons in the European maritime area under the 1985 Geneva Agreement.

## 3 Definitions

### 3.1 “Modified” Z-count

The Z-count represents the reference time for the differential data messages. The Z-count begins at 0, at the beginning of each hour in GPS or GLONASS time and ranges to a maximum value of 3 599.4 s, with a resolution of 0.6 s. It is used to compute the GPS time or GLONASS time of the corrections, in the same manner as other time calculations are made in the user’s receivers.

### 3.2 Sequence number

The sequence number increments by one with each header and may be used to aid in synchronization.

### 3.3 Issue of data (GPS)

The issue of data (IOD) as broadcast by the reference station is the value in the GPS navigational messages which corresponds to the GPS ephemeris data used to compute corrections. This is a key to ensure that the user equipment calculations and reference station corrections are based on the same set of broadcast orbital and clock parameters.

### 3.4 Scale factor

Two states of the scale factor for pseudorange corrections may be used and these are defined in Table 6. The rationale for the two-level scale factor is to maintain a high degree of precision most of the time, and the ability to increase the range of the corrections on those rare occasions when it is needed.

TABLE 6

Scale factor

Code	No.	Indication
0	(0)	Scale factor for pseudorange correction is 0.02 m and for range rate correction is 0.002 m/s
1	(1)	Scale factor for pseudorange correction is 0.32 m and for range rate correction is 0.032 m/s

### 3.5 User differential range error (UDRE)

An estimate of the root-mean-square error in the differential pseudorange correction. It is influenced by such factors as satellite signal-to-noise ratio, multipath effects and data smoothing. Table 7 defines the format for the UDRE field.

TABLE 7

User differential range error (UDRE)

Code	No.	1 $\sigma$ differential error (m)
00	(0)	$\leq 1$
01	(1)	$> 1$ and $\leq 4$
10	(2)	$> 4$ and $\leq 8$
11	(3)	$> 8$

### 3.6 Earth-centred earth fixed coordination system

WGS 84 is the coordinate system used for GPS. Reference stations may however, be located in a regional system (such as NAD 83 in the United States of America). PE-90 is the coordinate system used for GLONASS and for differential GLONASS reference stations.



**3.7  $T_b$  of navigation data (GLONASS)**

The time within the current 24 h period by UTC(SU), which includes the operational information transmitted in the frame.

**3.8 Special message**

Type 16 and 36 messages are formatted with ASCII characters and shall be broadcast in English. In addition other languages can be broadcast by the service provider.

**3.9 Message scheduling**

Table 8 contains the message schedule for transmissions of differential GPS (DGPS) corrections and Table 9 contains the message schedule for the transmission of DGPS and DGLONASS corrections when they are broadcast from the same radio beacon station.

TABLE 8

**DGPS service**

Type	Rate
9 or 1	Should be broadcast as often as possible
3	Should be broadcast at least twice every hour and after any change in reference station location
5	Should be broadcast at 5 min past the hour and every 15 min thereafter
6	Should be broadcast as required
7	Should be broadcast at 15 min intervals and after any change in broadcast station data. The message should include data on adjacent beacons
16	Should be broadcast as required

TABLE 9

**Combined DGPS/DGLONASS**

GPS		GLONASS	
Type	Rate	Type	Rate
9 or 1	Should be broadcast as often as possible (approximately every 15-20 s)	34 ( $N > 1$ ) or 31	Should be broadcast every 50-60 s
3	Should be broadcast at 15 min and 45 min past each hour	32	Should be broadcast at 15 + 1 min and 45 + 1 min past each hour
5	Should be broadcast at 5 min past each hour and every 15 min thereafter	33	Should be broadcast at 5 + 1 min past each hour and every 15 min thereafter
6	Should be broadcast as required	34 ( $N = 0$ or $N = 1$ )	Should be broadcast as required
7	Should be broadcast at 7 min past the hour and every 15 min thereafter	35	Should be broadcast at 7 + 1 min past the hour and every 15 min thereafter
16	Should be broadcast as required	36	Should be broadcast as required