

RECOMMENDATION ITU-R M.1450-2^{*,**}**Characteristics of broadband radio local area networks**

(Questions ITU-R 212/8 and ITU-R 142/9)

(2000-2002-2003)

The ITU Radiocommunication Assembly,

considering

- a) that broadband radio local area networks (RLANs) will be widely used for semi-fixed (transportable) and portable computer equipment for a variety of broadband applications;
- b) that broadband RLAN standards currently being developed will be compatible with current wired LAN standards;
- c) that it is desirable to establish guidelines for broadband RLANs in various frequency bands;
- d) that broadband RLANs should be implemented with careful consideration to compatibility with other radio applications;
- e) that the above guidelines should not limit the effectiveness of broadband RLANs but be used to enhance their development,

recommends

- 1 that for guidance on preferred methods of multiple access and modulation techniques for broadband RLANs in mobile applications, Table 2 can be referred to;
- 2 that for guidance on existing broadband RLAN standards, Table 3 can be referred to;
- 3 that for guidance on the characteristics of broadband RLANs, Annex 1 can be referred to;
- 4 that for guidance on modulation schemes using orthogonal frequency division multiplexing (OFDM) for broadband RLANs, Annex 2 can be referred to;
- 5 that for detailed guidance on remote access schemes for RLANs in mobile applications, Annex 3 can be referred to;
- 6 that for other information on RLANs refer to Recommendation ITU-R F.1244.

NOTE 1 – Acronyms and terminology used in this Recommendation are given in Table 1.

* This Recommendation was jointly developed by Radiocommunication Study Groups 8 and 9, and future revisions should be undertaken jointly.

** This Recommendation should be brought to the attention of Telecommunication Standardization Study Group 17, and Radiocommunication Study Groups 3 and 4.

TABLE 1

Acronyms and terms used in this Recommendation

AFC	Automatic frequency control
AGA	Automatic gain amplifier
AGC	Automatic gain control
AP	Access point
ARA	Apple remote access
ARP	Authentication request packet
ATM	Asynchronous transfer mode
BPSK	Binary phase shift keying
BRAN	Broadband radio networks
CCK	Complementary code keying
CDMA	Code division multiple access
CSMA/CA	Carrier sensing multiple access with collision avoidance
DCS	Dynamic channel selection
DFS	Dynamic frequency selection
DHCP	Dynamic host configuration protocol
DQPSK	Differential quaternary phase shift keying
DS	Direct sequence
ETSI	European Telecommunications Standards Institute
EY-NPMA	Elimination-yield non-pre-emptive priority multiple access
FDD	Frequency division duplex
FDMA	Frequency division multiple access
FFT	Fast Fourier transform
FH	Frequency hopping
FSK	Frequency shift keying
FWA	Fixed wireless access
GI	Guard interval
GMSK	Gaussian minimum shift keying
HBR	High bit rate HIPERLAN 1 for data period only
IEEE	Institute of Electrical and Electronics Engineers
IETF	Internet Engineering Task Force
IFFT	Inverse fast Fourier transform
IF	Intermediate frequency
IP	Internet protocol
ISDN	Integrated services digital network
ISI	Inter symbol interference
LBR	Low bit rate HIPERLAN 1 for signalling period only
LMS	Least mean square
LSIC	Large scale integrated circuits
MAC	Medium access control

TABLE 1 (*end*)

OFDM	Orthogonal frequency division multiplexing
PBCC	Packet binary convolution coding
PDU	Protocol data unit
PER	Packet error rate
PPP	Point-to-point protocol
PSK	Phase shift keying
PSTN	Public switched telephone network
QAM	Quadrature amplitude modulation
QPSK	Quaternary phase shift keying
RF	Radio frequency
RLS	Recursive least squares
SOHO	Small office home office
SSMA	Spread spectrum multiple access
TCP	Transmission control protocol
TDMA	Time division multiple access
TDD	Time division duplex
TPC	Transmit power control
WATM	Wireless asynchronous transfer mode
WLAN	Wireless local area network
Access method	Scheme used to provide multiple access to a channel
Bit rate	The rate of transfer of bit information from one network device to another
Channel-ization	Bandwidth of each channel and number of channels that can be contained in the RF bandwidth allocation
Frequency band	Nominal operating spectrum of application
Modulation	The method used to put digital information on an RF carrier
Tx power	(Transmitter power) – RF power in Watts produced by the transmitter

TABLE 2

Methods of multiple access and modulation techniques

Frequency band	Multiple access	Modulation technique
UHF	CSMA/CA FDMA TDMA SSMA-DS SSMA-FH	CCK PBCC
SHF	CSMA/CA FDMA TDMA-FDD TDMA-TDD TDMA/EY-NPMA	GMSK/FSK BPSK-OFDM QPSK-OFDM 8-PSK-OFDM 16-QAM-OFDM 64-QAM-OFDM

TABLE 3

Technical parameters for broadband RLAN applications

Network standard	IEEE Project 802.11b	IEEE Project 802.11a ⁽¹⁾	ETSI BRAN HIPERLAN 1 ETS 300-652	ETSI BRAN HIPERLAN 2 ^{(1), (2)}	MMAC HSWA HiSWAN a ⁽¹⁾
Access method	CSMA/CA, SSMA	CSMA/CA	TDMA/EY-NPMA	TDMA/TDD	TDMA/TDD
Modulation	CCK (8 complex chip spreading)	64-QAM-OFDM 16-QAM-OFDM QPSK-OFDM BPSK-OFDM 52 subcarriers (see Fig. 1)	GMSK/FSK	64-QAM-OFDM 16-QAM-OFDM QPSK-OFDM BPSK-OFDM 52 subcarriers (see Fig. 1)	64-QAM-OFDM 16-QAM-OFDM QPSK-OFDM BPSK-OFDM 52 subcarriers (see Fig. 1)
Data rate	1, 2, 5.5 and 11 Mbit/s	6, 9, 12, 18, 24, 36, 48 and 54 Mbit/s	23 Mbit/s (HBR) 1.4 Mbit/s (LBR)	6, 9, 12, 18, 27, 36 and 54 Mbit/s	6, 9, 12, 18, 27, 36 and 54 Mbit/s
Frequency band	2 400-2 483.5 MHz	5 150-5 250 MHz 5 725-5 825 MHz 5 250-5 350 MHz ⁽³⁾	5 150 to 5 300 MHz Limited in some countries to 5 150 to 5 250 MHz ⁽³⁾	5 150-5 350 and 5 470-5 725 MHz ⁽³⁾	5 150 to 5 250 MHz ^{(3), (6)}
Channelization	25/30 MHz spacing 3 channels	20 MHz channel spacing	23.5294 MHz (HBR) 3 channels in 100 MHz and 5 channels in 150 MHz 1.4 MHz (LBR)	20 MHz channel spacing 8 channels in 200 MHz 11 channels in 255 MHz	20 MHz channel spacing 4 channels in 100 MHz

TABLE 3 (end)

Network standard	IEEE Project 802.11b	IEEE Project 802.11a ⁽¹⁾	ETSI BRAN HIPERLAN 1 ETS 300-652	ETSI BRAN HIPERLAN 2 ^{(1), (2)}	MMAC HSWA HiSWAN a ⁽¹⁾
Tx power	1 000 mW e.i.r.p. ⁽⁴⁾ 100 mW e.i.r.p. ⁽⁵⁾ 10 mW/MHz e.i.r.p. density ⁽⁶⁾	5 150 to 5 250 MHz 10 mW/MHz 200 mW e.i.r.p. in 20 MHz channel 5 250-5 350 MHz 1 W e.i.r.p. 5 725-5 825 MHz 4 W e.i.r.p. ⁽⁷⁾	Three different classes of power levels depending on country administration 1 W e.i.r.p., 100 mW e.i.r.p., 10 mW e.i.r.p. Regulatory power limit in CEPT countries; 200 mW maximum mean e.i.r.p.	5 150-5 350 MHz: 200 mW maximum mean e.i.r.p. and use of transmitter power control. 5 470-5 725 MHz: 1 W maximum mean e.i.r.p. and use of transmitter power control	5 150 to 5 250 MHz 10 mW/MHz e.i.r.p. ⁽⁶⁾
Sharing considerations	<ul style="list-style-type: none"> – CDMA allows orthogonal spectrum spreading. – CSMA/CA provides “listen before talk” access etiquette 	<ul style="list-style-type: none"> – OFDM provides low power spectral density. – CSMA/CA provides “listen before talk” access etiquette. – In 5 150-5 250 MHz e.i.r.p. density limit should be subject to Recommendation ITU-R M.1454 	In 5 150-5 250 MHz e.i.r.p. density limit should be subject to Recommendation ITU-R M.1454	<ul style="list-style-type: none"> – OFDM provides low power spectral density. – In 5 150-5 250 MHz e.i.r.p. density limit should be subject to Recommendation ITU-R M.1454. Use of dynamic frequency selection to ensure a near uniform spectrum loading and to facilitate sharing with radars in the bands 5 250-5 350 and 5 470-5 725 MHz. Regulatory restriction to indoor use only in 5 150-5 350 MHz in CEPT countries 	<ul style="list-style-type: none"> – OFDM provides low power spectral density. – “listen before talk” access etiquette is provided (Carrier Sense Rule). – In 5 150-5 250 MHz e.i.r.p. density limit should be subject to Recommendation ITU-R M.1454

⁽¹⁾ Parameters for the physical layer are common between IEEE 802.11a and ETSI BRAN HIPERLAN 2 and HiSWANa.

⁽²⁾ WATM (Wireless ATM) and advanced IP with QoS are intended for use over ETSI BRAN HIPERLAN 2 physical transport.

⁽³⁾ For the band 5 150 to 5 250 MHz, No. 5.447 of the Radio Regulations (RR) applies.

⁽⁴⁾ This requirement refers to FCC 15.247 in the United States of America.

⁽⁵⁾ This requirement refers to EUROPE ETS 300-328.

⁽⁶⁾ This requirement refers to JAPAN MPHPT ordinance for Regulating Radio Equipment, Articles 49-20 and 49-21.

⁽⁷⁾ All values from FCC amendment of the Commission’s Rules to Docket No. 96-102 provide for operation of unlicensed NII (RM-8648) devices in the 5 GHz frequency range (RM-865). Also reflected in Canadian Radio Standard Specification RSS-210.

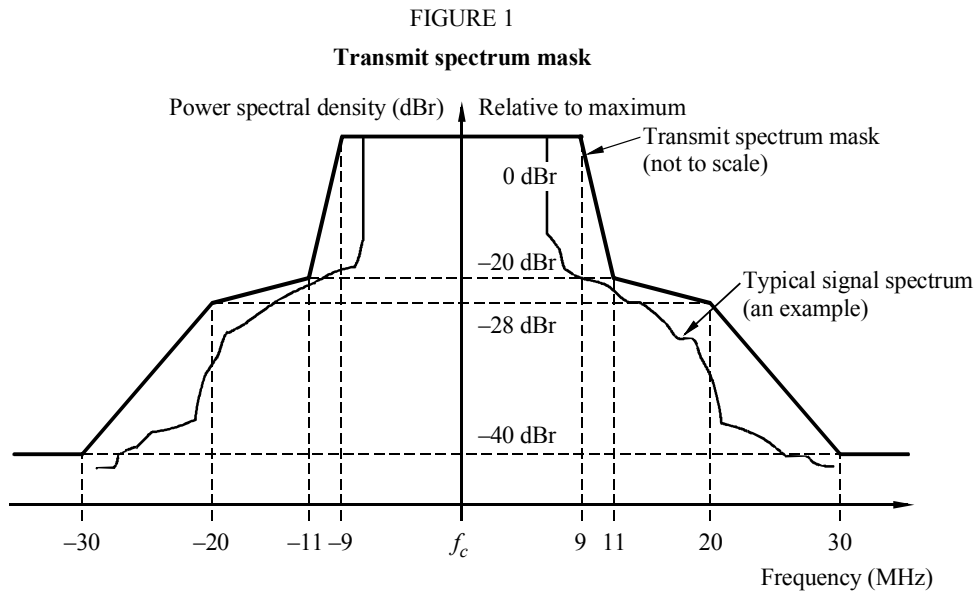

Annex 1

General guidance for broadband RLAN system design

1 Introduction

Emerging broadband RLAN standards will allow compatibility with wired LANs such as IEEE 802.3, 10BASE-T, 100BASE-T and 51.2 Mbit/s ATM at comparable data rates. Some broadband RLANs have been developed to be compatible with current wired LANs and are intended to function as a wireless extension of wired LANs using TCP/IP and ATM protocols. This will allow operation without the bottleneck that occurs with current wireless LANs. Recent bandwidth allocations by some administrations will promote development of broadband RLANs. This will allow applications such as audio/video streaming to be supported with high QoS.

A feature provided by broadband RLANs not provided by wired LANs is portability. New laptop and palmtop computers are very portable and have the ability when connected to a wired LAN to provide interactive services. However, when they are connected to wired LANs one loses the portability feature. Broadband RLANs allow portable computing devices to remain portable and operate at maximum potential.

Private on-premise, computer networks are not covered by traditional definitions of fixed and mobile wireless access and should be considered. The nomadic user of the future will no longer be bound to a desk. Instead, they will be able to carry their computing devices with them and maintain contact with the wired LAN in a facility.

Speeds of notebook computers and hand-held computing devices are increasing steadily. Many of these devices are able to provide interactive communications between users on a wired network but sacrifice portability when connected. Multimedia applications and services require broadband communications facilities not only for wired terminals but also for portable and personal communications devices. Wired local area network standards, i.e. IEEE 802.3ab 1000BASE-T, are able to transport high rate, multimedia applications. To maintain portability, future wireless LANs will need to transport higher data rates. Broadband RLANs are generally defined as those that can provide data throughput greater than 10 Mbit/s.

2 Mobility

Broadband RLANs may be either pseudo fixed as in the case of a desktop computer that may be transported from place to place or portable as in the case of a laptop or palmtop devices working on batteries. Relative velocity between devices remains low. In warehousing applications, RLANs may be used to maintain contact with lift trucks at speeds of up to 6 m/s. RLAN devices are generally not designed to be used at automotive or higher speeds.

3 Operational environment and considerations of interface

Broadband RLANs are predominantly deployed inside buildings, in offices, factories, warehouses, etc. For RLAN devices deployed inside buildings, emissions will be attenuated by the structure.

RLANs utilize low power levels because of the short distance nature of inside building operation. Power spectral density requirements are based on a basic service area of a single RLAN defined by a circle with a radius from 10 to 50 m. When larger networks are required, RLANs may be logically concatenated via bridge or router function to form larger networks without increasing their composite power spectral density.

One of the most useful RLAN features is the connection of mobile computer users to his own LAN network without wires. In other words, a mobile user can be connected to his own LAN subnetwork anywhere within the RLAN service area. The service area may expand to other locations under different LAN subnetworks, enhancing the mobile user's convenience.

Annex 2 describes several remote access network techniques to enable the RLAN service area to extend to other RLANs under different subnetworks. Among these techniques, the mobile VLAN (virtual LAN) technique is a most promising enhancement.

To achieve the coverage areas specified above, it is assumed that RLANs require a peak power spectral density of approximately 12.5 mW/MHz in the 5 GHz operating frequency range. For data transmission, some standards use higher power spectral density for initialization and control the transmit power according to evaluation of the RF link quality. This technique is referred to as transmit power control (TPC). The required power spectral density is proportional to the square of the operating frequency. The large scale, average power spectral density will be substantially lower than the peak value. RLAN devices share the frequency spectrum on a time basis. Activity ratio will vary depending on the usage, in terms of application and period of the day.

Broadband RLAN devices are normally deployed in high density configurations and may use an etiquette such as listen before talk and dynamic channel selection (referred to here as dynamic frequency selection, DFS), TPC to facilitate spectrum sharing between devices.

4 System architecture

Broadband RLANs are nearly always point-to-multipoint architecture. Point-to-multipoint applications commonly use omnidirectional, down looking antennas. The multipoint architecture employs two system configurations:

4.1 point-to-multipoint centralized system (multiple devices connecting to a central device or access point via a radio interface);

4.2 point-to-multipoint non-centralized system (multiple devices communicating in a small area on an ad hoc basis);

4.3 RLAN technology is sometimes used to implement fixed point-to-point links between buildings in a campus environment. Point-to-point systems commonly use directional antennas that allow greater distance between devices with a narrow lobe angle. This allows band sharing via channel reuse with a minimum of interference with other applications.

5 Spectrum reuse

RLANs are generally intended to operate in unlicensed or license-exempt spectrum and must allow adjacent uncoordinated networks to coexist whilst providing high service quality to users. In the 5 GHz bands, sharing with primary services must also be possible. Whilst multiple access techniques might allow a single frequency channel to be used by several nodes, support of many users with high service quality requires that enough channels are available to ensure access to the radio resource is not limited through queuing, etc. One technique that achieves a flexible sharing of the radio resource is DFS.

In DFS all radio resources are available at all RLAN nodes. A node (usually a controller node or access point (AP)) can temporarily allocate a channel and the selection of a suitable channel is performed based on interference detected or certain quality criteria, e.g. received signal strength, C/I . To obtain relevant quality criteria both the mobile terminals and the access point make measurements at regular intervals and report this to the entity making the selection.

DFS can be implemented to ensure that all available frequency channels are utilized with equal probability. This maximizes the availability of a channel to node when it is ready to transmit, and it also ensures that the RF energy is spread uniformly over all channels when integrated over a large number of users. The latter effect facilitates sharing with other services that may be sensitive to the aggregated interference in any particular channel, such as satellite-borne receivers.

TPC is intended to reduce unnecessary device power consumption, but also aids in spectrum reuse by reducing the interference range of RLAN nodes.

Annex 2

Modulation techniques in broadband RLANs

1 Introduction

RLAN systems are being marketed all over the world. There are several major standards for broadband RLAN systems and Table 3 provides an overview of these.

Broadband RLAN systems make it possible to move a computer within a certain area such as an office, a factory, and SOHO with high data rates of more than 20 Mbit/s. As a consequence of the great progress in this field, computer users are demanding free movement with bit rates equivalent to those of conventional wired LANs such as 10BASE-T Ethernet.

This Annex presents features of the modulation techniques used in the standards listed in Table 3.

2 Physical layer to realize high bit rate and stable wireless networks

The broadband radio channel is known to be frequency selective, causing ISI in the time domain and deep notches in the frequency domain. A possible method to realize a high bit rate, wireless access system under frequency selective fading channels is to shorten the symbol period. A second way is to use bandwidth efficiently by multi-level modulation. The third way is to employ multicarrier modulation. The first and second solutions show serious drawbacks in multipath environments. In the first solution, as the symbol period decreases, ISI becomes a severe problem. Therefore, equalization techniques will be necessary. The second solution reduces the symbol distance in the signal space and hence the margin for thermal noise or interference is decreased, leading to intolerable performance degradation for high bit rate, wireless access systems. The third solution, the multicarrier method, is to increase the symbol period in order to compensate for ISI resulting from multipath propagation. As promising methods for multipath countermeasures, the first solution of single carrier with equalizer and the third solution using multicarrier methods (OFDM) are discussed below.

3 Single carrier with equalizer

In radiocommunications, the transmission is affected by the time-varying multipath propagation characteristics of the radio channel. To compensate for these time-varying characteristics, it is necessary to use adaptive channel equalization. There are two main groups into which adaptive equalizers can be subdivided; the LMS equalizer and the RLS equalizer. The LMS algorithm is the most commonly used equalization algorithm because of its simplicity and stability. Its main disadvantage is its relatively slow convergence. LMS converges in 100-1000 symbols. A faster equalization technique is known as an RLS method. There exist various versions of RLS with somewhat different complexity and convergence trade-off. RLS is more difficult to implement than

LMS, but converges in fewer symbols compared with LMS methods. Although much research has been conducted on RLS and LMS equalizers in the cellular systems, RLS and LMS are still a research topic in the points of fast convergence, stability and complexity for high bit rate wireless access applications.

4 Multicarrier OFDM

With multicarrier transmission schemes the nominal frequency band is split up into a suitable number of sub-carriers each modulated by QPSK modulation, etc., with a low data rate. In general, when dimensioning a multicarrier system, the maximum path delay should be shorter than the symbol time. An OFDM modulation scheme is one of the promising multicarrier methods. The power spectrum of this modulation is shown in Fig. 2. The development of fast and power saving LSIC and effective algorithms, FFT for signal processing today allows a cost-effective realization of OFDM schemes. The advantages of this system are given by a satisfactory spectral efficiency and in the reduced effort for equalization of the received signal. In the case of limited delay spread ($< \sim 300$ ns) of the multipath signals it is possible to dispense with an equalizer.

FIGURE 2
Spectrum of OFDM

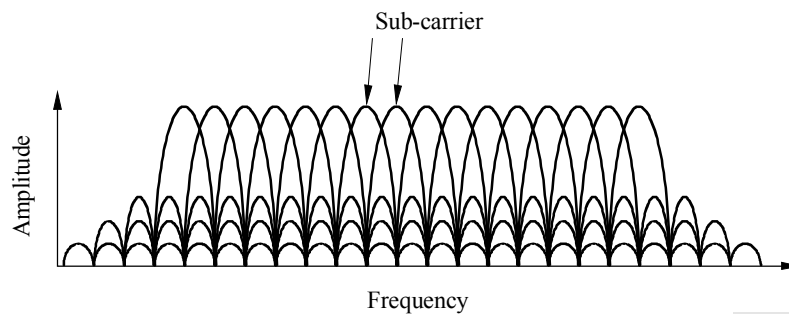

1450-02

The multicarrier transmission scheme employed with OFDM causes envelope fluctuation like additive white Gaussian noise and the effect on the interference environment is negligible.

5 Configuration of OFDM system

A simplified block diagram of an OFDM transmitter and receiver is shown in Fig. 3. In this example the data to be transmitted are coded by convolutional coding ($r = 3/4$, $k = 7$) and serial-parallel (S/P) converted and the data modulates the allocated subcarrier by DQPSK modulation. In the IEEE 802.11a and HIPERLAN/2 standards, data rates from 6 to 54 Mbit/s can be offered by using various signal alphabets for modulating the OFDM sub-carriers and by applying different puncturing patterns to a mother convolutional code. BPSK, PSK, 16-QAM and 64-QAM modulation formats are used. An IFFT of the modulated sub-symbols generates the OFDM signals. GI signals are added to the output signals of the IFFT. The GI added OFDM signals are shaped by roll-off amplitude weighting to reduce outband emission. Finally, the OFDM signals modulate IF. At the receiver side, received signals are amplified by the AGA and converted to the baseband

signals. At this stage, frequency error due to instability of the RF oscillators is compensated by AFC and the timing of packet arrival is detected. After this synchronization processing, the GI signals are removed and the OFDM signals are de-multiplexed by the FFT circuit. The output signals of the FFT circuit are fed to the de-mapping circuit and demodulated. Finally, a Viterbi decoder decodes the demodulated signals.

FIGURE 3
Configuration of DQPSK-OFDM with convolutional coding

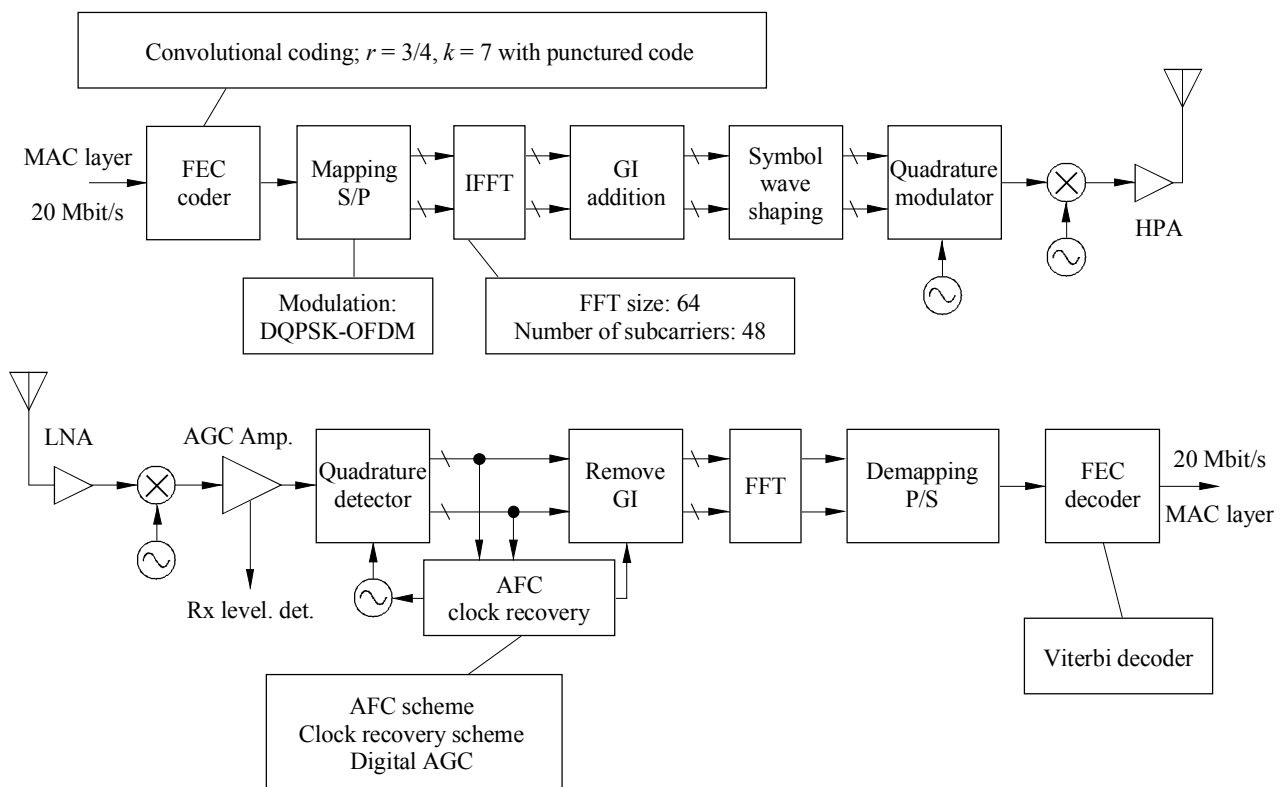

1450-03

6 Computer simulation

Major simulation parameters and the OFDM symbol format are shown in Table 4 and Fig. 4, respectively. Figure 5 shows that to achieve the packet error rate of 10%, the required E_b/N_0 is about 20 dB under the frequency selective fading channel with 300 ns delay spread. The proposed physical layer approach allows us to use this high bit rate RLAN system not only in indoor areas but also outdoor areas forming parts of locations such as universities, factories, and shopping malls, etc.

TABLE 4

Major simulation parameters

Raw data rate	26.6 Mbit/s
Modulation/detection	DQPSK/differential detection
FFT size	64 samples
Number of subcarriers	48
GI	12 samples
Number of T_{prefix} samples	4 samples
Symbol duration (T_s)	84 samples (= 3.6 μ s)
Carrier frequency offset	50 kHz (10 ppm at 5 GHz)

FIGURE 4

OFDM symbol format

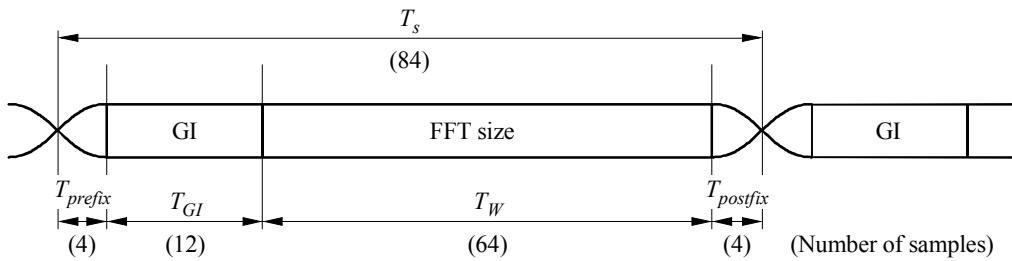

1450-04

FIGURE 5

Packet error rate vs E_b/N_0

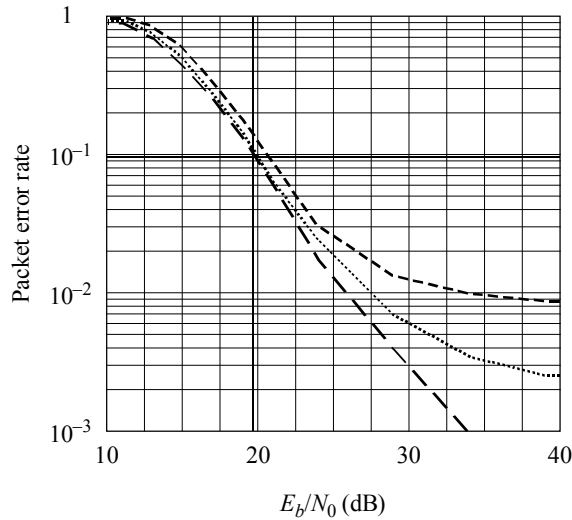

- $\tau_{rms} = 100$ ns
- $\tau_{rms} = 200$ ns
- .-.- $\tau_{rms} = 300$ ns

Packet length = 1 000 byte with ideal AGC
 3-bit soft decision
 Output backoff = 5 dB

1450-05

Annex 3

Remote access techniques in RLANs

1 Introduction

One of the most beneficial usages of RLANs is that the RLAN terminals can be used without any additional operation at other company offices where they move. In order to realize such usage, it is very important to establish network techniques to virtually connect the RLAN terminals that are in other offices (other subnetworks) to their own subnetwork.

There are several approaches to support such remote access for RLAN terminals.

In the following sections, these techniques will be explained, and compared in the aspects of service performance and system composition.

2 Remote access techniques

2.1 Dial-up connection

Currently, the simplest way to connect a terminal from a remote place is a dial-up method. It does not need a LAN environment, but it is possible wherever the telephone network is available, using a modem or an ISDN adapter. Normally, the user sets up a telephone line in his home office, and connects a modem to a dial-up server. A mobile PC with a modem card can be connected to the home network server by a public wired or wireless telephone. In this connection PPP [IETF, 1994a], or ARA is mainly used.

On the other hand, the dial-up method has the following restrictions:

- additional software is necessary on mobile terminals;
- the network interface changes;
- communication bit rate is low;
- connection fee is generally expensive.

2.2 Dynamic Host Configuration Protocol (DHCP)

DHCP [IETF, 1993] is a technique using a new network address at a remote network. DHCP is originally a protocol for the auto-configuration of terminal network interfaces. It enables mobile RLAN terminals to connect to the home network via the Internet by searching for a DHCP server and obtaining a new address.

For DHCP, the following restrictions exist:

- additional software is necessary on mobile RLAN terminals;
- only TCP/IP is available;
- it is unavailable for networks with private IP addresses.

2.3 Mobile IP

Mobile IP [IETF, 1996] is a technique that supports terminal mobility in networks. In mobile IP, IP packets transmitted to a mobile RLAN terminal are encapsulated by a home agent into other IP packets, and are forwarded to the foreign agent. In this way, the mobile RLAN terminal can be used at the home network. Because mobile IP works on the Internet, communication cost is low even for international communication.

However, the following are its restrictions:

- additional software is necessary on mobile RLAN terminals;
- only TCP/IP is available;
- it is unavailable for networks with private IP addresses.

2.4 VLAN

Recent advances in VLAN allow us to construct subnetworks or LAN segments independent of physical network topology, by using switching hubs, ATM switches, or routers. The main purpose of VLAN is to adopt the following independently of the physical locations:

- unified administration;
- security;
- private IP address or multi-protocol;
- broadcast.

Some of them allow us to construct wide area VLANs, which are also called Internet VPNs [IETF, 1994b]. The wide area VLAN is a very recent technique and the standardization works are now under study in the IETF. In this technique, VLAN functions are necessary on remote network routers, or mobile RLAN terminals themselves.

When the function is on a router, advance registration is necessary. This means that access to Intranet is available only in limited remote networks. When the function is on a mobile RLAN terminal, additional software is necessary.

2.5 Mobile VLAN

Among the various mobile environment requirements, the mobile VLAN technique was developed to support the following features:

- low-cost communication;
- no operation for connection at the RLAN terminal;
- multi-protocol, private IP address;
- ubiquitous communication;
- high security.

In mobile VLAN, the MAC frame transmitted by a mobile RLAN terminal moves to a remote network. Next, it is encapsulated into an IP packet by the server at the remote network. The IP packet is then transferred to its home network (MAC over IP). Then the server at the home network de-encapsulates the received IP packet to the original MAC frame. Therefore, the mobile RLAN terminal can use the home network environment at the remote network.

Mobile VLAN has such functions as terminal location registration, address resolution, authentication, and recognition of disconnection. In order to connect with no operation at the RLAN terminal, all of these functions are performed on the network side.

3 Evaluation

Table 5 summarizes the serviceability of the techniques mentioned above. The mobile VLAN realizes low-cost communication, connection with no operation at a RLAN terminal, support for multi-protocols, and ubiquitous communication without losing other technical advantages.

Appendix 1 to Annex 3 outlines the mobile VLAN system, which is considered most promising to support RLAN terminal mobility.

TABLE 5

Comparison of the mobility support techniques

	Mobile VLAN	Dial-up connection	DHCP	Mobile IP	Wide area VLAN (in router)
Transport network	Internet	PSTN ISDN	Internet	Internet	Internet
Communication cost	Low	High	Low	Low	Low
Network interface modification	No	Yes	No	No	No
Network address modification	No	No	Yes	No	No
Additional software on terminal	No	Yes	Yes	Yes	No
Multi-protocol	Available	Unavailable	Unavailable	Unavailable	Available
Private IP address	Available	Available	Unavailable	Unavailable	Available
Ubiquitous communication	Available	Available	Available	Available	Unavailable

References

- IETF [1993] Dynamic Host Configuration Protocol, RFC1541, 1531. Internet Engineering Task Force (IETF).
- IETF [1994a] The Point-to-Point Protocol, RFC1661, 1548. Internet Engineering Task Force.
- IETF [1994b] Generic Routing Encapsulation, RFC1701. Internet Engineering Task Force.
- IETF [1996] INTERNET draft. IP Mobility Support Rev.17. Internet Engineering Task Force.

Appendix 1 to Annex 3

Outline of mobile VLAN system

1 System composition

The functions needed for the mobile VLAN techniques are address resolution, terminal authentication, location registration for recognition of disconnection, and MAC frame encapsulation/de-encapsulation. The first two factors, i.e. address resolution and terminal authentication, are necessary over the entire network. The location registration function is required only in remote networks. The MAC frame encapsulation/de-encapsulation is necessary in both home networks and remote networks. Consequently, the usage of three kinds of servers may be proposed: the management server (MS), the home server (HS), and the client server (CS), as shown in Fig. 6. One MS serves the whole network. It manages terminal authentication data and terminal location data, and resolves addresses. One HS is located in one home network, where it encapsulates and forwards MAC frames for mobile terminals. One CS is located in one remote network, where it recognizes mobile terminals, requests terminal authentication to the MS, establishes connection to the HS, and encapsulates MAC frames.

FIGURE 6
System composition of mobile VLAN

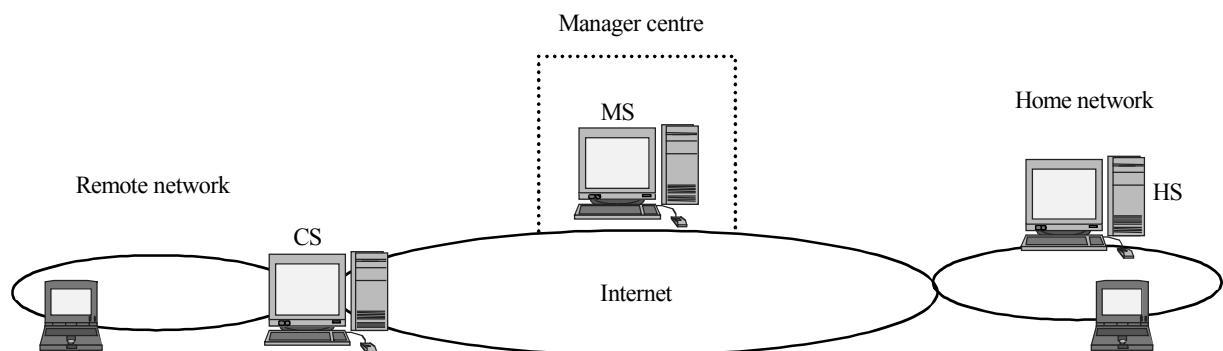

1450-06

2 Major techniques of mobile VLAN

In this section, the major techniques of mobile VLAN are introduced based on sequence charts.

2.1 Terminal authentication, location registration, connection

MAC addresses and the corresponding HS IP addresses have to be registered in advance in the MS. IP addresses of all HSs and CSs are also registered. TCP connections to all HSs and CSs are established. The mobile terminal can be connected to remote networks that are connected to the CSs. After connection, when the terminal sends a packet, e.g. an ARP, the CS captures the packet as a MAC frame. The CS sends the source MAC address to the MS, and the MS authenticates that the terminal is from the corresponding home network.

Upon authentication, the MS registers the terminal location to itself, and notifies the CS and corresponding HS of terminal movement. Then, the CS establishes a TCP connection for MAC frame forwarding to the HS.

Because the destination HS differs depending on the source address of the MAC frame, a CS can belong to many HSs.

FIGURE 7
Sequence chart for terminal authentication, location registration, and connection

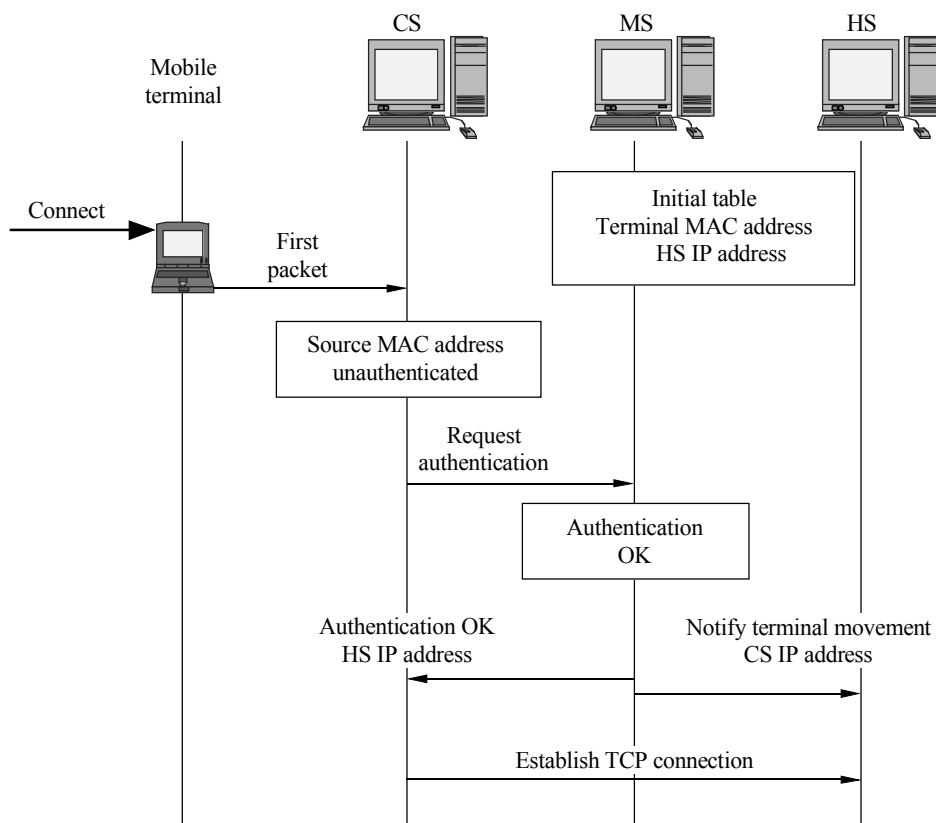

1450-07

2.2 Encapsulation/de-encapsulation

After TCP connection is established, the CS captures MAC frames with source MAC address of the mobile terminal, and the HS captures MAC frames with destination MAC address of the mobile terminal. Then they encapsulate MAC frames into IP packets. If they receive encapsulated MAC frames via the TCP connection, they de-encapsulate them and transmit extracted MAC frames to the LAN. If a MAC frame for another mobile terminal is captured, they encapsulate it again and send it to the corresponding CS. In this way, many CSs can belong to one HS.

FIGURE 8
Sequence chart for encapsulation/de-encapsulation

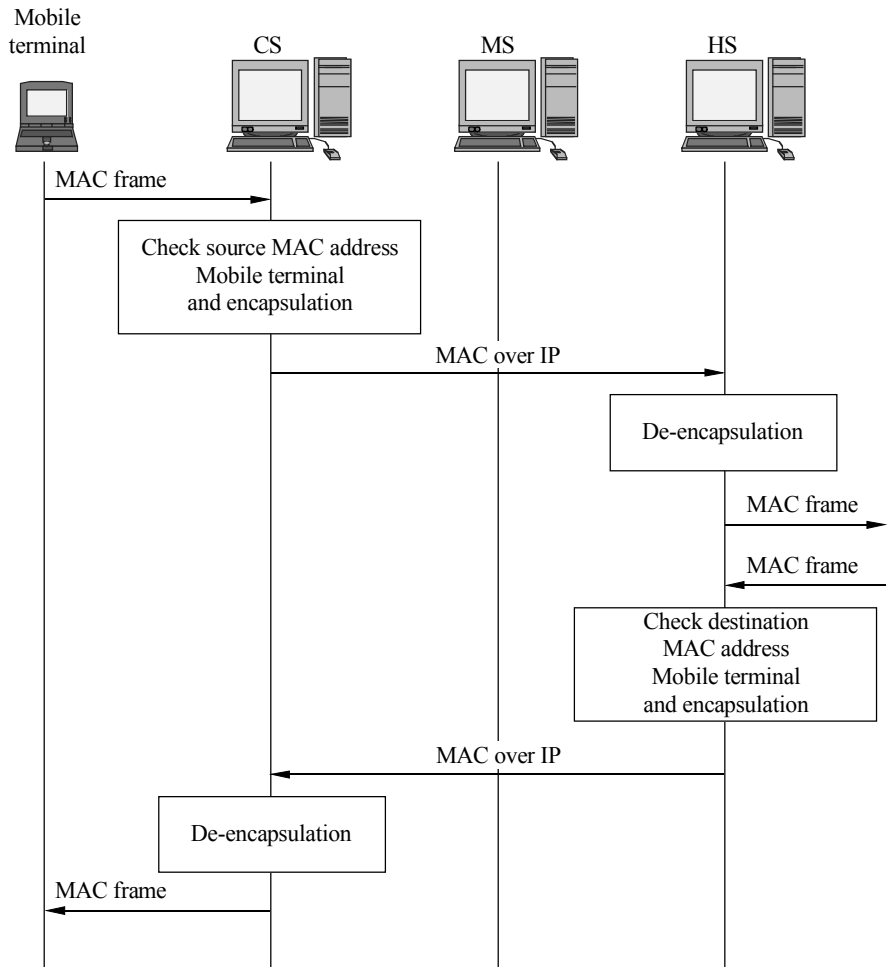

1450-08

2.3 Recognition of terminal disconnection

The CS has a timer, and if reception of MAC frames from the mobile terminal stops for a certain period, it recognizes this as disconnection.

FIGURE 9
Sequence chart for terminal disconnection

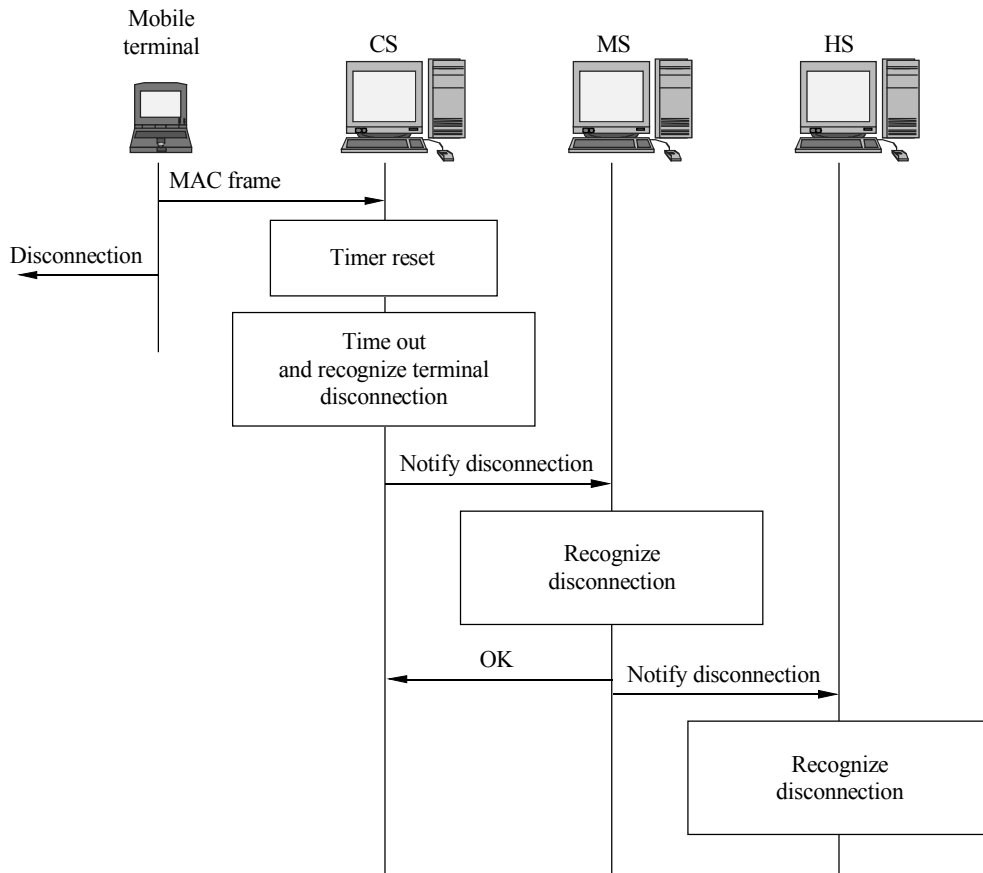

1450-09