

## RECOMMENDATION ITU-R F.595-7

**Radio-frequency channel arrangements for radio-relay systems  
operating in the 18 GHz frequency band**

(Question ITU-R 108/9)

(1982-1986-1990-1992-1995-1997-1999-2002)

The ITU Radiocommunication Assembly,

*considering*

- a) that there may be economic and operational advantages in the use of radio-relay systems for the transmission of digital signals in the frequency band 17.7 to 19.7 GHz;
- b) that it may be desirable to interconnect such systems at radio frequencies on international circuits;
- c) that a sufficient degree of compatibility between systems of different capacities should be assured,

*recommends*

**1** that the preferred radio-frequency (RF) channel arrangement for digital radio-relay systems with a capacity of the order of 280 Mbit/s, the order of 140 Mbit/s and 34 Mbit/s or synchronous digital hierarchy bit rates operating in the 17.7 to 19.7 GHz band should be derived as follows:

Let  $f_0$  be the frequency of the centre of the band of frequencies occupied (MHz),

$f_n$  be the centre frequency of a RF channel in the lower half of the band (MHz),

$f'_n$  be the centre frequency of a RF channel in the upper half of the band (MHz),

then the frequencies (MHz) of individual channels are expressed by the following relationships:

### 1.1 Co-channel arrangement

1.1.1 for systems with a capacity of the order of 280 Mbit/s:

lower half of the band:  $f_n = f_0 - 1110 + 220n$  MHz

upper half of the band:  $f'_n = f_0 + 10 + 220n$  MHz

where:

$n = 1, 2, 3$  or  $4$ .

The frequency arrangement is illustrated in Fig. 1a).

**1.1.2** for systems with a capacity of the order of 140 Mbit/s:

$$\text{lower half of the band: } f_n = f_0 - 1\,000 + 110 n \quad \text{MHz}$$

$$\text{upper half of the band: } f'_n = f_0 + 10 + 110 n \quad \text{MHz}$$

where:

$$n = 1, 2, 3, 4, 5, 6, 7 \text{ or } 8.$$

The frequency arrangement is illustrated in Fig. 1b).

**1.1.3** for systems with a capacity of the order of 34 Mbit/s:

$$\text{lower half of the band: } f_n = f_0 - 1\,000 + 27.5 n \quad \text{MHz}$$

$$\text{upper half of the band: } f'_n = f_0 + 10 + 27.5 n \quad \text{MHz}$$

where:

$$n = 1, 2, 3, \dots 35.$$

The frequency arrangement is illustrated in Fig. 1c).

**1.1.4** for systems with a capacity of the order of 140 Mbit/s or STM-1 with multi-state modulation formats:

$$\text{lower half of the band: } f_n = f_0 - 1\,000 + 55 n \quad \text{MHz}$$

$$\text{upper half of the band: } f'_n = f_0 + 10 + 55 n \quad \text{MHz}$$

where:

$$n = 1, 2, 3, \dots 17.$$

The frequency arrangement is illustrated in Fig. 1d).

## **1.2 Interleaved arrangement**

**1.2.1** for systems with a capacity of the order of 280 Mbit/s:

$$\text{lower half of the band: } f_n = f_0 - 1\,000 + 110 n \quad \text{MHz}$$

$$\text{upper half of the band: } f'_n = f_0 + 120 + 110 n \quad \text{MHz}$$

where:

$$n = 1, 2, 3, 4, 5, 6 \text{ or } 7.$$

The frequency arrangement is illustrated in Fig. 2a).

**1.2.2** for systems with a capacity of the order of 140 Mbit/s:

$$\text{lower half of the band: } f_n = f_0 - 945 + 55 n \quad \text{MHz}$$

$$\text{upper half of the band: } f'_n = f_0 + 65 + 55 n \quad \text{MHz}$$

where:

$$n = 1, 2, 3, \dots 15.$$

The frequency arrangement is illustrated in Fig. 2b):

FIGURE 1  
**Radio-frequency channel arrangement for radio-relay systems**  
 operating in the 17.7 to 19.7 GHz band  
 (Co-channel arrangement)  
 (All frequencies in MHz)

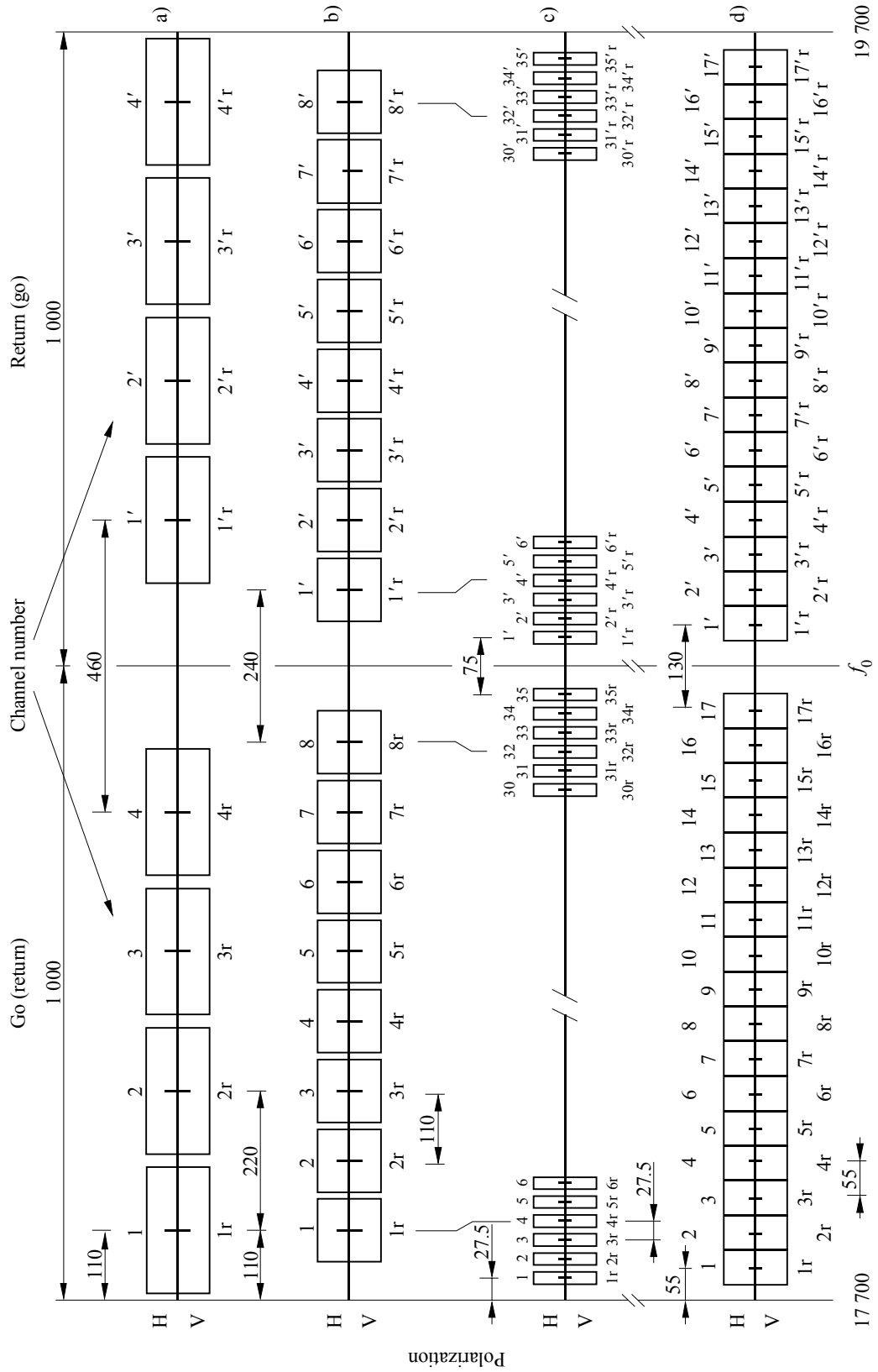

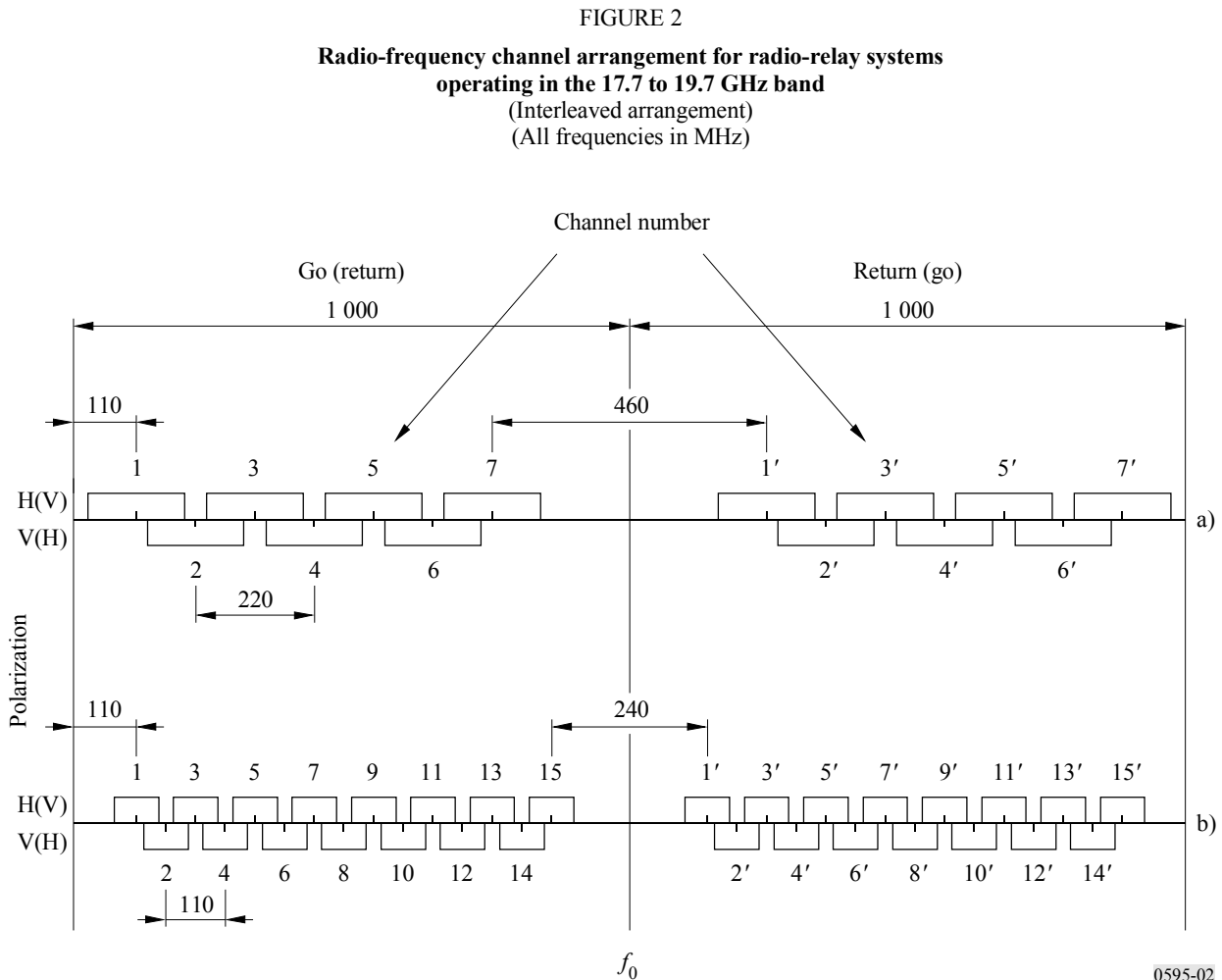

2 that the preferred RF channel arrangement for digital radio-relay systems with a capacity of 155 Mbit/s for use in the synchronous digital hierarchy shall be as given in § 1.1.2 (co-channel arrangement) and § 1.2.2 (alternated channel arrangement) for systems using QPSK-like modulation.

While for systems using 16-QAM-like modulation the RF channel arrangement shown in Fig. 1d) is preferred for co-channel operation.

The frequencies of channels 2, 3, 4, . . . 16 in Fig. 1d) are the same as the centre frequencies in § 1.2.2 for channels 1, 2, 3, . . . 15 respectively.

Channels 1 and 17 in Fig. 1d) are allocated 55 MHz below channel 2 and above channel 16 respectively;

3 that, in the section through which an international connection is arranged to pass, all the go channels should be in one half of the band and all the return channels should be in the other half of the band;

4 that both horizontal and vertical polarizations should be used for each RF channel in the co-channel arrangement;

5 that the centre frequency  $f_0$  is 18 700 MHz;

6 that for low capacity digital systems, i.e. below about 10 Mbit/s, frequency allocations may be accommodated within any of the high-capacity channels or guardbands as shown by Annex 3 and 5. Channels 1, 1' and 8, 8' of Fig. 1b) or channels 1, 1' and 17, 17' of Fig. 1d) and the

guardbands are the most suitable choice for sub-band allocations for such low capacity utilizations, however, when more band is required, the adjacent channels may be used as shown by the example in Annex 5 where also channels 2, 2' of Fig. 1d) are assigned to low capacity use. The selection of alternative allocations should not prevent the pairing of the go and return channels in the manner described in Figs. 1 and 2;

7 that for medium-capacity systems with bit rates different from that given in § 1.1.3 above and for low capacity systems, administrations may adopt other RF channel arrangements in conformity with the recommended pattern for high-capacity systems (see Annex 4);

8 that due regard be taken of the fact that in some countries another arrangement of the go and return channels which incorporates a mid-band allocation for low capacity systems may be used, as shown in Fig. 3;

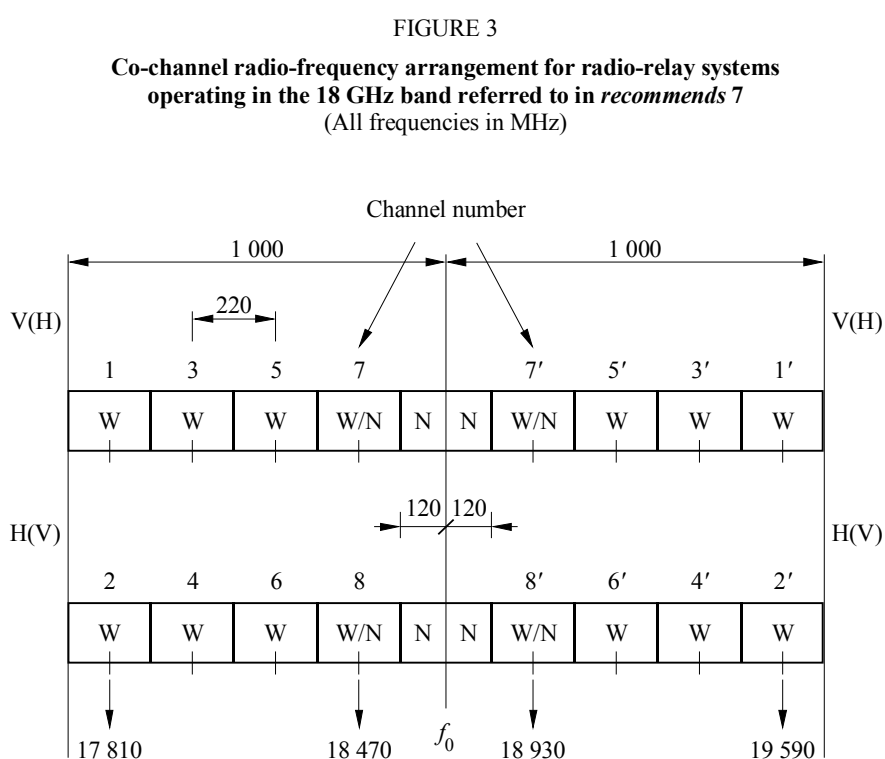

W : wideband channel (high-capacity of the order of 280 Mbit/s)  
N : narrow-band channel (small-capacity, below 10 Mbit/s)  
W/N : wideband or narrow-band channel

0595-03

9 that due regard be taken of the fact that in the countries where the band 17.7 to 21.2 GHz is available for the fixed service other channel arrangements may be used (see Annex 1);

10 that due regard be taken of the fact that in some countries the band 17.7 to 19.7 GHz is subdivided to serve different applications in separate parts of the band (see Annex 2) or is used for low capacity systems (see Annex 3) with different go-return and channel spacings;

11 that due regard be taken of the fact that in one country, another channel arrangement is used (see Annex 6);

**12** that if multi-carrier transmission (Note 3) is employed the overall number of  $n$  carriers will occupy a single channel the centre frequency and channel spacing of which will be that defined according to Figs. 1 and 2, disregarding the actual centre frequencies of the individual carriers, which may vary, for technical reasons according to practical implementations.

NOTE 1 – In establishing these systems, account should be taken of the primary allocation to the Earth exploration-satellite service (passive) in the band 18.6 to 18.8 GHz, the provisions of No. 5.522A of the Radio Regulations and the need to protect passive sensors in this band.

NOTE 2 – Actual gross bit rates may be as much as 5% or more higher than net transmission rates.

NOTE 3 – A multi-carrier system is a system with  $n$  (where  $n > 1$ ) digitally modulated carrier signals simultaneously transmitted (or received) by the same RF equipment.

## ANNEX 1

### Description of a RF channel arrangement in the band 17.7 to 21.2 GHz referred to in *recommends 9*

#### 1 Introduction

In Japan, the frequency band between 17.7 and 19.7 GHz is used contiguously with the 19.7 to 21.2 GHz band for radio-relay systems having a transmission capacity of about 400 Mbit/s.

#### 2 RF channel arrangements

The RF channel arrangements shown in Fig. 4 occupy a band of 3.5 GHz and provide for 9 go-and-return RF channels.

The normalized values of  $X$ ,  $Y$ ,  $Z$  with respect to the digital symbol rate  $S$  are:

$$X = 1.6 \qquad Y = 3.1 \qquad Z = 0.8$$

where:

$XS$ : separation between the centre frequencies of adjacent RF channels on the same plane of polarization in the same direction of transmission

$YS$ : frequency separation between the centre frequencies of the go and return channels which are nearest to each other

$ZS$ : frequency separation between the centre frequencies of the outermost RF channels and the edge of the frequency band.

FIGURE 4  
**Radio-frequency channel arrangements for digital radio-relay systems  
operating in the 17.7 to 21.2 GHz band (Japan)**  
(All frequencies in MHz)

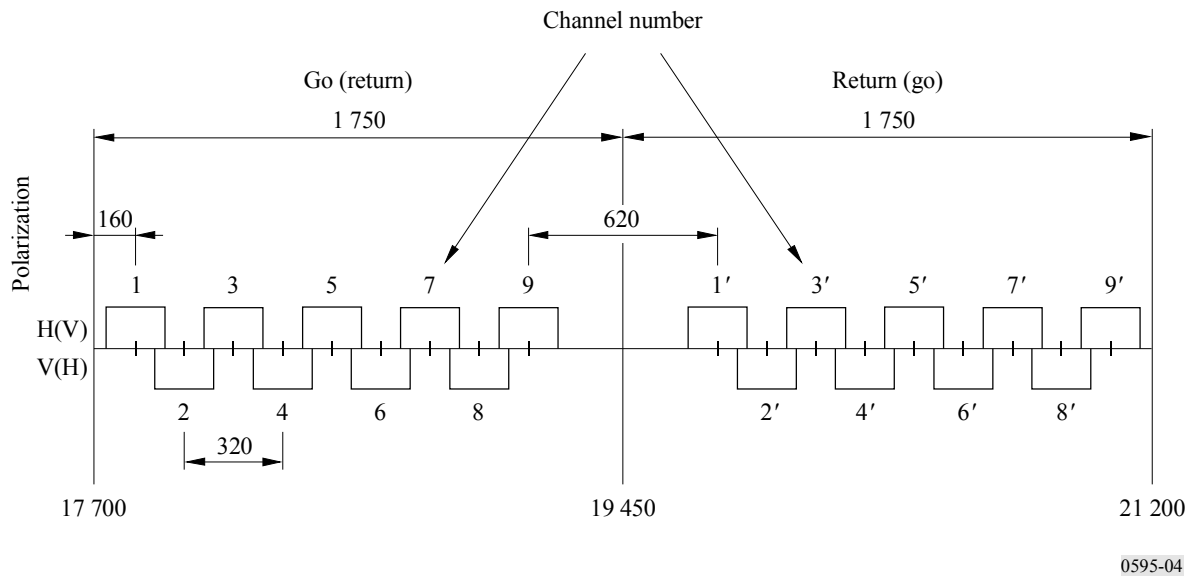

### 3 System parameters

Transmission capacity of about 400 Mbit/s (5 760 telephone channels) per RF channel is achieved by using QPSK modulation. The system operates with a receiver noise figure of 8 dB, a transmitter output power of 22 dBm and an antenna of 1.8 m diameter. The typical repeater spacing is about 3 km, dependant on the precipitation conditions along the route. The system is also used for broadband non-telephone services e.g. picture and data communications in urban areas and also for long-distance circuits.

## ANNEX 2

### **Description of a RF channel arrangement in the band 17.7 to 19.7 GHz referred to in *recommends 10***

In North America this band was initially used for high-capacity digital transmission and then for small-capacity digital transmission systems. Usage has been extended to intermediate transmission capacities. More recently, new requirements have been put forward for this band by other services that originally used lower frequencies. The extent and variety of existing and identified future operational requirements have resulted in subdivision of the 17.7 to 19.7 GHz band in North America.

The multi-service requirements are met by assigning separate bands to the major different service categories and by allowing for various RF channel widths to simultaneously increase usage versatility and spectral efficiency. The resulting composite RF channel arrangement is illustrated in Fig. 5.

FIGURE 5

**Radio-frequency channel arrangements for digital and analogue radio-relay systems  
in the 17.7 to 19.7 GHz band (North America)**  
(All frequencies in MHz)

220 MHz (T)		220 MHz (R)						220 MHz (R)	
WB (T)	6 MHz (T)	6 MHz (R)	NB (T)	DTS (T)	NB (R)	DTS (R)	WB (R)		
17 700	18 140	18 360	18 580	18 820	18 920	19 160	19 260	19 700	

220 MHz: 220 MHz channels

WB: 10, 20, 40 and 80 MHz "wideband" channels

NB: 5, 10 and 20 MHz "narrow-band" channels

DTS: 10 MHz digital termination system channels which may be sub-divided

6 MHz: 6 MHz channels for cable TV radio-relay systems

(T): transmit frequencies: go (return)

(R): receive frequencies: return (go)

0595-05

The versatility of this RF channel arrangement is exemplified by the overlap between the various WB, NB and DTS channel bandwidths, and by the common transmit-receive frequency spacings for the adjacent NB and DTS services.

NOTE 1 – In the United States of America, the channels in the band 18.58-19.3 GHz are no longer available for new FS stations.

## ANNEX 3

### Description of a RF channel arrangement in the band 17.7 to 19.7 GHz referred to in *recommends 10*

In the United Kingdom, this band is used primarily for low capacity equipment, in accordance with the following plan:

$$\text{lower half of the band: } f_n = f_0 - 981.25 + 3.5 n \quad \text{MHz}$$

$$\text{upper half of the band: } f'_n = f_0 + 26.75 + 3.5 n \quad \text{MHz}$$

where:

$$f_0 = 18\,700 \text{ MHz}$$

$$n = 1, 2, 3, \dots 272.$$



FIGURE 6  
**Radio-frequency channel arrangement for low capacity radio-relay systems operating in the 18 GHz band (United Kingdom)**  
 (All frequencies in MHz)

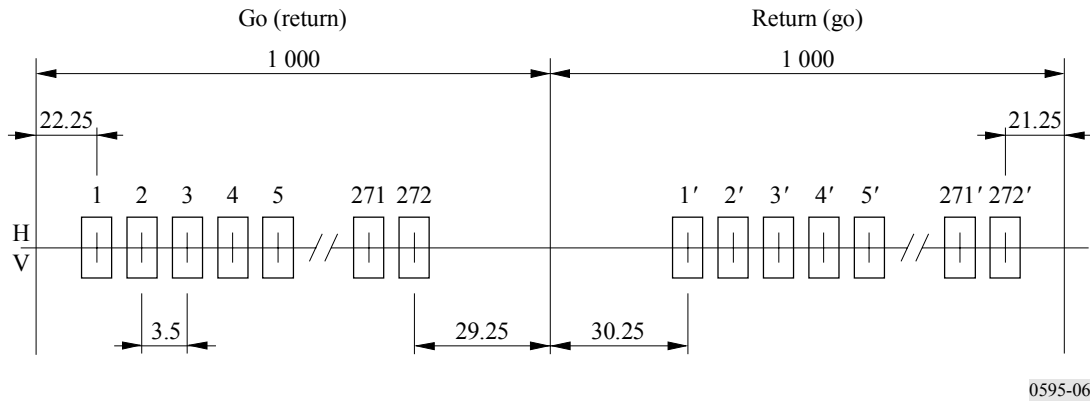

ANNEX 4

**Description of two RF channel arrangements for medium capacity radio-relay systems with 13.75 MHz channel spacing in co-channel arrangement (Fig. 7a) and with 27.5 MHz channel spacing in interleaved channel arrangement (Fig. 7b) and an example of co-channel arrangements for low capacity radio-relay systems in (Fig. 8) referred to in *recommends 7***

The channel arrangements are in accordance with the following plans:

*Co-channel arrangement* (Fig. 7a):

$$\text{lower half of the band: } f_n = f_0 - 1\,000 + 13.75 n \quad \text{MHz}$$

$$\text{upper half of the band: } f'_n = f_0 + 10 + 13.75 n \quad \text{MHz}$$

where:

$$n = 1, 2, 3, \dots 70.$$

*Interleaved channel arrangement* (Fig. 7b):

$$\text{lower half of the band: } f_n = f_0 - 986.25 + 13.75 n \quad \text{MHz}$$

$$\text{upper half of the band: } f'_n = f_0 + 23.75 + 13.75 n \quad \text{MHz}$$

where:

$$n = 1, 2, 3, \dots 69.$$

FIGURE 7a  
**Radio-frequency channel arrangement for medium capacity radio-relay systems with 13.75 MHz channel spacing in co-channel arrangement**  
 (All frequencies in MHz)

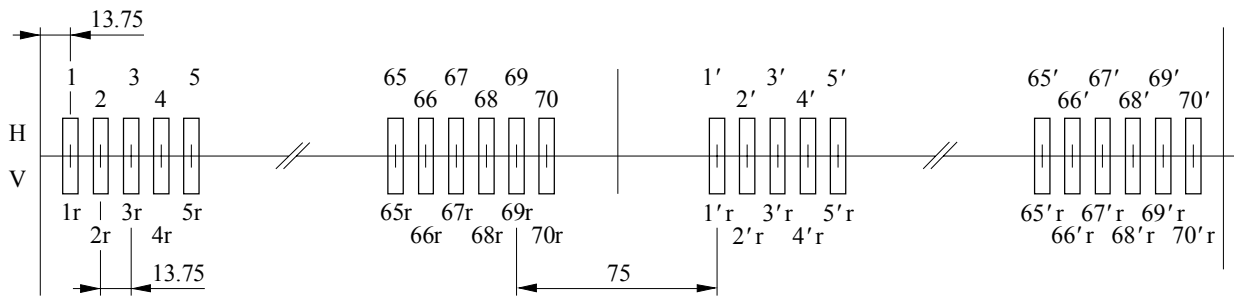

FIGURE 7b  
**Radio-frequency channel arrangement for medium capacity radio-relay systems with 27.5 MHz channel spacing in interleaved channel arrangement**  
 (All frequencies in MHz)

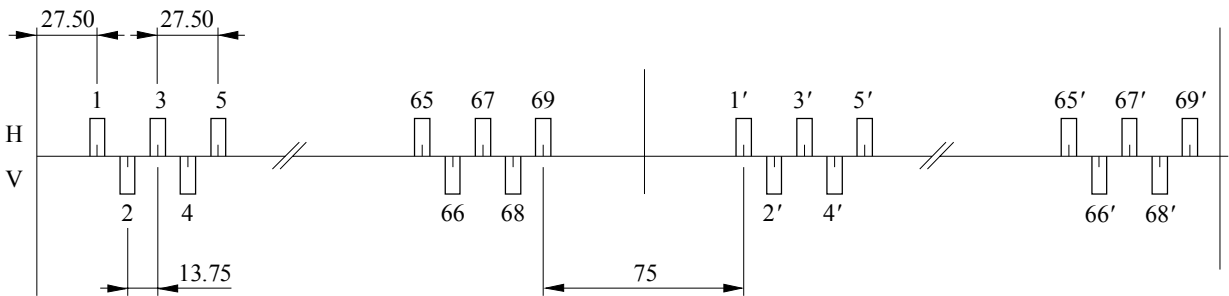
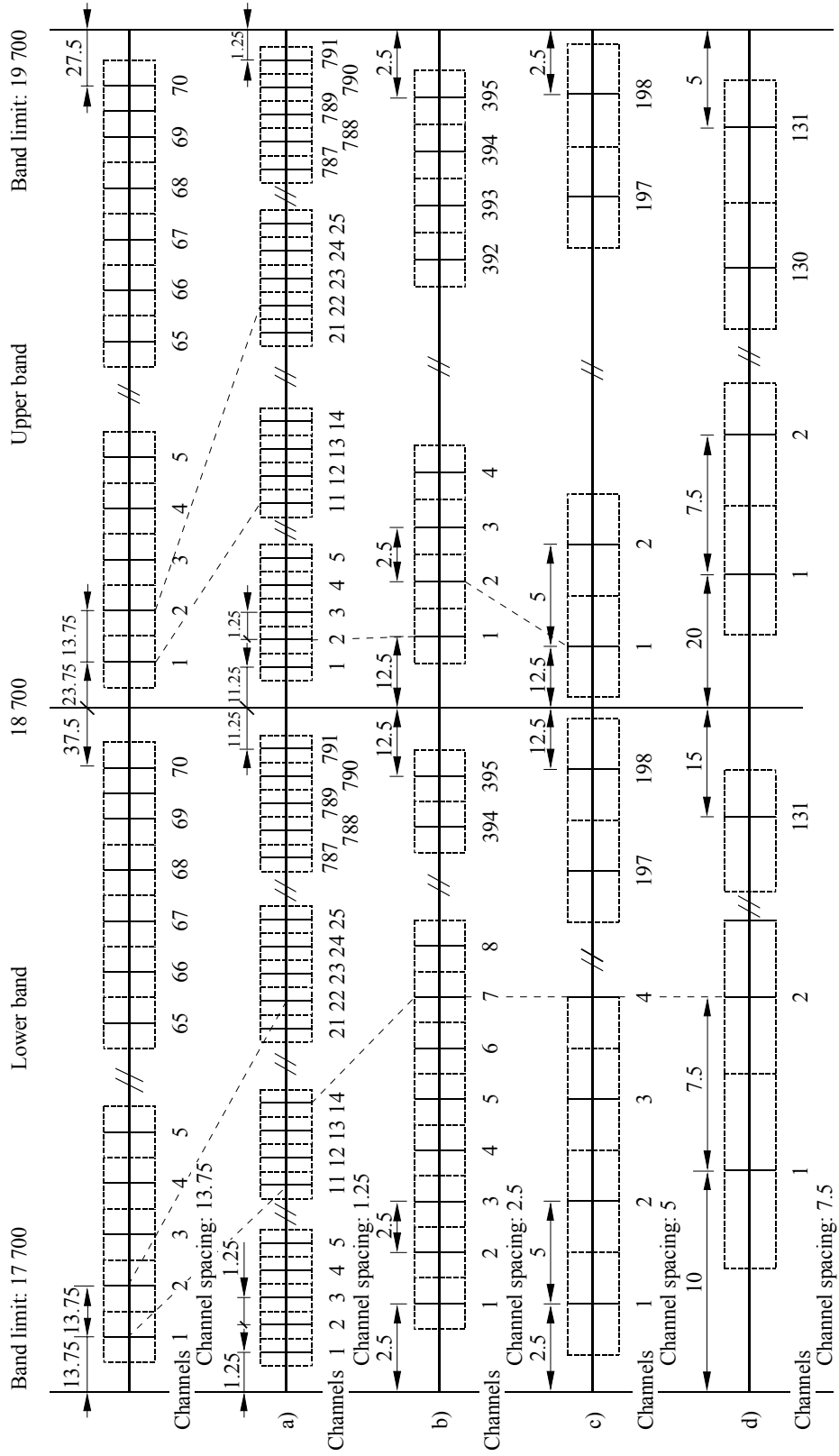

FIGURE 8  
**Radio-frequency co-channel arrangements for low capacity digital radio-relay systems as used in Germany derived from 13.75 MHz channel spacing**  
 (All frequencies in MHz)



0595-08

In Germany the RF co-channel arrangements for channel spacings of 1.25, 2.5, 5 and 7.5 MHz are used as follows:

according to Fig. 8a):

$$\text{lower half of the band: } f_n = f_0 - 1\,000 + 1.25 n \quad \text{MHz}$$

$$\text{upper half of the band: } f'_n = f_0 + 10 + 1.25 n \quad \text{MHz}$$

where:

$$n = 1, 2, 3, \dots 791;$$

according to Fig. 8b):

$$\text{lower half of the band: } f_n = f_0 - 1\,000 + 2.5 n \quad \text{MHz}$$

$$\text{upper half of the band: } f'_n = f_0 + 10 + 2.5 n \quad \text{MHz}$$

where:

$$n = 1, 2, 3, \dots 395;$$

according to Fig. 8c):

$$\text{lower half of the band: } f_n = f_0 - 1\,002.5 + 5 n \quad \text{MHz}$$

$$\text{upper half of the band: } f'_n = f_0 + 7.5 + 5 n \quad \text{MHz}$$

where:

$$n = 1, 2, 3, \dots 198;$$

according to Fig. 8d):

$$\text{lower half of the band: } f_n = f_0 - 997.5 + 7.5 n \quad \text{MHz}$$

$$\text{upper half of the band: } f'_n = f_0 + 12.5 + 7.5 n \quad \text{MHz}$$

where:

$$n = 1, 2, 3, \dots 131.$$

## ANNEX 5

### **Description of a RF channel arrangement for low capacity digital fixed wireless systems (FWS) obtained by the sub-division of high capacity channels in the band 17.7 to 19.7 GHz referred to in *recommends 6***

In Italy a mixed usage of high, medium and low capacity digital FWS is envisaged; the frequency channel arrangements of *recommends 1.1.3* and *1.1.4* are used for medium and high capacity systems, respectively.

For low capacity systems, the high capacity channels 1, 1' and 2, 2' are subdivided on a 1.75, 3.5 and 7 MHz basis together with the adjacent guardbands, following the rule for the centre frequencies reported below:

a) For systems requiring channel spacing of 7 MHz, the channel centre frequencies are given by:

$$\text{lower half of the band: } f_n = f_0 - 997 + 7n \quad \text{MHz}$$

$$\text{upper half of the band: } f'_n = f_0 + 13 + 7n \quad \text{MHz}$$

where:

$$n = 1, 2, 3, \dots 18.$$

b) For systems requiring channel spacing of 3.5 MHz the channel centre frequencies are given by:

$$\text{lower half of the band: } f_n = f_0 - 998.75 + 3.5n \quad \text{MHz}$$

$$\text{upper half of the band: } f'_n = f_0 + 11.25 + 3.5n \quad \text{MHz}$$

where:

$$n = 1, 2, 3, \dots 37.$$

c) For systems requiring channel spacing of 1.75 MHz the channel centre frequencies are given by:

$$\text{lower half of the band: } f_n = f_0 - 997.875 + 1.75n \quad \text{MHz}$$

$$\text{upper half of the band: } f'_n = f_0 + 12.125 + 1.75n \quad \text{MHz}$$

where:

$$n = 1, 2, 3, \dots 74.$$

In areas where interference from other services, sharing the same band, do not allow the use of part of the above channels, the high capacity channels 3, 3' and 4, 4' may alternatively be subdivided, creating 1.75, 3.5 and 7 MHz channels, which centre frequencies are given by the same formulas with the values of  $n$  expanded as follows:

$$n = 19, 20, 21, \dots 33 \quad (7 \text{ MHz channels})$$

$$n = 38, 39, 40, \dots 68 \quad (3.5 \text{ MHz channels})$$

$$n = 75, 76, 77, \dots 136 \quad (1.75 \text{ MHz channels})$$

Figure 9 shows graphically the subdivision of channels 1, 1' and 2, 2'.

FIGURE 9  
**Radio-frequency channel arrangement for low capacity fixed wireless systems (co-channel arrangement).**  
**Example of subdivision of the first two 55 MHz channels, 1' and 2',**  
**and of the guardband according to *recommendations 6***  
 (All frequencies in MHz)

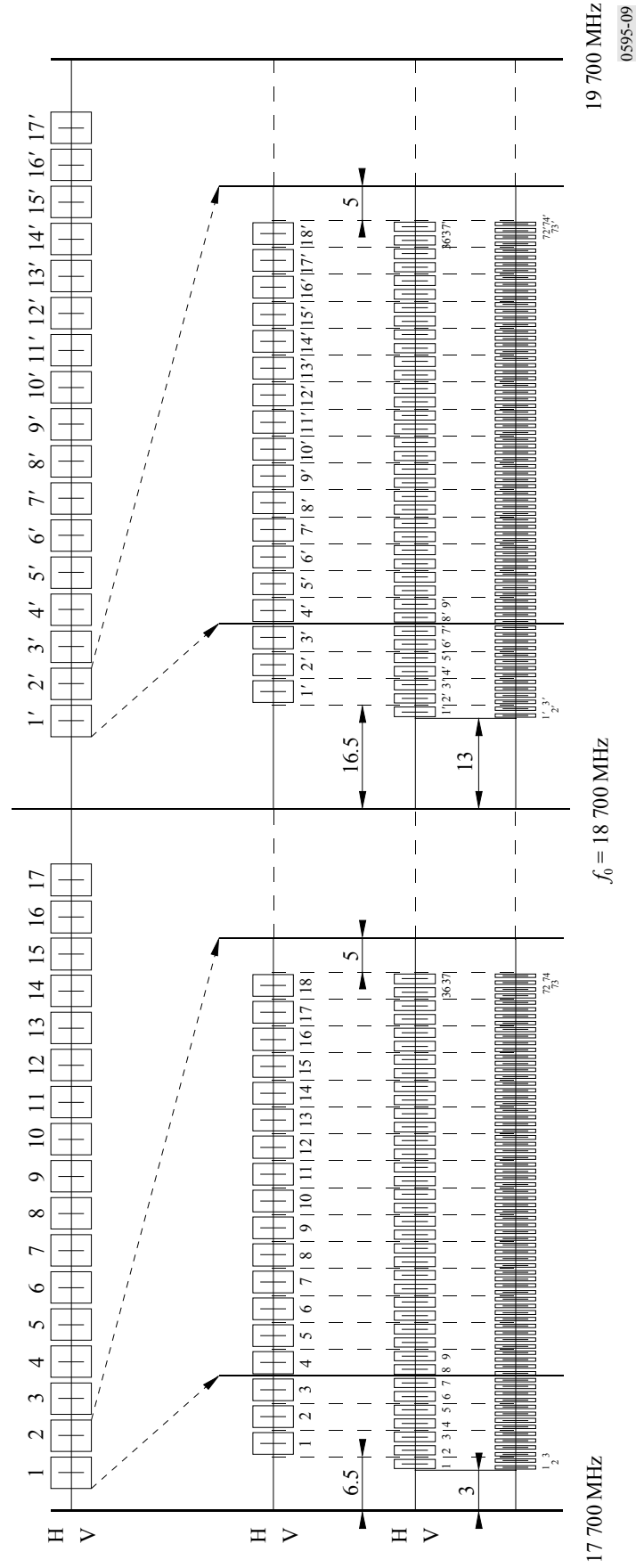

## ANNEX 6

**Description of a RF channel arrangement in the band 17.7-19.7 GHz  
referred to in *recommends 11***

The following arrangement is planned to be implemented by Indonesia.

Let  $f_0$  be the middle of the band 17.7-19.7 GHz, i.e.  $f_0 = 18\,700$  MHz,

$f_n$  be the middle frequency of the radio-frequency channel in the lower half of the 17.7-19.7 GHz band,

$f'_n$  be the middle frequency of the radio-frequency channel in the upper half of the 17.7-19.7 GHz band,

then the frequencies (MHz) of individual channels are expressed by the following relationships:

*Co-channel arrangement*

a) for systems with a carrier spacing of 110 MHz:

$$\text{lower half of the band: } f_n = f_0 - 450 + 110 n$$

$$\text{upper half of the band: } f'_n = f_0 + 560 + 110 n$$

where:

$$n = 1, \dots, 3$$

– Tx/Rx separation band (in the frequency division duplex (FDD) mode) = 1 010 MHz

$$\text{lower half of the band: } f_n = f_0 - 1\,110 + 110 n$$

$$\text{upper half of the band: } f'_n = f_0 - 495 + 110 n$$

where:

$$n = 4$$

– Tx/Rx separation band (in the FDD mode) = 615 MHz

$$\text{lower half of the band: } f_n = f_0 - 1\,495 + 110 n$$

$$\text{upper half of the band: } f'_n = f_0 - 1\,010 + 110 n$$

where:

$$n = 5, 6$$

– Tx/Rx separation band (in the FDD mode) = 485 MHz

b) for systems with a carrier spacing of 55 MHz:

$$\text{lower half of the band: } f_n = f_0 - 422.5 + 55 n$$

$$\text{upper half of the band: } f'_n = f_0 + 587.5 + 55 n$$

where:

$$n = 1, \dots, 6$$

– Tx/Rx separation band (in the FDD mode) = 1 010 MHz

$$\text{lower half of the band: } f_n = f_0 - 1\,082.5 + 55 n$$

$$\text{upper half of the band: } f'_n = f_0 - 467.5 + 55 n$$

where:

$$n = 7, 8$$

– Tx/Rx separation band (in the FDD mode) = 615 MHz

lower half of the band:  $f_n = f_0 - 1\,467.5 + 55 n$

upper half of the band:  $f'_n = f_0 - 982.5 + 55 n$

where:

$$n = 9, \dots, 12$$

– Tx/Rx separation band (in the FDD mode) = 485 MHz

lower half of the band:  $f_n = f_0 - 752.5 + 55 n$

upper half of the band:  $f'_n = f_0 + 257.5 + 55 n$

where:

$$n = 13$$

– Tx/Rx separation band (in the FDD mode) = 1 010 MHz

FIGURE 10  
Channelization plan for the 17.7-19.7 GHz band of Annex 6

