

RECOMMENDATION ITU-R BT.709-4

**PARAMETER VALUES FOR THE HDTV STANDARDS FOR PRODUCTION
AND INTERNATIONAL PROGRAMME EXCHANGE**

(Question ITU-R 27/11)

(1990-1994-1995-1998-2000)

The ITU Radiocommunication Assembly,

considering

- a) that, for many years, HDTV programmes has been produced in several countries;
- b) that parameter values for HDTV production standards should have maximum commonality;
- c) that two HDTV scanning standards, 1125/60/2:1 and 1250/50/2:1, were previously developed for that purpose, having a significant number of parameters which have been agreed on a worldwide basis, and for which some equipment remains in use;
- d) that a HDTV common image format of 1920 pixels by 1080 lines providing square pixel sampling and a number of interlace and progressive picture rates has been designed for digital television, computer imagery and other applications (in this Recommendation, the term pixel is used to describe a picture element in the digital domain);
- e) that the parameters defined for all these systems meet the quality goals set for HDTV;
- f) that film productions are an important programme source for HDTV broadcasting, and conversely that the use of HDTV production systems has significant benefits for film programme production;
- g) that high-quality conversion between the various HDTV systems, as well as down-conversion to 525/625 television systems, has been successfully implemented;
- h) that programmes produced and archived will not become obsolete using these standards,

recommends

- 1** that for HDTV programme production and international exchange, one of the systems described in Parts 1 or 2 of this Recommendation, should be used;
- 2** that for new HDTV programme production and international exchange, systems described in Part 2 are preferred.

**Signal parameter values for the 1125/60/2:1 system
and the 1250/50/2:1 system**

PART 1

HDTV systems related to conventional television

(The areas in bold characters in the Tables below denote parameter values which have been agreed to on a worldwide basis.)

1 Opto-electronic conversion

Item	Parameter	Value	
		1125/60/2:1	1250/50/2:1
1.1	Opto-electronic transfer characteristics before non-linear precorrection	Assumed linear	
1.2	Overall opto-electronic transfer characteristics at source	$V = 1.099 L^{0.45} - 0.099$ for $1 \geq L \geq 0.018$ $V = 4.500 L$ for $0.018 > L \geq 0$ where: L : luminance of the image $0 \leq L \leq 1$ V : corresponding electrical signal	
1.3	Chromaticity coordinates (CIE, 1931)	x	y
	Primary		
	<ul style="list-style-type: none"> - Red (R) - Green (G) - Blue (B) 	0.640 0.300 0.150	0.330 0.600 0.060
1.4	Assumed chromaticity for equal primary signals	D_{65}	
	(Reference white)	x	y
	$E_R = E_G = E_B$	0.3127	0.3290

2 Picture characteristics

Item	Parameter	Value	
		1125/60/2:1	1250/50/2:1
2.1	Aspect ratio	16:9	
2.2	Sample per active line	1920	
2.3	Sampling lattice	Orthogonal	
2.4	Active lines per picture	1035	1152

3 Picture scanning characteristics

Item	Parameter	Value	
		1125/60/2:1	1250/50/2:1
3.1	Order of sample scanning	Left to right, top to bottom 1st line of field 1 above 1st line of field 2	
3.2	Interlace ratio	2:1	
3.3	Picture rate (Hz)	30	25
3.4	Total number of lines	1125	1250
3.5	Field frequency (Hz)	60	50
3.6	Line frequency (Hz)	$33\,750 \pm 0.001\%$	$31\,250 \pm 0.0001\%$

4 Signal format

The terms R , G , B , Y , C_B , C_R , are often used and are generally understood to refer to the signals E'_R , E'_G , E'_B , E'_Y , E'_{C_B} , E'_{C_R} respectively (i.e. they correspond to gamma pre-corrected signals).

Item	Parameter	Value	
		1125/60/2:1	1250/50/2:1
4.1	Conceptual non-linear precorrection of primary signals	$\gamma = 0,45$ (see item 1.2)	
4.2	Derivation of luminance signal E'_Y ⁽¹⁾	$E'_Y = 0.2126 E'_R +$ $0.7152 E'_G +$ $0.0722 E'_B$	$E'_Y = 0.299 E'_R +$ $0.587 E'_G +$ $0.114 E'_B$
4.3	Derivation of colour-difference signal (analogue coding) ⁽¹⁾	$E'_{C_B} = 0.5389 (E'_B - E'_Y)$ $E'_{C_R} = 0.6350 (E'_R - E'_Y)$	$E'_{C_B} = 0.564 (E'_B - E'_Y)$ $E'_{C_R} = 0.713 (E'_R - E'_Y)$
4.4	Derivation of colour-difference signal (digital coding) C_B , C_R	Digitally scaled from the values of item 4.3	

⁽¹⁾ The coefficients for the equations have been calculated following the rules laid down in SMPTE RP177-1993.

5 Analogue representation

Levels are specified in millivolts (mV) measured across a matched 75 Ω termination.

Item	Parameter	Value	
		1125/60/2:1	1250/50/2:1
5.1	Nominal level (mV) E'_R, E'_G, E'_B, E'_Y	Reference black: 0 Reference white: 700 (see Fig. 1)	
5.2	Nominal level (mV) E'_{C_B}, E'_{C_R}	± 350 (see Fig. 1)	
5.3	Form of synchronizing signal	Tri-level bipolar (see Fig. 2)	
5.4	Line sync timing reference	O_H (see Fig. 2)	
5.5	Sync level (mV)	$\pm 300 \pm 2\%$	
5.6	Sync signal timing	(See Table 1 and Fig. 3) Sync on all components	(See Fig. 4) – rise time 50 \pm 10 ns (between 10-90%) – see also footnote ⁽¹⁾
5.7	Inter-component timing accuracy	Not applicable	± 2 ns
5.8	Blanking interval	(See Table 1 and Fig. 5)	(See Tables 2 and 3)
5.9	Nominal signal bandwidth (MHz)	30 (for all components)	

⁽¹⁾ When using R, G, B signals, the use of syncs on at least the green channel is advised; transmission of separate syncs is also acceptable. When using Y, C_B, C_R signals the Y signal at least carries sync.

FIGURE 1
Sync level on component signals

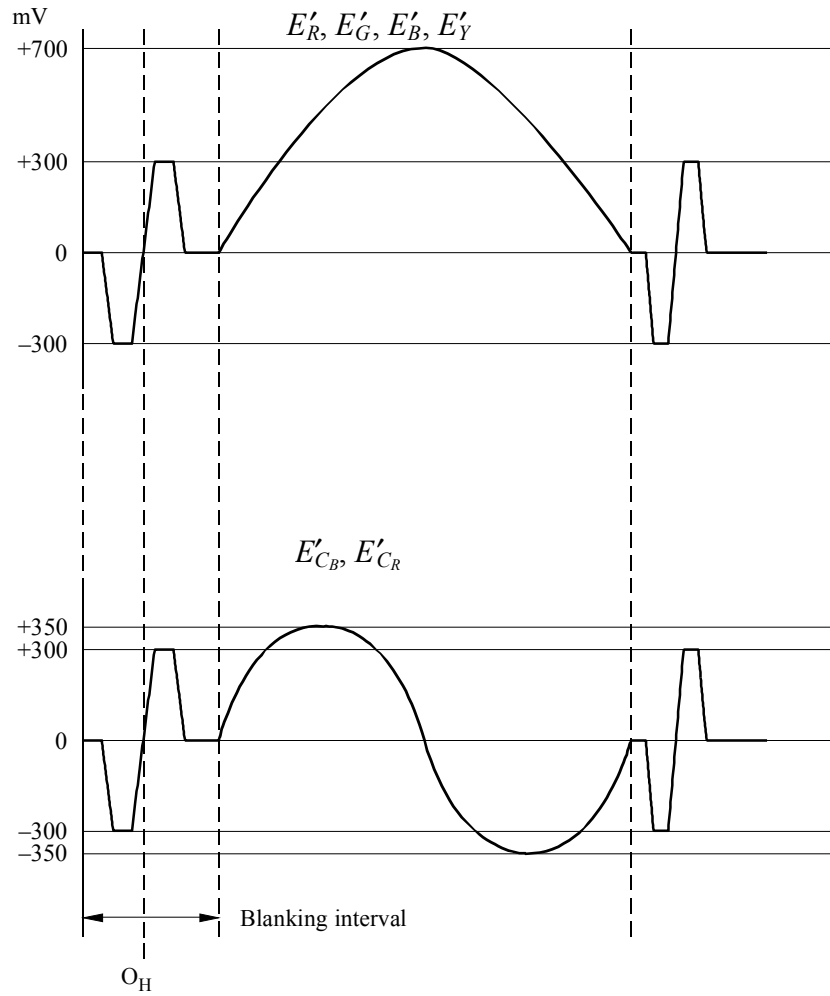

0709-01

FIGURE 2
Form of synchronizing signal

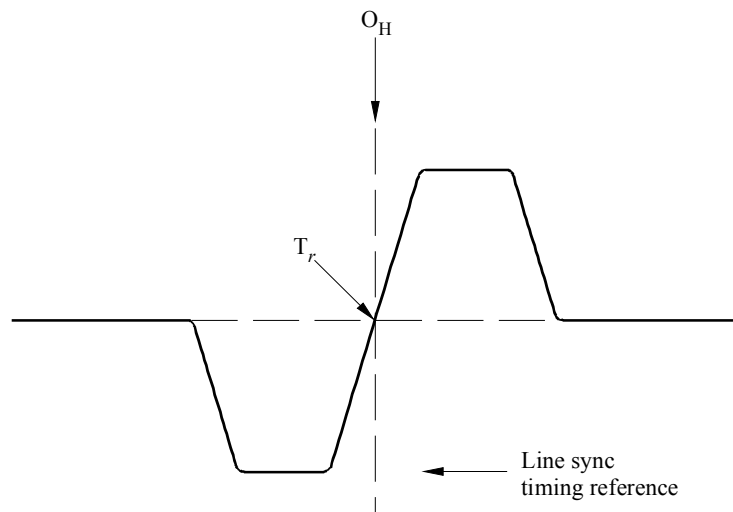

(The waveform exhibits symmetry with respect to point T_r .)

0709-02

FIGURE 3
Line synchronizing signal waveform for the 1125/60/2:1 system

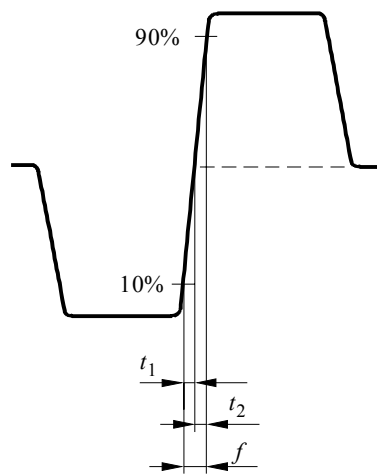
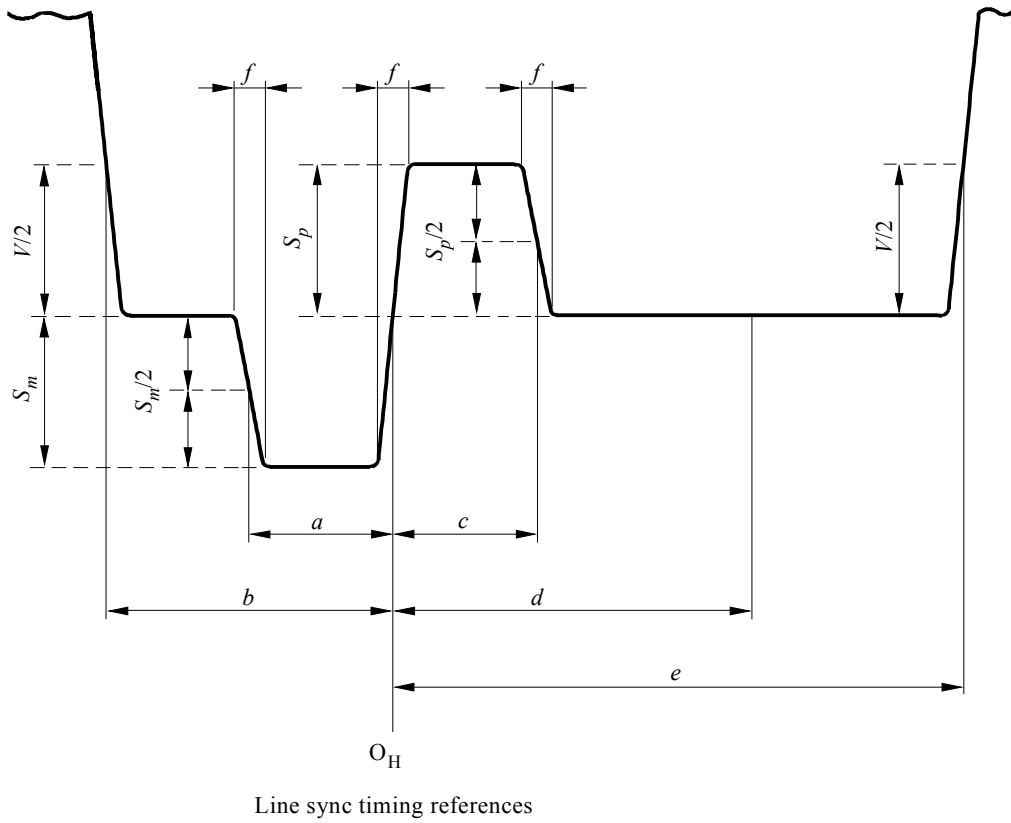
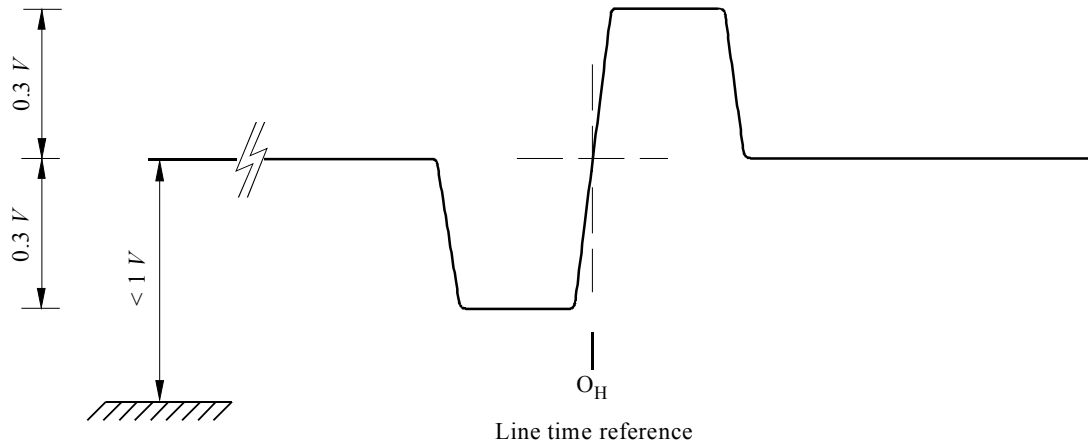

FIGURE 4
Line synchronizing signal waveform for the 1250/50/2:1 system



0709-04

TABLE 1
Level and timing specification of synchronizing signal of the 1125/60/2:1 system
(see Figs. 3 and 5)

Symbol	Parameter	Nominal value	Reference clock intervals	Tolerance
a	Negative line sync width	0.593 μs	44	$\pm 0.040 \mu\text{s}$
b	End of active video	1.185 μs	88	+0.080 $\mu\text{s}/-0 \mu\text{s}$
c	Positive line sync width	0.593 μs	44	$\pm 0.040 \mu\text{s}$
d	Clamp period	1.778 μs	132	$\pm 0.040 \mu\text{s}$
e	Start of active video	2.586 μs	192	+0.080 $\mu\text{s}/-0 \mu\text{s}$
f	Rise/fall time	0.054 μs	4	$\pm 0.020 \mu\text{s}$
$t_2 - t_1$	Symmetry of rising edge	–	–	$\pm 0.002 \mu\text{s}$
S_m	Amplitude of negative pulse	300 mV	–	$\pm 6 \text{ mV}$
S_p	Amplitude of positive pulse	300 mV	–	$\pm 6 \text{ mV}$
V	Amplitude of video signal	700 mV	–	–
–	Field-blanking interval	45 H/field	99 000	–

FIGURE 5
Field synchronizing signal waveform for the 1125/60/2:1 system

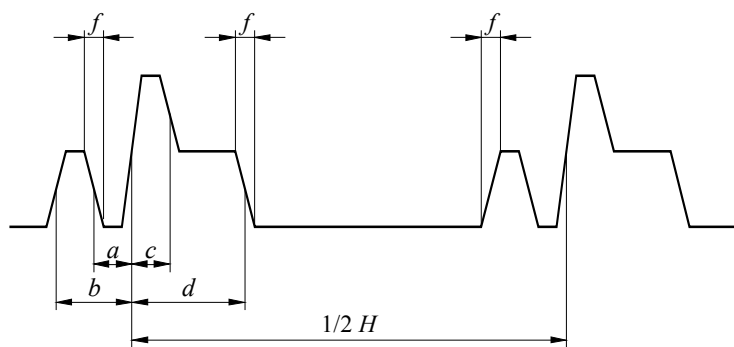
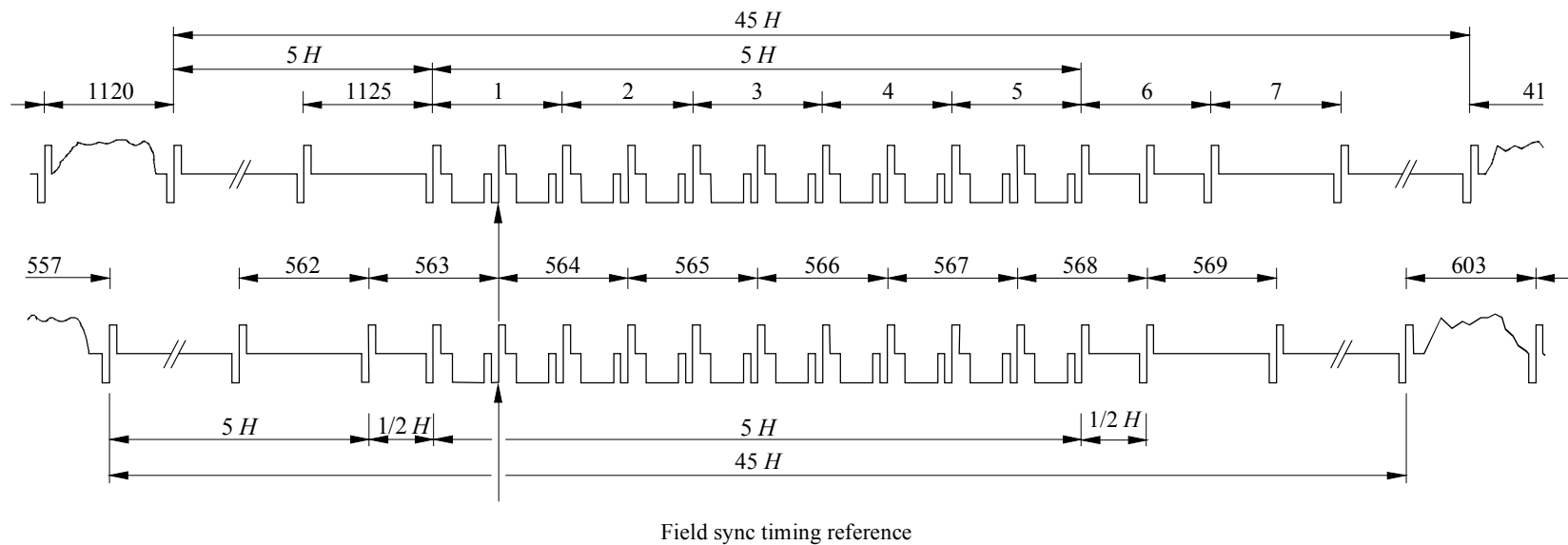

0709-05

TABLE 2
Line timing details for the 1250/50/2:1 system
(See Figs. 4, 6 and 7)

Item	Parameter	Time (µs)	2.25 MHz samples	72 MHz samples
1	Total line length	32	72	2 304
2	Active line length ⁽¹⁾ – digital – analogue	26.67 26.00	60 (58.5)	1 920 1 872
3	Line blanking ⁽²⁾ – digital – analogue	5.33 6.00	12 (13.5)	384 432
4	Front porch ⁽²⁾	0.89	2	64
5	Back porch ⁽²⁾	2.67	6	192
6	Tri-level sync half width (T-sync)	0.89	2	64
7	Field pulse	8.00	18	576

- ⁽¹⁾ Relative disposition of analogue and digital active lines assumed to be as per scaled version of Recommendation ITU-R BT.601 (Annex 1, Part A) (i.e. symmetrical). The analogue active line is measured from the half-height of signal after line blanking. Rise and fall times assumed to be 15 ns but subject to ratification. Analogue blanking should preferably be applied at the studio or playout output.
- ⁽²⁾ Front porch is defined as the interval between the end of active video and the half-height of the leading negative edge of the tri-level sync pulse. Similarly back porch is the interval between the half-height of the trailing negative edge of the tri-level sync and the start of active video (see Fig. 6).

TABLE 3
Field timing details for the 1250/50/2:1 system
(See Figs. 7 and 8)

Item	Parameter	Value/Description
1	Total number of lines per frame	1250
2	Total number of lines per field	625
3	Active lines per frame	1152
4	Active lines per field	576
5	Frame reference O_V	O_H on line 1
6	Frame indication	Line 1250
7	Field indication	Line 625
8	Active lines field 1	Lines 45 ... 620 inclusive
9	Active lines field 2	Lines 670 ... 1245 inclusive
10	Field blanking	Lines 1246 ... 44 and 621 ... 669 inclusive

FIGURE 6
Line sync timing references for the 1250/50/2:1 system
after D/A conversion and before final analogue blanking

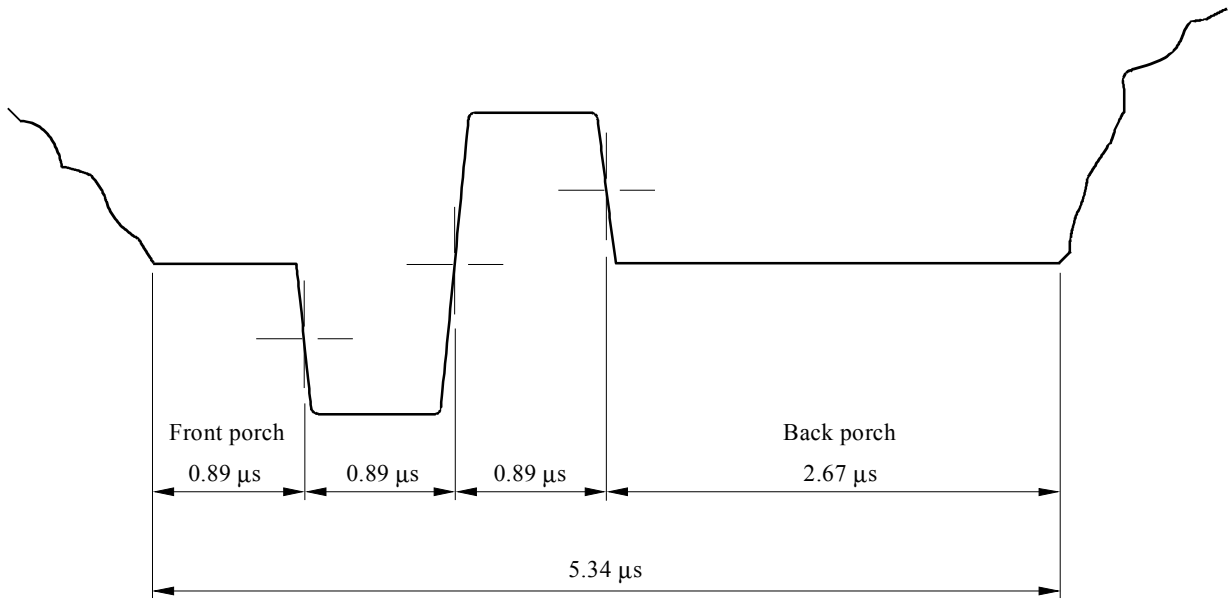

0709-06

FIGURE 7
Frame and field identification for the 1250/50/2:1 system

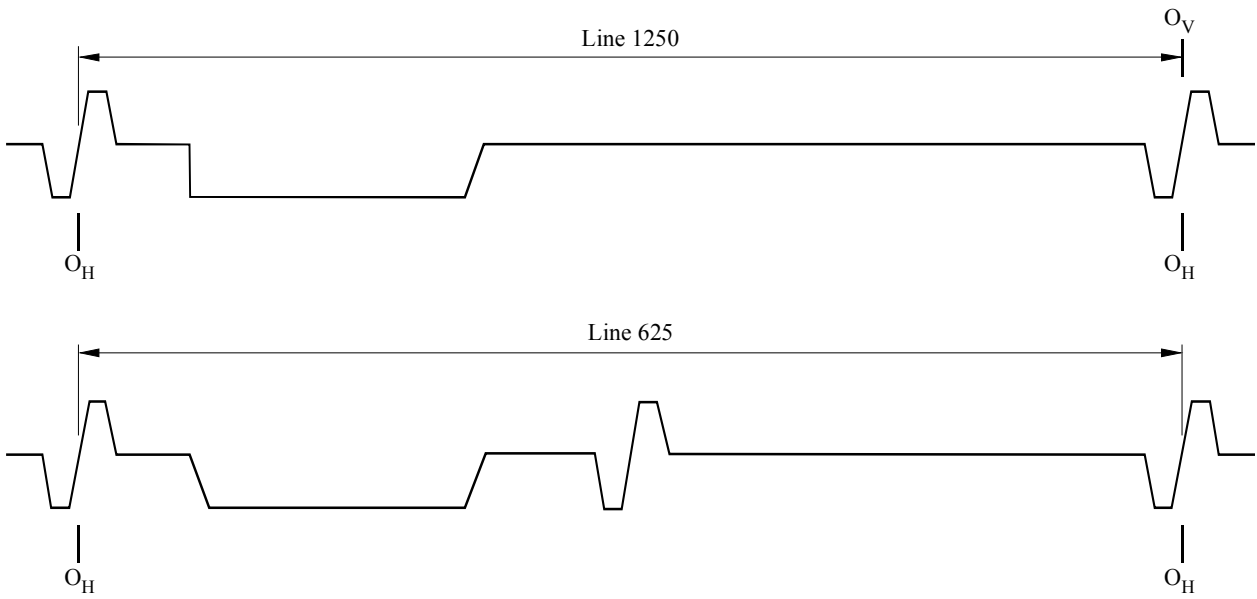

0709-07

FIGURE 8

Timing of signals during the field-blanking interval for the 1250/50/2:1 system

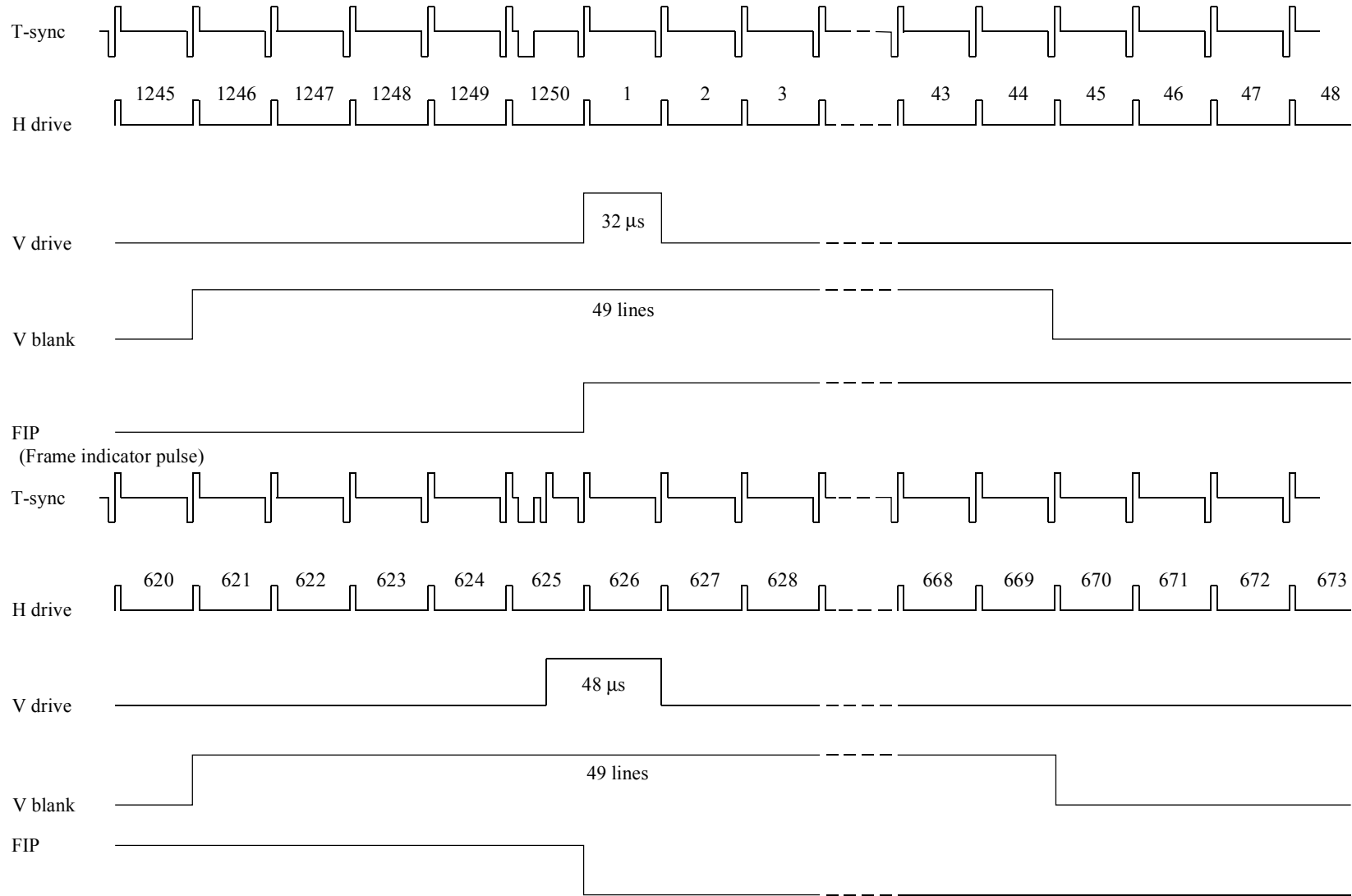

0709-08

6 Digital representation

Item	Parameter	Value	
		1125/60/2:1	1250/50/2:1
6.1	Coded signal	<i>R, G, B, or Y, C_B, C_R</i>	
6.2	Sampling lattice – <i>R, G, B, Y</i>	Orthogonal, line and picture repetitive	
6.3	Sampling lattice signal – <i>C_B, C_R</i>	Orthogonal, line and picture repetitive co-sited with each other and with alternate ⁽¹⁾ <i>Y</i> samples	
		(Multiples of 2.25 MHz)	
6.4	Sampling frequency (MHz) – <i>R, G, B, Y</i>	74.25 ± 0.001% (33 × 2.25)	72 ± 0.0001% (32 × 2.25)
		(Half of luminance sampling frequency)	
6.5	Sampling frequency (MHz) – <i>C_B, C_R</i>	37.125 ± 0.001% (33/2 × 2.25)	36 ± 0.0001% (32/2 × 2.25)
6.6	Number of samples per full line – <i>R, G, B, Y</i> – <i>C_B, C_R</i>	2 200 1 100	2 304 1 152
6.7	Active number of samples per line – <i>R, G, B, Y</i> – <i>C_B, C_R</i>	1 920 960	
6.8	Coding format	Linear, 8 or 10 bit/component	
6.9	Timing relationship between the analogue synchronizing reference O _H and video data (in clock periods)	192	256
6.10	Quantization levels ⁽²⁾ – Black level <i>R, G, B, Y</i> – Achromatic <i>C_B, C_R</i> – Nominal peak – <i>R, G, B, Y</i> – <i>C_B, C_R</i>	8 bit coding 16 128 235 16 and 240	
6.11	Quantization level assignment ⁽³⁾ – Video data – Timing references ⁽²⁾	8 bit coding 1 through 254 0 and 255	
6.12	Filter characteristics ⁽⁴⁾ – <i>R, G, B, Y</i> – <i>C_B, C_R</i>	See Fig. 9A See Fig. 9B	See Fig. 10A See Fig. 10B

(1) The first active colour-difference samples being co-sited with the first active luminance sample.

(2) For 1125/60/2:1 – In the case of 10 bit representation the two LSBs are ignored.

(3) For 1125/60/2:1 – For 10 bit coding two LSBs are added to the 8 bit code words.
For 1250/50/2:1 – 10 bit representation is under study.

(4) These filter templates are defined as guidelines.

FIGURE 9A
 Filter characteristics for *R, G, B* and *Y* signals for the 1125/60/2:1 system

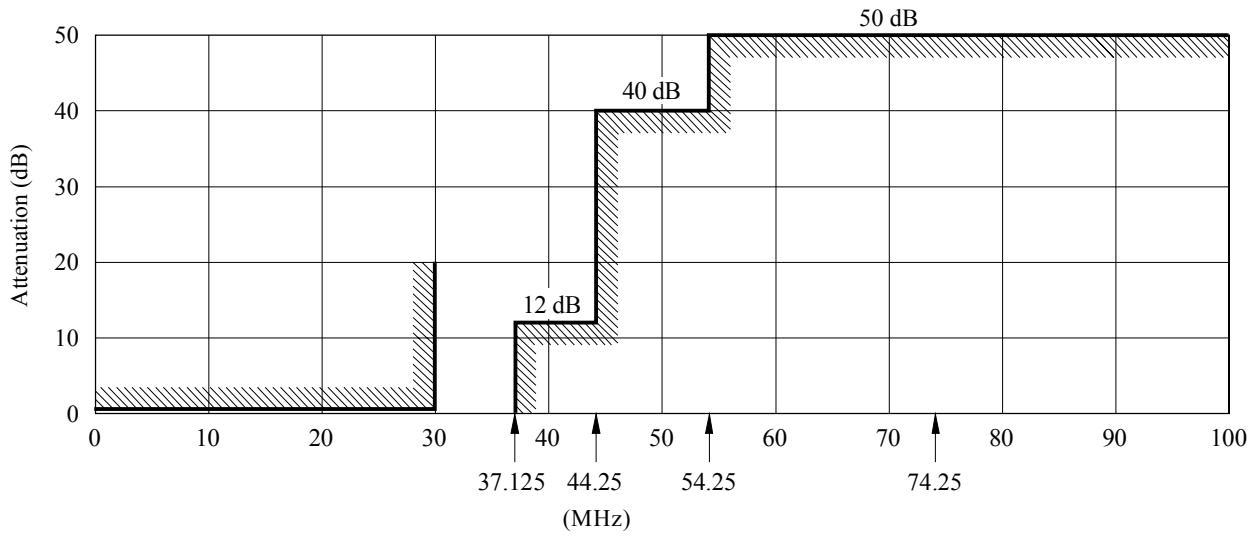

a) Template for insertion loss/frequency characteristic

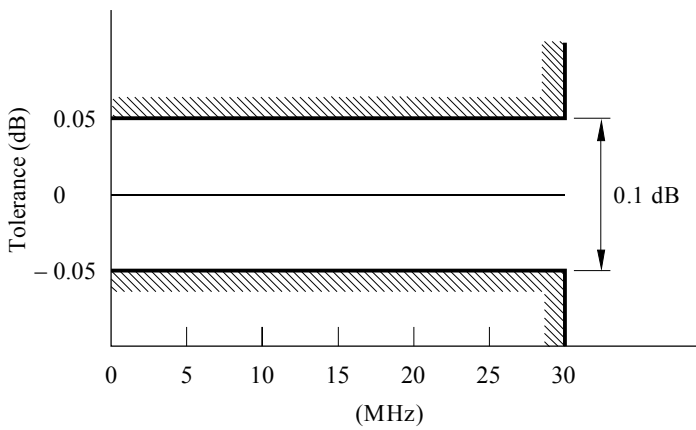

b) Passband ripple tolerance

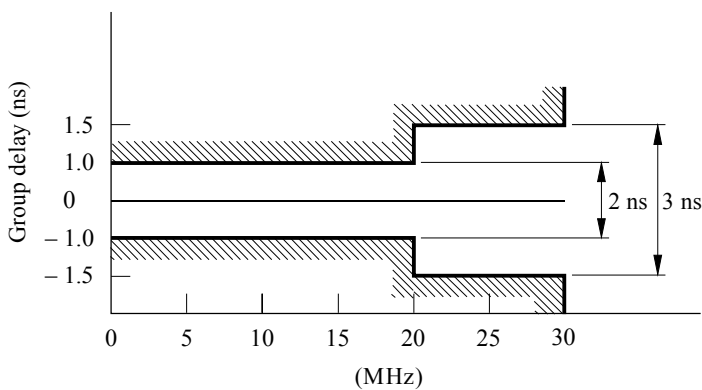

c) Passband group-delay tolerance

Note 1 – The lowest frequency value in b) and c) is 100 kHz (instead of 0 MHz).

FIGURE 9B
 Filter characteristics for C_B and C_R signals for the 1125/60/2:1 system

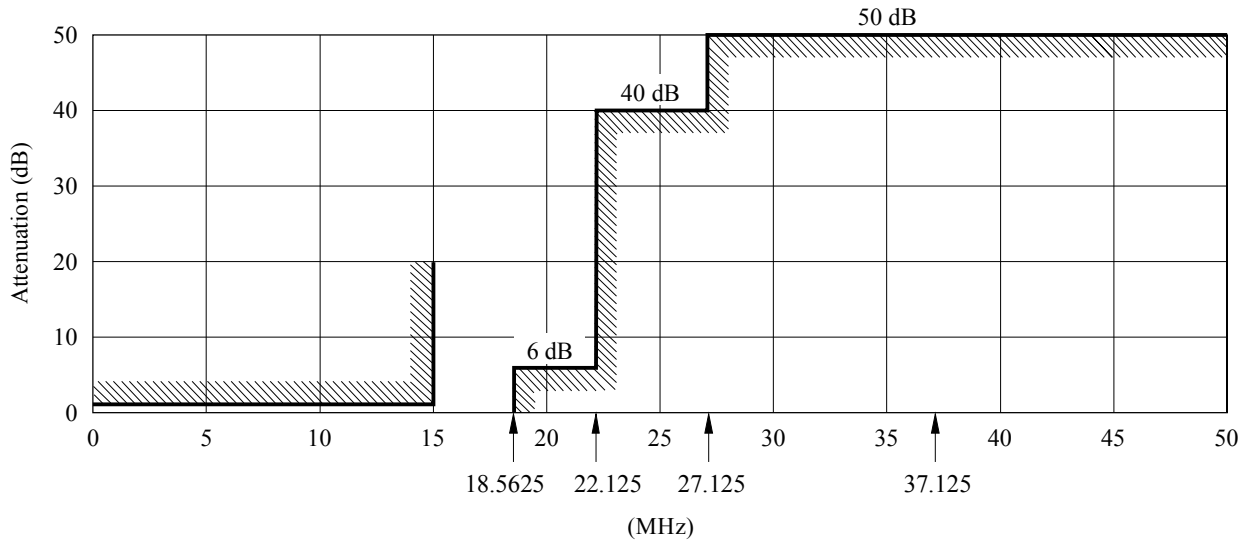

a) Template for insertion loss/frequency characteristic

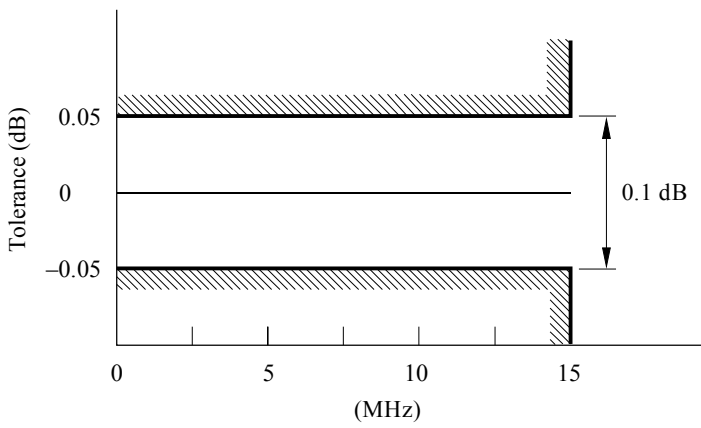

b) Passband ripple tolerance

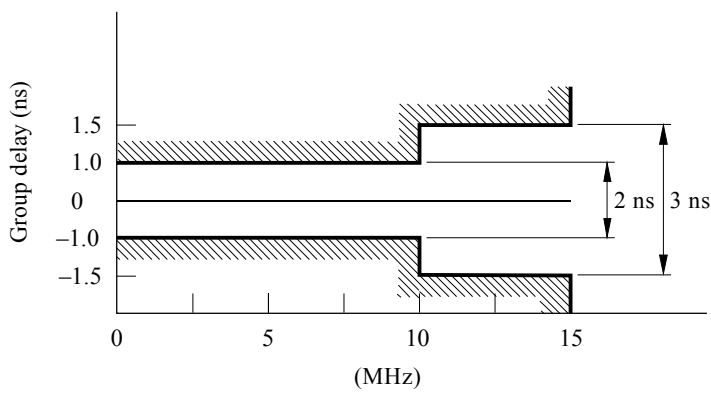

c) Passband group-delay tolerance

Note 1 – The lowest frequency value in b) and c) is 100 kHz (instead of 0 MHz).

FIGURE 10A
Filter characteristics for R, G, B and Y signals for the 1250/50/2:1 system

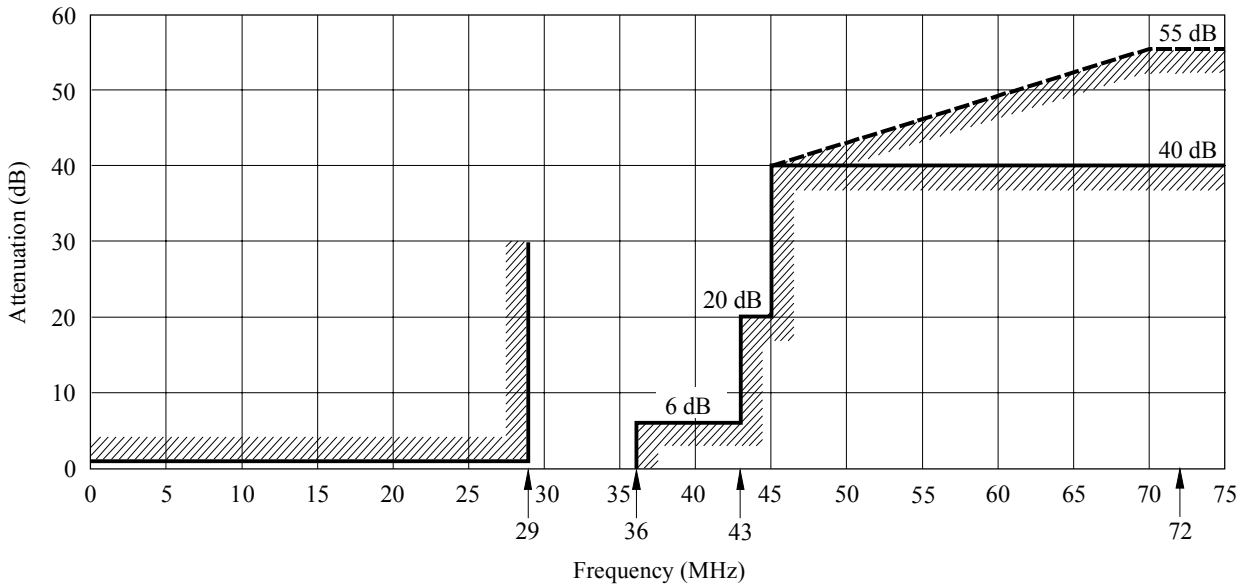

a) Template for insertion loss/frequency characteristic

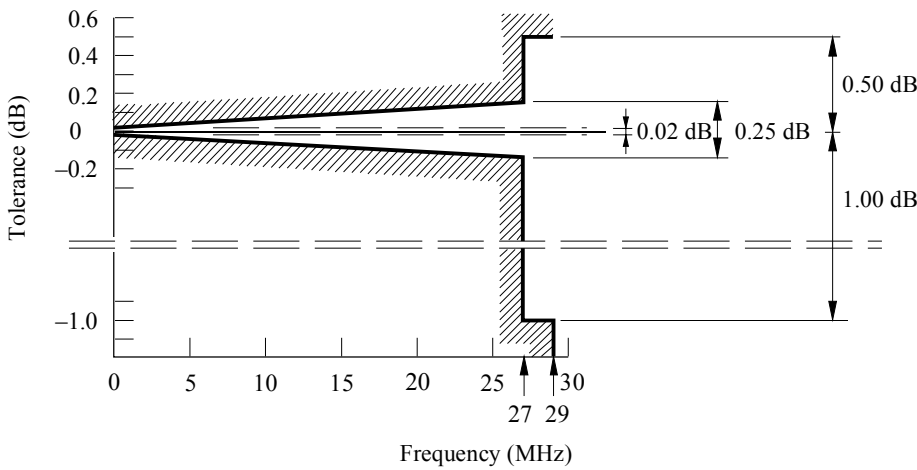

Note 1 – In a digital implementation:

- the insertion loss should be at least 55 dB above 70 MHz (dashed-line template);
- the amplitude/frequency characteristic (on linear scales) should be skew-symmetric about the half amplitude point;
- the group delay distortion should be zero by design.

Note 2 – Ripple and group delay are specified relative to their values at 5 kHz.

b) Passband ripple tolerance

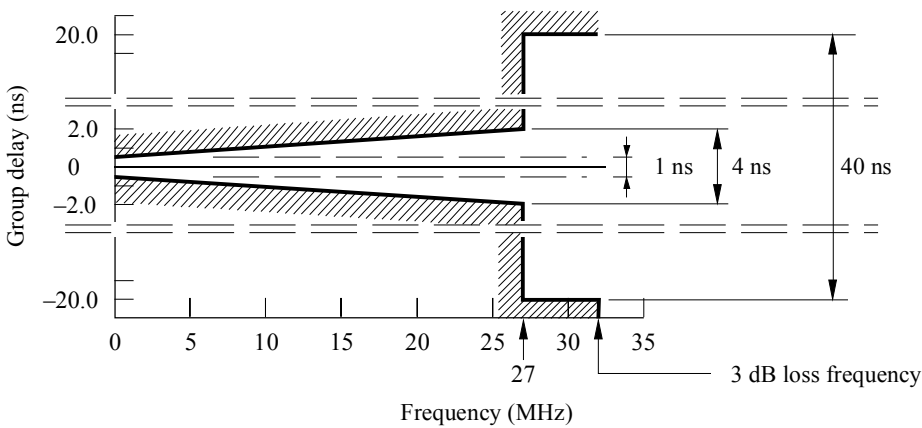

c) Passband group-delay tolerance

FIGURE 10B
Filter characteristics for C_B and C_R signals for the 1250/50/2:1 system

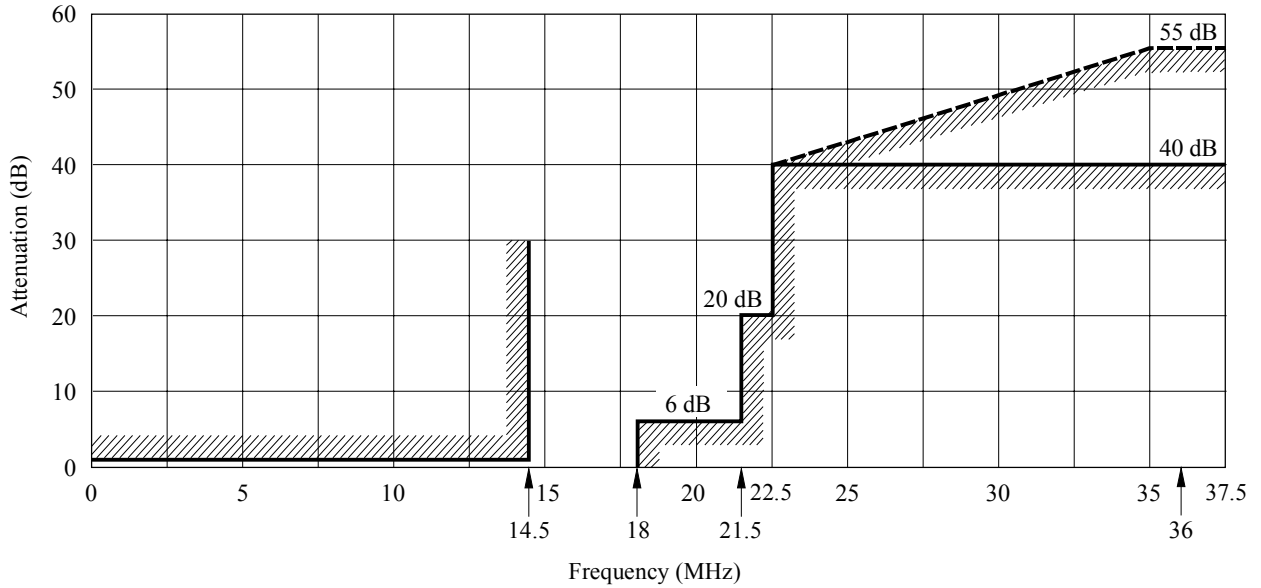

a) Template for insertion loss/frequency characteristic

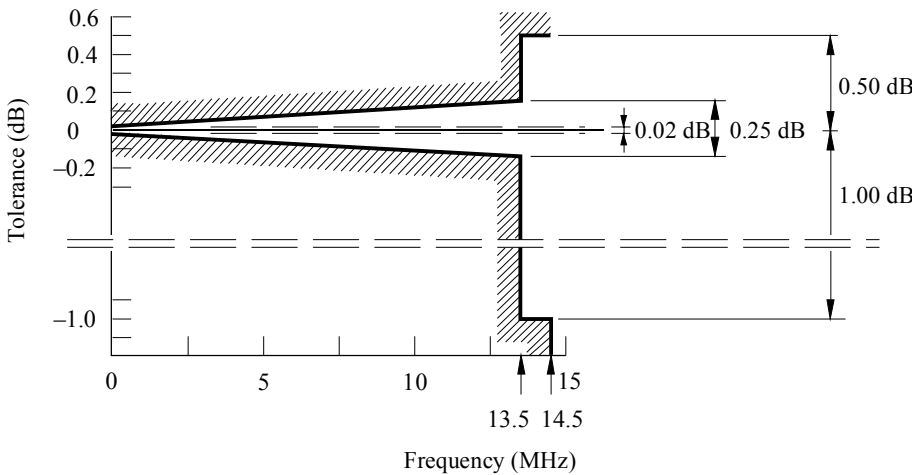

b) Passband ripple tolerance

Note 1 – In a digital implementation:

- the insertion loss should be at least 55 dB above 35 MHz (dashed-line template);
- the amplitude/frequency characteristic (on linear scales) should be skew-symmetric about the half amplitude point;
- the group delay distortion should be zero by design.

Note 2 – Ripple and group delay are specified relative to their values at 5 kHz.

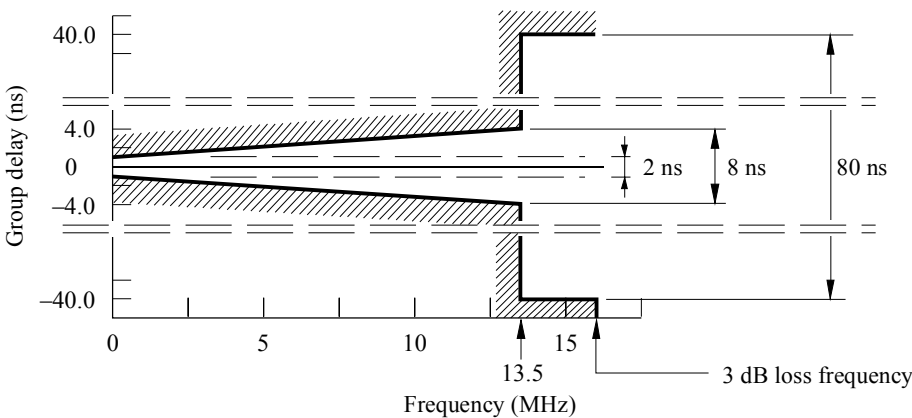

c) Passband group-delay tolerance

PART 2

HDTV system with square pixel common image format**Introduction**

The common image format (CIF) is defined to have common picture parameter values independent of the picture rate. The following picture rates are specified: 60 Hz, 50 Hz, 30 Hz, 25 Hz and 24 Hz. For the 60, 30 and 24 Hz systems, picture rates having those values divided by 1.001 are also specified. The parameter values for these systems as referred to in the Table of § 6, are presented in parentheses.

Pictures are defined for progressive (P) capture and interlace (I) capture. Progressive captured pictures can be transported with progressive (P) transport or progressive segmented frame (PsF) transport. Interlace captured pictures can be transported with interlace (I) transport. Refer to Annex 1 for a description of segmented frame transport.

This results in the following combinations of picture rates and transports:

System	Capture (Hz)	Transport
60/P	60 progressive	Progressive
30/P	30 progressive	Progressive
30/PsF	30 progressive	Segmented frame
60/I	30 interlace	Interlace
50/P	50 progressive	Progressive
25/P	25 progressive	Progressive
25/PsF	25 progressive	Segmented frame
50/I	25 interlace	Interlace
24/P	24 progressive	Progressive
24/PsF	24 progressive	Segmented frame

In cases where a progressive captured image is transported as a segmented frame, or a segmented frame signal is processed in a progressive format, the following rules shall be observed (see Fig. 11):

- line numbering from the top of the captured frame to the bottom of the captured frame shall be sequential;
- active line 1 and active line 1080 of the progressive captured image shall be mapped onto total line 42 and total line 1121, respectively, of the 1125 total lines;
- odd active lines of the progressive captured image (1, 3, ..., 1079) shall be mapped onto total lines 21 through 560 of the segmented frame interface;
- even active lines of the progressive captured image (2, 4, ..., 1080) shall be mapped onto total lines 584 through 1123 of the segmented frame interface.

With these rules, segmented frame transport has the same line numbering as that of interlace transport.

FIGURE 11

Mapping of progressive images into progressive and segmented frame transport interfaces

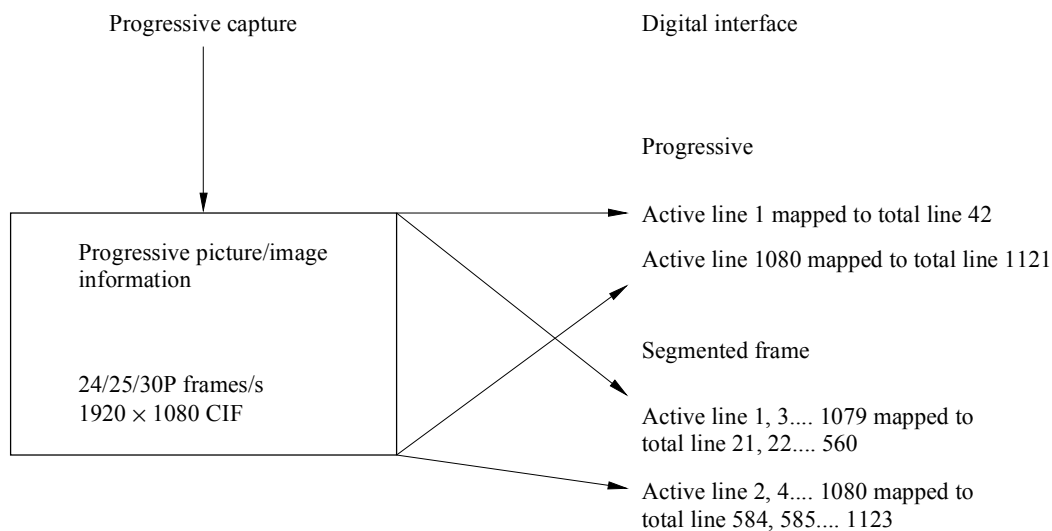

0709-11

1 Opto-electronic conversion

Item	Parameter	System Values									
		60/P	30/P	30/PsF	60/I	50/P	25/P	25/PsF	50/I	24/P	24/PsF
1.1	Opto-electronic transfer characteristics before non-linear pre-correction	Assumed linear									
1.2	Overall opto-electronic transfer characteristics at source ⁽¹⁾	$V = 1.099 L^{0.45} - 0.099 \quad \text{for } 1 \geq L \geq 0.018$ $V = 4.500 L \quad \text{for } 0.018 > L \geq 0$ where: L : luminance of the image $0 \leq L \leq 1$ V : corresponding electrical <i>signal</i>									
1.3	Chromaticity coordinates (CIE, 1931)	x					y				
	Primary – Red (R) – Green (G) – Blue (B)	0.640 0.300 0.150					0.330 0.600 0.060				
1.4	Assumed chromaticity for equal primary signals (Reference white)	D_{65}									
		x					y				
	$E_R = E_G = E_B$	0.3127					0.3290				

⁽¹⁾ Recommendation ITU-R BT.1361 gives detailed specifications for colorimetric parameters and non-linear characteristics for both the conventional and extended color-gamut systems.

2 Picture characteristics

Item	Parameter	System Values									
		60/P	30/P	30/PsF	60/I	50/P	25/P	25/PsF	50/I	24/P	24/PsF
2.1	Aspect ratio	16:9									
2.2	Samples per active line	1 920									
2.3	Sampling lattice	Orthogonal									
2.4	Active lines per picture	1 080									
2.5	Pixel aspect ratio	1:1 (square pixels)									

3 Signal format

Item	Parameter	System Values									
		60/P	30/P	30/PsF	60/I	50/P	25/P	25/PsF	50/I	24/P	24/PsF
3.1	Conceptual non-linear pre-correction of primary signals	$\gamma = 0,45$ (see item 1.2)									
3.2	Derivation of luminance signal E'_Y	$E'_Y = 0.2126 E'_R + 0.7152 E'_G + 0.0722 E'_B$									
3.3	Derivation of color-difference signal (analogue coding)	$E'_{C_B} = (E'_B - E'_Y) / 1.8556$ $E'_{C_R} = (E'_R - E'_Y) / 1.5748$									
3.4	Derivation of luminance and color-difference signals (digital coding)	See Recommendation ITU-R BT.1361 ⁽¹⁾									

⁽¹⁾ Recommendation ITU-R BT.1361 gives general calculation rules to obtain the coefficients for digital coding, as well as the actual coefficients values for 8- to 16-bit quantization systems.

4 Analogue representation

Item	Parameter	System Values									
		60/P	30/P	30/PsF	60/I	50/P	25/P	25/PsF	50/I	24/P	24/PsF
4.1	Nominal level (mV) E'_R, E'_G, E'_B, E'_Y	Reference black: 0 Reference white: 700 (see Fig. 13B)									
4.2	Nominal level (mV) E'_{C_B}, E'_{C_R}	± 350 (see Fig. 13B)									
4.3	Form of synchronizing signal	Tri-level bipolar (see Fig. 13A)									
4.4	Line sync timing reference	O_H (see Fig. 13A)									
4.5	Sync level (mV)	$\pm 300 \pm 2\%$									
4.6	Sync signal timing	Sync on all components (see Table 4, Figs. 12 and 13)									
4.7	Blanking interval	(see Table 4, Figs. 12 and 13)									

5 Digital representation

Item	Parameter	System Values									
		60/P	30/P	30/PsF	60/I	50/P	25/P	25/PsF	50/I	24/P	24/PsF
5.1	Coded signal	R, G, B or Y, C_B, C_R									
5.2	Sampling lattice – R, G, B, Y	Orthogonal, line and picture repetitive									
5.3	Sampling lattice – C_B, C_R	Orthogonal, line and picture repetitive co-sited with each other and with alternate ⁽¹⁾ Y samples									
5.4	Number of active samples per line – R, G, B, Y – C_B, C_R	1 920 960									
5.5	Coding format	Linear 8 or 10 bits/component									
5.6	Quantization levels – Black level R, G, B, Y – Achromatic C_B, C_R – Nominal peak – R, G, B, Y – C_B, C_R	8-bit coding					10-bit coding				
		16 128 235 16 and 240					64 512 940 64 and 960				
5.7	Quantization level assignment – Video data – Timing reference	8-bit coding					10-bit coding				
		1 through 254 0 and 255					4 through 1 019 0-3 and 1 020-1 023				
5.8	Filter characteristics ⁽²⁾ – R, G, B, Y – C_B, C_R	See Fig. 14A See Fig. 14B									

(1) The first active color-difference samples being co-sited with the first active luminance sample.

(2) These filter templates are defined as guidelines.

6 Picture scanning characteristics

Item	Parameter	System Values									
		60/P	30/P	30/PsF	60/I	50/P	25/P	25/PsF	50/I	24/P	24/PsF
6.1	Order of sample presentation in a scanned system	Left to right, top to bottom For interlace and segmented frame systems, 1st active line of field 1 at top of picture									
6.2	Total number of lines	1125									
6.3	Field/frame/segment frequency (Hz)	60 (60/1.001)	30 (30/1.001)	60 (60/1.001)		50	25	50		24 (24/1.001)	48 (48/1.001)
6.4	Interlace ratio	1:1			2:1	1:1			2:1	1:1	
6.5	Picture rate (Hz)	60 (60/1.001)	30 (30/1.001)			50	25			24 (24/1.001)	
6.6	Line frequency ⁽¹⁾ (Hz)	67 500 (67 500/1.001)	33 750 (33 750/1.001)			56 250	28 125			27 000 (27 000/1.001)	
6.7	Samples per full line – R, G, B, Y – C_B, C_R	2 200 1 100				2 640 1 320				2 750 1 375	
6.8	Nominal analogue signal bandwidths ⁽²⁾ (MHz)	60	30			60	30				
6.9	Sampling frequency – R, G, B, Y (MHz)	148.5 (148.5/1.001)	74.25 (74.25/1.001)			148.5	74.25			74.25 (74.25/1.001)	
6.10	Sampling frequency ⁽³⁾ – C_B, C_R (MHz)	74.25 (74.25/1.001)	37.125 (37.125/1.001)			74.25	37.125			37.125 (37.125/1.001)	

⁽¹⁾ The tolerance on frequencies is $\pm 0.001\%$.

⁽²⁾ Bandwidth is for all components.

⁽³⁾ C_B, C_R sampling frequency is half of luminance sampling frequency.

TABLE 4
Level and line timing specification
(See Figs. 12 and 13)

Symbol	Parameter	System Values									
		60/P	30/P	30/PsF	60/I	50/P	25/P	25/PsF	50/I	24/P	24/PsF
T	Reference clock interval (μs)	1/148.5 (1.001/148.5)	1/74.25 (1.001/74.25)		1/148.5	1/74.25		1/74.25 (1.001/74.25)			
a	Negative line sync width ⁽¹⁾ (T)	44 \pm 3									
b	End of active video ⁽²⁾ (T)	88 \pm 6 - 0			528 \pm 6 - 0			638 \pm 6 - 0			
c	Positive line sync width (T)	44 \pm 3									
d	Clamp period (T)	132 \pm 3									
e	Start of active video (T)	192 \pm 6 - 0									
f	Rise/fall time (T)	4 \pm 1.5									
–	Active line interval (T)	1 920 \pm 0 - 12									
S_m	Amplitude of negative pulse (mV)	300 \pm 6									
S_p	Amplitude of positive pulse (mV)	300 \pm 6									
V	Amplitude of video signal (mV)	700									
H	Total line interval (T)	2200			2640			2750			
g	Half line interval (T)	1100			1320			1375			
h	Vertical sync width (T)	1 980 \pm 3		880 \pm 3		1 980 \pm 3		880 \pm 3		1 980 \pm 3	880 \pm 3
k	End of vertical sync pulse (T)	88 \pm 3			528 \pm 3		308 \pm 3		638 \pm 3		363 \pm 3

(1) “ T ” denotes the duration of a reference clock or the reciprocal of the clock frequency.

(2) A “line” starts at line sync timing reference O_H (inclusive), and ends just before the subsequent O_H (exclusive).

FIGURE 12A
Field/frame/segment synchronizing signal waveform

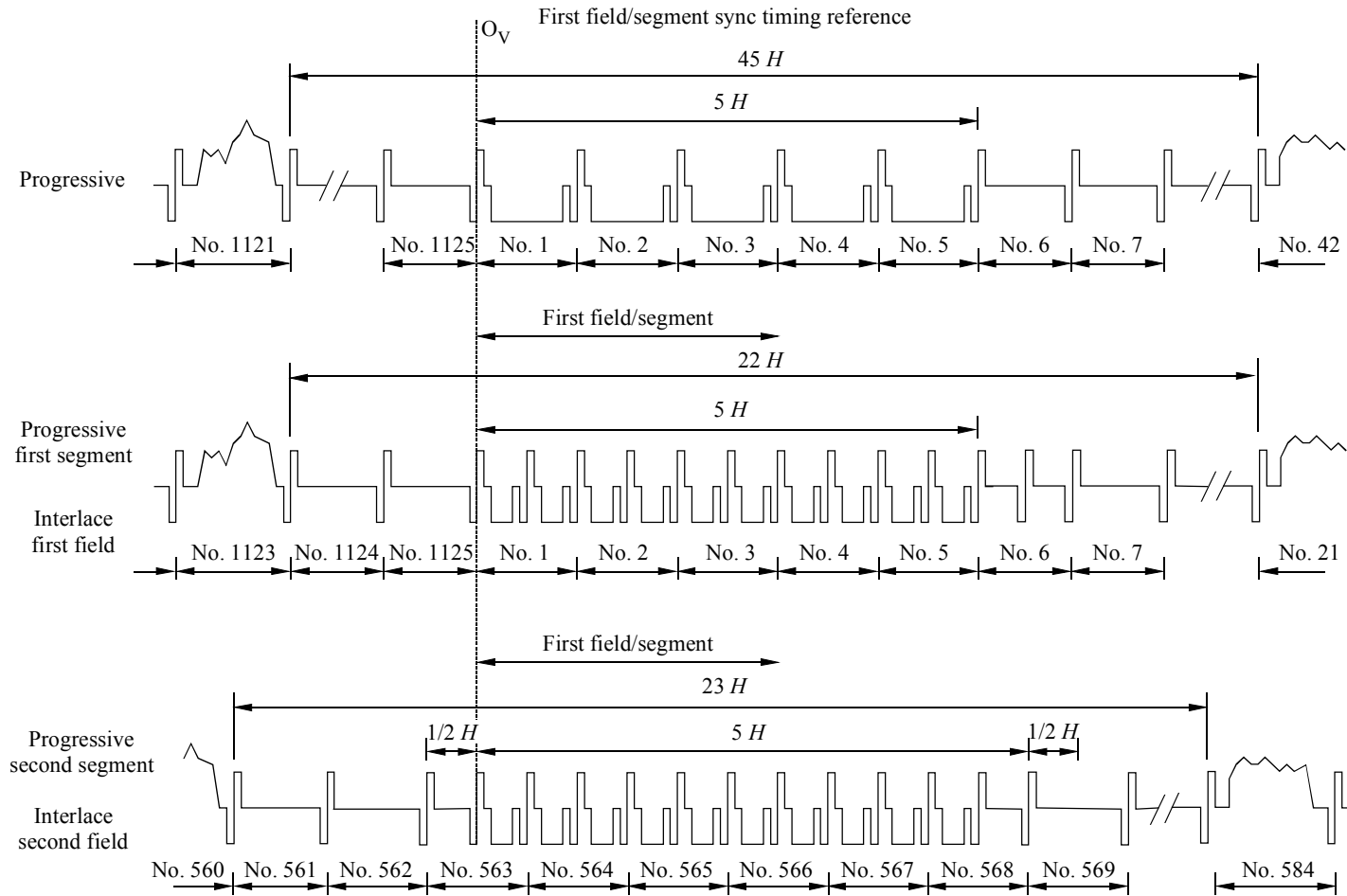

0709-12A

FIGURE 12B
Detail of field/frame/segment synchronizing signal waveform

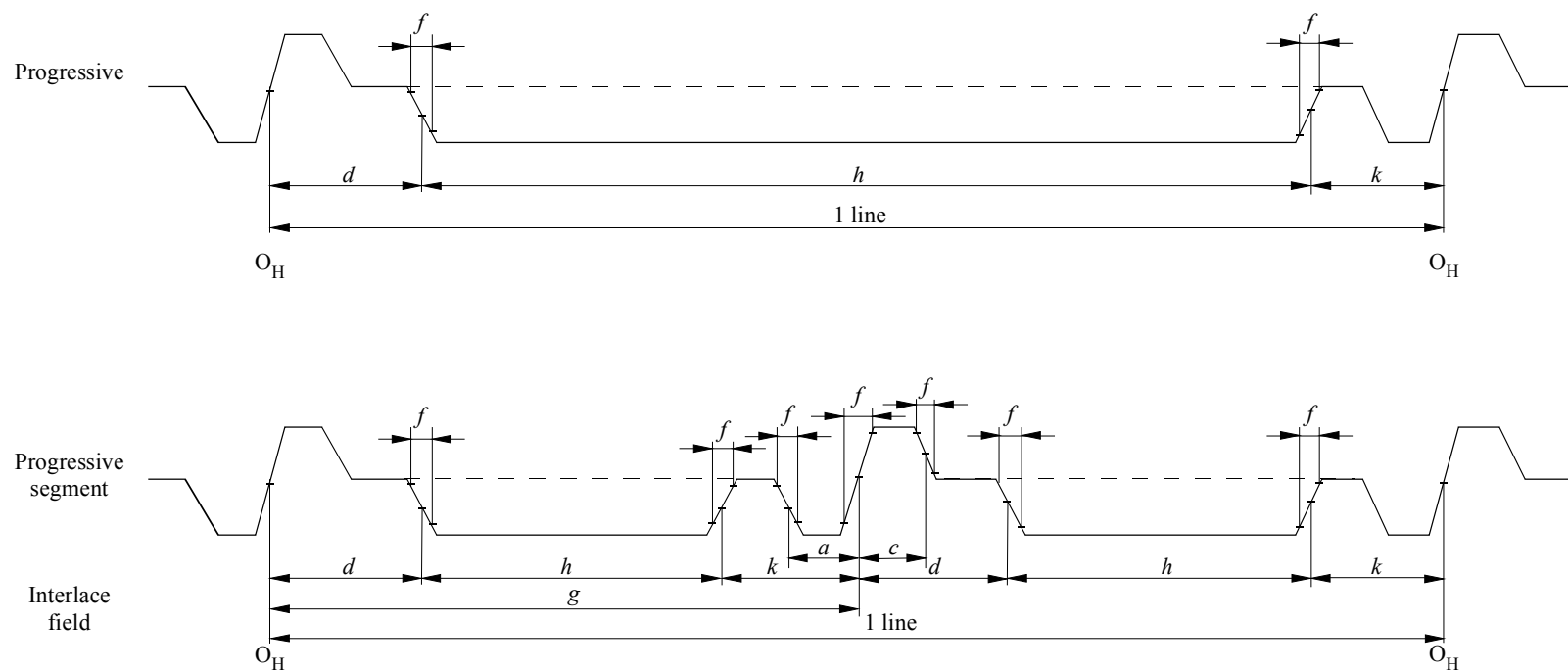

0709-12B

FIGURE 13A
Line synchronizing signal waveform

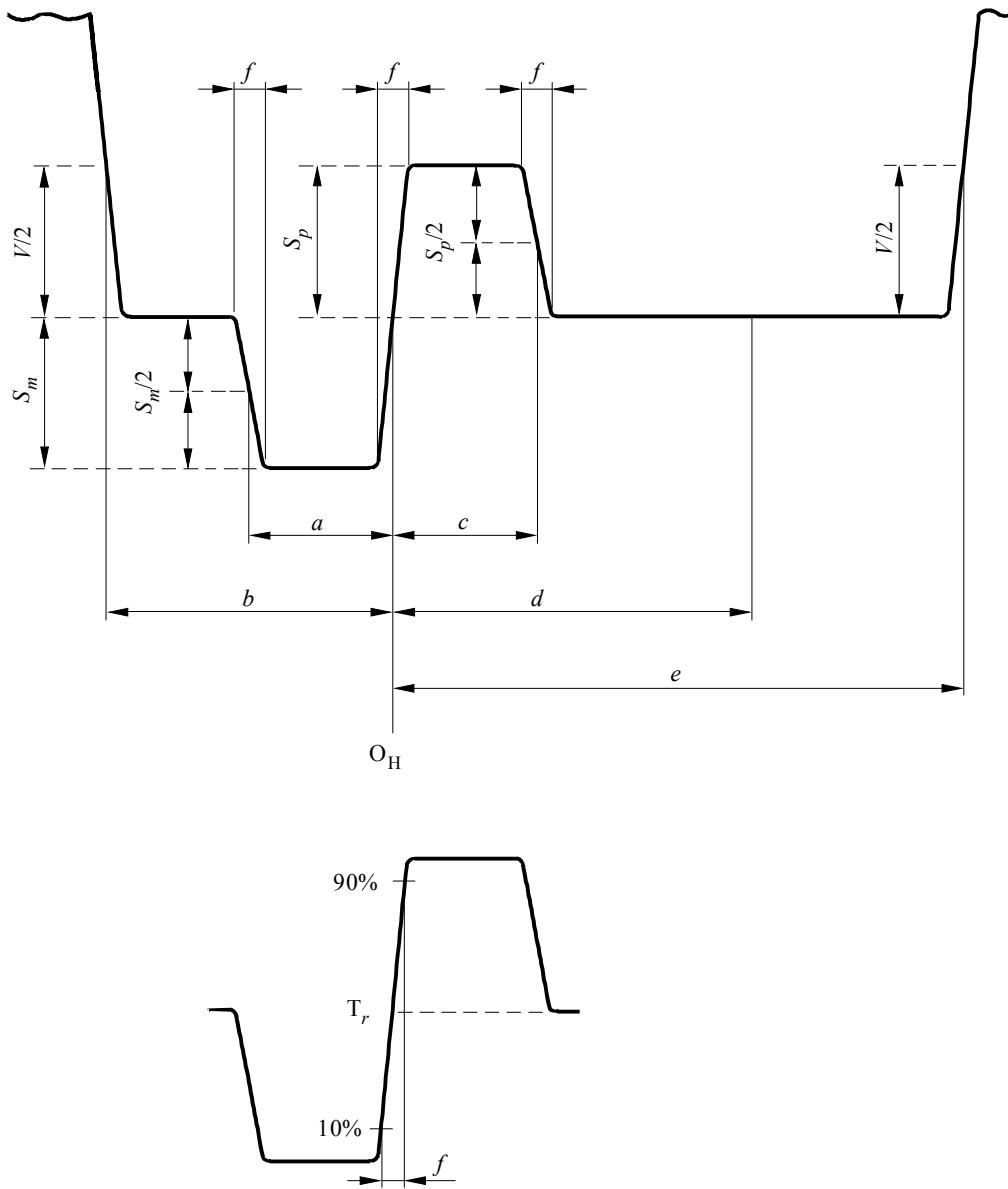

(The waveform exhibits symmetry with respect to point T_r .)

FIGURE 13B
Sync level on component signals

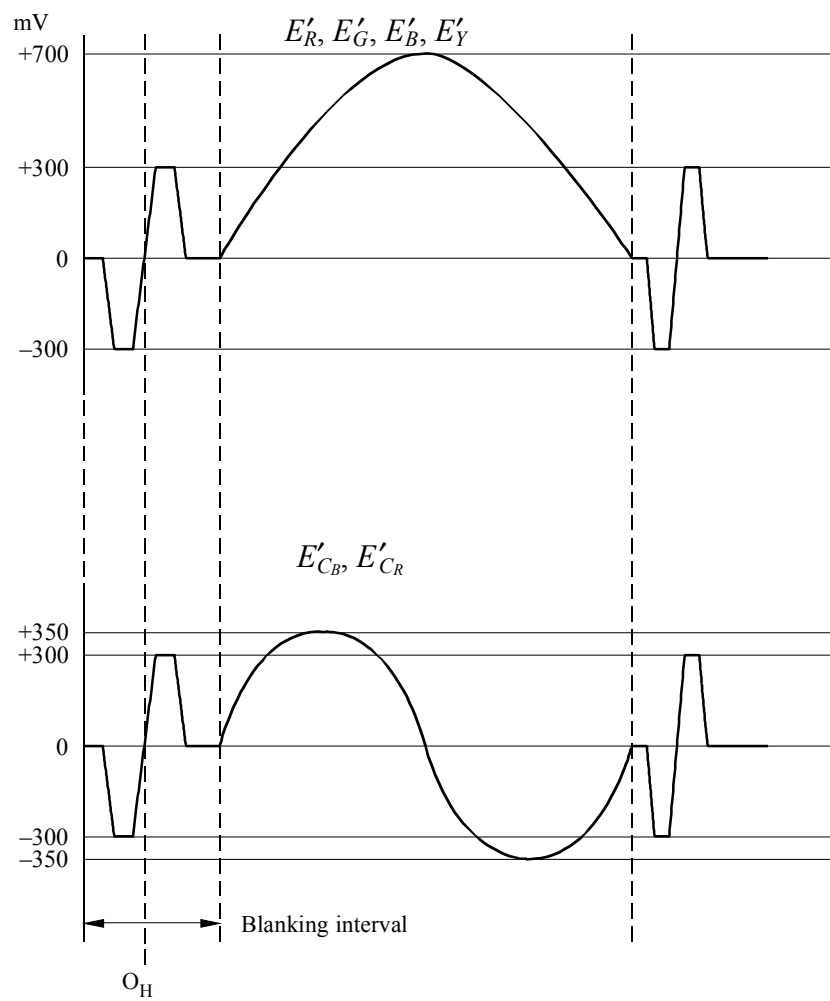

0709-013B

FIGURE 14A
Guideline filter characteristics for R, G, B and Y signals (informative)

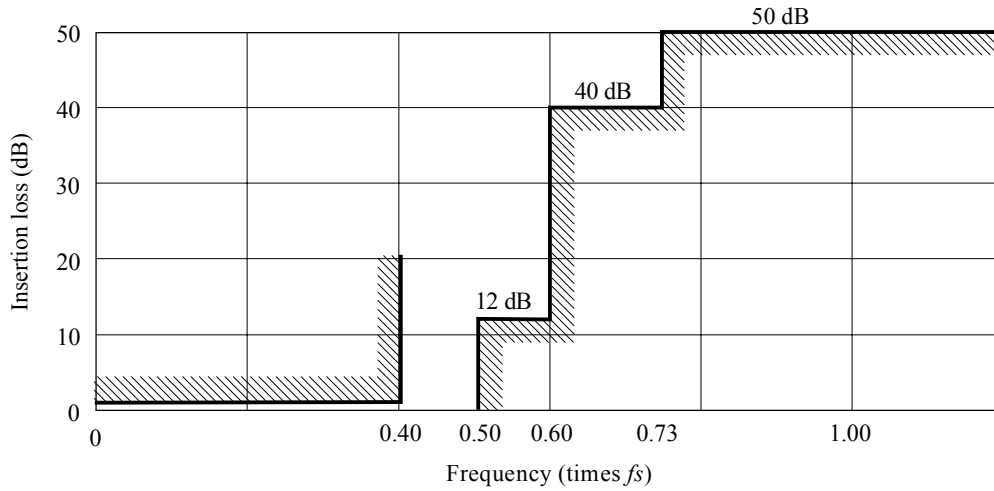

a) Template for insertion loss

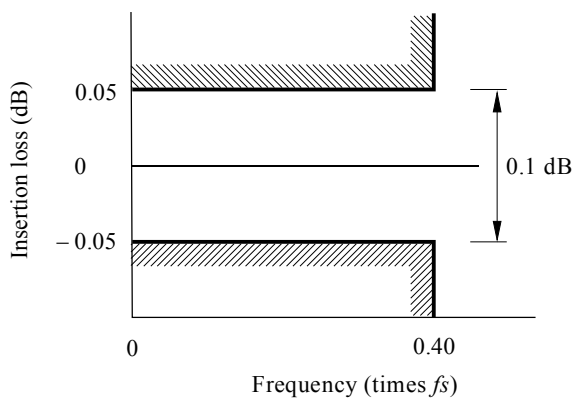

b) Passband ripple tolerance

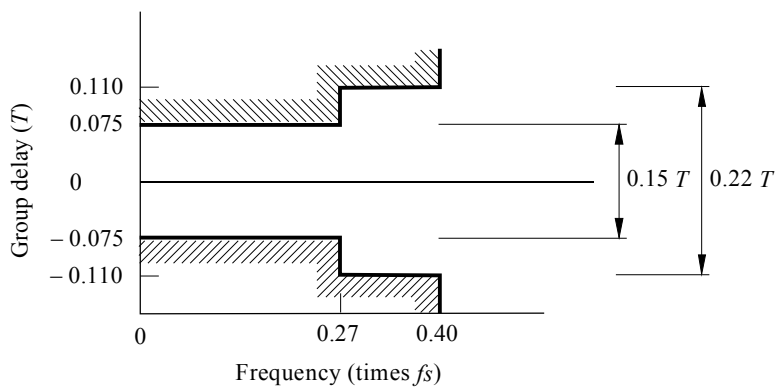

c) Passband group-delay

Note 1 – f_s denotes luminance sampling frequency, the value of which is given in Part 2, item 6.9.

Note 2 – Ripple and group delay are specified relative to their values at 100 kHz.

FIGURE 14B
 Guideline filter characteristics for C_B and C_R signals (informative)

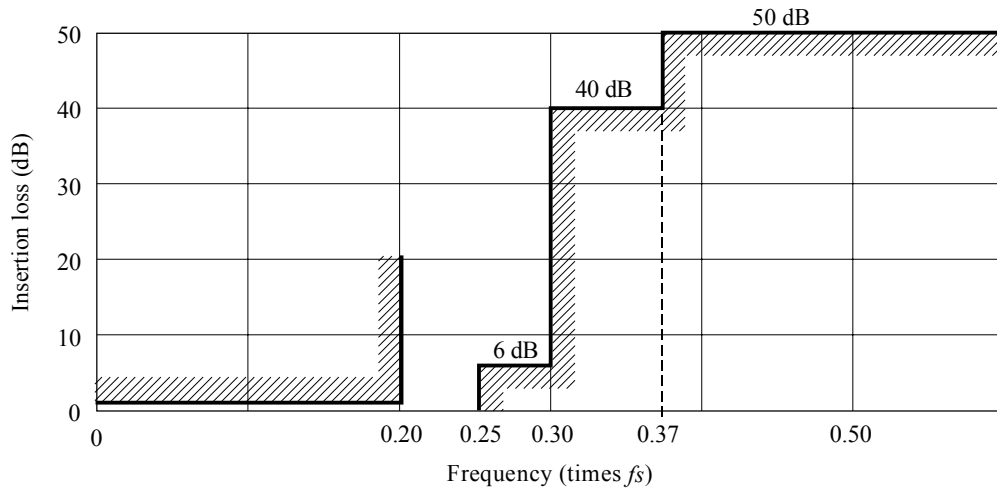

a) Template for insertion loss

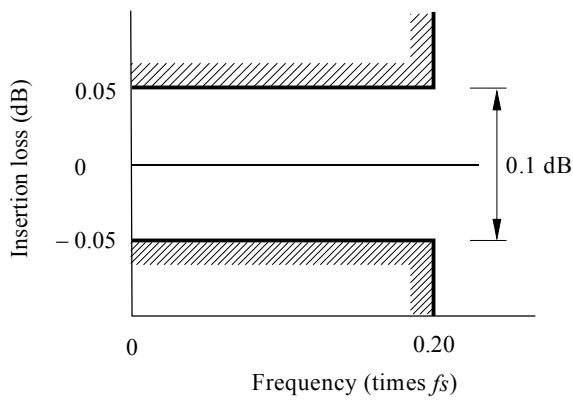

b) Passband ripple tolerance

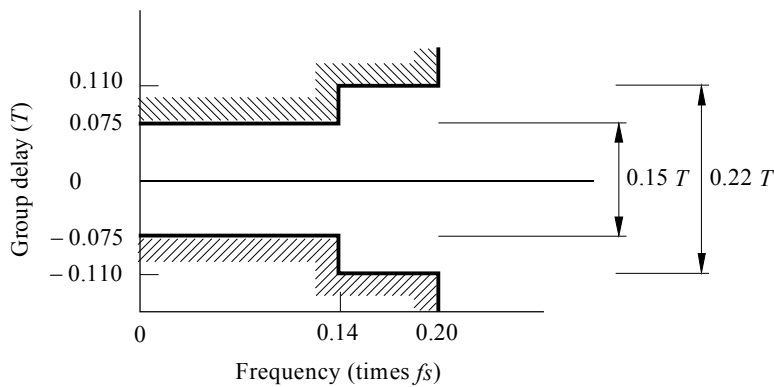

c) Passband group-delay

Note 1 – f_s denotes luminance sampling frequency, the value of which is given in Part 2, item 6.9.

Note 2 – Ripple and group delay are specified relative to their values at 100 kHz.

ANNEX 1

TO PART 2

(Informative)

Segmented frame

(See Note 1)

NOTE 1 – The term segmented frame in the context of this Recommendation is intended to indicate that a picture has been captured in a progressive mode, and transported as two segments. One segment containing the odd lines of the progressive image, the second segment containing the even lines of the progressive image.

1 Background

The television systems in current use have typically used interlace capture (acquisition) and transmission. The frame/field rates of these systems have been 50/60 Hz, a rate that when presented on cathode ray tube (CRT) display devices did not require any associated picture flicker correction. Television systems of the future will support both interlace and progressive capture and display technology.

In addition to the support of interlace and progressive capture and display, there will be extended frame rates to be supported, along with new display technology. For a number of years there will be a mix of the old and new technologies.

Specifically, the PsF technology is intended to be implemented only when frames rates of 30 Hz and lower are being used.

A large percentage of television programming is produced on film that has a frame rate of 24 frames/s and sometimes 30 frames/s. Past practice was to perform post production by editing the film to produce a complete programme on film. The final film could be transferred to 60 Hz video by employing the 3:2 pull down technique. For 25 Hz release the film could be transferred by running the 24 frame film at 25 frames/s.

It is common practice to transfer the film to 60 Hz (field) interlace video for post production. Once the film is transferred, edit decision lists are created based on the 60 Hz (field) video rate, not the original 24 Hz original film frame rate. The conversion process from 24 Hz film to 60 Hz (field) video results in a number of operational impediments, such as tracking of 3:2 pull down, editing of split fields etc. In addition when 25 Hz video copies of the material are required, either reconfirming is necessary, or standards conversion 30 Hz to 25 Hz, with a loss of quality.

Equipment is now available that will permit the transfer, post production and worldwide distribution of film originated material with the original frame rate of 24 frames/s.

2 24-frame/s production

Using the CIF of 1920×1080 , film material may be transferred using progressive capture. This transfer will provide the highest resolution capture, with no 3:2 pull-down artifacts, moreover both 30 Hz frame rate and 25 Hz frame rate versions may be created from a single master with no quality loss.

The 30 Hz frame rate copy may be created by playing the 24-frame/s original and inserting the 3:2 pull-down during the replay process. This process also has the advantage of maintaining the 3:2 pull-down sequence during the replay process such that any downstream picture processing, such as an MPEG encoder, will not be affected by any 3:2 discontinuities.

The 25 Hz frame rate copy may be created by simply playing back the 24 Hz film rate original at the slightly faster 25 Hz rate; there is no picture quality loss.

In addition to simply transferring film originated material it is expected that electronic capture of images will occur at a 24-frame/s rate; this will provide the production community with yet another tool for seamless integration of images from various sources.

3 Progressive/interlace compatibility

The post production world has a need to cater for both progressive and interlace television signal formats for the foreseeable future. Therefore any new signal format such as 24P, the original film frame rate, will need to coexist with interlace formats of 25 Hz and 30 Hz systems. One of the constraints in monitoring the 24-frame/s systems is the picture flicker that is present when displaying a 24-frame/s signal on a CRT display. Interlace systems minimize this flicker by refreshing the CRT phosphors every 60th/50th of a second. There are at least two solutions to the flicker created by the 24-frame/s systems, install a frame store in every monitor, or provide to the monitor a signal that emulates the interlace refresh rate.

24PsF/25PsF/30PsF are transmission formats that will provide monitoring devices with signal refresh rates that will permit direct monitoring of the original frame rate of the material.

It should be noted that in some cases users may want to monitor 24-frame/30-frame material at other than the original frame rates.

The use of 24PsF/25PsF/30PsF does not in any way limit the monitoring of the signal by the newer flat panel displays.

A second potential use of the 24PsF/25PsF/30PsF transmission format is in the area of digital post production switchers. A common switcher design handling both interlace and progressive signals is economically possible, and addresses the requirements of end users who have a requirement to work in interlace and progressive formats with common equipment. The digital interface of an interlace signal and a PsF signal are common, only the signal content is different.

4 Signal mapping

The 24PsF/25PsF/30PsF transmission format maps a progressive image onto the interlace digital serial interface as defined in this Recommendation (see Fig. 11).

Line numbering convention for the image capture and image transmission is contained in the introduction of Part 2 (see also Fig. 11).

The same lines numbers of an interlace picture are used by the PsF to carry the segmented frame format.

The sF format is not related to any interlace format characteristics. It is a way to convey a progressive image that has been captured at a 24/25/30 Hz rate. Capture at these low frequencies may require special monitoring considerations. The sF transmission format is intended to provide an economical solution while still retaining the compatibility with interlace systems.
