

RECOMMANDATION UIT-R BT.1618

Structure de données des signaux audio, de données et de vidéo compressée en format vidéonumérique aux débits de 25 et 50 Mbit/s

(Question UIT-R 12/6)

(2003)

L'Assemblée des radiocommunications de l'UIT,

considérant

- a) que l'on a identifié des applications de production et de postproduction de télévision professionnelle dans lesquelles la compression vidéo au format vidéonumérique est susceptible de présenter des avantages opérationnels et économiques par rapport aux opérations au format d'interface série numérique;
- b) que, dans le même groupe de compression, trois débits de données destinés aux différentes applications (25 Mbit/s, 50 Mbit/s et 100 Mbit/s) ont été proposés;
- c) que les grilles d'échantillonnage de ces trois applications sont différentes;
- d) que les éléments audio, de données auxiliaires et de métadonnées font partie intégrante de ces applications;
- e) que ces éléments sont multiplexés dans un flux de données unique en vue de leur transport et de leur traitement ultérieur;
- f) que la qualité de compression et les caractéristiques fonctionnelles doivent être identiques et reproductibles dans des chaînes de production complexes;
- g) qu'à cette fin, il faut définir tous les détails des paramètres utilisés pour le codage et le multiplexage,

recommande

1 d'utiliser, pour des applications de la production et de la postproduction de télévision professionnelle utilisant la compression au format vidéonumérique à 25 et à 50 Mbit/s, les paramètres spécifiés dans la norme SMPTE 314M-1999 «Data Structure for DV-Based Audio, Data and Compressed Video – 25 et 50 Mb/s».

Résumé de la norme SMPTE 314M-1999

Cette norme définit la structure de données au format vidéonumérique pour l'interfaçage du son, des données de sous-code et de vidéo compressée numériques avec les paramètres suivants:

- Système 525/60 – structure d'échantillonnage d'image 4:1:1, débit de données 25 Mbit/s
- Système 525/60 – structure d'échantillonnage d'image 4:2:2, débit de données 50 Mbit/s
- Système 625/50 – structure d'échantillonnage d'image 4:1:1, débit de données 25 Mbit/s
- Système 625/50 – structure d'échantillonnage d'image 4:2:2, débit de données 50 Mbit/s.

La norme ne définit pas la structure de données conforme au format vidéonumérique pour l'interfaçage du son numérique, des données de sous-code et de vidéo compressée avec les paramètres suivants:

- Système 625/50 – Structure d'échantillonnage d'image 4:2:0, débit de données 25 Mbit/s.

Dans la structure à 50 Mbit/s, les données d'une image vidéo sont réparties entre deux voies. Chaque voie est divisée en 10 séquences d'interface numérique pour le système 525/60, en 12 pour le système 625/50.

Dans la structure à 25 Mbit/s, les données d'une image vidéo sont réparties en 10 séquences d'interface numérique pour le système 525/60, en 12 pour le système 625/50.

NOTE 1 – La norme SMPTE 314M-1999 est donnée dans l'Annexe 1. La norme 314M-1999 et son résumé renvoient uniquement à la version 1999, qui est celle qui a été approuvée, en application de la Résolution UIT-R 1-3, le 03-05-03, par les Administrations des Etats Membres de l'UIT. Comme convenu entre l'UIT et la SMPTE, ladite version a été fournie par la SMPTE qui en a autorisé l'utilisation et l'UIT-R a accepté de l'inclure dans la présente Recommandation. Toute version ultérieure de la norme SMPTE 314M qui n'aurait pas été agréée et approuvée par la Commission d'études 6 des radiocommunications, n'entre pas dans le cadre de la présente Recommandation. Pour des versions ultérieures de documents SMPTE, le lecteur est prié de consulter le site web de la SMPTE à l'adresse suivante: <http://www.smpite.org/>.

SMPTE STANDARD

SMPTE 314M-1999

for Television — Data Structure for DV-Based Audio, Data and Compressed Video — 25 and 50 Mb/s



Page 1 of 46 pages

Table of contents

- 1 Scope
- 2 Normative references
- 3 Acronyms
- 4 Interface
- 5 Video compression
- Annex A Differences between IEC 61834 and SMPTE 314M
- Annex B Bibliography

1 Scope

This standard defines the DV-based data structure for the interface of digital audio, subcode data, and compressed video with the following parameters:

525/60 system –
4:1:1 image sampling structure, 25 Mb/s data rate

525/60 system –
4:2:2 image sampling structure, 50 Mb/s data rate

625/50 system –
4:1:1 image sampling structure, 25 Mb/s data rate

625/50 system –
4:2:2 image sampling structure, 50 Mb/s data rate

The standard does not define the DV-compliant data structure for the interface of digital audio, subcode data, and compressed video with the following parameters:

625/50 system – 4:2:0 image sampling structure, 25 Mb/s data rate

The compression algorithm and the DIF structure conform to the DV data structure as defined in IEC

61834. The differences between the DV-based data structure defined in this standard and IEC 61834 are shown in annex A.

2 Normative references

The following standards, through reference in this text, constitute provisions of this standard. All standards are subject to revision, and parties to agreements based on this standard are encouraged to investigate the possibility of applying the most recent edition of the standards indicated below.

IEC 61834-1 (1997), Recording — Helical-Scan Digital Video Cassette Recording System Using 6,35 mm Magnetic Tape for Consumer Use (525-60, 625-50, 1125-60, and 1250-50 Systems) — Part 1: General Specifications

IEC 61834-2 (1997), Recording — Helical-Scan Digital Video Cassette Recording System Using 6,35 mm Magnetic Tape for Consumer Use (525-60, 625-50, 1125-60, and 1250-50 Systems) — Part 2: SD Format for 525-60 and 625-50 Systems

3 Acronyms

AAUX	Audio auxiliary data
AP1	Audio application ID
AP2	Video application ID
AP3	Subcode application ID
APT	Track application ID
Arb	Arbitrary
AS	AAUX source pack
ASC	AAUX source control pack
B/W	Black-and-white flag
CGMS	Copy generation management system
CM	Compressed macro block
DBN	DIF block number

CAUTION NOTICE: This Standard may be revised or withdrawn at any time. The procedures of the Standard Developer require that action be taken to reaffirm, revise, or withdraw this standard no later than five years from the date of publication. Purchasers of standards may receive current information on all standards by calling or writing the Standard Developer. Printed in USA.

SMPTE 314M-1999

DCT	Discrete cosine transform
DIF	Digital interface
DRF	Direction flag
Dseq	DIF sequence number
DSF	DIF sequence flag
DV	Identification of a compression family
EFC	Emphasis audio channel flag
EOB	End of block
FR	Identification for the first or second half of each channel
FSC	Identification of a DIF block in each channel
LF	Locked mode flag
QNO	Quantization number
QU	Quantization
Res	Reserved for future use
SCT	Section type
SMP	Sampling frequency
SSYB	Subcode sync block
STA	Status of the compressed macro block
STYPE	Signal type (see note)
Syb	Subcode sync block number
TF	Transmitting flag
VAUX	Video auxiliary data
VLC	Variable length coding
VS	VAUX source pack
VSC	VAUX source control pack

NOTE – STYPE as used in this standard is different from that in ANSI/IEEE 1394.

4 Interface

4.1 Introduction

As shown in figure 1, processed audio, video, and subcode data are output for

different applications through a digital interface port.

4.2 Data structure

The data structure of the compressed stream at the digital interface is shown in figures 2 and 3. Figure 2 shows the data structure for a 50 Mb/s structure, and figure 3 shows the data structure for a 25 Mb/s structure.

In the 50 Mb/s structure, the data of one video frame are divided into two channels. Each channel is divided into 10 DIF sequences for the 525/60 system and 12 DIF sequences for the 625/50 system.

In the 25 Mb/s structure, the data of one video frame are divided into 10 DIF sequences for the 525/60 system and 12 DIF sequences for the 625/50 system.

Each DIF sequence consists of a header section, subcode section, VAUX section, audio section, and video section with the following DIF blocks respectively:

Header section:	1 DIF block
Subcode section:	2 DIF blocks
VAUX section:	3 DIF blocks
Audio section:	9 DIF blocks
Video section:	135 DIF blocks

As shown in figures 2 and 3, each DIF block consists of a 3-byte ID and 77 bytes of data. DIF data bytes are numbered 0 to 79. Figure 4 shows the data structure of a DIF sequence for a 50 or 25 Mb/s structure.

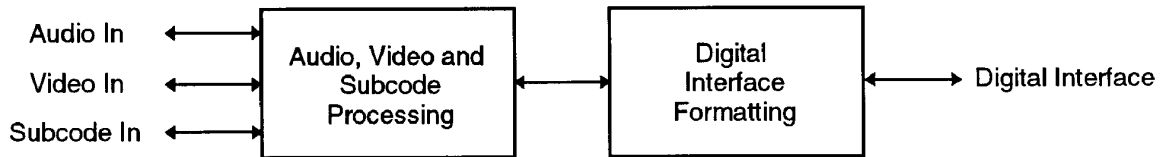

Figure 1 – Block diagram on digital interface

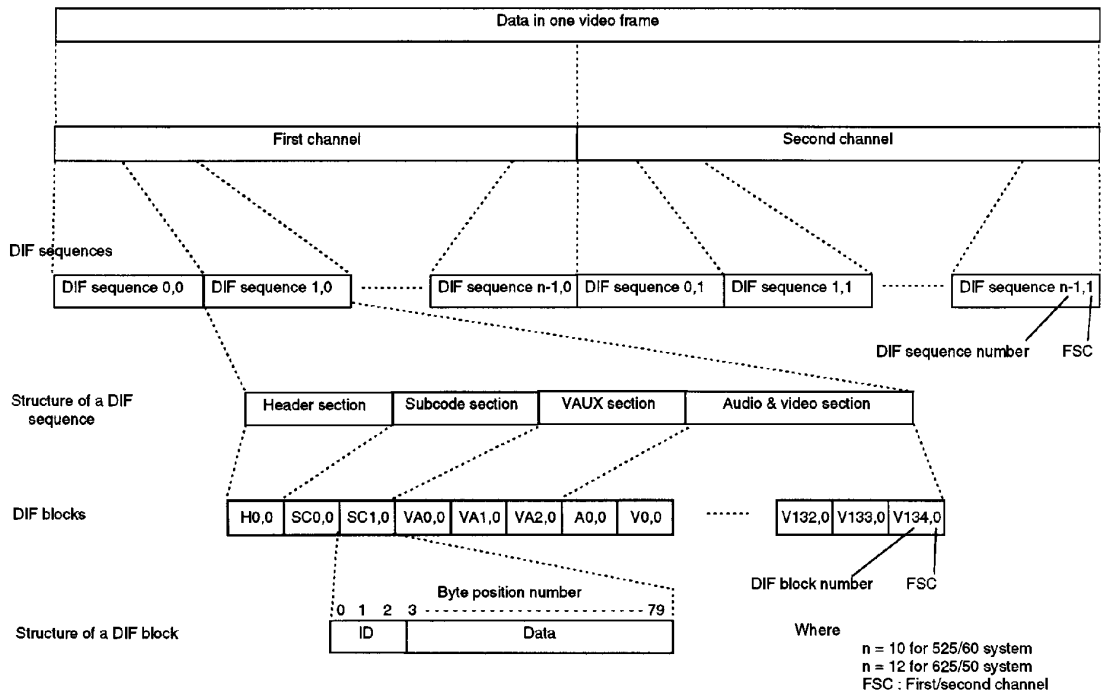

Figure 2 – Data structure of one video frame for 50 Mb/s structure

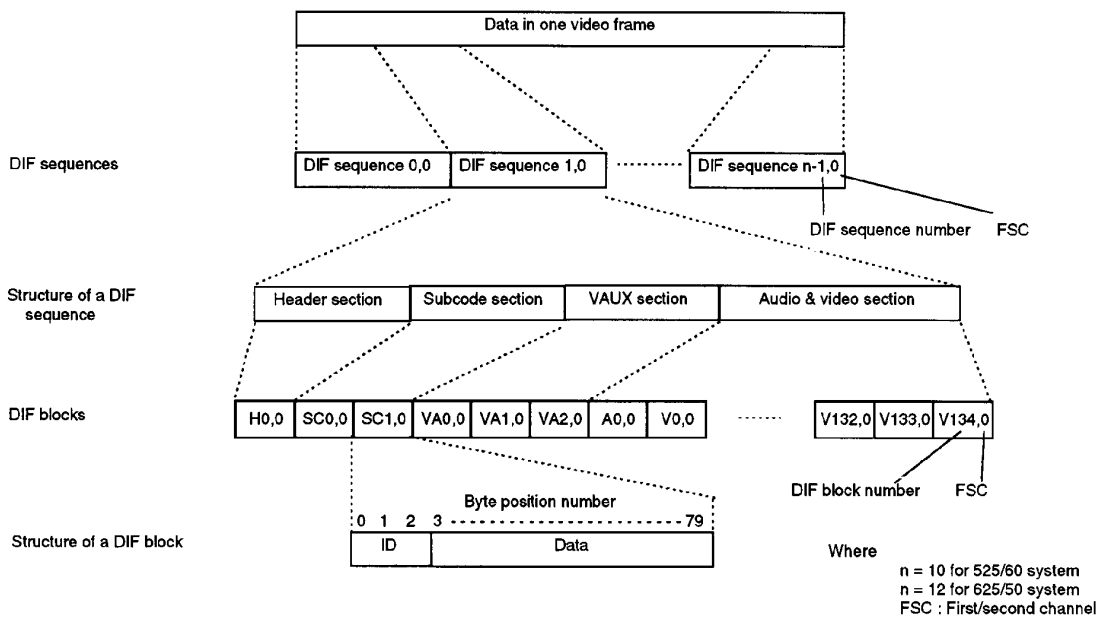
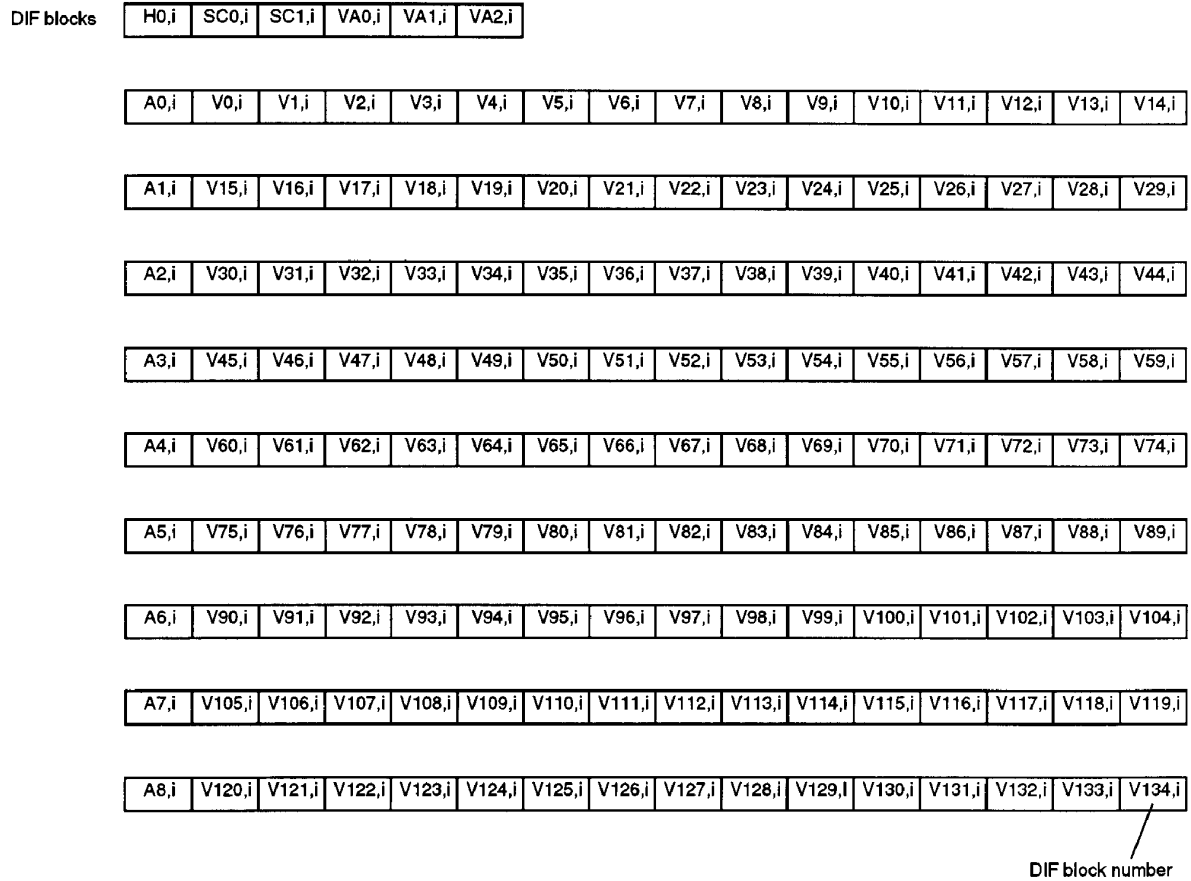

Figure 3 – Data structure of one video frame for 25 Mb/s structure

SMPTE 314M-1999



where

i : FSC
 i = 0 for 25 Mb/s structure
 i = 0,1 for 50 Mb/s structure

H0,i : DIF block in header section
 SC0,i to SC1,i : DIF blocks in subcode section
 VA0,i to VA2,i : DIF blocks in VAUX section
 A0,i to A8,i : DIF blocks in audio section
 V0,i to V134,i : DIF blocks in video section

Figure 4 – Data structure of a DIF sequence

4.3 Header section

4.3.1 ID

The ID part of each DIF block in the header section, shown in figures 2 and 3, consists of 3 bytes (ID0, ID1, ID2). Table 1 shows the ID content of a DIF block.

Table 1 – ID data of a DIF block

		Byte position number		
		Byte 0 (ID0)	Byte 1 (ID1)	Byte 2 (ID2)
MSB		SCT ₂	Dseq ₃	DBN ₇
		SCT ₁	Dseq ₂	DBN ₆
		SCT ₀	Dseq ₁	DBN ₅
		Res	Dseq ₀	DBN ₄
LSB		Arb	FSC	DBN ₃
		Arb	Res	DBN ₂
		Arb	Res	DBN ₁
		Arb	Res	DBN ₀

Table 3 – DIF sequence number for 525/60 system

Dseq ₃	Dseq ₂	Dseq ₁	Dseq ₀	Meaning
0	0	0	0	DIF sequence number 0
0	0	0	1	DIF sequence number 1
0	0	1	0	DIF sequence number 2
0	0	1	1	DIF sequence number 3
0	1	0	0	DIF sequence number 4
0	1	0	1	DIF sequence number 5
0	1	1	0	DIF sequence number 6
0	1	1	1	DIF sequence number 7
1	0	0	0	DIF sequence number 8
1	0	0	1	DIF sequence number 9
1	0	1	0	Not used
1	0	1	1	Not used
1	1	0	0	Not used
1	1	0	1	Not used
1	1	1	0	Not used
1	1	1	1	Not used

ID contains the following:

- SCT: Section type (see table 2)
- Dseq: DIF sequence number (see tables 3 and 4)
- FSC: Identification of a DIF block in each channel
 - 50 Mb/s structure
 - FSC = 0: first channel
 - FSC = 1: second channel
 - 25 Mb/s structure
 - FSC = 0
- DBN: DIF block number (see table 5)
- Arb: Arbitrary bit
- Res: Reserved bit for future use
 - Default value shall be set to 1

Table 2 – Section type

SCT ₂	SCT ₁	SCT ₀	Section type
0	0	0	Header
0	0	1	Subcode
0	1	0	VAUX
0	1	1	Audio
1	0	0	Video
1	0	1	Reserved
1	1	0	
1	1	1	

Table 4 – DIF sequence number for 625/50 system

Dseq ₃	Dseq ₂	Dseq ₁	Dseq ₀	Meaning
0	0	0	0	DIF sequence number 0
0	0	0	1	DIF sequence number 1
0	0	1	0	DIF sequence number 2
0	0	1	1	DIF sequence number 3
0	1	0	0	DIF sequence number 4
0	1	0	1	DIF sequence number 5
0	1	1	0	DIF sequence number 6
0	1	1	1	DIF sequence number 7
1	0	0	0	DIF sequence number 8
1	0	0	1	DIF sequence number 9
1	0	1	0	DIF sequence number 10
1	0	1	1	DIF sequence number 11
1	1	0	0	Not used
1	1	0	1	Not used
1	1	1	0	Not used
1	1	1	1	Not used

SMPTE 314M-1999

Table 5 – DIF block number

DBN ₇	DBN ₆	DBN ₅	DBN ₄	DBN ₃	DBN ₂	DBN ₁	DBN ₀	Meaning
0	0	0	0	0	0	0	0	DIF block number 0
0	0	0	0	0	0	0	1	DIF block number 1
0	0	0	0	0	0	1	0	DIF block number 2
0	0	0	0	0	0	1	1	DIF block number 3
⋮	⋮	⋮	⋮	⋮	⋮	⋮	⋮	⋮
1	0	0	0	0	1	1	0	DIF block number 134
1	0	0	0	0	1	1	1	Not used
⋮	⋮	⋮	⋮	⋮	⋮	⋮	⋮	⋮
1	1	1	1	1	1	1	1	Not used

4.3.2 Data

The data part (payload) of each DIF block in the header section is shown in table 6. Bytes 3 to 7 are active and bytes 8 to 79 are reserved,

Table 6 – Data (payload) in the header DIF block

		Byte position number of header DIF block							
		3	4	5	6	7	8	—	79
MSB	DSF	Res	Res	TF1	TF2	TF3	Res	Res	Res
	0	Res	Res	Res	Res	Res	Res	Res	Res
	Res	Res	Res	Res	Res	Res	Res	Res	Res
	Res	Res	Res	Res	Res	Res	Res	Res	Res
	Res	Res	Res	Res	Res	Res	Res	Res	Res
LSB	Res	APT ₂	AP1 ₂	AP2 ₂	AP3 ₂	Res	Res	Res	Res
	Res	APT ₁	AP1 ₁	AP2 ₁	AP3 ₁	Res	Res	Res	Res
	Res	APT ₀	AP1 ₀	AP2 ₀	AP3 ₀	Res	Res	Res	Res
	Res	APT ₀	AP1 ₀	AP2 ₀	AP3 ₀	Res	Res	Res	Res

DSF: DIF sequence flag

DSF = 0 : 10 DIF sequences included in a channel (525/60 system)

DSF = 1 : 12 DIF sequences included in a channel (625/50 system)

APT_n, AP1_n, AP2_n, AP3_n: These data shall be identical as track application IDs (APT_n = 001, AP1_n = 001, AP2_n = 001, AP3_n = 001), if the source signal

comes from a digital VCR. If the signal source is unknown, all bits for these data shall be set to 1.

TF: Transmitting flag:

TF1: Transmitting flag of audio DIF blocks

TF2: Transmitting flag of VAUX and video DIF blocks

TF3: Transmitting flag of subcode DIF blocks

TF_n = 0: Data shall be valid.

TF_n = 1: Data shall be invalid.

Res: Reserved bit for future use

Default value shall be set to 1.

4.4 Subcode section

4.4.1 ID

The ID part of each DIF block in the subcode section is described in 4.3.1. The section type shall be 001.

4.4.2 Data

The data part (payload) of each DIF block in the subcode section is shown in figure 5. The subcode data consists of 6 SSYBs, each 48 bytes long, and a reserved area of 29 bytes in each DIF block. SSYBs in a DIF sequence are numbered 0 to 11. Each SSYB is composed of SSYB ID equal to 2 bytes, FF_h, and an SSYB data payload of 5 bytes.

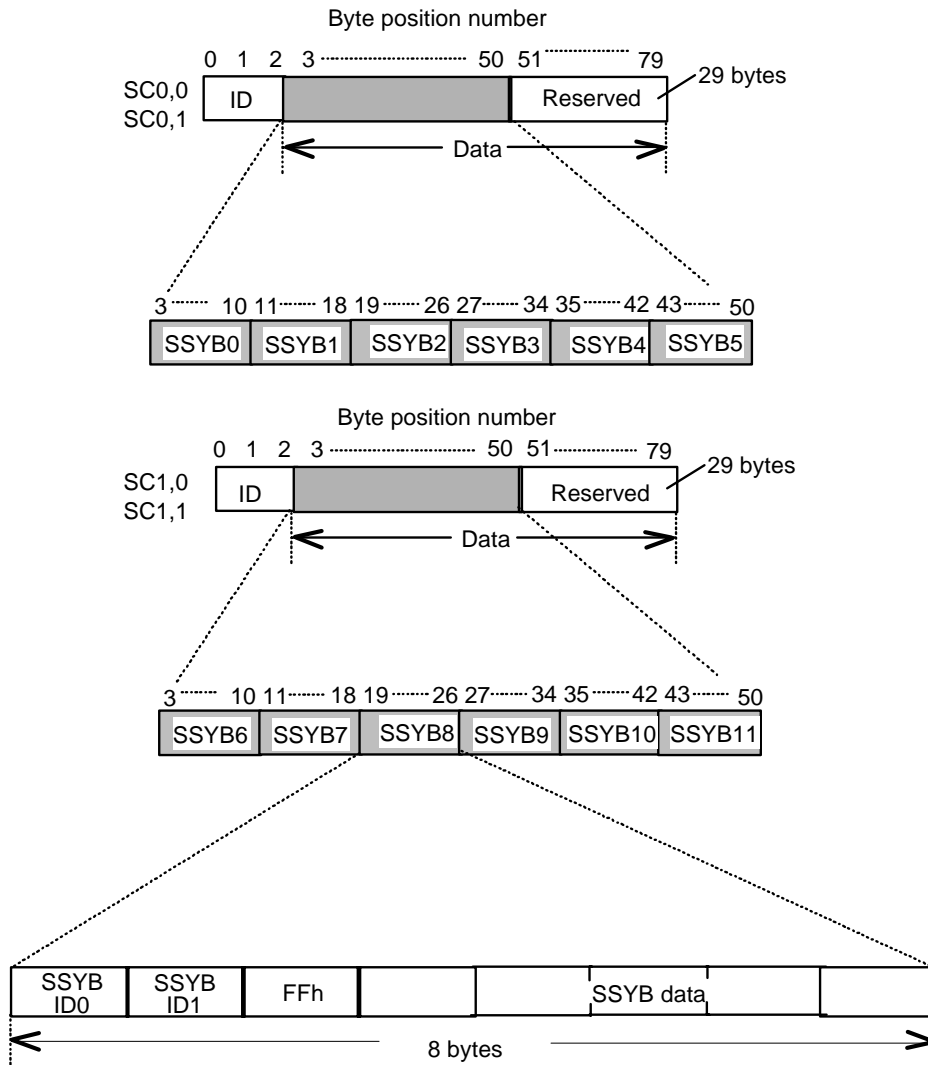

Figure 5 – Data in the subcode section

SMPTE 314M-1999

Table 7 – SSYB ID

Bit position	SSYB number 0 and 6		SSYB number 1 to 5 and 7 to 10		SSYB number 11	
	ID0	ID1	ID0	ID1	ID0	ID1
b7 (MSB)	FR	Arb	FR	Arb	FR	Arb
b6	AP3 ₂	Arb	Res	Arb	APT ₂	Arb
b5	AP3 ₁	Arb	Res	Arb	APT ₁	Arb
b4	AP3 ₀	Arb	Res	Arb	APT ₀	Arb
b3	Arb	Syb ₃	Arb	Syb ₃	Arb	Syb ₃
b2	Arb	Syb ₂	Arb	Syb ₂	Arb	Syb ₂
b1	Arb	Syb ₁	Arb	Syb ₁	Arb	Syb ₁
b0 (LSB)	Arb	Syb ₀	Arb	Syb ₀	Arb	Syb ₀

NOTE – Arb = arbitrary bit.

4.4.2.1 SSYB ID

Table 7 shows SSYB ID (ID0, ID1). These data contain FR ID, application ID (AP3₂, AP3₁, AP3₀), and SSYB number (Syb₃, Syb₂ Syb₁, Syb₀).

FR ID is an identification for the first or second half of each channel:

- FR = 1: the first half of each channel
- FR = 0: the second half of each channel

The first half of each channel

DIF sequence number 0, 1, 2, 3, 4 for the 525/60 system

DIF sequence number 0, 1, 2, 3, 4, 5 for the 625/50 system

The second half of each channel

DIF sequence number 5, 6, 7, 8, 9 for the 525/60 system

DIF sequence number 6, 7, 8, 9, 10, 11 for the 625/50 system

If information is not available, all bits shall be set to 1.

4.4.2.2 SSYB data

Each SSYB data payload consists of a pack of 5 bytes as shown in figure 6. Table 8 shows pack header table (PCO byte organization). Table 9 shows the pack arrangement in SSYB data for each channel.

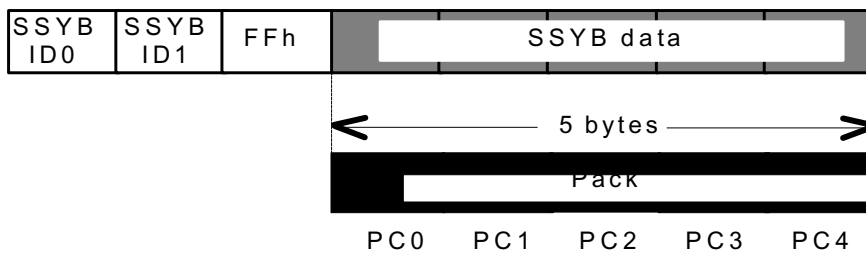

Figure 6 – Pack in SSYB

Table 8 – Pack header table

UPPER LOWER	0000	0001	0010	0011	0100	0101	0110	0111	—	1111
0000						SOURCE	SOURCE			
0001						SOURCE CONTROL	SOURCE CONTROL			
0010										
0011		TIME CODE								
0100		BINARY GROUP								
0101										
1111										NO INFO

Table 9 – Mapping of packet in SSYB data

SSYB number	First half of each channel	Second half of each channel
0	Reserved	Reserved
1	Reserved	Reserved
2	Reserved	Reserved
3	TC	TC
4	BG	Reserved
5	TC	Reserved
6	Reserved	Reserved
7	Reserved	Reserved
8	Reserved	Reserved
9	TC	TC
10	BG	Reserved
11	TC	Reserved
NOTES 1 TC = time code pack. 2 BG = binary group pack. 3 Reserved = default value of all bits shall be set to 1. 4 TC and BG data are the same within a single video frame. The time code data are an LCT type.		

SMPTE 314M-1999

4.4.2.2.1 Time code pack (TC)

Table 10 shows a mapping of the time code pack. Time code data mapped to the time code packs remain the same within each video frame.

Table 10 - Mapping of time code pack

525/60 system

MSB				LSB				
PC0	0	0	0	1	0	0	1	1
PC1	CF	DF	TENS of FRAMES		UNITS of FRAMES			
PC2	PC	TENS of SECONDS		UNITS of SECONDS				
PC3	BGF0	TENS of MINUTES		UNITS of MINUTES				
PC4	BGF2	BGF1	TENS of HOURS		UNITS of HOURS			

625/50 system

MSB				LSB				
PC0	0	0	0	1	0	0	1	1
PC1	CF	Arb	TENS of FRAMES		UNITS of FRAMES			
PC2	BGF0	TENS of MINUTES		UNITS of SECONDS				
PC3	BGF2	TENS of MINUTES		UNITS of MINUTES				
PC4	PC	BGF1	TENS of HOURS		UNITS of HOURS			

NOTE – Detailed information is given in ANSI/SMPTE 12M.

CF: Color fame

- 0 = unsynchronized mode
- 1 = synchronized mode

DF: Drop frame flag

- 0 = Nondrop frame time code
- 1 = Drop frame time code

PC: Biphase mark polarity correction

- 0 = even
- 1 = odd

BGF: Binary group flag

Arb: Arbitrary bit

4.4.2.2.2 Binary group pack (BG)

Table 11 shows the mapping of the binary group pack. Binary group data mapped to the binary group packs remain the same within each video frame.

Table 11 – Mapping of binary group pack

MSB					LSB			
PC0	0	0	0	1	0	1	0	0
PC1	BINARY GROUP 2				BINARY GROUP 1			
PC2	BINARY GROUP 4				BINARY GROUP 3			
PC3	BINARY GROUP 6				BINARY GROUP 5			
PC4	BINARY GROUP 8				BINARY GROUP 7			

4.5 VAUX section

4.5.1 1D

The ID part of each DIF block in the VAUX section is described in 4.3.1. The section type shall be 010.

4.5.2 Data

The data part (payload) of each DIF block in the VAUX section is shown in figure 7. This figure shows the VAUX pack arrangement for each DIF sequence.

There are 15 packs, each 5 bytes long, and two reserved bytes in each VAUX DIF block payload. A default value for the reserved byte is set to FF_h.

Therefore, there are 45 packs in a DIF sequence. VAUX packs of the DIF blocks are sequentially numbered 0 to 44. This number is called a video pack number.

Table 12 shows the mapping of the VAUX packs of the VAUX DIF blocks. A VAUX source pack (VS) and a VAUX source control pack (VSC) must be present in each of the video compressed frames. The remaining VAUX packs of the DIF blocks in a DIF sequence are reserved and the value of all reserved words is set to FF_h.

If VAUX data are not transmitted, a NO INFO pack, which is filled up by FF_h, shall be transmitted.

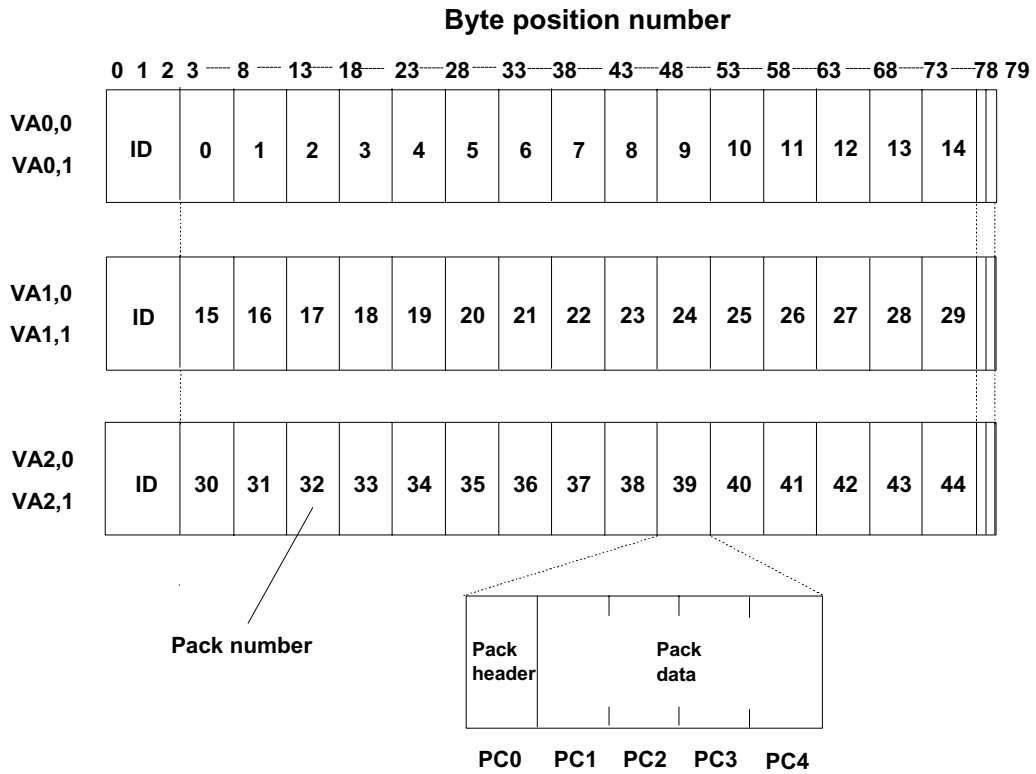

Figure 7 – Data in the VAUX section

Table 12 – Mapping of VAUX pack in a DIF sequence

Pack number		Pack data
Even DIF sequence	Odd DIF sequence	
39	0	VS
40	1	VSC

where

Even DIF sequence:

- DIF sequence number 0, 2, 4, 6, 8 for 525/60 system
- DIF sequence number 0, 2, 4, 6, 8, 10 for 625/50 system

Odd DIF sequence:

- DIF sequence number 1, 3, 5, 7, 9 for 525/60 system
- DIF sequence number 1, 3, 5, 7, 9, 11 for 625/50 system

SMPTE 314M-1999

4.5.2.1 VAUX source pack (VS)

Table 13 shows the mapping of a VAUX source pack.

Table 13 – Mapping of VAUX source pack

	MSB				LSB			
PC0	0	1	1	0	0	0	0	0
PC1	Res	Res	Res	Res	Res	Res	Res	Res
PC2	B/W	EN	CLF		Res	Res	Res	Res
PC3	Res	Res	50/60	STYPE				
PC4	VISC							

B/W: Black-and-white flag
 0 = Black and white
 1 = Color

EN: Color frames enable flag
 0 = CLF is valid
 1 = CLF is invalid

CLF: Color frames identification code (see ITU-R BT.470-4)
 For 525/60 system
 00b = Color frame A
 01b = Color frame B
 Others = Reserved

For 625/50 system
 00b = 1st, 2nd field
 01b = 3rd, 4th field
 10b = 5th, 6th field
 11b = 7th, 8th field

50/60:
 0 = 60-field system
 1 = 50-field system

STYPE: STYPE defines a signal type of video signal
 00000b = 4:1:1 compression
 00001b = Reserved
 | |
 00011b = Reserved
 00100b = 4:2:2 compression
 00101b = Reserved
 | |
 11111b = Reserved

VISC:
 10001000b = -180
 | |
 00000000b = 0
 | |
 01111000b = 180
 01111111b = No information
 Other = Reserved

Res: Reserved bit for future use
 Default value shall be set to 1

4.5.2.2 VAUX source control pack (VSC)

Table 14 shows the mapping of the VAUX source control pack.

Table 14 – Mapping of VAUX source control pack

	MSB						LSB	
PC0	0	1	1	0	0	0	0	1
PC1	CGMS		Res	Res	Res	Res	Res	Res
PC2	Res	Res	0	0	Res	DISP		
PC3	FF	FS	FC	IL	Res	Res	0	0
PC4	Res	Res	Res	Res	Res	Res	Res	Res

CGMS: Copy generation management system

CGMS	Copy possible generation
0 0	Copy free
0 1	Reserved
1 0	
1 1	

DISP: Display select mode

DISP	Aspect ratio and format	Position
0 0 0	4:3 full format	Not applicable
0 0 1	Reserved	
0 1 0	16:9 full format (squeeze)	Not applicable
0 1 1 1 1 1	Reserved	

FF: Frame/field flag

FF indicates whether two consecutive fields are delivered, or one field is repeated twice during one frame period.

0 = Only one of two fields is delivered twice; 1 = Both fields are delivered in order.

FS: First/second field flag

FS indicates a field which is delivered during the field one period.

0 = Field 2 is delivered; 1 = Field 1 is delivered.

FF	FS	Output field
1	1	Field 1 and field 2 are output in this order (1,2 sequence)
1	0	Field 2 and field 1 are output in this order (2,1 sequence)
0	1	Field 1 is output twice
0	0	Field 2 is output twice

FC: Frame change flag

FC indicates whether the picture of the current frame is repeated based on the immediate previous frame.

0 = Same picture as the previous frame; 1 = Different picture from the previous frame

IL: Interlace flag

0 = Noninterlaced; 1 = Interlaced

Res: Reserved bit for future use

Default value shall be set to 1.

SMPTE 314M-1999

4.6 Audio section

4.6.1 ID

The ID part of each DIF block in the audio section is described in 4.3.1. The section type shall be 011.

4.6.2 Data

The data part (payload) of each DIF block in the audio section is shown in figure 8. The data of a DIF block in the audio DIF block are composed of 5 bytes of audio auxiliary data (AAUX) and 72 bytes of audio data which are encoded and shuffled by the process shown in figure 8.

4.6.2.1 Audio encoding

4.6.2.1.1 Source coding

Each audio input signal is sampled at 48 kHz, with 16-bit quantization. The system provides two channels of audio for 25 Mb/s structure or four channels of audio for 50 Mb/s structure. Audio data for each audio channel are located in an audio block respectively.

An audio block consists of 45 DIF blocks (9 DIF blocks × 5 DIF sequences) for the 525/60 system; and 54 DIF blocks (9 DIF blocks × 6 DIF sequences) for the 625/50 system.

4.6.2.1.2 Emphasis

Audio encoding is carried out with the first order preemphasis of 50/15 μs. For analog input recording, emphasis shall be off in the default state.

4.6.2.1.3 Audio error code

In the encoded audio data, 8000_h shall be assigned as an audio error code to indicate an invalid audio

sample. This code corresponds to negative full-scale value in ordinary twos complement representation. When the encoded data includes 8000_h, it shall be converted to 8001_h.

4.6.2.1.4 Relative audio-video timing

The audio frame duration equals a video frame period. An audio frame begins with an audio sample acquired within the duration of minus 50 samples relative to zero samples from the first preequalizing pulse of the vertical blanking period of the input video signal. The first preequalizing pulse means the start of line number 1 for the 525/60 system, and the middle of line number 623 for the 625/50 system.

4.6.2.1.5 Audio frame processing

This standard provides audio frame processing in the locked mode.

The sampling frequency of the audio signal is synchronous with the video frame frequency. Audio data are processed in frames. For an audio channel, each frame contains 1602 or 1600 audio samples for the 525/60 system or 1920 audio samples for the 625/50 system. For the 525/60 system, the number of audio samples per frame shall follow the five-frame sequence as shown below:

1600, 1602, 1602, 1602, 1602 samples.

The sample audio capacity shall be capable of 1620 samples per frame for the 525/60 system or 1944 samples per frame for the 625/50 system. The unused space at the end of each frame is filled with arbitrary values.

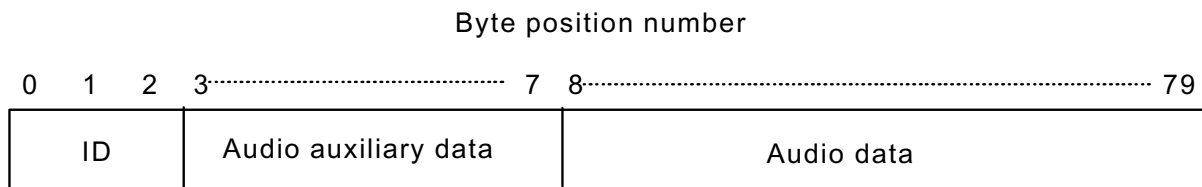

Figure 8 – Data in the audio section

4.6.2.2 Audio shuffling

The 16-bit audio data word is divided into two bytes; the upper byte which contains MSB, and the lower byte LSB, as shown in figure 9. Audio data shall be shuffled over DIF sequences and DIF blocks within a frame. The data bytes are defined as D_n ($n = 0, 1, 2, \dots$) which is sampled at n th order within a frame and shuffled by each D_n unit.

The data shall be shuffled through a process expressed by the following equations:

525/60 system:

DIF sequence number:
 $(INT(n/3) + 2 \times (n \bmod 3)) \bmod 5$ for CH1, CH3
 $(INT(n/3) + 2 \times (n \bmod 3)) \bmod 5 + 5$ for CH2, CH4

Audio DIF block number:
 $3 \times (n \bmod 3) + INT((n \bmod 45) / 15)$
 where FSC = 0: CH1, CH2
 FSC = 1: CH3, CH4

Byte position number:
 $8 + 2 \times INT(n/45)$ for the most significant byte
 $9 + 2 \times INT(n/45)$ for the least significant byte
 where $n = 0$ to 1619

625/50 system:

DIF sequence number:
 $(INT(n/3) + 2 \times (n \bmod 3)) \bmod 6$ for CH1, CH3
 $(INT(n/3) + 2 \times (n \bmod 3)) \bmod 6 + 6$ for CH2, CH4

Audio DIF block number:
 $3 \times (n \bmod 3) + INT((n \bmod 54) / 18)$
 where FSC = 0: CH1, CH2
 FSC = 1: CH3, CH4

Byte position number:
 $8 + 2 \times INT(n/54)$ for the most significant byte
 $9 + 2 \times INT(n/54)$ for the least significant byte
 where $n = 0$ to 1943

4.6.2.3 Audio auxiliary data (AAUX)

AAUX shall be added to the shuffled audio data as shown in figures 8 and 10. The AAUX pack shall include an AAUX pack header and data (AAUX payload). The length of the AAUX pack shall be 5 bytes as shown in figure 10, which depicts the AAUX pack arrangement. Packs are numbered from 0 to 8 as shown in figure 10. This number is called an audio pack number.

Table 15 shows the mapping of an AAUX pack. An AAUX source pack (AS) and an AAUX source control pack (ASC) must be included in the compressed stream.

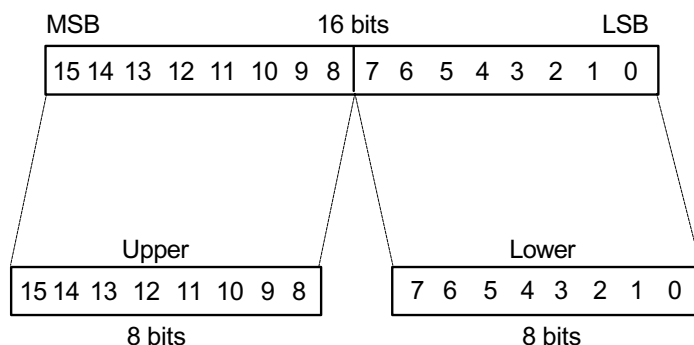

Figure 9 – Conversion of audio sample to audio data bytes

SMPTE 314M-1999

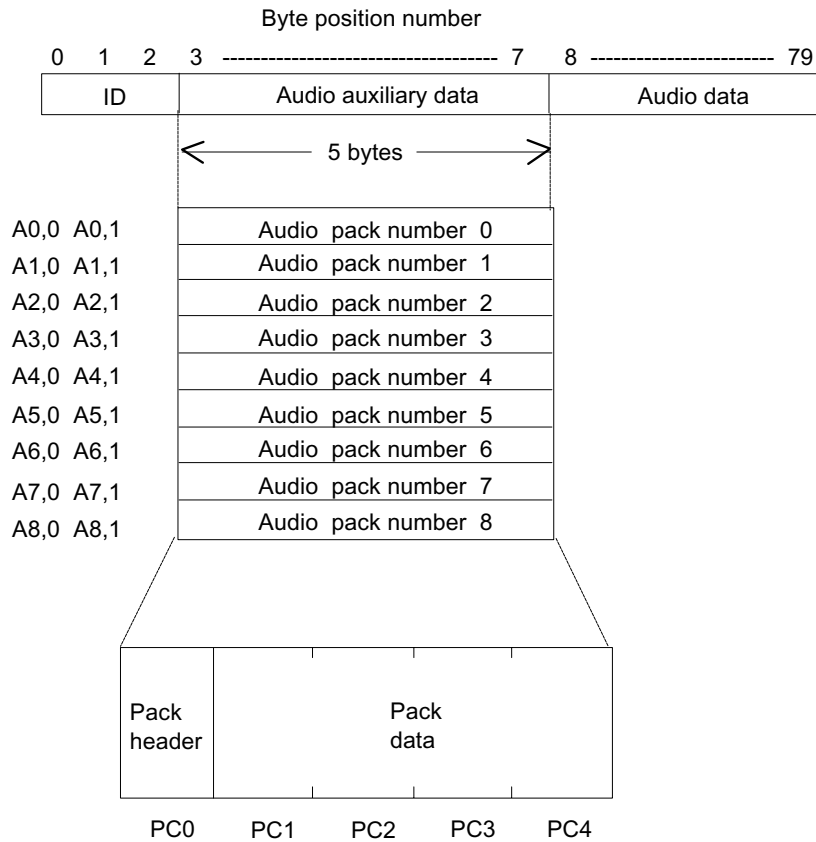

Figure 10 – Arrangement of AAUX packs in audio auxiliary data

Table 15 – Mapping of AAUX pack in a DIF sequence

Audio pack number		Pack data
Even DIF sequence	Odd DIF sequence	
3	0	AS
4	1	ASC

where

Even DIF sequence:

DIF sequence number 0, 2, 4, 6, 8 for 525/60 system
 DIF sequence number 0, 2, 4, 6, 8, 10 for 625/50 system

Odd DIF sequence:

DIF sequence number 1, 3, 5, 7, 9 for 525/60 system
 DIF sequence number 1, 3, 5, 7, 9, 11 for 625/50 system

4.6.2.3.1 AAUX source pack (AS)

The AAUX source pack is configured as shown in table 16.

Table 16 – Mapping of AAUX source pack

	MSB						LSB	
PC0	0	1	0	1	0	0	0	0
PC1	LF	Res	AF SIZE					
PC2	0	CHN		Res	AUDIO MODE			
PC3	Res	Res	50/60	STYPE				
PC4	Res	Res	SMP			QU		

LF: Locked mode flag

Locking condition of audio sampling frequency with video signal
 0 = Locked mode; 1 = Reserved

AF SIZE: The number of audio samples per frame

- 010100b = 1600 samples/frame (525/60 system)
- 010110b = 1602 samples/frame (525/60 system)
- 011000b = 1920 samples/frame (625/50 system)
- Others = Reserved

CHN: The number of audio channels within an audio block

- 00b = One audio channel per audio block
- Others = Reserved

The audio block is composed of 45 DIF blocks of the audio section in five consecutive DIF sequences for the 525/60 system, and 54 DIF blocks of the audio section in six consecutive DIF sequences for the 625/50 system.

AUDIO MODE: The contents of the audio signal on each audio channel

- 0000b = CH1 (CH3)
- 0001b = CH2 (CH4)
- 1111b = Invalid audio data
- Others = Reserved

50/60:

- 0 = 60-field system
- 1 = 50-field system

STYPE: STYPE defines audio blocks per video frame

- 00000b = 2 audio blocks
- 00010b = 4 audio blocks
- Others = Reserved

SMP: Sampling frequency

- 000b = 48 kHz
- Others = Reserved

QU: Quantization

- 000b = 16 bits linear
- Others = Reserved

Res: Reserved bit for future use

Default value shall be set to 1

SMPTE 314M-1999

4.6.2.3.2 AAUX source control pack (ASC)

The AAUX source control pack is configured as shown in table 17.

Table 17 – Mapping of AAUX source control pack

	MSB						LSB	
PC0	0	1	0	1	0	0	0	1
PC1	CGMS			Res	Res	Res	Res	EFC
PC2	REC ST	REC END	FADE ST	FADE END	Res	Res	Res	Res
PC3	DRF	SPEED						
PC4	Res	Res	Res	Res	Res	Res	Res	Res

CGMS: Copy generation management system

CGMS	Copy possible generation
0 0	Copy free
0 1	Reserved
1 0	
1 1	

EFC: Emphasis audio channel flag

00b = emphasis off

01b = emphasis on

Others = reserved

EFC shall be set for each audio block.

REC ST: Recording start point

0 = recording start point

1 = not recording start point

At a recording start frame, REC ST 0 lasts for a duration of one audio block which is equal to 5 or 6 DIF sequences for each audio channel.

REC END: Recording end point

0 = recording end point

1 = not recording end point

At a recording end frame, REC END 0 lasts for a duration of one audio block which is equal to 5 or 6 DIF sequences for each audio channel.

FADE ST: Fading of recording start point

0 = fading off

1 = fading on

The information of FADE ST shall be effective only at the recording start frame (REC ST = 0).

If FADE ST is 1 at the recording start frame, the output audio signal should be faded in from the first sampling signal of the frame. If FADE ST is 0 at the recording start frame, the output audio signal should not be faded.

FADE END: Fading of recording end point

0 = fading off

1 = fading on

The information of FADE END shall be effective only at the recording end frame (REC END = 0).

If FADE END is 1 at the recording end frame, the output audio signal should be faded out to the last sampling signal of the frame. If FADE END is 0 at the recording end frame, the output audio signal should not be faded.

DRF: Direction flag

0 = reverse direction

1 = forward direction

SPEED: Shuttle speed ov VTR

SPEED	Shuttle speed of VTR	
	525/60 system	625/50 system
0000000	0/120 (=0)	0/100 (=0)
0000001	1/120	1/100
:	:	:
1100100	100/120	100/100 (=1)
:	:	Reserved
1111000	120/120 (=1)	Reserved
:	Reserved	Reserved
1111110	Reserved	Reserved
1111111	Data invalid	Data invlaid

RES: Reserved bit for future use.
Default value shall be set to 1.

4.7 Video section

4.7.1 ID

The ID part of each DIF block in the video section is described in 4.3.1. The section type shall be 100.

4.7.2 Data

The data part (payload) of each DIF block in the video section consists of 77 bytes of video data which shall be sampled, shuffled, and encoded. Video data of every video frame are processed as described in clause 4.

4.7.2.1 DIF block and compressed macro block

Correspondence between video DIF blocks and video compressed macro blocks is shown in tables 18 and 19. Table 18 shows correspondence between video DIF blocks for 50 Mb/s structure and video compressed macro blocks of 4:2:2 compression. Table 19 shows correspondence between the video DIF blocks for 25 Mb/s structure and video compressed macro blocks of 4:1:1 compression.

The rule defining the correspondence between video DIF blocks and compressed macro blocks is shown below:

50 Mb/s structure – 4:2:2 compression
 if (525/60 system) n = 10 else n = 12;
 for (i = 0; i < n; i++){
 a = i;
 b = (i - 6) mod n;
 c = (i - 2) mod n;

```

d = (i - 8) mod n;
e = (i - 4) mod n;
p = a;
q = 3;
for (j = 0; j < 5; j++){
  for (k = 0; k < 27; k++){
    V (5 × k + q), 0 of DSNp = CM 2i,j,k;
    V (5 × k + q), 1 of DSNp = CM 2i + 1,j,k;
  }
  if (q == 3) {p = b; q = 1;}
  else if (q == 1) {p = c; q = 0;}
  else if (q == 0) {p = d; q = 2;}
  else if (q == 2) {p = e; q = 4;}
}

```

```

25 Mb/s structure -- 4:1:1 compression
if (525/60 system) n = 10 else n = 12;
for (i = 0; i < n; i++){
  a = i;
  b = (i - 6) mod n;
  c = (i - 2) mod n;
  d = (i - 8) mod n;
  e = (i - 4) mod n;
  p = a;
  q = 3;
  for (j = 0; j < 5; j++){
    for (k = 0; k < 27; k++){
      V (5 × k + q) of DSNp = CM 2i,j,k;
    }
    if (q == 3) {p = b; q = 1;}
    else if (q == 1) {p = c; q = 0;}
    else if (q == 0) {p = d; q = 2;}
    else if (q == 2) {p = e; q = 4;}
  }
}

```

SMPTE 314M-1999

Table 18 – Video DIF blocks and compressed macro blocks for 50 Mb/s structure — 4:2:2 compression

DIF sequence number	DIF block	Compressed macro block
0	V0,0	CM 4,2,0
	V0,1	CM 5,2,0
	V1,0	CM 12,1,0
	V1,1	CM 13,1,0
	V2,0	CM 16,3,0
	V2,1	CM 17,3,0
	:	:
	V134,0	CM 8,4,26
	V134,1	CM 9,4,26
1	V0,0	CM 6,2,0
	V0,1	CM 7,2,0
	V1,0	CM 14,1,0
	V1,1	CM 15,1,0
	V2,0	CM 18,3,0
	V2,1	CM 19,3,0
	:	:
	V134,0	CM 10,4,26
	V134,1	CM 11,4,26
⋮	⋮	⋮
n-1	V0,0	CM 2,2,0
	V0,1	CM 3,2,0
	V1,0	CM 10,1,0
	V1,1	CM 11,1,0
	V2,0	CM 14,3,0
	V2,1	CM 15,3,0
	:	:
	V134,0	CM 6,4,26
	V134,1	CM 7,4,26
NOTE – n = 10 for 525/60 system; n = 12 for 625/50 system.		

Table 19 – Video DIF blocks and compressed macro blocks for 25 Mb/s structure — 4:1:1 compression

DIF sequence number	DIF block	Compressed macro block
0	V0,0	CM 2,2,0
	V1,0	CM 6,1,0
	V2,0	CM 8,3,0
	V3,0	CM 0,0,0
	V4,0	CM 4,4,0
	:	:
	V133,0	CM 0,0,26
	V134,0	CM 4,4,26
1	V0,0	CM 3,2,0
	V1,0	CM 7,1,0
	V2,0	CM 9,3,0
	V3,0	CM 1,0,0
	V4,0	CM 5,4,0
	:	:
	V133,0	CM 1,0,26
	V134,0	CM 5,4,26
⋮	⋮	⋮
n-1	V0,0	CM 1,2,0
	V1,0	CM 5,1,0
	V2,0	CM 7,3,0
	V3,0	CM n - 1,0,0
	V4,0	CM 3,4,0
	:	:
	V133,0	CM n - 1,0,26
	V134,0	CM 3,4,26
NOTE – n = 10 for 525/60 system; n = 12 for 625/50 system.		

SMPTE 314M-1999

5 Video compression

This clause includes video compression processing for 4:2:2 and 4:1:1 compression.

5.1 Video structure

The video signal is sampled with a frequency of 13.5 MHz for luminance (Y) and 6.75 MHz for color difference (C_R, C_B). The data of the vertical blanking area and the horizontal blanking area are discarded, then the remainder of the video data is shuffled in the video frame. The original quantity of video data shall be reduced by use of bit-rate reduction techniques which adopt DCT and VLC.

The process of the bit-rate reduction is as follows: Video data are assigned to a DCT block (8×8 samples). Two luminance DCT blocks and two color-difference DCT blocks form a macro block for 4:2:2 compression. For 4:1:1 compression, four luminance DCT blocks and two color-difference DCT blocks form a macro block. Five macro blocks constitute a video segment. A video segment is further compressed into five compressed macro blocks by use of the DCT and VLC techniques.

5.1.1 Sampling structure

The sampling structure is identical to the sampling structure of 4:2:2 component television signals described in ITU-R BT.601. Sampling of luminance (Y)

and two color-difference signals (C_R, C_B) in the 4:2:2 structure are described in table 20.

Line structure in one frame

For the 525/60 system, 240 lines for Y, C_R, and C_B signals from each field shall be transmitted. For the 625/50 system, 288 lines for Y, C_R, and C_B signals from each field shall be transmitted. The transmitted lines on a TV frame are defined in table 20.

Pixel structure in one frame

4:2:2 compression –

All sampled pixels, 720 luminance pixels per line and 360 color-difference pixels, are retained for processing as shown in figures 11 and 12. The sampling process starts simultaneously for both luminance and color-difference signals. Each pixel has a value from –127 to +126 which is obtained by the subtraction of 128 from the input video signal level.

4:1:1 compression –

All sampled luminance pixels, 720 pixels per line, are retained for processing. Of 360 color-difference pixels sampled per line, every other pixel is discarded, leaving 180 pixels for processing. The sampling process starts simultaneously for both luminance and color-difference signals. Figures 13 and 14 show the sampling process in detail. Each pixel has a value in range from –127 to +126 which is obtained by the subtraction of 128 from the input video signal level.

Table 20 – Construction of video signal sampling (4:2:2)

		525/60 system	625/50 system
Sampling frequency	Y	13.5 MHz	
	C _R , C _B	6.75 MHz	
Total number of pixels per frame	Y	858	864
	C _R , C _B	429	432
Number of active pixels per line	Y	720	
	C _R , C _B	360	
Total number of lines per frame		525	625
Number of active lines per frame		480	576
Active line numbers	Field 1	23 to 262	23 to 310
	Field 2	285 to 524	335 to 622
Quantization		Each sample is linearly quantized to 8 bits for Y, C _R , C _B	
Relation between video signal level and quantized level	Scale	1 to 254	
	Y	Video signal level of white: 235	Quantized level 220
		Video signal level of black: 16	
	C _R , C _B	Video signal level of gray: 128	Quantized level 225

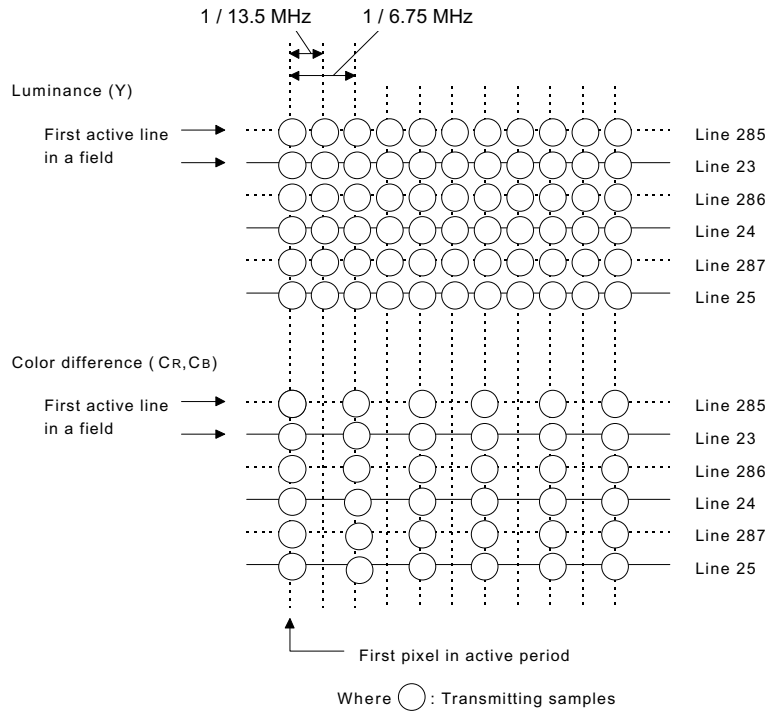

Figure 11 – Transmitting samples of 525/60 system for 4:2:2 compression

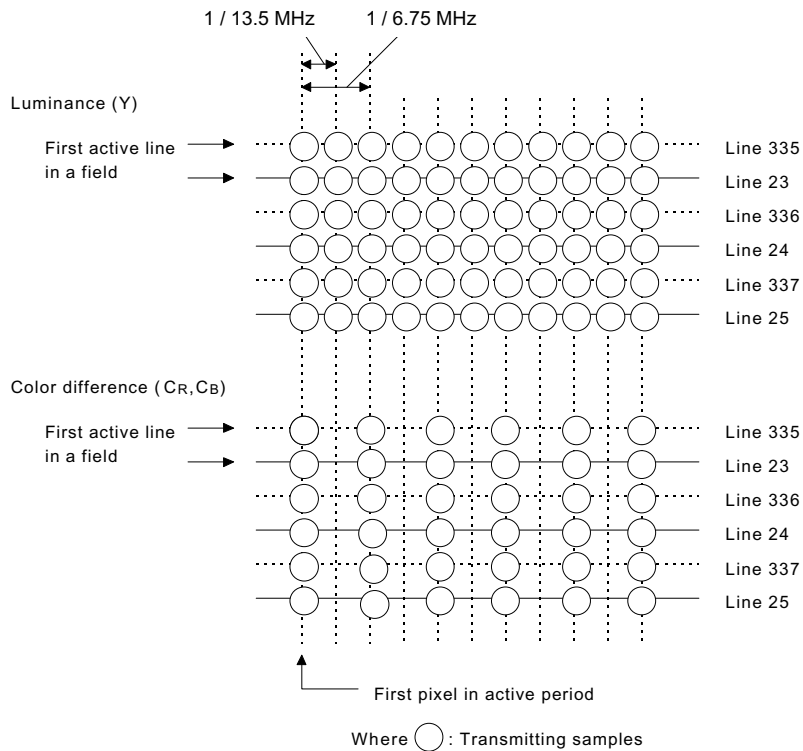

Figure 12 – Transmitting samples of 625/50 system for 4:2:2 compression

SMPTE 314M-1999

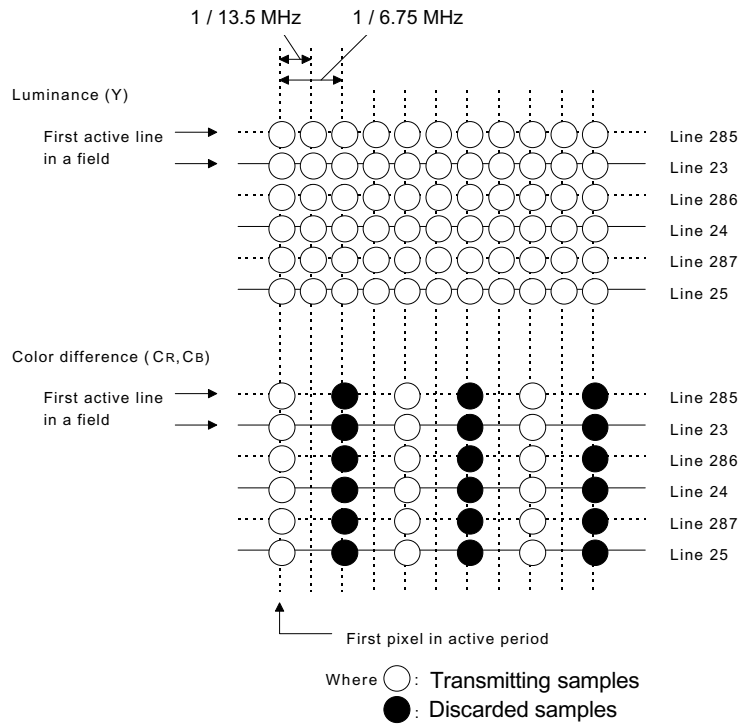

Figure 13 – Transmitting samples of 525/60 system for 4:1:1 compression

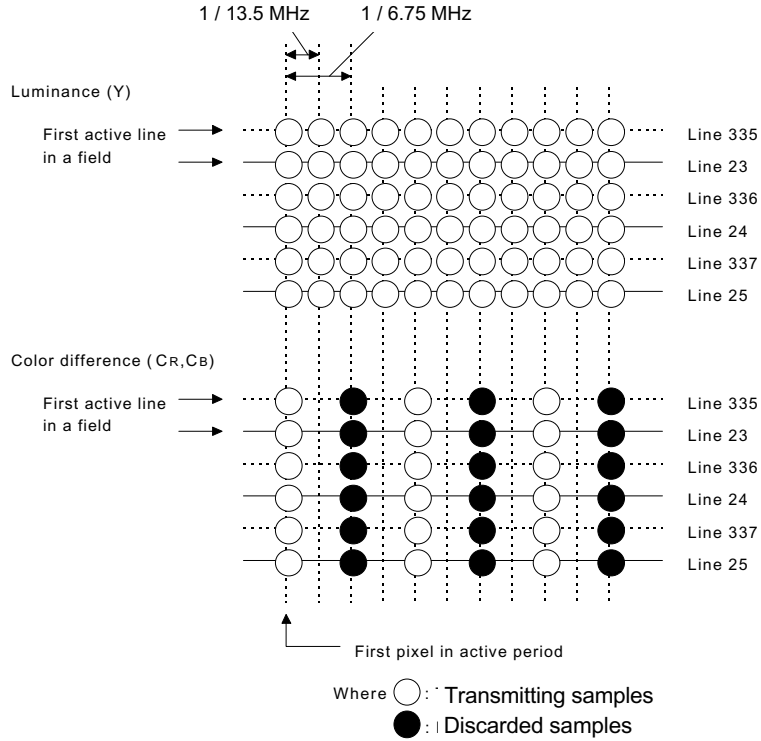

Figure 14 – Transmitting samples of 625/50 system for 4:1:1 compression

5.1.2 DCT block

The Y, C_R, and C_B pixels in one frame shall be divided into DCT blocks as shown in figure 15. All DCT blocks for 4:2:2 compression and DCT blocks for 4:1:1 compression, with the exception of the rightmost DCT blocks in C_R and C_B for 4:1:1 compression, are structured as a rectangular area of eight vertical lines and eight horizontal pixels for each DCT block. The value of x shows the horizontal coordinate from the left and the value of y shows the vertical coordinate from the top. Odd lines of y = 1, 3, 5, 7 are the horizontal lines of field one, and even lines of y = 0, 2, 4, 6 are those of field two.

In the 4:1:1 compression mode, the rightmost DCT blocks in C_R and C_B are structured with 16 vertical lines and four horizontal pixels. The rightmost DCT block shall be reconstructed to eight vertical lines and eight horizontal pixels by moving the lower part of eight vertical lines and four horizontal pixels to the higher part of eight vertical lines and four horizontal pixels as shown in figure 16.

DCT block arrangement in one frame for 525/60 blocks

The arrangement of horizontal DCT blocks in one frame in the 4:2:2 compression mode is shown in figure 17, and in the 4:1:1 compression mode in figure 18. The same horizontal arrangement is repeated with 60 DCT blocks in the vertical direction. Pixels in one frame are divided into 10,800 DCT blocks for 4:2:2 compression and 8,100 DCT blocks for 4:1:1 compression.

4:2:2 compression

Y: 60 vertical DCT blocks × 90 horizontal DCT blocks
= 5400 DCT blocks

C_R: 60 vertical DCT blocks × 45 horizontal DCT blocks
= 2700 DCT blocks

C_B: 60 vertical DCT blocks × 45 horizontal DCT blocks
= 2700 DCT blocks

4:1:1 compression

Y: 60 vertical DCT blocks × 90 horizontal DCT blocks
= 5400 DCT blocks

C_R: 60 vertical DCT blocks × 22.5 horizontal DCT blocks
= 1350 DCT blocks

C_B: 60 vertical DCT blocks × 22.5 horizontal DCT blocks
= 1350 DCT blocks

DCT block arrangement in one frame for 625/50 blocks

The arrangement of horizontal DCT blocks in one frame for the 4:2:2 compression mode is shown in figure 17, and for the 4:1:1 compression mode in figure 18. The same horizontal arrangement is repeated to 72 DCT blocks in the vertical direction. Pixels in one frame are divided into 12,960 DCT blocks for 4:2:2 compression and 9,720 DCT blocks for 4:1:1 compression.

4:2:2 compression

Y: 72 vertical DCT blocks × 90 horizontal DCT blocks
= 6480 DCT blocks

C_R: 72 vertical DCT blocks × 45 horizontal DCT blocks
= 3240 DCT blocks

C_B: 72 vertical DCT blocks × 45 horizontal DCT blocks
= 3240 DCT blocks

4:1:1 compression

Y: 72 vertical DCT blocks × 90 horizontal DCT blocks
= 6480 DCT blocks

C_R: 72 vertical DCT blocks × 22.5 horizontal DCT blocks
= 1620 DCT blocks

C_B: 72 vertical DCT blocks × 22.5 horizontal DCT blocks
= 1620 DCT blocks

5.1.3 Macro block

As shown in figure 19, each macro block in the 4:2:2 compression mode consists of four DCT blocks. As shown in figure 20, each macro block in the 4:1:1 compression mode consists of six DCT blocks. In the 4:1:1 compression mode, each macro block consists of four horizontally adjacent DCT blocks of Y, one DCT block of C_R, and one DCT block of C_B on a television screen. The rightmost macro block on the television screen consists of four vertically and horizontally adjacent DCT blocks of Y, one DCT block of C_R, and one DCT block of C_B.

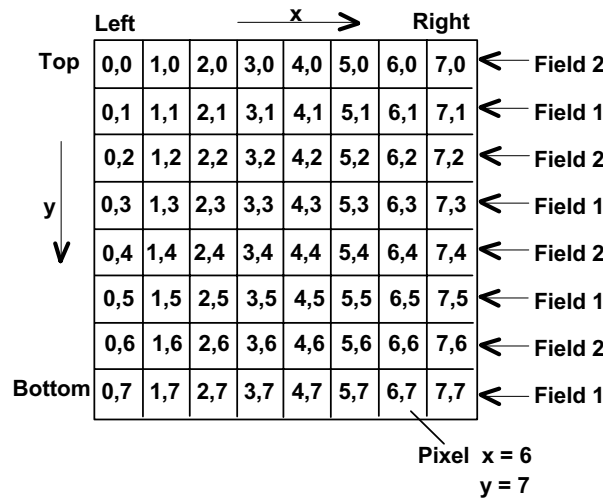

Figure 15 – DCT block and pixel coordinates

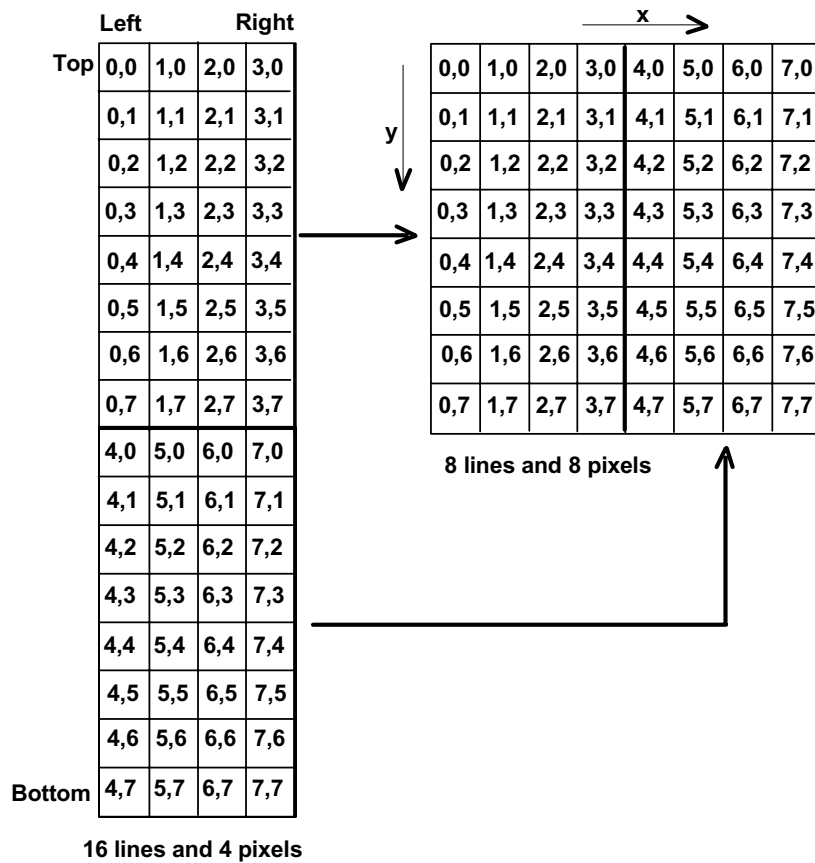
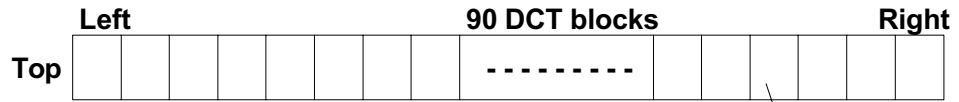
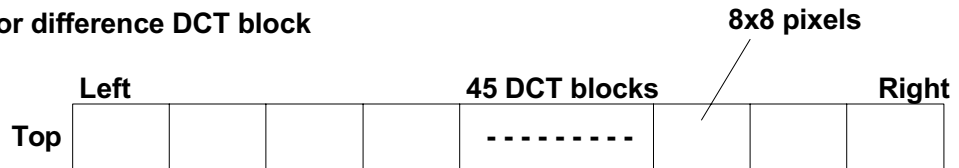

Figure 16 – Rightmost DCT block in color-difference signal for 4:1:1 compression mode

Luminance DCT block



Color difference DCT block



8x8 pixels

Figure 17 – DCT block arrangement for 4:2:2 compression

Luminance DCT block

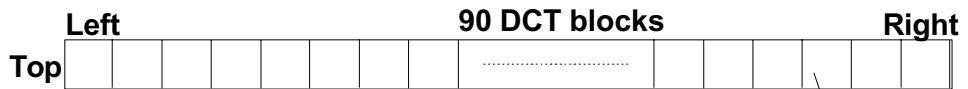

Color difference DCT block

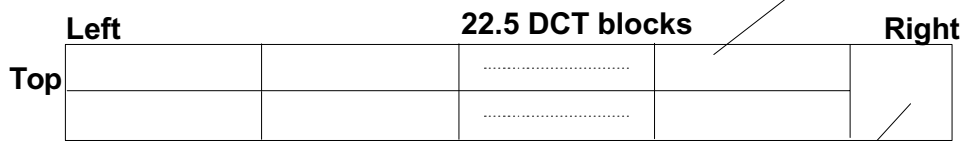

8x8 pixels

16x4 pixels

Figure 18 – DCT block arrangement for 4:1:1 compression

SMPTE 314M-1999

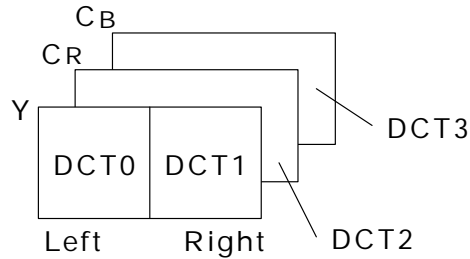
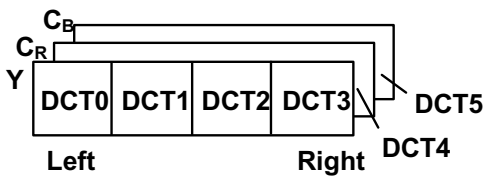

Figure 19 – Macro block and DCT blocks for 4:2:2 compression

Except for the rightmost macro block



For the rightmost macro block

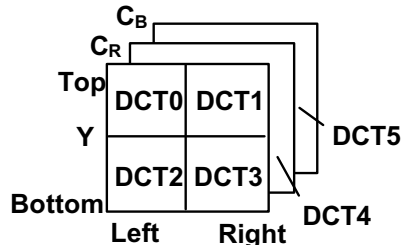

Figure 20 – Macro block and DCT blocks for 4:1:1 compression

Macro block arrangement in one frame for 525/60 system

The arrangement of macro blocks in one frame is shown in figure 21 for 4:2:2 compression and figure 22 for 4:1:1 compression. Each small rectangle shows a macro block. Pixels in one frame are distributed into 2700 macro blocks for 4:2:2 compression and 1350 macro blocks for 4:1:1 compression.

4:2:2 compression

60 vertical macro blocks × 45 horizontal macro blocks = 2700 macro blocks

4:1:1 compression

60 vertical macro blocks × 22.5 horizontal macro blocks = 1350 macro blocks

Macro block arrangement in one frame for 625/50 system

The arrangement of macro blocks in one frame is shown in figure 23 for 4:2:2 compression and figure 24 for 4:1:1 compression. Each small rectangle shows a macro block. Pixels in one frame are distributed into 3240 macro blocks for 4:2:2 compression and 1620 macro blocks for 4:1:1 compression.

4:2:2 compression

72 vertical macro blocks × 45 horizontal macro blocks = 3240 macro blocks

4:1:1 compression

72 vertical macro blocks × 22.5 horizontal macro blocks = 1620 macro blocks

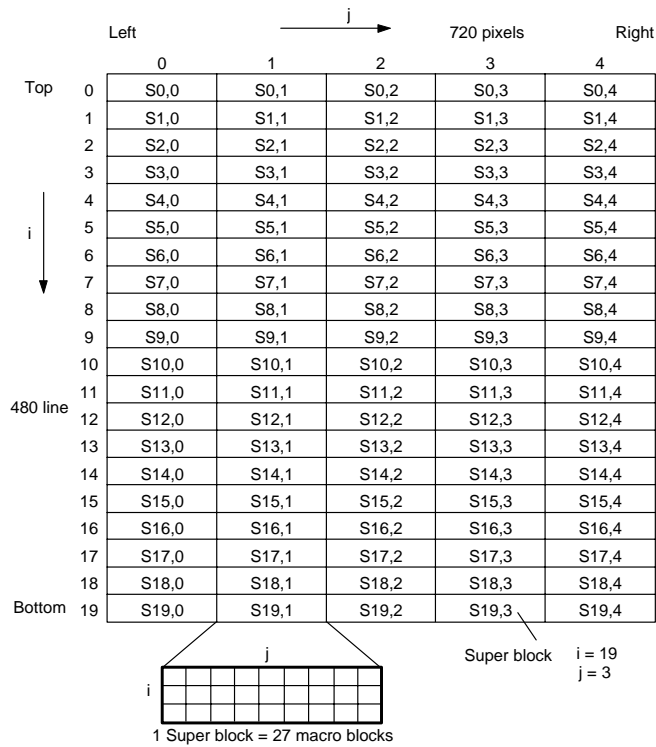

Figure 21 – Super blocks and macro blocks in one television frame for 525/60 system for 4:2:2 compression

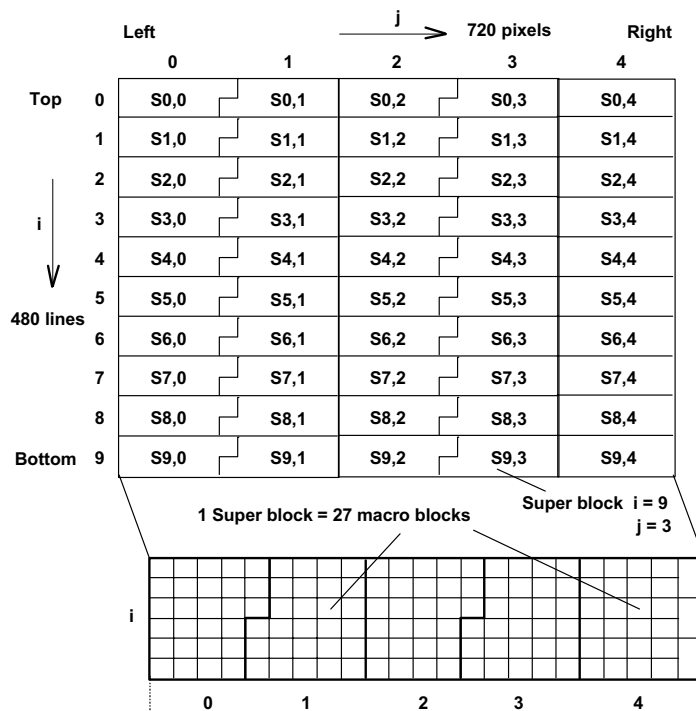

Figure 22 – Super blocks and macro blocks in one television frame for 525/60 system for 4:1:1 compression

SMPTE 314M-1999

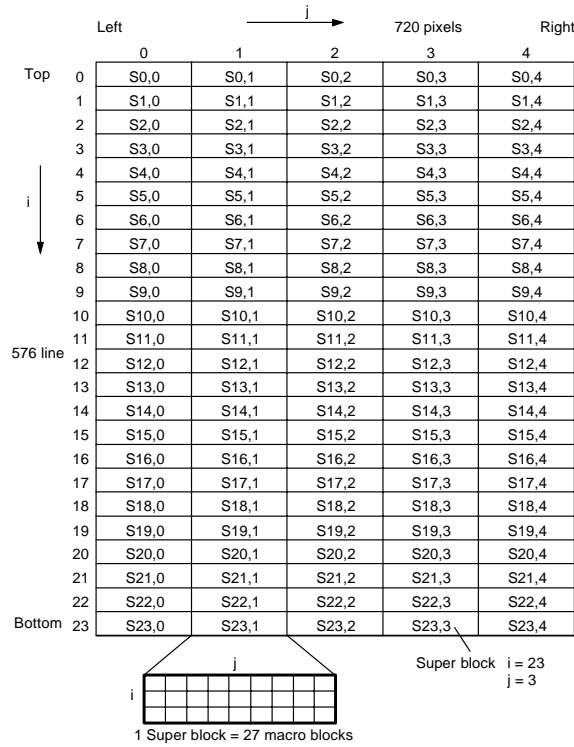

Figure 23 – Super blocks and macro blocks in one television frame for 625/50 system for 4:2:2 compression

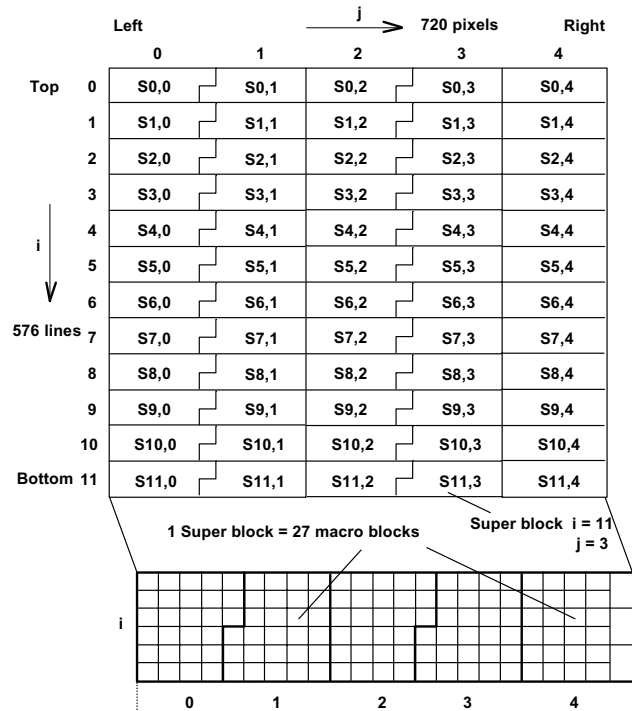

Figure 24 – Super blocks and macro blocks in one television frame for 625/50 system for 4:1:1 compression

5.1.4 Super block

Each super block consists of 27 macro blocks.

Super block arrangement in one frame for 525/60 system

The arrangement of super blocks in one frame is shown in figure 21 for 4:2:2 compression and figure 22 for 4:1:1 compression. Each super block consists of 27 adjacent macro blocks, and its boundary is marked by a heavy line. The total number of pixels in a frame is distributed into 100 super blocks for 4:2:2 compression or 50 super blocks for 4:1:1 compression.

4:2:2 compression

20 vertical super blocks \times 5 horizontal super blocks
= 100 super blocks

4:1:1 compression

10 vertical super blocks \times 5 horizontal super blocks
= 50 super blocks

Super block arrangement in one frame for 625/50 system

The arrangement of super blocks in one frame is shown in figure 23 for 4:2:2 compression and figure 24 for 4:1:1 compression. Each super block consists of 27 adjacent macro blocks, and its boundary is marked by a heavy line. The total number of pixels in a frame is distributed into 120 super blocks for 4:2:2 compression or 60 super blocks for 4:1:1 compression.

4:2:2 compression

24 vertical super blocks \times 5 horizontal super blocks
= 120 super blocks

4:1:1 compression

12 vertical super blocks \times 5 horizontal super blocks
= 60 super blocks

5.1.5 Definition of a super block number, a macro block number and value of the pixel

Super block number

The super block number in a frame is expressed as $S_{i,j}$ as shown in figures 21, 22, 23, and 24.

$S_{i,j}$ where i : the vertical order of the super block

$i = 0, \dots, n-1$

where

n : the number of vertical super blocks in a video frame

$n = 10 \times m$ for the 525/60 system

$n = 12 \times m$ for the 625/50 system

m : the compression type

$m = 1$ for 4:1:1 compression

$m = 2$ for 4:2:2 compression

j : the horizontal order of the super block

$j = 0, \dots, 4$

Macro block number

The macro block number is expressed as $M_{i,j,k}$. The symbol k is the macro block order in the super block as shown in figure 25 for 4:2:2 compression and figure 26 for 4:1:1 compression. The small rectangle in these figures shows a macro block and a number in the small rectangle indicates k .

$M_{i,j,k}$ where i, j : the super block order number

k : the macro block order in the super block

$k = 0, \dots, 26$

Pixel location

Pixel location is expressed as $P_{i,j,k,l}(x,y)$. The pixel is indicated as the suffix of $i, j, k, l(x,y)$. The symbol is the DCT block order in a macro block as shown in figures 19 and 20. The rectangle in the figure shows a DCT block, and a DCT number in the rectangle expresses l . Symbol x and y are the pixel coordinate in the DCT block as described in 5.1.2.

$P_{i,j,k,l}(x,y)$ where i, j, k : the macro block number

l : the DCT block order in the macro block

(x, y) : the pixel coordinate in the DCT block

$x = 0, \dots, 7$

$y = 0, \dots, 7$

SMPTE 314M-1999

Super block S_{ij} ($i = 0, \dots, n-1, j = 0, \dots, 4$)

0	5	6	11	12	17	18	23	24
1	4	7	10	13	16	19	22	25
2	3	8	9	14	15	20	21	26

Where $n = 20$: 525/60 system
 $n = 24$: 625/50 system

Figure 25 – Macro block order in a super block for 4:2:2 compression

Super block $S_{i,0}, S_{i,2}$ ($i = 0, \dots, n-1$)

0	11	12	23	24
1	10	13	22	25
2	9	14	21	26
3	8	15	20	
4	7	16	19	
5	6	17	18	

Super block $S_{i,1}, S_{i,3}$ ($i = 0, \dots, n-1$)

	8	9	20	21
	7	10	19	22
	6	11	18	23
0	5	12	17	24
1	4	13	16	25
2	3	14	15	26

Super block $S_{i,4}$ ($i = 0, \dots, n-1$)

0	11	12	23	24
1	10	13	22	
2	9	14	21	25
3	8	15	20	
4	7	16	19	26
5	6	17	18	

Where $n = 10$: 525/60 system
 $n = 12$: 625/50 system

Figure 26 – Macro block order in a super block for 4:1:1 compression

5.1.6 Definition of video segment and compressed macro block

A video segment consists of five macro blocks assembled from various areas within the video frame:

Ma, 2, k where $a = (i + 2m) \bmod n$
 Mb, 1, k where $b = (i + 6m) \bmod n$
 Mc, 3, k where $c = (i + 8m) \bmod n$
 Md, 0, k where $d = (i + 0) \bmod n$
 Me, 4, k where $e = (i + 4m) \bmod n$

where i: the vertical order of the super block

$i = 0, \dots, n-1$

n: the number of vertical super blocks in a video frame

$n = 10 \times m$ for the 525/60 system

$n = 12 \times m$ for the 625/50 system

m: the compression type

$m = 1$ for 4:1:1 compression

$m = 2$ for 4:2:2 compression

k: the macro block order in the super block

$k = 0, \dots, 28$

Each video segment before the bit-rate reduction is expressed as $V_{i, k}$ which consists of Ma, 2, k; Mb, 1, k; Mc, 3, k; Md, 0, k; and Me, 4, k.

The bit-rate reduction process is operated sequentially from Ma, 2, k to Me, 4, k. The data in a video segment are compressed and transformed to a 385-byte data stream. A compressed video data consists of five compressed macro blocks. Each compressed macro block consists of 77 bytes and is expressed as CM. Each video segment after the bit-rate reduction is expressed as $CV_{i, k}$ which consists of CM a, 2, k; CM b, 1, k; CM c, 3, k; CM d, 0, k; and CM e, 4, k as shown below.

CMa, 2, k:

This block includes all parts or most parts of the compressed data from macro block Ma, 2, k and may include the compressed data of macro block Mb, 1, k; or Mc, 3, k; or Md, 0, k; or Me, 4, k.

CMb, 1, k:

This block includes all parts or most parts of the compressed data from macro block Mb, 1, k and may include the compressed data of macro block Ma, 2, k; or Mc, 3, k; or Md, 0, k; or Me, 4, k.

CMc, 3, k

This block includes all parts or most parts of the compressed data from macro block Mc, 3, k and may include the compressed data of macro block Ma, 2, k; or Mb, 1, k; or Md, 0, k; or Me, 4, k.

CMd, 0, k

This block includes all parts or most parts of the compressed data from macro block Md, 0, k and may include the compressed data of macro block Ma, 2, k; or Mb, 1, k; or Mc, 3, k; or Me, 4, k.

CMe, 4, k:

This block includes all parts or most parts of the compressed data from macro block Me, 4, k and may include the compressed data of macro block Ma, 2, k; or Mb, 1, k; or Mc, 3, k; or Md, 0, k.

5.2 DCT processing

DCT blocks are comprised of two fields; each field providing pixels from 4 vertical lines and 8 horizontal pixels. In this clause, the DCT transformation from 64 pixels in a DCT block whose numbers are $i, j, k, l(x, y)$ to 64 coefficients whose numbers are $i, j, k, l(h, v)$ is described. $P_{i, j, k, l}(x, y)$ is the value of the pixel and $C_{i, j, k, l}(h, v)$ is the value of the coefficient.

For $h = 0$ and $v = 0$, the coefficient is called DC coefficient. Other coefficients are called AC coefficients.

5.2.1 DCT mode

Two modes, 8-8-DCT, and 2-4-8-DCT, are selectively used to optimize the data-reduction process, depending upon the degree of content variations between the two fields of a video frame. The two DCT modes are defined:

SMPTE 314M-1999

8-8-DCT mode

DCT

$$C, i, j, k, l (h, v) = C (v) C (h) \sum_{y=0}^7 \sum_{x=0}^7$$

$$(P i, j, k, l (x, y) \cos(\pi v(2y + 1)/16) \cos(\pi h(2x + 1)/16))$$

Inverse DCT:

$$P, i, j, k, l (x, y) = \sum_{v=0}^7 \sum_{h=0}^7 (C (v) C (h)$$

$$C, i, j, k, l (h, v) \cos(\pi v(2y + 1)/16) \cos(\pi h(2x + 1)/16))$$

where

$$\begin{aligned} C(h) &= 0, 5 / \sqrt{2} & \text{for } h = 0 \\ C(h) &= 0, 5 & \text{for } h = 1 \text{ to } 7 \\ C(v) &= 0, 5 / \sqrt{2} & \text{for } v = 0 \\ C(v) &= 0, 5 & \text{for } v = 1 \text{ to } 7 \end{aligned}$$

2-4-8 DCT mode

DCT

$$C, i, j, k, l (h, u) = C (u) C (h) \sum_{z=0}^3 \sum_{x=0}^7$$

$$((P i, j, k, l (x, 2z) + P i, j, k, l (x, 2z + 1)) KC)$$

$$C, i, j, k, l (h, u + 4) = C (u) C (h) \sum_{z=0}^3 \sum_{x=0}^7$$

$$((P i, j, k, l (x, 2z) - P i, j, k, l (x, 2z + 1)) KC)$$

Inverse DCT:

$$P, i, j, k, l (x, 2z) = \sum_{u=0}^3 \sum_{h=0}^7 (C (u) C (h)$$

$$(C i, j, k, l (h, u) + C, i, j, k, l (h, u + 4)) KC)$$

$$P, i, j, k, l (x, 2z + 1) = \sum_{u=0}^3 \sum_{h=0}^7 (C (u) C (h)$$

$$(C i, j, k, l (h, u) - C, i, j, k, l (h, u + 4)) KC)$$

where

$$\begin{aligned} u &= 0, \dots, 3 \\ z &= \text{INT} (y / 2) \\ KC &= \cos(\pi u(2z + 1)/8) \cos(\pi h(2x + 1)/16) \\ C(h) &= 0, 5 / \sqrt{2} & \text{for } h = 0 \\ C(h) &= 0, 5 & \text{for } h = 1 \text{ to } 7 \\ C(u) &= 0, 5 / \sqrt{2} & \text{for } u = 0 \\ C(u) &= 0, 5 & \text{for } u = 1 \text{ to } 7 \end{aligned}$$

5.2.2 Weighting

DCT coefficients shall be weighted by the process as described below. $W(h, v)$ expresses weight for $C i, j, k, l (h, v)$ of the DCT coefficient.

8-8-DCT mode

$$\begin{aligned} \text{For } h = 0 \text{ and } v = 0 & W(h, v) = 1 / 4 \\ \text{For others} & W(h, v) = w(h) w(v) / 2 \end{aligned}$$

2-4-8- DCT mode

$$\begin{aligned} \text{For } h = 0 \text{ and } v = 0 & W(h, v) = 1 / 4 \\ \text{For } v < 4 & W(h, v) = w(h) w(2v) / 2 \\ \text{For others} & W(h, v) = w(h) w(2(v - 4)) / 2 \end{aligned}$$

where

$$\begin{aligned} w(0) &= 1 \\ w(1) &= CS4 / (4 \times CS7 \times CS2) \\ w(2) &= CS4 / (2 \times CS6) \\ w(3) &= 1 / (2 \times CS5) \\ w(4) &= 7 / 8 \\ w(5) &= CS4 / CS3 \\ w(6) &= CS4 / CS2 \\ w(7) &= CS4 / CS1 \end{aligned}$$

where $CSM = \cos(m\pi / 16)$ $m = 1$ to 7

5.2.3 Output order

Figure 27 shows the output order of the weighted coefficients.

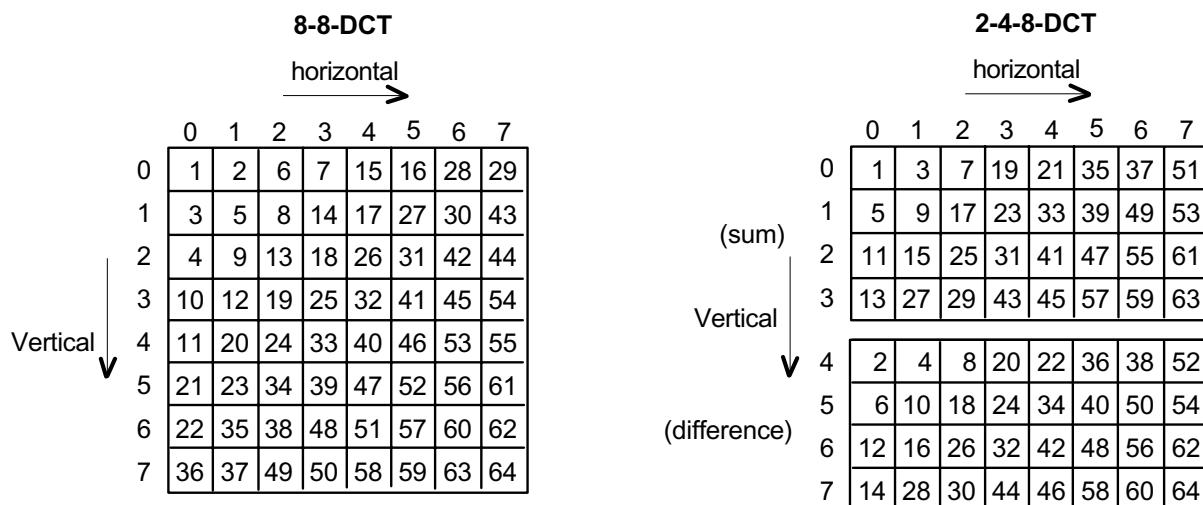

Figure 27 – Output order of weighted DCT block

5.2.4 Tolerance of DCT with weighting

Output error between the reference DCT and the tested DCT should satisfy the tolerances of the following cases:

- Probability of occurrence of error;
- Mean square errors for all coefficients;
- Maximum value of mean square error for each DCT block;
- All input pixel values of a DCT block are the same.

5.3 Quantization

5.3.1 Introduction

Weighted DCT coefficients are first quantized to 9-bit words, then divided by quantization in order to limit the amount of data in one video segment to five compressed macro blocks.

5.3.2 Bit assignment for quantization

Weighted DCT coefficients are represented as follows:

DC coefficient value (9 bits):
 b8 b7 b6 b5 b4 b3 b2 b1 b0
 twos complement (-255 to 255)

AC coefficient value (10 bits):
 s b8 b7 b6 b5 b4 b3 b2 b1 b0
 1 sign bit + 9 bits of absolute value (-511 to 511)

5.3.3 Class number

Each DCT block shall be classified into four classes by the definitions as described in table 21. For selecting the quantization step, the class number is used. Both c1 and c0 express the class number and are stored in the DC coefficient of compressed DCT blocks as described in 5.5. For reference, table 22 shows an example of the classification.

5.3.4 Initial scaling

Initial scaling is an operation for AC coefficients to transform from 10 bits to 9 bits. Initial scaling shall be done as follows:

For class number = 0, 1, 2
 input data s b8 b7 b6 b5 b4 b3 b2 b1 b0
 output data s b7 b6 b5 b4 b3 b2 b1 b0

For class number = 3
 input data s b8 b7 b6 b5 b4 b3 b2 b1 b0
 output data s b8 b7 b6 b5 b4 b3 b2 b1

SMPTE 314M-1999

Table 21 – Class number and the DCT block

Class number			DCT block	
	c1	c0	Quantization noises	Maximum absolute value of AC coefficient
0	0	0	Visible	Less than or equal to 255
1	0	1	Lower than class 0	
2	1	0	Lower than class 1	
3	1	1	Lower than class 2	
			————	Greater than 255

Table 22 – An example of the classification for reference

	Maximum absolute value of AC coefficient			
	0 to 11	12 to 23	24 to 35	> 35
Y	0	1	2	3
C _R	1	2	3	3
C _B	2	3	3	3

5.3.5 Area number

An area number is used for selection of the quantization step. AC coefficients within a DCT block shall be classified into four areas with area number as shown in figure 28.

5.3.6 Quantization step

The quantization step shall be decided by the class number, area number, and quantization number (QNO) as specified in table 23. QNO is selected in order to limit the amount of data in one video segment to five compressed macro blocks.

5.4 Variable length coding (VLC)

Variable length coding is an operation for transforming from quantized AC coefficients to variable length codes. One or more successive AC coefficients within a DCT block are coded into one variable length code according to the order as shown in figure 27. Run length and amplitude are defined as follows:

Run length: The number of successive AC coefficients quantized to 0 (run = 0, ..., 61)

Amplitude: Absolute value just after successive AC coefficients quantized to 0 (amp = 0, ..., 255)

(run, amp): The pair of run length and amplitude

Table 24 shows the length of code words corresponding to (run, amp). In the table, sign bit is not included in the length of code words. When the amplitude is not zero, the code length shall be plus 1 because sign bit is needed. For empty columns, the length of code words of the (run, amp) equals that of the (run - 1, 0) plus that of the (0, amp).

Variable length code shall be as shown in table 25. The leftmost bit of code words is MSB and the rightmost bit of code words is LSB in table 25. The MSB of a subsequent code word is next to the LSB of the code word just before. Sign bit "s" shall be as follows:

When the quantized AC coefficient is greater than zero, s = 0

When the quantized AC coefficient is less than zero, s = 1

When the values of all of the remaining quantized coefficients are zero within a DCT block, the coding process is ended by adding EOB (end of block) code word of 0110b to just after the last code word.

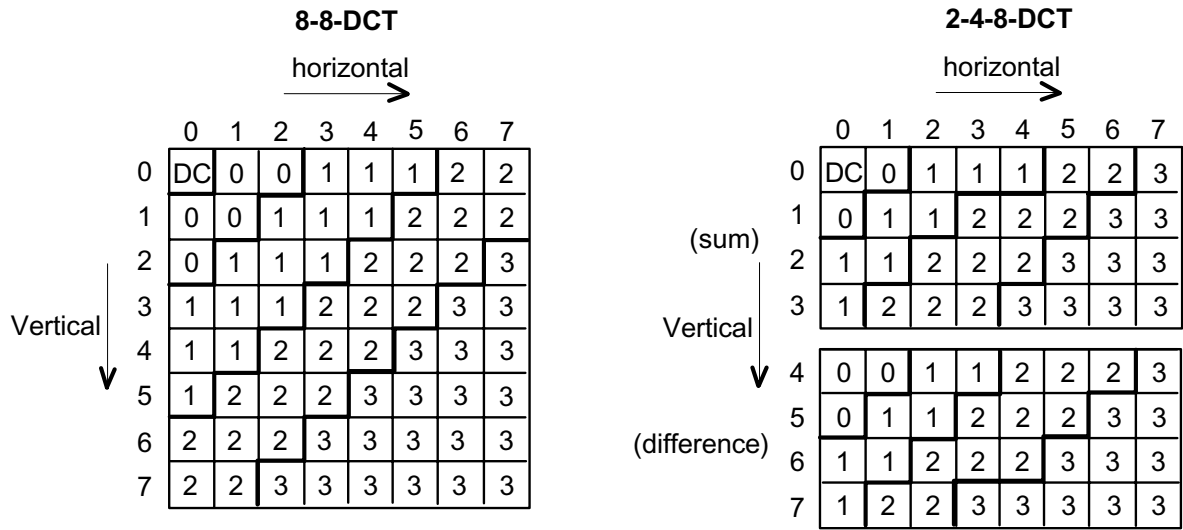

Figure 28 – Area numbers

Table 23 – Quantization step

	Class number				Area number			
	0	1	2	3	0	1	2	3
Quantization number (QNO)	15				1	1	1	1
	14				1	1	1	1
	13				1	1	1	1
	12	15			1	1	1	1
	11	14			1	1	1	1
	10	13		15	1	1	1	1
	9	12	15	14	1	1	1	1
	8	11	14	13	1	1	1	2
	7	10	13	12	1	1	2	2
	6	9	12	11	1	1	2	2
	5	8	11	10	1	2	2	4
	4	7	10	9	1	2	2	4
	3	6	9	8	2	2	4	4
	2	5	8	7	2	2	4	4
	1	4	7	6	2	4	4	8
	0	3	6	5	2	4	4	8
		2	5	4	4	4	8	8
		1	4	3	4	4	8	8
		0	3	2	4	8	8	16
			2	1	4	8	8	16
		1	0	8	8	16	16	
		0		8	8	16	16	

SMPTE 314M-1999

Table 24 – Length of codewords

Run length	Amplitude																										
	0	1	2	3	4	5	6	7	8	9	10	11	12	13	14	15	16	17	18	19	20	21	22	23	—	255	
0	11	2	3	4	4	5	5	6	6	7	7	7	8	8	8	8	8	8	9	9	9	9	9	15	—	15	
1	11	4	5	7	7	8	8	8	9	10	10	10	11	11	11	12	12	12									
2	12	5	7	8	9	9	10	12	12	12	12	12															
3	12	6	8	9	10	10	11	12																			
4	12	6	8	9	11	12																					
5	12	7	9	10																							
6	13	7	9	11																							
7	13	8	12	12																							
8	13	8	12	12																							
9	13	8	12																								
10	13	8	12																								
11	13	9																									
12	13	9																									
13	13	9																									
14	13	9																									
15	13																										
61	13																										

NOTES
 1 Sign bit is not included.
 2 The length of EOB = 4.

Table 25 – Codewords of variable-length coding

(Run, amp)	Code	Length	(Run, amp)	Code	Length	(Run, amp)	Code	Length																		
0 1	00s	2+1	11 1	111100000s	9+1	7 2	111110110000s	12+1																		
0 2	010s	3+1	12 1	111100001s		8 2	111110110001s																			
EOB	0110	4	13 1	111100010s		9 2	111110110010s																			
1 1	0111s	4+1	14 1	111100011s		10 2	111110110011s																			
0 3	1000s		5 2	111100100s		7 3	111110110100s																			
0 4	1001s		6 2	111100101s		8 3	111110110101s																			
2 1	10100s	5+1	3 3	111100110s		4 5	111110110110s																			
1 2	10101s		4 3	111100111s		3 7	111110110111s																			
0 5	10110s		2 4	111101000s		2 7	111110111000s																			
0 6	10111s		2 5	111101001s		2 8	111110111001s																			
3 1	110000s	6+1	1 8	111101010s		2 9	111110111010s																			
4 1	110001s		0 18	111101011s		2 10	111110111011s																			
0 7	110010s		0 19	111101100s		2 11	111110111100s																			
0 8	110011s		0 20	111101101s		1 15	111110111101s																			
5 1	1101000s	7+1	0 21	111101110s		1 16	111110111110s																			
6 1	1101001s		0 22	111101111s		1 17	111110111111s																			
2 2	1101010s		5 3	1111100000s		6 0	1111110000110																			
1 3	1101011s		3 4	1111100001s	7 0	1111110000111																				
1 4	1101100s	10+1	3 5	1111100010s	<table border="1"> <tr> <td>R</td> <td>0</td> <td>1111110</td> <td>Binary notation of R R = 6 to 61</td> <td rowspan="5">13</td> </tr> <tr> <td> </td> <td> </td> <td></td> <td></td> </tr> <tr> <td> </td> <td> </td> <td></td> <td></td> </tr> <tr> <td>61</td> <td>0</td> <td>1111110111101</td> <td></td> </tr> <tr> <td>0</td> <td>23</td> <td>111111100010111s</td> <td></td> </tr> </table>	R	0	1111110	Binary notation of R R = 6 to 61	13									61	0	1111110111101		0	23	111111100010111s	
R	0		1111110	Binary notation of R R = 6 to 61		13																				
61	0		1111110111101																							
0	23	111111100010111s																								
0 9	1101101s	2 6	1111100011s	1 9	1111100100s																					
0 10	1101110s	1 9	1111100100s	1 10	1111100101s																					
0 11	1101111s	1 10	1111100101s	1 11	1111100110s																					
7 1	11100000s	1 11	1111100110s	0 0	11111001110																					
8 1	11100001s	0 0	11111001110	1 0	11111001111																					
9 1	11100010s	1 0	11111001111	6 3	11111010000s																					
10 1	11100011s	6 3	11111010000s	4 4	11111010001s																					
3 2	11100100s	4 4	11111010001s	3 6	11111010010s																					
4 2	11100101s	3 6	11111010010s	1 12	11111010011s																					
2 3	11100110s	1 12	11111010011s	1 13	11111010100s																					
1 5	11100111s	1 13	11111010100s	1 14	11111010101s																					
1 6	11101000s	1 14	11111010101s	2 0	111110101100																					
1 7	11101001s	2 0	111110101100	3 0	111110101101																					
0 12	11101010s	3 0	111110101101	4 0	111110101110																					
0 13	11101011s	4 0	111110101110	5 0	111110101111																					
0 14	11101100s	5 0	111110101111	11+1	<table border="1"> <tr> <td>0</td> <td>A</td> <td>1111111</td> <td>Binary notation of A A = 23 to 255</td> <td rowspan="5">15+1</td> </tr> <tr> <td> </td> <td> </td> <td></td> <td></td> </tr> <tr> <td> </td> <td> </td> <td></td> <td></td> </tr> <tr> <td>0</td> <td>255</td> <td>111111111111111s</td> <td></td> </tr> <tr> <td>0</td> <td>24</td> <td>111111100011000s</td> <td></td> </tr> </table>	0	A	1111111	Binary notation of A A = 23 to 255	15+1									0	255	111111111111111s		0	24	111111100011000s	
0	A	1111111	Binary notation of A A = 23 to 255			15+1																				
0	255	111111111111111s																								
0	24	111111100011000s																								
0 15	11101101s	8+1		0	255	111111111111111s																				
0 16	11101110s																									
0 17	11101111s																									

NOTES

- 1 (R, 0): 1111110 r5 r4 r3 r2 r1 r0, where 32r5 + 16r4 + 8r3 + 4r2 + 2r1 + r0 = R.
- 2 (0, A): 1111111 a7 a6 a5 a4 a3 a2 a1 a0 s, where 128a7 + 64a6 + 32a5 + 16a4 + 8a3 + 4a2 + 2a1 + a0 = A.
- 3 S is sign bit. EOB means end of block.

SMPTE 314M-1999

5.5 Arrangement of a compressed macro block

A compressed video segment consists of five compressed macro blocks. Each compressed macro block has 77 bytes of data. The arrangement of the compressed macro block shall be as shown in figure

29 for 4:2:2 compression and in figure 30 for 4:1:1 compression. Each compressed macro block of 4:2:2 compression includes a two-byte data area (X0, X1). The data arrangement is shown in figure 29. The data format of the reserved area is not defined except 10000000000.

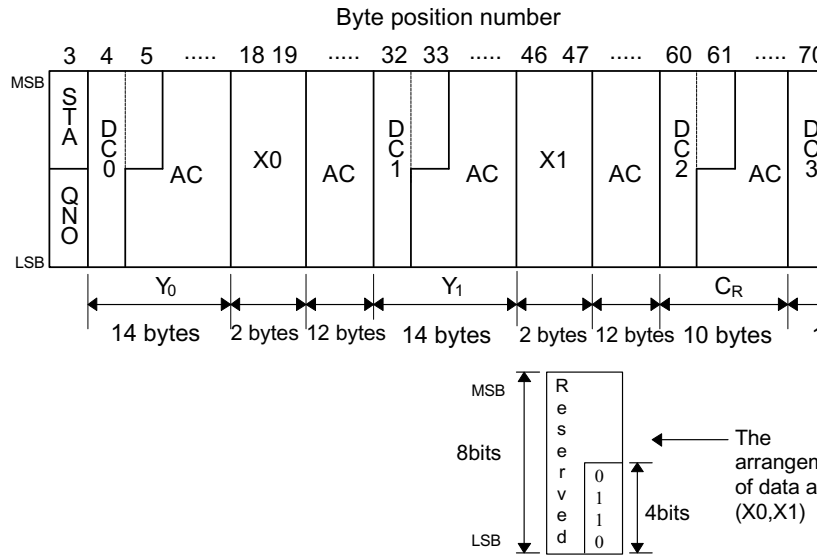

Figure 29 – Arrangement of a compressed macro block for 4:2:2 compression

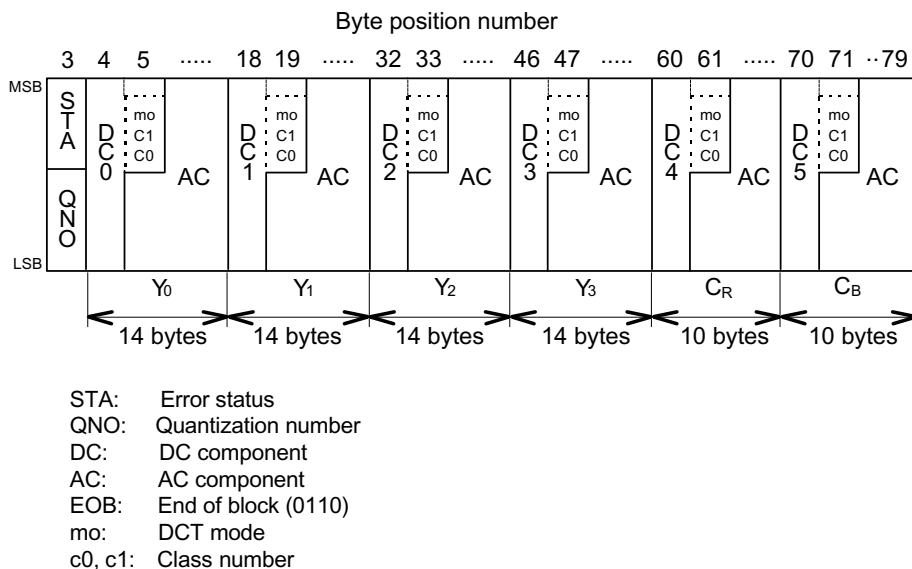

Figure 30 – Arrangement of a compressed macro block for 4:1:1 compression

STA (status of the compressed macro block)

QNO (quantization number)

STA expresses the error and concealment of the compressed macro block and consists of four bits: s3, s2, s1, s0. Table 26 shows the definitions of STA.

QNO is the quantization number applied to the macro block. Code words of the QNO shall be as shown in table 27.

Table 26 – Definition of STA

STA				Information of the compressed macro block		
s3	s2	s1	s0	Error	Error concealment	Continuity
0	0	0	0	No error	Not applied	—
0	0	1	0		Type A	Type a
0	1	0	0		Type B	
0	1	1	0		Type C	
0	1	1	1	Error exists	—	—
1	0	1	0	No error	Type A	Type b
1	1	0	0		Type B	
1	1	1	0		Type C	
1	1	1	1	Error exists	—	—
Others				Reserved		
where Type A: Replaced with a compressed macro block of the same compressed macro block number in the immediate previous frame. Type B: Replaced with a compressed macro block of the same compressed macro block number in the next immediate frame. Type C: This compressed macro block is concealed, but the concealment method is not specified. Type a: The continuity of the data processing sequence with other compressed macro blocks whose s0 = 0 and s3 = 0 in the same video segment is guaranteed. Type b: The continuity of the data processing sequence with other compressed macro blocks is not guaranteed.						
NOTES 1 For STA = 0111b, the error code is inserted in the compressed macro block. This is an option. 2 For STA = 1111b, the error position is unidentified.						

Table 27 – Codewords of the QNO

q3	q2	q1	q0	QNO
0	0	0	0	0
0	0	0	1	1
0	0	1	0	2
0	0	1	1	3
0	1	0	0	4
0	1	0	1	5
0	1	1	0	6
0	1	1	1	7
1	0	0	0	8
1	0	0	1	9
1	0	1	0	10
1	0	1	1	11
1	1	0	0	12
1	1	0	1	13
1	1	1	0	14
1	1	1	1	15

SMPTE 314M-1999

DC

DCI (where l is the DCT block order in the macro block, $l = 0, \dots, 3$ for 4:2:2 compression, $l = 0, \dots, 5$ for 4:1:1 compression) consists of a DC coefficient, the DCT mode, and the class number of the DCT block.

MSB
 DCI: b8 b7 b6 b5 b4 b3 b2 b1 b0 mo c1 c0
 LSB

where

- b8 to b0: DC coefficient value
- mo: DCT mode mo = 0 for 8-8-DCT mode
 mo = 1 for 2-4-8-DCT mode
- c1 c0: class number

AC

AC is a generic term for variable length coded AC coefficients within the video segment $V_{i,k}$. For 4:2:2 compression, the areas of Y_0 , Y_1 , C_R , and C_B are defined as compressed-data areas and each of Y_0 and Y_1 consists of 112 bits and each C_R and C_B consists of 80 bits as shown in figure 29. For 4:1:1

compression, the areas of Y_0 , Y_1 , Y_2 , Y_3 , C_R , and C_B are defined as compressed-data areas and each of Y_0 , Y_1 , Y_2 , and Y_3 consists of 112 bits and each C_R and C_B consists of 80 bits as shown in figure 30. DCI and variable length code for AC coefficients in the DCT block whose DCT block number is i, j, k, l are assigned from the beginning of the compressed-data area in the compressed macro block $CM_{i,j,k,l}$. In figures 29 and 30, the variable length code word is located starting from the MSB which is shown in the upper left side, and the LSB shown in the lower right side. Therefore, AC data are distributed from the upper left corner to the lower right corner.

5.6 Arrangement of a video segment

In this clause, the distribution method of quantized AC coefficients is described. Figures 31 and 32 show the arrangement of a video segment $CV_{i,k}$ after bit-rate reduction. Each row contains a compressed macro block. Columns $F_{i,j,k,l}$ express the compressed data area for DCT blocks whose DCT block numbers are i, j, k, l . Symbol $E_{i,j,k,l}$ expresses an additional AC area for recording remaining data from the fixed AC area.

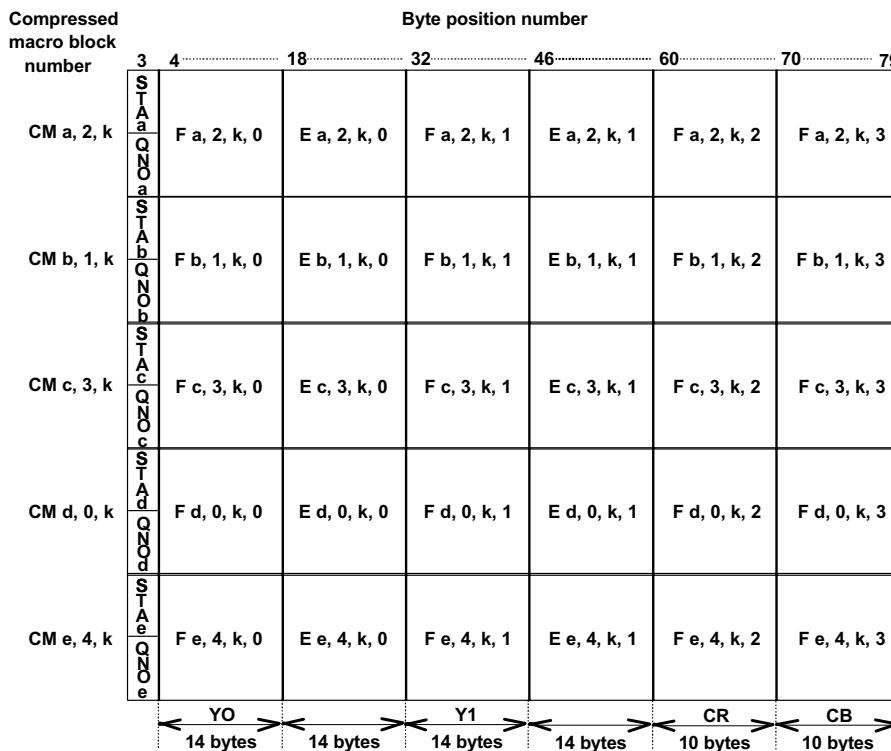
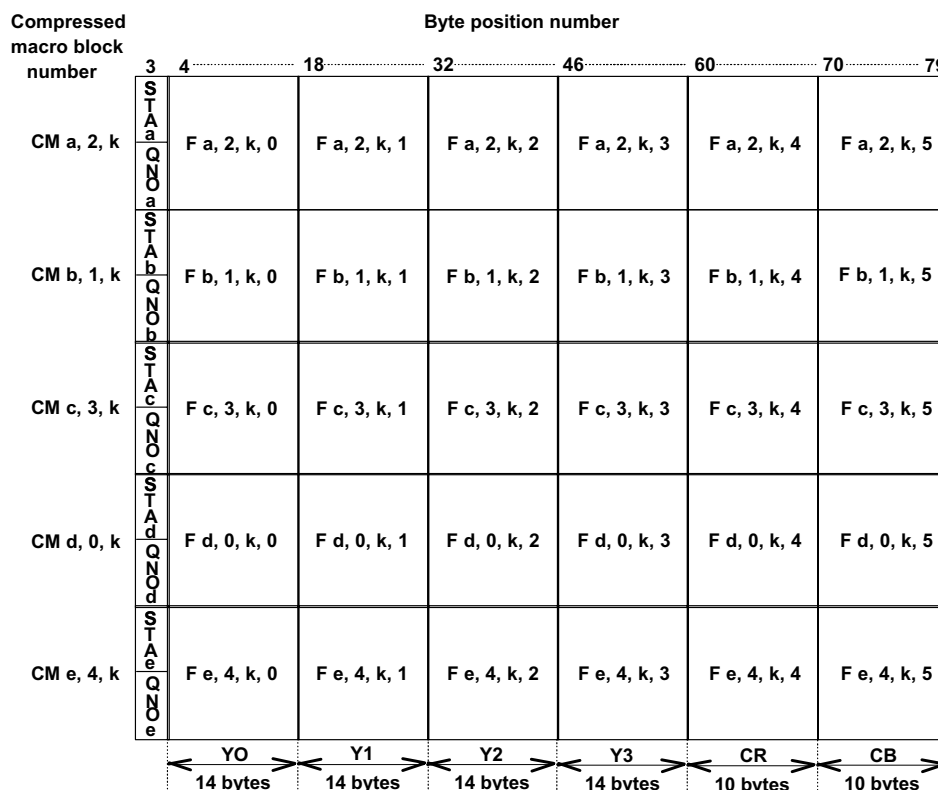

Figure 31 – Arrangement of a video segment after the bit-rate reduction for 4:2:2 compression



where $a = (i + 2) \bmod n$
 $b = (i + 6) \bmod n$
 $c = (i + 8) \bmod n$
 $d = (i + 0) \bmod n$
 $e = (i + 4) \bmod n$

i : the vertical order of the super block
 $i = 0, \dots, n-1$
 n : the number of vertical super blocks in a video frame
 $n = 10$ for the 525/60 system
 $n = 12$ for the 625/50 system
 k : the macro block order in the super block
 $k = 0, \dots, 26$

Figure 32 – Arrangement of a video segment after the bit-rate reduction for 4:1:1 compression

Bit sequence, defined as $B_{i, j, k, l}$, shall consist of the following concatenated data: DC coefficient, DCT mode information, class number, and AC coefficient code words for DCT blocks numbered i, j, k, l . Code words for AC coefficients of $B_{i, j, k, l}$ shall be concatenated according to the order as shown in figure 27 and the last code word shall be EOB. The MSB of the subsequent code word shall be next to the LSB of the code word just before.

The arrangement algorithm of a video segment shall be composed of three passes:

Pass 1: The distribution of $B_{i, j, k, l}$ to the compressed-data area;

Pass 2: The distribution of the overflow $B_{i, j, k, l}$ which are the remainder after the pass 1 operation in the same compressed macro block;

Pass 3: The distribution of the overflow $B_{i, j, k, l}$ which are the remainder after the pass 2 operation in the same video segment.

Arrangement algorithm of a video segment

4:2:2 compression
 if (525/60 system) $n = 20$ else $n = 24$;
 for ($i = 0; i < n; i++$)
 $a = (i + 4) \bmod n$;
 $b = (i + 12) \bmod n$;

SMPTE 314M-1999

```

c = (i + 16) mod n;
d = (i + 0) mod n;
e = (i + 8) mod n;
for (k = 0; k < 27; k++){
  q = 2;
  p = a;
  VR = 0
  /* VR is the bit sequence for the data */
  /* which are not distributed to video segment
  CV i, k by pass 2. */
/* pass 1 */
  for (j = 0; j < 5; j++) {
    MRq = 0;
    /* MRq is the bit sequence for the data */
    /* which are not distributed to macro block
    M i, q, k by pass 1. */
    for (l = 0, l < 4; l++) {
      remain = distribute (B p, q, k, l, F p, q, k, l);
      MRq = connect (MRq, remain);
    }
    if (q == 2) {q = 1; p = b;}
    else if (q == 1) {q = 3; p = c;}
    else if (q == 3) {q = 0; p = d;}
    else if (q == 0) {q = 4; p = e;}
    else if (q == 4) {q = 2; p = a;}
  }
/* pass 2 */
  for (j = 0; j < 5; j++) {
    for (l = 0; l < 4; l++) {
      MRq = distribute (MRq, F p, q, k, l);
      if ((l == 0) || (l == 1))
        MRq = distribute (MRq, E p, q, k, l);
    }
    VR = connect (VR, MRq);
    if (q == 2) {q = 1; p = b;}
    else if (q == 1) {q = 3; p = c;}
    else if (q == 3) {q = 0; p = d;}
    else if (q == 0) {q = 4; p = e;}
    else if (q == 4) {q = 2; p = a;}
  }
/* pass 3 */
  for (j = 0; j < 5; j++) {
    for (l = 0; l < 4; l++) {
      VR = distribute (VR, F p, q, k, l);
      if ((l == 0) || (l == 1))
        VR = distribute (VR, E p, q, k, l);
    }
    if (q == 2) {q = 1; p = b;}
    else if (q == 1) {q = 3; p = c;}
    else if (q == 3) {q = 0; p = d;}
    else if (q == 0) {q = 4; p = e;}
    else if (q == 4) {q = 2; p = a;}
  }
}

```

```

}
}
4:1:1 compression
if (525/60 system) n = 10 else n = 12;
for (i = 0; i < n; i++){
  a = (i + 2) mod n;
  b = (i + 6) mod n;
  c = (i + 8) mod n;
  d = (i + 0) mod n;
  e = (i + 4) mod n;
  for (k = 0; k < 27; k++){
    q = 2;
    p = a;
    VR = 0
    /* VR is the bit sequence for the data */
    /* which are not distributed to video segment
    CV i, k by pass 2 */
/* pass 1 */
    for (j = 0; j < 5; j++) {
      MRq = 0;
      /* MRq is the bit sequence for the data */
      /* which are not distributed to macro block
      M i, q, k by pass 1. */
      for (l = 0, l < 6; l++) {
        remain = distribute (B p, q, k, l, F p, q, k, l);
        MRq = connect (MRq, remain);
      }
      if (q == 2) {q = 1; p = b;}
      else if (q == 1) {q = 3; p = c;}
      else if (q == 3) {q = 0; p = d;}
      else if (q == 0) {q = 4; p = e;}
      else if (q == 4) {q = 2; p = a;}
    }
/* pass 2 */
    for (j = 0; j < 5; j++) {
      for (l = 0; l < 6; l++) {
        MRq = distribute (MRq, F p, q, k, l);
      }
      VR = connect (VR, MRq);
      if (q == 2) {q = 1; p = b;}
      else if (q == 1) {q = 3; p = c;}
      else if (q == 3) {q = 0; p = d;}
      else if (q == 0) {q = 4; p = e;}
      else if (q == 4) {q = 2; p = a;}
    }
/* pass 3 */
    for (j = 0; j < 5; j++){
      for (l = 0; l < 6; l++) {
        VR = distribute (VR, F p, q, k, l);
      }
    }
  }
}

```

```

    if (q == 2) {q = 1; p = b;}
    else if (q == 1) {q = 3; p = c;}
    else if (q == 3) {q = 0; p = d;}
    else if (q == 0) {q = 4; p = e;}
    else if (q == 4) {q = 2; p = a;}
    }
    }
}

```

where

```

distribute (data 0, area 0) {
    /* Distribute data 0 from MSB into empty
       area of area 0. */
    /* The area 0 is filled starting from the MSB. */
    remain = (remaining_data);
    /* Remaining_data are the data which are not
       distributed. */
    return (remain);
}

```

```

connect (data 1, data 2) {
    /* Connect the MSB of data 2 with the LSB of
       data 1. */
    data 3 = (connecting_data)
    /* Connecting_data are the data which are
       connected. */
    /* data 2 with data 1. */
    return (data 3);
}

```

The remaining data which cannot be distributed within the unused space of the macro block will be ignored. Therefore, when error concealment is performed for a compressed macro block, some distributed data by pass 3 may not be reproduced.

Video error code processing

If errors are detected in a compressed macro block which is reproduced and processed with error correction, the compressed-data area containing these errors should be replaced with the video error code. This process replaces the first two bytes of data of the compressed-data area with the code as follows:

MSB LSB
 10000000000000110b

The first 9 bits are the DC error code, the next 3 bits are the information of the DCT mode and class number, and the last 4 bits are the EOB as shown in figure 33.

When the compressed macro blocks, after error code processing, are input to the decoder which does not operate with video error code, all data in this compressed macro block should be processed as invalid.

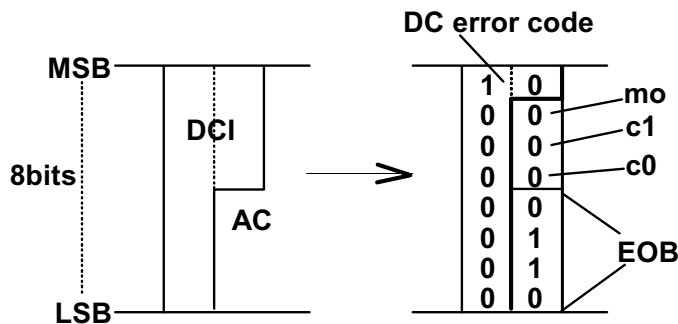

Figure 33 – Video error code

SMPTE 314M-1999

Annex A (informative)**Differences between IEC 61834 and SMPTE 314M**

The differences between IEC 61834 and SMPTE 314M are shown in table A.1.

Table A.1 – Abstract of differences between IEC 61834 and SMPTE 314M

		DV IEC 61834	DV-BASED SMPTE 314M	
			25 Mb/s structure	50 Mb/s structure
Data structure		IEC 61834	Same as IEC 61834	See figure 2
Header	Bit name			
	APT	000		001
	AP1	000		001
	AP2	000		001
	AP3	000		001
Video	Sampling structure	525: 4:1:1	525: 4:1:1	525: 4:2:2
		625: 4:2:0	625: 4:1:1	625: 4:2:2
VAUX	VS	IEC 61834	See 4.5.2.1	
	VSC	IEC 61834	See 4.5.2.2	
	Other	IEC 61834	Reserved	
Audio	Sampling	48 kHz (16 bits, 2ch) 44.1 kHz (16 bits, 2ch) 32 kHz (16 bits, 2ch) 32 kHz (12 bits, 4ch)	48 kHz (16 bits, 2ch)	48 kHz (16 bits, 4ch)
	Locked mode	Locked/unlocked	Locked	Locked
AAUX	AS	IEC 61834	See 4.6.2.3.1	
	ASC	IEC 61834	See 4.6.2.3.2	
	Other	IEC 61834	Reserved	
Subcode	SSYB ID	IEC 61834	See 4.4.2.1	
	TC	IEC 61834	See 4.4.2.2.1	
	BG	IEC 61834	Same as IEC 61834	
	Other	IEC 61834	Reserved	

Annex B (informative)**Bibliography**

ANSI/IEEE 1394-1995, High Performance Serial Bus

IEC 60958 (1989-02), Digital Audio Interface

ANSI/SMPTE 12M-1995, Television, Audio and Film — Time and Control Code

ITU-R BT.470-6 (11/98), Conventional Television Systems

ANSI/SMPTE 125M-1995, Television — Component Video Signal 4:2:2 — Bit-Parallel Digital Interface

ITU-R BT.601-5 (10/95), Studio Encoding Parameters of Digital Television for Standard 4:3 and Wide-Screen 16:9 Aspect Ratios

SMPTE 306M-1998, Television Digital Recording — 6.35-mm Type D-7 Component Format — Video Compression at 25 Mb/s — 525/60 and 625/50