

International Telecommunication Union

ITU-R
Radiocommunication Sector of ITU

Report ITU-R BT.2140-6
(05/2013)

**Transition from analogue to digital
terrestrial broadcasting**

BT Series
Broadcasting service
(television)



International
Telecommunication
Union

Foreword

The role of the Radiocommunication Sector is to ensure the rational, equitable, efficient and economical use of the radio-frequency spectrum by all radiocommunication services, including satellite services, and carry out studies without limit of frequency range on the basis of which Recommendations are adopted.

The regulatory and policy functions of the Radiocommunication Sector are performed by World and Regional Radiocommunication Conferences and Radiocommunication Assemblies supported by Study Groups.

Policy on Intellectual Property Right (IPR)

ITU-R policy on IPR is described in the Common Patent Policy for ITU-T/ITU-R/ISO/IEC referenced in Annex 1 of Resolution ITU-R 1. Forms to be used for the submission of patent statements and licensing declarations by patent holders are available from <http://www.itu.int/ITU-R/go/patents/en> where the Guidelines for Implementation of the Common Patent Policy for ITU-T/ITU-R/ISO/IEC and the ITU-R patent information database can also be found.

Series of ITU-R Reports

(Also available online at <http://www.itu.int/publ/R-REP/en>)

Series	Title
BO	Satellite delivery
BR	Recording for production, archival and play-out; film for television
BS	Broadcasting service (sound)
BT	Broadcasting service (television)
F	Fixed service
M	Mobile, radiodetermination, amateur and related satellite services
P	Radiowave propagation
RA	Radio astronomy
RS	Remote sensing systems
S	Fixed-satellite service
SA	Space applications and meteorology
SF	Frequency sharing and coordination between fixed-satellite and fixed service systems
SM	Spectrum management

Note: This ITU-R Report was approved in English by the Study Group under the procedure detailed in Resolution ITU-R 1.

Electronic Publication
Geneva, 2013

© ITU 2013

All rights reserved. No part of this publication may be reproduced, by any means whatsoever, without written permission of ITU.

REPORT ITU-R BT.2140-6

Transition from analogue to digital terrestrial broadcasting

(2008-2009-2010-05/2011-10/2011-2012-2013)

Note by the Chairman

A Group was tasked to prepare a Report on the Transition from analogue to digital broadcasting by WP 6E of ITU-R with Decision annexed to the Chairman's Report as Corrigendum 1 to Annex 17 to Document 6E/39/30-01-2004 of WP 6E.

The Group had nine meetings and prepared a draft final version of the Report. Three meetings were held, the first at the EBU Headquarters in Geneva on 13 January 2004, the second in Milan on 26 and 27 February 2004 and the third, organized during the April 2004 meeting of WP 6E. As a result of these meetings the Group defined and adopted the Draft Contents of the Report. The next six meetings were held in Rome on 7-9 July 2004, in October 2004 during the meeting of WP 6E, in Venice on 3-4 March 2005, in Rome on 27-28 June 2005, in Seoul in August 2006, in Rome on 17-18 January 2007 and in Rome on 3-6 December 2007. At this meeting the Group concluded its work and will present its Final Report to the WP 6E meeting planned for May 2008.

The purpose of this Report is to help the Countries that are in the process of migrating from analogue to digital terrestrial broadcasting. The Report examines the reasons why this is happening and the technologies involved. It provides an overview of digital terrestrial sound and television broadcasting technologies and system migration. The Report outlines the available options for making that transition and the route to be followed.

The Report is divided into two parts. Part 1 deals with the main issues related with the transition to digital, presents the principal problems and possible solutions. Part 2 gives more detailed information on important aspects which have already been covered in Part 1.

List of participants

Arasteh K. (IRN), Bochent D. (F), Cane M. (I), Canzio A. (I), Cruciatti M. (I), Dotolev V. (RUS), Valderez de Almeida Donzelli (B), Fujii T. (J), Giudici P.V. (CVA), Hate M. (UK), Kantchev P. (BUL), Kim K. (KOR), Kisrawi N. (SYR), Lazzarini P. (CVA), Magenta A. (I), Masullo G. (I), Mege Ph. (F), Mimis V. (CAN), Montrucchio S. (I), Nalbandian A. (ARM), Olson L. (USA), Perpar S. (SVN), Perrazzino A. (I), Puigrefagut E. (EBU), Salvatori S. (CVA), Simic M. (Ser), Scotti A. (I), Spells G. (UK), Stanley G. (UK), Tsuchida K.(J), Vasseur P. (F).

Part 1

TABLE OF CONTENTS

	<i>Page</i>
Chapter 1 to Part 1	8
1 Introduction	8
1.1 Purpose of Report	8
1.2 General.....	8
1.3 Why Digital? – Technical Considerations	9
1.4 Why digital? – Commercial and regulatory considerations	9
1.5 How digital? – Technical and regulatory considerations	10
1.6 How digital? – Commercial considerations.....	11
1.7 ITU activities	12
1.8 The scope and the future of SG 6	13
Chapter 2 to Part 1	17
2 Overview of broadcasting technologies	17
2.1 Introduction.....	17
2.2 Analogue broadcasting technologies and systems.....	19
2.3 Planning considerations for analogue and digital systems	20
2.4 Digital broadcasting technologies and systems	22
2.5 Digital sound broadcasting	25
2.6 Digital terrestrial television broadcasting.....	29
2.7 Summary.....	38
2.8 Evaluation of potential digital sound and TV broadcasting systems.....	38
Chapter 3 to Part 1	40
3 Application and implementation of digital broadcasting	40
3.1 Regulatory considerations	40
3.2 Efficient usage of broadcasting spectrum.....	41
3.3 Requirements of sound and television broadcasting services.....	41
3.4 Aspects related to the interoperability of systems	42
3.5 Components of digital sound broadcasting equipment.....	43

	<i>Page</i>
3.6 Components of digital television broadcasting equipment.....	44
3.7 Data broadcasting	45
3.8 Broadcasting services for mobile reception.....	45
3.9 Interference aspects	46
Chapter 4 to Part 1	47
4 Transition issues	47
4.1 Spectrum availability	47
4.2 Broadcasting planning principles	50
4.3 Quality of service.....	52
4.4 Economical aspects of spectrum utilization	52
4.5 Health, safety and other legal considerations	52
4.6 Switchover analogue to digital	53
Appendix 1 to Part 1 – Case studies	55
1 Australia	55
2 Brazil	56
3 Bulgaria	57
4 Canada	57
5 China.....	57
6 Germany	58
7 Guinea.....	59
8 Italy.....	59
9 Japan.....	64
10 Kenya.....	64
11 Mexico	66
12 Russian Federation	67
13 Tanzania	67
14 United States of America.....	68
15 Republic of Korea.....	68

	<i>Page</i>
16 Venezuela	69
17 OCDE	69
18 European Union.....	69
19 Rwanda.....	69
Annex 1 – Minimum Technical Specifications of Set Top Box (STB) for Digital Terrestrial Television (DTT) in Rwanda.....	72
Annex 2 – Digital frequency planning of Rwanda	76
Appendix 2 to Part 1 – Glossary (Abbreviations).....	78
Part 2	81
Chapter 1 to Part 2	84
1.1 Digital Radio Mondiale	84
1.2 T-DAB general	91
1.3 IBOC.....	92
1.4 ISDB-TSB.....	103
1.5 ATSC	111
1.6 DVB-T	118
1.7 DVB-H.....	119
1.8 ISDB-T	122
1.9 Terrestrial digital multimedia broadcasting.....	125
1.10 LMDS (local multipoint distribution system).....	128
1.11 Forward link only	130
Chapter 2 to Part 2	133
2.1 Aspects related to interoperability of systems	133
2.2 Mobile services	136
Chapter 3 to Part 2	139
3.1 Report of TG 6/8.....	139
3.2 UMTS/GSM and DVB-T convergence	140
3.3 DRM simulcast	141
3.4 Service planning	142

3.5	Market impact.....	147
3.6	General strategy and coordination.....	150
3.7	Problems related to the interoperability of systems.....	151
3.8	Precautions to control the direct health effects of RF radiation.....	154
3.9	Precautions to control the indirect RF radiation hazards.....	156
3.10	Field-strength values to be determined.....	156
3.11	Additional evaluation methods.....	158
3.12	Legal consideration.....	162
Appendix 1 to Part 2.....		162
1	Australia.....	162
2	Brazil.....	170
3	Bulgaria.....	176
4	Canada.....	181
5	Germany.....	195
6	Guinea.....	196
7	Italy.....	197
8	Japan.....	208
9	Kenya.....	219
10	Russian Federation.....	237
11	Tanzania.....	242
12	United States of America.....	244
13	Republic of Korea.....	248
14	Venezuela.....	250
Appendix 2 to Part 2.....		252

Chapter 1

to Part 1

1 Introduction

1.1 Purpose of Report

Throughout the world, countries are in various stages of switching over from analogue to digital terrestrial broadcasting. The digital systems utilized in different parts of the world are described in Recommendations ITU-R BS.1114-5 (for sound) and ITU-R BT.1306-3 (for television).

This Report attempts to provide an overview of the digital switch-over situation worldwide and will be updated regularly.

In 2006, the ITU's Regional Radiocommunication Conference (RRC-06) comprising 120 Administrations in Region 1 (except Mongolia) and Iran from Region 3, adopted a treaty Agreement (GE06 Agreement) that includes a frequency Plan for the digital sound and television broadcasting service. The Plan was developed based upon the digital sound T-DAB system and the digital television DVB-T system. This is a long-term Plan which is based on a mask concept and defined protection and interference criteria that would allow for further evolution of this Plan¹.

1.2 General

The process of migration, or "Switchover" from analogue to digital techniques can take many routes, each with its own advantages and disadvantages in terms of rapidity, the players involved, and the degree of government intervention. Often influenced by the local broadcasting legacy, each country will follow its own switchover path. Switchover implies more than a technical migration as the role of TV and radio in modern societies is economic, social and political. Appendix 1 Part 2 (Case studies) is intended to demonstrate the existing and planned transition from analogue to digital systems in different countries.

Switchover affects all segments in the broadcasting value-chain: from content production through transmission to reception, all of which require technical upgrading to support digital broadcasts. The serious challenge is to replace or upgrade the huge installed base of analogue receivers. This can be done with integrated digital receivers, or "set-top-boxes" taking care to modify such things as antennas, dishes, cabling, etc. as appropriate.

While market forces and consumer demand will eventually drive the digitalization of broadcasting it is important to remember that the change has been facilitated by technical development. In broadcasting, as in many other industries, changes are brought about as much, if not more, through the emergence and exploitation of new technologies than by a perceived business demand. With this in mind, it is worth first briefly examining the benefits that digitization might offer.

¹ Art. 5.1.3 of GE06 Agreement:

"5.1.3 A digital entry in the Plan may also be notified with characteristics different from those appearing in the Plan, for transmissions in the broadcasting service or in *other primary terrestrial services* operating in conformity with the *Radio Regulations*, provided that the peak power density in any 4 kHz of the above-mentioned notified assignments shall not exceed the spectral power density in the same 4 kHz of the digital entry in the Plan. Such use shall not claim more protection than that afforded to the above-mentioned digital entry."

1.3 Why Digital? – Technical Considerations

A primary benefit of digitalization is greater control over channel performance. The overall performance of an analogue radiocommunications channel is dictated largely by the characteristics of the channel itself. The scope for exploiting the “trade-offs” implicit in Shannon’s Theorem (Shannon, C. E. [1949] *The Mathematical Theory of Information*.: University of Illinois Press) is limited. By contrast, the overall performance of digital systems is largely governed by the quality of the conversion processes (analogue to digital and vice versa) provided that the capabilities of the channel are not exceeded. There is much greater scope for exploiting the “Shannon trade-offs”, particularly if error correction techniques are used. In effect the performance of analogue systems tends to deteriorate as the channel performance deteriorates while digital systems remain as defined by the conversion processes until they fail completely. Unfortunately, this means that the subjective effects of channel performance on digital systems can be much more obtrusive when working close to the ultimate channel capacity.

Of seminal importance is the ability of digital systems to compress data into a smaller space with the consequently delay output of the signal. In the broadcasting context this means the use of compression coding techniques which allow relatively high sound and picture quality to be accommodated in a much smaller channel bandwidth. A related benefit is the ability to trade between quality (which is dictated primarily by the degree of compression) and spectral occupancy more or less at will.

The two factors taken together have allowed digital broadcasters to transmit various combinations of high definition (HDTV) and standard definition (SDTV) programs and ancillary data in the same amount of spectrum as one analogue channel while the transmitter power per channel is approximately one fifth of that for an analogue channel. The major selling point for digital TV systems is the ability to offer the viewer and listener more services, greater variety and higher technical quality.

Further to this, digital systems offer additional benefits. Firstly, the relatively easy addition of ancillary data services allows such features as automatic or semi-automatic tuning, multiple camera angles, conditional access and the inclusion of supplementary (or even completely unrelated) data streams. Secondly, digital broadcasting techniques can offer credible “single frequency networks”. This in its turn makes for even more efficient use of available spectrum, potentially opening the door to even more audience choice. Another technical solution related to digital broadcasting technology is the possibility to adopt them for mobile receiving devices.

1.4 Why digital? – Commercial and regulatory considerations

As already stated, the major commercial advantage of digital broadcasting is the ability to offer a greater range and diversity of services and applications. This is attractive from the broadcaster’s perspective since this can be done ultimately without the need for additional spectrum (after transition period) and with lower transmitter power. New commercial opportunities will exist. The more consistent, if not better, subjective quality can be a benefit to both providers and users, as can the ancillary services like automatic re-tuning on a car radio for example.

In an environment where the regulatory authority can charge users for the use of spectrum, the availability of a greater number of channels can generate greater income or allow lower rates to be charged to a wider range of users. Some in the regulatory community might even be keen to force the analogue switch off as soon as possible, commensurate with not causing disquiet among listeners and viewers, in order to release the spectrum for other uses.

There are, however, commercial drawbacks. For any individual broadcaster there is the cost of re-equipping and it is unlikely that this will be offset by increased revenue (advertising or subsidy).

Persuading the audience to invest in new receivers, or set top boxes, is of fundamental importance to the venture. This cannot be stressed too highly and to do it, it is necessary either to offer a wider range of high quality programming or threaten to discontinue the analogue service. The latter course can be taken at the behest of the administration or government or by way of a commercial decision by the broadcasters. In some environments, spectral allocations are traded between broadcasters (and new entrants). The availability of more channels in such an environment will, in the short term at least, upset the commercial balance by depressing the value of the existing allocations.

1.5 How digital? – Technical and regulatory considerations

There is little compatibility between digital and analogue broadcast transmission systems. While this can cause some transition problems it is generally advantageous because the digital systems have been optimized against their own technical and financial drivers and are not compromised by having to be compatible with less advanced existing technologies. A primary consideration with the familiar NTSC, PAL and SECAM analogue colour TV systems was their backward compatibility with the existing black and white transmissions.

Any technical transition, or “Switchover”, strategy must work within certain commercial and regulatory imperatives. Commercial considerations are discussed in more detail in the next section but in essence any transition strategy will probably demand the continued availability of analogue versions of existing programme streams until a high proportion of the audience is able to receive the digital services by one delivery means or another (satellite, cable or terrestrial broadcast). Typically, this will mean that digital and analogue versions of the same programmes are broadcast simultaneously during the transition period (i.e. simulcast). Various technical strategies can be and have been deployed to achieve this.

The easiest is to allocate a new band of spectrum to accommodate the new programmes. In the fullness of time, as migration takes place, the old spectrum can be given up. If necessary, and with careful planning and equipment design, it may eventually be possible to transfer the digital services back to the original band. Eureka 147 DAB has been introduced into Europe in this way. The technical characteristics of the system even allow different bands to be used in different countries.

Given the lower demands in both bandwidth and power of digital systems there can be scope for digital transmissions to fit into bands that are already occupied with other services. Typically this will involve a small deterioration in quality (an increase in interference) to the existing analogue services but this could be tolerable because:

- it is potentially small;
- it is temporary – until the digital service becomes the norm;
- it is a key element in facilitating the transition.

The introduction of digital terrestrial television services to UHF bands 4 and 5 in the United Kingdom is an example of this approach. Its effectiveness depends on the existing degree of band congestion.

Where a digital transmission can be made to occupy the same amount of spectrum and have the similar interference impact as an analogue signal it might be possible to simply replace an existing analogue service with a digital one or to use an existing, unused allocation. In most bands there are few unused allocations and so this strategy relies on there being broadcasters which simultaneously transmit the same material on different channels (or even platforms) and are prepared to risk one (the smaller) audience re-tuning to the other frequency. This strategy is currently being used in the AM bands, HF, MF and LF, to mount experimental DRM transmissions. In the HF bands there are possibilities to coordinate channels through the various informal coordinating bodies. There are

however, still problems with congestion in the lower frequency HF bands and with the limited availability of suitable transmitting plant.

Another approach that is being pursued, notably in the United States of America with the IBOC systems, fits the digital signal simultaneously into the same channel as the analogue signal. This is only possible where the channelling arrangements allow it and great care needs to be taken to prevent unacceptable levels of co and adjacent channel interference.

If new spectrum is not available and the digital transmissions cannot co-exist with the analogue ones, the switchover might have to take place “overnight”. This will be expensive for all concerned.

1.6 How digital? – Commercial considerations

It seems unlikely that there has been or will be any pressure from the audience to introduce digital services for their own sake. Audience take up is driven much more by the potential benefits:

- the availability of a wider range of services and applications,
- the availability of premium (conditional access – subscription) services and applications such as first run films and sport,
- improved formats such as wide screen, high definition and surround sound,
- improved sound and picture quality,
- programme associated data, metadata or even independent services like web pages,
- easier access – particularly to specialist material, and
- easier selection of programming – e.g. automatic switching between different LF, MF and HF transmitters or electronic programme guides.

These must be traded against the perceived cost of new equipment and possible subscription costs. It is essential therefore that the audience is presented with an attractive package of services and applications at a price that it is prepared to pay. The drivers on the industry are therefore the production of more and increasingly attractive programme content and the deployment of receivers at appropriate prices.

Receiver price is driven by a number of factors, not least the willingness of the broadcaster or regulator to subsidize the cost in order to promote sales and uptake of the service. DVB-S receivers in the UK are “free issued” as part of an interactive subscription package. Any switch over strategy must recognize that, the user community can generally be divided in three in its willingness to invest in new technology. The “early adopters” tend to be enthusiastic about technological development and will invest in new machinery simply in order to have it at an early stage. Such people will typically be prepared to pay a high price for new equipment. In the early stages of product life, the manufacturers rely on this community to offset some of the high development costs of new consumer equipment. The early adopters are followed by the “mainstream”. These users will be much more circumspect about price and will compare the value they put on the new service/application with the cost of making the change before actually buying a new receiver. These people know that they intend to make the change but do so when the cost of the receiver has dropped (as it inevitably will) to the level they are prepared to pay. The third group, the “unwilling” have typically decided that they will never change or they have sufficiently little interest in the subject that they are unaware of the development. These people will only change when they absolutely have to (perhaps because the analogue service is withdrawn) or when the price becomes so low that it is not important and digital has anyway become the standard.

This simplistic model of the market is clearly going to be distorted by factors such as subsidies and the threat of discontinuing the analogue services. The threat of discontinuation is a (market) driver that must be used with extreme caution. Public service broadcasters as well as the advertisers who

fund a large part of the broadcasting industry will not be pleased to find themselves “cut off” from an established audience if “switch off” is contemplated before a substantial proportion of it is able to receive the new service. The community of broadcasters will be unwilling to turn any of their services off before the audience drops to the point where the transmission cost is not viable.

One thing can be stated with certainty. Continued technical development and an ever expanding consumer base will mean that the cost of producing receivers will fall. This in turn will push down the purchase price. Continuous development in the integrated technology sector means that systems of ever greater complexity can be accommodated on small silicon chipsets. Receivers with diverse capabilities and single function machines can all use elements of the same chipset, the manufacturing cost of which depends far more on production volumes than on functionality. Stifled development of purely analogue receivers will mean that the time will come when they are more expensive than their much more capable digital brothers. At this point the pressure for switch over will be unstoppable.

While the broadcasters are potentially easier to persuade than the audience when it comes to deploying new equipment, the process is not cost free. If transition is to be achieved within realistic timescales and budgets, every effort must be made to re-use existing analogue plant if at all possible. Thankfully, where services are to be mounted in existing frequency bands, the transmitters and antennas, which at the lower frequencies are usually expensive and difficult to replace, can often be adapted to work with the digital transmissions. Most of the DRM transmissions now currently being broadcast around Europe are carried on analogue transmitters which have been adapted. While these transmitters are not usually optimized for carrying digital transmissions, the design considerations are quite different, this strategy can allow the plant to continue to be used for analogue services as well as digital during the transition period. In addition the cost of producing and transmitting analogue and digital versions of the same programme material at the same time must not be ignored.

1.7 ITU activities

The ITU will continue to play a pivotal role in the regulation of spectrum usage and broadcast technologies. A debate on spectrum aspects of switchover has already been launched among some administrations within the spectrum policy framework. The top-level objective is to encourage efficient and flexible spectrum usage, while preserving the service mission of broadcasting. Among other things this will address the economic value of spectrum allocated to terrestrial broadcasting services and the transparency needed in setting this value. It is not envisaged that the ITU should be involved at the level of, for example, common switch-off dates or the prohibition of selling analogue receivers. However, national digital broadcasting markets and policies will continue to be monitored.

The three ITU Sectors, each within its own sphere of competence, are responsible for activities and studies relating to broadcasting (see Chapter 2, Part 1, § 2.1). In particular, Radiocommunication Study Group 6 (SG 6) is mainly involved in this issue. Due to the explosive increase in the convergence of the various media, the introduction of digital technologies and taking into account the approach of SG 6 in studying the broadcasting service as an end-to-end chain, SG 6 is well placed to play an important role in the study of emerging services and applications. These services and applications involve the distribution of multimedia material by new means which include over-the-air distribution to portable and handheld receivers.

1.8 The scope and the future of SG 6

1.8.1 Introduction

On the need to study the broadcasting service on an end-to-end basis, the Radiocommunication Assemblies (Istanbul 2000 and Geneva 2007) have already recognized that the broadcasting service must be studied on an end-to-end basis. Indeed, the terms of reference for SG 6 “Broadcasting services” clearly state that “the Study Group, recognizing that radiocommunication broadcasting extends from the production of programmes to their delivery to the general public studies those aspects related to production and radiocommunication, including the international exchange of programs as well as the overall quality of service”. In effect, broadcasting services are based on a long chain of technical operations that use different technologies and perform different functions, but are closely interrelated, since each operation strongly influences the operations that are located downstream in the chain.

The purpose of these considerations is to provide some further insight in the diversified structure of the broadcasting chain, in order to further clarify the reasons why it is essential to study broadcasting services in a single body. A single body collects all of the diverse expertise needed to cover all the links in the broadcasting chain, keeping in mind that the goal of those studies today, is to issue a set of harmonized ITU-R Recommendations. These Recommendations point the way to achieving the best possible quality of the media (audio, video and data) that broadcasting can provide to the end user (the home listener/viewer) most reliably and with the minimum expenditure of resources (e.g. with an efficient use of the spectrum).

1.8.2 The digital broadcasting chain

Figure 1 shows a very simplified basic block diagram of the digital broadcasting chain. It includes four main conceptual blocks, namely the production block, the delivery block, the reception block and the presentation block.

The production block includes three main conceptual functions, namely: production, postproduction and recording.

Production covers the capture of the various media that form a program (program image and the various accompanying sound components) and their transformation from their original state as perceptual stimuli into their representation as digital signals. This block includes the mixing and sequencing of signals from various audio and video sources. It requires, inter alia, expert knowledge of human psychophysical perception to audiovisual stimuli, including knowledge of colorimetry, and of the sampling of audio and video signals.

Recording covers the recording, playback and archiving of audiovisual programs for their subsequent use. It is used when program material produced in the production block needs to be re-mixed or re-sequenced, or when it needs to be integrated with program material produced at different times. It also covers program archiving, which now attracts the keen interest of broadcasters, in view of the possibility to exploit their asset of recorded programs, for re-use on the air, or for sale on the national and international program market. This study requires in-depth knowledge of the available recording technologies, including knowledge of modern tapeless recording (recording on optical discs, solid-state memories and on computer-type memories) and on the ways to manage the access and exploitation of such program signals.

Postproduction covers all the technical operations required to put the captured program signals in their final form as a finished program. It includes the insertion of component elements in the program, such as the mixing of music and dialogue, the development of special visual effects such as reframing, matting or colouring, the dubbing of program sound, the insertion of archive material in studio sequences, the development of elements related to multimedia and interactive applications,

etc. This study requires, inter alia, expert knowledge of the type and extent of interaction among the various post-processing treatments of image or sound signals, when they are performed in tandem, one after the other, in view of the risk that, cumulating, they may impair the final quality of the image or sound.

FIGURE 1
Conceptual block diagram of the broadcasting chain

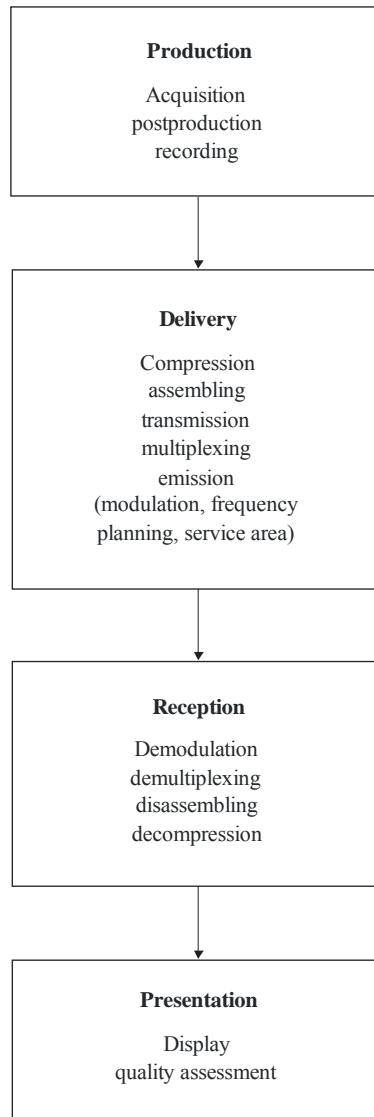

Report BT.2140-01

The delivery block includes four main conceptual functions, namely: compression, assembling, multiplexing and emission.

Compression covers the operations required to reduce the bit rate of each program component (video and audio signals, etc.), in order that they will require as small a bit rate in the emission channel, as it is strictly necessary to deliver the intended image and sound quality to the end user. This study requires, inter alia, an in-depth knowledge of bit-rate-reduction mechanisms and of their impact on the perceptual quality of program material.

Assembling merges the various program components (video signals, audio signals, signals related to multimedia and interactive applications, etc.), in order that they form a properly structured, single serial data stream, that also carries any ancillary information required to manage the program, such as information on intellectual property rights, conditional access, copy protection, etc. This study, as the one described below, requires a good familiarity with the digital protocols used to smoothly multiplex various digital streams into a single stream, e.g.: preserving synchronization of audio and video

Multiplexing merges various program streams together, into a single data stream whose bit rate matches the data capacity of the transmission channel used to deliver the programs carried in the multiplexed stream. It also adds the data required to protect those program signals against errors introduced by the transmission channel. It is at this stage that statistical multiplexing can be best implemented, thus achieving greater exploitation of the bit rate available on the emission channel.

Emission modulates the multiplexed data stream on the channel carrier, in order that it may be broadcast in the foreseen delivery channel. It also studies the frequency plan, the location and design of the emitting antennas and their emitted power. This study requires an excellent grasp of the related spectrum implications, in order to adequately cover the intended service area while complying with the mandated requirements in terms of interference to and from the emissions of other transmitters.

The reception block of the broadcast chain implements functions that are the counterparts of the functions implemented in the delivery block, namely: demodulation, de-multiplexing, disassembling and decompression.

Demodulation operates on the modulated signal received by the receiver at the user premises, recovering the multiplexed bit stream and correcting as far as possible the errors introduced by the transmission channel.

Demultiplexing operates on the multiplexed bit stream, extracting from it the various program streams that are multiplexed on it.

Disassembling operates on a program stream selected among those demultiplexed in the previous function, recovering the compressed signals that contain the components of the selected program (video signal, various audio signals, and data).

Decompression operates on the compressed signals that compose the selected program, recovering them in their uncompressed form.

The presentation block operates on the decompressed signals, processing them in such a way that the original audio and video program material may be properly presented on the set (radio or television) at the end-user premises. This study requires matching the characteristics of the devices originally used to capture the program, to the characteristics of the user's display. With the current advent of new types of displays, this has become an important challenge.

1.8.3 Outline for the future

Radiocommunication SG 6 grasped the multifaceted nature of broadcasting at an early stage of its activity and has promptly and efficiently addressed this challenge.

SG 6 was mandated to conduct end-to-end studies in the following domains:

- production of program material (all functions needed to repackage program material in order that it may also be distributed over the advanced applications such as internet, cellular phones, etc.);
- digital signal compression, assembly of program material and relevant metadata;

- production of television programs for collective viewing in large halls, similar to movie theatres (almost completed);
- distribution of program material by terrestrial broadcasting and by satellite broadcasting service;
- program distribution over new, emerging media such as interactive broadcasting and “webcasting”;
- reception of broadcasting service by the end user;
- provide to the end user the best possible quality of picture and sound;
- subjective assessment and objective measurement of perceptual video and audio quality at the end of a chain, even on-line.

Indeed, the broadcasting chain described above applies to both traditional broadcasting and interactive broadcasting, whether it is over the air, by cable television, by fibre optics or via satellite. The identification of appropriate return channels and of the applicable digital protocols to achieve the desired degree of interactivity is being aggressively pursued in cooperation with other Sectors of the ITU.

Nowadays we witness an explosive increase in the convergence of various media in the wake of the pervasive introduction of digital technologies, the success of the approach taken by SG 6 to the study of the broadcasting service as an end-to-end chain, might encourage extending its study to the repackaging of television program material for distribution by new broadcasting means such as over-the-air distribution of television program material to fixed, portable and handheld receivers or even for distribution of that material over cabled connections by “web-casting” or “cable-casting”.

Chapter 2

to Part 1

2 Overview of broadcasting technologies

2.1 Introduction

This chapter deals with ITU activities and studies concerning analogue and digital broadcasting systems.

The three ITU Sectors, each within its own sphere of competence, are responsible for activities and studies relating to broadcasting.

2.1.1 ITU-R

Radiocommunication Study Group 1 – Spectrum management

- Recommendation ITU-R SM.1047 – National spectrum management
- Report ITU-R SM.2012 – Economic aspects of spectrum management and its Addendum
- Handbook – National Spectrum Management, 2005
- Handbook – Computer-aided Techniques for Spectrum Management (CAT), 2005
- Handbook – Spectrum Monitoring, 2002*.

Radiocommunication Study Group 3 – Radiowave propagation

- Recommendation ITU-R P.1546 – Method for point-to-area predictions for terrestrial services in the frequency range 30 MHz to 3 000 MHz. This revised Recommendation replaces the two former Recommendations ITU-R P.370 and ITU-R P.529, which were the two main Recommendations containing propagation curves for use in predicting field strengths in the case of terrestrial mobile and broadcasting service systems.
- ITU-R Handbook – Terrestrial land mobile radiowave propagation in the VHF/UHF bands, 2002.

Radiocommunication Study Group 6 – Broadcasting service

- In particular the activities of Working Party 6A (formerly Working Party 6E) which is responsible for terrestrial broadcasting standards and planning parameters. WP 6A created a Rapporteur Group to prepare a Report on digital broadcasting technologies and systems, interoperability of digital terrestrial systems with existing analogue networks, and methods of migration from analogue terrestrial techniques to digital techniques.
- Task Group 6/8 prepared a Report for the Regional Radiocommunication Conference-06 (RRC-06) which updated the Stockholm 1961 Plan and the Geneva Plan 1989 (see Chapter 4, Part 1).

2.1.2 ITU-T

SG 9 – Television and sound transmission and integrated broadband cable networks

This is the lead Study Group on integrated broadband cable and television networks, with responsibility for studies relating to:

* See: Supplement to Handbook on Spectrum Monitoring, 2008.

- the use of cable and hybrid networks, primarily designed for television and sound programme delivery to the home, such as integrated broadband networks to also carry voice or other time critical services, video on demand, interactive services, etc.;
- the use of telecommunication systems for contribution, primary distribution and secondary distribution of television, sound programmes and similar data services.

In ITU-T Study Group 9, dealing with integrated broadband cable networks and television and sound transmission, the following Questions and their relevant recommendations are to be found:

Question 6/9 – Digital programme delivery controls for multiplexing, switching and insertion in compressed bit streams, possibly encapsulated in TS or TP packets.

Question 12/9 – Objective and subjective methods for evaluating perceptual audiovisual quality in multimedia services within the terms of Study Group 9.

Question 13/9 – Transmission of Large Screen Digital Imagery programmes for contribution and distribution purposes.

Study Group 9 is responsible for coordination with Radiocommunication Study Group 6 on matters relating to broadcasting.

SG 15: In ITU-T Study Group 15 which covers optical and other transport networks, the following Questions and relevant associated Recommendations will be covered:

Question 1/15 – Coordination of Access Network transport standards.

This Question maintains a comprehensive standards overviews that is updated on a regular basis and can be found at the following website address:

<http://www.itu.int/ITU-T/studygroups/com15/index.asp>.

SG 16 – Multimedia coding, systems and applications.

2.1.3 ITU-D

Specific collaboration was initiated between ITU-D Study Group 2 and Radiocommunication SG 1 with respect to the implementation of WTDC-98 Resolution 9, entitled “Participation of countries, particularly developing countries, in frequency spectrum management”, leading in the first instance to the adoption of a report in that regard. WTDC-02 adopted a revised version of Resolution 9 and required that the corresponding studies be pursued and associated with the work being done on ITU-D Question 21/1 – Calculation of frequency fees. The WTDC-06 has confirmed the same decisions and the work is ongoing. We also note that Question 21/2 is incorporated in Resolution 9 of WTDC-06.

In ITU-D Question 11-2/2 – Examination of terrestrial digital sound and television broadcasting technologies and systems, including cost/benefit analyses, interoperability of digital terrestrial systems with existing analogue networks, and methods of migration from analogue terrestrial techniques to digital techniques, deals with this matter. It should be noted that a summary of the Questions and topics under study, as well as details of approved Recommendations and Handbooks having a particular bearing on developing countries, are provided in ITU-D Study Group 2’s Report on Question 9-2/2 – Identification of study topics in the ITU-T and ITU-R Study Groups which are of particular interest to developing countries.

In this Report, attention is drawn to the main points pertaining to Question 11-1/2:

2.1.4 Regional Radiocommunication Conference

Following the consultations initiated in 2000 regarding the holding of a Regional Radiocommunication Conference (RRC) and planning of the future broadcasting service in the bands 174-230 MHz (VHF bands) and 470-862 MHz (UHF bands), the Plenipotentiary Conference adopted Resolution 117 (Marrakech, 2002) on determination of the planning area for terrestrial television and sound broadcasting in those bands at the Regional Radiocommunication Conference.

At its 2003 session, the Council modified Resolution 1185 to take account of the decisions taken by the Plenipotentiary Conference (Marrakech, 2002) and draw up the agendas of the two sessions of the RRC. In accordance with Council Resolution 1185 (modified, 2003), a report was drawn up in Geneva during RRC-04 (May 2004). It served as the basis for the work of the first session of the RRC, with a view to facilitating the planning exercises prior to the second session and the form in which administrations should submit their requirements. The first session of the conference took place from 10 to 28 May 2004 in Geneva. The second and final session of the Conference took place from 15 May to 16 June 2006 in Geneva. The results are reported in Chapter 4 Part 1, § 4.1.2.

2.1.5 World Radiocommunication Conference

World Radiocommunication Conference (WRC-07) decided to allocate conditionally on a co-primary basis some bands (790/806-862 MHz) to IMT, previously allocated on a primary basis to the broadcasting service (please refer to WRC-07 Final Acts, Article V, Table of Frequency Allocations).

2.2 Analogue broadcasting technologies and systems

Radiocommunication and the Broadcasting service based on the Nikola Tesla inventions, practically, were born at the end of XIX^o century with the Marconi transmissions. Starting from the first decade of XX^o century the scientific theories dealing with the issues of broadcasting were rapidly developed.

The first standard regarding the treatment of the signals on radio frequencies, contrary to our assumption, was the digital type (on-off). The standards used for wire telegraphy were applied to radio transmission, called “telegraphy without wires”. For the development of analogue systems and technology for radio broadcasting it was necessary to wait for the technological development of the “Diode” and “Triode” tubes. “Frequency modulation” and “phase modulation” systems (Recommendations ITU-R BS.467 and ITU-R BS.1194) have progressively complimented the “amplitude modulation” systems (Recommendation ITU-R BS.598), created around 1930. Around 1940, the technologies and standards combining the analogue, amplitude modulation with frequency modulation for video and audio television systems, were the consequence of the intense studies on television systems. Different combinations have originated three different standards adopted by ITU-R around 1960, PAL, SECAM, and NTSC systems (Recommendation ITU-R BT.470). The development of advanced technology in the field of tubes, with the realization of “Tetrode” “Pentode” “Klystron”, led to very compact and high efficiency transmitter and receiver equipment. That allowed the large development of analogue systems for radio and television. At the same time, the new technological invention of the solid state triode, “Transistor”, and all other solid state components, opened the way to the development of a new series of systems, primarily used for receiving equipment and for computer chips.

The satellite technologies came, in about 1960 starting with analogue systems, but rapidly changed to digital.

The new technologies enable the transmission of other data, which makes possible the convergence between broadcasting and telecommunications in general.

2.3 Planning considerations for analogue and digital systems

2.3.1 Background

At the international level, the ITU is responsible for the preparation of standards for broadcasting. The studies in ITU-R are carried out in SG 1 (spectrum issues), SG 6 (RF standards and planning parameters) and the relevant group of SG 2 of ITU-D.

The digital standardization in ITU-R began in around 1960 and the first planning of analogue systems by satellite (WARC-77) opened the way for digital systems.

The technological convergence between broadcasting and computers, in around 1980, gave the impetus to study digital systems and to create digital technology. The low power linear amplifiers used for satellites (transponders) led to the revision of the use of analogue systems for satellite emission. All the chain from the transmitter (Tx) to the receiver (Rx) became digital. At WRC-2000 a fully digital broadcasting plan was created for ITU Regions 1 & 3.

Terrestrial analogue broadcasting was revised by the Regional Radiocommunication Conference, RRC in Region 1 and changed to digital in considering the advantages in spectrum saving, additional services, different types of services and better quality of service. The first part of this conference, which was held in May 2004 (RRC-04), prepared the planning procedure and parameters; the second part (RRC-06) took place in Geneva in May 2006 and prepared the final frequency plan.

In the year 2000 sound broadcasting created digital systems for different frequencies (DAB, DRM, and IBOC). The improvement in reception quality of digital radio may make some of the broadcasting bands more attractive to commercial broadcasters. ITU-R has standardized the system DRM for frequencies below 30 MHz and IBOC for the medium wave bands (Recommendation ITU-R BS.1514). Due to the fact that all the new standards are based on digital technologies, the previous border in-between sound broadcasting and TV broadcasting is disappearing. Nowadays, it is possible to broadcast sound, TV and data with all the digital standards such as ATSC, DVB-T, ISDB-T, DVB-H, ISDB-T_{SB}, T-DMB and DTMB (Digital Television Terrestrial Multimedia Broadcasting). This means that with a single digital receiver or set-top box, it is possible to have access either to TV content, data or radio services. In the rest of this Report, the different standards will be analysed in a traditional way for use by either the sound broadcasting approach or the TV broadcasting approach.

Digital technology, even if it is now mature, depends on the availability of low cost receivers. This facility has to be supported by a large availability of programme emissions.

The transition period was obviously the main point for the final application of digital systems.

Another very crucial point for the transition from analogue to digital systems is the Planning.

All plans adopted by ITU until 2006 were mainly analogue plans, trying to satisfy the increasing demand for channels and on-air time from some Administrations. This growing demand has led to an increase in the level of interference within the available frequency spectrum. It shall be noted that the improvement of receiver characteristics has improved spectrum efficiency.

Digital techniques offer the possibility not only to trade quality for channel capacity but also to use the available capacity more effectively. Increased demand for channel capacity from commercial broadcasters means that both of these features will need to be exploited. The present situation, with the increasing demand for additional services from commercial operators leads to a demand for more spectrum. This demand can be satisfied by digital systems which offer higher reception quality together with improved spectrum utilization. The launching of digital systems becomes very desirable. A good example is given by the Geneva-06 Plan (covering 120 Member States of the

ITU), which has accommodated the increased demand for channels in Region 1 (except Mongolia) and in one country of Region 3 (Iran).

The need for additional spectrum during the transition period to satisfy both analogue and digital systems shall be taken into consideration.

It should also be noted that the introduction of digital technology will lead to an improvement in spectrum efficiency.

2.3.2 Sharing broadcasting frequencies bands with other primary services

In planning and using frequencies available for broadcasting, we should keep in mind, that broadcasting does not always have exclusive access to these frequencies and that sharing situations need to be taken into account.

The use of radio spectrum should be based on the ITU Radio Regulations (RR), which in the Preamble states that:

“In using frequency bands for radio services, Members shall bear in mind that radio frequencies and the geostationary-satellite orbit are limited natural resources and that they must be used rationally, efficiently and economically, in conformity with the provisions of these Regulations, so that countries or groups of countries may have equitable access to both, taking into account the special needs of the developing countries and the geographical situation of particular countries (No. 196 of the Constitution).”

In Article 4 of the RR it is also stated that:

“Member States undertake that in assigning frequencies to stations which are capable of causing harmful interference to the services rendered by the stations of another country, such assignments are to be made in accordance with the Table of Frequency Allocations and other provisions of these Regulations.”

In Article 5 of the RR the Table of Frequency Allocations is given for frequencies from 9 kHz up to 275 GHz. For the allocation of frequencies the world has been divided into three Regions as shown on the following map:

FIGURE 2

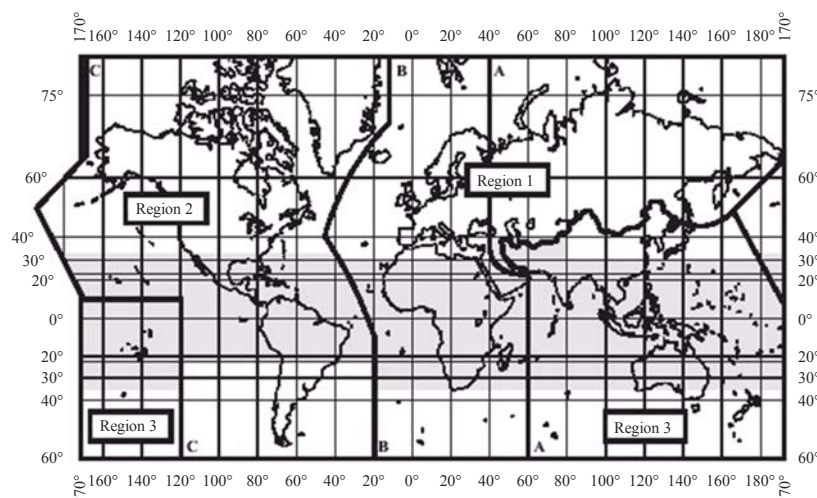

Where, in a box of the Table of Frequency Allocations a band is indicated as allocated to more than one service, either on a worldwide or regional basis, such services may have two categories, primary or secondary. Primary services are printed in the Table of Frequency Allocations with capital letters (e.g. BROADCASTING) and secondary with normal characters (e.g. Fixed).

Stations of a secondary service:

- shall not cause harmful interference to stations of primary services to which frequencies are already assigned or to which frequencies may be assigned at a later date;
- cannot claim protection from harmful interference from stations of a primary service to which frequencies are already assigned or may be assigned at a later date;
- can claim protection, however, from harmful interference from stations of the same or other secondary service(s) to which frequencies may be assigned at a later date.

In the Table of Frequency Allocations, one can see that in different regions, a different status is given to the services.

Additionally, in footnotes to this Table of Frequency Allocations, Administrations from that Region, could have a different situation in their country in comparison to the Region.

In international frequency planning the protection from and to other primary services should be taken into account. This may cause quite a lot of difficulties in planning of the digital broadcasting.

During the transition period, the coexistence of broadcasting signals with other existing non-broadcasting primary services in the same frequency bands is the most important issue to be solved by the Administration and towards this end the Final Acts of WRC-07 are to be taken into consideration.

2.4 Digital broadcasting technologies and systems

2.4.1 Digital fundamentals

There are a number of fundamental technologies which underpin digital broadcasting systems. The more important ones are summarized below.

2.4.2 Background

The digital systems even though they were developed before, had to wait for the invention of the “RADAR”, and “LASER” technologies for their expansion.

Computer technology, now available on the market, equipped with transistors of 30 nm, frequency of 20 GHz or above, static memory of great capacity, permitting software and algorithms, which are always faster and powerful, gives the opportunity to facilitate the substitution of the analogue systems.

These new technologies can also facilitate the convergence between broadcasting and telecommunications.

In some ITU Member States digital sound and TV broadcasting is still a blossoming market, where current difficulties are more regulatory and economic than technological, although new projects continue to be launched.

In Europe, nearly all EU Member States have adopted policy measures to promote digital TV. Some of the EU Member States have also done the same for digital sound broadcasting.

2.4.2.1 PCM and Sampling

Most digital signal representations and processes are based on pulse code modulation (PCM). PCM was invented in the 1930s and allows an analogue waveform to be represented by a string of numbers known as a bitstream. In its simplest form these numbers are “1”s and “0” (on/off keying) representing binary quantities. The advantage of this over (then) conventional analogue transmission was that, provided the channel quality was sufficient to distinguish a “1” from a “0”, the original signal could be reconstructed to a defined accuracy. Digital systems process signals by manipulating the numbers. With ever more powerful and faster digital number crunching devices coming from the IT industry, the opportunities for advanced signal processing are considerable.

There are two fundamental elements to the PCM process.

First is “Sampling”. The analogue signal is represented by a series of discrete samples. While the analogue signal has to be sampled sufficiently often to allow an accurate version of the original to be re-constructed, there is no benefit in sampling more often than is necessary. The Nyquist-Shannon Sampling Theorem specifies the minimum sampling rate as greater than double the highest frequency component present in the analogue original. Sampling at a lower frequency gives rise to an effect called aliasing, familiar to most people from “western” films where the wheels of the stagecoach appear to go backwards. In this instance the sampling frequency is the frame rate of the camera which is insufficient to resolve the positions of adjacent spokes of the wheel. The effect is used beneficially in stroboscopic examination of fast moving objects.

Second is “Digitization”. Each individual sample has to be converted to a (usually) binary number using an analogue to digital converter. Given sufficient quality and resolution in the converter itself, this can be done to any level of accuracy. The price paid for high accuracy is long binary numbers which, in turn demand high bandwidth if they are to be transmitted in “real time”. The noise performance of the overall system is limited by the resolution of the analogue to digital conversion. Any digital representation of an analogue quantity has an error which is less than or equal to half the least significant bit in the binary number. This noise component is called quantization noise and obviously reduces as the number of bits in the digital sample is increased.

2.4.2.2 Bits, Symbols, QAM and IP

While the digital representation almost invariably uses binary numbers it can be wasteful in a channel capable of carrying analogue signals simply to transmit “1s” and “0s”. The channel capabilities can often be better exploited by using intermediate levels as well. By moving to four levels, “0”, “ $\frac{1}{3}$ ”, “ $\frac{2}{3}$ ”, and “1” for example, each level can be made to represent 2 binary bits; “00”, “01”, “10” and “11” respectively. Each discrete level or “symbol” now carries double the amount of information. Depending on the noise in the channel more levels can be resolved allowing each symbol to carry more information. In systems using a carrier or sub-carrier, the phase of the carrier can similarly be varied in discrete steps. This is called phase shift keying (PSK), often qualified as B(inary)PSK for 180° phase shifts and Q(uadrature)PSK for 90°.

Quadrature amplitude modulation (QAM) modulates both the amplitude and phase of the carrier simultaneously. Each symbol is defined by a unique combination of amplitude and phase, chosen to minimize the potential for interference (noise) to confuse any one symbol with others which are in close proximity in terms of amplitude and phase. While any set of symbols can be used, typically 64-QAM with 64 (2^6) unique symbols and 16-QAM with 16 (2^4) are the most common in broadcasting applications; 4-QAM is a variant of QPSK. 64-QAM carries 6 binary bits per symbol and 16-QAM carries 4.

Usually, N -QAM arrangements can be described mathematically. It can be seen that this gives rise to an even spread of N points on a complex plane. This is customarily called a “constellation”.

FIGURE 3
Constellation 16-QAM

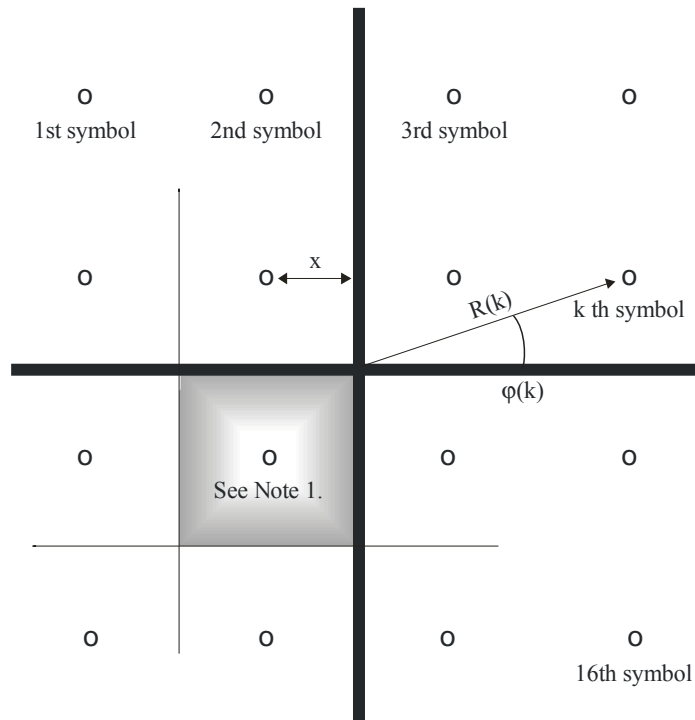

Note 1 – Each point in the constellation occupies a box, the size of which ($2x$ by $2x$) is determined by the signal amplitude. If the combined effects of amplitude and phase noise serve to move the symbol into an adjacent box, accurate decoding is not possible because the symbol will be confused with one of its neighbours.

Report BT.2140-03

2.4.2.3 Time and frequency division multiplexing

It is often advantageous to transmit more than one bit stream in a given channel. One method, frequency division multiplexing (FDM) puts each bit stream onto a different sub-carrier and adds all of the sub-carriers together ready for transmission. This is a familiar technique and has been used for multiplexing analogue signals for a very long time. It relies on the total channel bandwidth being sufficient to accommodate the sum of the bandwidths of the individual components.

Time division multiplexing (TDM) can only be used with digital systems and places bits (or groups of bits) from one stream in a sequence with bits from other streams. In its simplest form a bit from stream 1 is followed by a bit from stream 2, then one from stream 3, etc. until it is time to insert a bit from stream 1 again. Clearly, the more complicated the interleaving structure, the more sophisticated will be the timing and date recovery arrangements. Clearly, the throughput rate, in bits per second, of the channel must be greater than or equal to the sum of the bit rates of all the component bit streams.

Time and frequency interleaving and error correcting code are two other important techniques to be considered.

2.4.2.4 Coded orthogonal frequency-division multiplexing

Coded orthogonal frequency-division multiplexing (COFDM) is used extensively in digital terrestrial broadcasting systems. Early experiments with digital broadcasting showed that there could be severe problems with multipath reception in urban areas. A delayed version of the signal

could be received that was of comparable magnitude with the direct version and the delay was such that adjacent (or even further separated) symbols would become confused and interfere with each other. The solution was to reduce the effective bit rate and add a buffer interval (the so called “guard interval”) to allow the effect of any reflected contributions to stabilize. Rather than transmit the bitstream at full speed it was divided into a large number of sub-streams (almost the opposite of TDM), each with a much lower bitrate and each modulated onto a different sub-carrier; a clear example of frequency division multiplexing. Since the bitrate on each sub-carrier was relatively small, they could be closely spaced and a large number fitted into the channel bandwidth. In COFDM systems, each carrier actually carries an N -QAM signal with N typically 4, 16 or 64 in broadcasting applications.

Conventionally, each sub-carrier in an FDM scheme is extracted from the multiplex by filtering before it is demodulated. This implies a certain separation, or “guard band”, between the modulated sub-carriers. If the frequencies of the sub-carriers are chosen with care they can be made to be mathematically orthogonal. This means that they can be closer and can even overlap. Orthogonality means that the intrusive effect of an adjacent sub-carrier, when integrated over one whole symbol period, is reduced to almost zero; actually zero (only) if the adjacent sub-carrier is unmodulated. Very simply, there is a whole number of cycles of the adjacent sub-carrier within the symbol length when the wanted sub-carrier has been translated to base band.

Inevitably, any radio transmission channel will be affected by flat or selective fading. Hopefully, the channel bandwidth can be sufficient to minimize the former, but selective fading will occasionally take out one or a group of adjacent channels in the multiplex. Interleaving will mean that any errors in the received signal can be spread so as to have a small impact on a large number of samples rather than a gross effect on a few. Coding, or strictly error correcting coding, is used in COFDM to minimize the impact on the overall received signal of selective fading and the occasional “drop out”.

COFDM brings together most if not all of the techniques covered in earlier sections and gives a modulation scheme which is both efficient and robust.

2.5 Digital sound broadcasting

Digital sound broadcasting (DSB) has been launched in various locations in the world with various digital systems: DRM, DAB, IBOC and ISDB-T_{SB}. In the United States of America, digital hybrid systems (Satellite and terrestrial) have been introduced: XM radio and Sirius. The business model of those systems implies subscription. In other parts of the world, radio is free to air since the beginning of radio broadcasting. The main problem is to replace millions of analogue receivers, often very cheap, by more expensive digital receivers during the introduction period.

Most consumers are not aware of digital radio and find analogue radio is good value for money. The gap in terms of quality and added-value from digital radio, or at least the information available to consumers, needs to be important enough to justify the additional cost for the average consumer, although prices are falling. Moreover, even if analogue radio switch-off did occur, little spectrum would be released in comparison with TV and it would likely be absorbed by increased demand for radio broadcasting services.

The situation is more delicate for “stand-alone” digital radio services; that is, services not bundled with digital TV service bouquets nor received over the Internet. Unlike in the United States of America and other parts of the world, digital satellite radio services are not yet broadcast in Europe. Digital terrestrial radio broadcasts started in 1995, based on the Eureka-147 – Digital Audio Broadcasting (DAB) standards. But there are almost no digital receivers on the market and therefore no listeners, although the situation started to improve in 2002, especially in the United Kingdom.

The main problem, as said before, is to replace millions of analogue receivers, often very cheap, by more expensive digital receivers. Most consumers are not aware of digital radio and find analogue radio is good value for money. The added-value from digital radio, or at least the information available to consumers, does not yet seem sufficient to justify the additional cost for the average consumer, although prices are falling. In addition, subsidization of receivers is difficult in Europe as the scope for pay radio is limited. Moreover, even if analogue radio switch-off did occur, little spectrum would be released in comparison with TV and it would likely be absorbed by increased demand for radio broadcasting services.

The migration from a radio service dependent primarily on the application of analogue technologies to one that is based on digital technologies has been evolving over the past 20 years with the emergence of performant algorithms, the evolution of computing power and the availability of digital signal processing (DSP) devices required to allow the introduction of digital sound broadcasting, first in the studio, then in the primary and secondary contribution network, and finally in the consumer area at affordable prices. (According to Moore's Law, the power of computation doubles every 18 months and thus speeds up the process of the introduction of digital technologies). The digital techniques applied to the modulation scheme provide transparent channels. The quality of each part of the sound broadcasting chain has to be close to perfect; the weakest element will be the bottleneck and the final quality will depend on it. Consequently, digital techniques will be applied from the studio up to the contribution network even to feed analogue transmitters such as AM and FM transmitters and obviously to feed digital broadcasting transmitters (DAB, DRM, etc.).

The main advantages of a migration from analogue sound broadcasting to digital are:

a) *Better sound reception*

Since the introduction of new components and devices such as CD players and MP3 players, the public has wanted better audio quality, and even data broadcasting service capabilities.

At the end of the 1990s, European countries developed a new broadcasting service based on OFDM technology, using "state of the art" technologies such as T-DAB audio encoders. T-DAB has consequently constituted the development base of other worldwide systems: DRM, IBOC. The latest digital standards are using MPEG-4 based audio compression standards. As an example, DRM includes three different audio compression solutions (algorithms): AAC+ for multipurpose sound, CELP for high quality speech encoding and HVXC for very low bit rate speech encoding. The three algorithms are part of MPEG-4. The gain in terms of bit rate between the first audio compression algorithms and the latest one is close to 4 times less for the same audio quality.

b) *Attractive new content/programmes*

The introduction of digital technologies and highly efficient audio/video compression allows the introduction of numerous programmes (contents) compared with analogue systems, along with very high quality sound (FM as in the AM bands and CD quality on T-DAB as in stereo sound and multichannel surround sound systems (the 5.1 system for example) accompanying data presentation (programme guides, traffic information). Moreover, the digital sound systems can provide still pictures. In the case of video and/or data requirements, it is necessary for the listener to acquire a dedicated receiver.

The listener benefits from a number of new programmes as a result of the efficiency of the digital technology used: from 1 bit/Hz/s up to 4 bit/Hz/s.

c) *Portability, mobility*

Users want the same capabilities and more in terms of portability and mobile reception as compared with analogue systems (AM, FM).

d) *Efficiency*

The introduction of digital technologies allows:

- improved frequency efficiency in the allocated channel (more programmes) but also the use of the adjacent channel interference-free;
- a drastic reduction in radiated power for the some coverage area with a better audio quality: for example, for the DRM system, 80 kW instead of 250 kW peak power.

2.5.1 Description of digital sound broadcasting systems

Various digital systems have been developed for terrestrial sound broadcasting. The systems considered in this Report are:

- DRM – Digital Radio Mondiale – (System A Recommendation ITU-R BS.1514).
- IBOC – In Band On Channel (System B Recommendation ITU-R BS.1514 and System C Recommendation ITU-R BS.1114).
- ISDB-T_{SB} – Integrated Services Digital Broadcasting Terrestrial – (System F Recommendation ITU-R BS.1114).
- T-DAB – Terrestrial Digital Audio Broadcasting – (System A Recommendation ITU-R BS.1114).

(More detailed information on the above systems can be found in Part 2.)

2.5.1.1 Digital Radio Mondiale

The terrestrial Digital Radio Mondiale (DRM), developed by the DRM International consortium (digital System A for Recommendation ITU-R BS.1514) is designed to provide high quality digital radio broadcasting for reception vehicular, portable and fixed receivers. It is designed to operate at any frequency below 30 MHz for terrestrial. The system allows the development of local services (MW and/or SW in the 26 MHz band), regional services (MW), national services (High power LW, MW, NVIS in SW and even SW from a transmitting site located at a hop from the targeted area) and finally international services for long and very long distance services (SW).

The DRM system is a rugged, yet highly spectrum and power-efficient, sound and data broadcasting system. It uses advanced digital techniques to remove redundancy and perceptually irrelevant information from the audio source signal, and then it applies closely-controlled redundancy to the transmitted signal for error correction. The transmitted information is then spread in both the frequency and time domains so that a high quality signal is obtained in the receiver, even when working in conditions of severe multipath propagation (skywave propagation), whether stationary, portable or mobile. Efficient spectrum utilization is achieved close to 4 bit/Hz/s. DRM allows to broadcast up to 4 different services in an ITU channel (9 or 10 kHz). Due to the use of OFDM modulation scheme, it allows a special feature of frequency reuse permits broadcasting networks to be extended, virtually without limit, using additional transmitters which are all synchronized and operating on the same radiated frequency (SFN). DRM standard includes different modulation modes according to the behaviour of the propagation channel, from a very ruggedized mode C up to a very efficient mode A (up to 37 kbit/s in a 10 kHz channel). DRM standard allows to use different kind of simulcast modes from the single channel simulcast (SCS) which is a compromise which permits to broadcast the same content both in analogue and digital in the same RF channel or multichannel simulcast (MCS) which consist in broadcasting the same content in Analogue and Digital either in two adjacent channels, or non-adjacent channels or also using a combination of frequencies. As an example, broadcasting the analogue content in MW and the digital signal in SW.

Recently, the DRM consortium decided to extend the DRM standard in the VHF bands (band I and II) the specification of the extended standard will be available in a couple of years.

More detailed information on DRM can be found in § 1.1, Part 2.

2.5.1.2 In-Band On-Channel Digital Sound Broadcasting

The In-Band On-Channel digital sound broadcasting (IBOC DSB) system (used only in the United States of America) for operation in MW and VHF band II (Recommendations ITU-R BS.1514 and ITU-R BS.1114), also known as the HD Radio™ system, is designed to operate in three modes: “hybrid”, “extended hybrid” and “all-digital”. The mode of operation depends on the broadcasting frequency, the existing use of the spectrum and the service requirements of the broadcaster. The hybrid mode of operation permits simultaneous broadcast of identical program material in both an analogue and digital format within the channel currently occupied by the analogue signal. The extended hybrid mode also supports simulcasting but allows the broadcaster to add digital carriers closer to the existing analogue signal in order to obtain more digital capacity for advanced audio and data services. The all-digital mode provides enhanced capabilities for operation in the same channel after removal of the existing analogue signal or where the channel is not currently used for analogue broadcasts.

The IBOC DSB system is comprised of four basic components: the codec, which encodes and decodes the audio signal; FEC coding and interleaving which provides robustness through redundancy and diversity; the modem, which modulates and demodulates the signal; and blending, which provides a smooth transition from the digital to either the existing analogue signal, in the case of hybrid or extended hybrid operations, or a back-up digital signal, in the case of all-digital operations.

The IBOC DSB system offers broadcasters and listeners several benefits. At both VHF and MF, the system offers enhanced audio quality. VHF broadcasts provide near CD-quality and MF broadcasts offer VHF quality sound. The broadcasts also offer greater robustness to multipath interference in the VHF band and channel noise in the MF band. The system also allows broadcasters to offer multicasting, which permits broadcasters to introduce up to seven new digital audio channels in addition to the simulcast of existing analogue programming. The IBOC DSB offers program associated data as a basic feature. This allows the receiver to display artist name, song title information and other scrolling data. The system also allows broadcasters to offer advanced data services such as traffic and weather information, navigation system updates, stock quotes, audio storage and replay, and electronic programming guides.

More detailed information on IBOC DSB can be found in § 1.3, Part 2.

2.5.1.3 ISDB-T_{SB}

The Integrated Services Digital Broadcasting – Terrestrial for Sound Broadcasting ISDB-T_{SB} system, (also known as digital system F of Recommendation ITU-R BS.1114, Annex 3), is designed to provide high-quality sound and data broadcasting with high reliability even in mobile reception. The system is also designed to provide flexibility, expandability, and commonality for multimedia broadcasting using terrestrial networks, and conform to system requirements given in Recommendation ITU-R BS.774.

The ISDB-T_{SB} system is a rugged system which uses OFDM modulation, 2 dimensional frequency-time interleaving and concatenated error correction codes. The OFDM modulation used in the system is called BST (band segmented transmission) – OFDM. The system has commonality with ISDB-T system for digital terrestrial television broadcasting in the physical layer. The bandwidth of an OFDM block, called an OFDM-segment, is approximately 500 kHz. The system consists of one or three OFDM-segments; therefore the bandwidth of the system is approximately 500 kHz or 1.5 MHz.

The ISDB-T_{SB} system has a wide variety of transmission parameters such as carrier modulation scheme, coding rates of the inner error correction code, and length of time interleaving. Some of the carriers are assigned to control carriers which transmit the information on the transmission parameters. These control carriers are called TMCC carriers.

The ISDB-T_{SB} system can use high compression audio coding methods such as MPEG-2 Layer II, AC-3 and MPEG-2 AAC. Also, the system adopts MPEG-2 systems. It has commonality and interoperability with many other systems which adopt MPEG-2 systems such as ISDB-S, ISDB-T, DVB-S and DVB-T.

More detailed information on ISDB-T_{SB} can be found in § 1.4, Part 2.

2.5.1.4 Terrestrial digital audio broadcasting

The Terrestrial digital audio broadcasting (T-DAB) developed within Eureka 147 project, (digital System A of Recommendation ITU-R BS.1114) is designed to provide high quality, multi-service digital radio broadcasting for reception by vehicular, portable and fixed receivers. It is designed to operate at any frequency up to 3 000 MHz for terrestrial, satellite, hybrid (satellite and terrestrial), and cable broadcast delivery. The system is also designed as a flexible, general-purpose integrated services digital broadcasting (ISDB) system which can support a wide range of source and channel coding options, sound-programme associated data and independent data services, in conformity with the flexible and broad-ranging service and system requirements given in Recommendations ITU-R BO.789 and ITU-R BS.774.

The T-DAB system is a rugged, yet highly spectrum and power-efficient, sound and data broadcasting system. It uses advanced digital techniques to remove redundancy and perceptually irrelevant information from the audio source signal, and then it applies closely-controlled redundancy to the transmitted signal for error correction. The transmitted information is then spread in both the frequency and time domains so that a high quality signal is obtained in the receiver, even when working in conditions of severe multipath propagation, whether stationary or mobile.

Efficient spectrum utilization is achieved by interleaving multiple programme signals and a special feature of frequency reuse permits broadcasting networks to be extended, virtually without limit, using additional transmitter all synchronized and operating on the same radiated frequency (SFN).

More detailed information on T-DAB can be found in § 1.2, Part 2.

2.6 Digital terrestrial television broadcasting

2.6.1 Introduction

Digital TV was introduced in 1994 in the United States of America and in 1996 in Europe and Japan, first on satellite and soon after on cable and terrestrial networks, based on the Advanced Television Systems Committee (ATSC), digital video broadcasting (DVB) and Integrated services digital broadcasting (ISDB) specifications.

The EU average household penetration was estimated in 2002 at 32 million (21%): satellite: 21.5 million (13.9%); cable 8.1 (5.2%); terrestrial 2.6 (1.7%). Digitization of satellite TV is market-led.

With the advent of digital television, the public authorities must consider the future and make preparations for the transition from analogue to digital television to be as smooth as possible. The United States is scheduled to cease analogue television broadcasting in February of 2009. Japan is scheduled to cease analogue television broadcasting in July of 2011. Korea plans to make the transition from analogue to digital in December 2012. Some European countries have already decided to impose a cut-off date by which analogue television broadcasting will cease, with an

EU-wide deadline already agreed for the year 2012. Brazil is scheduled to cease analogue television broadcasting in 2016.

There is therefore a need for government authorities to study the policy implications, proposed services, market (potential audience and financial volume), availability of channels for introducing digital television service and, of course, the technical integration of such a service in the existing analogue network.

The first stage in such a migration requires that a regulatory framework (law or ordinance) be set up to govern the introduction of digital television, specifying the number of multiplexes authorized (several broadcast channels per multiplex, one multiplex occupying the equivalent of an analogue channel) and the types of service.

The migration from a television service dependent primarily on the application of analogue technologies to one that is based on digital technologies has been evolving over the past thirty years. This television service migration is part of a natural outgrowth of the convergence of the television, telecommunications and computer arts and sciences through the shared use of digital technology.

The input and output signals of television systems, at the camera and at the receiver, respectively, are inherently analogue. Thus, the question “Why digital?” is a natural one.

While signal degradations in the analogue signal are cumulative and the characteristics of the degradations make them difficult to distinguish from the video signal, the ability to regenerate a digital pulse train exactly renders the digital signals theoretically immune to impairments from external sources. Digital bit streams can be interleaved within a single channel. This interleaving process allows for the emission, transmission, storage or processing of ancillary signals along with the video and associated audio. Further, compression techniques based on redundancy reduction can be applied to digitized video and audio services allowing the possibility of transmitting one HDTV service, multiple standard services or combinations of HDTV and SDTV in an existing broadcasting channel.

The arrival of the second and third generation component and composite digital video tape recorders, switchers, animated graphics and special effects machines and agreement on a serial digital signal interface by 1990 have sped up the move to implementation of the all-digital production facility. Digital production and use of digital tape recorders moved the broadcaster’s practice on multi-generation editing from five generations of post-production editing using analogue technology to tens of generations using digital technology. The application of digital techniques has reduced camera set-up time from hours to near-instantaneous. Digital library systems made the location of recorded media transparent to the user. Computer control of the entire process penetrated deeply into the programme generation and distribution facility, bringing with it precise control and function repeatability.

The first use of digital broadcasting technologies has been for distribution between the studio and the transmitting sites either via satellite or terrestrial links.

Consequently the advantages of the digital terrestrial television broadcasting (DTTB) are as follows:

As well as more channels than analogue television, digital television terrestrial (DTT) offers advantages likely to encourage viewers to buy or rent a decoder in order to receive it:

a) ***Better images and sound*** – A driving force behind the development of DTT was the ability to transmit high definition television (HDTV) to consumers. HDTV with high quality surround sound is the major focus of all delivery platforms including terrestrial broadcasting, satellite and cable. HDTV is also being delivered on disk using Blue-ray technology.

b) **Attractive new programmes** – The attraction must be real and sufficient to capture audiences. Three types of channel are likely to arouse viewer’s interest: general channels which either innovate or differentiate themselves from existing ones; more thematic channels, sufficiently encompassing and likely to appeal to a fairly broad target audience; and local or regional channels, which respond to the social, economic, and political concerns of viewers in their immediate geographic environment.

c) **Portability** – In the absolute, this is the ideal technical solution: by means of an antenna integrated within or connected to the set, television can be received outdoors as well as anywhere in the house, even on a pocket set. In terms of broadcasting infrastructure, however, it will be costly, as the main transmitters will need additional relays in order to provide all viewers in the DTT coverage area with portable reception.

d) **Interactivity** – DTT is also presented as offering viewers interactive services and applications – in other words, as allowing a dialogue between the television user and a service provider, for example provision of information, transaction services such as television shopping, gambling and banking. Ultimately, technological convergence should enable television to be the vector or the receptacle of multiple functions. However, the relatively slow take-up rate of the Internet in some countries where it is available shows that part of the population is reluctant to use such services. Their development may also be restricted by the narrow capacities of the available frequencies. Furthermore, some people are of the opinion that the television remote control is probably not the most user-friendly tool for navigating within an interactive programme or service, and it will be some time before there is any improvement in connection and response times.

e) **Mobility** – One of the most obvious advantages of terrestrial broadcasting compared with other means of broadcasting is the capability to provide mobile reception for cars, trucks, buses and trains.

The most difficult switchover case is with terrestrial TV due to such factors as lack of spectrum in certain areas, cost of achieving wide coverage, relatively limited network capacity, competing TV offers already in place, and business mistakes.

However, there are significant national differences, notably in relation to market variables like penetration of individual TV networks (terrestrial, cable and satellite) and business models (free-to-air versus pay-TV), but there are also differences between national policies regarding the migration to digital broadcasting. So far, digital TV has mainly grown on the back of satellite pay-TV, with free-to-air still accounting for less than 20% of total digital TV viewing. In turn, pay-TV has been driven by multi-channel and premium programming, together with operator’s subsidies for set-top-boxes.

2.6.2 Description of digital television broadcasting systems

Various digital television systems have been developed for terrestrial broadcasting. The relevant systems are:

- ATSC DTV – Advanced Television Systems Committee – (System A).
- ATSC-M/H – Advanced Television Systems Committee Mobile & Handheld.
- DTMB – (GB 20600-2006: “Framing structure, Channel coding and modulation for digital television terrestrial broadcasting system” (System D).
- DVB-H – Digital Video Broadcasting Handheld.
- DVB-T – Digital Video Broadcasting Terrestrial – (System B).
- ISDB-T – Integrated Services Digital Broadcasting Terrestrial – (System C).

- T-DMB compatible with T-DAB (Recommendation ITU-R BT.1833, ETSI TS 102 427 and ETSI TS 102 428).
- ISDB-T_{SB} – Integrated Services Digital Broadcasting-Terrestrial Sound Broadcasting – (Recommendation ITU-R BT.1833 Multimedia System F).
- FLO – Forward Link Only (Recommendation ITU-R BT.1833, Multimedia System M, TIA-1099).

Details of systems A, B, C and D may be found in Recommendation ITU-R BT.1306 and in Report ITU-R BT.2035 – Guidelines and techniques for the evaluation of digital terrestrial television broadcasting systems. Recommendation ITU-R BT.1833 – Broadcasting of multimedia and data applications for mobile reception by handheld receivers, defines T-DMB as Multimedia System “A”, ISDB-T one segment as Multimedia System “C”, ISDB-T_{SB} as Multimedia System “F”, DVB-H as Multimedia System “H” and Forward Link Only (FLO) as Multimedia System “M”.

For more details see Part 2.

2.6.2.1 ATSC

The ATSC Digital Television Standard was designed to maximize the ability to transmit high quality video and audio and ancillary data within a single 6 MHz terrestrial television broadcast channel. This design focus resulted in the advent of digital high definition television (HDTV) and multichannel surround-sound as well as the capability to provide multichannel standard definition and data broadcast and interactive services.

The 8-VSB modulation mode for terrestrial broadcasting was designed for spectral efficiency, maximizing the data throughput with a low receiver carrier-to-noise (C/N) threshold requirement, high immunity to both co-channel and adjacent channel interference and a high robustness to transmission errors. The characteristics of 8-VSB allow the use of DTV channels in a crowded spectrum environment that contains both analogue and digital television signals. Lower power requirements of 8-VSB allow ATSC DTV stations to exist on channels where analogue stations cannot due to interference constraints. The spectral efficiency and power requirement characteristics of 8-VSB are essential to the conversion of terrestrial broadcast transmission from analogue to digital since new spectrum is not allotted during the transition phase.

The ATSC system uses the MPEG-2 transport stream syntax for the packetization and multiplexing of video, audio, and data signals for digital broadcasting systems. The Program and System Information Protocol (PSIP) defined in ATSC standard A/65, is a small collection of tables designed to operate within every Transport Stream (TS) for terrestrial broadcast of digital television. Its purpose is to describe the information at the system and event levels for all virtual channels (channel numbers are not tied directly to the actual RF channel frequency) carried in a particular TS. Additionally, information for analogue channels as well as digital channels from other Transport Streams may be incorporated.

ATSC utilizes the MPEG-2 video stream syntax (Main Profile at High Level) for the coding of video. Table 1 lists the compression formats allowed in the ATSC Digital Television Standard. Note that both 60.00 Hz and 59.94 (60x1000/1001) Hz picture rates are allowed. Dual rates are allowed also at the picture rates of 30 Hz and 24 Hz.

TABLE 1
Compression formats

Vertical lines	Pixels	Aspect ratio	Picture rate
1 080	1 920	16:9	60I, 30P, 24P
720	1 280	16:9	60P, 30P, 24P
480	704	16:9 and 4:3	60P, 60I, 30P, 24P
480	640	4:3	60P, 60I, 30P, 24P

The ATSC Standard – Digital Audio Compression (AC-3) as defined in the ATSC A/52B is used for the coding of audio. Enhanced AC-3 (E-AC-3) which provides additional coding tools and capabilities is also defined by the A/52B Standard.

ATSC has developed a suite of data broadcast standards and the ACAP standard for interactive television services.

ATSC-M/H

ATSC-M/H (A/153) provides mobile/pedestrian/handheld broadcasting services using a portion of the ~19.39 Mbit/s ATSC 8-VSB payload, while the remainder is still available for HD and/or multiple SD television services. The M/H system is a dual-stream system – the ATSC service multiplex for existing digital television services and the M/H service multiplex for one or more mobile, pedestrian and handheld services.

The ATSC Mobile/Handheld service (M/H) shares the same RF channel as a standard ATSC broadcast service described in ATSC A/53. M/H is enabled by using a portion of the total available 19.4 Mbit/s bandwidth and utilizing delivery over IP transport. The overall M/H system is illustrated in Fig. 4.

FIGURE 4

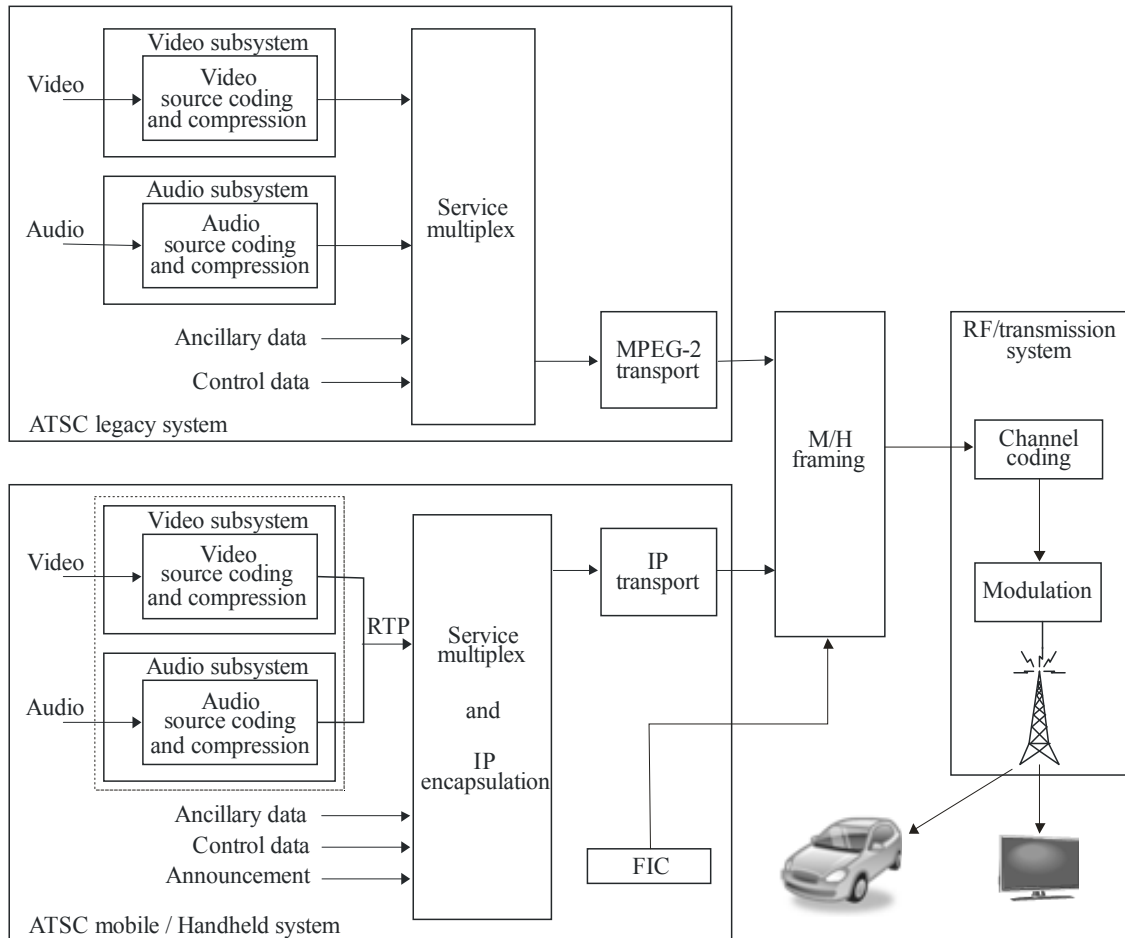

Report BT.2140-04

More detailed information on ATSC can be found in § 1.5, Part 2.

2.6.2.2 DTMB

The Chinese DTTB national standard, “Framing structure, channel coding and modulation for digital television terrestrial broadcasting system” was issued on 18th August 2006 by Standardization Administration of China and became mandatory on 1st August 2007. The system was named Digital Television Terrestrial Multimedia Broadcasting with the acronym DTMB. DTMB system was designed with built-in flexibility, adapt to variety of reception: it is capable of coping not only with fixed reception but also mobile reception, simultaneously supports the application in the adjacent channels to an analogue TV channel, and the framework of single frequency network with the same programme.

DTMB system had a special design on the PN sequences as the frame header and symbol guard interval insertion that can achieve rapid and efficient channel estimation and equalization, Low Density Parity Check coding (LDPC), spread spectrum transmission of the system information, etc. The system supports data rates from 4.813 Mbit/s to 32.486 Mbit/s, having application to standard-definition television (SDTV) and high-definition television (HDTV). The system was designed for the current 8 MHz TV channel spacing used in China, but it can also support systems with either 6 MHz or 7 MHz TV channel spacing used in other countries.

It provides service flexibility, with constellation mapping of 64-QAM, 32-QAM, 16-QAM, 4-QAM, 4-QAM-NR, FEC coding LDPC (7488, 3008), (7488, 4512), (7488, 6016), frame header length PN420, PN595, PN945 and two kinds of convolutional interleaving possibility, if desired, of many options. Mobile reception is possible for 4-QAM-NR, 4-QAM even 16-QAM and also for higher modulation orders, proven by extensive laboratory measurements and field trials under different channel conditions.

The system had strong robustness under different environments, against the echoes from terrain or buildings or co-channel signals from distant transmitters or in an SFN. This capability will improve spectrum utilization efficiency when planning digital television services in crowded spectrum conditions as occurs in China.

DTMB system included randomization for energy dispersal, channel coding, interleaving, constellation mapping, framing structure, processing of frame information, processing of baseband signals and RF signals in every digital television band in UHF and VHF spectrum.

Now, a series of relevant digital terrestrial television specifications are under development, and several transmitting stations in Olympic cities are being established, and the HDTV program has been launched in Beijing in January, 2008.

2.6.2.3 DVB-H

The merger of audiovisual and telecommunication services has already been implemented, as most telecommunication actors envisage having TV over xDSL. No doubt the user will soon require the associated service environment to be available on the move. Services can be expected to benefit from a window of opportunity of 8-15 years (eight years is the approximate time frame from now until analogue TV simulcast is turned off in most countries, while 10-15 years is the time before new radio systems, whose requirements are currently being discussed under the label “4G”, are rolled out-assuming it will take ten years for 3G to reach break-even point). The opportunity comes from the fact that cellular associated with DVB-T/H would potentially have some of the expected 4G capabilities.

At the basis for the commercial provision of convergent services in mobility, particularly use is made of the DVB-T/DVB-H standard and the concept of wireless communication networks (GSM/GPRS, UMTS) combined with terrestrial DVB broadcast networks.

In the new business and regulatory environment, the longer-term activities of various international work-groups such as DVB and 3GPP have slowed down as industry searches for a shorter-term return on investment. The project will bridge this recent trend with the latest technological developments, allowing DVB in particular to keep its worldwide domination as a broadcasting standard toolbox by supporting the design and testing of the DVB-H standard that is necessary because DVB-T is presently being challenged by ISDB-T in mobility and power consumption issues.

A study on mobile TV (October 2007) was made by the Policy Department of the Economic and Scientific Policy Directorate of the European Parliament.

More detailed information on DVB-H can be found in Part 2, § 1.7.

2.6.2.4 DVB-T

The Digital Video Broadcasting – Terrestrial (DVB-T) system was essentially designed with built-in flexibility, in order to be able to adapt to all channels: it is capable of coping not only with clear channel but with interleaved planning, i.e. in the adjacent channels to an analogue transmission, and even co-channel operation for the same programme by different transmitters (SFN).

The multi-carrier (DVB-T) system was designed originally for the 8 MHz UHF channel spacing used in Europe and has been adapted to fit 7 and 6 MHz channels. Depending on the choice of coding and modulation parameters, data rates from 20 to 30 Mbit/s can be realized to deliver high quality digital television through the broadcasting channels. Equally, lower data rates can be employed in cases where additional ruggedness is considered to be desirable.

It also permits service flexibility, with the possibility of reception by rooftop antennas and also, if desired, of portable reception. Mobile reception is possible for quadrature phase-shift keying (QPSK) and also for higher modulation orders, proven by extensive laboratory measurements and field trials under different channel conditions.

The system was also designed to be robust against interference from delayed signals, either echoes from terrain or buildings or signals from distant transmitters in an SFN. This capability will improve spectrum utilization efficiency when planning digital television services in crowded spectrum conditions as occurs in Europe.

The DVB-T system features a number of selectable parameters, which allows it to accommodate a large range of values for C/N ratio and channel behaviour, allowing fixed, portable, or mobile reception, with a trade-off in the usable bit rate. The range of parameters allows the broadcasters to select an appropriate mode for the foreseen application. For instance, a very robust mode (with correspondingly lower payload) is needed to ensure portable reception. A moderately robust mode with a higher payload could be used where the digital services are interleaved with analogue services (for example in the adjacent channels to analogue). The less robust modes with the highest payloads can be used if a clear channel is available for digital television broadcasting.

More detailed information on DVB-T can be found in Part 1, § 1.6.

2.6.2.5 ISDB-T

The Integrated Services Digital Broadcasting – Terrestrial (ISDB-T) system (used in Japan) is designed to provide reliable high-quality video, sound, and data broadcasting not only for fixed receivers but also for portable/mobile receivers. The system is also provided flexibility, expandability, and commonality/interoperability for multimedia broadcasting. The system is rugged because it uses orthogonal frequency-division multiplexing (OFDM) modulation, two-dimensional (time-domain and frequency-domain) interleaving, and concatenated error-correction codes.

The ISDB-T system uses OFDM modulation associated with band segmentation which is called band-segmented transmission OFDM (BST-OFDM). The ISDB-T system consists of 13 OFDM segments. Each segment has a bandwidth $B/14$ MHz (B means the bandwidth of a terrestrial TV channel: 6, 7 or 8 MHz depending the region), so one segment occupies bandwidth $6/14$ MHz (428.57 kHz), $7/14$ MHz (500 kHz) or $8/14$ MHz (571.29 kHz). The system has a wide variety of transmission parameters for choosing the carrier modulation scheme, coding rate of the inner error-correcting code, length of time interleaving, etc. Each segment is assigned to a layer, for which a set of transmission parameters can be selected individually.

The system supports hierarchical transmission of up to three layers (Layers A, B, and C). The transmission parameters can be changed in each of these layers. In particular, the centre segment of this hierarchical transmission can be received by handheld receivers (called “One-Seg”). Owing to the common structure of each OFDM segment, a one-segment receiver can “partially” receive a program transmitted on the centre segment of an ISDB-T signal (partial reception is the name given to the means by which a receiver picks out only part of the transmission bandwidth). The system has three transmission modes (Modes 1, 2, and 3) having different carrier intervals in order to deal with a variety of conditions such as the variable guard-interval length as determined by the network configuration and the Doppler shift occurring in mobile reception.

The system uses MPEG-2 Video coding and MPEG-2 advanced audio coding (AAC). Moreover, it adopts MPEG-2 Systems for encapsulating data streams. Therefore various forms of digital content, such as sound, text, still pictures, and other data, can be transmitted simultaneously. It has commonality and interoperability with other systems using MPEG-2 Systems, such as ISDB-S, ISDB-C, and ISDB-T_{SB}.

More detailed information on ISDB-T can be found in Part 2, § 1.8.

2.6.2.6 T-DMB

For mobile multimedia broadcasting services, the Republic of Korea developed a video standard, terrestrial digital multimedia broadcasting (T-DMB), which is fully backward compatible with T-DAB. T-DMB is designed to provide video services for users in mobile environment with the backward compatibility with Digital Sound Broadcasting (DSB) System A. The MPEG-4 AVC is known to have compression efficiency as high as up to twice that of MPEG-4 Part 2 Visual (ISO/IEC 14496-2). The MPEG-4 BSAC is known to have the same compression efficiency as MPEG-4 AAC (Advanced Audio Coding) and is characterized by its additional functionality of fine grain scalability. The Binary Format for Scene (BIFS) provides a flexible composition capability for various multimedia objects in conjunction with MPEG-4 Synchronization Layer (SL) that enables smooth rendering of different types of multimedia objects for interactive services. For audio services, DSB System A in Recommendation ITU-R BS.1114 uses MUSICAM, however T-DMB system does MPEG-4 BSAC or MPEG-4 AAC as well as MUSICAM to provide enriched service supplemented by still pictures and texts.

More detailed information is given the Report ITU-R BT.2049 and in § 1.9.1, Part 2.

2.6.2.7 Forward link only

Forward link only (FLO) is a mobile digital broadcasting technology designed to provide mobile reception of broadcast multimedia content on handsets to address the physical limitations of the handheld terminal, including power consumption, memory, mobility, and form-factor constraints. Service elements of FLO include reception of real-time broadcast video and audio streams; access to multimedia services, and wide area and localized content in the same carrier. FLO system is designed to support access control, subscription management, and interactive services via IP.

2.6.2.8 ISDB-T_{SB}

ISDB-T_{SB} system is known as Multimedia System “F” of Recommendation ITU-R BT.1833, is designed to provide video, high-quality audio and data services which can be configured flexibly. In addition, support of script interpreter for rich content format provides content and service flexibility in multimedia broadcasting for handheld receivers.

More detailed information is given in § 2.5.1.3.

2.7 Summary

TABLE 2

Standard	Channels	Band	Modulation	Applicable standards
ATSC	6 MHz	UHF/VHF	8-VSB	A/52,A/53, A/65, A/153
DTMB	6,7 and 8 MHz	UHF/VHF	Single carrier (QAM)/OFDM	GB 20600-2006
DVB-T	6, 7 and 8 MHz	UHF/VHF	OFDM	EN 300 744
DVB-H	5, 6, 7 and 8 MHz	UHF/VHF	OFDM	EN 302 304
ISDB-T	6, 7 and 8 MHz	UHF/VHF	Segmented OFDM	ARIB STD-B31
T-DMB	1.75 MHz	VHF/1.5 GHz	OFDM	ETSI TS 102 427 and ETSI TS 102 428
FLO	5, 6, 7 and 8 MHz	UHF/VHF	OFDM	TIA 1099
ISDB-T _{SB}	0.43, 0.50, 0.57 MHz 1.29, 1.50, 1.71 MHz	UHF/VHF	Segmented OFDM	ARIB STD-B29

2.8 Evaluation of potential digital sound and TV broadcasting systems

In recent times, several digital broadcasting systems have been proposed in different areas of the world.

All of the currently implemented systems are based on the availability of a high efficiency encoding system with the capability to compress the bit rate needed to transmit digital contents to values compatible with the characteristics of the available on-air channels.

For TV broadcasting, the MPEG standard is currently almost globally adopted in its various levels, even though newer and possibly even more efficient encoding standards have been recently proposed.

The different currently available digital transmission systems have been proposed in different times, and the newer ones are supposed to benefit from the analysis of advantages and disadvantages of the previously proposed ones.

In the search for a real “killer application” for digital broadcasting, of the utmost importance is the capability of the digital standard to adapt to possible advanced broadcasting services. Concerning digital TV broadcasting, this includes interactivity, datacasting, portable and mobile reception.

2.8.1 Evaluation of specific terrestrial digital sound and TV broadcasting

The available standards for digital TV and sound broadcasting can be roughly divided in two groups:

- Single carrier codes (like 8-VSB, used in the United States of America standard ATSC-DTT)

The 8-VSB system is based on coding the digital information to be transmitted using amplitude only (8 levels). The modulated signal is then processed through a Nyquist filter, in order to reduce the transmission bandwidth.

- Multicarrier (various evolutions of COFDM, on which DVB-T and DAB – adopted in Europe and in Countries involved in the RCC-06-, ISDB-T – adopted in Japan-, and other codes are based.

The COFDM approach is based on splitting the data between a high number of carriers within the operating channel. The digital information associated to each carrier can then be coded using amplitude and phase (e.g. QPSK, 16-QAM, 64-QAM). Together, the digital data simultaneously transmitted and associated to the different carriers constitute an OFDM symbol.

COFDM-based codes allow the transmission through the physical channel of a multiplex, consisting of several contents that can then be selected and extracted by the receiver.

Moreover, the signal spreading over many carriers distributed over the whole channel width, together with the error-recovery systems introduced to safeguard the data integrity, make it possible to consider COFDM-based systems, like DVB-T, also for the implementation of SFN networks, in which the same frequency is used for the transmission over adjacent coverage areas and the implied fading due to co-channel interference between signals originated by transmitters operating on the same frequency is recovered due to the COFDM system characteristics. Commercial SFN networks (in DVB-T) have been rolled out for instance in Australia and in Spain.

The same high immunity to interferences makes COFDM digital broadcasting systems also suitable for mobile reception. Especially suited to this purpose is the recently issued standards for handheld receptions listed under Recommendation ITU-R BT.1833. In this case, special attention has been paid to preserving battery life, error correction mechanism, etc. in order to enhance the system's robustness.

The ATSC has developed the ATSC-M/H system which allows broadcasters to use their existing DTV channel to provide service to mobile and handheld devices while maintaining backwards compatibility with the large population of DTV receivers.

For more details, see Part 2, Chapter 1.

2.8.2 Hybrid systems

Some satellite systems use the terrestrial component to improve the quality of service: XM radio, Sirius. More information is available for Digital System E in the Recommendations ITU-R BO.1130 and ITU-R BS.1547. Other systems may use similar approach.

Chapter 3

to Part 1

3 Application and implementation of digital broadcasting

Traditionally, broadcasting and telecommunications have been treated as separate, vertical markets. Digital convergence, which means the same digital content can be transported over any of those networks, has a potential to create new horizontal markets within each level of the value chain such as content, service provision, network operation and terminals thereby opening up an abundance of new business opportunities. For the first time, people would be able to access any multimedia services from any type of delivery platforms such as fixed, portable and mobile with reasonable costs.

Switchover, i.e. the transition, from analogue to digital broadcasting is a complex process with social and economic implications going well beyond the pure technical migration. Digital broadcasting development is positive as it improves both the range and quality of services, notably thanks to digital compression. This improves both spectrum efficiency and network payloads.

Sound and Digital TV switchover should be an inclusive process encompassing various networks, business models and services, including free to-air TV, better picture quality or data and interactive services. Analogue switch-off should only take place when digital broadcasting has achieved almost universal penetration, taking all the above possibilities into account, to minimize social cost. Policy intervention should take place at national level in the first instance, considering market and policy differences between Member States in the area of broadcasting. However, the ITU has also a role to play, in particular in view of the internal market aspects. Possible ITU contributions concern notably: benchmarking, equipment standards, consumer information, facilitating and promoting access to added value services.

The industry is in the process of developing technologies that will make digital convergence a reality. Digital convergence allows content and service providers to deliver their offers through multiple delivery mechanisms. Correspondingly, consumers can access services via various terminals delivering multimedia content and more services via a single terminal. This blurs the borderlines between the traditional broadcasting and electronic communication sectors and consequently has a profound effect in the future of media distribution. Consequently, regulatory provisions must be carefully elaborated to reflect those changes.

3.1 Regulatory considerations

Regulation should allow multimedia service provision through all types of delivery networks, and regulations should ensure that a level playing field exists for all actors in the new horizontal markets and should correct imperfections of the market. To facilitate this process, the existing political and regulatory structures need to be adapted.

It is also important that spectrum policy (which includes and takes into account items such as allocations, assignments, and liberalization) provide access for all contenders in a harmonized, open, transparent and non-discriminatory way, and the means for sufficient and appropriate delivery capacity. In order to facilitate the development of global service and delivery, as well as interoperability and economies of scale in the production of equipment, a globally harmonized spectrum usage should be encouraged, without preventing, at the same time, the flexibility needed for the creation of a competitive and technologically advanced scenario through spectrum management and licensing. In addition, the spectrum usage should also allow for regional

differences in the amount of spectrum required for content delivery and for interactive services, since customer demand and interest may differ between regions.

Both telecommunications and broadcast networks have until now evolved under separate, vertically oriented standards and regulations. Broadcasting has been for radio and TV, and telecommunication has been for voice. Recently also data communications has evolved under its own IT-labelled umbrella. With digitization the borderlines between telecommunication, TV and radio services and data communication are disappearing. As a result, it will become increasingly difficult to define or categorize future delivery structures by the type of services that are delivered through them. Accordingly, new definitions will be needed in relation to regulatory aspects.

The new regulatory environment should also allow multimedia service provision through all types of delivery networks (broadcasting and mobile). In fact, network usage expands and becomes more flexible when it is not bound to the transmission of certain kinds of content. The expansion of usage will increase the desire to invest in the building of networks, and their technological improvement.

3.2 Efficient usage of broadcasting spectrum

The migration from analogue to digital broadcasting has already commenced in some countries and is expected to continue throughout the world for the next few years. The actual duration of parallel analogue and digital broadcasting, i.e. the date when the analogue transmissions will end, will vary from country to country (2010 has been stated as an objective for a number of European countries concerning digital TV).

There are a number of elements to this transition:

- the switch on of digital TV;
- the switch off of analogue TV;
- how to deal with the reuse of analogue TV spectrum (“refarming”).

This development will bring about significant new capacity for new services, as digital content can be broadcast in a fraction of the radio bandwidth that would be required for the equivalent transmission in analogue mode. Consequently, a much larger offering of digital TV programming is technically feasible while using less of the available radio spectrum. Furthermore, new types of digital services and content can be offered through this digital broadcast spectrum, both during the introduction of the digital technology is introduced but even more so also once analogue broadcasting has ceased – even while significantly increasing the quantity of broadcast TV (video) programming. Thus there is a significant opportunity for both additional TV and radio broadcasting, as well as for other interactive services in the fixed, portable and mobile environments, for example IP datacasting and interactive services.

The full benefits of the all-digital future will only be realized once analogue switch-off has been completed. The key issue will be to ensure the availability of many different services by many different service providers, as well as to guarantee openness and neutrality, which will pave the road for innovative services, technological innovation and vigorous competition to the benefit of the consumer and the entire economy.

3.3 Requirements of sound and television broadcasting services

3.3.1 Network aspects

The advantage of digital terrestrial broadcasting in terms of portability, mobility, integrated receivers and set-top reception fully justify the maximization of terrestrial coverage. In many countries most households receive analogue broadcasting by terrestrial means. For those households

who only want digital free-to-air services there will be a strong expectation of receiving these services by terrestrial means. The existing terrestrial analogue network infrastructure can be fully utilized for this.

The concept of single frequency networks (SFNs) is efficient in saving the spectrum required to offer service to a limited geographical area.

However, for DVB-T, by having both 2K and 8K modes as well as several guard intervals, the system can offer efficient tools for planning SFNs for various purposes including mobile reception. As is widely known in the broadcasting world, by also using gap fillers or repeaters, transmitters can easily enhance reception with full compatibility with respect to future upgrades, and portable and mobile reception possibilities will be better. This means that network extensions and modification for mobile or portable reception can be implemented at reasonable costs.

Users are moving rapidly towards a mobile lifestyle. 2G, 3G and future technologies have taught us to use mobile cellular technology in our everyday communication. By receiving mobile broadcasting datacast services over DVB-T/H in conjunction with 2G/3G as a return channel, consumers will be able to receive new kinds of content services and have increased interactivity. Joint utilization of DVB-T/H and cellular network technologies will provide consumers with location-independent and personalized services.

3.3.2 Receiver aspects

There will likely be four main types of receiver:

- 1 Fixed digital TV and set-top boxes for fixed reception using either roof-top antennas or fixed indoor antennas.
- 2 Portable TV or radio sets.
- 3 Car-installed terminals and mobile hand-held terminals, possibly integrating with 2G/3G cellular functions.
- 4 Mobile/portable broadband wireless systems.

Types 3 and 4, i.e. hand-held and portable terminals, will be battery operated and must focus on low power consumption. Therefore extra care has to be taken to make the radio environment such that this would be possible, and also user-friendly and convenient from the terminal and RF viewpoints. In particular, as regards TV one of the major concerns with the current environment is the placement of digital channels all over the UHF spectrum so that high-power analogue channels are adjacent to digital ones. This sets up very high linearity requirements from the terminal's RF components, and thus consumes excessive power. Having a unified part of the spectrum reserved only for portable/mobile digital data broadcasting and broadband wireless would help to ease the situation considerably.

3.4 Aspects related to the interoperability of systems

Regarding more sophisticated functionalities such as Application Program Interfaces (API), interoperable and open solutions for interactive TV services must be encouraged. The Member States will decide whether it is necessary to mandate certain standards to improve interoperability and freedom of choice for users. Indeed, these two criteria will likely contribute to consumer uptake of digital broadcasting in a market-led switchover scenario, thus minimizing the need for public intervention.

The interoperability of systems is facilitated by the introduction of new technologies and convergence of services.

For more information, see Part 2.

3.5 Components of digital sound broadcasting equipment

3.5.1 Transmitters

Non-linear sound transmitters cannot be modified and re-used for digital systems. For this reason all transmitters of this type will have to be replaced during the transition period. Depending on the switch-off period, some transmitters capable of simulcasting the emissions may have to be installed. From the point of view of Broadcasters the economic problems become relevant.

Newly built transmitters for the LF, MF, and HF bands are ready for digital operation.

3.5.2 Antennas for transmission

During the transition period, broadband antennas for use in the MF, HF, VHF frequency bands do not present any difficulty from the technical/economical point of view because technological intervention are not required.

Narrow-band antennas for use in the MF HF, VHF frequency bands produce relevant attenuation and phase rotation on digital carriers with a consequential reduction in quality. In this case relevant technical/economical intervention are required depending of power applied to antenna and type of system used.

For LF emission the real problem is the bandwidth of the antenna together with the associated economical and technical issues.

3.5.3 Receivers

The user is expecting an affordable and easy-to-use terminal, capable of receiving both digital and analogue sound broadcasting services.

The first consumer digital terminals were available in the marketplace from the end of 2003.

With regard to the digital market, for example in Italy there is interest in terminals which operate in VHF and a portion of L-band (1 452 to 1 492 MHz).

It is expected that the majority of effort for industry in the near future will be concentrated on portable and mobile/handheld receivers, provided that the necessary frequency spectrum will be available.

Also, it has to be taken into account that this kind of terminal needs integrated networks and service platforms while, historically, they have evolved independently.

In fact, in particular, it has to be noted that:

- Telecom networks focus on wireless and wired interactive communications between individuals.
- Broadcast networks deliver one-way programmes to mass consumer audiences.

Data networks meet the ever-increasing demands of internet traffic and file download for business and domestic users.

During transition from analogue to digital systems, broadband antennas for reception in LF, MF HF, VHF, UHF frequency bands do not present any difficulty from the technical/economical point of view because technological intervention are not required.

Narrow-band antennas for reception in LF, MF HF, VHF, UHF frequency bands produce relevant attenuation and phase rotation on digital carriers with a consequential reduction in quality.

3.6 Components of digital television broadcasting equipment

As far as TV broadcasting is concerned, the digital TV standards can be considered to be finalized. Now the interoperability between different makes of transmission system components and the compatibility of the transmission systems with the available makes of set-top boxes (STB) on the market has to be checked in detail.

3.6.1 Transmitters

In addition to replacing the existing analogue modulator with a suitable digital modulator in order to convert analogue equipment to digital, the following points have to be considered with the utmost care:

- Capability of the system to operate in “common amplification”, i.e. amplifying the whole signal, and not its separate carriers (e.g. audio and video carriers).
- Linearity of the system, with low intermodulation, that in digital is expressed by the shoulder level.
- Stability and phase noise produced by the reference frequency sources.
- Capability of the system control logic to interface the new components requested to convert the system to digital (i.e. the digital modulator).

In recent times, a large proportion of manufactured analogue equipment (most of all for TV applications in VHF and UHF frequency bands) feature a so-called “digital ready” conditioning that improves its suitability to be converted to digital. Anyway, the actual feasibility of this operation and the implied costs has to be specifically checked on a case-by-case basis.

3.6.2 Antennas for transmission

VHF and UHF antenna systems in use for TV broadcasting are generally well suited to operate additionally with digital signals on the same channel. In this case, no further critical issues are expected in terms of RF bandwidth, as the channel width is the same as used for analogue broadcasting. Antenna re-tuning could be needed in case the operational channel in digital is different from the one previously used in analogue, or when a new digital channel is added to the existing analogue channels of operation, without replacing any of them. Even though a large number of antenna components feature wideband characteristics, a change of operating frequency within the same frequency band (VHF or UHF IV or UHF V) implies a need to check the antenna tuning. In many cases, possible incompatibility problems could be solved by tuning the input characteristics, that could be generally obtained using specific tuning devices, and checking the phasing of the feed lines. In other cases, a new antenna design is required to comply with the new operational condition.

As far as DAB services are concerned, these are transmitted at completely different frequencies (VHF and L band) and therefore completely new antennas are required. At the VHF band, as the operation channel bandwidth is narrower than that used for TV, antenna systems designed for TV broadcasting at VHF seem also to be suitable for DAB broadcasting at the same frequency.

3.6.3 Receivers

Old TV analogue receivers can be maintained with the addition of set-top-boxes compliant with the standard used. Consequently the TV transition can be changed progressively.

Integrated digital TV sets are available on the market for various standards.

3.6.3.1 Distribution network

In the case of community reception a new distribution network may be required.

3.6.3.2 Antennas for reception

Modification to the antenna is not normally required. However, in certain cases, depending on the planning criteria applied and service area obtained, a modification may be necessary.

3.7 Data broadcasting

This involves the delivery of multimedia content direct to a computer or other digital devices. This is affected by installing a specific data card into the receiving device and converting it into a format that can be utilized by the computer or other digital devices. The use of Internet and the adoption of Internet protocol has revolutionized the commercial market of multimedia broadcasting worldwide. There are a number of standards being developed across Europe, the United States and Japan for multimedia broadcasting and standardization has also been ongoing in ITU.

Citing the benefits of digital broadcasting technologies it is clear that migration from analogue to digital will be universal over time. The pivotal factors for the success of the technologies are the availability of higher bandwidth, cheaper receivers, frequency spectrum for efficient global usage and interoperability issues with the existing analogue networks.

Before migrating from analogue to digital broadcasting, it is always essential to identify the market. The market and consumers look for usability and quality in technology and services. However, it is proved that both digital radio and TV have a range of benefits compared with their analogue counterparts. They are:

- Better images and sound.
- Attractive new programmes.
- Portability.
- Interactivity.
- New services.
- Lower radiated power of the transmitters.

These factors strengthen the viability of the future digital market. The digital technologies provide opportunities for new advanced services, as now has been proved by the Internet enabled ventures (e-businesses) and many companies are emerging which will satisfy the varying and sophisticated needs of consumers. The players must also be customer focused and always ready to serve the customers and users of the technologies.

The relevant problems are related to multiplexing, data bit rate, the video bit rate and the audio bit rate with consequent different choice or usage of algorithms, software and compressions. The above problems may be influenced also by the type of propagation (e.g. ionospheric propagation).

3.8 Broadcasting services for mobile reception

There are multimedia systems for mobile reception by handheld receivers developed within SG 6 as described in Annexes of Recommendation ITU-R BT.1833 – Broadcasting of multimedia and data applications for mobile reception by handheld receivers.

For more information, see also Part 2, Chapter 2.

3.9 Interference aspects

3.9.1 Interference free reception in the mobile environment

Having experienced the quality of service (QoS) of stationary (analogue) terrestrial broadcasting for many years, future users of mobile broadcasting services will not only demand a higher level of QoS (clearer TV pictures, higher sound quality) but also demand that this is sustained in the mobile environment where multipath-reflections and Doppler-shifts introduce substantial BER in the broadcasted data stream.

Here it is important to note that these systems will not only be used to receive broadcast content in the traditional sense, but also be capable of offering error free downloads of purchased source code and even executable code, which of course has to reach the target clients uncorrupted.

The practical implementation of mitigating such interference is not trivial, but has already found different solutions in some of the new standards/specifications emerging.

3.9.2 Impact of interference in end user environment

The audio or video receivers are normally affected by local interference created by manmade noise and/or by other services. The system efficiencies can be improved when the cause of the interference has been mitigated.

The PC, the mobile telephone and/or domestic equipment (electric razor, microwave oven, etc.) are the principal equipment producing greater interference to fix or portable audio and video receivers.

The interference impact of Power Line Transmission (PLT) is under study in radiocommunication SG 6. To mitigate this impact each Administration has to consider the possibility to define and apply appropriate protection values.

Chapter 4

to Part 1

4 Transition issues

In general, spectrum, technology, legal requirements and obligations on digital broadcasting services drive the implementation of digital broadcasting.

4.1 Spectrum availability

4.1.1 Considerations for the digital broadcasting

4.1.1.1 Technological convergence

With the introduction of digital techniques and technologies in digital broadcasting the difference between digital broadcasting, computing and other telecommunications systems seems to become smaller and smaller. Therefore technological convergence of these applications becomes possible.

Different technologies offer different opportunities for different types of services, like sound, television, additional data etc.

As digital services in principle offer both improved quality and/or more programmes in the same frequency bandwidth, the broadcaster has the possibility to offer new attractive services in addition to broadcasting.

On the other hand technologies in mobile telephony services can offer services similar to broadcasting, with limited quality but for portable reception.

4.1.1.2 Obligations

In some countries, obligations to transmit certain channels have been traditionally imposed on certain networks. Some broadcasters argue that extension of these obligations to digital networks will help switchover to digital technology as users expect to find the same service they already have in analogue. However, network operators express concerns about the proportion of these measures and the absence of appropriate compensation. In any event, the obligation can be clearly defined.

4.1.1.3 Copyright

As a general rule, transmission in digital as well as analogue (simulcast) of a copyright protected service results in additional copyright payments even though few or no additional viewers are involved. Such demands may be perceived as a disincentive to provide or extend digital services. Rights holders, including their representatives, should be encouraged to offer appropriate terms for the simultaneous transmission of analogue and digital through the same delivery mechanism where migration is the aim. Future copyright licences should also facilitate modifications or enrichment of services and data to improve accessibility for users with special needs.

Developments in digital broadcasting can also be constrained by the inability of citizens to legally obtain access to TV programmes other than those originating in the country where they reside. Although such access is technically possible, it is, in some instances, not authorized by Rights holders, given the territorial nature of copyright.

4.1.1.4 Diversity of digital broadcasting services

Digital broadcasting will attract different consumer segments if it is associated with a variety of services not available, or only partially available, in analogue, such as:

- fixed, portable and mobile reception;
- increased audio and picture quality, including wide-screen and high-definition television;
- data and interactive services, notably “Information Society services”;
- increased number of programs transmitted and therefore possibility for higher diversity of programs and possibility also of more regional and local programs.

Such digital service diversity is helpful for extending the appeal of digital TV beyond multi-channel and premium pay services. These have been the predominant digital TV services since the beginning of the market, but are usually not a driver where analogue multi-channel is available. Maximizing digital service diversity will help ensure differentiation from analogue and serve the needs of population segments and markets that are interested in other types of digital television services.

Public authorities can encourage the availability of added value content on TV networks in different ways.

First, ensuring government information is increasingly available. Much of this information is very valuable to citizens and is often cheaply available. It is possible to build on the work done on e-government and ensure the information is formatted to be displayed on TV in accessible formats. Action by Member States can provide critical mass and reduce costs thanks to economies of scale. This implies interoperable and horizontal solutions, as “platform-agnostic” as possible, to facilitate exchanges between administrations.

Secondly, various Member States initiatives in the areas of *e-content*, *e-government*, *e-learning*, *e-health*, can support public-private partnerships regarding the provision of added value content, government-related or not, on digital broadcasting networks.

Thirdly, service competition can be stimulated through the implementation of National and International regulatory provisions on third party access to electronic communication networks and facilities. Services concerned can include traditional broadcast programming but also interactive services, such as messaging services allowing for interaction between users, thus stimulating uptake through direct network effects.

Finally, wide-screen and high definition formats will stimulate the consumer take-up of digital television.

4.1.1.5 Spectrum management

Limited availability of terrestrial broadcasting spectrum is both an important justification and challenge for switchover.

The spectrum situation varies from one region to another. In areas where spectrum is over-crowded simulcasting is more challenging and there is greater pressure analogue services to be switched off early.

Spectrum management has traditionally been closely controlled by national governments. In addition, a high degree of international coordination of spectrum management takes place within the ITU. These international fora focus on two major issues:

- avoidance of cross-border interference;

- promoting the availability of communication services and equipment on a global and/or regional scale by fostering the harmonization of the frequency bands used for specific purposes.

In spectrum management it is necessary to distinguish “allocation”, “allotment” and “assignment” issues. See respectively Nos. 1.16, 1.17 and 1.18 of the RR.

Allocation refers to the types of services delivered over specific spectrum bands (terrestrial mobile, fixed satellite, radio astronomy or other), on which harmonization decisions are largely agreed at international level. Nevertheless, the distinction between different services may be increasingly challenged by market and technological developments, notably associated with digital convergence, calling for more flexible approaches to spectrum allocation. This issue affects, but actually goes well beyond, the switchover debate. Frequency assignment refers to granting of rights to use specific frequencies to a station.

The actual organization of switchover and the timing of analogue switch-off are important factors. In Region 1 and some countries in Region 3 the provision of analogue services in one country could constrain the use of the same frequency bands in another. This tension between the priorities of different national governments is particularly acute for broadcasting signals because of the long distances they typically travel, due to their high power and their use of low transmitting frequencies (VHF and UHF bands). So switchover progress in these countries, and all its attendant benefits, may be held up by slower migration in neighbour countries.

Technical discussions on coordination issues have been taking place for some years in the ITU. In particular, a two-session ITU Regional Radiocommunication Conference, covering the whole European Broadcasting Area, Africa and contiguous countries, was held place to review the current frequency coordination planning for terrestrial broadcasting (the “1961 Stockholm plan” and Geneva 89 and their subsequent updates), so as to facilitate the digital transition and prepare the post-switch off scenario. The first session was held in 2004 and the second session in 2006. These inter-governmental negotiations have a technical focus and decisions are not necessarily based on shared policy goals, with outcomes which may not be in line with market developments. The selection of coordination mechanisms according to specific technical criteria may also lead to the exclusion of other alternatives, possibly reducing market competition and consumer’s welfare.

In this context, it seems justified to develop policy orientations on spectrum management and switchover to achieve the goals of the internal market, addressing in particular the three aspects mentioned: assignment mechanisms; organization and time scales of the migration. This would help clarify the real stakes of the switchover, in particular who will benefit from it, when and how. That would provide certainty for all those involved, help establish their respective responsibilities.

4.1.2 General considerations on broadcasting planning

As explained before, there is a general trend for introduction of digital techniques to replace analogue broadcasting. However, because of the very large numbers of broadcasting receivers in use and the long life expected for such receivers, it is clear that a changeover from analogue to digital broadcasting will not take place very rapidly in all countries. Indeed, the changeover can be expected to take many years in most countries. It is therefore necessary to consider very carefully how the changeover can be managed to ensure the end result is successful. It is also necessary to consider very carefully the transition period between an all-analogue situation and an all-digital situation if harmful interference to broadcasting reception is to be avoided.

In the context of transition, it must be stressed that there are two separate phases to be considered. The first phase occurs when digital transmissions are introduced into broadcasting bands, which are already occupied, more or less completely, by analogue transmissions which remain in operation.

The second phase occurs when the analogue transmissions are switched off allowing the opportunity to introduce additional digital transmissions. Planning considerations during these two phases are likely to be very different but, at present, sufficient information is only available to allow detailed examination of different approaches for the first phase.

In preparation for the first session of Regional Radiocommunication Conference (RRC-04) the Task Group 6/8 produced an input document containing several planning scenarios.

The second session of the Regional Radiocommunication Conference (RRC-06) established digital terrestrial broadcasting DVB-T plan for television systems in Band III (VHF), Bands IV and V (UHF), and digital terrestrial sound broadcasting T-DAB plan in Band III (VHF) in Region 1 and certain Countries in Region 3, known as Geneva-06 Plan. This text can be accessed via internet at http://www.itu.int/ITU-R/conferences/rrc/rrc-06/plan_process/index.html.

4.2 Broadcasting planning principles

4.2.1 General considerations

The planning of terrestrial analogue broadcasting services during the Stockholm and Geneva Conferences was based on the concept of an “assignment” defined in No. 1.18 of the RR as:

“Authorization given by an administration for a radio station to use a radio frequency or radio frequency channel under specified conditions.”

In the context of producing a plan using an assignment planning approach, an assignment consists of a (single) transmitter site (specified in terms of longitude and latitude), with given effective radiated power (e.r.p.), effective antenna height, transmitter radiation pattern, etc. These parameters are chosen to ensure acceptable reception (or coverage) of an intended program in an area associated with, and usually surrounding, the transmitter location. However, the desired coverage of the assignment is not explicitly taken into account during the development of the plan and, in principle, cannot be determined until the plan had been finalized.

As more attention is now being placed on the need for a plan to achieve protection of a known coverage area and as digital techniques offer greater potential for planning approaches, the concept of assignment planning has come under close examination. This has evolved into a related but more flexible concept termed “allotment planning”. An allotment is defined in No. 1.17 of the RR as:

“Entry of a designated frequency channel in an agreed plan, adopted by a competent conference, for use by one or more administrations for a terrestrial or space radiocommunication service in one or more identified countries or geographical area and under specified conditions.”

However, in order to avoid difficulties with regard to the competence of administrations in territories other than their own, in the context of planning for terrestrial broadcasting services, this definition can be taken to mean:

“Entry of a designated frequency channel in an agreed plan, adopted by a competent conference, for use by an administration for a terrestrial broadcasting service within its own territory, or geographic areas within its territory, and under specific conditions.”

4.2.2 Coverage of an allotment area

Allotment planning may be used to ensure that the area which is intended to be protected against interference is taken into account during the development of a plan. The coverage of an allotment may be achieved by using:

- A single frequency network (SFN) consisting of a group of transmitters whose precise site locations and other technical characteristics are known at the time when the plan is made because the transmitter infrastructure has already been determined. In this case, the interference potential of the network can be represented by the set of assignments forming the SFN.
- A single transmitter with known characteristics at a pre-determined site. The interference potential is represented by the assignment.
- A single frequency network (SFN) consisting of a group of transmitters whose precise site locations and other technical characteristics have not been determined at the time when the plan is made. In this case, the interference potential of the network must be represented by means of a reference network.
- In the case where a small area is to be covered but where there have been no decisions regarding the choice of transmitter site or other characteristics, the interference potential may be represented by a single transmitter.

See Recommendation ITU-R SM.1050-1.

4.2.3 Allotment test points

Once the coverage area for an allotment has been decided, its boundary must be explicitly defined by means of test points. These test points will serve several purposes.

First of all, the allotment test points will define the geographical position, shape, and size of the allotment, that is, the “allotment boundary”:

- For this purpose, the test points are to be specified using, where appropriate, an agreed set of national boundaries and coastlines (as contained in the ITU IDWM), in terms of degrees, minutes, and seconds of longitude and latitude.
- An allotment area will be represented by the polygon (or polygons) defined by the specified test points (which will be the vertices of each polygon). Because only a limited number of test points can be usefully treated, the match between the polygon (or polygons) and the desired coverage may not be exact; therefore the choice of test points must be made carefully to demarcate the allotment area to a sufficient degree of accuracy.
- The test points for a given polygon should be ordered so that, when straight lines are drawn between consecutive points, a closed polygon is formed with no sides intersecting and containing the intended coverage area. This means that the coordinates of the first test point and the last test point in the sequence for the polygon must be identical (i.e. they represent the same physical point) so that the polygon “closes”.

Secondly, for calculations during planning in those cases where the interference potential of the allotment is represented by means of reference networks rather than by actual assignments, the test points will be used for the locations of the source of the interference that is associated with the allotment. In this way the interference potential of the allotment can be assessed.

Thirdly, for calculations during planning, the interference level due to other allotments or assignments will be calculated for the allotment test points. For this reason they should be “reasonably” spaced. This means that they should give a “good” approximation to the intended coverage area, the idea being that any potential interference within the polygon (i.e. the coverage area) will be no more than that occurring at the test points; too large a spacing may not assure this aim. On the other hand, too small a spacing may be “overkill” and only lead to superfluous calculations.

4.2.4 Digital sound broadcasting in HF bands

WRC-03 decided to encourage the introduction of Digital Radio Mondiale (DRM) by the broadcasting service in the HF bands on condition that the protection ratios are compliant with Resolution 543 (WRC-03).

There have been various discussions in the informal coordination groups and in the Broadcasting Unions on different approaches to implementing DRM transmission in the HF bands. At present, no method has provided any real benefit over the existing procedures in Article 12 of the RR.

Consequently, DRM transmissions are being introduced using the informal coordination procedure of Article 12. This gives broadcasters the greatest flexibility when planning DRM transmissions as they are free to select any new frequency using the existing and well known procedures. Any unexpected interference to existing analogue transmissions is then resolved using these informal coordination procedures. Furthermore, it allows broadcasters to change an existing analogue frequency to digital modulation for part of the transmission.

Other strategies may need to be considered in the future as the number of digital transmissions increases.

4.3 Quality of service

An important part of assuring the quality of any broadcast transmission comes from monitoring the transmitted signals within the target coverage area. In the case of analogue services, this has generally been accomplished by using a high quality receiver for signal reception. The signal strength is then read from a calibrated meter, whilst making a subjective assessment of the signal quality. Such an assessment has historically been made by someone in the target area tuning a receiver to the required service and then watching and/or listening to it in real time. More recently, this manual method has been supplemented by using unmanned remotely controlled or scheduled receivers to receive the signals and record the signal strength, together with a sample of the received signal. The move to using a digital transmission system enables the monitoring of reception to be completely automated.

4.4 Economical aspects of spectrum utilization

For more information it is necessary to take into account Report ITU-R SM.2012 – Economic aspects of spectrum management, and Resolution 9 of WTDC-06 – Joint Group between ITU-R and ITU-D for spectrum management.

See also Part 2.

4.5 Health, safety and other legal considerations

During any transition from Analogue to Digital broadcasting due care must be taken to ensure that transmission systems conform to all prevailing standards and recommendations concerning the limits of electromagnetic radiation hazards in force and the health and safety of staff and the general public.

Recommendation ITU-R BS.1698 contains the precautions to be taken into account. In Part 2 there is a summary of the important part of this Recommendation.

4.6 Switchover analogue to digital

4.6.1 Simulcast of analogue and digital services

4.6.1.1 Advantages and disadvantages of simulcast

There are several kinds of possible simulcast. In this report we consider only the following:

- Single channel simulcast: a single channel carrying both analogue and digital versions of the same content.
- Multichannel simulcast: The same content is broadcast in analogue and digital in two (possibly adjacent) channels. The concept of multichannel simulcast can be extended to using as an example MW bands for the analogue signal and HF for the digital content or the contrary.

One example of DRM simulcast is given in Part 2.

4.6.1.2 Advantages and disadvantages of single frequency networks

The main advantage is to use only one RF channel to deliver the same content all over a coverage area. The main weakness is that the content needs to be exactly the same and that local or regional services are not any more possible.

4.6.1.3 Spectrum availability

In some countries where there is congestion in the broadcasting bands the transition could be difficult. Solutions should be found by national administrations.

4.6.2 Possible mechanisms for the implementation of digital broadcasting

In the case of AM broadcasting in the HF, MF and LF bands all existing frequencies appear to be already occupied. It may be possible to use the same frequencies as used for analogue transmissions additionally for a digital one. However the interference caused to other stations, or caused by other stations to existing ones, should not exceed the values used in existing frequency plans. For the DRM system the value of -7 dB seems to be adequate on an interim basis.

The most important parameter in deciding when to change over to digital is the availability of receivers capable of decoding the digital signal. For this reason a transition period is needed, during which emissions will be transmitted in both analogue and digital techniques.

When the number of digital receivers will exceed say 95% of all receivers or all listeners, the analogue services can be discontinued.

For the introduction of T-DAB the situation is somewhat easier. For this type of digital sound broadcasting service some TV channels in Band III (mostly channel 12) and also channels in Band L (c/a 1.5 GHz) are foreseen in some countries.

During the transition period the analogue transmissions will remain in the FM band (in most European countries from 87.5 MHz to 108 MHz). After that period this band may also be used for digital transmissions.

A more difficult problem seems to be the digital terrestrial television. In a majority of West European countries all available television channels are used for analogue transmissions. In some countries there are some free channels in the band channel 61 to 69, because part of this band was used by other services.

Another possibility may be to use channels, which were restricted during analogue TV planning, so called planning constrains (in the United States of America called "TABO" channels).

However the strategy may be quite different from region to region of the planning area and even from country to country.

In general, when replacing the existing analogue transmission with digital for the same coverage area with the same quality of service, the radiated power will be lower.

4.6.3 Switchover overview

In the field of radio and television (jointly referred to as “broadcasting”), “switchover” refers to the migration process from analogue to digital broadcasting, starting with the introduction of digital and ending with the switch-off of analogue broadcasting. Many routes are possible in terms of the speed and length of the process, the parties involved, and the degree of government intervention.

Each country follows its own switchover path, often influenced by local broadcasting legacy.

Ideally, the final analogue switch-off should take place when digital broadcasting has achieved widespread penetration and very few analogue homes remain. Otherwise the impact would be socially regressive, if many homes were simply deprived of TV or radio services; or economically damaging, if expensive or distorting public policy measures were implemented to avoid such a negative outcome.

Switchover implies much more than a technical migration. Considering the role of TV and radio in modern societies, that impact is not only economic but also social and political. Switchover affects all segments in the broadcasting value-chain, namely: content production, transmission and reception. All require technical upgrading to support digital broadcasts. The main challenge is on the reception side: to replace or upgrade the huge installed base of analogue receivers. This can be done with integrated digital television or radio receivers, or “set-top-boxes” connected to the analogue TV set. Moreover, connection points (antennas, dishes, cabling) must often also be adapted.

The switchover cases for TV and radio are quite different. Digital TV market penetration is much greater. Analogue and digital TV are provided on various networks, mainly cable, satellite and terrestrial (over VHF and UHF frequency bands). Digital audio-visual content can be also supported by the internet and, still marginally, *Digital Subscriber Lines* (DSL) networks. Each network has specific strengths and weaknesses. So television switchover is a “multi-network” or “multi-platform” process and digital TV is not synonymous with digital terrestrial TV. However, the debate often focuses on terrestrial TV because of the potential recovery of spectrum currently used by analogue terrestrial TV, and traditional government involvement in this area.

Nor is digital TV equal to interactive TV. The former concerns the type of communication network and is the focus of the present document; the latter refers to specific services that can be provided over that network. In practice, the roll-out of networks and services are related. Finally, digital TV is not just pay-TV; free-to-air digital TV offerings also exist in some Member States.

As to the benefits of digital broadcasting, some are associated with the switchover process itself, others would be only achieved at the end, when analogue broadcasts have ceased. All benefits derive from the possibility of processing and compressing digital data, making much more efficient use of network capacity than is the case with analogue signals. This can be exploited in several ways. Firstly, it enables the offering of new or improved broadcasting services: additional programming; programme-related enhancements; better picture and audio quality; data and interactive services, including “Information Society” and internet-like services. Secondly, it provides increased market competition and innovation, thanks to the potential arrival of new entrants at different levels in the value-chain, for instance new broadcasters or developers of interactive applications.

In addition, switchover implies specific benefits for some categories of market players: reduction of transmission costs; opportunity for increased sales of digital receivers; easier storage and processing of content. In fact, the potential benefits and difficulties vary according to the stakeholders, as well as the local context and networks considered.

In any event, in the short-term, switchover involves significant costs and difficulties associated with the need to: introduce technical upgrades in all segments of the value chain and review spectrum mechanisms and approaches; develop attractive services to drive demand, without which the overall process could be financially and politically unsustainable; and overcome scepticism and even resistance from some industrial players and citizens, who may see risks in changing the status quo in the broadcasting sector.

Currently, the migration to digital broadcasting has been affected by the situation in the information and communications sector, characterized by limited capital availability. This removes part of the pressure to accelerate switchover in order to release spectrum. Moreover, market potential for interactive TV and convergent services is taking time to materialize and consumer willingness to pay for this remains uncertain.

In summary, progress is slower than anticipated and doubts are expressed about switch-off targets in certain countries. TV and radio broadcasts will be fully digital one day but it is difficult to know when and how. In some EU countries switchover could be a long process and its outcome is uncertain. For instance, the extent to which spectrum will be recovered and reallocated more efficiently will depend on political and market circumstances.

Appendix 1 to Part 1

Case studies

Overview of National case studies

This appendix presents an overview of the approach and current status of digital terrestrial television broadcasting (DTTB) in several countries.

Below there is a summary of action done by different countries.

More information is available in Part 2.

1 Australia

Australia is served by an extensive network of DVB-T digital transmitters covering approximately 600 geographic areas. Digital terrestrial television broadcasting transmitting sites operate in both VHF Band III and UHF Bands IV and V on a 7 MHz raster and predominately operate with the following transmission parameters: 8k carrier mode, 64-QAM, 2/3 or 3/4 FEC. Digital terrestrial television services commenced in major metropolitan regions on 1 January 2001 and have been progressively deployed in regional and some remote areas.

A feature of the Australian transmitter deployment is that a large percentage of the population receives signals from a small number of high power “main station” transmitters with typical coverage areas of up to 150 km. For digital services the radiated power levels of the main station

transmitters are up to 150 kW e.r.p. at VHF and up to 895 kW e.r.p. at UHF. In addition to high power main station services, repeater stations to cover deficient coverage areas are extensively used. They may be implemented using either a multi-frequency network (MFN) or a single frequency network (SFN) approach.

HDTV was a key feature of the introduction of digital terrestrial television in Australia and has been an important driver in the uptake of digital television. The Australian Government committed to ensuring that digital television would be as affordable as possible. Initially broadcasters were required to provide at least a minimum amount of high definition television programming for those who have HDTV sets, they were also required to provide their broadcasts in SDTV format. Transmission of SDTV format programming not only provided viewers with the ability to access the additional features of digital broadcasting, but it also gave viewers a cheaper conversion path for obtaining digital services.

The Australian Government has announced that 31 December 2013 will be the date by which the last analogue transmitter will be switched off.

2 Brazil

Beforehand, it's important to note that the country's channel planning is not DTTB standard-specific, since it contemplates the particularities of each existing DTTB standards. DTTB is to replace existing analogue TV by using UHF (channels 14 to 69) frequency bands. DTTB stations will have similar service areas as presently analogue stations do. Simulcasting of existent analogue channels and new digital ones is the approach applied during the transition phase.

In June 2006, the Brazilian government adopted, by the issue of Decree No. 5820, the ISDB-T digital television standard (Recommendation ITU-R BT.1306 System C) as a base for the terrestrial transmission. The video coding is the ITU-T Recommendation H.264 (MPEG-4/AVC) and the data coding is an innovative system harmonizing international Application Program Interfaces – APIs with local middleware development.

To make the transition to digital possible, up to December 2006, 1893 digital channels had been made available by the National Telecommunications Agency (Agência Nacional de Telecomunicações – Anatel). This work still continues and there will be more than 6 100 digital channels in Brazil until 2013. Considering that each analogue channel must have its digital correspondent, more than 12 200 channels, including analogue and digital, must be available during the “simulcast” period.

On December 2nd, 2007, the first official implementations of the Brazilian DTT system began commercial operations in the city of São Paulo and, in the 2nd semester of 2008, there were already 10 commercial broadcasters operating in the city. Although test transmissions were being held since May 2007, the Brazilian government established December 2nd as the official system launch date.

The Brazilian digital transmission system provides important features, such as high definition and standard resolution pictures, data delivery, interactive communication, portable and mobile services, with the required technical flexibility to better serve the viewers.

Brazilian Authorities consider that keeping the free and open TV model is essential to the DTTB success and to bring its benefits to the entire Brazilian society.

In 2007, more than 85% out of 56,45 million households in Brazil had TV sets that received only free, over-the-air TV service. This testifies to the importance of a free TV model to Brazil.

3 Bulgaria

Simulcasting between analogue and digital terrestrial TV broadcasting will be applied but not permitted for more than a year duration, except in remote rural areas.

Two phases of transition to digital TV terrestrial broadcasting will enable gradual transition to digital.

Six nation-wide DVB-T and DVB-H MFN/SFN networks-licensed operators must ensure full population coverage in all fifteen allotment zones: first three by December 2012, remaining three by June 2015.

Twenty seven regional SFN networks must ensure 90-95% population coverage in all fifteen allotment zones: first twelve SFNs by January 2010, remaining fifteen SFNs by December 2012.

License applications for digital terrestrial HDTV broadcasting shall be submitted by December 2011 and licenses may be granted shortly.

Interactive services and applications will be encouraged.

Switch-off of all analogue TV terrestrial transmissions will be completed by December 2012.

Transition to digital terrestrial TV Broadcasting shall be terminated by June 2015 and factual digital dividend be established.

4 Canada

Canada adopted the ATSC standard in 1997. The first commercial DTT station went on the air in Toronto in early 2003. Currently, there are about 2 dozen DTT stations across the country broadcasting in the major markets such as Toronto, Montreal, Vancouver and Ottawa. About 33% of the population of can receive at least on Canadian DTT station. The Canadian Radio-television and Telecommunications Commission (CRTC) mandated August 31, 2011 as the date to shut-down analog TV in Canada. As a result, most major television networks are actively planning their transition to digital to meet the CRTC deadline.

Test transmissions are being carried out by the Communications Research Center (CRC) using distributed transmission networks such as SFN – Single Frequency Network and digital on-channel repeaters (DOCR). The purpose of the tests is to identify the solutions that are needed to overcome coverage difficulties due to terrain and to explore possibilities in the area of pedestrian and mobile reception of DTT services.

5 China

China started research and development on digital television (DTV) broadcasting systems in 1994.

In 2004, the national special working group for Chinese digital television terrestrial broadcasting standard was established including members from several universities and research institutes. Prototypes, field trials and system demonstrations were conducted by this working group.

On 18 August 2006, the Chinese digital television terrestrial broadcasting standard, GB20600-2006, was officially ratified. The full name of this standard is “Framing structure, channel coding and modulation for digital television terrestrial broadcasting system” and the abbreviation is DTMB, standing for digital television terrestrial multimedia broadcasting.

The signal frame of DTMB system consists of a specially designed pseudo-noise (PN) sequence and an either orthogonal frequency division multiplexing (OFDM) modulated or single-carrier modulated frame body. PN sequence is inserted as the training sequence and guard interval, which could be used by receivers to achieve synchronization, channel estimation and equalization.

The system information is protected by using spread spectrum communication techniques to guarantee the reliability.

There are 5 different constellations used in DTMB standard, i.e. 64-QAM, 32-QAM, 16-QAM, 4-QAM and 4-QAM-NR (Nordstrom Robinson).

Concatenated code of BCH and LDPC is adopted as forward error correction coding. There are three coding rates in the system, i.e. 0.4, 0.6 and 0.8. The system frame head also has 3 options (420, 595 and 945). There are two different modulation modes, multi-carrier and single-carrier. The usage of these two carrier modes depends on the IFFT processing parameter, $C = 3\ 780$ or $C = 1$. To improve the performance under impulse interference, time-domain interleaving with two different depth and frequency-domain interleaving are supported.

Through the combinations of different parameters, the DTMB system can provide a bit rate from 4.813 Mbit/s to 32.486 Mbit/s and flexible services can be supported by the DTMB standard. The bandwidth of the DTMB system used in China is 8 MHz. Lab tests and field trials demonstrate that the DTMB standard can also work well for systems with bandwidths of 6 MHz and 7 MHz.

The DTMB standard can support high definition TV, standard definition TV, fixed/mobile, as well as indoor/outdoor reception. The system can also support the infrastructure of single-frequency networks.

On 31 December 2007, the Hong Kong Special Administrative Region of China became the first city to launch commercial DTMB service. In January of 2008, DTMB signals were broadcast in 8 cities, some of them hosting the 2008 [Olympic Games](#). In late 2008, the Macao Special Administrative Region of China also adopted the DTMB standard. The Chinese Government plans to provide national wide digital terrestrial television signal coverage before analogue TV is shut down. By the end of 2010, DTMB transmitters were deployed in more 310 cities of China.

6 Germany

DTTB was officially launched on 1 November 2002 and, by the end of 2008, all transmissions were completely digital, using the DVB-T standard. The business model is free-to-air broadcasting. The country's channel planning is based on the framework of the national frequency rights resulting from the ITU-R Geneva Agreement 2006 (GE-06), using predominantly the service concept "portable outdoor" (RPC-2 according to the Geneva Plan plus one or several assignments per city for high-power transmitter). This service concept generally enables indoor reception in the German agglomerations, which makes up one half of the total area, where typically more than twenty digital programmes are available in standard definition (SD) quality. Outside of these agglomerations, DVB-T can either be received as "portable outdoor" or by using directive antennae. With respect to HDTV, first test transmissions have taken place. Trials are also carried out concerning the transmission of sound radio programmes within a DVB-T multiplex.

There are various types of receivers on the market, ranging from USB dongles for PC and laptops over small portable TV sets for handheld and in-car reception (screen size typically between 5 and 7 inch of diameter) to set-top boxes and stand-alone TV sets for stationary reception (typically with flat-screen displays). In May 2008, the first mobile phones with integrated DVB-T receivers appeared on the market. In addition, car navigation systems are nowadays equipped with DVB-T receivers.

The switch-off started in Berlin-Brandenburg in August 2003. Already by the end of 2003, some six million people were able to receive 26 digital channels in SD quality in the city of Berlin and the federal member state of Brandenburg. This was the first switch-off of terrestrial analogue television worldwide. This success can be ascribed in part to the Government, which decreed that the service was to be totally free of charge, and which provided, only in 2003, free decoders to the poorest households. Under no other circumstances, the purchase of DVB-T receivers was subsidized. By the end of 2007, more than 85% of the German population (68 million people) could already receive digital terrestrial television. More than nine million receivers had been sold by that date. The success of DVB-T in Germany was due to the fact that the reception of a multitude of German-speaking programmes was available to the general public free-of-charge. In 2008, DVB-T is used by 16.8% of the households in Berlin – Brandenburg.

In other metropolitan areas, DVB-T transmissions started in 2004. One key element of the German approach was the implementation of the digital broadcasting service region by region, initially after an announced transition period of as little as six months and later on without any simulcast period. By the end of 2008, the switch-over will definitely have been completed (two years earlier than originally planned).

By the end of 2008, some 15 million DVB-T receivers are expected to have been sold since the launch of the service. Nevertheless, for their primary TV service in the households (large flat screen in the living room) approximately 90% of the Germans still rely on cable TV or satellite distribution.

7 Guinea

The advance of satellite broadcasting slows down the process of migration from analogue to digital broadcasting in terrestrial television. However, DTTB launching is under consideration. Two alternatives are examined, either to close down the analogue system and construct an entirely digital network, or to deploy a hybrid system (analogue and digital). The latter option would seem to be the most appropriate for developing countries. In respect to channel planning and platforms, the DVB-T standard is perceived as less costly and more advantageous to developing countries during the transition period. This will allow for more fruitful regional consultation, among adjoining countries, aimed at harmonizing the technical facilities to be used when introducing digital broadcasting equipment.

8 Italy

The switch-off of analogue broadcasting (analogue switch off (ASO)) was completed in July 2012. The adopted standard for digital terrestrial television broadcasting is mainly DVB-T. It also uses DVB-H and DVB-T2. In the reception availability model, free TV coexists with pay-per-view services.

Broadcasters have provided a wide range of MHP-based interactive services such as digital teletext, news information, weather forecasts, audience polling and EPG. Furthermore, the government (both central and local Administration) is providing experimental “t-government” services by using interactivity on TV set, with the aim to help bridge the digital divide.

The current percentage of the Italian population reached by digital terrestrial television signals is around 99% of the population. The division of the Italian population in respect to the three different platforms primarily used for receiving television is as follows:

- The percentage of users who receive television primarily by terrestrial means is around 83% of the population.

- The percentage of user who receive television primarily by satellite means is around 17%.
- IPTV users are under 1% of the population.

With regard to the satellite platform, a free to view satellite service called “Tivù Sat” was launched in July 2009 as result of a joint venture of the main Italian terrestrial broadcasters (Rai, Mediaset, Telecom Italia Media and two associations of local/private broadcasters – Aeranti Corallo and FRT). This platform, available from Eutelsat Hotbird 13°, offers its viewers access to all the free-to-air programmes already available on the DTT platform.

8.1 Spectrum policy

8.1.1 Italian Plan for DTT and the “internal digital dividend”

The Italian Plan defined in 2010, identified the channels in the VHF and UHF bands for 25 DTT national networks (21 DVB-T + 4 DVB-H) with a coverage of at least 80% of the national population and an extensive use of SFN techniques.

Six networks (5 DVB-T + 1 DVB-H) out of the above-mentioned 25 national DTT networks were made available as “internal digital dividend” to facilitate the entry of newcomers within the Italian media market. In fact, due to an infringement procedure moved by the EU against Italy, whose media market was accused to be too closed to newcomers, in July 2011, the Ministry for Economic Development published the rules for the handing over of 5 groups of frequencies to be allocated to DVB-T Multiplexes, plus 1 frequency to be allocated to a DVB-H (or DVB-T2) Multiplex after an evaluation of the possible candidates (or “Beauty Contest”). These “5+1” groups of frequencies are the so called “internal digital dividend” result of the transition from analogue to digital television and to be used for broadcasting service. In January 2012, the new Minister of Economic Development has decided to suspend the Beauty Contest for a period of three months for further in-depth considerations, in light of the outcomes of WRC-12. On 24th April 2012, a new law was approved in which it is announced that, by the end of 2012, the rules for acquiring the 5+1 groups of frequencies of the “internal digital dividend” will be defined: the government decided to assign such frequencies by allocating the licences through a bid up process.

8.1.2 The local/private broadcasters phenomenon

It is important to take into account that about 600 local broadcasters are operated over Italy in the “analogue era”, typically with a service target area of some adjacent provinces/regions. As a result of the Italian digitizing process, each “analogue” local broadcaster has become a “digital” network operator having been assigned a multiplex. Before the Switch-Off in some areas there was a preliminary selection (“graduatoria”) of the local regional/subregional operators and formal agreements among them (“intese”), in order to limit the total number of assignments.

However, also taking into account the complete release of the portion of the UHF band 790-862 MHz (by 31.12.2012), in Italy remain approximately 500 multiplexes broadcasted by about 500 different local regional/subregional network operators that produce, as a result, an average occupancy of spectrum equivalent to 18 national Muxes (without considering that frequencies from 790-862 MHz, allocated to mobile service in December 2010, are still in use for broadcasting in some Italian regions because assigned to local commercial broadcasters before December 2010 and shall be released by 31.12.2012 as a result of the 800 MHz auction (held in September 2011)).

8.1.3 Migration to DVB-T2 system

In early 2012, the Italian government announced that as of 2015, all DTT receivers must include a tuner with the DVB-T2 standard. This decision is a consequence of, at least, the following two reasons:

- at present, in DVB-T multiplexes there is not enough capacity to introduce new services or improve the technical quality of broadcasting contents (SD towards HD and beyond);
- following the outcome of the last WRC-12 to reduce the amount of spectrum to broadcasting service in favour of mobile services, new and more efficient modulation and transmission techniques will be necessary to satisfy the enhanced TV services (i.e. DVB-T2/HEVC) on DTT platform.

At the moment there is no plan for the transition from DVB-T standard towards the DVB-T2 standard. Note that:

- RAI has been performing a DVB-T2 trial in Aosta since July 2011; a bouquet composed of a mix of SD and HD channels is currently broadcasted. On one of the HD channels, 3DTV plano-stereoscopic services are also being broadcasted aiming to test the service compatible operation with 2D receivers;
- the commercial broadcaster Europa 7 broadcasts pay TV services (4 HD programmes) using the DVB-T2 standard since 2010 (on ch. 8 VHF). Europa 7 makes its DTT set-top box available to its subscribers.

8.1.4 Tables on multiplexes in use, contents and other details

In the following tables are summarized:

- Table 3: number of DTT multiplexes in VHF (174-223 MHz) and UHF (470-790 MHz) bands.
- Table 4: multiplex and program contents related to Italian National Broadcasters.
- Table 5: details on number of multiplexes in use, their technical specifications and percentage of population covered.

TABLE 3

Number of DTT multiplexes in VHF (174-223 MHz) and UHF (470-790 MHz) bands

Italian Multiplexes	Tot.	<i>DTT</i>	<i>DVB-T2</i>	<i>DVB-H</i>
Multiplexes assigned to NATIONAL broadcasters	19	<i>15</i>	<i>2</i>	<i>2</i>
“Internal Digital Dividend”	6	<i>5</i>	<i>1</i>	<i>0</i>
Multiplexes assigned to LOCAL broadcasters (average)	18	<i>18</i>	<i>0</i>	<i>0</i>
TOT.	43	<i>38</i>	<i>3</i>	<i>2</i>

TABLE 4

Multiplex and program contents related to Italian National Broadcasters

National operators	Multiplex				Contents			
	Tot.	<i>DTT</i>	<i>DVB-T2</i>	<i>DVB-H</i>	TV (SD)	<i>TV (HD)</i>	<i>Radio</i>	<i>Prog. DVB-H</i>
RAI	4+1	4	1		14+2	1	7	0
Mediaset	4+1	4		1	19	5	0	9
TIMB	3	3			21	0	1	0
Rete A	2	2			10	0	10	0
DFREE	1	1			9	0	0	0
H3g	1			1	0	0	0	7
Retecapri	1	1			7	0	1	0
Europa 7	1		1		0	4	0	0
TOT.	19	15	2	2	82	10	19	16

TABLE 5

Details on number of multiplexes in use, their technical specifications and percentage of population covered

Broadcasters	No of Muxes	System & modulation	FEC	GI	Reception mode	Capacity per multiplex (Mb/s)	Current percentage population coverage	Intended percentage population coverage	Content	Total capacity (Mbit/s)	Total spectrum bandwidth used or intended for implementation (MHz)	Notes(*)
RAI Public Service	1	DVB-T, 64-QAM SFN in UHF Band	3/4 or 5/6	1/4	Fixed	22.4 – 23.7	>99.0%	>99.0%	4 SD MPEG2 + 3 radio programs	83	(2x7 MHz channels) + 4x8 MHz channels = 46 MHz	Public service broadcaster multiplex with one different regional program for each region. Free to air
		DVB-T, 64-QAM MFN in VHF Band	3/4	1/32	Fixed							
	3	DVB-T, 64-QAM SFN in UHF Band	2/3	1/4	Fixed	19,9	>90.0%	>90.0%	12 SD MPEG2 + 1 HD MPEG4 + 5 radio programs	Not yet defined	1x7 MHz channel	Public service multiplexes Free to air
	1	DVB-T2 in VHF Band	2/3	1/128	Fixed	35,2	trial	>80.0%	[See Reply 8]	Not yet defined	1x7 MHz channel	Public service multiplex Free to air
Mediaset	1	DVB-T, 64 QAM	3/4	1/4	Fixed	22,4	> 95 %	> 95 %	6 SD	107,1	40	Free-to-air
	3	DVB-T, 64 QAM	5/6	1/4	Fixed	24,9	> 90 %	> 90 %	13 SD + 5 HD			1 Free + 2 Pay-Tv
	1	DVB-H, 16 QAM	1/2	1/4	Portable/mobile	10	> 90 %	> 90 %	9 Portable			
TIMB	3	DVB-T, 64 QAM	3/4	1/4	Fixed	22,4	> 90 %	> 90 %	21 SD + 1 radio	67,2	24	Free-to-air
Rete A	2	DVB-T, 64 QAM	3/4	1/4	Fixed	22,4	> 80 %	> 85 %	10 SD + 10 radio	44,8	16	Free-to-air
DFREE	1	DVB-T, 64 QAM	5/6	1/4	Fixed	24,9	> 90 %	> 90 %	9 SD	24,9	8	Pay-Tv
H3g	1	DVB-H, QPSK	1/2	1/8	Portable/mobile	6	> 80 %	> 85 %	7 Portable	6,0	8	
Retecapri	1	DVB-T, 64QAM	2/3	1/4	Fixed	19,9	> 80 %	> 85 %	7 SD + 1 radio	19,9	8	Free-to-air
Europa 7	1	DVB-T2, 256 QAM	n.a.	n.a.	Fixed	32	n.a.	n.a.	4 HD MPEG4	32,0	7	Pay-Tv
Regional-Local (average)	18	DVB-T, 64 QAM	3/4 typical	1/4 typical	Fixed	22.4 typical	> 80 %	> 85 %	typical: 120 SD + 10 HD + 10 radio	403,2	144	Mainly Free-to-air

(*) All Italian DTT licences will last until 2032.

8.2 Monitoring systems

Due to the transition of terrestrial television transmission from analogue to digital, it became necessary to improve and adapt the monitoring systems and the technical procedures, used by Companies to verify the signal quality at every stage of the chain. As known, in Italy, every broadcasting Company owns its broadcasting network: consequently every broadcasting Company had developed in the past years its peculiar monitoring system to evaluate the compliance of signal quality with the standards defined by ITU Recommendations and in the Monitoring Handbook.

For this purpose, Rai Radiotelevisione Italiana, in a collaborative effort by its internal departments, has developed a monitoring system known as “EVA” (signal quality evaluator), which provides results that are considered more than satisfactory.

Moreover RaiWay, a Company of the Rai Group in charge of network planning, implementation, extension and management, has developed a family of monitoring systems covering the whole chain from the signal coding to the user antennas: one of these systems is called “Rete Leggera”.

The monitoring networks mentioned above are described in Part 2, Appendix 1. They are just two of the several different monitoring networks implemented by RAI-RaiWay. The other networks have more specific tasks, e.g. surveillance for operational aims, such as transmitters remote control.

9 Japan

Terrestrial TV broadcasting is a fundamental medium in Japan with 52 million households. Terrestrial broadcasters have established many relay stations to provide maximum coverage throughout mountainous regions and the entire archipelago. In fact, there were more than 3,000 transmitter sites for analogue TV broadcasting. Assigning digital channels without migrating analogue channels was not possible due to the heavy use of UHF channels by analogue relay stations. As a result, many analogue TV channels were forced to shift to other UHF channels before assigning channels for digital TV broadcasting.

From the three major metropolitan areas of Tokyo, Nagoya, and Osaka, service coverage has been expanded nationwide since the start of digital terrestrial TV broadcasting (DTTB) in December 2003. As of December 2007, more than 90% of households were covered. Most of the relay stations were built by 2010 and digital migration was completed in July 2011. The number of households with digital receivers has been increasing on a gradual basis. According to government investigations, the percentage of households with digital receivers was 28% in 2007, 61% in 2009, and 95% in 2010. Over 120 million receivers had been shipped by May 2011.

Receivers for automobiles have been on the market since 2005 and 6.9 million automobile TV receivers had been shipped by May 2011.

The One-Seg service for handheld receivers using the central segment of the ISDB-T signal started in April 2006. Over 106.2 million mobile phones with One-Seg receivers had been shipped by May 2011.

10 Kenya

In Kenya, sound and television broadcasting is an activity of great public interest, and therefore, it is necessary that the broadcasting service is provided in an efficient and effective manner in order to benefit the people of Kenya. In this respect, following the conclusion of the ITU RRC-06 Conference, the government established the *Digital Broadcasting Taskforce* (the taskforce) on 14th March 2007 to provide advice on the development of a national strategy for the switchover of broadcasting systems from analogue to digital broadcasting.

The Taskforce made various recommendations including the need for the government in consultation with the country's ICT sector regulator Communications Commission of Kenya (CCK) to establish a Digital Television Committee (DTC) to manage the migration process within a specified timetable and develop an appropriate switchover strategy. The taskforce also recommended the simulcast period to end on 30 June 2012 and the analogue switch-off of analogue broadcasting to be effected on 1st July 2012.

The DTC set up in February 2008 focused on three areas namely digital broadcasting standards, signal distribution and consumer issues. "DigitalKenya" is the brand associated with digital migration process in Kenya. In June 2012, consumer awareness campaign under the slogan 'join the great digital migration' was unveiled using the print, radio/TV media and roadshows. Minimum requirements for set-top boxes (STB) based on DVB-T2/MPEG-4 video compression standards have already been issued and conditional access feature has been made optional for free to air (FTA). The CCK hosts the DTC secretariat, and also provides budget to meet expenses related to DTC and consumer awareness campaigns.

The CCK authorized the first trial terrestrial DVB-T network in Nairobi on channel 57 and the licensee began operations in April 2006. However, this network is no longer operational. The mobile TV digital network deployed on DVB-H platform was authorized in Nairobi on channel 21 and began operations in October 2007. The DVB-H network is still operational having expanded its coverage to other cities namely Mombasa, Kisumu, Eldoret and Nakuru.

The country's channel planning for digital terrestrial television broadcasting (DTTB) is based on DVB-T and MPEG-4 AVC. Sound broadcasting using T-DAB technology is envisaged in band III (174-230 MHz) while digital TV was planned in bands IV/V (470-806 MHz) but arising from the decision of WRC-12, re-planning is now being carried out covering only channels 21-48 (470-694 MHz).

On 9th December 2009, Kenya took a giant step towards setting the pace for migration from analogue to digital broadcasting when H.E the President of the Republic of Kenya launched the pilot digital signal in Nairobi officially paving way for existing analogue TV stations to be broadcast on DVB-T digital platform. One multiplex was activated on UHF channel 26 carrying a total of 16 standard definition TV channels and 4 radio services.

Rollout of digital TV in other parts of the country is expected to be implemented in phases until the entire country is covered. Phase 1 rollout ending by 31st December 2012 targets to cover 12 main towns and is expected to provide digital signal coverage to 70%-80% of the existing analogue coverage areas. In 2010, the DTC adopted DVB-T2, MPEG-4 standard and decided that going forward, further rollout of the digital terrestrial infrastructure in Kenya would be on DVB-T2 technology in order for the country to fully benefit from the spectrum efficiency gain and services flexibilities associated with DVB-T2. The DVB-T transmitter was switched off on 31 August 2012 and all terrestrial digital transmissions are on DVB-T2.

On 7th October 2011, the second broadcast signal distribution licence was awarded to Pan Africa Networks Group (K) Co. Ltd following a competitive tendering process. This licensee's first digital transmitter went on air in Nairobi in June 2012.

During the simulcast period expected to run until end of 2012, existing analogue channels shall be accommodated on the signal distributor's multiplex platform for free. The analogue switch-off date earlier set for 30th June 2012 at which time all analogue transmitters were expected to be switched off, was revised in view of the delayed network roll out. The government has decided to adopt phased switch-off starting with Nairobi whose switch-off date has been provisionally set at 31st December 2012.

Four main challenges are envisaged in the digital migration initiative:

- ensuring DVB-T2 compliant digital set-top boxes are readily available and at affordable prices to the general public;
- financing the roll out of the digital network infrastructure to ensure adequate coverage of the country with digital signal to meet the ambitious analogue switch-off date of 2012 for East Africa Region;
- generating appropriate content that is relevant to the Kenyan consumers to populate the envisaged immense capacity afforded on digital platform;
- the desire to ensure that all consumers, including the rural communities, access the digital TV content against the challenge of poor coverage of rural areas by the national electricity grid and the limitations of alternative solar power.

In June 2012, the Government announced the waiver of import duty (accounting for about 25%) on digital set-top boxes to make them more affordable. This was in line with the decision by the five East African Community (EAC) member states to zero rate import duty on digital broadcast terrestrial receivers.

As at the end of September 2012, the DVB-T2 signal was on air in seven sites namely Nairobi, Mombasa, Kisumu, Eldoret, Nakuru, Webuye and Nyeri carrying both free to air and pay TV channels.

11 Mexico

In Mexico, the broadcasting sound and television is an activity of public interest, and therefore, it is necessary for these services to be provided under the best technological conditions, in benefit of the population. For this reason in 1999 was established the Consultative Committee of Digital Technologies for Broadcasting (the Committee), in which the industry and the government consensually analyze and evaluate, the development and transition process implemented in other countries. In the year 2000, the Committee established the commitments with such agreements; experimental operations have been conducted with digital technology for radio and television.

In addition, the Committee participated in various meetings of Radiocommunication Study Group 6, which provided the necessary technical information to evaluate the development level of the digital standards analyzed at the ITU. Furthermore, the committee conducted meetings with digital TV technology developers to learn the strengths and weaknesses of each of the standards from the source, as well as any situation of concern in the transition process due to equipment availability and cost.

The Committee considered that it had the key elements to recommend the adoption of the *digital television terrestrial (DTT) standard and its transition policy*; the corresponding agreement was issued on July 2nd, 2004. The Agreement established: the adoption of Standard A/53 on the ATSC; the transition process with legal certainty for all parties involved; the objective conditions for process follow-up to evaluate the development, and the objectives, goals, requirements, conditions and obligations.

Due to the costs that the terrestrial digital television transition policy involves for concessionaries, licensees, producers, advertisers and TV viewers in general, this is a long-term process. For this reason the following elements were taken into account to establish a transition schedule: a flexible and gradual installation process for DTT stations; development periods within this process subject to review, and minimum goals based on population density.

At the April 11, 2006, the regulatory authority for broadcasting sound and television corresponds to the Federal Telecommunication Commission who has given special attention to the supervision and control of the DTT transition. At these date, 35 stations transmitting with digital technologies in 10 principals cities of the country.

12 Russian Federation

Five DVB-T transmitters are working at present time and one more will be launched in nearest future. All of them have experimental status and used for investigations of compatibility between DVB-T and analogue (SECAM-K) television broadcasting, but also proposed to be full-functional DVB-T services.

Transition from analogue to digital TV in the Russian Federation at the first stage assumes the replacement of an analogue signal into digital one with preservation of the existing standard of decomposition of a signal. Such signal can be reproduced not only by colour TV set, but also by black-and-white TV set having a special receiver box.

In Russia before the introduction of digital TV it is required to carry out an experimental broadcasting. In connection to this there were organized experimental broadcasting areas in Moscow – 32, 34 TVch; Saint-Petersburg – 34 TVch; Nizhniy Novgorod – 50 TVch; Vladivostok – 51 TVch; Chelyabinsk – 30 TVch.

The broadcasting is conducted in standard of DVB-T. Now researches of an opportunity of interactive reception on mobile television receivers with the liquid crystal display are conducted, the return channel is planned to realize through GSM network.

For the further introduction of digital TV broadcasting a planning of DVB-T frequency assignments, both in European Broadcasting Area and to the west from longitude 170°E is carried out. Now the majority of planned frequency assignments to DVB-T stations is coordinated with other Administrations, 37 frequency assignments are included in the Plan (Stockholm, 1961), 4 frequency assignments are included in MIFR.

Furthermore 24 frequency assignments to DVB-T stations are coordinated and in the near future will be included in the Plan (Stockholm – 61) and in Lists of existing and planned TV stations for the territories of extended planning area.

MHP-based interactive services are possible, but the penetration of telephone and telecommunication systems –that are not yet at a nationwide extent- is a critical element that shall be taken into deep consideration.

13 Tanzania

Tanzania falls under ITU Region1 with the Tanzania Communications Regulatory Authority (TCRA) (representing Tanzania at the ITU) the regulatory body of Communications, Broadcasting and Postal sectors. TCRA represented the country in RRC-04 and RRC-06 processes which yielded two public consultation documents followed by workshops, annual conferences and forums aimed at addressing how digital terrestrial broadcasting will be implemented, managed and regulated. The consultations yielded initial framework on the new broadcasting landscape in Tanzania which is introduction of signal distributors branded Multiplex Operators (MUX). It is proposed of two commercial Multiplex Operators and one Public Service Multiplex Operator under the initial licensing framework.

Among measures undertaken by TCRA is the introduction of the Converged Licensing Framework (CLF) with four (4) major licences:

- 1 Network Facility

- 2 Network Service
- 3 Content Service
- 4 Application Service

to address the complex licensing issues associated with convergence and digitization, formation of the National Technical Committee to handle migration and work out the roadmap to full digital broadcasting, formation of the interim Work Group on Digital Broadcasting (WGDB) within the Authority with experts from broadcasting, spectrum management, ICT development and legal sector to address the following issues: consider licensing issues of MUX, National Plan of Digital Broadcasting and simulcast period, licensing of other services such as, Mobile TV, IPTV, consider and adopt a positional paper on availability of STB and editing the final document on Digital Broadcasting.

In April, 2008, TCRA announced an Expression Of Interest (EOI) for prequalification for provision of digital multiplex services with a positive response. Processes to amend the Tanzania ICT Policy, 2003 and other applicable laws steered by the Government are smoothly ongoing. Channels are available for implementation of DTT country wide after initial Digital Plan and four phases are initially proposed to be updated soon.

14 United States of America

The United States has moved forward aggressively with the implementation of DTV using the ATSC Digital Television (DTV). At the request of the FCC, 28 stations in the ten largest cities volunteered to launch DTT service in November 1998, six months ahead of the deadline established by the FCC. Six months later (May 1999) all stations in the top 10 markets that were affiliated with the four largest broadcast networks were required to provide service, and in another six months (November 1999) this requirement was extended to the affiliates of the four largest networks in all of the 30 largest cities. All commercial broadcasters were required to be on the air by May 2002 and all non-commercial broadcasters by May 2003. In early 2006, legislation was enacted by the U.S. Congress requiring broadcasters to terminate their analog transmissions by February 17, 2009. This legislation included provision of up to US \$1.5 billion to subsidize the purchase by television viewers of digital-to-analog set-top converters that could be used to view DTT signals on existing analog television receivers. The FCC adopted regulations that phased in a requirement for inclusion of ATSC receiving capability starting with the largest TV sets first, in 2004, and for all sets over 13 inches by July 2007. In November 2005 the FCC amended its rules to advance the date for the completion of the phase-in period to March 1, 2007, and to apply the requirement to all receivers regardless of screen size. Thus, since March 1, 2007 every television set sold in the U.S. has contained a ATSC DTT reception and decoding capabilities. The U.S. Consumer Electronics Association predicts that 34 million ATSC DTT receivers per year will be sold in the U.S. alone by 2007, with a cumulative total of 152 million ATSC receivers by 2009. Broadcasters and manufacturers are now in the process of planning for the rollout of mobile and handheld services using the ATSC-M/H system.

15 Republic of Korea

The Republic of Korea started digital terrestrial television broadcasting in 2001, digital satellite broadcasting in 2002, and terrestrial multimedia broadcasting in 2005. Cable TV is also in service of digital programs since 2002.

15.1 Digital TV for fixed reception

The Republic of Korea adopted ATSC system in 1997 for digital transition of analogue television broadcasting in the UHF band to obtain high definition quality within 6 MHz raster and conducted field tests in 1999 and 2000. There are 160 ATSC transmitters currently installed around the country covering about 92% of territory as of 2006. It was not an easy job to find frequencies for digital television stations, because the UHF band is already occupied with analogue television broadcasting. In order to facilitate frequency assignments, Equalization Digital On-Channel Repeater and Distributed Translator are devised for ATSC system to use same frequencies.

15.2 T-DMB for mobile reception

For mobile multimedia broadcasting service, the Republic of Korea developed the Terrestrial Digital Multimedia Broadcasting (T-DMB). T-DMB pilot services were conducted in Band III in Seoul metropolitan area and its vicinity and field test results showed good mobile reception quality. Field test results were submitted to WP 6M meeting held in April 2004 and included in the Report ITU-R BT.2049 (see also Doc. 6E/186). In December 2005, the Republic of Korea launched commercial service of T-DMB in Seoul Metropolitan area and expanded to the nationwide services in March 2007.

16 Venezuela

DTTB is going to be introduced through a process assisted by the National Regulator, that is CONATEL – National Commission of Telecommunications. The process is split into different stages: feasibility study, forum and operating tables, trials and standard adoption. This process is under developments. Trials have been conducted and concluded. Specific channel planning is completed and ISDB-T standard was chosen.

17 OCDE

The major part of the OCDE document published in June 2003 with the following title: “The Implications of convergence for regulation of electronic communications” from the Committee for Information, Computer and Communications Policy, is dedicated to the place of broadcasting in electronic communications (Doc. DSTI/ICCP/TISP (2003)5).

18 European Union

Information regarding Digital video broadcasting spectrum issue in Europe (Finland, France, Spain, Sweden, and United Kingdom) can be found in the ITU-D Report regarding Question 11-1/2.

19 Rwanda

In Rwanda, sound and television broadcasting is an activity of great public interest, and therefore, it is necessary that the broadcasting service is provided in an efficient and effective manner in order to benefit the people of Rwanda. In this respect, following the conclusion of the Regional Radiocommunication Conference 2006 (RRC-06), the government of Rwanda established a digital broadcasting steering committee.

The purpose of the steering committee was to develop a national strategy for the switchover of broadcasting systems from analogue to digital broadcasting.

19.1 Implementation roadmap and strategy

In collaboration with the East African Community's Broadcasting Technical Task Force (BTTF), which is composed of Technical Staff from ICT regulators of East African Community (EAC) member states (Rwanda, Uganda, Tanzania, Burundi and Kenya) dealing with broadcasting issues, the Rwanda steering committee made various recommendations including the need for the government of Rwanda to produce a roadmap of transition from analogue to digital TV Broadcasting within a specified timetable, develop an appropriate switchover strategy and monitor its implementation. The steering committee recommended the simulcast period to end on 31 December 2013 and the switch-off of analogue broadcasting to be effective from 1st January 2014.

The BTTF focuses on developing the Set Top Box (STB) standards, signal distributor licensing framework and monitoring the implementation of the analogue to digital migration roadmap.

The Rwanda Utilities Regulatory Agency (RURA) decided to authorize two signal distributors including the public broadcaster Rwanda Broadcasting Agency; the second signal distributor will be selected through public tender process.

A large public awareness campaign will be launched in course of March 2013. The purpose of that campaign will be to sensitize the general public to migrate from analogue to digital TV broadcasting, to encourage rural population to have at least one TV set per family. Meanwhile the government decided to distribute community TVs and their STBs to a village level within the whole country.

To facilitate commercialization and acquisition of STBs the related minimum technical requirements have already been developed and published on RURA website.

The public Broadcaster Rwanda Broadcasting Agency (RBA) has already installed the necessary DVB-T infrastructure covering almost the same area as the analogue TV.

The country's channel planning for Digital Terrestrial Television Broadcasting (DTTB) is based on DVB-T2 and MPEG-4 AVC. Sound broadcasting using T-DAB technology is envisaged in Band III (174-230 MHz) while digital TV was planned in Bands IV/V (470-806 MHz). However, following the decision of WRC-2012, re-planning is now being carried out covering only channels 21-48 (470-694 MHz).

ITU recommended at least four DTT channels at each transmitter site but according to GE06, it was not possible to find those channels at all the selected fourteen main transmitter sites.

A series of DTT frequency coordination meetings organized by EACO (East African Communication Organization) came up with the solution for insufficient frequencies that the government of Rwanda was facing. Now according to the new frequency planning, the minimum four frequencies can be found at all the main fourteen transmitter sites.

19.2 Transition Progress

Different actions have been undertaken to ensure the whole country goes digital in harmony and meet the deadline of 30th June 2015 for analogue switch-off:

- signal distributor licensing framework was put in place;
- digital TV infrastructure was rolled out in the whole country;
- DVB-T2 MPEG4 Set Top Box minimum technical requirements were produced and published in order to ensure interoperability;
- DVB-T channel planning was made; now different channels are allocated to the transmitting sites and are ready for assignment to the signal distributors;

- the awareness campaign and the simulcast period are planned to be launched soon;
- the second broadcast signal distribution licence will be awarded soon.

During the simulcast period expected to go until end of 2013, existing analogue channels shall be accommodated on the signal distributor's multiplex platform for free to air.

19.3 Challenges

- availability of compatible digital STBs at affordable prices to the general public;
- generating appropriate content that is relevant to the Rwandan public to populate the envisaged immense capacity afforded on digital platform;
- lack of electricity in some rural areas.

Annexes: 2

Annex 1

Minimum Technical Specifications of Set Top Box (STB) for Digital Terrestrial Television (DTT) in Rwanda

In preparation for migration from analogue to digital television, Rwanda Utilities Regulatory Agency (RURA) like other sister regulators in East African Community (EAC) has adopted DVB-T2 as transmission standards for digital terrestrial television (DTT). Therefore, any rollout of digital broadcasting infrastructure in Rwanda after 2012 shall be in DVB-T2 Standard. Existing broadcasting infrastructure in DVB-T platform are required to be upgraded into DVB-T2.

While awaiting this upgrade, DVB-T and DVB-T2 platforms will run concurrently in Rwanda especially during the entire duration of the simulcast period (migration period).

It is well understood that DVB-T compliant set top box is limited to only receiving DVB-T digital signal and is NOT capable of correctly receiving and displaying digital TV signals transmitted on a DVB-T2 digital platform.

Consequently, in order to receive TV programmes, consumers and vendors of equipment are requested to acquire DVB-T2/MPEG-4 compliant Set Top Boxes or integrated digital TVs (iDTVs) fitted with a DVB-T2 tuner that are capable of receiving and correctly displaying digital TV signals transmitted on both DVB-T and DVB-T2 digital platforms.

In addition to that, STB suppliers are further advised to obtain type approval to import set top boxes from Rwanda Utilities Regulatory Agency as required by the law governing telecommunication.

The minimum DVB-T2/MPEG-4 digital set top box specifications for the Rwandan market are summarized as follows:

TABLE A.1

Basic features	Full function standard IR remote control	
	Minimum channels receivable and storable	200
	Warranty	1 year
	User manual	Use friendly documentation which should be in English or French
System resources	Flash memory	>8 MB
	RAM	>128 MB
RF tuner & DVB-T2 channel	Frequency	– UHF (470-862 MHz) – Optional, VHF (174-230 MHz)
	Input signal level	36-85 dB μ V
	FEC coding	LDPC Code + BCH Code, Code rates: 1/2, 3/5, 2/3, 3/4, 4/5, 5/6
	Transmission mode (Fast Fourier Transform, FFT Size)	1K, 2K, 4K, 8K, 16K, 32K
	C/N range (rice channel)	3 dB (QPSK 1/2) to 24 dB (256QAM 5/6)
	Pilot pattern	PP1 to PP8

TABLE A.1 (continued)

	Guard intervals	1/128, 1/32, 1/16, 19/256, 1/8, 19/128, 1/4
	Channel raster	7 MHz (VHF), 8 MHz (UHF)
	Signal bandwidth	7.61 MHz (Normal mode), 6.80, 7.77 MHz (Extended mode) 1.54 (optional) 6.66, 1.57 (optional)
	Service specific robustness	Physical Layer Pipes (PLP)
	Interleaving	Bit + Cell + Time + Frequency
	Diversity	SISI, MISO (SIMO, MIMI if diversity receiver)
	Rotated constellations	Significant robustness gain in channels with severe degradations (multipath, SFN operation, narrow band interference, etc.)
	Mode of extensions	Future Extension Frame (FEF)
	Max bit rates (8 MHz)	50.3 Mbit/s (32Ke, 256QAM, CR=5/6, GI=1/128, PP7)
	Used bit rates (8 MHz)	Portable SFN: 25.0 Mbit/s, Fixed SFN: 37.0 Mbit/s, Fixed MFN: 40.2 Mbit/s
	$C/(N+I)$ performance in SFNs	EN 300744 compliant
	GE06 compatible	Signal is under the mask of DVB-T (power level measured in a 4 kHz bandwidth)
Maximum frequency offset	The STB shall be able to receive signals with an offset of up to 125 kHz from the nominal centre frequency	
MPEG transmission stream and video and audio decoding	Transmission stream	MPEG-4 ISO/IEC 14496
	Video decoding	MPEG 4 AVC (ITU-T H.264), (ISO/IEC 14496-10)
	Aspect ratio (image rate)	4:3, 16:9
	Frame frequency	25 Hz (PAL)
	Video resolution	720×576 (PAL)-standard definition, HD 1080,1080i
	Audio decoding	MPEG/MusiCam Layer I & II/HE AAC

TABLE A.1 (continued)

	Audio mode	Single track/dual track/stereo
	Audio sampling rate	32 kHz, 44.1 kHz, 48 kHz, 96 kHz (optional)
	Quality reception thresholds	All STBs should have an on-screen visual signal level indicator which would aid in directing the antenna and troubleshooting reception problems
Scanning function (5 min max)	<ul style="list-style-type: none"> – The STB should include a frequency scanning function to detect the availability of DVB-T signals. – It should also automatically list the content of the terrestrial bouquet by reading the PSI/SI streams and – Be capable of programme memory in case of cut off 	
Software	<ul style="list-style-type: none"> – EPG: current and next programme information. 24×7 days schedule – Capable of the Identity control, watch rating and parental lock – Auto/manual tuning – 24-hour clock (optional) – OTA: STB software's, EPG, CA features must be upgradable over the air (USB Upgrade-optional) – Support receive mail – Provides the instant and personalized message prompt – Display and withdrawal of subtitles – Support multi-language info 	
Software for interpretation and handling of the active service information	PSI/SI (programme specific information/service information)	NIT, CAT, PAT, PMT, SDT, EIT, TDT, TOT EN 300 468 and ETSI TR 101 211 compliant
Additional hardware	PVR (optional)	
Teletext & teletext subtitle	<ul style="list-style-type: none"> – It is able to display teletext using the OSD and/or by the insertion of the teletext data in the VBI of the analogue CVBS video output. – It is able to display teletext subtitling, meeting the requirements for level 1.5 in ETS 300 706, "Enhanced Teletext Specification". 	
Interfaces	<ul style="list-style-type: none"> – RF input connector: IEC 169-2 female, input impedance 75 ohms – One RCA (CINCH) female connector for video output and two RCA (CINCH) female connectors for stereo sound output – RF by pass (loop) IEC 169-2 male – RF input via a PAL-B/G modulator – SCART interface (optional) – HDMI interface – USB port (optional) – Data port 1 (RS232, 9 pin D – subtype (optional)) – Should include at least one RF cable to connect the unit with its associated analogue television receiver – For pay TV, at least one CI (Common Interface) slot to allow any type of conditional access module to be plugged into the set top box (EN 50221-1997 V1.2/97) 	

TABLE A.1 (*end*)

Mechanical interfaces (LED indicators)	Green	Normal operation
	Flashing green	System boot in progress
	Flashing red	Software download in progress
	Controls to be provided on the front panel	Menu, P+, P-, V+, V-
Physical attributes	Power supply	AC 230 ± 10%, 50 Hz
Environmental attributes	Power consumption	Max 15 W
	Operating temperature	0~45°C
	Operating humidity	Up to 90%
	Over and under voltage protection	
	Overheating protection	
Reliability	MTBF (Mean time between failures)	80,000 Hrs
	Standby functionality (sleep mode)	
Service acquisition	Typically 500 ms, and a maximum of 750 ms	When required service is carried in the same transport stream as the current service
	Typically 750 ms and a maximum of 1 000 ms	When the required service is in a different transport stream.

Annex 2

Digital frequency planning of Rwanda

RWA				
Broadcasting Regions	Site	Available channels	RBA (1 st Signal Distributor)	2 nd Signal Distributor
KIGALI	Jari	28 43 47	28 43	47 29
	Rebero	22 23 26 27 29	22 26	23 27
	Kabuye	28 38	channel 38 to be used at Kabuye if requested for	
WEST-NORTH	Rubavu	30 33 41 43	30 33	41 43
	Rubona	22 25 27 28	22 28	25 27
	Kanama	39 45	channel 39 to be used at Kanama if requested for	
WEST-CENTER	Karongi	31 34 36 37	34 36	31 37
	Kibisabo	42	to be removed	to be removed
WEST-SOUTH	Gihundwe	25 26 30 41	26 30	25 41
	Kinanira	21 24 35 47	24 35	21 47
	Nyabitimbo	40 43 46	40 43	21 46
EAST	Gitwe	21 30 36	30 45	21 36
	Musaza	39 42 45	30 39	36 42

RWA				
Broadcasting Regions	Site	Available channels	RBA (1 st Signal Distributor)	2 nd Signal Distributor
NORTH-WEST	Karisimbi	24 45		
	Mugogo	32 46	24 45	32 46
NORTH-CENTER	Rushaki	39 48 42	39 48	42 44
	Byumba	25 33 36 44	25 33	36 44
	Bwesige	45		
NORTH-EAST	Nyarupfubire	31 34 37 41	34 41	31 37
SOUTH	Huye	21 38 40 48	40 48	21 38
	Mushubati	35	Free	Free

Appendix 2 to Part 1

Glossary (Abbreviations)

AAC	Advanced Audio Coding
AFS	Alternative Frequency Switching
AM	Amplitude Modulation
ATSC	Advanced Television Systems Committee
ATSC-DTT	Advanced Television Systems Committee – Digital Terrestrial Transmission
ATSC M/H	Advanced Television Systems Committee Mobile / Handheld
BER	Bit Error Rate
BPF	Band Pass Filter
BST	Band Segmented Transmission
CA	Conditional Access
CELP	Code Excited Linear Prediction
COFDM	Coded Orthogonal Frequency Division Multiplex
DAB	Digital Audio Broadcasting
DC	Direct Current
DCP	Distribution and Communications Protocol
DDC	Digital Down Conversion
DTMB	Digital Television Terrestrial Multimedia Broadcasting, Chinese Digital Television – Terrestrial Broadcasting standard
DRM	Digital Radio Mondiale
DSB	Digital Sound Broadcasting
xDSL	x Digital Subscriber Line
DVB	Digital Video Broadcasting
DVB-H	Digital Video Broadcasting – Handheld
DVB-T	Digital Video Broadcasting – Terrestrial
ETSI	European Telecommunications Standards Institute
FAC	Fast Access Channel
FDM	Frequency Division Multiplex
FEC	Forward Error Correction
FLO	Forward Link Only
FM	Frequency Modulation
GPRS	General Packet Radio Service
GPS	Global Positioning System
GSM	Global System for Mobile communication
HF	High Frequency
HVXC	Harmonic Vector excitation Coding
IBOC	In Band On Channel
IDS	iDAB Data Service
IEC	International Electrotechnical Committee

IP	Internet Protocol
IPR	Intellectual Property Right
IRD	Integrated Receiver and Decoder
ISDB	Integrated Services Digital Broadcasting
ISDB-T	Integrated Services Digital Broadcasting – Terrestrial
ISDB-T _{SB}	Integrated Services Digital Broadcasting – Terrestrial Sound Broadcasting
ISDN	Integrated Services Digital Network
ITU-D	International Telecommunication Union – Telecommunication Development Sector
ITU-R	International Telecommunication Union – Radiocommunication Sector
ITU-T	International Telecommunication Union – Telecommunication Standardization Sector
LAN	Local Area Network
LF	Low Frequency
LMDS	Local Multipoint Distribution System
LW	Long Wave
MCI	Modulator Control Interface
MCS	Multiple Channel Simulcast
MDI	Multiplex Distribution Interface
MER	Modulation Error Ratio
MHP	Multimedia Home Platform
MLC	Multi-Level Coding
MLDS	Multimedia Local Distribution System
MF	Medium Frequency
MFN	Multi-Frequency Network
MMDS	Multichannel Multipoint Distribution System
MPEG	Moving Picture Experts Group
MSC	Main Service Channel
MUX	Multiplexer
MW	Medium Wave
NTP	Network Time Protocol
NTSC	National Television System Committee
NVIS	Near Vertical Incidence Sky-wave
NVOD	Near Video On Demand
OCDE	Organisation pour le Commerce et le Développement Economique
OFDM	Orthogonal Frequency Division Multiplex
PC	Personal Computer
PDA	Personal Digital Assistant
PFT	Protection, Fragmentation and Transport
PSTN	Public Switched Telephone Network
QAM	Quadrature Amplitude Modulation
QoSAM	Quality of Service in the digitized AM bands
QPSK	Quadrature Phase Shift Keying
RA	Radiocommunication Assembly of ITU-R
RBDS	Radio Broadcasting Data System
RDS	Radio Data System

RF	Radio Frequency
RFP	Radio Frequency Phase
RRB	Radio Regulatory Board of ITU
RSCI	Receiver Status and Control Interface
RT	Remote Terminal
SBR	Spectral Band Replication
SCE	Service Component Encoder
SCS	Single Channel Simulcast
SDC	Service Description Channel
SDI	Service Distribution Interface
SFN	Single Frequency Network
SNR	Signal to Noise Ratio
SOHO	Small Business or Home Business
SW	Short Wave
T-DAB	Terrestrial Digital Audio Broadcasting
T-DMB	Terrestrial Digital Multimedia Broadcasting
TMCC	Transmission and Multiplexing Configuration Control
UEP	Unequal Error Protection
UDP	User Datagram Protocol
UMTS	Universal Mobile Telecommunications System
USB	Universal Serial Bus
VOD	Video On Demand
VSAT	Very Small Aperture Terminal
VSF	Vestigial Sideband
WAN	Wide Area Network
WARC	World Administrative Radiocommunication Conference
WLL	Wireless Local Loop
WRC	World Radiocommunication Conference
WTDC	World Telecommunication Development Conference

Part 2

TABLE OF CONTENTS

	<i>Page</i>
Part 2	81
Chapter 1 to Part 2	84
1.1 Digital Radio Mondiale	84
1.2 T-DAB general	91
1.3 IBOC.....	92
1.4 ISDB-TSB.....	103
1.5 ATSC	111
1.6 DVB-T	118
1.7 DVB-H.....	119
1.8 ISDB-T	122
1.9 Terrestrial digital multimedia broadcasting.....	125
1.10 LMDS (local multipoint distribution system).....	128
1.11 Forward link only	130
Chapter 2 to Part 2	133
2.1 Aspects related to interoperability of systems	133
2.2 Mobile services	136
Chapter 3 to Part 2	139
3.1 Report of TG 6/8.....	139
3.2 UMTS/GSM and DVB-T convergence	140
3.3 DRM simulcast	141
3.4 Service planning	142
3.5 Market impact.....	147
3.6 General strategy and coordination	150
3.7 Problems related to the interoperability of systems.....	151
3.8 Precautions to control the direct health effects of RF radiation	154
3.9 Precautions to control the indirect RF radiation hazards.....	156
3.10 Field-strength values to be determined.....	156
3.11 Additional evaluation methods	158

	<i>Page</i>
3.12 Legal consideration.....	162
Appendix 1 to Part 2	162
1 Australia	162
2 Brazil	170
3 Bulgaria	176
4 Canada	181
5 Germany	195
6 Guinea.....	196
7 Italy.....	197
8 Japan	208
9 Kenya.....	219
10 Russian Federation	237
11 Tanzania	242
12 United States of America.....	244
13 Republic of Korea.....	248
14 Venezuela	250
Appendix 2 to Part 2	252

Chapter 1

to Part 2

1.1 Digital Radio Mondiale

1.1.1 Features of the system design for the markets to be served by the Digital Radio Mondiale system

The Digital Radio Mondiale (DRM) system, is a flexible digital sound broadcasting (DSB) system for use in the terrestrial broadcasting bands below 30 MHz (see Recommendation ITU-R BS.1514.)

It is important to recognize that the consumer radio receiver of the near future will need to be capable of decoding any or all of several terrestrial transmissions; that is, narrow-band digital (for <30 MHz RF), wider band digital (for >30 MHz RF), and analogue for the LF, MF, HF bands and the VHF/FM band. The DRM system will be an important component within the receiver. It is unlikely that a consumer radio receiver designed to receive terrestrial transmissions with a digital capability would exclude the analogue capability.

In the consumer radio receiver, the DRM system will provide the capability to receive digital radio (sound, program related data, other data, and still pictures) in all the broadcasting bands below 30 MHz. It can function in an independent manner, but, as stated above, will more likely be part of a more comprehensive receiver – much like the majority of today's receivers that include AM and FM band analogue reception capability.

The DRM system is designed to be used in either 9 or 10 kHz channels or multiples of these channel bandwidths. Differences in detail on how much of the available bit stream for these channels is used for audio, for error protection and correction, and for data depend on the allocated band (LF, MF, or HF) and on the intended use (for example, ground wave, short distance sky wave or long distance sky wave). In other words, there are modal trade-offs available so that the system can match the diverse needs of broadcasters worldwide. As indicated in the next section, when regulatory procedures are in place to use channels of greater bandwidth than 9/10 kHz, the DRM system's audio quality and total bit stream capability can be greatly improved.

The DRM system employs advanced audio coding (AAC), supplemented by spectral band replication (SBR) as its main digital encoding. SBR improves perceived audio quality by a technique of higher baseband frequency enhancement using information from the lower frequencies as cues. OFDM/QAM is used for the channel coding and modulation, along with time interleaving and forward error correction (FEC) using multi-level coding (MLC) based on a convolutional code. Pilot reference symbols are used to derive channel equalization information at the receiver. The combination of these techniques results in higher quality sound with more robust reception within the intended coverage area when compared with that of currently used AM.

The system performs well under severe propagation conditions, such as those encountered under long distance multipath HF sky-wave propagation, as well as under easier to cope with MF groundwave propagation. In the latter case, maximum use is made of the AAC and SBR source coding algorithms, leading to much higher quality audio than that achieved by AM, since a minimal amount of error correction has to be employed. For many HF propagation conditions, the necessity to achieve a high degree of robustness reduces the audio quality compared to MF digital; nevertheless, the audio quality is still better than current AM quality.

The design permits the use of the DRM system within a single frequency network (SFN).

It also provides the capability for automatic frequency switching, which is of particular value for broadcasters who send the same signals at different transmission frequencies. For example, this is done routinely by large HF broadcasting organizations using AM to increase the probability of at least one good signal in the intended reception area. The DRM system can enable a suitable receiver to select the best frequency for a programme automatically without any effort on the part of the listener.

1.1.2 Brief description of the DRM system

1.1.2.1 Overall design

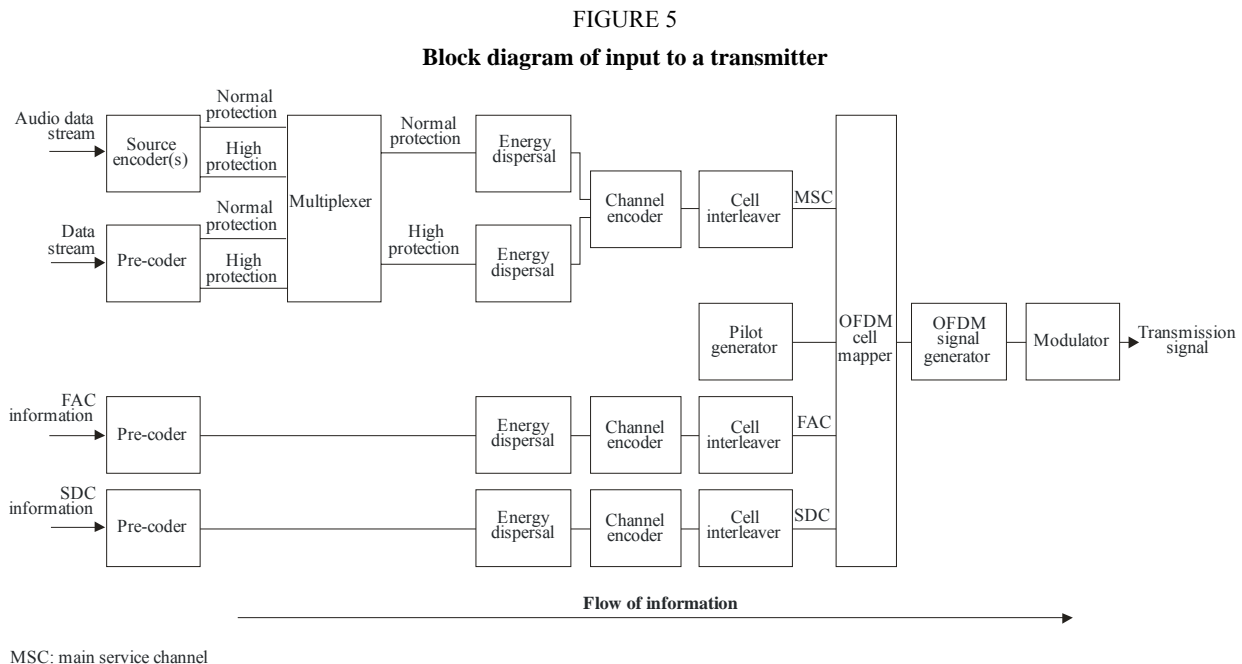

Report BT.2140-05

Figure 5 describes the general flow of the different classes of information (audio, data, etc.) from encoding on the left of the Figure to a DRM system transmitter exciter on the right. Although a receiver diagram is not included as a figure, it would represent the inverse of this diagram.

On the left are two classes of input information:

- the encoded audio and data that are combined in the main service multiplexer;
- information channels that bypass the multiplexer that are known as fast access channel (FAC) and service description channel (SDC)

The audio source encoder and the data pre-coders ensure the adaptation of the input streams onto an appropriate digital format. Their output may comprise two parts requiring two different levels of protection within the subsequent channel encoder.

The multiplex combines the protection levels of all data and audio services.

The energy dispersal provides a deterministic, selective complementing of bits in order to reduce the possibility that systematic patterns result in unwanted regularity in the transmitted signal.

The channel encoder adds redundant information as a means for error correction and defines the mapping of the digital encoded information into QAM cells. The system has the capability, if a broadcaster desires, to convey two categories of “bits”, with one category more heavily protected than the other.

Cell interleaving spreads consecutive QAM cells onto a sequence of cells, quasi-randomly separated in time and frequency, in order to provide an additional element of robustness in the transmission of the audio in time-frequency dispersive channels.

The pilot generator injects information that permits a receiver to derive channel equalization information, thereby allowing for coherent demodulation of the signal.

The OFDM cell mapper collects the different classes of cells and places them on a time-frequency grid.

The OFDM signal generator transforms each ensemble of cells with the same time index to a time domain representation of the signal, containing a plurality of carriers. The complete time-domain OFDM symbol is then obtained from this time domain representation by inserting a guard interval – a cyclic repetition of a portion of the signal.

The modulator converts the digital representation of the OFDM signal into the analogue signal that will be transmitted via a transmitter/antenna over the air. This operation involves frequency up-conversion, digital-to-analogue conversion, and filtering so that the emitted signal complies with ITU-R spectral requirements.

With a non-linear high-powered transmitter, the signal is first split into its amplitude and phase components (this can advantageously be done in the digital domain), and then recombined (by the action of the transmitter itself) prior to final emission.

1.1.2.2 Audio source coding

FIGURE 6

Source coding overview

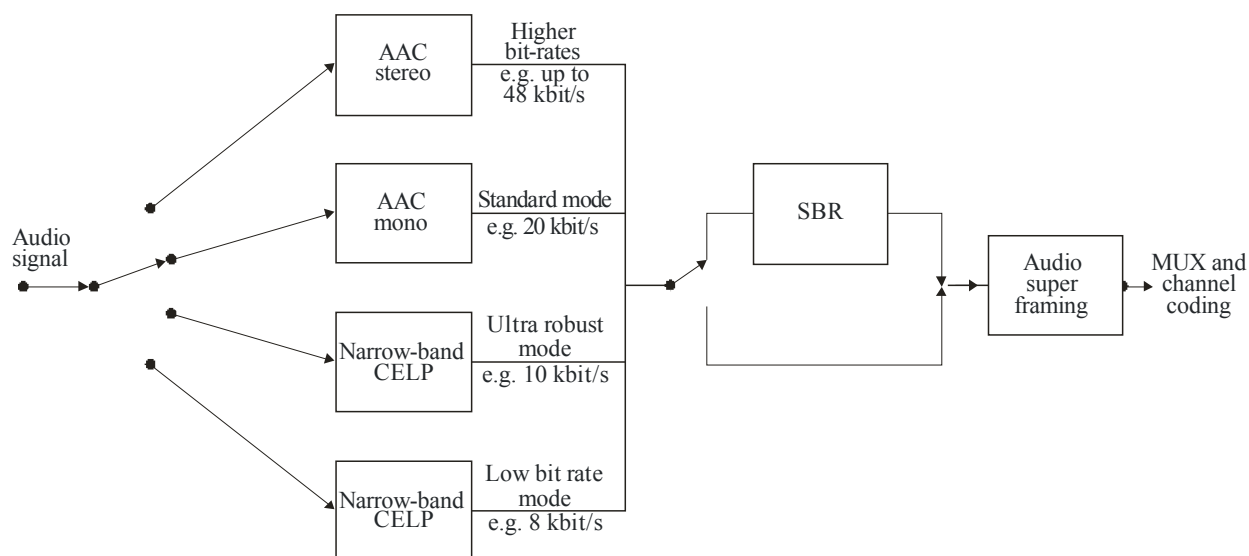

CELP: code excited linear prediction

Report BT.2140-06

The source coding options available for the DRM system are depicted in Fig. 6. All of these options, with the exception of the one at the top of the figure (AAC stereo), are designed to be used within the current 9/10 kHz channels for sound broadcasting below 30 MHz. The CELP option provides relatively low bit-rate speech encoding and the AAC option employs a subset of standardized MPEG-4 for low bit rates (that is, up to 48 kbit/s). These options can be enhanced by a bandwidth-enhancement tool, such as the SBR depicted in the figure. Representative output bit rates are noted in the figure. All of this is selectable by the broadcaster.

Special care is taken so that the encoded audio can be compressed into audio superframes of constant time length (400 ms). Multiplexing and unequal error protection (UEP) of audio/speech services is effected by means of the multiplex and channel coding components.

As an example of the structure, consider the path in Fig. 6 of AAC mono plus SBR. For this, there are the following properties:

Frame length:	40 ms
AAC sampling rate:	24 kHz
SBR sampling rate:	48 kHz
AAC frequency range:	0-6.0 kHz
SBR frequency range:	6.0-15.2 kHz
SBR average bit rate:	2 kbit/s per channel.

In this case, there is a basic audio signal 6 kHz wide, which provides audio quality better than standard AM, plus the enhancement using the SBR technique that extends this to 15.2 kHz. All of this consumes approximately 22 kbit/s. The bitstream per frame contains a fraction of highly protected AAC and SBR data of fixed size, plus the majority of AAC and SBR data, less protected, of variable size. The fixed-time-length audio superframe of 400 ms is composed of several of these frames.

1.1.2.3 Multiplex, including special channels

As noted in Fig. 5, the DRM system total multiplex consists of three channels: the MSC, the FAC and the SDC. The MSC contains the services, audio and data. The FAC provides information on the signal bandwidth and other such parameters and is also used to allow service selection information for fast scanning. The SDC gives information to a receiver on how to decode the MSC, how to find alternate sources of the same data, and gives attributes to the services within the multiplex.

The MSC multiplex may contain up to four services, any one of which can be audio or data. The gross bit rate of the MSC is dependent upon the channel bandwidth and transmission mode being used. In all cases, it is divided into 400 ms frames.

The FAC's structure is also built around a 400 ms frame. The channel parameters are included in every FAC frame. The service parameters are carried in successive FAC frames, one service per frame. The names of the FAC channel parameters are: base/enhancement flag, identity, spectrum occupancy, interleaver depth flag, modulation mode, number of services, reconfiguration index, and reserved for future use. These use a total of 20 bits. The service parameters within the FAC are: service identifier, short identifier, CA (conditional access) indication, language, audio/data flag, and reserved for future use. These use a total of 44 bits. (Details on these parameters, including field size, are given in the system specification.)

The SDC's frame periodicity is 1 200 ms. Without detailing the use for each of the many elements within the SDC's fields, the names of them are: multiplex description, label, conditional access, frequency information, frequency schedule information, application information, announcement support and switching, coverage region identification, time and date information, audio information, FAC copy information, and linkage data. As well as conveying this data, the fact that the SDC is inserted periodically into the waveform is exploited to enable seamless switching between alternate frequencies.

1.1.2.4 Channel coding and modulation

The coding/modulation scheme used is a variety of coded orthogonal FDM (COFDM) which combines OFDM with MLC based on convolutional coding. These two main components are supplemented by cell interleaving and the provision of pilot cells for instantaneous channel estimation, which together mitigate the effects of short-term fading, whether selective or flat.

Taken together, this combination provides excellent transmission and signal protection possibilities in the narrow 9/10 kHz channels in the long-wave, medium-wave and short-wave broadcasting frequency bands. And it can also be effectively used at these broadcasting frequencies for wider channel bandwidths in the event that these are permitted from a regulatory standpoint in the future.

For OFDM, the transmitted signal is composed of a succession of symbols, each including a guard interval – a cyclic prefix which provides robustness against delay spread. Orthogonality refers to the fact that, in the case of the design of the DRM system, each symbol contains approximately 200 subcarriers spaced across the 9/10 kHz in such a way that their signals do not interfere with each other (are orthogonal). The precise number of subcarriers, and other parameter considerations, are a function of the mode used: ground wave, sky wave, and highly robust transmissions.

QAM is used for the modulation that is impressed upon each of the various subcarriers to convey the information. Two primary QAM constellations are used: 64-QAM and 16-QAM. A QPSK mode is also incorporated for highly robust signalling (but not for the MSC).

The interleaver time span for HF transmission is in the range of 2.4 s to cope with time- and frequency-selective fading. Owing to less difficult propagation conditions, a shortened interleaver with 0.8 s time span can be applied for LF and MF frequencies.

The multi-level convolutional coding scheme will use code rates in the range between 0.5 and 0.8, with the lower rate being associated with the difficult HF propagation conditions.

1.1.3 Transmitter considerations

The DRM system exciter can be used to impress signals on both linear and non-linear transmitters. It is expected that high-powered non-linear transmitters will be the normal way of serving the broadcasters. This is similar to current practice which exists for double-sideband amplitude modulation.

Because of this need, over the past few years, using the DRM system and other prototypes, effort has been spent to determine how these non-linear transmitters can be used with narrow-band digital signals. The results have been encouraging, as can be seen from recent DRM system field tests.

Briefly, the incoming signal to a Class C (non-linear amplification) transmitter needs to be split into its amplitude and phase components prior to final amplification. The former is passed via the anode circuitry, the latter through the grid circuitry. These are then combined with the appropriate time synchronization to form the output of the transmitter.

Measurements of the output spectra show the following: the energy of the digital signal is more or less evenly spread across the 9/10 kHz assigned channel; the shoulders are steep, and drop rapidly to 40 dB or so below the spectral density level within the assigned 9/10 kHz channel, and the power spectral density levels continue to decrease at a lower rate beyond $\pm 4.5/5.0$ kHz from the central frequency of the assigned channel.

1.1.4 Over the air

The digital phase/amplitude information on the RF signal is corrupted to different degrees as the RF signal propagates. Some of the HF channels provide challenging situations of fairly rapid flat fading, multipath interference that produces frequency-selective fading and large path delay spreads in time, and ionospherically induced high levels of Doppler shifts and Doppler spreads.

The error protection and error correction incorporated in the DRM system design mitigates these effects to a great degree. This permits the receiver to accurately decode the transmitted digital information.

1.1.5 Selecting, demodulation and decoding of a DRM system signal at a receiver

A receiver must be able to detect which particular DRM system mode is being transmitted, and handle it appropriately. This is done by way of the use of many of the field entries within the FAC and SDC.

Once the appropriate mode is identified (and is repeatedly verified), the demodulation process is the inverse of that shown in the upper half of Fig. 5, the diagram of the transmitter blocks.

Similarly, the receiver is also informed what services are present, and, for example, how source decoding of an audio service should be performed.

1.1.6 Ongoing case study in Italy since 2006: DRM daytime MW Tests for frequencies below 1 MHz

The transmission site located near Milan was used to provide for an initial field test on frequency (693 kHz). The DRM signal is being broadcast by a station in Siziano, located 20 kilometres south of Milan. The same site is used to broadcast RAI's regular analogue MW signals.

The analogue transmitter (working on 200 kW at 900 kHz) was combined with the digital transmitter (working on 34 kW at 693 kHz) and radiated by the same antenna structure.

On the basis of acquired data for the DRM transmission we can reach the following conclusions.

The whole north-west part of Italy is completely covered with a signal strength with a level greater than the minimum one indicated in Recommendation ITU-R BS.1698 for the adopted configuration transmission parameters (38.6 dB(μ V/m)). Moreover minimum SNR of 14.1 dB was exceeded in each measurement point, also in deep valleys. The extension of coverage area can be identified with national border (Sestriere, Ceresole Reale, Domodossola and Bormio). On the east direction the DRM signal is available up to Trieste on which seacoast the field strength is 48.5 dB(μ V/m) with a SNR of 21.7 dB. Due to particular topography and poor ground conductivity the Brennero valley was covered only before the town of Trento. In south-east direction DRM is available up to just before Ancona. In south direction DRM reaches all Liguria coast, and a part of Tuscany coast up to Grosseto town. The cities of Genova, Savona, La Spezia and Livorno are also covered.

The whole coverage results are indicated on Map 1. The inner contour shows the coverage area in which both commercial and professional receivers were able to decode DRM signal. The outer contour shows the coverage area in which only professional receiver was able to decode DRM signal.

MAP 1

Measured coverage area



- Receiving area professional receiver only*
 Receiving area professional and commercial receivers

Report BT.2140-map1

The service area shown on Map 2 is computed on the basis of 45 dB(μ V/m) for towns below 1,000 living persons and of 53 dB(μ V/m) for towns with more than 1,000 living persons.

At the moment, about 150 static measurement points were verified.

Some data analysis was done in order to identify locations where reception was not available because of local particular situations:

- in the centre town of Turin, 125 km far from the transmitter, in 1 of 12 measurement points the performance of DRM signal has been damaged by an electric feeder for public transport. At that point was recorded a SNR of 13.4 dB with a signal strength of 52.1 dB(μ V/m) and no audio decoding;
- northern from Milan, at the beginning of Valtellina valley (93 km far from the transmitter) some topographical situations and poor ground conductivity cause low signal strength (35.7 dB(μ V/m)) and SNR (8.5 dB). Travelling along the valley route the signal and SNR come back to increase up to Bormio city, 170 km far from the transmitter.

MAP 2

Predicted coverage area (according to Recommendation ITU-R P.368-7)

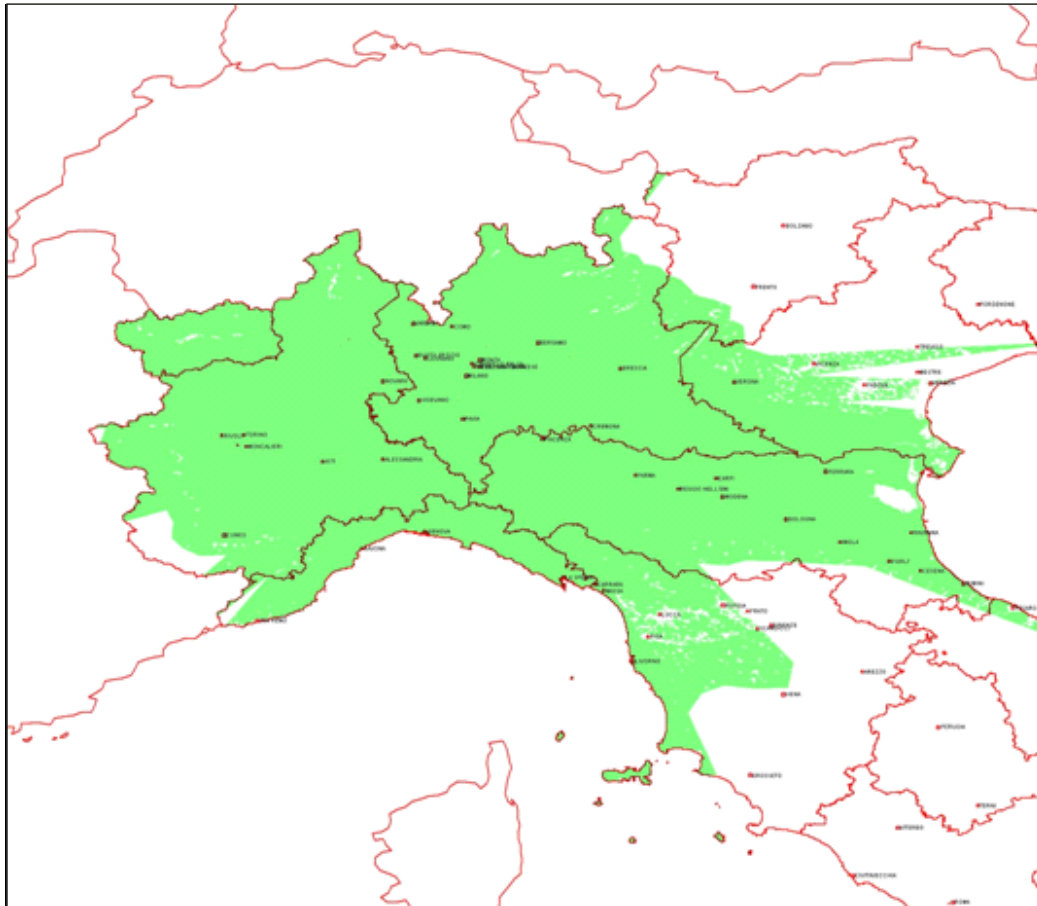

Report BT.2140-map2

During day time no discernable broadcasting interference situations were recorded in the whole predicted and measured coverage area.

As can be easily noted, measured and predicted area match quite well.

1.2 T-DAB general

The multi-carrier T-DAB system as adopted by the majority of countries in Europe and also in some countries outside the European continent, has been designed with a bandwidth of about 1.5 MHz. Frequency blocks have been fit in to the 7 MHz VHF channel scheme. A mean rate of about 1.15 Mbit/s is available for the delivery of high quality CD-like sound services in conjunction with text, data and images, for fixed, portable and mobile receivers.

1.2.1 Frequency bands

1.2.1.1 General

The Plan to be established by the second session of Regional Radio Conference (RRC-06) should contain assignments and/or allotments for digital broadcasting stations in the following bands:

- Band III (174 to 230 MHz);
- Bands IV and V (470 to 862 MHz).

The European countries after evaluating the other possible options have finally adopted the T-DAB system for Band III.

1.2.1.2 Frequencies for sound channels in the planning area

It is to be noted that whilst the frequency band from 174 to 216 MHz is primarily used for terrestrial analogue television, there are also some T-DAB allotments in this band. The frequency band 216-230 MHz (240 MHz in some countries) is mainly allocated to T-DAB in European countries; nevertheless there is still widespread use of part of this band for television.

Ultimately, a flexible approach will be required as regards the use of T-DAB, or DVB-T, in specific channels in Band III because of the different situations and time-frames all over the planning area, or even within one country. Sharing criteria and clear procedures for both kinds of use are therefore required.

1.2.2 T-DAB in Band III

Band III is seen as the optimum solution for a T-DAB band to provide a terrestrial T-DAB service.

The band does not suffer from a number of the anomalous propagation characteristics which are a problem in Band I such as sporadic E and F2 layer propagation. Man-made noise is significantly lower in Band III than in Band I, and Band III frequencies are still sufficiently low that the Doppler shift created by moving vehicles at motorway speeds will not create a problem for operation in Mode 1 of the digital System A specification.

This is made possible by a rugged system design that allows seamless and fade-free reception even in highly disruptive conditions, largely dominated by multipath propagation.

It has to be noted that Band II was also considered for T-DAB, but this turned out not to be viable due to the congested situation in many areas.

1.2.3 Location of transmitters

It should be noted that in the case of an SFN the separation distance between transmitters influences the choice of guard interval, which in turn determines the size of the network. The separation distance and the effective height influence the effective radiated power. In the implementation of T-DAB existing transmitting site infrastructures have been used where possible, with the addition of some new supplementary sites. The latter have been adopted in order to fulfil the SFN requirements.

1.3 IBOC

1.3.1 IBOC overview

The IBOC system was designed for regions where limited spectrum prevents the allocation of new spectrum for digital broadcasting. The IBOC system allows broadcasters to simultaneously transmit an analogue and digital signal without the need for additional spectrum for the digital signal. The IBOC system takes advantage of unused portions of the spectrum on either side of the analogue carrier (as defined by the service frequency allocation “mask”) and implements frequency re-use by including digital carriers in quadrature to the existing analogue carrier. In either case, the analogue signals are in close proximity to the digital signals and great care must be taken to prevent unwanted interference between them.

The IBOC system offers a number of advantages for broadcasters, consumers and regulators. The IBOC system replicates the existing coverage patterns of each radio station thereby retaining the existing economic value of the station. Broadcasters can convert to digital broadcasts with a modest investment and retain the vast majority of their existing physical plant. In addition, the introduction of the digital signal in the existing channel allows the broadcaster to retain the station’s existing dial position. Because the system supports simulcast of the analogue and digital signals, consumers are able to upgrade to digital over an extended period and taking into account normal equipment

replacement cycles. Regulators benefit because there is no need for spectrum allocations or licensing of new stations.

The IBOC system offers the following features:

- CD quality audio in the VHF-band and VHF quality audio in the MF band.
- Digital coverage equivalent to existing analogue coverage. In areas where the digital signal is lost, the system automatically blends to the analogue back-up signal to ensure digital coverage is never less than existing analogue coverage.
- Advanced coding technologies and time diversity between the analogue and digital signals ensure a robust signal.
- The VHF system has demonstrated significant robustness in the presence of severe multipath, and the MF system has demonstrated significant robustness in the presence of impulse noise.
- The VHF system offers options for introducing new audio and data services ranging from 1 to 300 kbit/s depending on the mode of operation.

The IBOC system has been tested in North and South America, Europe and Asia. It is currently in operation in approximately 1 800 stations throughout the United States of America. This has added more than 900 new multicast audio streams using existing VHF stations. The system has been used for demonstrations, testing and/or ongoing operations in Brazil, China, France, Indonesia, Mexico, the Philippines, Switzerland, Ukraine, Vietnam.

The IBOC system has been standardized by the National Radio Systems Committee (NRSC), a standards setting organization sponsored by the National Association of Broadcasters and the Consumer Electronics Association in the United States. The current version of the standard, NRSC-5-B is available from the NRSC at www.nrscstandards.org.

Currently, there are commercially available IBOC receivers in most market segments. OEM receivers are available in the United States as standard equipment or a factory installed option for many major auto manufacturers. More than sixty models of aftermarket automobile receivers, tabletop receivers, home HiFi receivers and car converter products are available from national and local retailers throughout the United States. As the cost of components and the power consumption levels are reduced in the near future, it is anticipated that mobile receivers will become available.

1.3.2 The IBOC System Technical Design

The IBOC system is designed to permit a smooth evolution from current analog modulation to a fully digital system. This system can deliver digital audio and data services to mobile, portable, and fixed receivers from terrestrial transmitters in the existing medium frequency (MF) and very high frequency (VHF) radio bands. The system is designed to allow broadcasters to continue to transmit analog MF and VHF simultaneously with new, higher-quality and more robust digital signals, allowing broadcasters and their listeners to convert from analog to digital radio while maintaining each station's current frequency allocation.

The IBOC system allows a broadcast station to offer multiple services. A service can be thought of as a logical grouping of application data identified by the IBOC system. Services are grouped into one of two categories:

1. Core Services:
 - a) Main Program Service (both Audio (MPA) and Data (PAD)).
 - b) Station Information Service (SIS).
2. Advanced Application Services (AAS).

The flow of service content through the IBOC broadcast system is as follows:

- a) Service content enters the IBOC broadcast system via Service Interfaces.
- b) Content is assembled for transport using a specific protocol.
- c) It is routed over logical channels via the Channel Multiplex.

It is waveform modulated via the Waveform / Transmission System for over-the-air transmission.

The system employs coding to reduce the sampled audio signal bit rate and baseband signal processing to increase the robustness of the signal in the transmission channel. This allows a high quality audio signal plus ancillary data to be transmitted in band segments and at low levels which do not interfere with the existing analog signals.

1.3.2.1 Services

1.3.2.1.1 Main Program Service

The Main Program Service (MPS) is a direct extension of traditional analog radio. MPS allows the transmission of existing analog radio-programming in both analog and digital formats. This allows for a smooth transition from analog to digital radio.

Radio receivers that are not IBOC enabled can continue to receive the traditional analog radio signal, while IBOC receivers can receive both digital and analog signals via the same frequency band. In addition to digital audio, MPS includes digital data related to the audio programming. This is also referred to as Program Associated Data (PAD).

1.3.2.1.2 Station Information Service

The Station Information Service (SIS) provides the necessary radio station control and identification information, such as station call sign identification, time and location reference information. SIS can be considered a built-in service that is readily available on all IBOC stations. SIS is a required IBOC service and is provided dedicated bandwidth.

1.3.2.1.3 Supplemental Program Service

The Supplemental Program Service (SPS) allows broadcasters to introduce up to seven new digital audio channels depending on the throughput devoted to the SPS. The SPS includes support for Program Associated Data for each program stream.

1.3.2.1.4 Advanced Application Services

Advanced Application Services (AAS) is a complete framework in which new applications may be built. In addition to allowing multiple data applications to share the Waveform / Transmission medium, AAS provides a common transport mechanism as well as a unified Application Programming Interface (API). On the transmission side, broadcasters utilize the common AAS interface to insert service(s) into their signal; receiver manufacturers utilize the AAS “toolkit” to efficiently access these new services for the end-user. AAS includes separate audio programming such as reading services and other secondary audio and data services.

1.3.3 System components

1.3.3.1 Codec

The IBOC DSB system uses the HDC codec supplemented by SBR. This delivers high quality “FM-like” stereo audio within the bandwidth constraints imposed on operations below 30 MHz. To further enhance the robustness of the digital audio beyond that provided by FEC and interleaving, special error concealment techniques are employed by the audio codecs to mask the effects of errors in the input bit-stream. Furthermore, the audio codec bit-stream format provides the flexibility of allowing future enhancements to the basic audio coding techniques.

1.3.3.2 Modulation techniques

The IBOC DSB system uses QAM. QAM has a bandwidth efficiency that is sufficient for transmission of “FM-like” stereo audio quality as well as providing adequate coverage areas in the available bandwidth.

The system also uses a multi-carrier approach called OFDM. OFDM is a scheme in which many QAM carriers can be frequency-division multiplexed in an orthogonal fashion such that there is no interference among the carriers. When combined with FEC coding and interleaving, the digital signal’s robustness is further enhanced. The OFDM structure naturally supports FEC coding techniques that maximize performance in the non-uniform interference environment.

1.3.3.3 FEC coding and interleaving

FEC coding and interleaving in the transmission system greatly improve the reliability of the transmitted information by carefully adding redundant information that is used by the receiver to correct errors occurring in the transmission path. Advanced FEC coding techniques have been specifically designed based on detailed interference studies to exploit the non-uniform nature of the interference in these bands. Also, special interleaving techniques have been designed to spread burst errors over time and frequency to assist the FEC decoder in its decision-making process.

A major problem confronting systems operating below 30 MHz is the existence of grounded conductive structures that can cause rapid changes in amplitude and phase that are not uniformly distributed across the band. To correct for this, the IBOC DSB system uses equalization techniques to ensure that the phase and amplitude of the OFDM digital carriers are sufficiently maintained to ensure proper recovery of the digital information. The combination of advanced FEC coding, channel equalization, and optimal interleaving techniques allows the IBOC DSB system to deliver reliable reception of digital audio in a mobile environment.

1.3.3.4 Blend

The IBOC DSB system employs time diversity between two independent transmissions of the same audio source to provide robust reception during outages typical of a mobile environment. In the hybrid system the analogue signal serves as the backup signal, while in the all-digital system a separate digital audio stream serves as the backup signal. The IBOC DSB system provides this capability by delaying the backup transmission by a fixed time offset of several seconds relative to the main audio transmission. This delay proves useful for the implementation of a blend function. During tuning, blend allows transition from the instantly acquired back-up signal to the main signal after it has been acquired. Once acquired, blend allows transition to the back-up signal when the main signal is corrupted. When a signal outage occurs, the receiver blends seamlessly to the backup audio that, by virtue of its time diversity with the main signal, does not experience the same outage.

Digital systems depend on an interleaver to spread errors across time and reduce outages. Generally longer interleavers provide greater robustness at the expense of acquisition time. The blend feature provides a means of quickly acquiring the back-up signal upon tuning or re-acquisition without compromising full performance.

1.3.4 Operating modes

1.3.4.1 Hybrid MF mode

In the hybrid waveform, the digital signal is transmitted in sidebands on either side of the analogue host signal as well as beneath the analogue host signal as shown in Fig. 7. The power level of each OFDM subcarrier is fixed relative to the main carrier as indicated in Fig. 7. The OFDM carriers, or digital carriers, extend approximately ± 14.7 kHz from the AM carrier. The digital carriers directly beneath the analogue signal spectrum are modulated in a manner to avoid interference with the

analogue signal. These carriers are grouped in pairs, with a pair consisting of two carriers that are equidistant in frequency from the AM carrier. Each pair is termed a complementary pair and the entire group of carriers is called the complementary carriers. For each pair, the modulation applied to one carrier is the negative conjugate of the modulation applied to the other carrier. This places the sum of the carriers in quadrature to the AM carrier, thereby minimizing the interference to the analogue signal when detected by an envelope detector. Placing the complementary carriers in quadrature to the analogue signal also permits demodulation of the complementary carriers in the presence of the high level AM carrier and analogue signal. The price paid for placing the complementary carriers in quadrature with the AM carriers is that the information content on the complementary carriers is only half of that for independent digital carriers.

The hybrid mode is designed for stations operating at MF in areas where it is necessary to provide for a rational transition from analogue to digital. The hybrid mode makes it possible to introduce the digital services without causing harmful interference to the existing host analogue signal.

To maximize the reception of the digital audio, the IBOC DSB system uses a layered codec where the compressed audio is split into two separate information streams: core and enhanced. The core stream provides the basic audio information whereas the enhanced stream provides higher quality and stereo information. The FEC coding and placement of the audio streams on the OFDM carriers is designed to provide a very robust core stream and a less robust enhancement stream. For the hybrid system the core information is placed on high-powered carriers ± 10 to 15 kHz from the analogue carrier while the enhanced information is placed on the OFDM carriers from 0 to ± 10 kHz.

To protect the core audio stream from interference and channel impairments the IBOC DSB system uses a form of channel coding with the special ability to puncture the original code in various overlapping partitions (i.e. main, backup, lower sideband and upper sideband). Each of the four overlapping partitions survives independently as a good code. The lower and upper sideband partitions allow the IBOC DSB system to operate even in the presence of a strong interferer on either the lower or upper adjacent, while the main and backup partitions allow the IBOC DSB system to be acquired quickly and be robust to short-term outages such as those caused by grounded conductive structures.

FIGURE 7
Hybrid MF IBOC DSB power spectral density

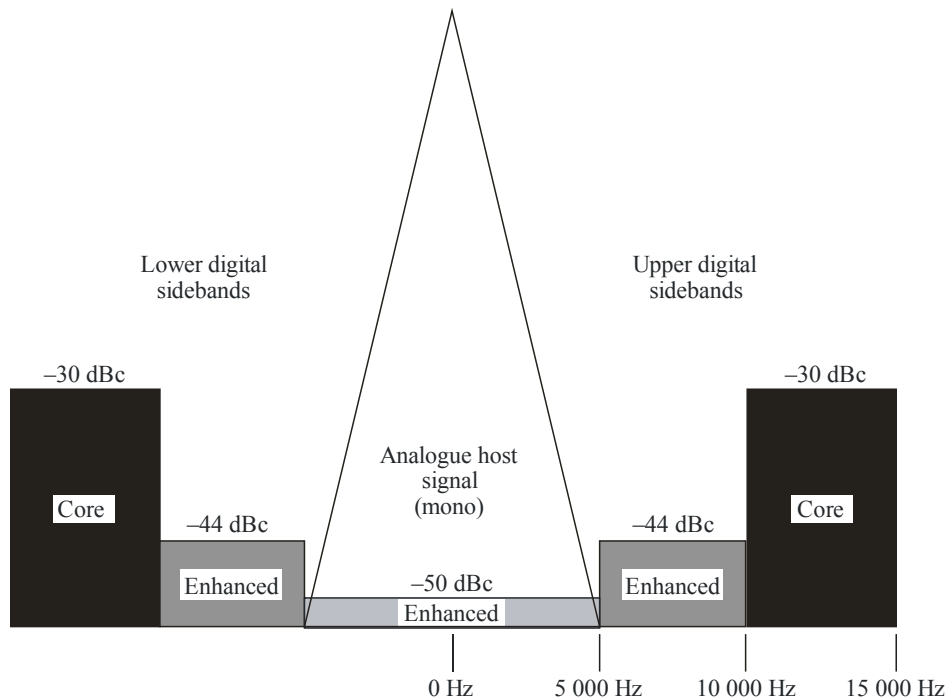

Report BT.2140-07

In the hybrid system the core audio throughput is approximately 20 kbit/s while the enhanced audio throughput adds approximately 16 kbit/s.

1.3.4.2 All-digital MF mode

The all-digital mode allows for enhanced digital performance after deletion of the existing analogue signal. Broadcasters may choose to implement the all-digital mode in areas where there are no existing analogue stations that need to be protected or after a sufficient period of operations in the hybrid mode for significant penetration of digital receivers in the market place.

As shown in Fig. 8, the principal difference between the hybrid mode and the all-digital mode is deletion of the analogue signal and the increase in power of the carriers that were previously under the analogue signal. The additional power in the all-digital waveform increases robustness, and the “stepped” waveform is optimized for performance under strong adjacent channel interference.

The same layered codec and FEC methods, with identical rates (i.e. ~20 kbit/s for the core audio and ~16 kbit/s for the enhanced audio), are used in the all-digital system as is used in the hybrid system. This simplifies the design of a receiver having to support both systems.

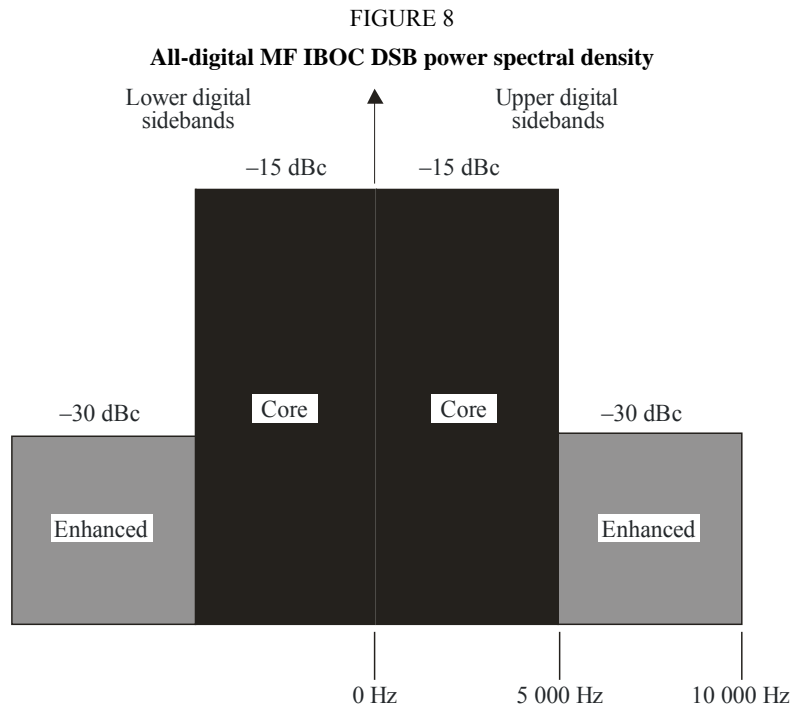

Report BT.2140-08

1.3.4.3 Hybrid VHF mode

The digital signal is transmitted in sidebands on either side of the analogue FM signal. Each sideband is comprised of ten frequency partitions, which are allocated among subcarriers 356 through 545, or -356 through -545 . Subcarriers 546 and -546 , also included in the sidebands, are additional reference subcarriers. The amplitude of the subcarrier within the sidebands is uniformly scaled by an *amplitude scale factor*.

FIGURE 9

Spectrum of the hybrid waveform—service mode
 (The level of the digital subcarriers is such that the total power of these carriers is 20 dB below the nominal power of the FM analogue carrier)

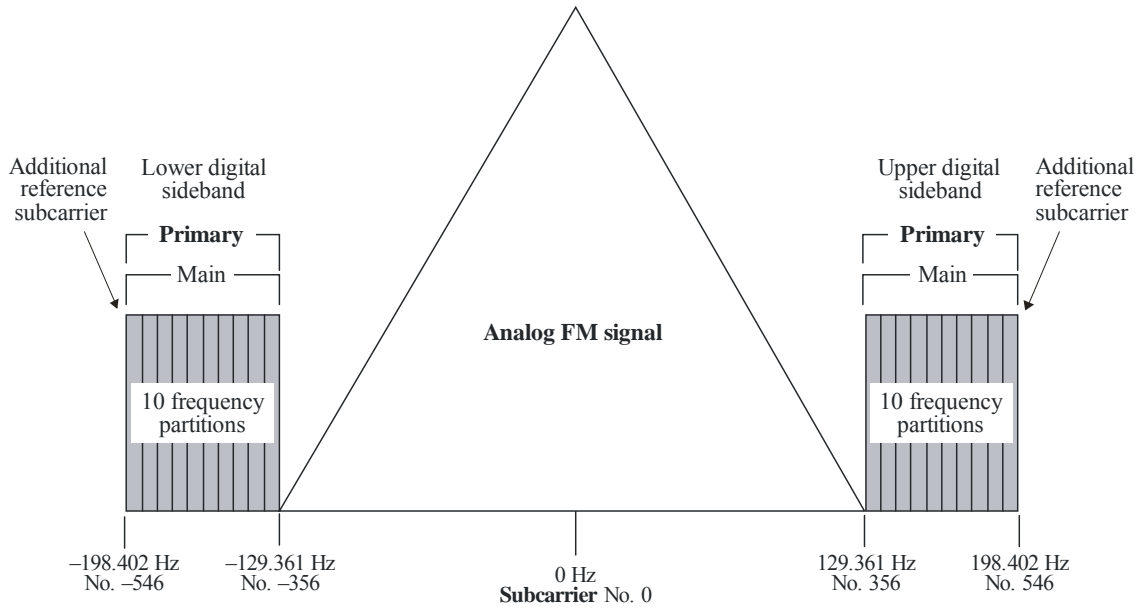

Report BT.2140-09

1.3.4.4 All digital VHF mode

The all-digital waveform is constructed by removing the analogue signal, fully expanding the bandwidth of the primary digital sidebands, and adding lower-power secondary sidebands in the spectrum vacated by the analogue signal. The spectrum of the all-digital waveform is shown in Fig. 10.

FIGURE 10

Spectrum of the all-digital waveform
 (The level of the digital subcarriers is such that the total power of these carriers is no more than 10 dB below the nominal power of the FM analogue carrier that it replaces)

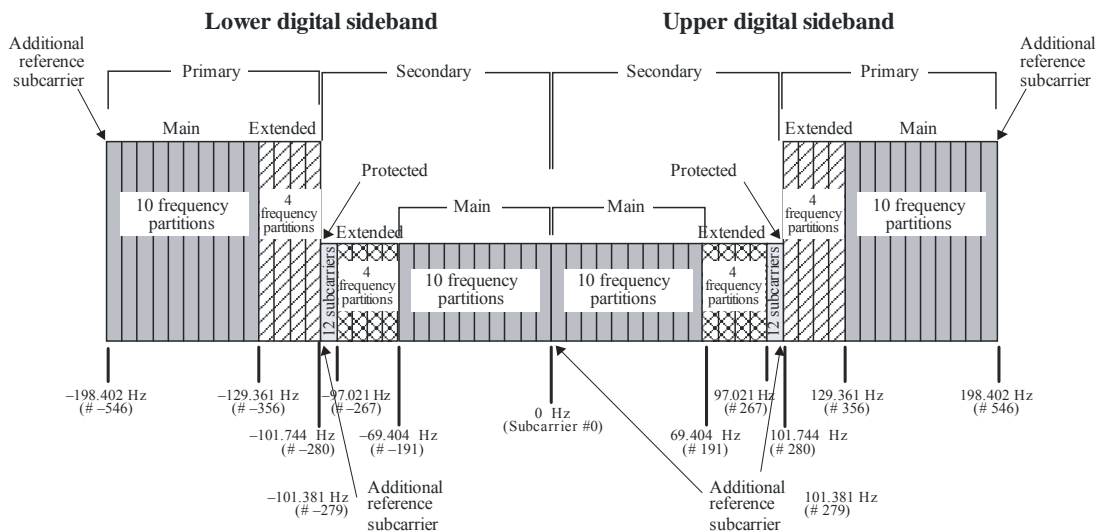

Report BT.2140-10

1.3.5 Generation of the signal

1.3.5.1 Transmission subsystems

A basic block diagram representation of the system is shown in Fig. 11. It represents the IBOC digital radio system as three major subsystems.

- Audio source coding and compression.
- Transport and service multiplex.
- RF/Transmission.

1.3.5.1.1 Audio source coding and compression

The Audio subsystem performs the source coding and compression of the sampled digitized Main Program Service (MPS) audio program material. “Source coding and compression” refers to the bit rate reduction methods, also known as data compression, appropriate for application to the audio digital data stream. In hybrid modes the MPS audio is also analog modulated directly onto the carrier for reception by conventional analog receivers. Several categories of data may also be transmitted on the digital signal including station identification, messages related to the audio program material, and general data services.

1.3.5.1.2 Transport and service multiplex

“Transport and service multiplex” refers to the means of dividing the digital data stream into “packets” of information, the means of uniquely identifying each packet or packet type (data or audio), and the appropriate methods of multiplexing audio data stream packets and data stream packets into a single information stream. The transport protocols have been developed specifically to support data and audio transmission in the MF and VHF radio bands.

FIGURE 11

IBOC digital radio broadcasting model

Analog audio (hybrid modes only)

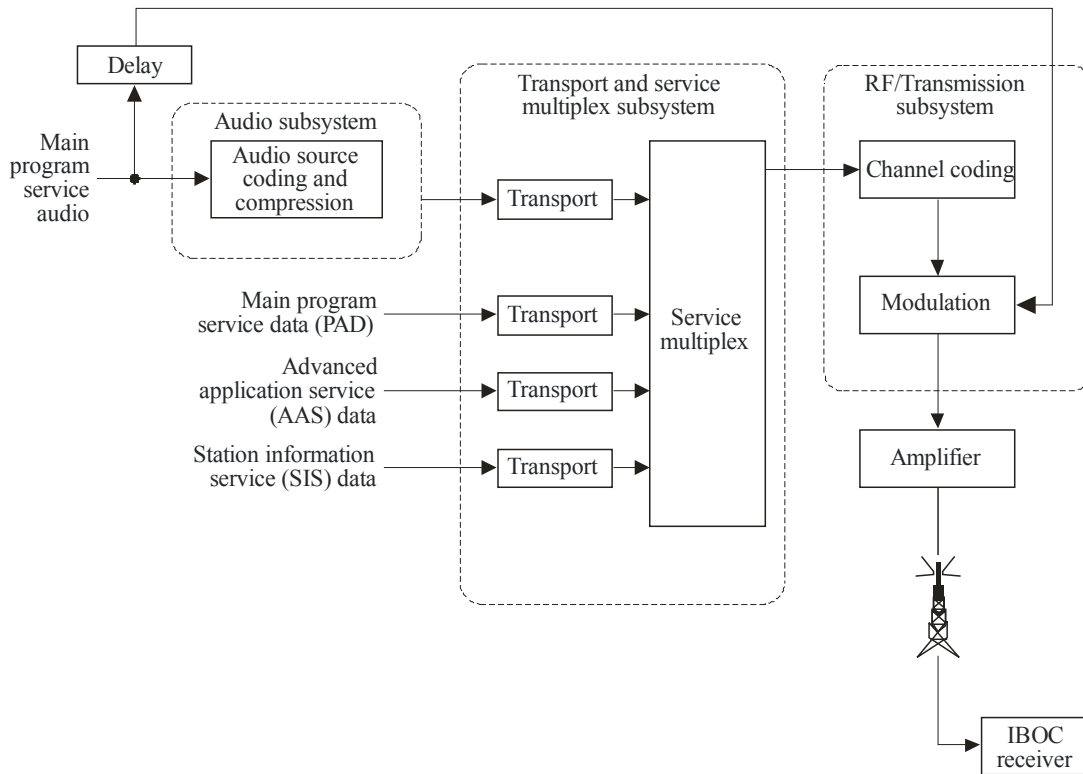

Report BT.2140-11

1.3.5.1.3 RF/Transmission system

“RF/Transmission” refers to channel coding and modulation. The channel coder takes the multiplexed bit stream and applies coding and interleaving that can be used by the receiver to reconstruct the data from the received signal which, because of transmission impairments, may not accurately represent the transmitted signal. The processed bit stream is modulated onto the OFDM subcarriers which are transformed to time domain pulses, concatenated, and up-converted to the VHF band.

1.3.6 Reception of the signal

A functional block diagram of an MF IBOC receiver is presented in Fig. 13. The signal is received by a conventional RF front end and converted to IF, in a manner similar to existing analogue receivers. Unlike typical analogue receivers, however, the signal is filtered, A/D converted at IF, and digitally down converted to baseband in-phase and quadrature signal components. The hybrid signal is then split into analogue and DSB components. The analogue component is then demodulated to produce a digitally sampled audio signal. The DSB signal is synchronized and demodulated into symbols. These symbols are deframed for subsequent deinterleaving and FEC decoding. The resulting bit stream is processed by the audio decoder to produce the digital stereo DSB output. This DSB audio signal is delayed by the same amount of time as the analogue signal was delayed at the transmitter. The audio blend function blends the digital signal to the analogue signal if the digital signal is corrupted and is also used to quickly acquire the signal during tuning or reacquisition.

Noise blanking is an integral part of the IBOC receiver and is used to improve digital and analogue reception. Receivers use tuned circuits to filter out adjacent channels and intermodulation products.

These tuned circuits tend to “ring”, or stretch out short pulses into longer interruptions. A noise blanker senses the impulse and turns off the RF stages for the short duration of the pulse, effectively limiting the effects on the analogue “listenability,” of ringing. Short pulses have a minimal effect on the digital data stream and increases “listenability of the analogue signal” (see Note 1).

NOTE 1 – The data paths and the noise blanker circuit are not shown for simplicity.

FIGURE 12

RF/Transmission function in context of overall system

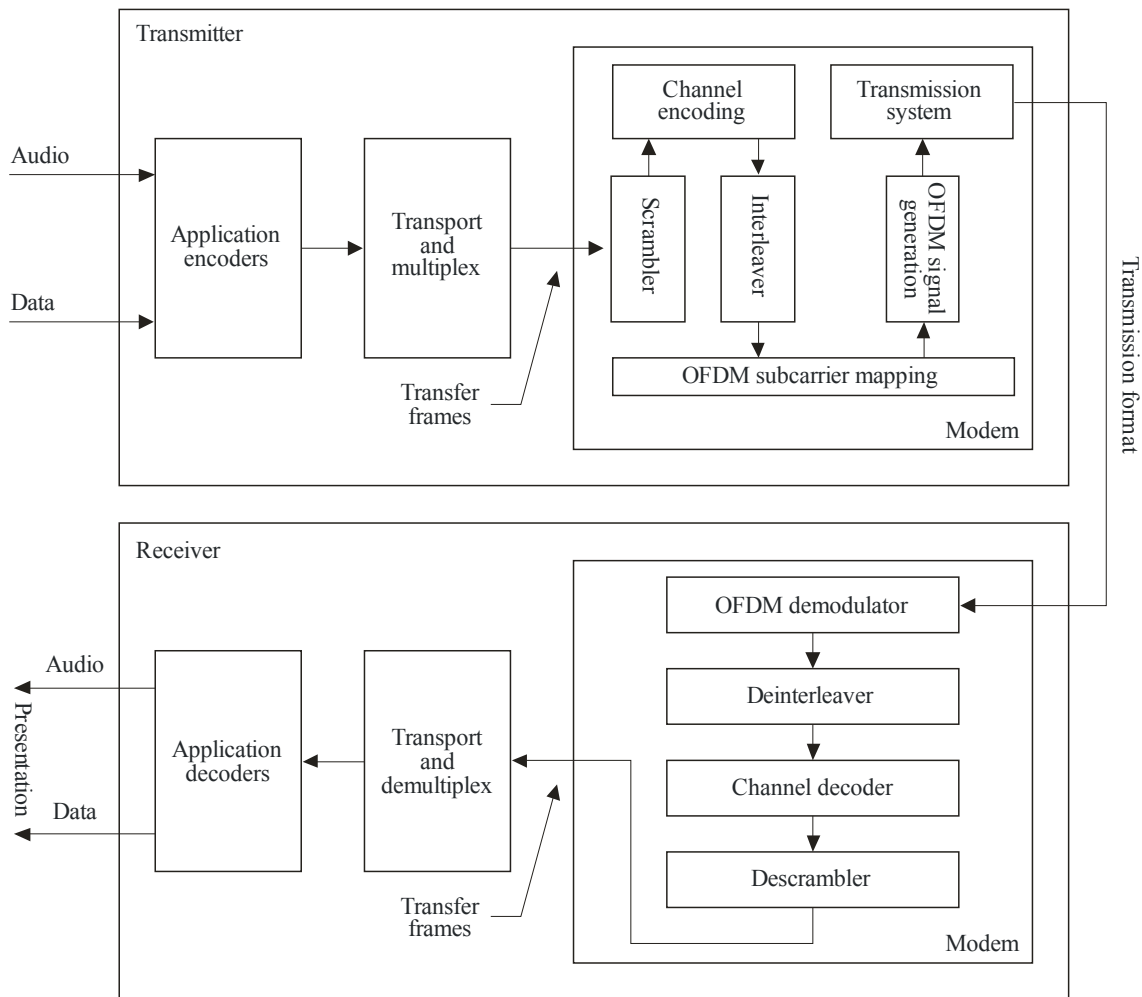
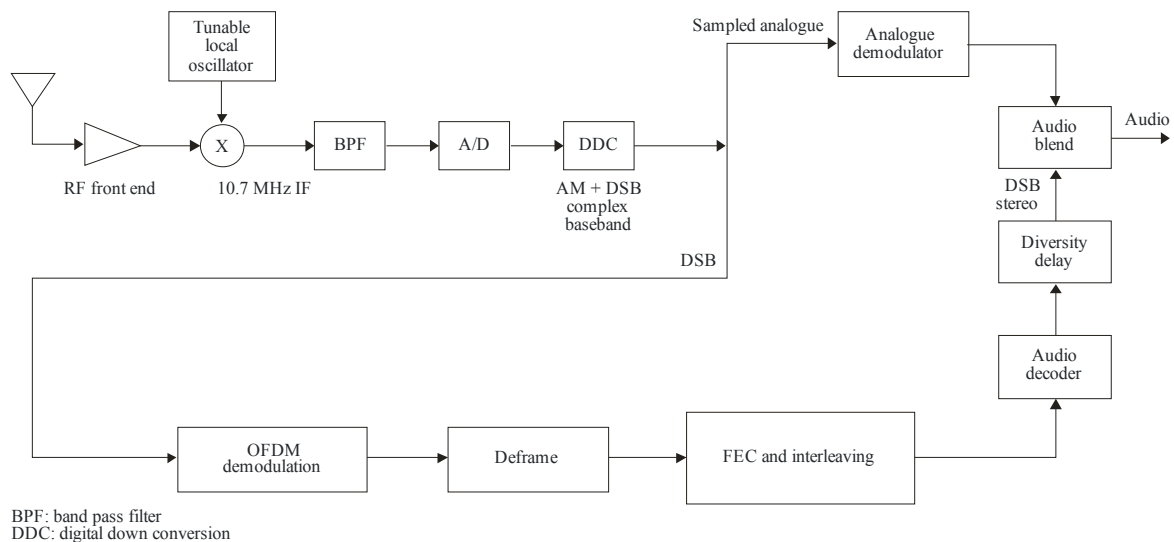

FIGURE 13

Hybrid MF IBOC typical receiver block diagram



Report BT.2140-13

1.4 ISDB-T_{SB}

1.4.1 Features of ISDB-T_{SB}

1.4.1.1 Ruggedness of ISDB-T_{SB}

The ISDB-T_{SB} system uses OFDM modulation, two-dimensional frequency-time interleaving and concatenated error correction codes. OFDM is a multi-carrier modulation method, and it is a multipath-proof modulation method, especially adding a guard interval in the time domain. The transmitted information is spread in both the frequency and time domains by interleaving, and then the information is corrected by the Viterbi and Reed-Solomon (RS) decoder. Therefore a high quality signal is obtained in the receiver, even when working in conditions of severe multipath propagation, whether stationary or mobile.

1.4.1.2 Wide variety of transmission

The ISDB-T_{SB} system adopts BST-OFDM, and consists of one or three OFDM-segments. That is single-segment transmission and triple-segment transmission. A bandwidth of OFDM-segment is defined in one of three ways depending on the reference channel raster of 6, 7 or 8 MHz. The bandwidth is a fourteenth of the reference channel bandwidth (6, 7 or 8 MHz), that is, 429 kHz (6/14 MHz), 500 kHz (7/14 MHz), 571 kHz (8/14 MHz). The bandwidth of OFDM-segment should be selected in compliance with the frequency situation in each country.

The bandwidth of single-segment is around 500 kHz, therefore the bandwidth of single-segment transmission and triple-segment transmission is approximately 500 kHz and 1.5 MHz.

The ISDB-T_{SB} system has three alternative transmission modes which allow the use of a wide range of transmitting frequencies, and four alternative guard interval lengths for the design of the distance between SFN transmitters. These transmission modes have been designed to cope with Doppler spread and delay spread, for mobile reception in presence of multipath echoes.

1.4.1.3 Flexibility

A multiplex structure of the ISDB-T_{SB} system is fully compliant with MPEG-2 systems architecture. Therefore various digital contents such as sound, text, still picture and data can be transmitted simultaneously.

In addition, according to the broadcaster's purpose, they can select the carrier modulation method, error correction coding rate, length of time interleaving, etc. of the system. There are four kinds of carrier modulation method of DQPSK, QPSK, 16-QAM and 64-QAM, five kinds of coding rate of 1/2, 2/3, 3/4, 5/6 and 7/8, and five kinds of time interleaving length from 0 to approximately 1 s. The TMCC carrier transmits the information to the receiver indicating the kind of modulation method and coding rate that are used in the system.

1.4.1.4 Flexibility commonality and interoperability

The ISDB-T_{SB} system uses BST-OFDM modulation and adopts MPEG-2 systems. Therefore the system has commonality with the ISDB-T system for digital terrestrial television broadcasting (DTTB) in the physical layer, and has commonality with the systems such as ISDB-T, ISDB-S, DVB-T and DVB-S which adopt MPEG-2 Systems in the transport layer.

1.4.1.5 Efficient transmission and source coding

The ISDB-T_{SB} system uses a highly-spectrum efficient modulation method of OFDM. Also, it permits frequency reuse broadcasting networks to be extended using additional transmitters all operating on the same radiated frequency.

In addition, the channels of independent broadcasters can be transmitted together without guardbands from the same transmitter as long as the frequency and bit synchronization are kept the same between the channels.

The ISDB-T_{SB} system can adopt MPEG-2 AAC. Near CD quality can be realized at a bit rate of 144 kbit/s for stereo.

1.4.1.6 Independency of broadcasters

The ISDB-T_{SB} system is a narrow-band system for transmission of one sound programme at least. Therefore broadcasters can have their own RF channel in which they can select transmission parameters independently.

1.4.1.7 Low-power consumption

Almost all devices can be made small and light weight by developing LSI chips. The most important aspect of efforts to reduce battery size is that the power consumption of a device must be low. The slower the system clock, the lower the power consumption. Therefore, a narrow-band, low bit rate system like single-segment transmission can allow for the receiver to be both portable and lightweight.

1.4.1.8 Hierarchical transmission and partial reception

In the triple-segment transmission, both one layer transmission and hierarchical transmission can be achieved. There are two layers of A and B in the hierarchical transmission. The transmission parameters of carrier modulation scheme, coding rates of the inner code and a length of the time interleaving can be changed in the different layers.

The centre segment of hierarchical transmission is able to be received by single-segment receiver. Owing to the common structure of an OFDM segment, a single-segment receiver can partially receive a centre segment of full-band ISDB-T signal whenever an independent program is transmitted in the centre segment.

Figure 14 shows an example of hierarchical transmission and partial reception.

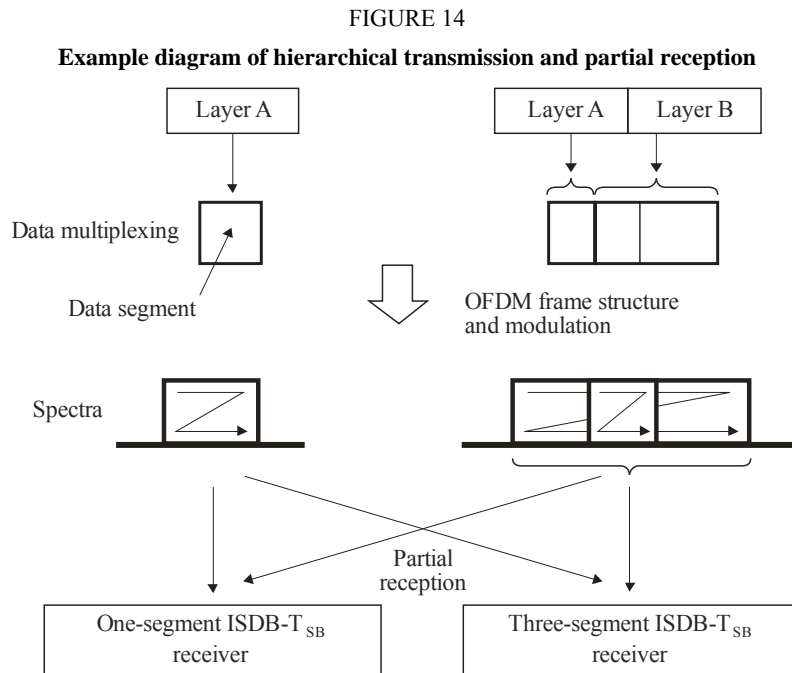

Report BT.2140-14

1.4.2 Transmission parameters

The ISDB-T_{SB} system can be assigned to 6 MHz, 7 MHz or 8 MHz channel raster. Segment bandwidth is defined to be a fourteenth of channel bandwidth, therefore that is 429 kHz (6/14 MHz), 500 kHz (7/14 MHz) or 571 kHz (8/14 MHz). However, the segment bandwidth should be selected in compliance with the frequency situation in each country.

The transmission parameters for the ISDB-T_{SB} system are shown in Table 6.

TABLE 6

Transmission parameters for the ISDB-T_{SB}

Mode	Mode 1	Mode 2	Mode 3
Total number of segments ⁽¹⁾ ($N_s = n_d + n_c$)		1, 3	
Reference channel raster (BW_f) (MHz)		6, 7, 8	
Segment bandwidth (BW_s) (kHz)		$BW_f \times 1\,000/14$	
Used bandwidth (BW_u) (kHz)		$BW_s \times N_s + C_s$	
Number of segments for differential modulation		n_d	
Number of segments for coherent modulation		n_c	

TABLE 6 (end)

Mode		Mode 1	Mode 2	Mode 3
Carrier spacing (C_s) (kHz)		$BWs/108$	$BWs/216$	$BWs/432$
Number of carriers	Total	$108 \times N_s + 1$	$216 \times N_s + 1$	$432 \times N_s + 1$
	Data	$96 \times N_s$	$192 \times N_s$	$384 \times N_s$
	SP ⁽²⁾	$9 \times n_c$	$18 \times n_c$	$36 \times n_c$
	CP ⁽²⁾	$n_d + 1$	$n_d + 1$	$n_d + 1$
	TMCC ⁽³⁾	$n_c + 5 \times n_d$	$2 \times n_c + 10 \times n_d$	$4 \times n_c + 20 \times n_d$
	AC1 ⁽⁴⁾	$2 \times N_s$	$4 + N_s$	$8 \times N_s$
	AC2 ⁽⁴⁾	$4 \times n_d$	$9 \times n_d$	$19 \times n_d$
Carrier modulation		DQPSK, QPSK, 16-QAM, 64-QAM		
Number of symbols per frame		204		
Useful symbol duration (T_u) (μ s)		$1\ 000/C_s$		
Guard interval duration (T_g)		$1/4, 1/8, 1/16$ or $1/32$ of T_u		
Total symbol duration (T_s)		$T_u + T_g$		
Frame duration (T_f)		$T_s \times 204$		
FFT samples (F_s)		$256 (N_s = 1)$ $512 (N_s = 3)$	$512 (N_s = 1)$ $1024 (N_s = 3)$	$1024 (N_s = 1)$ $2048 (N_s = 3)$
FFT sample clock (F_{sc}) (MHz)		$F_{sc} = F_s/T_u$		
Inner code		Convolutional code (Coding rate = $1/2, 2/3, 3/4, 5/6, 7/8$) (Mother code = $1/2$)		
Outer code		(204,188) RS code		
Time interleave parameter (I)		0, 4, 8, 16, 32	0, 2, 4, 8, 16	0, 1, 2, 4, 8
Length of time interleaving		$I \times 95 \times T_s$		

FFT: fast Fourier transform.

- (1) The ISDB-T_{SB} system uses 1 or 3 segments for sound services, while any number of segments may be used for other services such as television services. (Compare with System C of Recommendation ITU-R BT.1306.)
- (2) SP (scattered pilot), and CP (continual pilot) can be used for frequency synchronization and channel estimation. The number of CP includes CPs on all segments and a CP for higher edge of whole bandwidth.
- (3) TMCC carries information on transmission parameters.
- (4) AC (auxiliary channel) carries ancillary information for network operation.

1.4.3 Source coding

The multiplex structure of the ISDB-T_{SB} system is fully compliant with MPEG-2 systems architecture, therefore MPEG-2 transport stream packets (TSPs) containing compressed digital audio signal can be transmitted. Digital audio compression methods such as MPEG-2 Layer II audio specified in ISO/IEC 13818-3, AC-3 (Digital Audio Compression Standard specified in ATSC Document A/52) and MPEG-2 AAC specified in ISO/IEC 13818-7 can be applied to the ISDB-T_{SB} system.

1.4.4 Multiplexing

The multiplex of the ISDB-T_{SB} system is compatible with MPEG-2 TS ISO/IEC 13818-1. In addition, multiplex frame and TMCC descriptors are defined for hierarchical transmission with single TS.

Considering maximum interoperability among a number of digital broadcasting systems, e.g. ISDB-S recommended in Recommendation ITU-R BO.1408, ISDB-T recommended in Recommendation ITU-R BT.1306 (System C) and broadcasting-satellite service (sound) system using the 2.6 GHz band recommended in Recommendation ITU-R BO.1130 (System E), these systems can exchange broadcasting data streams with other broadcasting systems through this interface.

1.4.4.1 Multiplex frame

To achieve hierarchical transmission using the BST-OFDM scheme, the ISDB-T_{SB} system defines a multiplex frame of TS within the scope of MPEG-2 systems. In the multiplex frame, the TS is a continual stream of 204-byte RS-TSP composed of 188-byte TSP and 16 bytes of null data or RS parity.

The duration of the multiplex frame is adjusted to that of the OFDM frame by counting RS-TSPs using a clock that is two times faster than the inverse FFT (IFFT) sampling clock in the case of single-segment transmission. In the case of the triple-segment transmission the duration of the multiplex frame is adjusted to that of the OFDM frame by counting RS-TSPs using a clock that is four times faster than the IFFT sampling clock.

1.4.5 Channel coding

This section describes the channel coding block, which receives the packets arranged in the multiplex frame and passes the channel-coded blocks forward to the OFDM modulation block.

1.4.5.1 Functional block diagram of channel coding

Figure 15 shows the functional block diagram of channel coding of the ISDB-T_{SB} system.

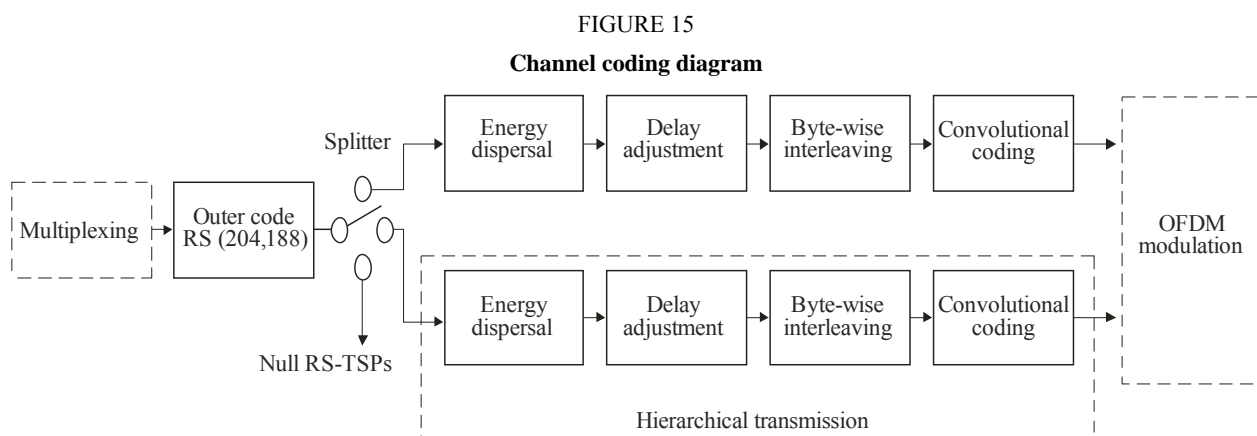

Report BT.2140-15

The duration of the multiplex frame coincides with the OFDM frame by counting the bytes in the multiplex frame using a faster clock than IFFT-sampling rate described in the previous section.

At the interface between the multiplex block and the outer coding block, the head byte of the multiplex frame (corresponding to the sync-byte of TSP) is regarded as the head byte of the OFDM frame. In bit-wise description, the most significant bit of the head byte is regarded as the synchronization bit of OFDM frame.

For the triple-segment layered transmission, the RS-TSP stream is divided into two layers in accordance with the transmission-control information. In each layer, coding rate of the inner error correction code, carrier-modulation scheme, and time-interleaving length can be specified independently.

1.4.5.2 Outer coding

RS (204,188) shortened code is applied to each MPEG-2 TSP to generate an error protected TSP that is RS-TSP. The RS (208,188) code can correct up to eight random erroneous bytes in a received 204-byte word.

Field generator polynomial: $p(x) = x^8 + x^4 + x^3 + x^2 + 1$

Code generator polynomial: $g(x) = (x - \lambda^0)(x - \lambda^1)(x - \lambda^2)(x - \lambda^3) \cdots (x - \lambda^{15})$

where $\lambda = 02_h$.

It should be noted that null TSPs from the multiplexer are also coded to RS (204,188) packets.

MPEG-2 TSP and RS-TSP (RS error protected TSP) are shown in Fig. 16. RS error protected TSP is also called transmission TSP.

FIGURE 16
MPEG-2 TSP and RS-TSP (transmission TSP)

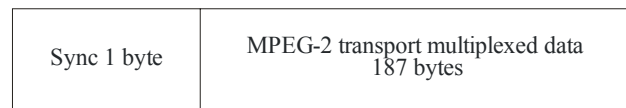

a) MPEG-2 TSP



b) RS-TSP (transmission TSP), RS (204,188) error protected TSP

Report BT.2140-16

1.4.5.3 Energy dispersal

In order to ensure adequate binary transitions, the data from the splitter is randomized with pseudo-random binary sequence (PRBS).

The polynomial for the PRBS generator shall be:

$$g(x) = x^{15} + x^{14} + 1$$

1.4.6 Delay adjustment

In the byte-wise interleaving, the delay caused in the interleaving process differs from stream to stream of different layer depending on its properties (i.e. modulation and channel coding). In order to compensate for the delay difference including de-interleaving in the receiver, the delay adjustment is carried out prior to the byte-wise interleaving on the transmission side.

1.4.6.1 Byte-wise interleaving (inter-code interleaving)

Convolutional byte-wise interleaving with length of $I = 12$ is applied to the 204-byte error protected and randomized packets. The interleaving may be composed of $I = 12$ branches, cyclically connected to the input byte-stream by the input switch. Each branch j shall be a first-in first-out

(FIFO) shift register, with length of $j \times 17$ bytes. The cells of the FIFO shall contain 1 byte, and the input and output switches shall be synchronized.

The de-interleaving is similar, in principle, to the interleaving, but the branch indices are reversed. Total delay caused by interleaving and de-interleaving is $17 \times 11 \times 12$ bytes (corresponding to 11 TSPs).

1.4.6.2 Inner coding (convolutional codes)

The ISDB-T_{SB} system shall allow for a range of punctured convolutional codes, based on a mother convolutional code of rate 1/2 with 64 states. Coding rates of the codes are 1/2, 2/3, 3/4, 5/6 and 7/8. This will allow selection of the most appropriate property of error correction for a given service or data rate in the ISDB-T_{SB} services including mobile services. The generator polynomials of the mother code are $G_1 = 171_{\text{oct}}$ for X output and $G_2 = 133_{\text{oct}}$ for Y output.

1.4.7 Modulation

Configuration of the modulation block is shown in Figs 17 and 18. After bit-wise interleaving, data of each layer are mapped to the complex domain.

1.4.7.1 Delay adjustment for bit interleave

Bit interleave causes the delay of 120 complex data ($I + jQ$) as described in the next section. By adding proper delay, total delay in transmitter and receiver is adjusted to the amount of two OFDM symbols.

1.4.7.2 Bit interleaving and mapping

One of the carrier modulation schemes among DQPSK, QPSK, 16-QAM and 64-QAM is selectable for this System. The serial bit-sequence at the output of the inner coder is converted into a 2-bit parallel sequence to undergo $\pi/4$ -shift DQPSK mapping or QPSK mapping, by which n bits of I-axis and Q-axis data are delivered. The number n may depend on the hardware implementation. In the case of 16-QAM, the sequence is converted into a 4-bit parallel sequence. In 64-QAM, it is converted into a 6-bit parallel sequence. After the serial-to-parallel conversion, bit-interleaving is carried out by inserting maximum 120-bit delay.

1.4.7.3 Data segment

Data segment is defined as a table of addresses for complex data, on which rate conversion, time interleaving, and frequency interleaving shall be executed. The data segment corresponds to the data portion of OFDM segment.

1.4.7.4 Synthesis of layer-data streams

After being channel-coded and mapped, complex data of each layer are inputted every one symbol to pre-assigned data-segments.

The data stored in all data segments are cyclically read with the IFFT-sample clock; then rate conversions and synthesis of layer data streams are carried out.

FIGURE 17
Modulation block diagram

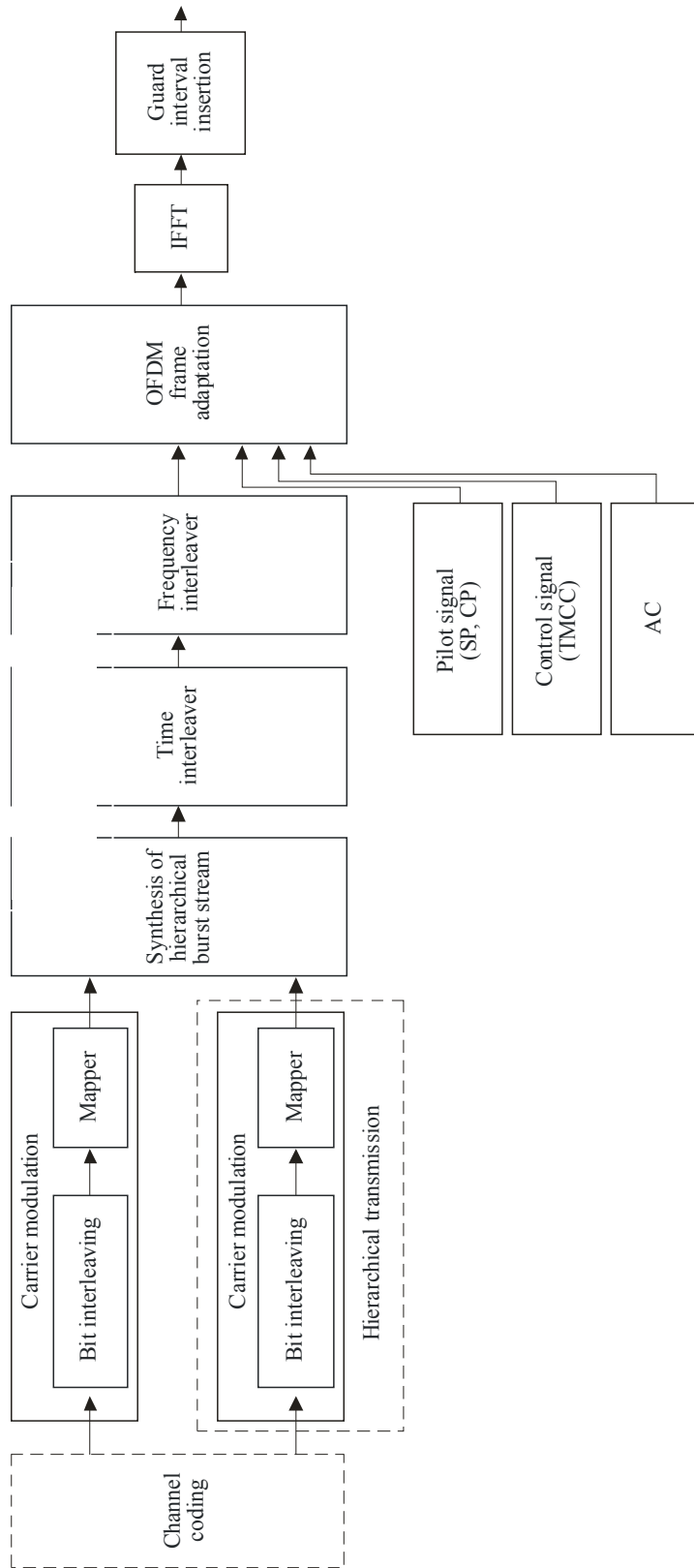

Report ITU-R BT.2140-17

FIGURE 18

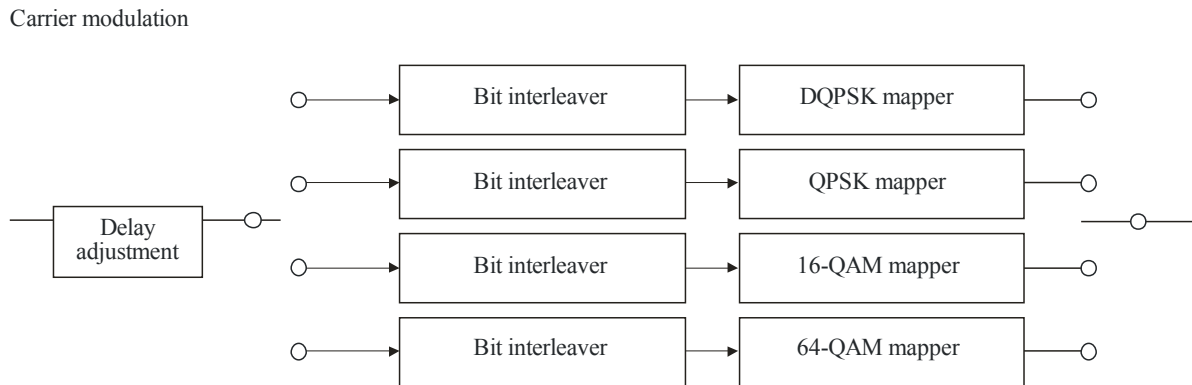
Configuration of carrier modulation block

Report BT.2140-18

1.4.7.5 Time interleaving

After synthesis, symbol-wise time interleaving is carried out. The length of time-interleaving is changeable from 0 to approximately 1 s, and shall be specified for each layer.

1.4.7.6 Frequency interleaving

Frequency interleaving consists of inter-segment frequency interleaving, intra-segment carrier rotation, and intra-segment carrier randomization. Inter-segment frequency interleaving is taken among the segments having the same modulation scheme. Inter-segment frequency interleaving can be carried out only for triple-segment transmission. After carrier rotation, carrier randomization is performed depending on the randomization table.

1.4.7.7 OFDM segment-frame structure

Data segments are arranged into OFDM segment-frame every 204 symbols by adding pilots such as CP, SP, TMCC and AC. The modulation phase of CP is fixed at every OFDM symbol. SP is inserted in every 12 carriers and in every 4 OFDM symbols in the case of coherent modulation method. The TMCC carrier carries transmission parameters such as carrier modulation, coding rate and time interleaving for the receiver control. The AC carrier carries the ancillary information.

1.5 ATSC**1.5.1 Overview of the ATSC digital television system**

The ATSC digital television (DTV) standard ushered in a new era in television broadcasting. The impact of DTV is more significant than simply moving from an analog system to a digital system. Rather, DTV permits a level of flexibility wholly unattainable with analog broadcasting. The ATSC Digital Television Standard describes a system designed to transmit high quality video and audio and ancillary data within a single 6 MHz terrestrial television broadcast channel. The design emphasis on quality resulted in the advent of digital HDTV and multichannel surround-sound. The ATSC system pioneered a layered architecture that separates picture formats, compression coding, data transport and digital transmission as shown in Fig. 19.

FIGURE 19

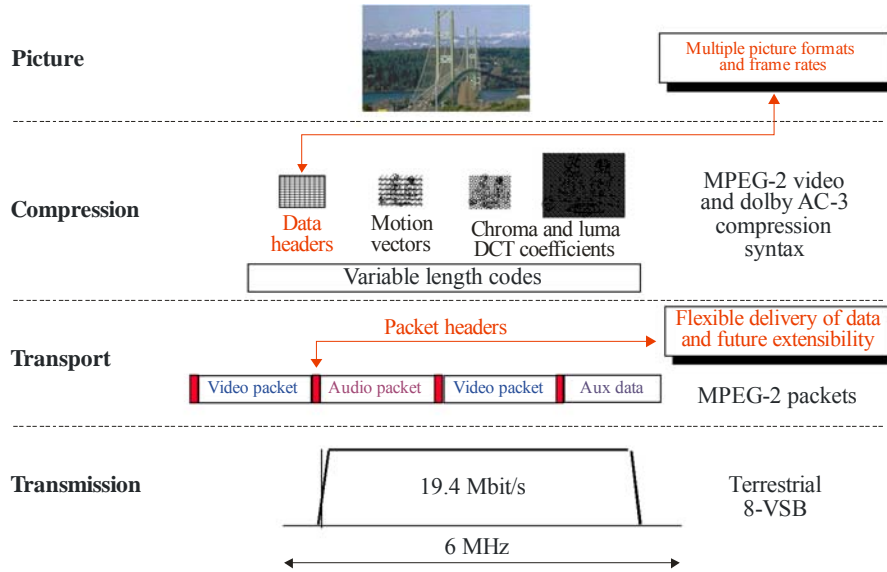

Report BT.2140-19

A block diagram of the system is provided in Fig. 20.

FIGURE 20

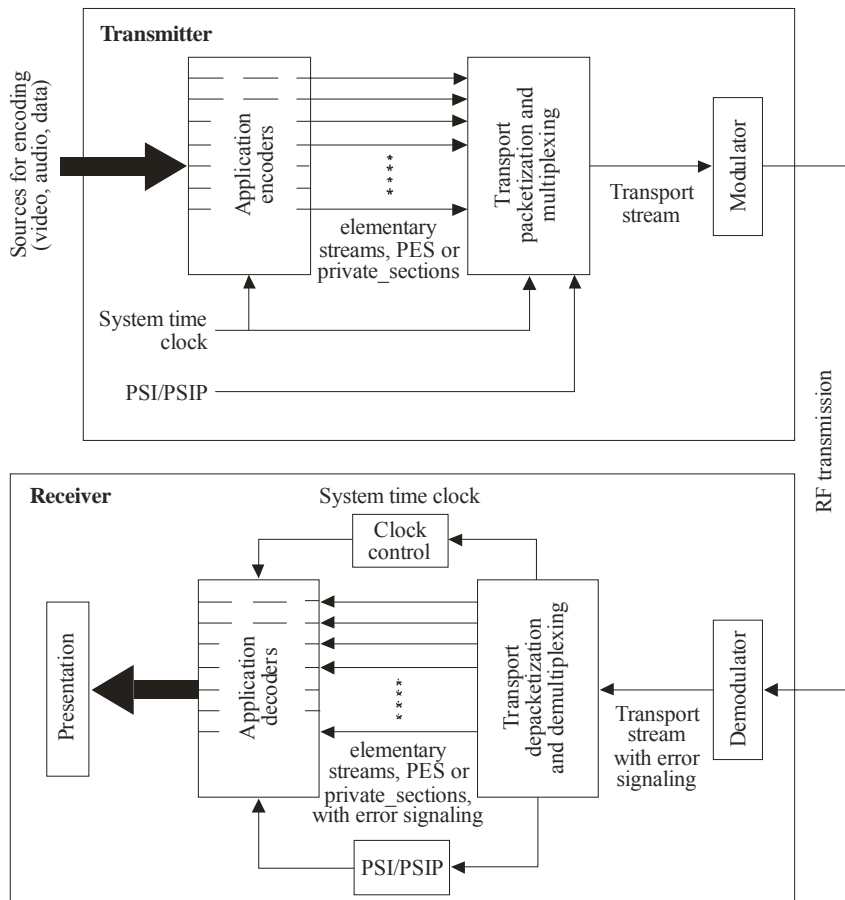

Note 1 – PSIP refers to ATSC standard (A/65) which was developed subsequent to ATSC standards (A/52), (A/53) and to this guide. For details regarding PSIP refer to ATSC standard (A/65).

Report BT.2140-20

1.5.1.1 Video formats

The source video formats for the ATSC standard were carefully selected for their interoperability characteristics with film (wide aspect ratio and 24 fps), computers (square pixels and progressive scanning), and legacy television systems (480 lines and ITU-601 sampling), as illustrated in Fig. 7. In addition, the HDTV formats and the square pixel SDTV format are related by simple 3:2 ratios, allowing high quality, yet economical conversion among these formats. ATSC system.

1.5.1.2 Video compression

The ATSC DTV Standard specifies the MPEG-2 video stream syntax (Main Profile at High Level) for the coding of video. The ATSC DTV Standard defines the video formats for HDTV and SDTV (Table 7).

TABLE 7
Digital Television Standard Video Formats(1)

Vertical lines	Pixels	Aspect ratio	Picture rate
1 080	1 920	16:9	60I, 30P, 24P
720	1 280	16:9	60P, 30P, 24P
480	704	16:9 and 4:3	60P, 60I, 30P, 24P
480	640	4:3	60P, 60I, 30P, 24P

⁽¹⁾ Note that both 60.00 Hz and 59.94 ($60 \times 1\,000/1\,001$) Hz picture rates are allowed. Dual rates are allowed also at the picture rates of 30 Hz and 24 Hz.

ATSC consumer receivers are designed to decode all HDTV and SDTV streams providing program service providers with maximum flexibility.

ATSC also provides the ability to utilize advanced video coding (AVC) within an ATSC DTV transmission. Part 1 of ATSC A/72, “Video System and Characteristics of AVC in the ATSC Digital Television System” and Part 2 “AVC Video Transport Subsystem Characteristics”. The standard details the methodology to utilize Advanced Video Coding (AVC) within an ATSC DTV transmission. AVC which was developed by the ITU-T Video Coding Experts Group together with the ISO/IEC Moving Picture Experts Group is also known as H.264 and MPEG-4 Part 10. The A/72 Standard defines constraints with respect to AVC, compression format restraints, low delay and still picture modes, and bit stream specifications.

1.5.1.3 Audio compression

The ATSC DTV Standard utilizes “Digital Audio Compression (AC-3)” for the coding of audio as based upon the ATSC A/52 Standard.

1.5.1.4 Transport

Transport defines the methodology of dividing each bit stream into “packets” of information. The ATSC system employs the MPEG-2 transport stream syntax for the packetization and multiplexing of video, audio, and data signals for digital broadcasting systems.

The ATSC A/65 Program and System Information Protocol (PSIP) describes the information at the system and event levels for all virtual channels (channel numbers are not tied directly to the actual RF channel frequency) carried in a particular TS. Additionally, information for analog channels as well as digital channels from other Transport Streams may be incorporated.

There are two main categories of information in the ATSC PSIP Standard (A65), system information and program data. System information allows navigation and access of the channels within the DTV transport stream, and the program data provides necessary information for efficient browsing and event selection. Some tables announce future events and some are used to locate the digital streams that make up an event. The PSIP data are carried via a collection of hierarchically arranged tables, repeated in the packet stream at frequent intervals.

1.5.1.5 RF Transmission

“RF Transmission” refers to channel coding and modulation. The channel coder takes the packetized digital bit stream, reformats it and adds additional information that assists the receiver in extracting the original data from the received signal, which due to transmission impairments may contain errors. In order to protect against both burst and random errors, the packet data is interleaved before transmission and Reed-Solomon forward error correcting codes are added. The modulation (or physical layer) uses the digital bit stream information to modulate a carrier for the transmitted signal. The basic modulation system offers two modes: an 8-VSB mode and a 16-VSB mode. The 8-VSB mode was designed for spectral efficiency, maximizing the data throughput with a low receiver carrier-to-noise (C/N) threshold requirement, high immunity to both co channel and adjacent channel interference, and high robustness to transmission errors. The attributes of 8-VSB allow DTV channels to co-exist in a crowded spectrum environment that contains both analog and digital television signals. In addition, the lower power requirements (typically, 12 dB lower than analog NTSC) of 8-VSB allow ATSC DTV stations to exist on channels where analog stations cannot due to interference constraints. The spectral efficiency and power requirement characteristics of 8-VSB are essential to the conversion of terrestrial broadcast transmission from analog to digital since new spectrum is not allotted during the transition phase.

1.5.2 ATSC-M/H system overview

The ATSC Mobile/Handheld service (M/H) shares the same RF channel as a standard ATSC broadcast service described in ATSC A/53. M/H is enabled by using a portion of the total available 19.4 Mbit/s bandwidth and utilizing delivery over IP transport. A block diagram representation of the broadcast system is shown in Fig. 21.

FIGURE 21
ATSC-M/H broadcast protocol stack

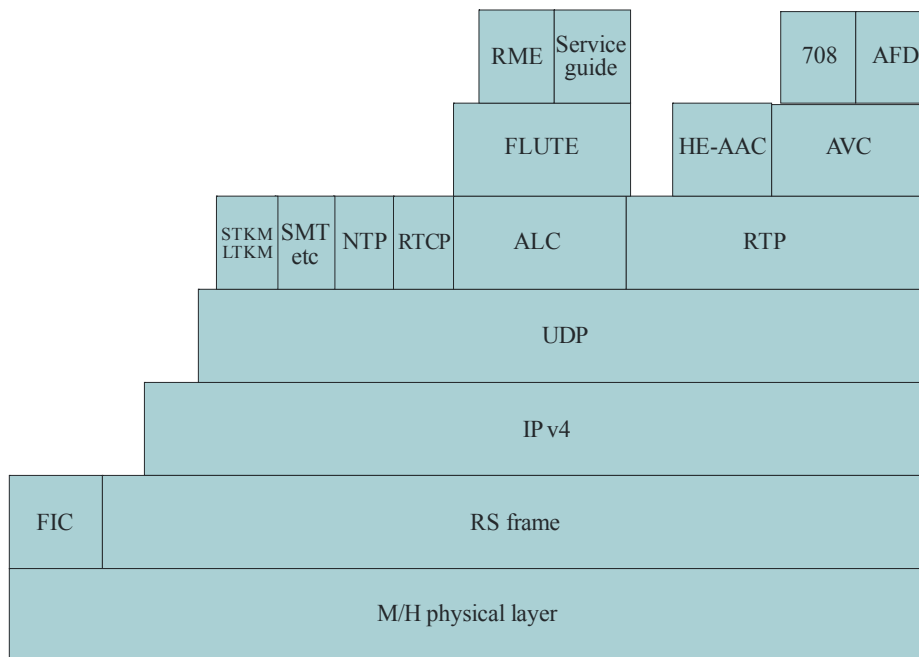

Report BT.2140-21

Central to the M/H system are additions to the physical layer of the ATSC transmission system that are easily decodable under high Doppler rate conditions. Extra training sequences and forward error correction (FEC) are added to assist reception of the enhanced stream(s). Consideration has also been given to the many system details that make such a signal compatible with legacy ATSC receivers, particularly audio decoder buffer constraints; but also such constraints as MPEG transport packet header standards, requirements for legacy PSIP carriage, etc. These changes do not alter the emitted spectral characteristics. The ATSC-M/H system broadcast protocol stack is illustrated in Fig. 21.

1.5.2.1 Description of A/153 Parts

The following sections provide an over view of the Parts that make up the ATSC-M/H system.

1.5.2.1.1 Part 2 – RF/ Transmission

M/H data is partitioned into Ensembles, each of which contains one or more services. Each Ensemble uses an independent RS Frame (an FEC structure), and furthermore, each Ensemble may be coded to a different level of error protection depending on the application. M/H encoding includes FEC at both the packet and trellis levels, plus the insertion of long and regularly spaced training sequences into the M/H data. Robust and reliable control data is also inserted for use by M/H receivers. The M/H system provides bursted transmission of the M/H data, which allows the M/H receiver to cycle power in the tuner and demodulator for energy saving.

1.5.2.1.2 Part 3 – Service Multiplex and Transport Subsystem

In the ATSC-M/H physical layer system, the M/H data is transferred by a time-slicing mechanism to improve the receiver's power management capacity. Each M/H Frame time interval is divided into 5 sub-intervals of equal length, called M/H Subframes. Each M/H Subframe is in turn divided into 4 sub-divisions of length 48.4 ms, the time it takes to transmit one VSB frame. These VSB frame time intervals are in turn divided into 4 M/H Slots each (for a total of 16 M/H Slots in each M/H Subframe).

The M/H data to be transmitted is packaged into a set of consecutive RS Frames, where this set of RS Frames logically forms an M/H Ensemble. The data from each RS Frame to be transmitted during a single M/H Frame is split up into chunks called M/H Groups, and the M/H Groups are organized into M/H Parades, where an M/H Parade carries the M/H Groups from up to two RS Frames but not less than one. The number of M/H Groups belonging to an M/H Parade is always a multiple of 5, and the M/H Groups in the M/H Parade go into M/H Slots that are equally divided among the M/H Subframes of the M/H Frame.

The RS Frame is the basic data delivery unit, into which the IP datagrams are encapsulated. While an M/H Parade always carries a Primary RS Frame, it may carry an additional Secondary RS Frame as output of the baseband process. The number of RS Frames and the size of each RS Frame are determined by the transmission mode of the M/H physical layer subsystem. Typically, the size of the Primary RS Frame is bigger than the size of Secondary RS Frame, when they are carried in one M/H Parade.

The Fast Information Channel (FIC) is a separate data channel from the data channel delivered through RS Frames. The main purpose of the FIC is to efficiently deliver essential information for rapid M/H Service acquisition. This information primarily includes binding information between M/H Services and the M/H Ensembles carrying them, plus version information for the M/H Service Signaling Channel of each M/H Ensemble.

In ATSC-M/H, an “M/H Service” is similar in general concept to a virtual channel as defined in ATSC A/65C [10]. An M/H Service is a package of IP streams transmitted through M/H Multiplex, which forms a sequence of programs under the control of a broadcaster which can be broadcast as part of a schedule. Typical examples of M/H Services include TV services and audio services. Collections of M/H Services are structured into M/H Ensembles, each of which consists of a set of consecutive RS Frames.

In general, there are two types of files that might be delivered using the methods described in this standard. The first of these is content files, such as music or video files. The second type of file that may be transmitted is a portion of the service guide. This includes long- and short-term keys for service protection, logos, and SDP files. In either case, the delivery mechanisms are the same and it is up to the terminal to resolve the purpose of the files.

1.5.2.1.3 Part 4 – Announcement

In an M/H system, the Services available on that system (or another system) are announced via the Announcement subsystem. Services are announced using a Service Guide. A Service Guide is a special M/H Service that is declared in the Service Signaling subsystem. An M/H receiver determines available Service Guides by reading the Guide Access Table for M/H (GAT-MH). This table lists the Service Guides present in the M/H broadcast, gives information about the service provider for each guide, and gives access information for each guide.

The ATSC-M/H Service Guide is an OMA BCAST Service Guide, with constraints and extensions as specified in this standard. A Service Guide is delivered using one or more IP streams. The main stream delivers the Announcement Channel, and zero or more streams are used to deliver the guide data. If separate streams are not provided, guide data is carried in the Announcement Channel stream.

1.5.2.1.4 Part 5 – Application Framework

The primary objective for the M/H platform is to deliver a set of audio and/or video services from a transmission site to mobile or portable devices. The Application Framework for enables the broadcaster of the audio-visual service to author supplemental content to define and control various additional elements to be used in conjunction with the M/H audio-visual service. It enables one to define auxiliary (graphical) components, layout for the service, transitions between layouts and

composition of audio-visual components with auxiliary data components. Furthermore, it enables the broadcaster to send remote events to modify the presentation and to control presentation timeline. The Application Framework further enables coherent rendering of the service and its layout over a variety of device classes and platforms, rendering of action buttons and input fields, and event handling and scripting associated with such buttons and fields.

1.5.2.1.5 Part 6 – Service Protection

Service Protection refers to the protection of content, be that files or streams, during its delivery to a receiver. Service Protection assumes no responsibility for content after it has been delivered to the receiver. It is intended for subscription management. It is an access control mechanism, only.

The ATSC-M/H Service Protection system is based on the OMA BCAST DRM Profile. It consists of the following components:

- Key provisioning.
- Layer 1 registration.
- Long-Term Key Message (LTKM), including the use of Broadcast Rights Objects (BCROs) to deliver LTKMs.
- Short-Term Key Messages (STKM).
- Traffic encryption.

The system relies on the following encryption standards:

- Advanced Encryption Standard (AES).
- Secure Internet Protocol (IPsec).
- Traffic Encryption Key (TEK).

In the OMA BCAST DRM Profile there are two modes for Service Protection—interactive and broadcast-only mode. In interactive mode, the receiver supports an interaction channel to communicate with a service provider, to receive Service and/or Content Protection rights. In broadcast-only mode, the receiver does not use an interaction channel to communicate with a service provider. Requests are made by the user through some out-of-band mechanism to the service provider, such as calling a service provider phone number or accessing the service provider website.

1.5.2.1.6 Part 7 – AVC and SVC Video System

The M/H system uses MPEG-4 AVC and SVC video coding as described in ISO/IEC 14496 Part 10, with certain constraints.

1.5.2.1.7 Part 8 – HE AAC Audio System

The M/H system uses MPEG-4 HE AAC v2 audio coding as described in ISO/IEC 14496 Part 3, with certain constraints. HE AAC v2 is used to code mono or stereo audio. HE AAC v2 is the combination of three audio coding tools, MPEG-4 AAC, Spectral Band Replication (SBR) and Parametric Stereo (PS).

1.5.3 System configuration signaling

Recognizing that the mobile sector of the economy is subject to rapid technology change, the needs for continued viability of the system in the face of change were formalized. As there are many technological elements of the system, they were grouped into functional units called elementary subsystems.

1.6 DVB-T

1.6.1 DVB-T variants

The DVB-T standard allows for different levels of modulation and different code rates to be used to trade bit rate versus ruggedness. As some variants can be selected as representative of the much larger set of all variants, it will be necessary to select such a sub-set for the planning Conference. This sub-set is useful to avoid too many options that would otherwise need to be displayed.

The non-hierarchical variants are chosen as being typical of some expressed requirements and are close to others; for the DVB-T example, it is to be expected that channel requirements for a variant with a code rate of 2/3 will be similar to those for a variant with a code rate of 3/4, for the same modulation.

A2: QPSK, 2/3: this variant provides a low data capacity of only 6 to 8 Mbit/s but it does provide a very rugged service.

B2: 16-QAM, 2/3: the data capacity is moderate at 13 Mbit/s to 16 Mbit/s and this variant may be of interest for providing reasonably rugged services especially for portable or mobile reception.

C2: 64-QAM, 2/3: this variant has a high data capacity, 20 Mbit/s to 24 Mbit/s but provides less rugged services and is particularly sensitive to self-interference effects in large area SFNs.

1.6.2 Hierarchical variant

Hierarchical DVB-T system variants mean that the MPEG-2 bit stream is divided into two parts: the high priority stream and the low priority stream. The high priority stream is the rugged part of the hierarchical system and uses QPSK modulation and an appropriate code rate to provide the necessary protection against noise and interference. Because of the type of modulation, the data capacity is low (about 5 to 6 Mbit/s). However, the *C/I* ratio is worse than that for a non-hierarchical QPSK system although the data capacity is the same as that of a QPSK system of the same code rate.

The low priority stream is the more fragile part of the hierarchical system and may be either 16-QAM or 64-QAM. Not much consideration has been given to a low priority stream using 16-QAM because the data capacity of the low priority stream is about the same as that of the high priority stream. A low priority stream using 64-QAM provides about twice the capacity of the high priority QPSK stream. Its exact capacity relative to that of the high priority stream depends on the relative code rate of the two streams.

The hierarchical system variants could be used in several ways. One example would be for a combination of fixed and mobile services in the same area, where the high priority stream gives robust mobile coverage and the low priority stream provides fixed antenna reception.

1.6.3 Guard interval

OFDM, as used in DVB-T, exhibits relatively long symbol periods due to its multi-carrier nature. This long symbol period provides a degree of protection against inter-symbol interference caused by multipath propagation. This protection can, however, be greatly enhanced by use of a guard interval. The guard interval is a cyclic extension of the symbol. In simplistic terms, a section of the start of the symbol is simply added to the end of the symbol.

For MFNs, small guard intervals are used while for SFNs, larger guard intervals are required. There is a trade-off between the length of the guard interval and the data capacity. For a given DVB-T variant, a larger guard interval length implies a lower data capacity.

1.6.4 DVB-T in Band III

There are indications that the use of Band III (174-230 MHz) is being considered for DVB-T in some countries. Band III propagation is particularly suitable for portable and mobile reception, because of the uniform field strength distribution that can be achieved in that band, together with the possibility of achieving large area coverage with lower power than would be needed using UHF frequencies. However, in some parts of the planning area (eastern Mediterranean area and Gulf area) the situation is different due to propagation anomalies such as ducting and super-refraction.

A challenge to be faced within Band III is the existence of several channelling arrangements, including the use of 7 MHz and 8 MHz bandwidth channels. Any possible move to a uniform channel raster presents a long-term challenge due to the existing complex non-uniform situation.

The following advantages have led to an increased interest in DVB-T in VHF Band III:

- coverage for large areas is achieved with fewer transmitters than are required at UHF;
- mobile reception (reduction of Doppler effect).

At VHF, propagation conditions are different from UHF; therefore suitable networks may also be different. Furthermore the Doppler shift for mobile reception is less at VHF than at UHF due to the lower frequencies. This is a clear advantage for VHF when administrations consider deploying mobile DVB-T.

1.7 DVB-H

1.7.1 Building and validating an open and scalable network architecture

The interworking points between the different domains and actors will also be identified with the objective of defining interworking units whenever required. System engineering rules will be articulated in order to cope with scalability issues. This in particular requires identifying the parameters that are key when scaling up the system. This is crucial to allow the successful progressive introduction of open systems with distributed management functions.

Field trials that include testing of an open operational architecture composed of several broadcast cells will give final input on the viability of the overall system. The novelty will consist in having an open demonstrator addressing the complete/commercial-like architecture. Roaming will be tested between different partner's sites, for instance. Feedback from a panel of users will determine whether the services have sufficiently user-friendly interfaces and will qualify the technical and commercial viability of the services.

Technology development in the project is articulated around three domains that intend to make particularly innovative contributions on:

- content, services and applications;
- user devices;
- networks.

1.7.2 Content, services and applications

The business motivation in this area is to increase content/service creation productivity because of the increasingly diverse means of accessing services in terms of networks and terminals. This productivity is enhanced only at the expense of making common as many steps as possible in the content/service creation process.

In content generation and production, the migration from the more or less autonomous production workflows of separate departments to workflows where content is created in a multitude of formats to be transmitted via a number of platforms and channels to different terminals will be planned.

Content will be produced, generated and edited from a number of sources. A central server architecture connected to a content management system will be implemented allowing for quick, cost-efficient and automated content editing. A mechanism will be established for ensuring that user privacy and security is kept in a common digital environment.

1.7.3 User devices

The main user-device-related objective is to pave the way for the commercial introduction of end-user devices able to provide intuitive access to mobile/portable broadcast and broadband services in collaborating networks. The Europe 2005 action plan recognizes that the development of such terminals is crucial to social inclusion.

1.7.4 Networks

Assuming that national regulations will evolve according to EC recommendations, the opportunity exists to deploy new networks specifically targeting broadcast-based mobile and indoor reception, with better geographical granularity (i.e. smaller cells). This will lead to the definition and field validation of deployment rules for a cellularized DVB-T/H system. Because of the potential co-location of low power DVB-T/H transmitters with 2G/3G base stations, co-existence rules will be defined, depending on the identified interference scenarios.

Digital Video Broadcasting Handheld (DVB-H) is a new standard for digital terrestrial TV broadcasting to handheld portable/mobile terminals.

It has been standardized in 2004 by ETSI EN 302 304: “Digital Video Broadcasting (DVB); Transmission System for Handheld Terminals” (DVB H).

The introduction of DVB-H implied to modify slightly few DVB standards. DVB-T has been improved with the introduction of a 4 K carriers mode, a depth interleaver, new time stamps (TPS) and a 5 MHz RF bandwidth. Some people are thinking to introduce 1, 5, 3 and 4,5 MHz RF bandwidth in order to fit with the frequency grid in the L band in Regions 1 and 3 (RRC). 5 MHz RF channel is used in USA in the L band.

FIGURE 22
DVB-H standards family

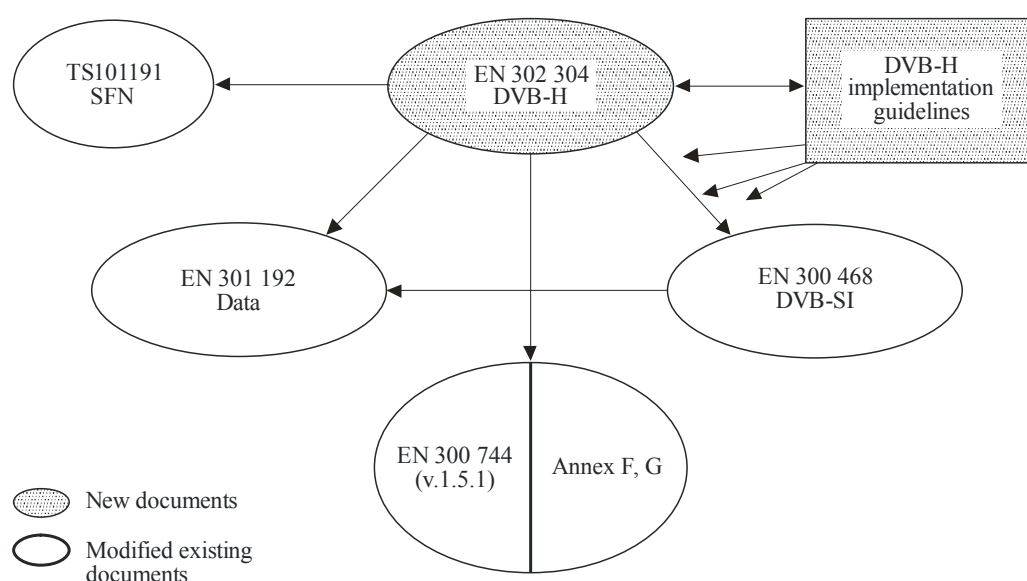

The main objective is to deliver various content (video and audio) compressed with MPEG-4 encapsulated in IP bursts. One of the main challenges was to reduce the power consumption of the handheld devices (mobile phones, PDA or portable PC) and to allow the reception in various conditions.

In the future, it could be large power transmitter in order to cover a great number of users at once (one to many) with a dedicated format of content and even to be able to deliver interactive services in small cells with low power transmitters compatible with GSM or UMTS cells.

There are two options in term of frequency usage:

- UHF for large coverage areas, from one DVB-H service up to a full channel filled with DVB-H services (see figure hereafter which shows a DVB-T service + several DVB-H services in the same channel. The DVB-T transport stream (service 4) has a constant bitrate the other services (1, 2 and 3) are DVB-H IP bursts).
- L bands for small coverage areas with full channel filled with DVB-H services.

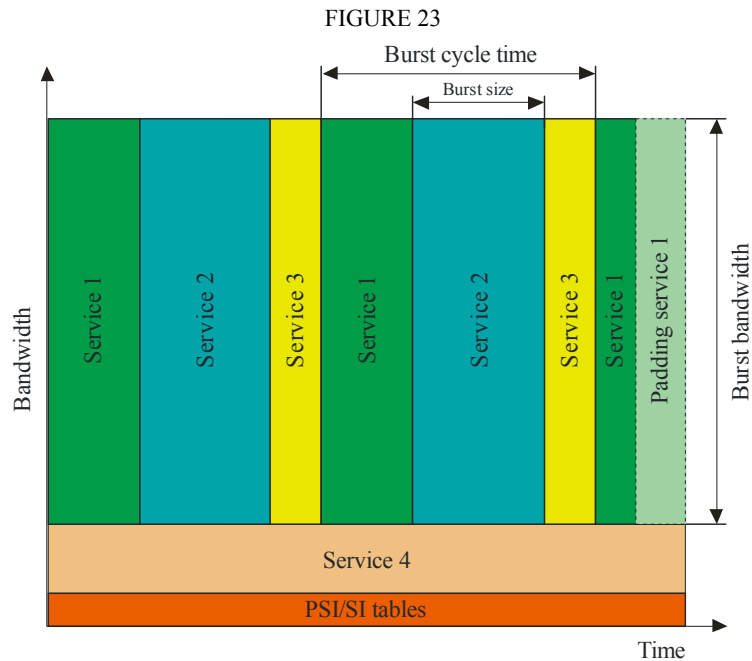

Report BT.2140-23

In one 8 MHz channel, it is possible to broadcast up to 50 different programmes with an average of 400 kbit/s MPEG4 streams.

The definition of the image is fitting with the size of the display of the handheld device which means (CIF or QVGA).

DVB-H benefits of the advantages of OFDM modulation scheme combined with IP slicing.

In term of usage, DVB-H is a relevant example of converging technology: convergence between broadcasting and telecommunication. However, the introduction of that technology has to be managed carefully in term of frequency allocation and/or sharing.

1.8 ISDB-T

1.8.1 ISDB-T transmission parameters

ISDB-T consists of 13 OFDM segments. One OFDM segment corresponds to a frequency spectrum having a bandwidth of $B/14$ MHz (B means the bandwidth of a terrestrial TV channel: 6, 7 or 8 MHz), so one segment occupies bandwidth $6/14$ MHz (428.57 kHz), $7/14$ MHz (500 kHz) or $8/14$ MHz (571.29 kHz). Television broadcasting employs 13 segments with a transmission bandwidth of about 5.6 MHz, 6.5 MHz or 7.4 MHz.

ISDB-T has three transmission modes having different carrier intervals in order to deal with a variety of conditions such as the variable guard interval as determined by the network configuration and the Doppler shift occurring in mobile reception. In Mode 1, one segment consists of 108 carriers, while Modes 2 and 3 feature two times and four times that number of carriers, respectively. Table 8 lists the basic parameters of each mode in ISDB-T system.

A digital signal is transmitted in sets of symbols. The active symbol duration is the reciprocal of the carrier spacing – this condition prevents carriers in the band from interfering with each other. The guard interval is a time-redundant section of information that adds a copy of the latter portion of a symbol to the symbol's "front porch" with the aim of absorbing interference from multi-path-delayed waves. Accordingly, increasing the guard-interval duration in the signal decreases the information bit rate. An OFDM frame consists of 204 symbols with guard intervals attached regardless of the transmission mode. The time interleaving duration in real time depends on the parameters set at the digital-signal stage and on the guard-interval duration, and consequently the values shown in Table 9 for these parameters are approximate.

The error-correction scheme uses concatenated codes, namely, Reed-Solomon (204,188) code for the outer code and convolutional code for the inner code. The information bit rate takes on various values depending on the selected modulation scheme, inner-code coding rate, and guard-interval ratio. The range shown in Table 8 reflects the minimum and maximum values for 13 segments.

TABLE 8

Basic parameter of ISDB-T system

Transmission parameter	Mode 1	Mode 2	Mode 3
Number of segments	13		
Bandwidth	5.57 MHz (6M*) 6.50 MHz (7M*) 7.43 MHz (8M*)	5.57 MHz (6M*) 6.50 MHz (7M*) 7.43 MHz (8M*)	5.57 MHz (6M*) 6.50 MHz (7M*) 7.43 MHz (8M*)
Carrier spacing	3.968 kHz (6M*) 4.629 kHz (7M*) 5.271 kHz (8M*)	1.948 kHz (6M*) 2.361 kHz (7M*) 2.645 kHz (8M*)	0.992 kHz (6M*) 1.157 kHz (7M*) 1.322 kHz (8M*)
Number of carriers	1405	2809	5617
Active symbol duration	252 μ s (6M*) 216 μ s (7M*) 189 μ s (8M*)	504 μ s (6M*) 432 μ s (7M*) 378 μ s (8M*)	1008 μ s (6M*) 864 μ s (7M*) 756 μ s (8M*)
Guard interval duration	1/4, 1/8, 1/16, 1/32 of active symbol duration		
Carrier modulation	QPSK, 16-QAM, 64-QAM, DQPSK		
Number of symbols per frame	204		
Time interleaving duration	0, 0.1s, 0.2s, 0.4s		
Inner code	Convolutional coding (1/2, 2/3, 3/4, 5/6, 7/8)		

TABLE 8 (*end*)

Transmission parameter	Mode 1	Mode 2	Mode 3
Outer code	RS(204,188)		
Information bit rate	3.65-23.2 Mbit/s (6M*) 4.26-27.1 Mbit/s (7M*) 4.87-31.0 Mbit/s (8M*)		
Hierarchical transmission	Maximum 3 levels (Layer A, B, C)		

* Bandwidth of a terrestrial TV channel.

1.8.2 Hierarchical transmission

A mixture of fixed-reception programs and handheld reception programs is made possible through hierarchical transmission achievable by band division within a channel. "Hierarchical transmission" means that the three elements of channel coding, namely, the modulation scheme, the coding rate of convolutional error-correcting code, and the time interleaving duration, can be independently selected. Time and frequency interleaving are each performed in their respective hierarchical data segment.

As described above, the smallest hierarchical unit in a frequency spectrum is one OFDM segment. Referring to Fig. 24, one television channel consists of 13 OFDM segments, and up to three hierarchical layers (Layers A, B, and C) can be set with regard to these segments. If the OFDM signal is transmitted using only one layer, the layer is A. If the signal is transmitted using two layers, the center "rugged" layer is A and the outer layer is B. If the signal is transmitted using three layers, the center "rugged" layer is A, the middle layer is B, and the outer layer is C. Taking the channel-selection operation of the receiver into account, a frequency spectrum segmented in this way must follow a rule for arranging segments. In addition, one layer can be set for the single center segment as a partial-reception segment for handheld receivers of one-segment services. In this case, the center segment is Layer A. Using the entire band in this way is called ISDB-T. Audio broadcasts and one-segment services feature a basic one-segment format as well as a three-segment expanded format, both referred to as ISDB-T_{SB}.

FIGURE 24

ISDB-T service examples and transmission signals

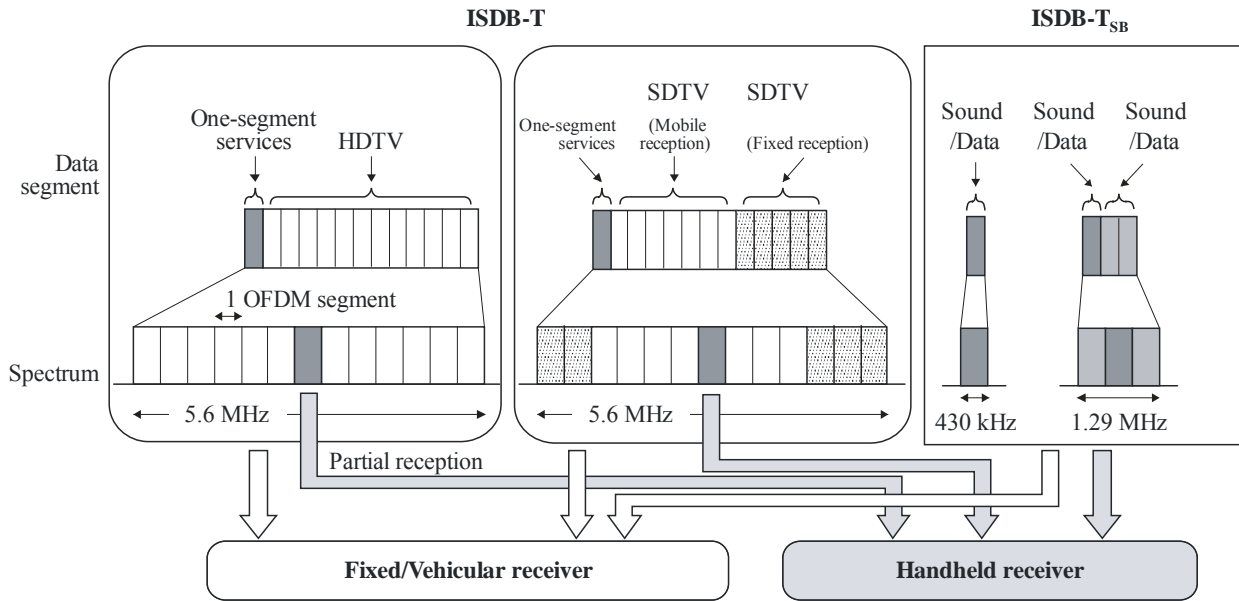

ISDB-T service examples and transmission signals

Report BT.2140-24

1.8.3 Outline of ISDB-T

Figure 25 shows ISDB-T system configuration. This system uses MPEG-2 Video coding and MPEG-2 advanced audio coding (AAC) for source coding. Moreover, it adopts MPEG-2 Systems for encapsulating data streams. Therefore, various digital content such as sound, text, still pictures, and other data can be transmitted simultaneously. For channel coding, transmission parameters may be individually set for each layer, making for flexible channel composition. Furthermore, to achieve an interface between multiple MPEG-2 Transport Streams (TSs) and the Channel coding, these TSs are re-multiplexed into a single TS. In addition, transmission control information, such as channel segment configuration, transmission parameters, etc., are sent to the receiver in the form of a transmission multiplexing configuration control (TMCC) signal.

FIGURE 25

ISDB-T system configuration

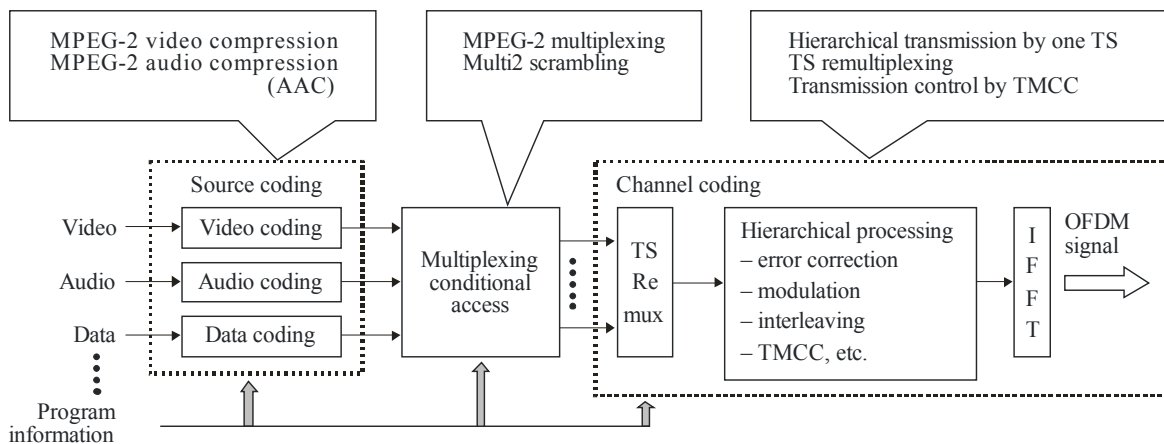

Report BT.2140-25

1.9 Terrestrial digital multimedia broadcasting

1.9.1 T-DMB general

Terrestrial digital multimedia broadcasting (T-DMB) system, is the extended system compatible with digital sound broadcasting System A, which enables video services by using T-DAB networks for handheld receivers in mobile environment. This system uses frequency bands of band III and L-band, which T-DAB networks are in operation.

T-DMB provides multimedia services including video, audio, and interactive data. For audio services it uses MUSICAM as specified in DSB System A and for video services MPEG-4 standards. ITU-T H.264 | MPEG-4 AVC standard is used for video, MPEG-4 ER-BSAC or MPEG-4 HE AAC for the associated audio, and MPEG-4 BIFS and MPEG-4 SL for interactive data. Outer channel coding of Reed-Solomon code applies to guarantee the good performance of video reception.

Field test results and the summary of T-DMB specification are included in the Report ITU-R BT.2049. The specification of T-DMB was standardized by ETSI in 2005. ETSI TS 102 427 and ETSI TS 102 428 describe error protection mechanism and the A/V codec of the T-DMB system, respectively. A variety of receivers are in the market: PC (laptop) type, vehicular type, and PDA type as well as mobile phone.

1.9.2 System architecture

The system for the T-DMB video services has the architecture that transmits MPEG-4 contents encapsulated using “MPEG-4 over MPEG-2 TS” specification as illustrated in Fig. 26.

Video service is delivered through the stream mode of DSB System A transmission mechanism. In order to maintain bit error rates extremely low, this service uses the error protection mechanism described in ETSI TS 102 427. This video service is composed of three layers: contents compression layer, synchronization layer, and transport layer. In the contents compression layer in ETSI TS 102 428, ITU-T H.264 | ISO/IEC 14496-10 AVC is employed for video compression, ISO/IEC 14496-3 ER-BSAC/HE-AAC for audio compression, and ISO/IEC 14496-11 BIFS for auxiliary interactive data services.

To synchronize audio-visual contents both temporally and spatially, ISO/IEC 14496-1 SL is employed in the synchronization layer. In the transport layer specified in ETSI TS 102 428, some appropriate restrictions are employed for the multiplexing of compressed audiovisual data.

FIGURE 26

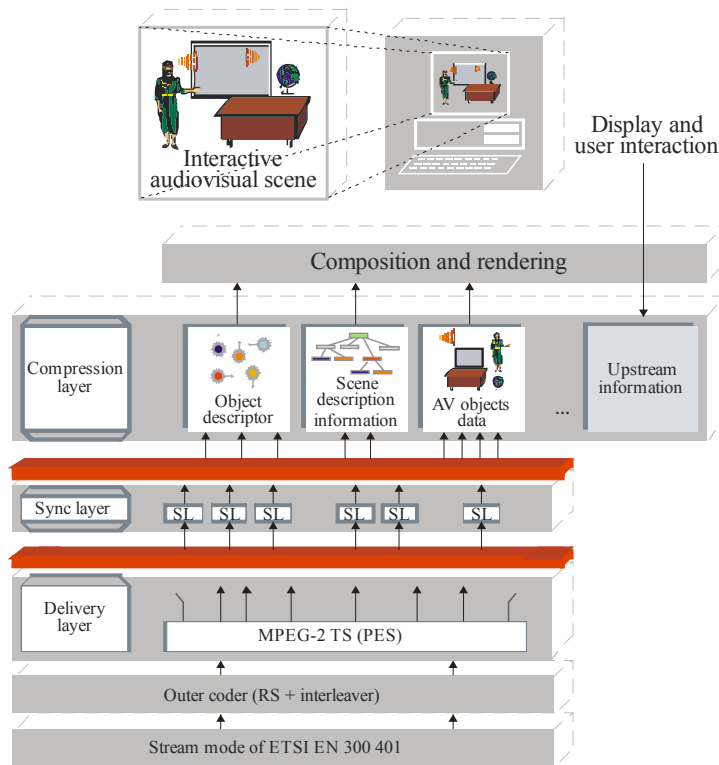
Conceptual architecture for the video services

Report BT.2140-26

1.9.3 Video service transmission architecture

The conceptual transmission architecture for video services is shown in Fig. 27. The video, audio, and auxiliary data information for a video service are multiplexed into an MPEG-2 TS and further outer-coded by the video multiplexer. It is transmitted by using the stream mode specified in DSB System A.

1.9.4 Video multiplexer architecture

The conceptual architecture of the video multiplexer for a video service is shown in Fig. 28.

FIGURE 27

Conceptual transmission architecture for the video services

DAB (ETSI EN 300 401)

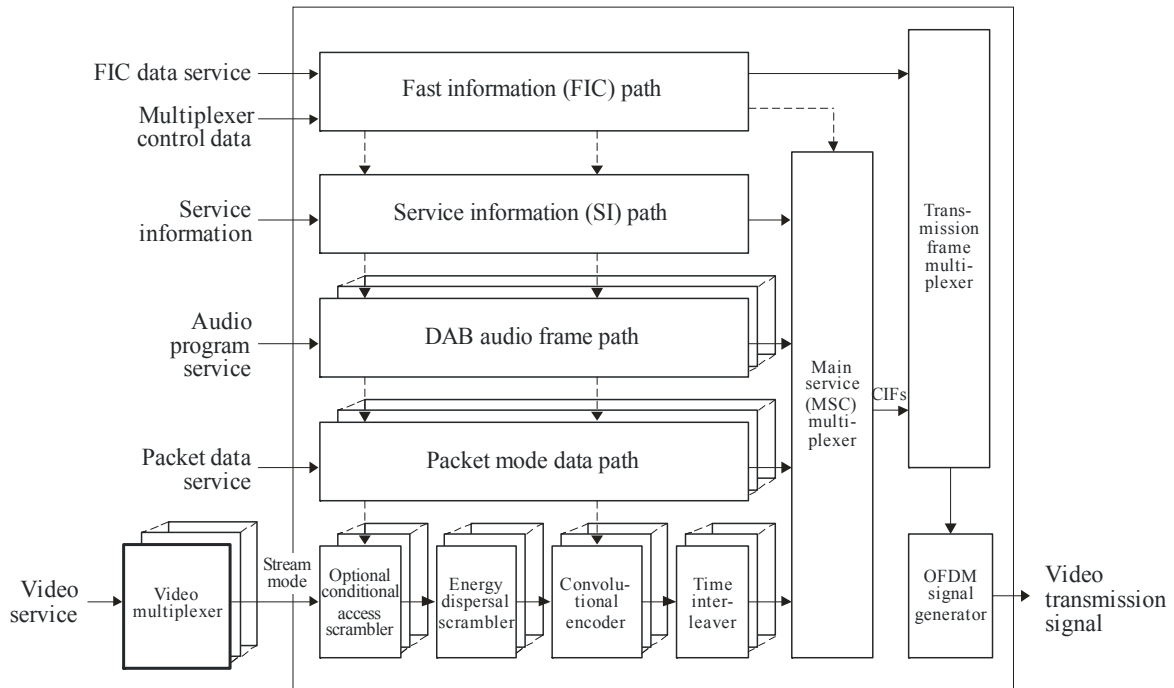

Report BT.2140-27

FIGURE 28

Architecture of the video multiplexer

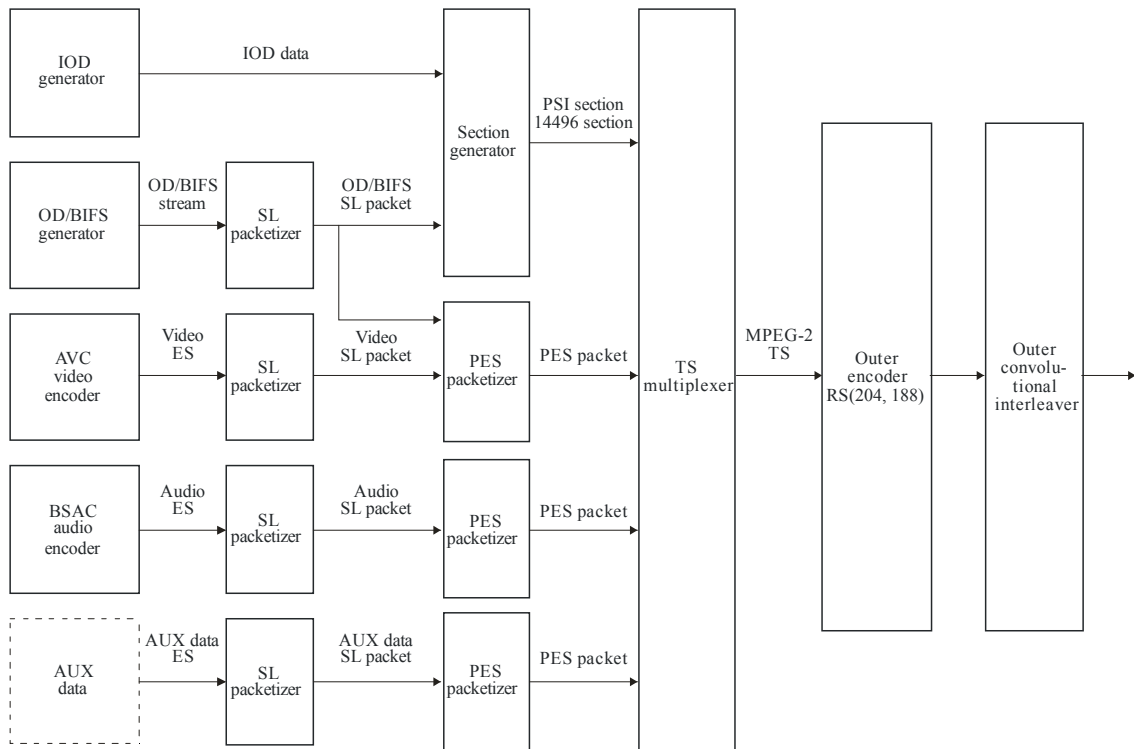

Report BT.2140-28

1.9.5 T-DMB specifications

The list of specifications for T-DMB is shown in Table 9.

TABLE 9
T-DMB specifications

Physical Layer	Recommendation ITU-R BS.1114 System A
Encapsulation and protocols for transmission of content	ETSI EN 300 401 ETSI TS 102 427 ISO/IEC 13818-1 ISO/IEC 14496-1 ETSI TR 101 497 ETSI TS 101 759 ETSI ES 201 735 ETSI TS 101 499 ETSI TS 101 498-1 ETSI TS 101 498-2
Multimedia Content Format	ETSI EN 301 234 ISO/IEC 14496-11
Audio Coding	MPEG-2 Layer II MPEG-4 ER BSAC/MPEG-4 HE-AAC ETSI TS 102 428
Video Coding	ITU-T Rec. H.264 / MPEG-4 AVC ETSI TS 102 428

1.10 LMDS (local multipoint distribution system)

Since the very preliminary applications of digital terrestrial broadcasting, interactive and multimedia applications seemed bound to play an important role in the take-off of the new broadcasting standard. Later on, the availability of MHP standard and of MHP-compatible set-top boxes definitely opened the doors to interactive and multimedia applications.

Interactive and multimedia terrestrial TV became a key part of the service in Finland, where are operational in MHP standard since 2002 and interactivity is currently tested also on the digital terrestrial TV networks of Spain, Germany, and Singapore (**other countries are invited to send a contribution on this**). With the current launch of digital terrestrial television in Italy, multimedia applications are getting a considerable interest, also for what concerns interaction with public administration (T-government) and education.

Some countries have started a field trial of IP over digital TV broadcasting.

1.10.1 Use of LMDS systems

1.10.1.1 The LMDS technology approaching the market of multimedia delivery

LMDS at 42 GHz is now a mature technology in terrestrial digital video broadcasting with the capability to have a great amount of band to offer services to the customers. For example multichannel LMDS and MPEG-2 compression coding system – allowing multiple digital time-shifted programs inside the same 33 MHz video channel – permit near video on demand (NVOD) services, without any “return connection” between the customer and the Service Provider.

Services with a low interactivity level like video on demand (VOD), games or home shopping applications, can be achieved over LMDS with telephone return channel: most of the commercial DVB Set Top Boxes (decoders) already include internal telephone modem. Also Internet access with telephone return channel is achievable, deserving some LMDS down-link channels to deliver Internet traffic.

(All sub-sections describe the situation in European Union. Other administrations are invited to provide further information on their own scenarios.)

LMDS technology is rapidly evolving and the introduction of higher levels of interactivity, will move applications from pure entertainment to wireless local loop (WLL) services. In-band return channels offer attractive independence from PSTN (public switching telephone network) for service providers. Interactivity is pushing LMDS and WLL applications into a merge whose continuous technology evolution will contribute extending profitable business penetration.

Some WLL services promise profitable commercial businesses for Small Business or Home Business (SOHO) subscribers; in particular high speed Internet surfing seems to be a valuable service for most of the users.

1.10.2 Some key factors in the technology

The choice of the complete system architecture requires a deep analysis of communication scenarios, network scenarios and traffic characteristics. The required capacity of a network depends on a large number of parameters, including the number of users, the applications they use, the protocol efficiency and the frequency re-use strategy. Access protocols must be able to cope with traffic loading near saturation.

1.10.3 Technological trends and objective constraints

Technology improvements, especially in the millimetre component field, will contribute to extend interactive LMDS services into large commercial business but, on the other hand, millimeter-wave Remote Terminal (RT) transceiver architecture must be maintained as simple as possible in order to be cost effective. Available throughput rate per customer must be traded-off with RT architecture complexity, Base Stations content feeding, modulation schemes, RT output power and return path link budget.

The design of application oriented LMDS network services in real environments appears to be an issue to be solved on a case by case basis. Besides automatic design procedures can help in the design producing an optimized network topology and architecture, cost and infrastructure implications must be carefully evaluated for each situation.

The main arguments in favour of the LMDS technology are increased data rates available to the user, the possibility to deliver both general content services and to customize dedicated services within well delimited geographical areas. Moreover it's considerable the opportunity for the operators to expand their network over a few years in terms of number of customers and services offered.

One of the most important factors affecting the success of Broadband Wireless Access Operators is the initial amount of spectrum licensed per Operator by the Administration. Another important factor is the availability of additional spectrum to meet demand as Broadband Wireless Access systems rollout. In fact, whilst a modest amount spectrum may be available in the short term, it will not be sufficient in a long term perspective where an increasing number of competitors and services will face the market.

1.10.4 Target market foreseen for LMDS

Due to the propagation limitation, line of sight users are mandatory. The target market for broadband wireless access systems could be a single or multi-tenant building within the coverage area of the cell with clear line of sight to the base station, and sufficient traffic volume to economically support the cost of the network infrastructure. There is also the need of a wired building in order to allow the distribution of forward and return channel, needed if a high interactivity level is requested, to each user from the RF terminal on the rooftop.

1.11 Forward link only

1.11.1 Introduction

Video and other rich multimedia services on a cellular phone have been primarily delivered via existing 3G wireless networks. Until recently this delivery was primarily via unicast wireless networks, although the availability of multicast methods within the existing unicast networks is increasing. The broadcast-multicast mechanisms of these 3G networks are basically added onto the existing unicast physical layer. For simultaneous wide distribution of content, typically beyond a few users per sector, it is generally accepted as economically advantageous to transition to broadcast-multicast delivery.

While the cost reduction that can be achieved by a broadcast mode within a unicast framework can be significant, even greater efficiencies can be achieved by a dedicated broadcast-multicast overlay. This is the underlying philosophy behind the forward link only (FLO) technology for broadcasting of multimedia data to handheld mobile devices.

1.11.2 Forward link only system architecture

A FLO system is comprised of four sub-systems namely Network Operation Centre (NOC – which consists of a National Operation Centre and one or more Local Operation Centres), FLO transmitters, IMT-2000 networks, and FLO enabled devices. Figure 29 shown below is a schematic diagram of an example of FLO system architecture.

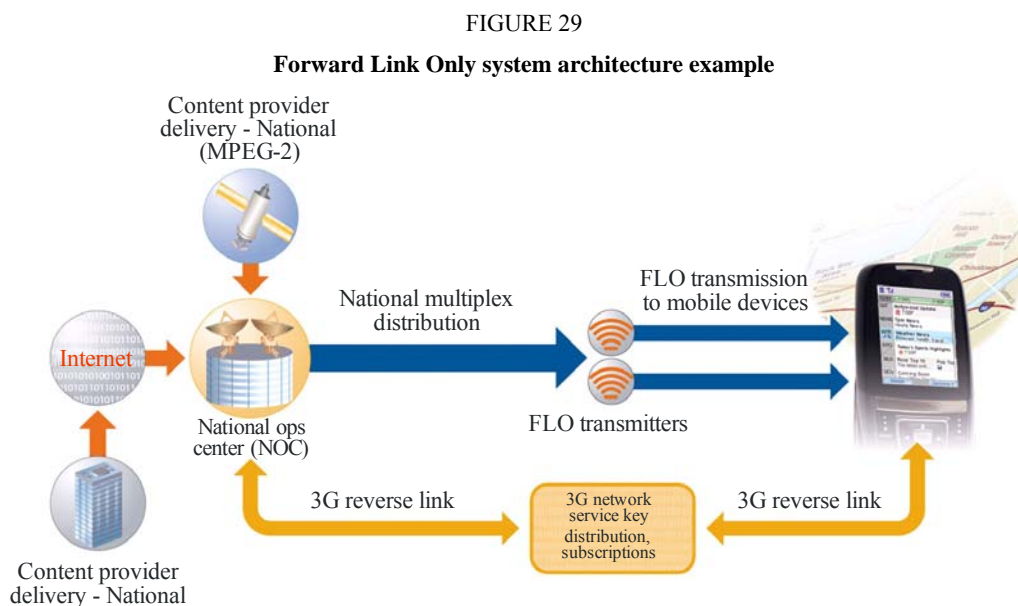

1.11.3 Forward link only system overview

1.11.3.1 Content acquisition and distribution

In a FLO network, content that is representative of a linear real-time channel is received directly from content providers, typically in MPEG-2 format, utilizing off-the-shelf infrastructure equipment. Non real-time content is received by a content server, typically via an IP link. The content is then reformatted into FLO packet streams and redistributed over a single or multiple frequency network (SFN or MFN). The transport mechanism for the distribution of this content to the FLO transmitter may be via satellite, fibre, etc. At one or more locations in the target market, the content is received and the FLO packets are converted to FLO waveforms and radiated out to the devices in the market using FLO transmitters. If any local content is provided, it would have been combined with the wide area content and radiated out as well. Only users of the service may receive the content. The content may be stored on the mobile device for future viewing, in accordance to a service programme guide, or delivered in real-time for live streaming to the user device given a linear feed of content. Content may consist of high quality video (QVGA) and audio (MPEG-4 HE-AAC)² as well as IP data streams. An IMT-2000 cellular network or reverse communication channel is required to provide interactivity and facilitate user authorization to the service.

1.11.3.2 Multimedia and data applications services

A reasonable FLO-based programming line-up for 25 frames-per-second QVGA video, with stereo audio, in a single 8 MHz bandwidth frequency allocation, includes 25 to 27 real-time streaming video channels of wide area content including some real-time streaming video channels of local market specific content. The allocation between local and wide area content is flexible and can be varied during the course of the programming day, if desired. In addition to wide area and local content, a large number of IP data channels can be included in the service delivery.

1.11.3.3 Power consumption optimization

The FLO technology simultaneously optimizes power consumption, frequency diversity, and time diversity. The FLO air interface employs time-division multiplexing (TDM) to transmit each content stream at specific intervals within the FLO waveform. The mobile device accesses overhead information to determine which time intervals a desired content stream is transmitted. The mobile device receiver circuitry powers up only during the time periods in which the desired content stream is transmitted and is powered down otherwise.

Mobile users can channel surf with the same ease as they would with digital satellite or cable systems at home.

1.11.3.4 Wide and local area content

As shown in Fig. 30, FLO supports the co-existence of local and wide area coverage within a single RF channel. When utilizing a SFN, it eliminates the need for complex handoffs for coverage areas. The content that is of common interest to all the receivers in a wide area network is synchronously transmitted by all of the transmitters. Content of regional or local interest can be carried in a specific market.

² High Efficiency AAC (HE AAC) audio profile is specified in “ISO/IEC 14496-3:2001/AMD 1:2003” and is accessible through the ISO/IEC website. The performance of the HE-AAC profile coder is documented in the publicly available formal verification test report WG 11 (MPEG) N 6009.

FIGURE 30
Hierarchy of local and wide area SFNs

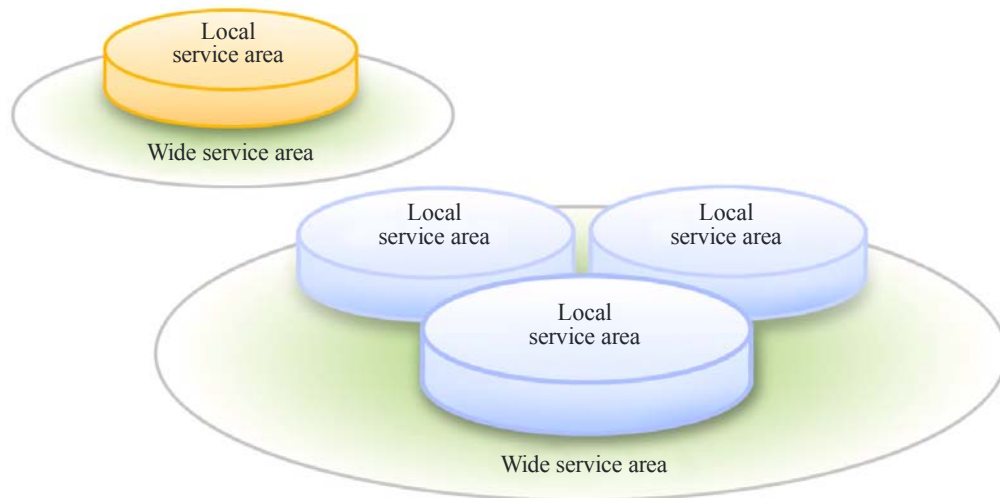

Report BT.2140-30

1.11.3.5 Layered modulation

To provide the best possible quality of service, FLO technology supports the use of layered modulation. With layered modulation, the FLO data stream is divided into a base layer that all users can decode, and an enhancement layer that users with a higher signal to noise ratio (SNR) can also decode. The majority of locations will be able to receive both layers of the signal. The base layer has superior coverage as compared to non-layered mode of similar total capacity. The combined use of layered modulation and source coding allows for graceful degradation of service and the ability to receive in locations or speeds that could not otherwise have reception. For the end user, this efficiency means that a FLO network can provide a better coverage with good quality services, especially video, which requires significantly more bandwidth than other multimedia services.

1.11.4 FLO Specification

Standardizing of the FLO technology has been achieved in the Telecommunications Industry Association (TIA) as Standard TIA-1099 and is further coordinated through the FLO Forum, www.floforum.org.

Other informative references related to the Multimedia system “M” performance include:

- TIA-1102: Minimum Performance Specification for Terrestrial Mobile Multimedia Multicast Forward Link Only Devices.
- TIA-1103: Minimum Performance Specification for Terrestrial Mobile Multimedia Multicast Forward Link Only Transmitters.
- TIA-1104: Test Application Protocol for Terrestrial Mobile Multimedia Multicast Forward Link Only Transmitters and Devices.

Chapter 2

to Part 2

2.1 Aspects related to interoperability of systems

2.1.1 Digital reception

Ensuring that most users are equipped with digital receivers is the main challenge for switchover and a pre-condition for switch-off. Finding a solution for all receivers in the home, not just the main receiver, just adds to the challenge. The two basic options are digital converters or set-top-boxes connected to analogue receivers, and integrated digital receivers. Moreover, additional reception facilities such as cabling, antennas, dishes, etc. are often necessary.

There must be a large range of digital reception solutions to suit various user segments. This means choice of functionality, price and commercial formulas. Equipment cost is not a major barrier to the consumer of pay-TV services since some pay-TV operators subsidize it, having already deployed millions of set-top-boxes. However, pay-TV will not achieve the widespread penetration of digital TV only. Now the main challenge concerns the creation of “horizontal” markets for unsubsidized receivers supporting free-to-air digital TV services, where consumers pay the full cost from day on. Co-existence of the two business models is important for wide-spread digital TV market penetration.

Availability of cheap receivers is essential to minimize entry barriers for consumers. Most of them must be equipped before the switch-off can take place. Equipment costs should not be much higher than in analogue and services at least comparable, thus offering a cheap entry point to digital TV. This is the way the market seems to go now. Of course consumers should also have options to buy expensive equipment supporting sophisticated services. Service and equipment diversity also contributes to wide-spread digital TV market penetration.

2.1.2 Encouragement to deployment of digital receivers

Free movement of goods within the internal market requires that national authorities do not impose administrative constraints for commercializing digital broadcasting equipment and compulsory technical requirements.

Some ITU Member States envisage public subsidies for digital equipment through schemes aimed at the whole population or just specific groups. The risk with the first scheme is discouraging purchases, including purchases of more sophisticated equipment than the one subsidized. The risk with the second scheme is trading of devices between subsidized and unsubsidized population groups.

Several other forms of incentives have been considered by some Member States, for instance temporary and digressive reduction of the license fee for homes with digital equipment to encourage fast digital migration, etc. Some Member States allow a reduced rate of VAT on pay-per-view and subscription broadcasting services. The financial implication and parties affected are different, so each option should be carefully analyzed and implemented.

2.1.3 Consumer information on digital equipment and switchover

Consumer information is crucial to drive digital equipment sales in a market-led approach to switchover. Consumers should be empowered to plan their own migration rather than being forced and thus deprived by this process. They should be well informed of the timing and consequences of switchover so as to take their own decisions on services and equipment from a wide range of choices. They must be aware of what various devices can offer, what are the prospects of analogue

equipment obsolescence and the possibilities for upgrading. Information and labelling should also be available in accessible formats for consumers with disabilities.

Informing consumers is the responsibility of equipment manufacturers, retailers and service providers, who need to co-ordinate their action and send clear messages whilst respecting competition law. Labelling schemes for analogue and digital equipment, with explanatory notices and/ or logos, based on voluntary industry commitment, would be particularly useful. The goal would be to send consumers positive and negative signals about, respectively, digital-compliant and analogue-only receiver equipment. This information should mirror national switchover policies, including indicative national or regional switch-off dates. Especially as an analogue switch-off date approaches in a particular Member State, its consumers should be clearly warned about the risks of equipment obsolescence.

Policy intervention in this area has been proposed in some ITU countries. However, Member States cannot impose *de jure* or *de facto* compulsory labelling schemes without prior notification. Notification enables a compatibility assessment of such measures with internal market rules to be undertaken. Where necessary, a certain degree of harmonization could be envisaged so that the approach to labelling would be common whilst tailoring its implementation to local circumstances, such as national switch-off dates. Labelling specifications could be approved by consumer and standardization bodies.

2.1.4 Integrated digital television receivers

The prohibition of selling analogue-only television receivers according to a staggered calendar was approved and is now fully implemented in the United States of America. It is being debated in some EU Member States. All EU countries would have to implement the obligation more or less simultaneously to preserve homogeneity within the internal market. This would have greater impact in countries where digital penetration remains low and strain the principle of subsidiarity traditionally applied in broadcasting policy.

Another potential drawback of compulsory integrated digital receivers would be the extra cost for consumers which, depending on the exact technical requirements, could however be partly offset by economies of scale. The impact would be greater in those countries where digital TV is less developed. Concerns can be also raised as to the technological neutrality of the measure. If only one type of digital tuner were to be mandated, this would presumably favour the dominant analogue TV network, often terrestrial.

2.1.5 Digital connectivity

Currently, digital TV signals are almost always displayed on analogue TV sets connected to a digital set-top-box, which decodes those signals, through the analogue “SCART” socket or connector. That means digital signals are converted into analogue signals before being displayed. This is acceptable for today’s television receivers, based on cathode ray tubes and small screen sizes. However, the quality penalty is more perceptible on big screens using new digital display technologies. Moreover, the lack of systematically implemented and enabled digital connectors prevents the transfer of digital information between digital TV receivers and other digital devices in the home. But digital connectivity raises copyright security concerns, in particular that insufficiently protected digital content could be illegally copied or distributed. The possibilities for implementing digital connectors should be further explored as an incentive to consumer equipment switchover. A number of options exist to interconnect digital TV equipment, fulfilling different requirements but it is still unclear which way the market will go.

2.1.6 Access for users with special needs

Access to digital broadcasting should include citizens with special needs, notably people with disabilities and older persons. However, while digital broadcasting offers greater possibilities than analogue in this area, these are not yet supported by digital equipment on the market. Harmonized approaches can reduce costs through economies of scale, thus facilitating the marketing of relevant functionalities.

2.1.7 Removal of obstacles to the reception of digital broadcasting

Infrastructure competition stimulates market development, increasing consumer choice, quality of service and price competition. This may be constrained in some areas by legal, administrative or contractual restrictions on the deployment of infrastructure or reception facilities. Authorities will need to arbitrate between promoting digital broadcasting and the fundamental freedom to receive information and services, therefore facilitating network competition, and other policy objectives on town planning, environmental protection or other areas. With that proviso, national authorities should encourage network competition. By way of example, some Member States have already adopted measures in support of this objective, for instance by requiring the provision of multi-network reception facilities in new apartment blocks, facilitating their installation in existing blocks (for instance by reducing the required threshold of tenants' votes), or by removing restrictive clauses in property or renting contracts. Coordination between national and local authorities is important since local authorities are often responsible for the practical implementation of this type of measure.

2.1.8 Effects on citizens

In all transition periods there are a lot of actors, but the past has shown the principal actors are the users. The decision of the users is in all cases oriented by market forces that, driven politically by Administrations and Manufacturers with the support of Broadcasters, can promote the opinion for change to oldest analogical systems and buy the new digital equipment. What is very important and urgent is the coordination among the different actors. In fact if the users are ready to buy new equipment and the manufacturers have produced the equipment, is very important to have a "frequency planning" program prepared by Administrations and, at the same time, a sufficient number of programs emitted, with interesting contents attract the attention of users and promote the change.

The users are moving fast towards a mobile 2G/3G lifestyle and future technologies have taught us to use mobile technology in our everyday communication. By receiving mobile broadcasting services in conjunction with 2G/3G as a return channel, consumers will be able to receive a new kind of content service and have increased interactivity. Joint utilization of digital broadcasting and existing and new cellular/cellular-type network technologies will provide consumers with location-independent and personalized services. Additionally, the delivery of digital media content via several distribution channels strengthens the availability of information society services, as they could be provided in various manners, via different network transmission methods. The use of more extensive and diverse communication networks promotes the availability of additional services and the development of content and receivers at affordable prices. This will mean information society services, including public services, can be made more accessible and cheaper than ever for all citizens by combining the usage of different types of distribution communication networks or by offering them via one communication network.

For digital television and radio the crucial conditions for success require a public that is informed on the facilities and benefits offered by the new digital services, including technical enhancements, additional programmes and services. The public must be aware of the additional service opportunities digital broadcasting and consumer electronics will offer. (For example, initiatives in this direction (i.e. to raise the public's awareness) are already ongoing in some European countries.)

In addition, geographical access to digital services should be maximized and the new services should be accessible on the shortest time-scale.

Open access to public services of the information society should be encouraged, and directly developed whenever possible. This will support and speed up the implementation and success of digital broadcasting and additional datacast services. The lifetime of consumer products is in general expected typically to be from 5 to 10 years, and in some instances more. This requires stable systems, open access and the possibility of upgrading. This can only be assured when there are common, widely adopted standards jointly agreed among market players.

2.2 Mobile services

2.2.1 Sound

Mobile sound service consists of traditional audio programs. The small devices and low price are requested. One important problem is long battery lives.

Compared to stationary reception of broadcasting, the portable broadcast receiver is introducing this new user requirement, which can only be met, if the broadcasting link system allows for low power consumption of the receiving handheld terminals.

This has been taken into account through different means in some of the standards/specifications, which have already been elaborated on a regional/national basis.

2.2.2 Mobile TV

Mobile TV services consist of traditional TV programs or TV-like programs. TV type of services presented to mobile handheld devices with small screens is predicted to be designed different from content offered to large screen receiving terminals in a stationary broadcasting environment.

Instead of users watching a two-hour movie on the smaller screen of a handheld terminal, a more typical usage scenario would be to watch news flashes, sports features, music videos, weather forecasts, stock exchange reports and other such content, which is suitable for “ad hoc” consumption during smaller time slots.

2.2.3 Enhanced mobile TV

Online TV shopping, chat, gaming and quiz plus voting are examples of functionalities, which may be introduced as enhancements to the mobile TV to allow a true interactive mobile broadcasting experience.

2.2.3.1 The Electronic Service Guide

Especially in the mobile environment it is important for the user to be able to navigate through the various broadcast service offerings in an easy and formalized way. Electronic Service Guide (ESG) contains information of the available services and how those can be accessed. The concept of the ESG has been found to be a well-accepted way for the user on the move to discover, select, and purchase the broadcasted services he/she is interested in.

2.2.3.2 Data

The mobile TV programs may be supplemented by auxiliary data associated with the basic service. Such information could be part of the broadcast or can be accessed on demand via the interactivity link.

The additional background information may include links to the service provider’s web pages, video clips, sound tracks, games, etc.

In Table 10, an overview of currently known mobile broadcasting transmission mechanisms is provided. The technical characteristics shown are subject to change and are by no means exhaustive but provided for comparison only.

TABLE 10

Mobile digital broadcasting transport mechanisms

Standard or specifications	Modulation	Transport stream	RF channel (MUX) size (MHz)	Int. Broadcast bands	Terminal power reduction methodology	Regional national origin
DVB-H	QPSK or 16-QAM COFDM	IP/MPE-FEC/ MPEG-2 TS	8	IV and V	Time slicing	Region 1 (Europe)
ISDB-T	QPSK or 16-QAM COFDM	MPEG-2 TS	0.433	IV and V	Bandwidth shrinking	Region 3 (Japan)
T-DMB	DQPSK COFDM	MPEG-2 TS	1.75	III and 1.5 GHz	Optimized narrow bandwidth	Region 3 (Rep. of Korea)

2.2.3.3 Implementation of interactivity

It is therefore natural for the mobile user community to expect interactivity as a basic characteristic of future mobile broadcasting services, an expectation that several ongoing trials have confirmed.

2.2.3.4 The interaction channel implementation

2.2.3.4.1 Digital mobile telephony

As the major part of the world standards of digital mobile telephony including IMT-2000 offer two-way data services, one approach to implement interactivity seem to be the incorporation of such mobile technology in the user terminals.

Apart from offering the user all state-of-the-art mobile telephone services, this way of implementation of interactivity with the broadcasting service offerings provide immediately a reliable control link for all such broadcasting services. It allows the user to respond and interact with the broadcasting system and to receive control codes through a secure environment.

This approach may also take advantage of the global roaming characteristics of many mobile technologies as well as of the wide-area coverage characteristics of mobile telephone technology throughout the world.

2.2.3.4.2 Interaction channel making use of the broadcast spectrum

This approach has been studied in the past, but major difficulties with global circulation of user equipment capable of transmitting into the broadcast spectrum have so far been a substantial hurdle. The development of a new two-way data transport standard may also delay the progress.

2.2.3.4.3 Summary of interaction channel methodologies

TABLE 11

Interaction channel methodologies for interactive mobile broadcasting systems

Methodology	Reference standards/ Specifications	Carrier service	Link peak bit rate (bit/s)
Mobile telephony	IMT-2000	HSDPA (Device Category 10)	14 Mbit/s
		HSUPA (E-DCH)	3.84 Mbit/s
	Global system for mobile communications (GSM)	GPRS (Device Category 10)	85.6 kbit/s
		EGPRS	236.8 kbit/s
Other			
Broadcasting in-band	N/A		

N/A: Not applicable.

Chapter 3

to Part 2

3.1 Report of TG 6/8

The Report of TG 6/8, in Chapter 3 – Planning principle, methods and approach, § 3.4.2.3 to the first session of the RRC gave considerable information about four planning scenarios which were intended to indicate that any general planning philosophy wish expressed by an administration could be satisfied. There is, of course, no intention to imply that the detailed requirements submitted by administrations can all be satisfied. In fact, it is extremely unlikely that all requirements can be satisfied because there are natural limitations on the capacity of the available spectrum and it is to be expected that the initial requirements from administrations will exceed that natural capacity. Compromises will therefore need to be made by administrations in order to achieve a satisfactory plan.

The planning scenarios in the TG Report are intended to respond to a wider range of planning options than are likely to be required by administrations. This is necessary if there is to be certainty that all general planning philosophies can be dealt with. However, it means that only very limited attention needs to be given to planning scenario 1 which seems unlikely to be needed in practice as it can be replaced by planning scenario 2 with no loss of generality.

This is because the intention of planning scenario 1, which was to allow for the case where an analogue station remains operational for an indefinite period, can be achieved by planning scenario 2, which allowed for continued protection of an analogue station with a subsequent change to digital operation in the same channel at the end of a transition period. If an administration does decide not to convert an existing analogue station to digital operation, it just means that the transition period for that station is extended indefinitely.

It may also be the case that scenario 4, which allowed for the planning of digital stations with no constraints imposed by reuse of existing analogue channels, is unlikely to be of general value. This is because if there is no reuse of existing (or planned) channels, it becomes almost impossible to ensure protection of both analogue and digital stations during the transition period, especially in the case where the administrations of neighbouring countries have different timetables for effecting the transition from analogue to digital.

However, there is one situation in which the application of scenario 4 could become very important. This is where there is part of the spectrum in which there is no current analogue broadcasting, and preferably no planned analogue broadcasting either. Under these circumstances, the channels for digital broadcasting stations can be planned to make fully efficient use of the spectrum. The latter is not possible in the case where there is considerable reuse of the channels of the existing analogue stations, as the optimum distance spacing between a pair of analogue stations and that between the same pair of stations operating digitally may be different. This necessarily introduces some inefficiency in the use of the spectrum. On the other hand, reuse of channels makes it possible to plan for a transition from analogue to digital with a reasonable hope of controlling interference levels and the possibility for viewers and broadcasters to make use of the existing infrastructure to a large extent.

It will have been noted that in the limited discussion of the two planning scenarios above, there is an assumption that different scenarios can be adopted by different administrations and also in different parts of the planning area. The adoption of different scenarios can be considered at an even more detailed level, that is at the level of individual broadcasting stations. One example would be where an administration considers that a particular analogue station needs to be maintained in operation for a long period while some other analogue station (or stations) can be changed to digital

operation in the very short term. The converse is also true. An administration can decide that for some specific reason, and there can be many such reasons, an analogue station should be changed to digital operation as early as possible while other stations can be left as analogue for a much longer time.

3.2 UMTS/GSM and DVB-T convergence

The ad hoc group DVB-UMTS/GPRS/GSM has classified the cooperation of DVB-T and UMTS/GSM/GPRS for commercial applications in different scenarios. This classification typically uses the broadcast channel for the down-load (unidirectional way), and the telecommunication channel (PSTN, xDSL, GSM, GPRS, UMTS, and...) for the up/down-load (unidirectional/bi-directional way). Particularly are addressed the user view for services built on Telco/Broadcast convergence.

There are many scenarios that can be considered for a co-coordinated use of UMTS/GPRS/GSM and DVB networks. These range from the simple sharing of content to the sharing of spectrum. A basic assumption for a cooperation of mobile network is that terminals are able to access both networks (DVB and UMTS/GPRS/GSM). Such a cooperation of both networks will improve the capabilities and varieties of services, the economics for the user and, hopefully, the ease of handling. It combines the network service modes of both network and thus enables new solutions for applications. Of course, there will still be services, which need only one network. Some applications like interactive TV can use also separate terminals, e.g. a set top box (IRD) of a UMTS/GPRS/GSM mobile terminal. Furthermore, the cooperation of networks enables the use of the UMTS/GPRS/GSM operator's services like customer relationship management and billing for all services.

Initially, the work of DVB-UMTS/GPRS/GSM group has focused on the provision of services using the DVB-T and UMTS/GPRS/GSM platforms. The specifications will be developed in different stages, corresponding to the availability of present hardware and software products and the development time required for new solutions mainly:

- a) Interactive broadcast services (video, data); use of UMTS/GPRS/GSM as a return channel for interactive TV. UMTS shall be able to substitute GSM as a return channel for these services for dial in access and further for Internet based access.
- b) Integration at the terminal level. No definitive cooperation of networks is required. The specification covers only the terminal, which is able to switch between the two networks and related services. The user has the choice to select the service of DVB or UMTS/GPRS/GSM to get requested information.
- c) Integration at terminal and network levels. Cooperation of networks with applications using both co-operating network resources. Terminals are firstly portable PCs, PDAs etc. combined with a UMTS/GPRS/GSM "modem" for interactive services, which run on a co-operative software platform, e.g. in a domestic or car environment. The mobile handset and the broadcast receiver can connect (for example) into the PC via USB ports. The data allocation in the DVB Transport Stream can be used for IP data carousel play out and multicasting/unicasting; UMTS/GPRS/GSM will operate as an interaction channel for Internet services.
- d) Mobile operation: full mobility and range of co-operative services within a single handset (terminal). Delivery of DVB content and services over UMTS/GPRS/GSM will be supported. Content can be delivered via IP over the DVB-T platform, in all or part of the multiplex or (suitably re-purposed) over UMTS/GPRS/GSM.

The cooperation platform will incorporate all functions that enable inter-working between legacy domains (broadcast, cellular), or new functions that are not available in any legacy domain.

3.3 DRM simulcast

Simulcast is an option of particular interest to broadcasters who have to continue to satisfy existing analogue listeners for several years to come, but wish to introduce DRM services as soon as possible. In many cases these broadcasters are restricted in the ways in which the digital service can be introduced. For example they may have a single MF assignments and no prospect of receiving an additional frequency assignment to start a digital only version of their service. They may also be keen to avoid having to make a short-term investment in an additional transmitter and/or antenna and site to start a digital service on a new frequency.

These broadcasters would like to be able to transmit simultaneously both the existing analogue service and a new DRM service, with the same content, whilst using the existing transmitter and antenna. This option is probably most applicable to broadcasters with LF or MF assignments, where there is generally less freedom to use new frequencies, although there may be similar SW applications where NVIS is used for domestic radio coverage. In an ideal world these broadcasters would like to be able to transmit a service using single channel simulcast (SCS), so that both the analogue and digital signals are contained wholly within the assigned 9 or 10 kHz channel.

Strictly the term simulcast can be taken to describe the simultaneous transmission of more than one signal carrying the same programme content. In this context it often describes the simultaneous transmission of analogue and digital versions of the same programme from the same transmitter and therefore from a common location. However, it could also mean that only the antenna is common, as well as that both transmitter and antenna are common to the two services. In some cases it could be more economical to add a new lower powered transmitter for the DRM service, feeding the same antenna, rather than making extensive modifications to an older less suitable transmitter, currently carrying the analogue service.

DRM supports a number of different simulcast options. Currently the supported simulcast modes require the use of additional spectrum outside an assigned 9 or 10 kHz channel (multi-channel or multi-frequency simulcast, MCS). The DRM signal can be located in the next adjacent upper or lower channel and can occupy a half or whole channel depending on the bandwidth option chosen. Significant testing, both in the laboratory and in the field, has been carried out to determine the optimum level of DRM signal needed to provide a good quality DRM service, whilst avoiding significant impact on the continuing analogue service. The conclusion is that a satisfactory compromise can be obtained when the DRM power level is around 14-16 dBs below the adjacent analogue signal. In an ideal world it would also be possible to transmit both an analogue and a digital signal within the same channel (9 or 10 kHz) so that the analogue service could be received, without interference from the digital signal, on any analogue receiver. At the same time the digital service could be received in high quality audio on a digital receiver. However, although promising proposals for a SCS option are currently being evaluated, certain compromises will almost certainly need to be made. Amongst these are likely to be a reduced digital service data rate, which will adversely impact on audio quality, and a reduced service area compared to the analogue service if interference to the analogue service is to be avoided. In the case of the analogue service there is likely to be some impact on the background noise level due to the presence of the digital signal, and the impact is likely to be dependent on the design of the analogue receiver. Nevertheless, there is optimism that most of these problems will be overcome, or significantly reduced, as a result of the ongoing development work.

Even if single channel simulcast may prove a difficult goal to achieve, the other options mentioned above, which require wider bandwidths, can already be implemented. These options will still allow some reduction in transmission equipment investment by allowing the use of the existing antenna and/or transmitter that already carries the current analogue service.

3.4 Service planning

3.4.1 DRM overview

Planning procedures within the AM broadcasting bands below 30 MHz need to be considered in two parts. Within the AM bands contained in the LF and MF part of this spectrum, there are pre-existing regional plans which lay down the fixed assignments or allotments to be used for transmissions by each member country of the ITU. In the HF bands, planning is done on a much more flexible basis, which takes into account the diurnal, seasonal and solar variations in propagation when the allocation of spectrum is determined. In the case of MF and LF spectrum two agreements are in force, the Geneva 1975 Agreement, which covers ITU Regions 1 and 3 and employs a 9 kHz frequency grid, and the Rio Agreements of 1981 and 1988, which cover Region 2 and employ a 10 kHz frequency grid. In the case of HF planning, all three regions use the same frequency grid of 10 kHz and planning, for most countries, is carried out through the auspices of the informal HFCC/ASBU/ABU-HFCC coordination process, with the resultant twice-yearly plan being registered at the ITU by administrations.

3.4.1.1 Regions 1 and 3 – LF and MF planning

Within these two Regions only Region 1 currently has assignments for and uses the LF band. Therefore the majority of assignments for both regions are in the MF band. Under the existing GE75 Plan, existing assignments are listed with their power, antenna details and transmitter location. Any change to this situation, for a particular assignment, requires a recalculation of the transmission parameters to ensure that the protection ratios for other assignments in the Plan, which might be adversely affected by the change, do not deteriorate by more than 0.5 dB. This is also the means by which new assignments have been and can be introduced into the Plan. In September 2002 the ITU Radiocommunication Bureau published Circular Letter CCR/20 under which the RRB with Rules of Procedure to provide the possibility to introduce DRM transmissions into the MF band in Regions 1 and 3 and the LF band in Region 1. Until this issue is agreed by a competent conference the following course of action may be taken by administrations on a provisional basis.

In the case of existing assignments already within the GE75 Plan the ITU-R Letter allows these to be converted to DRM assignments on the basis that they operate with an average DRM power at least 7 dB below that of the currently assigned analogue DSB service carrier power.

In the case of new assignments, which it is proposed should be introduced under the existing GE75 Plan, planning is carried out as if it were to be a new analogue DSB Assignment. If such a new analogue assignment is allowable within the plan, then it may be introduced as a DRM service, provided it is operated at an average power level at least 7 dB below the allowable new analogue assignment.

In both the above cases it is important to note that only DRM Modes A and B using 9 kHz bandwidth are approved for use under this change in the Rules of Procedure.

3.4.1.2 Region 2 – MF planning

The introduction of DRM services in the MF band in Region 2, within the confines of the Rio 1981 (R81) Agreement, is much more problematical. This is due to a stipulation to the effect that § 4.2 of Annex 2 to this Agreement imposes on the classes of emission, other than A3E (that is DSB with full carrier), the condition of being receivable by receivers employing envelope detectors. The later Rio 1988 (R88) Plan, which extends the allowable extent of the MF band in this Region, does not impose such a similar condition. However the ITU RRB did not currently feel able to make a determination for a draft change in the Rules of Procedure for either agreement and so DRM services are not currently envisaged as feasible within the MF band in Region 2. This does not

entirely preclude the use of DRM transmissions in this band should an Administration wish to authorize its use within its territory on a non-interference and non-protected basis.

The RRB discussed in its determination the question of whether simulcast systems might be allowable under the R81 plan, as they were receivable on a receiver employing an envelope detector. However the Board expressed concern about the bandwidth requirements of such systems, as they generally required between 20 and 30 kHz of spectrum to accommodate both the analogue DSB signal and the digital counterpart.

Except for a single channel simulcast version of the DRM system (see § 3.3), which was not specified at the time of the RRB's determination, all other DRM simulcast proposals involve the use of between 20 and 30 kHz of spectrum. In some Region 2 territories such a system option would be potentially allowable within the terms of locally applied spectrum masks with which broadcast services in the MF band must comply. These spectrum masks are generally more relaxed than the ITU-R transmission spectrum mask and envisage lowered but significant levels of energy being radiated up to 10 or 15 kHz away from the assigned channel centre frequency. In such cases the DRM hierarchical transmission modes could be operated in conjunction with an analogue DSB signal to occupy a total of 20 or 30 kHz of spectrum. The analogue signal, at full assigned power, could occupy 10 kHz of spectrum with the base and enhancement DRM transmissions occupying 5 or 10 kHz of spectrum immediately above and below the analogue signal.

3.4.1.3 Regions 1, 2 and 3 – HF bands

Due to the diurnal (day/night-time), seasonal and sun spot related variations in propagation which take place in the SW bands, planning requires that frequency schedules are generally valid for only a six month period. For the majority of international SW broadcasters and operators this requires that intended transmissions are coordinated informally through the HFCC/ASBU/ABU-HFC in order to reduce the potential for interference to a minimum. This procedure is equally being observed for the introduction of DRM transmissions into these bands. Under current coordination procedures DRM transmissions may be introduced under similar principles to that in the MF bands. That is the service is first coordinated as if it were an analogue DSB service and then a DRM transmission substituted with a power level at least 7 dB lower than the allowable analogue transmission. The provisional protection ratios adopted during WRC-03, for the protection of analogue DSB transmissions from DRM transmissions, show small variations according to DRM mode and modulation. However, in all cases, these variations are smaller than the precision of the propagation prediction tools and can be discounted for the purposes of coordination.

3.4.1.4 The 26 MHz SW/HF band

The 26 MHz broadcasting band allocation is seldom used for traditional short-wave broadcasting. This is due to the frequency being too high for reliable sky-wave propagation during most of the 11-year sunspot cycle in most parts of the world. To a lesser degree, the same is true for the 21 and 19 MHz bands. These bands, particularly the 26 MHz one, could easily be used for DRM broadcasting to a more local audience. Tests in Europe have produced very encouraging results. In the UK tests were part of a local single frequency network of 3 transmitting stations for which the power used was only 10 watts per transmitter. Another test using a single 100-200 W transmitter at a high altitude site close to Geneva showed excellent coverage and quality around the city.

For the line-of-sight services, which are proposed within these bands, Modes A, or B are likely to offer the optimum results. It may sometimes be possible, in some countries and with regulatory approval, to employ the wideband 20 kHz option to improve the audio quality still further. To obtain the best performance from this type of service, it is likely that it will need to be planned in a similar way to an FM service. That is with the antenna at a high level, with respect to the coverage area, and with average powers in the range of 100 to 200 W. It must be recognized, however, that for a period of the sunspot cycle around its maximum, significant interference may be experienced

to the local service area. This interference is most likely to be caused by high power international 26 MHz transmissions, as conditions will then make these possible. There may also be interference from other, more local, low powered transmissions, if efforts are not made to minimize sky-wave radiation from them.

3.4.1.5 Near vertical incidence sky-wave

This type of propagation is typically used for in-country SW coverage in tropical zones. The “near vertical” geometry causes multiple reflections between ground and the reflecting ionospheric layers. The result is illustrated in Fig. 31, where several significant reflections are seen to arrive at the receiver antenna. It has been observed during transmissions that at certain times of day, such as dawn and dusk, these reflections can have similar energy and be spread over a period of several milliseconds. In order to prevent destructive interference it is important to ensure that these reflections arrive inside the guard interval otherwise the system will fail.

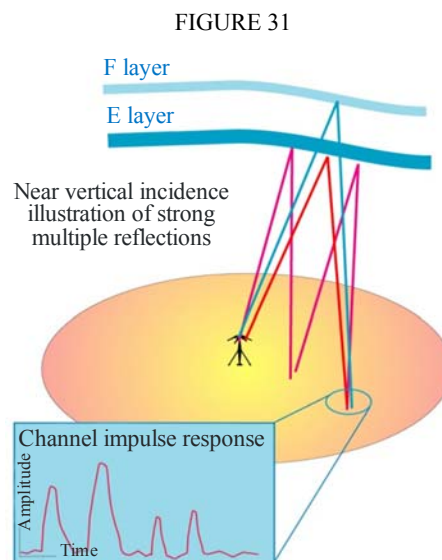

Report BT.2140-31

At the same time as these multiple impulses are observed they can also be subject to high values of Doppler spread. This is due to the constant movement of the reflecting layers and is more significant compared to long path reflections, due to the fact that for near vertical incidence sky-wave (NVIS) the movement represents a greater proportion of the ground to ionospheric distance. The result of the conjunction of these two phenomena is simultaneously high values of delay and Doppler spread. This can only be overcome by the use of a long guard interval in conjunction with wider frequency spacing for the OFDM carriers. However, because the signal strength can be quite high due to the short paths, signal to noise ratio is often not the limiting factor in NVIS and so 64-QAM may be useable for the MSC. Even so, due to the frequent need to use Mode D because of its higher resistance to Doppler and delay spread, the usable data rate of this mode, in a 10 kHz channel, will be quite low. This low data rate may force the use of CELP+SBR audio coding, rather than AAC, unless it is possible to use the 20 kHz wideband option. In this case AAC+SBR becomes possible providing near mono FM, or even stereo quality in good conditions.

3.4.1.6 Single frequency networks

Although analogue synchronous networks are often used to provide extended coverage, there will always be problems with mutual interference in at least some parts of the overlap areas. This usually requires the use of additional frequencies to supplement coverage in these areas. With careful design, this problem can be all but eliminated in the case of a DRM SFN. Figure 32 shows a much-simplified arrangement for a DRM SFN, using 6 transmitters. In the area of overlap between areas 1 to 4 it can be seen that signals may be received from all four transmitters at the same time. Provided these signals all arrive within the guard interval they will reinforce each other and reception should be improved in this area over that obtainable from any one transmitter. It is important to note that the transmitted signals must be identical for reinforcement, rather than interference, to occur.

FIGURE 32

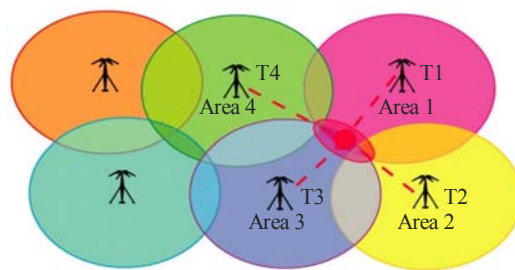

Single frequency network for ground-wave only propagation

Report BT.2140-32

Care will need to be taken however to ensure that the network continues to work effectively after dark. Then sky-wave propagation may allow more distant transmitters in the network to contribute signal into the local service area of parts of the SFN. If the propagation path is of sufficient length, and the signal strength is high enough, it may cause interference due to the sky-wave signal being delayed by more than the guard interval. Preventative measures to be taken could include ensuring that sky-wave radiation is minimized by suitable antenna design and changing to a more robust transmission mode, with a longer guard interval, during times of sky-wave propagation.

SFN operation is, in principle, possible using two or more MF or SW transmitters providing service entirely using sky-wave propagation. However the technical requirements are quite onerous, since each of the signals must be timed to arrive simultaneously over the whole of the coverage area. Otherwise they will cause mutual interference rather than reinforcement. This may require real-time monitoring of signals received at several points in the intended coverage area.

Without this, predicting the propagation transition time from transmitter to receivers in the coverage area may prove difficult to achieve sufficiently accurately in advance.

3.4.1.7 Coverage planning

At the time of writing there are no planning tools available which have been specifically designed to calculate coverage and availability for DRM transmissions. However a number of DRM Members plan to rectify this situation by setting up a new project to design software planning tools which takes into account the additional propagation parameter needs of the DRM system. For the moment though, it remains necessary to make a calculation of field strength in the target coverage area based on an analogue DSB transmission. This can then be related to the required signal strength for a DRM transmission using a particular combination of robustness Mode, MSC constellation and code rate to provide the necessary SNR for service. For ground-wave services, this method can be

expected to provide results close to observed measurements, as the path is simple, and little, if any, multi-path is introduced to cause signal distortions.

For sky-wave services the prediction is much more complex, as the resultant service will depend not only upon the delivered signal strength but on the level of Doppler and Delay spread to which the signal will be subject. Most software based prediction tools either do not estimate these parameters or, if they do, do not produce reliable results. Nevertheless, for the time being, the existing analogue prediction tools will continue to be used, as they are all that is available. However, it is anticipated that new tools will be developed in the near future, which will aim to provide an estimate of these additional propagation parameters. These tools will be designed to recommend the combination of transmission parameters that best meet the needs of a broadcaster for a specific transmission path and target zone.

In general the average power requirements of a DRM transmission will be less than that of the equivalent analogue transmission. In part this is due to the fact that a DRM transmission will have a higher peak to mean ratio than an analogue DSB signal.

A simple analogue DSB signal will consist of a single carrier at zero modulation whilst at 100% modulation there will be the addition of two sidebands which together will increase the power output of the transmitter to 1.5 times the carrier power. The use of power saving, where the carrier level depends on the modulation level, will modify this relationship, so that the average power output and consumption of the transmitter will be lowered compared to the absence of such a system. Because the DRM signal has a peak to mean power ratio of approximately 10 dB the transmitter must be operated in a backed off condition in order to avoid the digital signal being clipped within the various stages of the transmitter. Should excessive signal clipping occur within the transmitter, it would cause the generation of in channel intermodulation products. These products would cause inter-symbol interference and this can impact adversely on the receiver performance.

3.4.1.8 DRM reception monitoring

An important part of assuring the quality of any radio transmission comes from monitoring the transmitted signals within the target coverage area. In the case of analogue services, this has generally been accomplished by using a high quality receiver for signal reception. The signal strength is then read from a calibrated meter, whilst making a subjective assessment of the audio quality. Such an assessment has historically been made by someone in the target area tuning a receiver to the required service and then listening to it in real time. More recently, this manual method has been supplemented by using unmanned remotely controlled or scheduled receivers to receive the signals and record the signal strength, together with a sample of the audio. The move to using a digital transmission system enables the monitoring of reception to be completely automated. To this end DRM has developed a specification and protocol for the control interface (RSCI). If manufacturers of professional receivers use this specification it will ensure that an operator can use monitoring receivers of more than one manufacturer to build a monitoring network, but use the same software to control and download data from all these receivers. Furthermore this opens the possibility for several operators or broadcasters to share the same receivers, if they so wish.

Because a DRM transmission uses digital coding it facilitates the recording of data that can characterize the reception quality. This information can include not only the signal strength and audio quality, which can be assessed from the audio bit error rate, but also continuous parameters describing the quality and nature of the transmission channel. Over time the accumulation of this information should lead to an improved understanding of the propagation behaviour of the ionosphere.

Data acquired by the monitoring receiver can be stored locally and downloaded from the reception site on a regular basis, to provide evidence of the performance of a particular transmission, or accessed in near real time. In either case the most likely method of transmitting this information back to the broadcaster will be by means of the Internet, or if that is not available, by directly dialling the receiver using a telephone line and modem connection.

In some cases it may be possible to permanently connect to the monitoring receiver(s) either via the Internet, using broadband, or a local network connection or, perhaps, via VSAT terminals. In any of these cases it becomes possible to acquire information about the quality of the service in the target coverage area on a near real-time basis. In this case, by providing a real time method for collating and analysing the reception data, it becomes possible to optimize the transmission parameters of the service(s) in real time. This optimization process requires the employment of a computer system, which amalgamates the reception data from a number of monitoring receivers in the coverage area. Based on this data, the analysis and prediction algorithm within the computer makes near real-time adjustments to transmission parameters, such as the transmission Mode, MSC modulation and code-rate, to achieve a pre-defined quality of service.

A validation of that concept has been done in the framework of the QoSAM project in 2003 and 2004.

3.5 Market impact

3.5.1 Market complexity; plurality of scenarios and stakeholders

There is no single switchover pattern or formula. Experiences vary according to the local circumstances and from one network to another. Consequently, the general analysis provided here could only be a simplification. The switchover debate tends to focus on terrestrial TV for two reasons: greater difficulties for a market-led digitization than other networks; and higher political stakes and government involvement, mainly because of the pressure to recover spectrum, and a wide-spread perception associating terrestrial with universal free-to-air broadcasting services.

Switchover is a complex and long process involving many variables and affecting more or less directly many parties, namely: users/ consumers, industry and public authorities. Each group can be further subdivided into smaller segments. For instance, users can be categorized according to their attitude towards digital TV: current or potential pay-TV subscribers, assuming that all pay-TV will be digital sooner or later; current or potential free-to-air digital TV viewers, who have bought or are ready to buy a digital receiver; viewers who will be always reluctant to adopt any form of digital TV, pay or free-to-air, for various reasons. The switchover strategies adopted will obviously determine, and be determined by, the respective percentage of each user category. In particular, the extent to which market forces alone can achieve digitization will depend on the number and resilience of consumers reluctant to migrate to digital TV.

Switchover also concerns many industry players, such as content creators, service providers, network operators or equipment manufacturers. Some were already active in the analogue broadcasting market, others look for new business opportunities. Likewise, various departments in national and international administrations are interested in switchover insofar as it affects the achievement of policy objectives.

3.5.2 The case for public intervention

A key question is whether public authorities should intervene to accelerate switchover and/ or otherwise influence the process. That would be justified under *two premises*: first, the extent to which general interests are at stake; that is, how far there are potential benefits and/ or problems for the society as a whole, rather than just for certain groups or individuals. Secondly, market failure; that is, market forces alone fail to deliver in terms of collective welfare. In other words, market

players' behaviour does not fully internalize switchover costs. Assessing the existence and intensity of both premises is largely a matter of political judgement by the competent authority, which, in the case of broadcasting, tends to be national and/ or regional authorities. In any case, such judgement should not be arbitrary but supported by sound market analysis.

As to general interests, potential benefits from digitization can be oriented towards various policy goals: social, cultural, political, economic, etc. Usually there are trade-offs to make between them. For instance, part of the spectrum released by analogue switch-off could be redistributed in order to transfer this resource to operators who would use it to support different services or "reinvested" in broadcasting to improve and extend the service.

The broadcasting sector is not comparable to any other sector, as it plays a central role in modern democratic societies, notably in the development and transmission of social values. Broadcasting offers a unique combination of features. Its widespread penetration provides almost complete coverage of the population across different broadcasting networks; provision of substantial quantities of news and current affairs together with cultural programming mean that it both influences and reflects public opinion and socio-cultural values. Switchover may affect these general interests. It will be important to ensure the continuing availability of a variety of television services, without discrimination and on the basis of equal opportunities, to all parts of the population. In particular, this is a pre-condition for public service broadcasters to fulfil their special obligations.

The likelihood of market failure is linked to the complexity of the environment where switchover takes place, and the interactions between the main parties involved. All have interests to defend and seek to influence the main variables: introduction or not of digital terrestrial TV, speed of the migration and switch-off timing, convenience and type of public intervention. However, coordinated action from the main stakeholders, rather than confrontation of individual strategies, is likely to lead to the collective optimum: a swift and efficient switch-off, with the minimum negative social and economic implications.

At least in the case of terrestrial television and radio, a series of structural failures hinder market cooperation and slow down switchover, notably (free riding) behaviour, oligopoly situations and "chicken and egg" deadlocks. More specifically, the parties benefiting the most from switchover (equipment manufacturers or potential beneficiaries of released spectrum, including new broadcasters) may be different from those likely to bear the costs (final users or current broadcasters). So the latter have little incentive to internalize the costs and contribute to the switchover. Overcoming this kind of situation would require setting up coordination mechanisms to share benefits and costs between all parties involved, ideally with little or no public intervention. In this regard, public authorities, especially those responsible for competition law, must make careful judgements as to the right balance between market competition and cooperation between relevant parties. Those judgements must be based on clear understanding of both market dynamics and policy goals pursued.

3.5.2.1 Modalities

If the need for public intervention is established, decisions must be taken about its modalities, within a coherent switchover strategy. Any intervention should be transparent and proportionate as to the policy objectives pursued, market obstacles, and implementing details. This would provide certainty for all parties to prepare themselves and would limit the scope for arbitrary or discriminatory measures.

Five principles and guidelines for regulatory action can be established. Regulation should:

- Be based on clearly defined policy objectives.
- Be the minimum necessary to meet those objectives.

- Further enhance legal certainty in a dynamic market.
- Aim to be technologically neutral.
- Be enforced as closely as possible to the activities being regulated.

A key area in national switchover strategies is the approach to digital broadcasting licensing and regulatory obligations attached thereto. This involves policy choices on network competition versus complementarity, number of operators, roll-out calendar and map, etc. Otherwise, there is a variety of possible intervention instruments and measures to encourage switchover, ranging from encouragement measures, like information campaigns, to compulsory ones, like analogue turn-off dates, or mandatory standards for equipment including digital tuners. They can also vary according to the parties targeted (consumers, equipment manufacturers, broadcasters, potential users of released spectrum, others). The impact of the planned measures should be evaluated through prospective economic analysis to ensure that the expected cost and benefits are fairly distributed; public policy should not lead to situations where some parties will be forced to bear most switchover costs whilst others will enjoy the benefits.

Timing is a key element of any intervention on switchover. Premature or late action can be useless and even counterproductive insofar as it introduces market distortion. Timely intervention requires good knowledge of market status and evolution, and therefore regular monitoring and analysis. In principle, an early switch-off is likely to be more controversial, but a more distant date may reduce any beneficial impact. In this connection, three main phases can be identified in TV switchover: the take-up phase driven by pay-TV, where sooner or later operators convert subscribers to digital; the consolidation phase, starting now in the countries where digital TV is the most advanced, where some consumers decide to equip themselves with digital devices to receive free-to-air digital TV; the closure phase, where users still not interested in any type of digital TV are forced to adopt it, with or without public support for the acquisition of a digital receiver.

Public intervention can support digital TV penetration in all three phases but stronger measures should be confined to the closure stage, after industry has made all possible efforts to increase consumer uptake. This requires that authorities ensure a favourable and predictable regulatory environment, and intensify their action when the market cannot deliver further. That may be the case when it is considered that digital broadcasting is not progressing quickly enough to achieve policy targets.

3.5.2.2 Risks

Broadcasting has a stronger tradition of policy intervention than other information and communication sectors like telecommunications, where the impact of liberalization has been greater. This is justified by the political and social relevance of broadcasting content, which calls for the enforcement of minimum quality and pluralism requirements. Policy intervention is even greater in the case of terrestrial broadcasting because of its heavy use of spectrum, a scarce public resource, and the already-cited perception associating terrestrial with universal free-to-air TV services.

However, the contexts surrounding the introduction of analogue and digital broadcasting are very different. When analogue broadcasting was introduced, only the terrestrial option existed; there was no competition and the market was entirely shaped by regulatory intervention. Now, there are various types of networks, high market competition and faster technological change. Under these circumstances, the transition to digital broadcasting represents a big industrial challenge that must be led by the market. Intervention from public authorities to facilitate and supervise the process could be justified insofar as general interests are at stake.

The risks from both public intervention or absence of it must be assessed. Non-intervention can result in market failure and jeopardize general interest goals in the sense explained above. As to the risk from public intervention, it includes policy-driven approaches captured by industrial parties seeking to offset commercial risk, thus reducing competition and pressure to innovate. This could result in perverse effects, like “moral hazard” or market inaction, and ultimately slow the switchover process down. In practice, these parties may exaggerate the advantages from digital broadcasting, mixing private and collective benefits. Then, they might persuade authorities to support them (legally, financially or otherwise) in the name of general interests to gain a competitive edge over rivals. If not transparently justified, this could distort the market.

Moreover, public intervention, or the simple announcement of it, that turns out to be inappropriate for any reason (disproportionate, discriminatory, untimely, etc.) can be counterproductive. It can create additional obstacles to digital broadcasting uptake, by stimulating an appetite for more public intervention than would have been necessary otherwise. For instance, if a government announces too early that digital receivers will be offered to all remaining analogue users shortly before analogue switch-off, there will be little incentive for those users to buy receivers. Also, untimely imposition of technical standards that are immature or require costly implementation may discourage investment. Finally, all intervention by national authorities must be compatible with existing law.

3.5.2.3 Policy orientations

As explained, market forces must drive the switchover process focusing on users. The challenge is to stimulate demand so that it is a service-led process rather than a simple infrastructure change with no perceived added-value for citizens. Consequently, the various consumer segments must be offered packages of services and equipment that are attractive to them; that is, stimulating, user-friendly and affordable. This is primarily a task for market players.

There is however also scope for policy intervention considering the social and industrial general interest at stake, and that some key elements of the process are the responsibility of public authorities. Such intervention must be conducted in the first instance by national and/ or regional authorities, which are the most directly responsible for broadcasting content policy and licensing.

3.6 General strategy and coordination

3.6.1 Transparent strategy and monitoring

As indicated, policy transparency improves certainty for market players (including consumers), encourages coordinated action, and ultimately facilitates the switchover. Therefore will be important calls upon Member States to publish by end 2003 their intentions regarding a possible switchover. This could cover, in particular, the way they organize and monitor the process, stakeholder’s involvement, and policy instruments intended to promote switchover.

At ITU level, comparison of national experiences and regular monitoring would provide useful information on policy and market status. This would help identifying possible actions to develop internal market synergies.

3.6.2 Regulation allowing for business autonomy and cooperation

Developing digital broadcasting markets is a complex process requiring significant investment from many players to: roll-out networks, develop enabling technologies, sell terminals, offer compelling services, and encourage user uptake. Industry must have incentives to invest and autonomy to search for winning formulas. This requires a stable regulatory environment, including licensing terms for service operators with a duration that enables an appropriate return on investment, taking into account the additional costs caused by the transition and with the possibility of licence renewal

so as to provide an adequate incentive. Licensing terms should also facilitate provision of sufficient network capacity to support a variety of services.

However, authorities should monitor market evolution, consult with industry, and be ready to review or flexibly interpret conditions relevant to switchover where justified, for example conditions concerning the calendar for roll-out and territorial coverage, technical choices on transmission and terminals, ownership thresholds, price caps, taxes, simulcast extent and timing, or obligations to provide certain programming. Authorities may have trade-offs to make between a faster switchover and other policy objectives, for instance regarding the degree of pluralism, and they need to consider the impact of policy choices on market competition. The challenge is to find the right balance between different policy objectives while respecting legal requirements, in order to maximize collective welfare. For instance, as argued below, coordination and cooperation between different industries is important for switchover. While various public policy objectives can be taken into consideration in this context, competent authorities must ensure maximum transparency regarding such objectives and the necessary means to achieve them. This should go beyond vague references to the goal of digital switchover and/or the Information Society.

Coordinated and synchronized action may be necessary to achieve critical mass. Cooperation between industry players at various levels of the value-chain must be therefore facilitated, especially in the initial market stages, which imply trial and error testing. This can be organized through joint investment and risk sharing schemes for technological research, launch of new equipment and services, and promotion. Authorities may contribute through financing or regulation, as is done in some Member States for both digital TV and radio.

Coordination is particularly relevant in horizontal markets, such as free-to-air broadcasting. Unlike pay broadcasting, no dominant party controls the value-chain and “free-riding” behaviour can result in collective business failure. Sharing responsibility for commercial promotion and consumer after-sale service, notably in face of difficulties with signal reception or receiver equipment, is particularly important.

In the case of digital radio, apart from favourable regulatory frameworks in the Member States, it appears that synchronized implementation across the ITU Member States is important to increase market synergies.

3.6.3 Proportionate and technologically neutral regulation

In terms of political feasibility, switch-off in a given territory can only take place when nearly all households receive digital services. In order to promote the fast and efficient achievement of this objective, all transmission networks should be taken into account (primarily cable, satellite or terrestrial). This approach recognizes that network competition contributes to the roll-out process. This implies a regulatory level playing field. In principle, each network should compete on its own strengths. Any public support for one particular option cannot be excluded but should be justified by well-defined general interests, and implemented in a proportionate way. Otherwise it would appear discriminatory and could jeopardize investments in other networks. In particular, each individual network should not necessarily enjoy the same position in the digital landscape as in the analogue landscape. The objective should be to achieve a fast and efficient switchover. Efficiency should include preserving the general interest missions of broadcasting, while limiting public expense.

Finally, any public financial support to digital broadcasting needs to be compatible with State aids rules and in line with national laws.

3.7 Problems related to the interoperability of systems

In Europe the scenario is as follows.

3.7.1 Digital reception

Ensuring that most users are equipped with digital receivers is the main challenge for switchover and a pre-condition for switch-off. Finding a solution for all receivers in the home, not just the main receiver, just adds to the challenge. The two basic options are digital converters or set-top-boxes connected to analogue receivers, and integrated digital receivers. Moreover, additional reception facilities such as cabling, antennas, dishes, etc. are often necessary.

There must be a large range of digital reception solutions to suit various user segments. This means choice of functionality, price and commercial formulas. Equipment cost is not a major barrier to the consumer of pay-TV services since some pay-TV operators subsidize it, having already deployed millions of set-top-boxes. However, pay-TV will not achieve the widespread penetration of digital TV only. Now the main challenge concerns the creation of “horizontal” markets for unsubsidized receivers supporting free-to-air digital TV services, where consumers pay the full cost from day one. Co-existence of the two business models is important for wide-spread digital TV market penetration.

Availability of cheap receivers is essential to minimize entry barriers for consumers. Most of them must be equipped before the switch-off can take place. Equipment costs should not be much higher than in analogue and services at least comparable, thus offering a cheap entry point to digital TV. This is the way the market seems to go now. Of course consumers should also have options to buy expensive equipment supporting sophisticated services. Service and equipment diversity also contributes to wide-spread digital TV market penetration.

3.7.2 Encouragement to deployment of digital receivers

Free movement of goods within the internal market requires that national authorities do not impose administrative constraints for commercializing digital broadcasting equipment and compulsory technical requirements.

Some ITU Member States envisage public subsidies for digital equipment through schemes aimed at the whole population or just specific groups. The risk with the first scheme is discouraging purchases, including purchases of more sophisticated equipment than the one subsidized. The risk with the second scheme is trading of devices between subsidized and unsubsidized population groups.

Several other forms of incentives have been considered by some Member States, for instance temporary and digressive reduction of the licence fee for homes with digital equipment to encourage fast digital migration, etc. Some Member States allow a reduced rate of VAT on pay-per-view and subscription broadcasting services. The financial implications and parties affected are different, so each option should be carefully analysed and implemented.

3.7.3 Consumer information on digital equipment and switchover

Consumer information is crucial to drive digital equipment sales in a market-led approach to switchover. Consumers should be empowered to plan their own migration rather than being forced and thus deprived by this process. They should be well-informed of the timing and consequences of switchover so as to take their own decisions on services and equipment from a wide range of choices. They must be aware of what various devices can offer, what are the prospects of analogue equipment obsolescence and the possibilities for upgrading. Information and labelling should also be available in accessible formats for consumers with disabilities.

Informing consumers is the responsibility of equipment manufacturers, retailers and service providers, who need to co-ordinate their action and send clear messages whilst respecting competition law. Labelling schemes for analogue and digital equipment, with explanatory notices and/ or logos, based on voluntary industry commitment, would be particularly useful. The goal

would be to send consumers positive and negative signals about, respectively, digital-compliant and analogue-only receiver equipment. This information should mirror national switchover policies, including indicative national or regional switch-off dates. Especially as an analogue switch-off date approaches in a particular Member State, its consumers should be clearly warned about the risks of equipment obsolescence.

Policy intervention in this area has been proposed in some EU and third countries. However, Member States cannot impose *de jure* or *de facto* compulsory labelling schemes without prior notification. Notification enables a compatibility assessment of such measures with internal market rules to be undertaken. Where necessary, a certain degree of harmonization could be envisaged so that the approach to labelling would be common whilst tailoring its implementation to local circumstances, such as national switch-off dates. Labelling specifications could be approved by consumer and standardization bodies.

3.7.4 Integrated digital television receivers

The prohibition of selling analogue-only television receivers according to a staggered calendar has been completely implemented in the United States of America and debated in some EU Member States. All countries would have to implement the obligation more or less simultaneously to preserve homogeneity within the internal market. This would have greater impact in countries where digital penetration remains low and strain the principle of subsidiarity traditionally applied in broadcasting policy.

Although a potential drawback of compulsory integrated digital receivers would be the extra cost for consumers but the increase is likely to be minimal because of economies of scale.

3.7.5 Digital connectivity

Digital connectivity raises copyright security concerns, in particular that insufficiently protected digital content could be illegally copied or distributed. A number of options exist to interconnect digital TV equipment, fulfilling different requirements but it is still unclear which way the market will go in the long term as home networking strategies are implemented.

3.7.6 Interoperability of services

Regarding more sophisticated functionalities such as Application Programme Interfaces (API), interoperable and open solutions for interactive TV services must be encouraged. The Member States will decide whether it is necessary to mandate certain standards to improve interoperability and freedom of choice for users. Indeed, these two criteria will likely contribute to consumer uptake of digital broadcasting in a market-led switchover scenario, thus minimizing the need for public intervention.

3.7.7 Access for users with special needs

Access to digital broadcasting should include citizens with special needs, notably people with disabilities and older persons. However, while digital broadcasting offers greater possibilities than analogue in this area, these are not yet supported by digital equipment in some markets. Harmonized approaches can reduce costs through economies of scale, thus facilitating the marketing of relevant functionalities.

3.7.8 Removal of obstacles to the reception of digital broadcasting

Infrastructure competition stimulates market development, increasing consumer choice, quality of service and price competition. This may be constrained in some areas by legal, administrative or contractual restrictions on the deployment of infrastructure or reception facilities. Authorities will need to arbitrate between promoting digital broadcasting and the fundamental freedom to receive information and services, therefore facilitating network competition, and other policy objectives on

town planning, environmental protection or other areas. With that proviso, national authorities should encourage network competition. By way of example, some Member States have already adopted measures in support of this objective, for instance by requiring the provision of multi-network reception facilities in new apartment blocks, facilitating their installation in existing blocks (for instance by reducing the required threshold of tenant's votes), or by removing restrictive clauses in property or renting contracts. Coordination between national and local authorities is important since local authorities are often responsible for the practical implementation of this type of measure.

3.8 Precautions to control the direct health effects of RF radiation

Recommendation ITU-R BS.1698 contains the precautions to be taken into account. Two groups of people are considered in terms of the precautions that can reasonably be taken. The first group is employees at, or regular official visitors to, transmitting stations. Whilst this group may be at a more frequent risk, the extent to which control measures can be applied is much greater than that for the second group, being members of the general public.

3.8.1 Employee (occupational) precautionary measures

3.8.1.1 Physical measures

Some form of protective barrier must be provided to restrict access to any area where either the basic biological limits are exceeded or contact with exposed RF conductors is possible. Access to such areas must only be possible with the use of a key or some form of tool. Mechanical or electrical interlocking should be provided to enclosures where access for maintenance is needed. Screening of equipment should be sufficiently effective to reduce the level of RF radiation.

Other physical measures such as warning lights or signs should also be used in addition to, but not instead of, protective barriers.

The risk of shock or burns from RF voltages induced on conducting objects, such as fences and support structures, should be minimized by efficient and properly maintained RF earthing arrangements. Particular attention should be paid to the earthing of any temporary cables or wire ropes, such as winch bonds, etc.

Where such objects need to be handled in a RF field, additional protection from shocks or burns should be provided by the wearing of heavy-duty gloves and through effective labelling.

3.8.1.2 Operational procedures

RF radiation risk assessments must be carried out by suitably trained and experienced staff at regular intervals and also when any significant changes are made to a transmitting station. The initial objective must include the identification of the following:

- The areas where people may be exposed to “derived” or “investigation” levels.
- The different groups of people, e.g. employees, site sharers, general public etc., who may be exposed.
- The consequences of fault conditions, such as leakage from RF flanges, antenna misalignment or operational errors.

An initial check on the RF radiation levels can be done by calculation or mathematical modelling, but some sample measurements should also be carried out for verification purposes. In most cases, however, measurements will be needed to determine RF radiation levels more accurately. The actual quantities to be measured (E field, H field, power flux-density, induced current) should be determined based on the specific circumstances. These include station frequencies, field region (near/far field) being measured and whether it is proposed to check compliance with basic

restrictions (SAR) or only “derived/investigation” levels. These circumstances will also largely determine whether the three individual field components should be measured separately or whether an isotropic instrument should be used. RF radiation surveys should then be carried out by staff trained in the use of such instruments, following prescribed measurement procedures, and recording results in a specified format.

A nominated competent person should be made responsible for the identification and provision of suitable types within any organization or company. Such measuring instruments must always be used in accordance with manufacturers’ instructions and be subject to regular functional testing and calibration. Labels showing expiry dates must be fixed to instruments following such tests or calibration. Records of calibration should be kept, including whether adjustments and/or repairs were needed on each occasion. This information should then be used to determine the interval between calibrations.

Systems of work should be implemented that not only ensure that RF radiation limits are not exceeded, but also minimize exposure in terms of time and number of employees. Maintenance work, in areas subject to access restrictions due to high RF radiation levels, should be planned around scheduled transmission breaks or radiation pattern changes where possible. However, there should always be a balance between exposure to RF radiation and other risks, such as working on masts at night, even when floodlit. Where necessary, transmitters should be switched to reduced power or turned off to allow safe access for maintenance or repair work.

Prohibited areas on transmitting stations must be clearly defined and marked, and “permit to work” systems should be implemented. Appropriate arrangements should be put in place for any systems, antennas, combiners or areas shared by other organizations. All staff who regularly work in areas with high levels of RF radiation should be issued with some form of personal alarm or RF hazard meter.

Records must be kept of exposure above specified RF radiation levels. Companies or organizations responsible for operating transmitting stations should monitor the health of staff who regularly work in areas with high levels of RF radiation and take part in epidemiological surveys, where appropriate.

Details of general policies and procedures relating to RF radiation safety should be included in written safety instructions and given to all appropriate staff. In addition, local instructions for each transmitting station should be issued to ensure compliance with such policies and procedures.

Safety training should also include the nature and effects of RF radiation, the medical aspects and safety standards.

3.8.2 Precautionary measures in relation to the general public

3.8.2.1 Physical measures

Similar considerations apply to the general public, as those detailed in § 3.8.1.1 for employees.

Particular attention should be given to areas where RF radiation limits could be exceeded under fault conditions. Protective barriers should be provided in the form of perimeter fencing, suitably earthed where needed. Additional hazard warning signs will probably be necessary.

3.8.2.2 Operational procedures

Risk assessments, carried out under § 3.8.1.2 above, must take into account the possibility of members of the public having medical implants. A procedure for providing health hazard information to such potential visitors should be adopted with appropriate restricted access procedures. Basic RF safety instructions should be provided for regular site visitors.

The need to carry out RF radiation surveys beyond site boundaries must be considered, in particular where induced voltages in external metallic structures (cranes, bridges, buildings etc.) may cause minor burns or shock. In carrying out such surveys the possibility of the field strength increasing with distance, usually due to rising terrain, should be taken into account. Where necessary, a procedure for monitoring planning applications or other development proposals should be implemented.

An example which illustrates the text above is given in § 3.10 and Figs 33 and 34 of this Report.

3.9 Precautions to control the indirect RF radiation hazards

Indirect effects of RF radiation, such as ignition hazards to flammable substances, may occur at levels well below the “derived/investigation” levels particularly at MF/HF. This is because flammable substances may be stored on a site having associated conducting structures, such as pipe work, that could act as a fairly efficient receiving antenna. Actual risks are, however, rare, but may include industrial processing plants, fuel storage facilities and petrol filling stations. Detailed evaluation is, however, far from simple. The general procedure recommended below is, therefore, based on progressive elimination. The detailed precautions adopted will however need to take account of any national standards or legislation in the country concerned.

An initial assessment should be carried out, based on practical, worst case estimates, of the minimum separation needed between a particular type of transmitter and a conducting structure to avoid such a hazard. The first step in doing this is to determine the minimum field strength that might present an ignition hazard for the particular transmitter frequencies in use. This is a function of the type of flammable substance and the perimeter of any loop formed by metallic structures, usually pipe work, and can most easily be determined from tables or graphs. The vulnerable area should then be determined from this minimum field strength by calculation, mathematical modelling or from tables/graphs.

If the vulnerable area, as determined above, contains any such sites on which flammable substances are stored, or if any are being planned, a more detailed assessment should then be made. This should be based on the actual dimensions of any metallic structures, the gas category of the flammable substance(s) being stored and the measured field strength. This detailed assessment should be carried out by calculation of the extractable power from the metallic structure to determine whether this exceeds the minimum ignition energy of the flammable substance. Should this be the case, then the extractable power should be measured and any necessary modifications to the structure and/or other safeguards implemented.

In a similar category to ignition hazards, is the possible detonation of explosive materials. This will very rarely be encountered but detailed guidance is available from national standards, such as BS 6657 in the United Kingdom. Other indirect effects that should be considered include interference to the safety systems of vehicles, machines, cranes etc. close to, or within the boundaries of, transmitting stations. The immunity of these systems is covered by electromagnetic compatibility (EMC) regulations and CISPR.

Where necessary, precautions similar in principle to those described above may need to be applied.

3.10 Field-strength values to be determined

Preliminary, using data given by a number of international and national authorities concerned with the health aspects of EMFs, the range of electrical and magnetic field strengths are shown in Figs 33 and 34, respectively.

These curves/graphs should not be used as a basis for an administration’s regulatory requirements. They represent a composite view of the limits currently depicted and are certain to evolve over

time. As such, they are merely illustrative of the methodology that could be applied to develop useful standards within an administration.

Also, it must be recognized that results of independent studies of the subject are not entirely consistent and as a result the interpretation of the results by responsible authorities has in the past and will continue in the future to result in differing requirements in different countries.

FIGURE 33
The range of the electrical field strengths derived from the tables given by international and national authorities concerned with the health aspects of EMFs

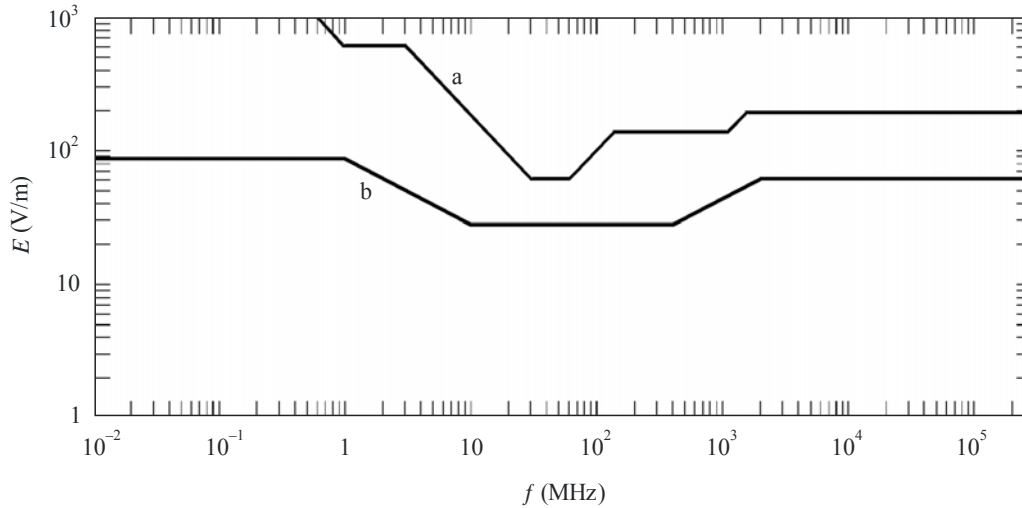

Report BT.2140-33

The curves “a” and “b” represent the upper and lower boundaries respectively of some known, existing recommendations for RF exposures levels (presented in this section, as example). All curves from authorities making such recommendation lie between these boundaries, and any curve between curves “a” and “b” should allow adequate broadcasting services.

FIGURE 34
The range of the magnetic field strengths derived from the tables given by international and national authorities concerned with the health aspects of EMFs

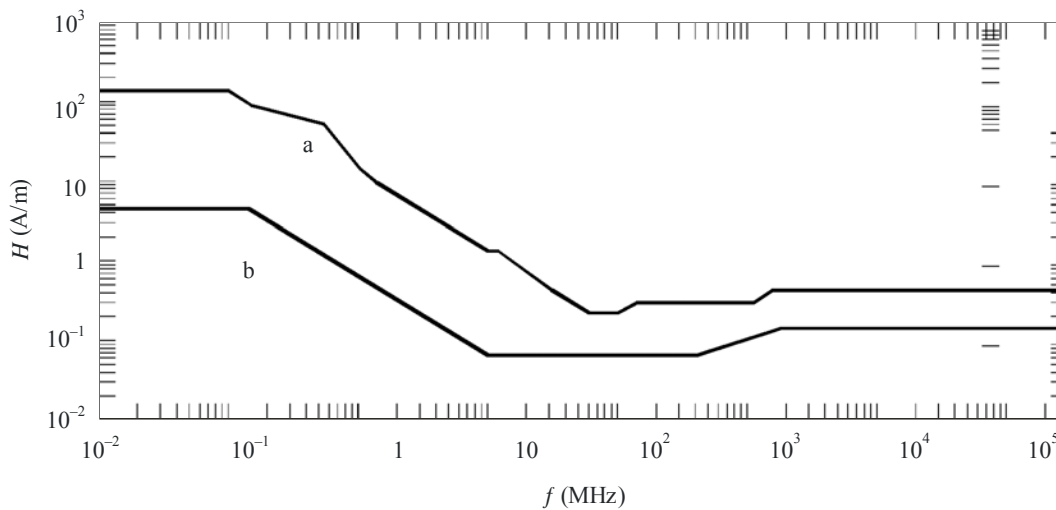

Report BT.2140-34

The curves “a” and “b” represent the upper and lower boundaries respectively of some known, existing recommendations for RF exposures levels (presented here, as example). All curves from authorities making such recommendation lie between these boundaries, and any curve between curves “a” and “b” should allow adequate broadcasting services.

The differences between the suggested maximum levels at the same frequency (see Figs 33 and 34) depend on different conditions considered by the various sources suggesting the limits.

3.11 Additional evaluation methods

3.11.1 Dosimetry

The application of dosimetric concepts enables the link to be established between external (i.e. outside the body) field strengths and internal quantities of electric field strength, induced current density and the energy absorption rate in tissues. The development of experimental and numerical dosimetry has been complementary. Both approaches necessitate approximations to the simulation of human exposure; however the development of tissue equivalent materials and minimally disturbing probes in the experimental domain and the use of anatomically realistic models for computational purposes have improved the understanding of the interaction of RF fields with the body.

Whereas current density is the quantity most clearly related to the biological effects at low frequencies, it is the specific energy absorption rate (SAR), which becomes the more significant quantity as frequencies increase towards wavelengths comparable to the human body dimensions.

In most exposure situations the SAR can only be inferred from measured field strengths in the environment using dosimetric models. At frequencies below 100 MHz non-invasive techniques have been used to measure induced current, and in extended uniform fields, external electric field strengths have been related to induced current as a function of frequency. In the body resonance region, exposures of practical significance arise in the reactive near field where coupling of the incident field with the body is difficult to establish owing to non-uniformity of the field and changing alignment between field and body. In addition, localized increases in current density and SAR may arise in parts of the body as a consequence of the restricted geometrical cross-section of the more conductive tissues.

Dosimetric quantities can be calculated by use of suitable numeric procedures and calculational models of the human body. On the other hand such quantities can be measured using suitable physical models (phantoms).

3.11.2 Specific absorption rate measurement

The specific absorption rate (SAR) (W/kg), is the basic limit quantity of most RF exposure regulations and standards. SAR is a measure of the rate of electromagnetic energy dissipated per unit mass of tissue.

The SAR may be specified as the value normalized over the whole body mass (sometimes referred to as the “whole body averaged SAR”) or the localized value over a small volume of tissue (“localized SAR”).

SAR can be ascertained from the internal quantities in three ways, as indicated by the following equation:

$$\text{SAR} = \frac{\sigma E^2}{\rho} = C_i \frac{dT}{dt} = \frac{J^2}{\sigma \rho}$$

where:

E : value of the internal electric field strength in the body tissue (V/m)

σ : conductivity of body tissue (S/m)

ρ : density of body tissue (kg/m)

C^i : heat capacity of body tissue (J/kg °C)

dT/dt : time derivative of temperature in body tissue (C/s)

J : value of the induced current density in the body tissue (A/m).

The local SAR in an incremental mass (dm) is defined as the time derivative of the incremental absorbed energy (dW) divided by the mass:

$$\text{SAR} = d/dt (dW/dm)$$

This quantity value is important from two standpoints; the resulting non-uniform distribution of energy absorption when exposed to a uniform plane wave, and the localized energy absorption arising from non-uniform fields in close proximity to a source of exposure.

Exposure regulations or standards contain derived electric and magnetic field limits. The underlying dosimetric concept assures that compliance with the (external) derived levels will assure compliance with the basic SAR limits. However, external or internal SAR measurements can also be used to show compliance. For partial-body near-field exposure conditions, the external electromagnetic fields may be difficult to measure, or may exceed the derived limits although the local SAR is below the basic limits. In these cases internal SAR measurements in body models have to be conducted. The most important methods to measure SAR will be described below.

3.11.3 Electric field measurement

The SAR is also proportional to the squared RMS electric field strength E (V/m) inside the exposed tissue:

$$\text{SAR} = \sigma E^2 / \rho$$

where σ (S/m) is the conductivity and ρ (kg/m³) is the mass density of the tissue material at the position of interest. Using an isotropic electric field probe, the local SAR inside an irradiated body model can be determined. By moving the probe and repeating the electric field measurements in the whole body or in a part of the body, the SAR distribution and the whole body or partial-body averaged SAR values can be determined. A single electric field measurement takes only a few seconds, which means that three-dimensional SAR distributions can be determined with high spatial resolution and with a reasonable measurement time (typically less than an hour).

3.11.4 Temperature measurement

The SAR is proportional to initial rate of temperature rise dT/dt (C/s) in the tissue of an exposed object:

$$\text{SAR} = c \Delta T / \Delta t$$

where c is the specific heat capacity of the tissue material (J/kgC). Using certain temperature probes, the local SAR inside an irradiated body model can be determined. One or more probes are used to determine the temperature rise ΔT during a short exposure time Δt (typically less than 30 s to prevent heat transfer). The initial rate of temperature rise is approximated by $\Delta T / \Delta t$, and the local SAR value is calculated for each measurement position. By repeating the temperature measurements in the whole body or in a part of the body, the SAR distribution and the whole-body or partial-body averaged SAR values can be determined.

Three-dimensional SAR-distribution measurements are very time consuming due to the large number of measurement points. To achieve a reasonable measurement time the number of points has to be limited. This means that it is very difficult to measure strongly non-uniform SAR distributions accurately. The accuracy of temperature measurements may also be affected by thermal conduction and convection during measurements, or between measurements.

3.11.5 Calorimetric measurement

The whole-body average SAR can be determined using calorimetric methods. In a normal calorimetric measurement, a full-size or scaled body model at thermal equilibrium is irradiated for a period of time. A calorimeter is then used to measure the heat flow from the body, until the model is at thermal equilibrium again. The obtained total absorbed energy is then divided by the exposure time and the mass of the body model, which gives the whole-body SAR. The calorimetric twin-well technique uses two calorimeters and two identical body models. One of the models is irradiated, and the other one is used as a thermal reference. This means that the measurement can be performed under less well-controlled thermal conditions than a normal calorimetric measurement.

Calorimetric measurements give rather accurate determinations of whole-body SAR, but do not give any information about the internal SAR distribution. To get accurate results a sufficient amount of energy deposition is required. The total time of a measurement, which is determined by the time to reach thermal equilibrium after exposure, may be up to several hours. Partial body SAR can be measured by using partial-body phantoms and small calorimeters.

3.11.6 Body current measurement

Measurement devices for body current may be carried out in two categories:

- Measurement devices for body to ground current.
- Measurement devices for contact current.

3.11.6.1 Induced body currents

Internal body currents are induced in persons occur from partial or whole-body exposure of the body to RF fields in the absence of contact with objects other than the ground.

The two principal techniques used for measuring body currents include clamp-on type (solenoidal) current transformers for measuring current flowing in the limbs, and parallel plate systems that permit the measurement of currents flowing to ground through the feet.

Clamp-on current transformer instruments have been developed that can be worn.

The meter unit is mounted either directly on the transformer or connected through a fibre-optic link to provide a display of the current flowing in a limb around which the current transformer is clamped. Current sensing in these units may be accomplished using either narrow-band techniques, e.g. spectrum analysers or tuned receivers (which offer the advantage of being able to determine the frequency distribution of the induced current in multi-source environments, or broadband techniques using diode detection or thermal conversion.

Instruments have been designed to provide true r.m.s. indications in the presence of multiple frequencies and/or amplitude-modulated waveforms.

The upper frequency response of current transformers is usually limited to about 100 MHz however air cored transformers (as opposed to ferrite-cored), have been used to extend the upper frequency response of these instruments. Whilst air-cored transformers are lighter and therefore useful for longer term measurements, they are significantly less sensitive than ferrite cored devices.

An alternative to the clamp-on device is the parallel plate system. In this instrument, the body current flows through the feet to a conductive top plate, through some form of current sensor

mounted between the plates, and thereby to ground. The current flowing between the top and bottom plates may be determined by measuring the RF voltage drop across a low impedance resistor. Alternatively, a small aperture RF current transformer or a vacuum thermocouple may be used to measure the current flowing through the conductor between the two plates.

Instruments with a flat frequency response between 3 kHz and 100 MHz are available.

There are several issues that should be considered when selecting an instrument for measuring induced current.

Firstly, stand-on meters are subject to the influence of electric-field induced displacement currents from fields terminating on the top plate. Investigations have shown that apparent errors arising in the absence of a person are not material to the operation of the meters when a person is present.

Secondly, the sum of both ankle currents measured with clamp-on type metres tends to be slightly greater than the corresponding value indicated with plate type meters. The magnitude of this effect, which is a function the RF frequency and meter geometry, is not likely to be material. Nonetheless, the more accurate method of assessing limb currents is the current transformer. The precise method of measurement may depend upon the requirements of protection guidelines against which compliance assessments are made.

Thirdly, the ability to measure induced currents in limbs under realistic grounding conditions such as found in practice need to be considered. In particular, the differing degree of electrical contact between the ground and bottom plate of the parallel plate system and the actual ground surface may affect the apparent current flowing to ground (Ref.).

Measurements can be made using antennas designed to be equivalent to a person. This enables a standardized approach to be used and permit current measurements to be made without the need for people to be exposed to potentially hazardous currents and fields.

3.11.7 Contact current measurement

The current measurement device has to be inserted between the hand of the person and the conductive object. The measurement technique may consist of a metallic probe (definite contact area) to be held by hand at one end of the probe while the other end is touched to the conductive object. A clamp-on current sensor (current transformer) can be used to measure the contact current which is flowing into the hand in contact with the conductive object.

Alternative methods are:

- the measurement of the potential difference (voltage drop) across a non-inductive resistor (resistance range of 5-10 Ω) connected in series between the object and the metallic probe holding in hand;
- a thermocouple milliammeter placed directly in series.

The wiring connections and the current meter must be set up in such way that interference and errors due to “pick-up” are minimized.

In the case where excessively high currents are expected an electrical network of resistors and capacitors can simulate the body’s equivalent impedance.

3.11.8 Touch voltage measurement

The touch voltage (no-load-voltage) is measured by means of a suitable voltmeter or oscilloscope for the frequency range under consideration. The measurement devices are connected between the conductive object charged by field induced voltage and reference potential (ground). The input impedance of the voltmeter must not be smaller than 10 k Ω .

3.12 Legal consideration

The legal and health aspects connected with the safety for R.F. services are strategic for the project of one transmitting centre. The values of the field strength should be compatible with the security of neighbouring living people and with the house TV set, telephones, and household appliances. Not only the medical aiding equipment but also the pacemaker, hearing aid systems and other personal aids, may suffer from radio-frequencies interference.

The levels indicated in Fig. 33 of § 3.10 are accepted levels to be maintained at the border of the transmission centre land. The above levels are considered suitable for a radioservice and are to be considered valid also for the quality of a radioservice. Consequently, from the above levels one derives the extension of the controlled area and the location of one transmission centre. Naturally, a transmitter centre located inside a city has much more constraints in comparison with a transmitter centre located in the countryside. Each administration or broadcaster may choose the values of the e.m. reference field (see Fig. 33), but, if the value is too low: either the radio services do not have the necessary quality (e.g. because the e.r.p. cannot reach the necessary values), or the necessary land extension is too large with consequent high cost for the construction of the transmission centre.

Currently the sensitivity of the people living near the transmitter centres, is very high for possible problems caused by the radio frequency. For legal consideration one clear indication of the perimeter and extension of the controlled area (where the values of e.m.f. are higher or equal to the values of Fig. 33) should be clearly indicated: one fence, one wall or, at least some appropriate signposting, with indication of e.m.f. value, need to be installed.

From urbanization point of view the construction of residential buildings must be forbidden inside the controlled area. The above aspects connected with the e.m.f. must be treated in the same manner as the ambient ecologic, landscape and panorama problems.

Appendix 1

to Part 2

1 Australia

1.1 Digital terrestrial television broadcasting in Australia

Australia is served by an extensive network of DVB-T digital, terrestrial television broadcasting transmitting sites. A feature of the transmitter deployments in Australia is that a very large proportion of the population receives signals from a relatively small number of high power “main station” transmitters that have large coverage areas, typically 100-150 km in diameter. Radiated power levels at main station VHF Band III digital transmitters can be up to 150 kW e.r.p. The radiated power levels at main station UHF Band IV and V transmitters can be up to 895 kW e.r.p.

As a consequence of an initially sparse distribution of terrestrial transmitter sites, analogue main station assignments in Australia were generally planned on the basis of noise-limited reception rather than interference limited reception. This meant that the so-called analogue taboo channels (e.g. adjacent channels, image channels and local-oscillator channels) were usually unencumbered

by other (out-of-area) TV signals³. Most of the population of Australia had access to five free-to-air analogue TV services.

Australian digital television services commenced in metropolitan regions on 1 January 2001 and were progressively deployed in regional areas and then to some remote areas. The relevant federal government legislation originally stipulated a simulcast period of eight years. During the simulcast period, existing analogue television transmissions continued and an additional digital signal was brought into service. The digital service was required to carry a standard definition (SDTV) digital version of the programmes being provided on the analogue service (more discussion on the regulatory framework for the introduction of digital television services is given in § 1.7).

In December 2007 the Australian Government changed the simulcast period, announcing that 31 December 2013 will be the date by which the last analogue transmissions will be switched off. Subsequently, a timetable was set for the progressive area by area switchover from June 2010 to December 2013.

1.2 DTTB System Selection

The first step in the DTV conversion process was a comparative assessment process that led to the selection of DVB-T as the preferred digital television transmission standard and the determination of system planning parameters such as interference protection ratios and minimum required signal levels.

The availability of this information permitted the conduct of a preliminary study of possible DTV channel allocations. The conclusions of this preliminary study showed that it would be possible to allocate a complete TV channel (7 MHz wide in Australia at both VHF and UHF) to each existing analogue service to permit its conversion to DTV as well as provide additional channels for new digital-only services.

In 1998 legislation that set the framework for the establishment of DTV services was passed by the Australian Parliament. In that legislation the government determined that each broadcaster would be loaned spectrum to provide a digital service that matched the coverage of the analogue service as closely as possible. Further legislation was also enacted to establish the detail of the regulatory regime to apply to the provision of digital television and datacasting.

1.3 Simulcast of SDTV and HDTV programmes

The Australian Government committed to ensuring that digital television would be as affordable as possible. Although broadcasters were required to provide at least a minimum amount of high definition television programming for those who could afford HDTV sets, they were also required to provide their broadcast in SDTV format. SDTV programming provided viewers with a picture quality that is generally superior to the analogue television service. Two additional SDTV digital-only programme streams were transmitted on national broadcaster networks and three more commercial SDTV programme streams were available from 1 January 2009. The transmission of SDTV format programming not only provided viewers with the ability to access the additional features of digital broadcasting, but also gave viewers a digital conversion path that was cheaper than the alternative approach of purchasing a HDTV set or a HD set top box.

HDTV was a key feature of the introduction of digital terrestrial television in Australia. Broadcasters were required to transmit HDTV programmes for a minimum of 1 040 hours per year. The government did not specify any particular technical parameters for HDTV, and broadcasters

³ As the number of services and the density of transmitter sites has increased, planning of later services, especially repeater services, has more typically been on an interference limited basis.

have been able to adopt and use the MPEG-2 MP@HL format for transmission (i.e. 576/50p, 720/50p, 1080/50i). However, Australian broadcasters expressed a preference that programme production and exchange should be based on 1080i line formats.

By requiring both SDTV and HDTV programming, viewers were given a choice in digital television products but at the same time allowed broadcasters scope to demonstrate the appeal of HDTV.

1.4 Use of single frequency networks

Digital television services were introduced in Australia, using either a multi-frequency network (MFN) or a single frequency network (SFN) approach. In either case, the digital television service is provided from a network that consists of a high-powered central (or parent) transmitter that may be supported by, or contribute signal to off-air feed, a number of low-powered in-fill or area-extension re-transmitters.

In the MFN case, the re-transmitters operate on a different channel (or channels) from the parent transmitter while, in the SFN case, the re-transmitters either operate on the same channel as the parent transmitter (if not an off air feed); or on another channel in one or more SFN re-transmission networks, which could be off air feed from the parent⁴.

In the latter case, the parent transmitter is operated in the MFN mode, albeit with SFN timing information embedded into the signal for use by the SFN re-transmission network(s). In a few cases more than one parent transmitter, together with their re-transmitters operate as an SFN.

1.5 Planning parameters and interference threshold limits

Australia's planning for digital television services has taken into account a legislated requirement that "... in SDTV digital mode in that area should achieve the same level of coverage and potential reception quality as is achieved by the transmission of that service in analog mode in the same area". Following this approach, Australia's digital services were typically planned with a maximum e.r.p. of 6 dB less than same band analogue television services.

Planning guidelines in Australia also specified minimum median field strengths (referred to a measurement height of 10 m above local terrain) of 44, 50 and 54 dB(μ V/m) for Band III, IV and V digital television services respectively⁵. To minimize the "cliff-effect", digital television services were planned to achieve the required protection ratio for better than 99% of the time, irrespective of whether the interference is considered to be continuous or tropospheric in nature.

1.6 Comparison of ITU-R and Australian television planning parameters

The following text summarizes differences between Australian television planning parameters, including minimum field strengths and protection ratios and the corresponding Recommendation ITU-R BT.1368 parameters for the protection of DVB-T digital television services.

Australian planning for digital terrestrial television is based on an assumption of fixed reception using outdoor receiving antennas. Therefore protection ratios relevant to Ricean channels are used where available. The DVB-T mode 64-QAM with 2/3 FEC and a 1/8 guard interval was originally adopted as the basis for digital television planning. Subsequently the guard interval assumed in

⁴ In a limited number of cases a parent station may feed several SFNs that may each operate on a different channel.

⁵ Refer to the ACMA website, www.acma.gov.au.

planning was revised to 1/16 (refer section 4). However to achieve a higher picture quality for the SD/HD simulcast, most broadcasters have selected 64-QAM with 3/4 FEC and 1/16 guard interval.

1.6.1 Digital television minimum median field strengths

Australian digital television planning is based on provision of minimum median field strength levels in rural environments of 44, 50 and 54 dB(μ V/m) in Bands III, IV and V respectively. These values are reasonably close to the values that can be derived from the sample calculation value provided in Table 53 (§ 6) of Annex 2 to Recommendation ITU-R BT.1368-10, once a location correction factor⁶, bandwidth adjustment⁷ and interference margin⁸ are applied. The Australian values for rural environments are, respectively, 0.3 and 0.1 dB lower, and 1.8 dB higher than values that would be derived from the Recommendation, for Bands III, IV and V, respectively.

The differences are due to: inclusion of a 1 dB higher receiver noise figure allowance in Bands III and V; inclusion of a 1 dB allowance for man-made noise in VHF Band III; different combinations of antenna gain/feeder loss in Bands III and IV; and, use of frequencies at the top rather than the middle of each band as the reference frequency for the calculation.

1.6.2 Digital television protection ratios

Protection ratios for digital-digital co-channel and adjacent channel interference from other television broadcasting services were first defined in July 1999⁹. Only minor changes have been made to those original values. The values used in Australian planning are the same as the 64-QAM, 2/3 FEC values set out for DVB-T interfered with by DVB-T in Tables 15 and 17 of Recommendation ITU-R BT.1368-10.

The relevant protection ratios are not to be exceeded for more than 1% of the time. That is, the E(50,1) value is used for the interfering field strength.

1.7 Regulatory framework

To facilitate the transition from analogue to digital broadcasting, the Australian Communications and Media Authority (ACMA) was required to prepare digital channel plans (DCPs) that determined the channels to be allotted in each area and assigned to each broadcaster as well as the technical limitations and characteristics of those channels. The ACMA's objective in preparing the DCPs was to enable a broadcaster to plan its digital transmission coverage to match its analog coverage. Further, each broadcaster was required to prepare implementation plans relating to the conversion of their services to digital.

To underpin the development of the DCPs, the ACMA developed and promulgated technical planning documents setting out the general and technical assumptions that were to be used for planning the rollout of digital television services.

⁶ Australian planning is based on provision of a service at 80% of locations within 200 m by 200 m areas for rural environments. A 4.5 dB correction factor is applied to convert from a 50% of locations to an 80% locations field strength value.

⁷ A 0.5 dB lower noise power applies due to the receiver bandwidth being 6.7 rather than 7.6 MHz.

⁸ The minimum field strength calculations also include a 1 dB "interference margin" for the support of co-channel frequency reuse planning.

⁹ The original 1999 values were adopted following protection ratio measurements made in 1998 using the "traditional" wanted-to-unwanted protection ratio measurement approach, rather than the $C/(I + N)$ approach that is now included in Recommendation ITU-R BT.1368.

Digital channel plans were developed in four stages. During the first stage, main station channels for the metropolitan licence areas of Sydney, Melbourne, Brisbane, Adelaide and Perth and some other priority areas were completed. These areas were revisited in the second stage through a variation to the DCP. Variations included planning for additional digital services and digital repeater sites. DCPs for regional areas of Australia were developed during stage three and DCPs for remote areas prepared during stage four.

1.8 Digital switchover

The Australian Government established a Digital Switchover Taskforce to coordinate and oversee the transition to digital from analogue television.

Its objectives are to:

- advise government on policy settings, implementation and issues connected with digital switchover;
- develop and implement a program framework, including a switchover timetable, to complete the switchover from analogue to digital television transmission in Australia by the end of 2013;
- manage an information and education program explaining the switchover process to all Australians setting out what they will need to do and how to get further information; and
- convene meetings of an industry advisory group consisting of stakeholders – including broadcasters, retailers, manufacturers, antenna technicians and public and commercial housing agencies, government departments – and coordinate these to utilize their expertise in delivering switchover by the end of 2013.

1.9 Digital dividend

In June 2010, the Australian Government announced that a digital dividend of 126 MHz of 700 MHz band spectrum, comprised of Australian UHF television channels 52 to 69, will be realized. The digital dividend is made possible by the move to digital-only television broadcasting under the digital television switchover program. The final step to realizing the digital dividend is for a significant number of digital television services to be moved to new channels so that channels 52 to 69 can be cleared and made available for new services such as wireless broadband.

The digital dividend channel changes will take place affecting approximately 450 geographic coverage areas across Australia.

1.10 Planning the restack of DTTB to achieve the digital dividend

The process of clearing digital television services from the digital dividend band (694-820 MHz) is often referred to as the restacking of digital services or 'restack'. After the restack is complete, all digital television services will operate in the remaining UHF broadcasting spectrum of 520-694 MHz and VHF broadcasting spectrum of 174-230 MHz.

At the outset of the restack planning process, the Australian Government provided a series of Ministerial objectives:

- the requirement to clear the dividend band (694-820 MHz);
- the requirement to complete restack as soon as possible after the final switchover day (with a target of end 2014);
- the number of services to be planned at each location (generally 6 but 9 in licence overlap areas);
- the retention of VHF spectrum for digital radio purposes (14 MHz); and

- specific planning arrangements for metropolitan area main transmission sites (all services to be in VHF).

The requirement to consider viewer and broadcaster costs and viewer disruption resulting from any changes that are not necessary for, or consequential to, the achievement of the policy objectives of the minister's direction. The restack activity has two major phases of work. The first was the development of revised channel plans and sequencing plans that identify the final channels that digital television services will move to and the order in which the moves will need to occur. The second was the implementation of those channel changes by broadcasters.

1.10.1 Restack channel planning

A Restack Planning Advisory Group (RPAG) was established by the ACMA to consult industry on the restacking of digital television services to clear the digital dividend. The RPAG was an informal group as it was not constituted under any legislative provisions. The RPAG provided a forum for the ACMA and industry to discuss proposals relating to replanning of digital television channels to facilitate the restack as well as restack implementation and timing issues. The RPAG was an important part of the process for the development of formal instruments but it did not replace public consultation on formal instruments. After discussion within the RPAG forum, and a formal public consultation, in May 2011 the ACMA adopted a series of restack objectives and principles. The objectives were:

- 1 clear the digital dividend band of broadcasting services as soon as practicable;
- 2 plan for six digital channels at each transmission site¹⁰;
- 3 plan for six VHF channels at all metropolitan main station sites;
- 4 plan such that coverage of all six channels is similar;
- 5 maintain or improve digital television coverage;
- 6 simplify viewer reception of terrestrial digital television;
- 7 establish spectrum planning arrangements that support future needs;
- 8 retain 14 MHz of spectrum in VHF Band III for possible expansion of digital radio;
- 9 comply with the legislated framework;
- 10 consistent with the minister's direction, the ACMA should wherever possible:
 - a) minimize viewer costs and disruption;
 - b) minimize commercial and national broadcaster costs.

The restack planning principles were as follows:

Principle 1: Replan digital television services to use VHF channels 6-12 and UHF channels 28-51.

Principle 2: Create a digital radio sub-band, comprising VHF television channels 9 and 9A, that is clear of digital television in metropolitan and regional licence areas. Where practicable, also avoid planning new services on these channels in remote licence areas.

Principle 3: Plan for six digital channels at each transmission site, except for

- i) licence area overlaps where two sets of three commercial services will require channels (a total of nine channels) and;
- ii) where broadcasters operate from different sites but cover the same area.

Principle 4: Plan channels so that viewers in metropolitan and regional licence areas can receive all services using a single band antenna (i.e. plan all channels in either the VHF or UHF band).

¹⁰ In licence area overlap regions, nine services per site would be planned at existing transmission sites.

Consider the benefit of single band operation in other areas on a case-by-case basis. The current polarization of the existing transmissions in a particular band at each transmission site is to be maintained.

Principle 5: Plan all six services on channels within defined blocks of channels as follows:

Block A: 6, 7, 8, 10, 11 and 12*

Block B: 28, 29, 30, 31, 32 and 33

Block C: 34, 35, 36, 37, 38 and 39

Block D: 40, 41, 42, 43, 44 and 45

Block E: 46, 47, 48, 49, 50, and 51.

* Channels 9 and 9A may be used for digital TV in some remote areas.

Principle 6: Assign channels within a block as follows.

VHF: Existing VHF services to retain current channels unless they have to move to clear channels 9 and 9A under Principle 2. New or changed channel assignments do not need to follow any particular order, except in all Metropolitan areas where SBS should move to channel 7. Where it is possible without moving existing services, channel 10 should be the unassigned channel to align with the metropolitan area unassigned channel.

UHF: Channel assignments should be made after considering and balancing a number of objectives including:

- avoiding off-air input issues (adjacent channel and N+5)
- avoiding changes to existing services within the block
- using the unassigned channel to remove restack timing constraints and manage band edge interference potential.

If none of the above issues apply, UHF channels should be assigned in the following order: SBS, ABC, Seven (or affiliate), Nine (or affiliate), Ten (or affiliate), Unassigned.

Principle 7: In selecting the channel block for a transmission site:

- Consider the channels used by existing digital services and any information available on the operating frequency range of broadcaster transmission equipment.
- Avoid use of a block outside the likely bandwidth of viewer antennas. In particular, avoid Block B where there is no current or past use of UHF Band IV channels. Where this cannot be avoided, minimize the total population affected.
- Wherever sites utilize UHF channel blocks, attempt to place high power services on lower UHF channel blocks.

Principle 8: Break up wide area single frequency networks (SFNs) known to have associated reception problems and minimize use of new SFNs where possible.

Principle 9: Plan on the basis of broadcasters using the DVB-T standard with transmission parameters of 8k, 64QAM, 2/3 forward error correction (FEC) and 1/16 guard interval.

The co-channel protection ratio used for planning will be: 20 dB

The minimum median field strengths used for planning will be:

Minimum median field strengths for digital television planning (dBµV/m)

	VHF (Block A) (174-230 MHz)			UHF (Blocks B and C) (526-610 MHz)			UHF (Blocks D and E) (610-694 MHz)		
	Rural	Suburban	Urban	Rural	Suburban	Urban	Rural	Suburban	Urban
Minimum median field strength (dBµV/m)	44	57	66	50	63	71	54	67	74

Principle 10: Equalize transmissions across all broadcasters as far as practicable through planning on the basis of equal ERP levels, identical antenna patterns, closely sited transmitters and all broadcasters having the same SFN arrangement.

Principle 11: Determine the timing constraints on channel availability and specify a minimum window of six months, where practicable, when both the current digital and the final digital channels are available. When all sites and timing windows are considered together, they should result in the digital dividend channels (52-69) being cleared as soon as practicable, and by the end of 2014 at the latest.

Principle 5 gave effect to a unique characteristic of the Australian planning which was the adoption of the “contiguous channel block model”.

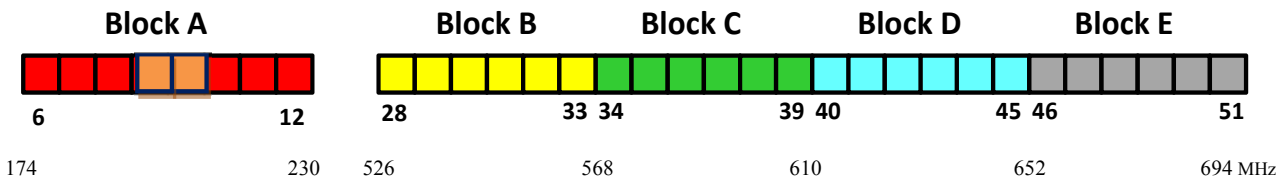

It was considered that aggregating all broadcast services that serve a particular area into one frequency range would equalize reception quality for all services – viewers that could receive one service would be much more likely to be able to receive all services (previously, under “interleaved” planning where services were widely spread across a band or across VHF and UHF Bands, this was sometimes not the case).

It is also noted that under Principle 2 Australian VHF channels 9 and 9A are being left clear for possible digital radio use in metropolitan and regional areas. DAB+ digital radio services commenced in the five major capital cities in July 2009.

1.10.2 Television licence area plans

Following discussions with the industry through the RPAG, the proposed restack channel planning proposals have been codified in draft instruments known as Television Licence Area Plans (TLAPs). These instruments identified the channel allotments each digital television service will need to move to, if it needs to change, and by when the changes need to be made. The draft instruments were made available for a period of formal public comment before being considered for approval by the ACMA.

1.10.3 Indicative restack channel chart

Detailed restack channel planning work commenced in 2011 and continued until late 2012. In the early stages of channel planning, to provide a framework that allowed the detailed channel planning for each licence area to proceed relatively independently, a 'key sites indicative channel plan' was developed. It has now been superseded by a more comprehensive *Indicative Channel Chart* that consolidates in a single spreadsheet the detailed channel planning work that the ACMA has performed for each of the television licence areas.

1.10.4 Implementation of the restack

The Australian Government has committed to:

- relocate commercial and national broadcasters' digital television services to their new channels by retuning, replacing or otherwise modifying transmission equipment to operate below UHF channel 52 (694 MHz);
- provide a project and implementation manager to manage channel changes nationally; and
- conduct a public education/information campaign about the need to retune receivers.

Generally, digital dividend channel changes will take place once digital television switchover has occurred in an area.

Viewers will not need to purchase new television reception equipment, but will generally need to retune their existing television, set top box or digital recorder to be able to continue viewing free-to-air services that have undergone a channel change.

The Australian Government expects that the channel changes will be completed by 31 December 2014.

A channel change timetable schedule that advises of nationwide activities and particularly public retune dates to ensure the program is delivered by 31 December 2014, was published on the website of the Department of Broadband, Communications and the Digital Economy (www.dbcde.gov.au).

2 Brazil

2.1 National Policies

The Brazilian digital television system Project (SBTVD) was established with the purpose of analysing exploration and deployment alternatives that can be fruitful for the advent of digital terrestrial TV (DTT) in Brazil. The government decided that the evolution of analogue television into the digital system should be developed by aiming at real benefits for the society. Among these benefits, it is possible to highlight the promotion of social inclusion, the creation of a widespread distance teaching network, and a gradual transition, compatible with users' purchasing power. Following that, it was established a formal structure of decision and execution concerning the necessary actions for obtaining the reference model of the DTT system.

The first phase in the deployment of the DTT system in Brazil was accomplished in the first half of the year 2005¹¹, reaching the following objectives:

- define a reference model;
- propose the digital television standard to be adopted;
- propose the digital television service development model;

¹¹ Decree n° 4901, of November 2003: <http://www.planalto.gov.br/ccivil/decreto/2003/D4901compilado.htm>

- propose timeframe and model for the transition from analogue to digital system.

The second phase continued the development of technologies and services considered significant to be selected within the reference model. It depended mostly on the definitions in the standard and on the business model chosen in the first phase. In this phase, among other initiatives, the regulation framework will have to be adapted.

Finally, the third phase encompassed the deployment of technologies and services developed. Brazilian Government has promoted the adoption of a DTT system that respects the social particularities and conditions, providing the opportunity to develop regional solutions, which are mostly suitable, overcoming the urgency of the decision.

After thorough testing and careful studies, the Brazilian Government adopted on June 2006¹² the ISDB-T standard for digital television, incorporating technological innovations that are deemed relevant by the Brazilian Government and whose technical specifications should facilitate the following:

- high-definition digital transmission (HDTV) and standard-definition digital transmission (SDTV);
- simultaneous digital transmission for fixed, mobile, and portable reception;
- interactivity.

2.2 Spectrum usage

The radio spectrum is an important and highly valuable resource that must be adequately managed to meet the established policies. To achieve this objective, regarding the TV broadcasting service, the National Telecommunication Agency (Agência Nacional de Telecomunicações – ANATEL) started drawing up a channel assignment plan in Brazil before the adoption of the digital standard, to guarantee simultaneous compliance with the technical requirements of the three digital television systems that were under analysis. This work took into consideration the following premises:

- the digital television channels would use the bands of VHF-H (7 to 13) and, preferably, the UHF band (14 to 59), keeping the service area equivalent to that of the current analogue service;
- during the analogue to digital transition phase, the programming of the stations shall be transmitted simultaneously by the analogue and digital channels. After that phase, analogue transmissions would be interrupted remaining only digital transmissions. The analogue switch off is programmed to take place in June 2016, as illustrated in Fig. 35;
- for each analogue channel considered, a digital channel shall be assigned during the analogue-to-digital transition period, set for 10 years, observing the current coverage of the analogue signal;
- for the adequate delivery of digital television service in Brazil without the interruption of analogue signal transmission, in order to facilitate the transition to digital technology, a 6 MHz channel shall be allocated;
- the technical criteria adopted must meet the protection and interference requirements of the three digital television systems, always bearing in mind the worst case, regarding this aspect.

¹² Decree n° 5820, of June 2006: http://www.planalto.gov.br/ccivil_03/_Ato2004-2006/2006/Decreto/D5820.htm

FIGURE 35

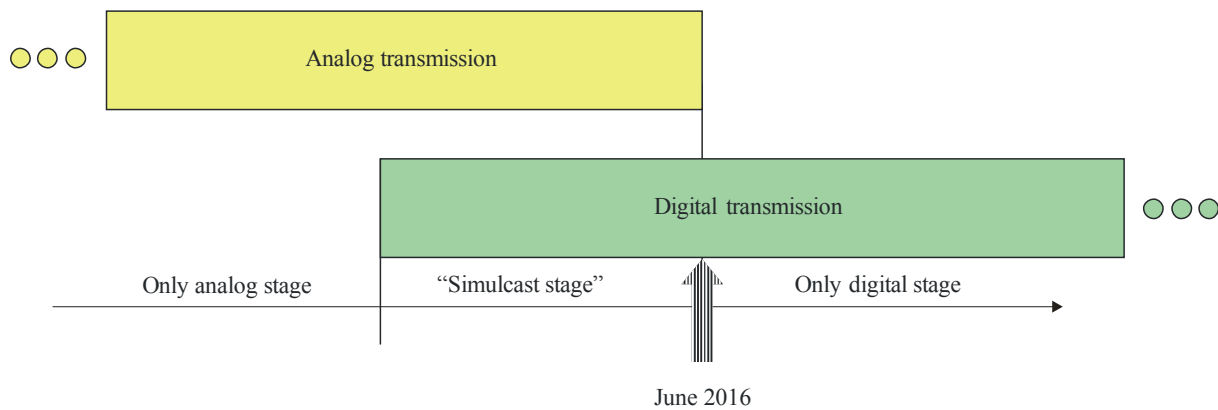
Digital switchover in Brazil

Report BT.2140-35

Guided by these principles, ANATEL, which is responsible for drawing up and maintaining the Basic Channel Assignment Plans, published the Basic Digital Television Channel Assignment Plan (Plano Básico de Distribuição de Canais de Televisão Digital – PBTVD). With 1 893 channels included, the above-mentioned Basic Plan was comprised of a universe of 296 Brazilian localities, including those which at that time had at least one operating broadcasting television generator station and, in addition, those which, although having only television translator stations, had a population of over 100 000 inhabitants.

Furthermore, to meet the expected demand for digital TV channel assignment, mainly in the regions with high occupancy of radiofrequency spectrum, ANATEL has been making efforts to change the assignment of channels 60 to 69, currently used by the television signal relay service, for their use, primarily, by TV broadcasting and translator stations. The television signal relay stations operating on these channels shall be motivated to change to other frequency bands.

The adoption of the ISDB-T standard made possible to adjust the PBTVD to the modulation characteristics inherent to the system. In 2006, ANATEL started up this adjustment to that new reality basically excluding the 91 channels envisaged for a possible choice of a system that would not permit the use of single frequency network (SFN), and adjusting the power of the digital channels to match the coverage area of analogue channels, once the drafting of the PBTVD had considered the worst protection and interference case, which led to higher power levels than needed and the alteration of the related installation points to meet co-location requirements.

This task is being carried out by region, starting with the regions in Brazil that account for the highest economic output and occupy most of the radioelectric spectrum, without neglecting however the regions of higher demographic density, which shall facilitate the implementation of digital television in Brazil.

In late 2009, the PBTVD already covered all the states in Brazil, totalizing 472 municipalities and 2 688 channels, including all 27 state capitals, and all locations of Parana and Sao Paulo states. Since then, studies were undertaken to include digital channels in the South, Southeast and Midwest regions, whose related changes should be implemented on the PBTVD until early 2011. The North and Northeast regions will be studied in the first half of 2011.

2.3 Current situation on DTT implementation

On December 2nd, 2007, the first official implementations of the Brazilian DTT system began commercial operations in the city of São Paulo and, by mid-2008, there were already 10 commercial broadcasters operating in this city. Although tests were already being conducted since May 2007, the government chose the December date as the official date of the system launch.

The actual deployment of DTT transmissions in Brazil was moving ahead of the schedule. Stimulated by the increasing interest in the new technology, many broadcasters have been investing earlier than required by law and have been starting digital transmissions sooner than expected. The accelerated implementation was also due to the tax-reduction incentives offered by the government, and to the new applications made possible by the DTT system, such as portable reception.

In the first three years of the official commercial launch, DTT transmissions in Brazil are a reality in over 39 metropolitan areas. By the third quarter of this year, DTT signals already covered over 72 million people. The robustness of DTT signals, as well as the superior video and audio quality provided by the technology, represents a big step forward in the technical quality on content access of lower income population.

In the third quarter of 2010, there were already over 50 different DTT receivers available in the market, with functionalities and designs aimed to different economic segments and user preferences, and which since mid-2010 also includes interactivity. Among those models, there could be found portable reception devices (1-Seg), including portable TVs, computer USB tuners and cell phones. For fixed reception, consumers could choose between standard definition and high definition devices, although all broadcasters have been transmitting in high definition (1080i). All interactivity products are branded with the DTVi logo.

Since the beginning of transmissions, market prices for DTT receivers have been falling gradually, as the market moves from the early adopters to the ordinary consumers. That expected movement has been regarded by broadcasters and industry as proof of the successful introduction of DTT. This trend has intensified on the first semester of 2010 due to the proximity of the soccer World Cup.

The receiver industry had already provided many solutions for the high-end DTT market, such as full-HD displays with integrated digital tuners. Brazilian Government provides tax incentives for the production of television set only if LCDs and Plasma with display sizes for at least 42 inches have built in receivers. This exemption will be extended to all display sizes by January 2011.

Not only the availability of products contributed to the system successful deployment but also the existence of the Forum of Brazil's terrestrial digital TV broadcasting system, formally instated in December 2006. The Forum is a non-profit entity, whose main objectives are to support and foster the development and implementation of the best practices for the success of digital television broadcasting in Brazil. Its membership is composed mainly of participants from the broadcasting, reception-and-transmission-equipment-manufacturing, and software industries.

The Forum's mission is to help and encourage the installation or improvement of the digital sound and image transmission and receiving system in Brazil, promoting standards and quality that meet the demands of the users.

The purpose of this Forum is to propose voluntary or mandatory technical norms, standards, and regulations for Brazil's terrestrial digital television broadcasting system, and, in addition, to foster and promote representation, relations, and integration with other national and international institutions.

2.4 New services offered by DTT

The Brazilian digital transmission system will provide new capabilities to serve viewers, such as high definition and standard resolution pictures, data delivery, interactive communication, portable and mobile services, with the required technical flexibility to better serve the viewers.

The possibility of signal transmission through a single channel for fixed (HDTV), mobile (SDTV) and portable reception (1-Seg), only possible on the ISDB-T system, encourages the relationship between viewers and the content provided. Furthermore, the system enables to increase the signal penetration to meet the needs of a dynamic population, maintaining the broadcasting service features of providing information, education and entertainment, which distinguishes it from others services.

Brazilian DTV broadcasting system enables a limitless variety of new information services, including interactive services. A great deal of interactivity in such applications can be provided simply by downloading substantial information from which viewers can choose. Interactivity can be increased further through the use of a return channel through which viewers can request specific content from the broadcaster. Brazilian system comprises multiple technologies to implement the return channel, including, but not limited to, fixed and mobile networks, broadband connections or even a terrestrial return channel if additional spectrum is available.

New services under deployment in the Brazilian market, including interactive services, represents an important opportunity to promote social inclusion, i.e. to provide education, health care, and other important social services to viewers of all socio-economic segments, including citizens who may never own a personal computer.

There are still lots of opportunities of the digital transition and digital system to be further explored:

- Signal coverage in all terrain types: provision of better services in their coverage areas, improving the quality of their service to the local population.
- Signal robustness and performance: signal robustness lowers acquisition and operation costs for all broadcasters, allowing resources to be allocated to content production and providing.
- Resistance to signal interference: ISDB-T offers time interleaving techniques, which provide powerful channel coding for mobile reception in which variations in field are inevitable.
- Audio and video quality in HDTV services: use of MPEG-4 audio and video coding for better quality. Viewers may benefit from enhanced image, sharper sound and exciting new applications.
- Balance between costs and technical performance: MPEG-4, which is optional in the system, is currently the most powerful and state-of-the-art audio and video coding standard. Its design provides valuable future proof balance between coding efficiency, implementation complexity and cost, based on the current state of VLSI design technology.
- Deliver of programs and applications to portable devices: Direct service from broadcasters to portable and hand-held devices of audio, video and applications will create new business models and increase audiences, reaching viewers on the move everywhere.
- One channel for all services: All types of services, either HDTV, SDTV or to portable devices (1-Seg) are transmitted using only one channel, rendering a better and more efficient use of the spectrum.
- Flexibility between signal coverage and bandwidth: The system is configurable in such a way that broadcasters may trade bit rate capacity against signal coverage to all services individually, either for stationary, mobile or portable reception.

- Signal coverage and quality of service (QoS): The system ensures a more efficient and cost-effective use of the spectrum when compared to analogue transmissions. All versions of the specification guarantee the use of advances such as SFN (single frequency network), on-channel repeaters and several other techniques for optimizing coverage and filling shadow areas.
- Flexible business models: Flexibility needed to offer the adequate blend of content that is most appealing to local audiences. HDTV, multiple SDTV services, mobile and portable services, plus a limitless variety of data services can be all harmonized under the same technical and regulatory umbrella.
- Mobile and portable services: The digital television system platform was developed to maximize its unique capacity for offering mobile and portable services, which has been actively developed for portable and mobile applications.
- New services: It renders an alternative to in-house wireless solutions as a means of overcoming the problem of second and third television sets in the home and providing new broadcast entertainment and information services to people on the move.
- Social inclusion and new audiences: ISDB-T is capable of providing increased access to information services to viewers of all socio-economic segments at once. Reaching the poorer segments of society is particularly relevant since in many countries a vast majority of the population relies on free-to-air television as the only means of access to information and entertainment.

The digital television implementation is no longer a technical challenge in Brazil but rather an opportunity to provide access to digital technology to all socio-economic segments of society. Flexible business models, mobile and portable reception and attractive applications to viewers are key to any digital television platform future viability.

(Detailed technical information can be found at <http://www.forumsbtvd.org.br/>)

2.5 Brazilian digital terrestrial television standards

Subject	ABNT NBR ¹³	Parts	Portuguese	English	Spanish
Transmission	15601	Part 1	Download Updated on 07/04/2008	Download Updated on 01/12/2007	Download Updated on 01/12/2007
Coding	15602	Part 1	Download Updated on 07/04/2008	Download Updated on 01/12/2007	Download Updated on 01/12/2007
		Part 2	Download Updated on 07/04/2008	Download Updated on 01/12/2007	Download Updated on 08/01/2010
		Part 3	Download Updated on 07/04/2008	Download Updated on 01/12/2007	Download Updated on 01/12/2007
Multiplexing	15603	Part 1	Download Updated on 22/08/2008	Download Updated on 22/08/2008	Download Updated on 01/12/2007
		Part 2	Download Updated on 21/09/2009	Download Updated on 21/09/2009	Download Updated on 21/09/2009
		Part 3	Download Updated on 02/09/2009	Download Updated on 02/09/2009	Download Updated on 02/09/2009
Receivers	15604	Part 1	Download Updated on 07/04/2008	Download Updated on 01/12/2007	Download Updated on 01/12/2007

¹³ Associação Brasileira de Normas Técnicas (ABNT) is the Brazilian Standardization Forum.

Subject	ABNT NBR ¹³	Parts	Portuguese	English	Spanish
Security	15605	Part 1	Download Updated on 16/07/2009	Download Updated on 16/07/2009	Download Updated on 16/07/2009
Middleware	15606	Part 1	Download Updated on 14/07/2010	Download Updated on 14/07/2010	Download Updated on 14/07/2010
		Part 2	Download Updated on 17/04/2009	Download Updated on 17/04/2009	Download Updated on 19/11/2009
		Part 3	Download Updated on 22/08/2008	Download Updated on 22/08/2008	Download Updated on 01/12/2007
		Part 4	Download Updated on 13/04/2010	Download Updated on 16/06/2010	Download Updated on 25/06/2010
		Part 5	Download Updated on 19/04/2011	Download Updated on 14/04/2009	Download Updated on 18/06/2009
		Part 6	Download Updated on 19/07/2010	Soon	Soon
		Part 7	Download Updated on 21/03/2011	Soon	Soon
Interactivity Channel	15607	Part 1	Download Updated on 05/04/2008	Download Updated on 05/04/2008	Download Updated on 05/04/2008
Operation Guide	15608	Part 1	Download Updated on 22/08/2008	Download Updated on 22/08/2008	Download Updated on 22/09/2008
		Part 2	Download Updated on 02/06/2010	Download Updated on 21/06/2010	Download Updated on 21/06/2010
		Part 3	Download Updated on 28/01/2011	Download Updated on 28/01/2011	Download Updated on 28/01/2011

3 Bulgaria

With due consideration of the complexity and far reaching consequences of the transition from analogue to digital, relevant Strategic Plan for Introduction of Terrestrial TV Broadcasting (DVB-T) in the Republic of Bulgaria has been elaborated and approved at session of the Council of Ministers of 31 January 2008 (Reference: Protocol No 5 by decision on Agenda item 24). Its main considerations and key aspects are provided herewith.

3.1 Background of country TV broadcasting market

3.1.1 TV Programme licences

As of January 2008, a total of 203 TV programmes have been licensed for delivery to the population of this country by cable television, terrestrial broadcasting and via satellite.

3.1.1.1 The terrestrial broadcasting component ensures analogue delivery of the total of seven TV programmes as follows

- a) Three nation-wide TV programmes, namely:
- “**Channel 1**” of the Bulgarian National Television (BNT) with population coverage of 98,3% achieved by 677 high power main transmitters, relay transmitters and low power fill-in transmitting stations in Frequency Bands II, III, IV and V;
 - “**bTV**” with population coverage of 97% achieved by 676 high power main transmitters, relay transmitters and low power fill-in stations in Frequency Bands III, IV and V; and

- “Nova” exceeding 70% population coverage achieved by total of 143 transmitters, with comparatively lesser number of high power main transmitters and with a growing network of relay transmitters and low power fill-in transmitting stations, all operating in Frequency Bands IV and V.
- b) In addition there are four regional TV programmes licensed to be on air in the towns of Blagoevgrad, Plovdiv, Ruse and Varna.

3.1.1.2 Remaining 196 licenses are issued for TV programme delivery via cable or satellite

3.1.2 Public/Commercial/Temporary licensed operators

Seventeen licenses are issued to public broadcasting operators and 169 licenses to commercial broadcasting operators totaling 186 regular licenses. Furthermore, the said regular licenses are supplemented by additional 42 specific licenses (temporary in nature but still in force) for terrestrial analogue broadcasting.

3.1.3 Cable/Satellite/Terrestrial delivery

It is estimated that predominantly around 63% of the country population is served by cable network delivery, 7% of the population by satellite and about 30% of the population receives TV programming via terrestrial broadcasting channels. While every country town is served via cable TV network delivery only about 28% of the villages of this country are served by cable TV. It is expected that cable TV network delivery would reach its saturation limit at 75% of the population coverage.

The country population having access to terrestrial TV broadcasting only is estimated to be within 10 to 11% range.

3.1.4 Digital terrestrial TV broadcasting

Only one digital terrestrial TV broadcasting operator has been licensed to serve the area of Sofia City since 2004.

3.2 Purpose and mission of the analogue to digital terrestrial TV transition

The said Plan for introduction of digital terrestrial broadcasting aims not only at retaining the number of users who, in spite of having access to cable, terrestrial and satellite delivery, have already chosen to use analogue terrestrial delivery, but also has set the target of increasing the number of digital terrestrial delivery users in nearest future. Indeed the Plan has the objective of creating an enabling competitive environment thus effectively preventing the monopolistic cable and satellite delivery operator's grasp at the market.

Towards this end, the digital terrestrial broadcasting shall be deployed under certain conditions as follows:

- free of charge delivery to users (not more than one encrypted programme per multiplex be permitted);
- initial number of programmes delivered shall be not less than 15;
- programmes delivered be composed of an attractive-to-viewers blend of national, regional and local origin;
- HDTV programme delivery license applications be allowed by 2011;
- better quality and offer of additional/interactive e-services and applications, in consistency with Directives 2002/21/EC (Framework Directive) and 2002/19/EC (Access Directive) of the European Parliament and the Council of 7 March 2002; and

- mobile outdoor reception predominantly for cars and portable reception inside of buildings expected to be used for the purpose of second and third household receivers.

The said Transition Plan has defined the strategic aspects of:

- population coverage objectives and criteria;
- Multiple Frequency Network (MFN) approach dedicated only to nation-wide coverage, while Single Frequency Network (SFN) approach will be applied explicitly to allotment zones;
- initial build-up of SFN network broadcast coverage of densely populated towns and areas (Island Coverage) within any allotment zone followed by further gradual network extension until the entire allotment zone coverage has been achieved;
- optimization of number of multiplexes within allotment zones;
- granting license or temporary permission to any new analogue terrestrial broadcasting operator applicant will be severely restricted;
- parallel broadcasting of both the analogue and the digital (simulcast) being limited to one year duration upon the expiry of which the concerned analogue broadcasting license/s will be terminated. Thus the reuse of liberated spectrum of analogue broadcasting is provided for further build-up of digital terrestrial TV broadcasting networks as per the Plan;
- establishing criteria for switch-off of analogue TV broadcasting, but not later than end 2012;
- nation-wide coverage by digital terrestrial broadcasting to be completed in all zones by end 2015;
- factual digital dividend definition; and
- timely supply of Set-Top Boxes (STB) to the population at affordable prices and risks involved.

3.3 Impact of the digital terrestrial broadcasting Plan of RRC-06 and GE-06 Agreement

RRC-06 and GE 06 Agreement guarantee to the Bulgarian Administration to have at its disposal and use at its discretion 10 nation-wide networks for terrestrial digital TV broadcasting, supplemented by 34 regional networks and by 23 networks dedicated to the regions of Sofia and Varna.

3.4 Transition to digital terrestrial TV broadcasting

The said transition will be executed into two phases as follows:

3.4.1 First phase-start of the transition

3.4.1.1 Three nation-wide digital terrestrial TV networks

Three nationwide MFN/SFN networks, all DVB-T, will be licensed to operators for deployment in allotment zones of Burgas, Plovdiv, Ruse, Sofia, Stara Zagora, Varna and Vidin by June 2008.

Licensed operators shall start “Island Coverage” broadcast within said allotment zones as from January 2009 and they must achieve at least 75% population coverage within said allotment zones by December 2012.

Exactly one year later, after the simulcast expiry, new licenses will be granted to operators with obligation to start “Island Coverage” broadcast within allotment zones of Blagoevgrad, Kurdzhali, Pleven, Smolyan and Shumen and they must achieve at least 75% population coverage by December 2011.

Furthermore, relevant licensees must ensure full population coverage inclusively for the above-mentioned twelve allotment zones by December 2012.

3.4.1.2 Twelve regional digital terrestrial TV networks

Twelve regional SFN networks will be licensed to operators within allotment zones of Burgas, Plovdiv, Sofia and Varna (three SFN networks each) by June 2008. Licensees shall start “Island Coverage” broadcast within said allotment zones by January 2009 followed by ensuring of full population coverage for the said four allotment zones by January 2010.

3.4.2 Second phase of the transition

3.4.2.1 Additional three nation-wide digital terrestrial TV networks

Furthermore, three nation-wide MFN/SFN networks, two of them DVB-T plus one DVB-H, will be licensed to operators for deployment in the allotment zones of Burgas, Plovdiv, Ruse, Sofia, Stara Zagora, Varna and Vidin by July 2010.

Licensed operators shall start “Island Coverage” broadcast within said allotment zones as from January 2011 and they must ensure at least 75% population coverage of said allotment zones by December 2013.

Exactly one year later, after the simulcast expiry, new licenses will be granted to operators by July 2011 with obligations to start “Island Coverage” broadcast within the allotment zones of Blagoevgrad, Kurdzhali, Pleven, Smolyan by January 2012, being followed by obligations to ensure at least 75% population coverage by July 2014.

Furthermore, relevant licensees must ensure full population coverage inclusively for the above-mentioned twelve allotment zones by July 2015.

3.4.2.2 Additional fifteen regional digital terrestrial TV networks

Fifteen regional SFN networks will be licensed to operators for deployment in the allotment zones of Blagoevgrad, Burgas, Kardzhali, Pleven, Plovdiv, Ruse, Smolyan, Sofia, Sofia-City, Stara Zagora, Strandzha, Shumen, Varna, Varna-City and Vidin by July 2010.

These licensees will be obliged to start “Island Coverage” broadcast within said allotment zones as from January 2011 and they will be required to ensure 90-95% of population coverage in the above-mentioned allotment areas by December 2012.

3.4.3 Allotment zones

Figure 36 defines the distribution of allotment zones on the map of Bulgaria as per RRC-06.

FIGURE 36
Allotment zones for the Republic of Bulgaria defined by RRC-06



Report BT.2140-36

3.4.4 HDTV

Subject to license application(s) for digital terrestrial HDTV broadcasting network/s being submitted latest by December 2011 to competent regulatory authorities, or upon initiative of competent regulatory authority, license/s may be granted to relevant operator/s for deployment and operation of digital High Definition TV terrestrial broadcasting network/s.

3.4.5 One Year Simulcast Limitation

The period of parallel broadcasting of both analogue and digital terrestrial TV broadcasting (simulcast) is limited to one year after the startup of digital terrestrial broadcasting within relevant “Island”. Upon expiry of this one-year period all analogue terrestrial TV broadcasting transmitters within the “Island” territory coverage will be switched-off as a principle, however exceptions may be granted spectrum permitting, in particular for remote rural areas.

Appropriate measures will be taken to ensure adequate spectrum allocation/s in order to guarantee the practical implementation of this key requirement.

3.4.6 “Must carry” obligation

The Electronic Communications Law, May 2007, Article 47(2).1 stipulates that any digital terrestrial broadcasting network, be it radio or television, must carry two Bulgarian programmes. It is within the purview of the Electronic Media Council (EMC), empowered by this Law, to decide on the programme allocation within any network. Furthermore, it is the EMC who decides on the network to broadcast the programme/s of Bulgarian National Television, but within the said limitation of two Bulgarian programmes per network.

Taking into account the existing spectrum constraints, the Second Phase of the Transition Plan (see § 2.4.2) may be implemented only on condition that relevant spectrum indeed be liberated by the already licensed operators for analogue terrestrial digital TV broadcasting with nation-wide

coverage networks. In this regard and in order to ensure that the above-mentioned requirement of the Electronic Communications Law will be met, either the said licensed operators must have new licenses granted for nation-wide network coverage of digital terrestrial TV broadcasting during the First Phase of Transition (see § 4.1), or alternatively, in consistency with the decision of the EMC on the network assigned to carry the programme/s of Bulgarian National Television (BNT) a “must carry” obligation be imposed on relevant operator/s, being licensed as First Three Nation-wide digital terrestrial TV Broadcaster during the First Phase of Transition to carry obligatorily the programme/s of Bulgarian National Television.

3.4.7 Analogue switch-off

Switch-off of any analogue TV terrestrial broadcasting transmission in the country will be imposed by December 2012 at the latest.

3.4.8 Digital dividend

The switchover from analogue to digital broadcasting will create new distribution networks and expand the potential for wireless innovation and services. The digital dividend accruing from efficiencies in spectrum usage will allow more channels to be carried with variety of fast data transmission rates and lead to greater convergence of services.

The inherent consistency of data flows over long distances and flexibility offered by digital terrestrial broadcasting will support mobile reception of video, internet and multimedia data, making applications, services and information accessible and usable anywhere and at any time. Along with the introduction of innovations such as Handheld TV Broadcast (DVB-H) and High-Definition Television (HDTV), it will provide greater bandwidth which, in full consistency with “European Parliament resolution Towards an European policy on the radio spectrum” {2006/2212(INI)}, could increase the widespread availability of affordable mobile/wireless broadband, including in rural areas.

Services ancillary to broadcasting (wireless microphones, talk back links), planned on a national basis, could also be extended.

Because of the complex and interleaving reasons, associated inter alia with the said purpose and mission of the introduction of digital TV terrestrial broadcasting in this country, it will be very difficult in the mid-term future to quantify the spectrum which will be available for use of services other than broadcasting. Therefore it is foreseen that the factual quantitative balance of the spectrum liberated will be done not earlier than the complete analogue switch-off at the end of 2012 and not later than end 2015, in full conformity with the decisions taken at the WRC-07.

4 Canada

4.1 National planning strategies and policy considerations

4.1.1 Introduction

For almost 25 years Canada has carried-out, research, demonstrations, put in place a Task Force, Working Groups, Industry Associations, Regulatory initiatives with minimal government involvement and with a policy firmly based on the market place for the transition to digital terrestrial television. Although the core of all of this work has focused on terrestrial television transition, there have been some notable diversions along the way including the Advanced Broadcasting Systems of Canada (ABSOC), which dealt with video compression issues for standard digital terrestrial television, cable and satellite.

ABSOC recommended that a digital Task Force look at all the issues surrounding the implementation of Digital Television (DTV) in Canada and the Government set one up in late 1995. It included all industry segments and completed its work in late 1997 with a report presented to the Ministers of Canadian Heritage and Industry Canada.

Following the Task Force report Industry Canada responded by accepting the recommendation to adopt the American Television Systems Committee (ATSC) transmission standard for terrestrial DTV services and made spectrum available to all licensed terrestrial television broadcasters for digital services. The broadcasters, distributors and manufacturers set up an industry association to manage and facilitate the transition realizing another recommendation, Canadian Digital Television (CDTV).

Over the next eight years CDTV working with the industry and the relevant interest groups and government departments, provided a platform for testing the technology, educating both the industry and the consumer, demonstrating HDTV services, and encouraging the production and distribution of HDTV programs and services. Over this period, the Canadian Radio-television and Telecommunications Commission (CRTC) also provided a regulatory framework for terrestrial television broadcasters and pay and specialty services to make the transition to digital High Definition service. The important point to note is that the emphasis of all of these initiatives was not just the introduction of DTV service but that service providing HDTV programs. The benefit for the citizen/consumer was defined both informally and formally as improved video and audio as characterized by HDTV.

In 1999, the industry defined Canada's DTV transition strategy as a fast follow by two years of the US roll out of DTV services. This strategy was consistent with the market place approach and ensured that the high-end costs associated with early adoption of new technology were avoided for both broadcasters and consumers.

A lot has changed in the broadcast environment since the beginnings of HDTV in the eighties. Broadcasters have lost market share to viewing in both in real terms to pay and specialty services as well as viewers receiving their service directly from the transmitter in favour of distributed cable and satellite. More than 30% of all viewing was from terrestrial transmitters in the eighties where today that figure hovers around 10% or even lower in some markets. Consequently, broadcasters have been reluctant to build digital transmission infrastructure noting that there simply is not a business case to do so. There are currently 12 DTV transmitters on the air concentrated in Toronto, Vancouver and Montreal, even though more than 40 temporary licenses have been granted.

Over this time, progress was made in creating digital HD infrastructure in network operations of the major networks and the production community is just now beginning to embrace HD production. However, for the most part the Canadian terrestrial television broadcast system remains a standard definition one (as do the pay and specialty services) and in many regional centres an analogue throwback.

It is against this background that the CRTC is conducting a television policy review and the Minister of Heritage requested an examination of the impact of new technology on the Canadian Broadcasting System. A lot has changed since the Task Force reported 9 years ago. Internet delivery, Video on Demand, mobile television and consumer empowering personal video recorders and devices have and will have an increasing impact on the traditional broadcast model and in fact on the fundamentals of the Canadian Broadcasting system as Canadians have historically understood it. Decisions made by the CTRC, Government and the interests of the Broadcasting system over the coming 12 months will have a profound impact on the future of broadcasting generally and the roll out of conventional terrestrial broadcast services in particular.

The remainder of the paper will look more closely at the history, present circumstances and future options.

4.2 DTV/HDTV history

4.2.1 The early years

Canadian engagement with digital television is rooted in the industry's early interest in High Definition Television (HDTV) as far back as 1982. In that year, the Canadian Broadcasting Corporation (CBC) and the Department of Communications and its research centre organized a Colloquium in Ottawa that drew delegates from all over the world to discuss HDTV and how to develop it as a future service. For almost a decade, there were follow up conferences, demonstrations and debate.

It is probably fair to say that the Department of Communications led a lot of Canada's participation through the eighties and into the nineties. In 1987, a major public demonstration of the Japanese MUSE system of HDTV was done with the cooperation of government, a number of Canadian industry players and the Japanese. It was successful but not practical for terrestrial display in North America because of the amount of bandwidth needed for broadcast, although the Japanese used the MUSE technology from the late eighties through to today via Satellite DTH. At the same time, the CBC produced the first North American High Definition program series, Chasing Rainbows.

As the eighties drew to a close the Canadian Government was involved in that process testing proponents of five different systems in 1991/92 and then the eventual successful effort in the mid-nineties. Canada worked closely with US industry and agencies in this process. At the same time Canadian industry recognized the need to become involved in the digital initiatives became apparent and in 1990 ABSOC was set up to perform that role.

From 1990 through to 1997 ABSOC played an important role of both informing the industry on digital developments and recommending standards and practices for MPEG-2 compression technologies as it effected production and distribution of standard digital television. Representing a cross section of the broadcast and distribution community with government liaison and support ABSOC brought a practicality and application to the new digital technologies as they developed.

As the initiative matured and accepted a new digital transmission technology capable of delivering High Definition signals within MHz of spectrum or multicast digital delivery of standard television, ABSOC came to realize that Canada needed to focus on what this new technology meant for Canadian viewers and the broadcast industry. They recommended a Task Force to examine the elements required to implement digital television in Canada and the government responded by naming a Task Force in November of 1995.

It is important to understand the environment that Canadian broadcasters enjoyed in the mid-nineties. Although conventional broadcasters faced increasing market fragmentation, they still enjoyed a transmitted market share of their viewers of over 20%. Although pay and specialty services were growing, they had not fragmented the audience share to the degree that would develop and is seen today. The internet as a delivery mechanism, video on demand and other platforms that define today's multi-platform broadcast world were barely a dream very much on the horizon but in a business sense not a huge blip on anyone's radar screen. By the end of the nineties, the view of the broadcast world was rapidly disintegrating. What was real was MPEG-2 compression, which made possible digital standard television satellite and cable delivery. Providing for more pay and specialty services with cheaper delivery to Broadcasting Distribution Undertaking (BDU) head ends and production facilities, and the prospect of better quality pictures and sound with HD services very far down the road.

For the newly announced Digital Task Force these problems were all in the future and it focused on its mandate to recommend the best way to implement digital television for Canada.

Digital Television Task Force

The Task Force was truly representative of all industry interests plus the production and consumer manufacturer's community. Over ninety people were on the Task Force or committees and many more were consulted throughout the Task Force's work. It has been noted that Canada does Royal Commissions and Task Forces very well, as they are often vehicles for inaction. However, they also do some remarkable work from time to time and by the time the Task Force reported in late 1997 an industry had been somewhat educated, consulted and had arrived at a consensus; albeit kicking, screaming and probably thinking that many of its recommendations were so far down the road that there was nothing really to worry about.

The seventeen recommendations were rooted in the work of four committees who recommended the substance to the Task Force members. The committees included; technology, production, policy and regulation, and economics, consumer services and products. It is interesting to note as Canada moved to an implementation stage those areas of work continue to provide guidance and direction. While it is not useful to review the entire Task Force report and recommendations, it is useful to recognize that much was achieved and many recommendations were acted on:

The ATSC transmission standard, A53, was adopted by Canada and a subsequent allotment plan was adopted providing digital spectrum for all licensed analogue conventional broadcasters. Broadcasters were to make the transition to digital transmission while retaining their analogue spectrum for simulcast until the transition was complete. This was important since it provided a secure business basis for broadcasters to begin the transition.

Many of the policy and regulatory recommendations have found their way into CRTC licensing and carriage frameworks. Again, this was to provide stability during the transition for the industry business models, as they were understood at the time.

A period was suggested for the digital transition with an end date that would be a year to 18 months behind the US. While not acted upon in Canada, virtually every other country in the world has either a notional or a firm target date for analogue shutdown. The Canadian transition has lacked clarity and definition in the absence of such an initiative.

Initiatives concerning the production community for training and HDTV content were never acted upon and regrettably this industry sector has lagged behind many in the global community and Canada has a lack of HD production.

The recommendation to set up an industry organization to help manage, facilitate and advise government on the transition was put into place and will be discussed later in this paper.

Some recommendations like that calling for a universal box which would work for terrestrial television and distributed BDU services were not realized and probably too idealistic.

One recommendation calling for universally available terrestrial services is worth noting:

Recommendation Fourteen

Basic terrestrial broadcast television services that are freely and universally available are central to achieving the objectives of the Canadian broadcasting system. This must continue in future digital terrestrial distribution packages.

Freely available broadcast television services are the foundation of the Canadian broadcasting system. This universality of access must be preserved in the emerging digital system.

This was fundamental to the system in 1997 but in today's environment terrestrial broadcasters are not committed to this principle given the change in how viewers receive their television services. In fact, the costs associated with this recommendation and the lack of any kind of business case will characterize the discussions of future policy hearings. This issue has also characterized the industry reluctance to move ahead with the digital transition in a timely way.

In looking back, the Task Force got many things right as evidenced by the overwhelming number of recommendations implemented. It set the agenda for the transition for terrestrial services and coincidentally the pay and specialty services. However, it did not anticipate the rapid change in the broadcast environment; its multi-platform distribution opportunities and the availability of the devices, which would empower consumers with both choice and schedule. Combined with a market place approach these factors inhibited a timely transition to digital High definition services.

Implementation 1998 to 2006

Following the Task Force report the broadcasting and distribution industry, along with manufacturers and producers came together to create CDTV, as recommended by the Task Force. In September of 1998 the organization was formally created as a not profit association, with by-laws, a Board of Directors based on industry sectors and a work plan. Relevant Government Departments and the CRTC were welcome to participate and contribute to committee work and observe in Board meetings.

The Board created Working Groups in the technology, policy and regulation, economics and marketing, communication and education and production. This was not very different from the original Task Force committees. These working groups were a part of the association to a greater or lesser extent through the life of the association responding to the approved work plans from the Board and the changing environment

The work of the association was totally funded by the industry with both direct and indirect funding. Industry Canada provided funds to test the frequency allotments at the CDTV test transmitter in Ottawa in 1998/99.

For eight years, CDTV represented the industry in helping manage and facilitate the transition. The early years focused on testing, education, and understanding the standards. As time passed demonstrations, seminars, policy, regulation and business models dominated the agenda. Over the last few years CDTV focused on operational implementation, the creation of HDTV programming, consumer education and awareness, and the impact of new technology including; improved compression technology, IPTV and mobile service. Throughout its mandate, CDTV participated with ATSC committees and on the Board, bringing back to the Canadian broadcasters and relevant government departments and agencies changes and improvements to the ATSC family of digital standards and Canadian input to those discussions.

An industry association that tries for consensus on issues, or at the very least an overwhelming majority is not the easiest of vehicles to manage in an environment of competing interests and agendas. The consensus and goodwill, which characterized the Task Force was not always seen as CDTV grappled with some of the business and regulatory issues where the interests of the principals were seen to be on the line. Yet for all of that the achievements were many over the life of the association and in fact defined the steps of the transition to digital terrestrial television to date.

Test transmitters were set up and operated in Ottawa, Toronto and Montreal. These gave the broadcasters and distribution communities the opportunity to work with the new digital transmission standard, understand its properties, coverage areas and delivery to BDU head ends.

The transmitters were used to test the frequency allotments (funding from Industry Canada), coverage reach, receiver strength and signal strength. This work became increasingly important, as improvements were made to off air receiver reception.

Canada was also called upon by consumer electronics manufacturers and the ATSC to test improvements and additions to the ATSC family of transmission standards.

Demonstrations for both the public and the industry of HDTV programming and delivery on the Canadian broadcasting system.

Seminars and workshops were held to explain to and educate the industry on the full range of the issues surrounding the production and distribution of digital High Definition programs.

A great deal of time and effort was spent on attempting to develop business models that digital terrestrial television in terms of program and non-program related data and multichannel delivery. It was hoped that these models could lead to additional resources to help fund the transition. While the process certainly educated the industry there was not a consensus on the right model or an agreement between the conventional broadcasters and the distributors over revenue sharing of distributed terrestrial data and services.

Costs for the transition were also carefully calculated and included transmission, master controls, editing and production all in high definition. Suggestions for upgrading as equipment became obsolete were made available so that the capital costs of conversion would not be an overnight hit and distort budgets. Again, the identification and process were helpful but no overall industry plan was adopted.

Very early in the transition the Board of Directors of CDTV created the policy of a two-year lag behind the US in Canada's transition to digital television. This built on a recommendation in the Task Force report that suggested a year to 18 months. Given the Government's view that Canada's transition to digital high definition broadcasting should be driven by the market this two-year lag policy was sensible and virtually adopted by all parties. It was successful in saving the industry and consumers a great deal of the costs associated with the early adoption of new technology.

Education and consumer awareness was a major focus of the transition work. This work involved not only the broadcast and distribution industry but the consumer electronics manufacturers and the retail sector as well. Several editions of pamphlets aimed first at the retailers and then directly at the consumers were prepared and delivered through retail outlets and reprinted in consumer electronic magazines. They explained digital television and all the choices and variables in services, programs and consumer equipment. This work was recognized as an effective tool in education and adopted by other countries as part of their transition work.

From the work done on consumer education it was decided that a web based information source of information would be a useful tool. CDTV resourced and created a bilingual consumer section open to everyone on its website. Since its creation a couple of years ago hundreds of thousands of Canadians have used it to gather more information about HDTV. In addition a 15-minute infomercial and several 30 s promos were produced and aired to both provide HD information and push people to the website. Similar efforts will be required in the future, as analogue shutdown becomes a reality in Canada.

The education, training and development of the independent production on HD production were the final major projects taken on by CDTV to aid the transition. Again, a bilingual website was created that contained information and practical experience about, equipment, facilities, production and editing of HD material. Originally conceived as a series of training modules that may be adapted to workshop environments, the website has proven a valuable tool for Canada's content creators. It is sad to note that additional funding could not be achieved to run workshops in all regions of the country to work with the production and broadcast community to create a better understanding of the challenges associated with HD production and how to meet these practically and efficiently. The production of HD content is still very modest in Canada but this is beginning to change and it should be encouraged.

While the core mission was on terrestrial broadcasting a great deal of time and effort was spent on assisting pay and specialty services to make the transition and supporting their needs for effective policies and regulation, facilities and capacity, and education.

During this period CDTV became the principle source of HD information in Canada for both trade press and general media. In the late nineties and in the early part of the two thousands the interest tended to be more industry related but today the Canadian consumer is engaged and very hungry for relevant information. Importantly, it is not about digital television that engages the consumer but it is High Definition, which is capturing their interest.

It is probably fair to ask if a transition association like CDTV was working so well, why it ceased its work a few months ago. Probably for two basic reasons:

The environment in 1998 was very different than it is today. There was less concentration in the broadcast industry and generally more reliance on associations to represent the industry sectors in designated areas. Emerging platforms and new technologies like IPTV and mobile applications were not a huge market factor in 1998, yet they are increasingly dominating discussions today.

At the core broadcasters, who were to make the transition from analogue to digital transmission platforms, drove CDTV. As markets fragmented and viewing reception for transmitter received services declined, the consensus achieved by the Task Force to transit to digital transmitted services began to break down and eventually eroded the support for an association whose mandate was to see the transition through.

With the above in mind, the industry members felt the association had gone as far as it could and its mandate was complete from their perspective given the new environmental realities. Many elements of this 8-year phase of Canada's DTV transition were done well and made substantial contributions to the process. Issues of timeliness, a focus on what the Canadian broadcast system should be when the transition is complete, and an end date for analogue needs to be urgently answered before the transition may proceed.

The Present

The Current Players and the Issues

Canadian broadcasters have demonstrated reluctance to build transmission infrastructure and thus there are only transmitters in Toronto, Montreal and Vancouver as noted earlier in this text.

Conventional broadcasters have invested in considerable digital HD equipment in their network centres but very little in regional locations across the country. To date they have depended on cable and satellite delivery of their HD signal to locations across the country. In some cases because of cable and satellite bandwidth constraints and the strict application of the carriage rules, this national coverage is not as good as the broadcasters would like.

There are no French language networks, which are providing digitally transmitted HD or SD services aside from SRC. Most of the transition developments have been within English services. While there have been more than 40 temporary licenses issued there have been relatively few actually act upon. Most of these are English services. With some 12 transmitters on the air and broadcasters reluctant to build out their digital transmission infrastructure the future of conventional terrestrial television, as we have historically understood it, seems to be poised for a change.

Digital HDTV set penetration is projected to be over 3 million by year-end in Canada and most of the sets now coming to market have built in tuners.

Hook ups to HD services from a BDU are still modest in Canada with numbers approaching 600K by year-end in Canada. This figure is expected to dramatically increase over the next few years.

It is difficult to assess IPTV, mobile, and multi-platform delivery and their impact on the terrestrial digital transition. All industry sectors are coping with these challenging issues and they are increasingly becoming central issues in developing future business models. However, it is a difficult to suggest that conventional broadcasters have not made the transition to transmitted digital services because of these emerging technologies. At this stage, they are just too peripheral to the core

business. The only apparent reason is the declining viewing to terrestrial services directly from the transmitter and the costs of duplicating the existing analogue system with digital transmitters for a decreasing audience return. In simple terms, there is no business case.

Although this paper focuses on terrestrial television it is important to understand the steps taken by the BDU industry to increase capacity that provides both more choice and HDTV capacity. Cable has worked to upgrade its capacity in recent years and has migrated its customer base to digital delivery with demonstrable success. The end of analogue conventional television would ease the bandwidth crunch that is clearly apparent in a transitional environment. Measures to speed up this process would benefit both the consumer and the industry interests. By necessity, these measures must be part of an agreed overall transition plan with a firm analogue shut off date.

Satellite DTH providers are already all digital but face similar capacity issues in this transitional phase which must be addressed. Likewise, Satellite carriers will face increasing demand and capacity issues as more services move to digital HDTV demanding more bandwidth in a finite satellite universe. Delivery to BDU head end, collection and backhaul in a HD environment puts tremendous pressure on the carrier and cost for the service provider whether conventional or pay and specialty. New compression technology and new Satellites may well be part of the solution for DTH providers and Carriers but a definable end to the digital transition would provide some certainty in the market place for all the players.

The above discussion provides some of the background that the recently held Television Review and the Canadian Government Directive concerning the impact of new technology on the future of broadcasting has considered. The reports and decisions, which arrive from it, will be very important to the future digital transition of the industry.

In reviewing the many submissions for consideration in this process, it was clear that most conventional broadcasters do not want duplicate their entire analogue transmitter structure and many see little or no future in transmitted services at all. The difficulty of these submissions is there seems to be no clear alternative or plan for what a new conventional broadcast system would look like in a non-analogue world.

Virtually every country in the world, which has embarked on a Digital Transition plan for terrestrial services, whether it includes HDTV or not, has a definable plan including scope and timeframe. The Canadian situation has suffered from this lack of definition and this now needs to be addressed.

Action Required

In order to expedite the transition of Digital Television, the regulatory process would have to address the following issues:

A policy decision about the future of terrestrial television.

If transmitted terrestrial services are to remain in the digital world do they mirror the current analogue coverage, a part of that coverage or not at all?

If there are Canadians disenfranchised by a decision to reduce transmitter coverage how do they receive their basic service?

Coincidental with this decision an analogue shut off date needs to be established with definable and measurable milestones.

A plan for informing the public and ensuring that all Canadians can receive a television signal with analogue shut off needs to be established.

The digital benefit for consumers needs to be defined (HDTV and/or enhanced choice) and realized by conventional and pay and specialty broadcasters.

Attention needs to focus on the new technologies; how they can both challenge and enhance the core conventional services in a multi-platform environment.

Capacity needs to be assessed in the distribution system to ensure that all services that need to transit to digital HDTV can do so in a timely cost efficient manner. There will be a capacity crunch and it cannot be a barrier to transition.

A plan for regional and local participation in the digital transition needs to be addressed, including local HD production and services.

A plan for the creation of Canadian HDTV content in all program genres to service Canadian HD services that now rely largely on foreign produced HD product.

It is worth repeating that a great deal of good work has been accomplished in the last decade and it is important to see these suggestions in light of that work and building upon it. At the same time, the current transition to digital HDTV is in crisis and needs to be firmly put on track, particularly for conventional terrestrial broadcasters. Canada has gained a lot of first-hand experience and knowledge of other countries and their challenges and triumphs. It is now time to take that experience and knowledge and resolve the future of the Canadian Broadcasting System in the digital HD world.

The Future

Given the changes to the broadcast environment in the last decade, it is difficult if not foolhardy to try to predict the future. None the less there is some givens that can shape our environment over the next few years.

High Definition programming will become the new norm over the coming years throughout most of the developed world.

All the new emerging technologies and platforms will have a business impact that will benefit and challenge the core conventional broadcast business in a multi-platform environment characterized by quality, choice, and consumer empowerment.

Content will need to be created at the highest possible level of quality for shelf life and conversion for multi-platform delivery. The 1080 progressive production standard will be the international HDTV program exchange standard. HD delivery will be either 720p or 1080 depending on spectrum availability and the nature of the service distributed

The ATSC family of standards will evolve to an advanced compression codec which will enhance the value of terrestrial television spectrum, this is already happening with the DVB-T standard. Future digital receivers will be capable of receiving both MPEG-2 and MPEG-4 signals (France is currently rolling out these boxes as part of their DTV transition).

Further work on the development of improvements in the ATSC system and receiver sensitivity with emphasis on work which may lead to solutions for wireless services and broadcast services in remote communities. This could be a part of the answer for bringing transmitted digital services to rural Canada.

A plan for analogue shutdown with a responsible agency or group who may be held accountable by the viewer and citizen will be critical to analogue shut off.

The Canadian Broadcasting System will continue to enjoy a balance of cable and satellite delivery along with the internet, and telecommunications services all providing real time, video on demand, and streaming services to the viewer. Consumer devices will enhance the viewer as programmer but for the foreseeable future conventional television will continue to drive the industry in terms of content and national, regional, and local reflection. Wireless delivery of these services has a role to play within this system.

Conclusion

Canadian distribution and collection of programming via satellite led the world in using this new technology to the benefit of broadcasting. Canada built the longest stereo FM network in the world.

And Canada's television production industry has thrived in the most competitive market in the world producing indigenous product for Canadians, while producing and selling for the rest of the world. Not bad! Canada has done so with the right balance of policy, regulation, incentives, creativity and entrepreneurial skill.

Canada is again at another critical point in its broadcast history. The environment has rapidly changed and yet the issue of valued Canadian services for all Canadians in all parts of the country remains as the constant core issue. Decisions made over the coming year will provide the framework that will define Canadian success in completing the digital transition to HD service for conventional broadcasting and in turn the rest of the system. These are important decisions that require a timely response. Not to respond will leave the current system in disarray and less relevant for both the Canadian viewer and the global community in which it has been a player.

ATSC-DTV distributed transmission network

Introduction

Distributed transmission (DTx) network is a network of transmitters that covers a large service area with a number of synchronized transmitters operating on the same TV channel. DTx offers interesting possibilities for digital TV transmission systems.

As explained in the ATSC Recommended Practice for Design of Synchronized Multiple Transmitter Networks¹⁴, DTx networks have a number of benefits over the single central transmitter approach, which has so far been the usual way of covering a large service area with analogue TV transmission. These benefits include:

- More uniform and higher average signal levels throughout the coverage area.
- More reliable indoor reception.
- Stronger signals at the edges of the service area without increasing interference to neighboring stations.
- Less overall effective radiated power (ERP) and/or antenna height resulting in less interference.

DTx networks can also reduce the number of channels used to cover a large service area and can free spectrum for other applications such as interactive TV, multimedia broadcasting, or any other application that may come up in the future.

As a trade-off for these benefits, implementation of a DTx network requires a very careful design when a DTV adjacent channel is operating in the same market area¹⁵. A more serious limitation on the DTx operation is that in the possible presence of NTSC adjacent channels operating within the same market area. In such cases, implementation would be very challenging if not impossible. This is due to the higher protection ratios required by NTSC, as opposed to DTV, from an adjacent channel DTV. However, such limitation will not exist after the transition period from NTSC to DTV.

Another important issue affecting the design of a DTx network is the ATSC-DTV receiver's performance with respect to their multipath handling capabilities. Better receivers, capable of handling stronger pre- and post-multipath distortions (pre- and post-echoes) on a wider range of delays, make DTx network design more flexible and simpler. On the other hand, receivers with

¹⁴ Advanced Television System Committee (ATSC), Recommended Practice – A/111, “Design of Synchronized Multiple Transmitter Networks”.

¹⁵ Advanced Television System Committee (ATSC), Recommended Practice – A/111, “Design of Synchronized Multiple Transmitter Networks”.

weaker multipath handling capabilities put more restrictions on the design and implementation of DTx networks.

In addition to providing many guidelines for designing a DTx network and managing its internal and external interference under different conditions, the above mentioned Recommended Practice proposes three methods (or their combinations) for implementing a DTx network.

DTx methods

The first method is distributed transmitter network, commonly known as single frequency network (SFN), consisting of a central studio that sends baseband signal or video-audio data stream to the SFN transmitters via studio-transmitter-links (STL). STLs can be fiber optics, microwave links, satellite links, etc. The SFNs may be costly to implement and operate. The SFN transmitters in this configuration require subtle (and rather complex) processes for their frequency and time synchronization with each other.

The second method is called distributed translator network in which the transmitters contributing to the SFN, which are some coherent translators all operating on the same channel, translate the frequency of an over-the-air signal received from a main DTV transmitter to a second RF channel. This eliminates the need for a costly Studio to Transmitter Links (STL). On the other hand, frequency and time synchronization for this configuration is quite simpler than the first method. During the translation process to the designated output channel, necessary corrections may also be applied to the signal. In this configuration, however, the main transmitter feeding the coherent translators is operating on another channel and is not part of the SFN. But one may consider this as a sort of frequency diversity in the overlapping coverage area of the main transmitter and the SFN.

The third method consists of digital on-channel repeaters (DOCR) that can differ from each other in the way that they process the signal through the path from their input to their output antennas. The DOCRs contributing to the SFN again pick up their inputs from a main transmitter, eliminating the need for any STL, and transmit on the same channel as they receive. Each DOCR can work on the basis of direct RF operation, conversion to IF or to baseband and up-convert again to the same channel as it receives. In order to form an SFN, however, all the repeater's outputs should be synchronized with each other and also with the main transmitter feeding them.

With this approach, two limiting factors exist on the operation of the network. First, the main transmitter signal can create advanced multipath (pre-echo) in the overlapping coverage areas between the main transmitter and the repeaters. For creating pre-echo, the repeater's signal must be dominant in such overlapping areas. This may be problematic to the ATSC legacy receivers that are vulnerable to pre-echoes. Second, depending on the amount of feedback from DOCR transmitting to receiving antenna, there is a power limitation on the repeater's output.

The Communications Research Centre (CRC) of Canada has already studied, by performing various field tests, different applications of direct RF operation OCRs and their performance under different conditions, and has published the results^{16, 17}. The below study focuses on the second configuration of distributed transmission network, which is "distributed translators".

¹⁶ SALEHIAN, K., GUILLET, M., CARON, B. and KENNEDY, A: On-channel repeater for digital television broadcasting service. *IEEE Trans. Broadcast.*, Vol. 48, 2, p. 97-102.

¹⁷ SALEHIAN, K., CARON, B. and GUILLET, M. Using on-channel repeater to improve reception in DTV broadcasting service area. *IEEE Trans. Broadcast.*, Vol. 49, 3, p. 309-313.

Setup and methodology

The distributed transmission network under consideration by the CRC consisted of three coherent translators. The translators received their input signal on channel 67 (788-794 MHz) from a medium power DTV transmitter having a tower height and EHAAT of 209 and 215.4 meters, and located at about 30 km south of Ottawa, Canada. This DTV transmitter covers Ottawa and its surroundings with an average ERP of 30 kW through a horizontally polarized omni-directional antenna system.

The translators converted the received channel 67 to channel 54 (710-716 MHz) through direct RF to RF operation. They were all frequency synchronized and their timing was adjusted to make them transmit with no delay with respect to each other.

The translators were installed on the top of three high-rise buildings in downtown Ottawa. They covered a common rectangular target area of approximately 1.66 by 1.14 km, and their output powers, which were between 15 to 25 W e.r.p. (enough to cover the small rectangular target area), were adjusted to produce equal signal strengths at the centre of the target area. Figure 37 shows the relative locations of the three synchronized translators along with their overlapping target area. Also shown is the direction of transmission of the three translator's output antennas and their 60° beam width. The main DTV station, which covers the whole Ottawa area including its downtown in which the DTx target area is located, is outside the map in the bottom right direction at a distance of 25 km from the centre of the target area.

Receiving conditions

The receiving conditions for these tests were intentionally selected to make a worst case scenario for the study. A single target area was selected for all three translators (see Fig. 37). In this way, the translators could create a lot of artificial multipaths (active echoes) in the target area. On the other hand, the downtown canyon, in which such target area was located, made the situation worse by creating additional static and dynamic multipath through reflections of each of the translator's signal from high-rise buildings and moving vehicles (passive echoes).

FIGURE 37

**Ottawa distributed translator network.
The rectangular target area is 1.6 × 1.14 km**

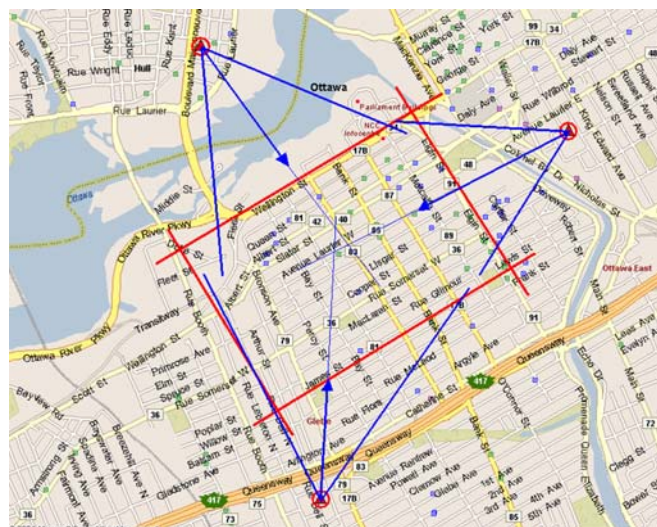

The measurement points were at the corners of the grids of a lattice covering the target area. A total of 59 points, at distances between 100 to 200 m from each other were measured. For the measurements, which were made on the street sidewalks at about 1.5 m above ground level (AGL), two types of antennas were used, an omni-directional antenna and a low gain directional antenna (usually used for indoor reception) with about 5 dB gain and 60° beam width.

Both antennas were made active by connecting them to a low noise amplifier (LNA) of about 1.2 dB noise figure and 20 dB gain, and also a band pass (BP) filter installed on the same stand as the antennas.

Characteristics of the receivers used for the tests

For these tests, two types of receivers were used, a new prototype, and an older generation receiver. The new prototype receiver, as compared with the older generation, was capable of handling pre- and post-echoes with a much wider delay range.

Figure 38 shows the relative attenuation of a single static echo at different delays, at which the receivers are at the threshold of visibility (TOV). As it is seen, the older generation receiver (Receiver G in the figure) could operate with about -5 dB echo in the range of -3 to $+40$ μs . The new generation receiver (Receiver V in the figure), on the other hand, could handle pre and post echoes over a wider range. It was capable of handling -10 dB pre- or post-echo with a delay spread of -50 to $+50$ μs , or -5 dB echo in the range of -25 to $+25$ μs .

FIGURE 38

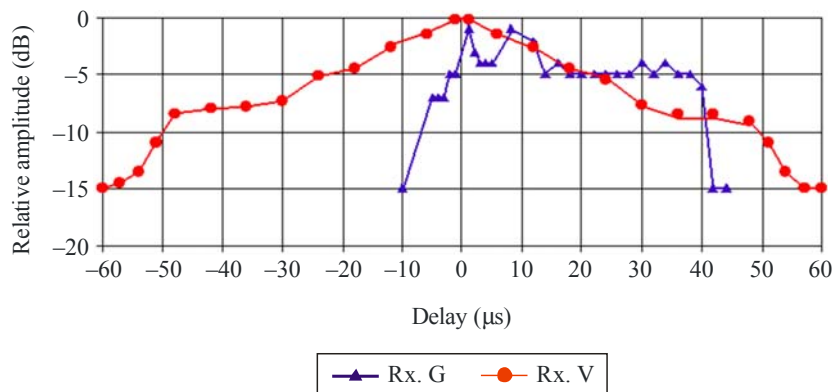

Report BT.2140-38

Performance of the two receivers used for the tests

Test results

In the first phase of the tests, the feasibility of implementation of such a network was verified. In the next phase of the study, measurements were performed in 59 points inside the target area. Table 12 shows the percentage of locations in which successful reception was achieved.

TABLE 12
Percentage of reception points with successful reception

	DTx (CH-54)	
	New Prototype Rx.	Older Generation Rx.
Directional Rx. Ant	97%	54%
Omnidirectional Rx. Ant.	71%	19%
	Main Tx (CH-67)	
	New Prototype Rx.	Older Generation Rx.
Directional Rx. Ant	93%	36%
Omnidirectional Rx. Ant.	44%	10%

Table 12 shows the results for DTx (CH-54) and also for the single distant transmitter (CH-67), using the new prototype and the older generation receivers, and also using directional and omnidirectional antennas. As it is seen, the results are somehow better, under all circumstances, with the DTx network as compared to the single transmitter configuration.

Comparison of the results, however, can be made based on the type of the receiver, type of the receiving antenna, or type of coverage. What is quite evident is that under any condition, the reception situation is remarkably improved when the new generation receiver is used instead of the older generation receiver. Another major improvement can also be seen with using directional antenna instead of omni-directional antenna for both DTx and single transmitter. This has probably been due to the attenuation effect of the antenna on signals coming from the directions other than the main signal and acting as multipath.

Another important result that can be highlighted from this table is the fact that the DTx network, as compared to single transmitter configuration, has improved the situation also for the older generation receiver under all conditions (although not significant in all cases). The most significant improvement is when directional receiving-antenna is used. Under this condition, distributed transmission could improve the percentage of points with successful reception from 36% for single transmitter configuration to 54% for DTx network.

Conclusion

For the study in this section, a distributed transmission (DTx) network, consisting of three coherent translators, was used to cover parts of the coverage area of a single transmitter. Two types of receivers and two types of receiving antennas were used and measurements were made in both channels corresponding to the DTx network and the single distant transmitter. The reception conditions were made very tough by choosing overlapping coverage area located in the hostile downtown environment for the DTx network, and also by making the measurements at 1.5 m AGL on the street sidewalks.

The results showed that the DTx network had better reception availability than the single transmitter, especially when omni-directional receiving antenna was used.

The results also showed remarkable improvement in the performance of a new prototype receiver in the SFN environment, as compared to an older generation receiver that was used in the tests. This was because of the major improvement in the multipath handling capabilities of the new prototype receiver, which makes the implementation and operation of ATSC distributed transmission networks possible and reliable.

Another important result was the impact of even small directivity of the receiving antenna on reception. Directional receiving antenna, as compared to the omni-directional one, could provide successful reception for a greater percentage of the measurement points.

The test results also demonstrated reception improvement for the older generation receiver under SFN operation. However, because that receiver was only one generation older than the new prototype one, more tests are required to investigate the performance of the legacy receivers in a distributed transmission environment.

5 Germany

DTTB was officially launched on 1 November 2002 and, by the end of 2008, all transmissions were completely digital, using the DVB-T standard. The business model is free-to-air broadcasting. The country's channel planning is based on the framework of the national frequency rights resulting from the ITU-R Geneva Agreement 2006 (GE-06), using predominantly the service concept "portable outdoor" (RPC-2 according to the Geneva Plan plus one or several assignments per city for high-power transmitter). This service concept generally enables indoor reception in the German agglomerations, which makes up one half of the total area, where typically more than twenty digital programmes are available in standard definition (SD) quality. Outside of these agglomerations, DVB-T can either be received as "portable outdoor" or by using directive antennae. With respect to HDTV, first test transmissions have taken place. Trials are also carried out concerning the transmission of sound radio programmes within a DVB-T multiplex.

There are various types of receivers on the market, ranging from USB dongles for PC and laptops over small portable TV sets for handheld and in-car reception (screen size typically between 5 and 7 inch of diameter) to set-top boxes and stand-alone TV sets for stationary reception (typically with flat-screen displays). In May 2008, the first mobile phones with integrated DVB-T receivers appeared on the market. In addition, car navigation systems are nowadays equipped with DVB-T receivers.

The switch-off started in Berlin-Brandenburg in August 2003. Already by the end of 2003, some six million people were able to receive 26 digital channels in SD quality in the city of Berlin and the federal member state of Brandenburg. This was the first switch-off of terrestrial analogue television worldwide. This success can be ascribed in part to the Government, which decreed that the service was to be totally free of charge, and which provided, only in 2003, free decoders to the poorest households. Under no other circumstances, the purchase of DVB-T receivers was subsidized. By the end of 2007, more than 85% of the German population (68 million people) could already receive digital terrestrial television. More than nine million receivers had been sold by that data. The success of DVB-T in Germany was due to the fact that the reception of a multitude of German-speaking programmes was available to the general public free-of-charge. In 2008, DVB-T is used by 16.8% of the households in Berlin –Brandenburg.

In other metropolitan areas, DVB-T transmissions started in 2004. One key element of the German approach was the implementation of the digital broadcasting service region by region, initially after an announced transition period of as little as six months and later on without any simulcast period. By the end of 2008, the switch-over will definitely have been completed (two years earlier than originally planned).

By the end of 2008, some 15 million DVB-T receivers are expected to have been sold since the launch of the service. Nevertheless, for their primary TV service in the households (large flat screen in the living room) approximately 90% of the Germans still rely on cable TV or satellite distribution.

Detailed information could be found at following links:

<http://www.alm.de/fileadmin/forschungsprojekte/GSDZ/digitalisierungsbericht2008D.pdf>

and

<http://www.ueberallfernsehen.de/>.

6 Guinea

Legal and regulatory aspects

It has to be acknowledged that analogue radio and television broadcasting are not very developed in certain African countries, for example the Republic of Guinea, where radio broadcasting was introduced only in 1952, and television in 1977.

The transmission medium initially used was the radio-relay network, constructed in 1977.

Today, this network, operated by the Department of Posts and Telecommunications and digitized to the tune of 85%, does not carry television and radio signals owing to the advance of satellite broadcasting, which is favoured by the Government. However, we are convinced that the rapid development of radio and television broadcasting will of necessity involve digitization through liberalization of the audiovisual sphere.

Legal and regulatory framework for DTT

In the Republic of Guinea, the tools and infrastructures conducive to the rapid opening up of digital radio and television broadcasting are to be found in different sectors, with much of the equipment (radio and television transmitters, studios) being administered by the Ministry of Information, while other equipment (shortwave and medium wave radio transmitters and terrestrial radio-relay transmission facilities) is administered by the Ministry of Posts and Telecommunications. The Government would be better advised, with support from the development partners, to group the various communication media under the same authority, pending the opening up of the audiovisual sphere.

Technical aspects

Two alternatives may be envisaged for the migration from analogue broadcasting to DTT:

- close down the analogue system and construct an entirely digital network, or
- deploy a hybrid system (analogue and digital).

The second option would seem to be the most appropriate for developing countries. It involves using the existing analogue network with a certain amount of refitting and the construction of a number of sites. However, the paramount requirement for making the DTT network more operational is a redistribution (replanning) of the frequencies used, this being the task of the regional radiocommunication conference (RRC) over the coming months.

Furthermore, the fact that our States currently use the radio-relay network for their radio and television signals leads us to recommend, for those countries that share a common border, that they jointly replan their frequencies and select the same digital television system, namely DVB-T, which is technically more adaptable than the ATSC(A) and ISDB-T(C) standards. The B(DVB-T) standard is less costly and more advantageous to developing countries during the transition period. This will allow for more fruitful regional consultation aimed at harmonizing the technical facilities to be used when introducing digital broadcasting equipment.

7 Italy

7.1 The EVA system

EVA (Signal Quality EVALuator) is a system designed and implemented to ensure a constant monitoring of the technical quality of the Rai offer to the customer. It also provides the General Directorate with a fast and effective communication of technical inefficiency that generates a visible impact on users of services with common platforms, i.e. analog broadcasting, digital terrestrial and digital satellite broadcasting. The system, which covers the entire production process from the production of the signal to the broadcast distribution to users, guarantees – in accordance with a provision of internal organizational communication – a fast internal communication of disruptions in order to identify:

- failure to deliver and distribute broadcasting services for a duration longer than 5 min, relating to 32 terrestrial Class 1 broadcasting plants and to the Rai satellite broadcasting services;
- failure to deliver and distribute broadcasting services for a duration longer than 10 min, for the 57 Class 2 broadcasting plants;
- disruption of television and radio broadcasts for more than 20 s;
- audio and video anomalies (RF/TV) longer than 1 min;
- transmission of a program with a delay of more than 1 min, if due to technical reasons;
- transmission of a wrong program.

The speed of communication ensures notification:

- within two hours after the event (except for § 2 where the event is notified within 4 o'clock p.m. of the next day);
- for failures that occur between 00.00 and 06.00 a.m. the running part from 6.00 o'clock a.m.

The new system allows RAI's structures to coordinate the activities of collection, verification and management of anomalies and to identify any required corrective actions. Its actions in real time include:

- inform top management about anomalies perceived by customers;
- monitor the communication process across the right company paths.

In terms of quality management for the continuous improvement, the system allows to perform sophisticated analysis on the collected data to support the identification of strategies to improve technical quality. The important aim is to help the corporate quality department in finding suitable preventive and corrective actions to improve the services offered to the public at large.

7.1.1 System architecture

The architecture of the system uses, on one side, the channels of communication officers of the structures involved in the production process and, on the other side, the "virtual user" which are sensors or devices capturing analog and digital signals in service area. They measure directly on the territory the parameters conventionally used to evaluate the technical quality of broadcasting services: the information received is analyzed in real time from the central system for managing communication anomalies operators and also for archiving and statistic purposes.

The system architecture is shown in Fig. 39.

FIGURE 39

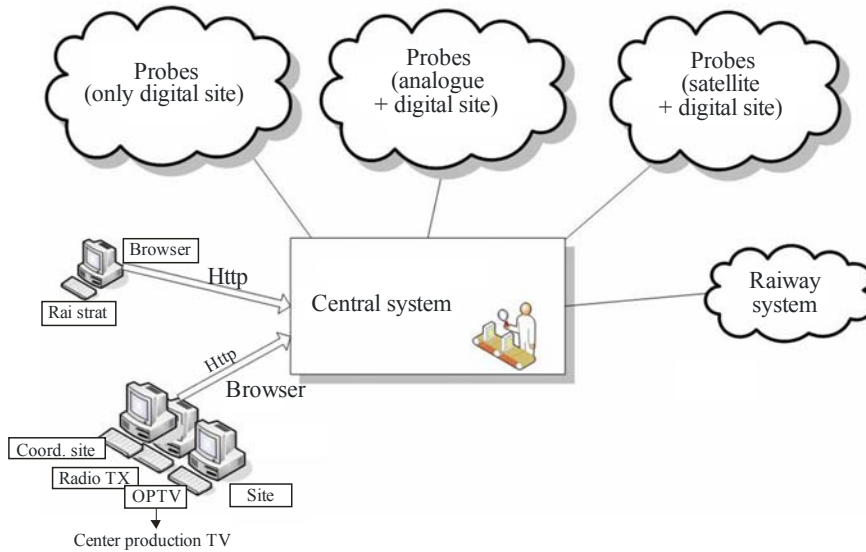

Report BT.2140-39

Where “probes” stand for remote devices placed in several Rai’s regional branches and which ensure the technical monitoring of the diffusion network; the graphic symbols represent the Company structures directly involved in the whole production/distribution process up to the customer. The entire workflow has been supplied with warning functionalities as e-mail (Exchange infrastructure) and sms (SMS Gateway infrastructure).

All warnings are collected in a centralized database. The technical collection of measures from remote sensors is carried out by a specific system component called “Dataminer”.

The EVA system afterwards assembles information from remote devices (measures) and from internal/external company structures (communications) in a central architecture as shown in Fig. 40.

FIGURE 40

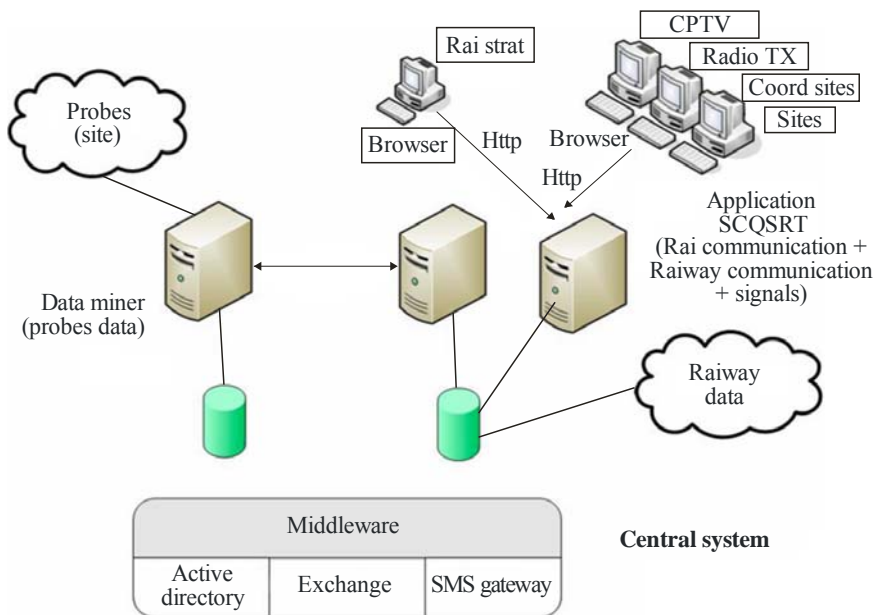

Report BT.2140-40

7.1.2 The measuring section

A typical remote device (so called “virtual user”) for all digital areas is the following:

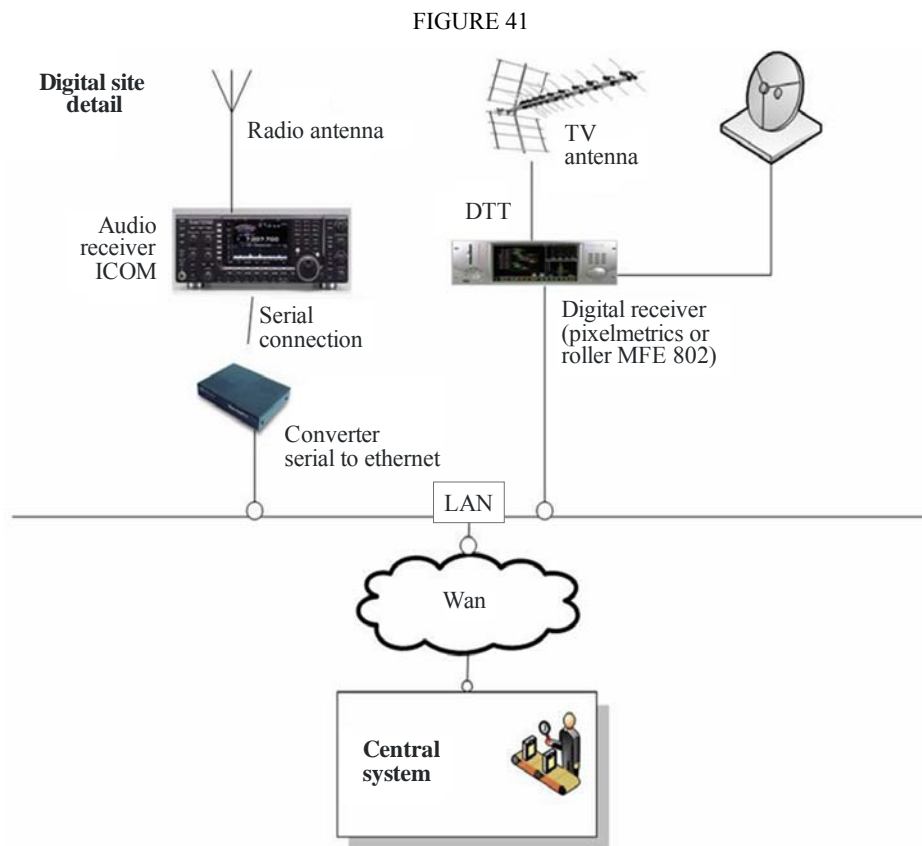

Report BT.2140-41

Technical parameters monitored by remote devices are different depending on signals (analog, digital, radio, satellite, etc.). Typically they are:

Analog services:

- Signal level.

Digital services:

- Sync loss.
- Continuity error.
- Signal level.
- MER.
- Pre-Viterbi BER.

For digital sensors we are studying the best threshold values for measure to be in line with the customer perceiving expectations.

The transport stream analysis of the DTT signal is possible (at present only for the same remote branches).

7.1.3 The communication section

As seen below EVA also collects structured communication on faults coming from all company sections involved in broadcasting process. Operators can put into system warning messages with different severity. The procedure is a system driven by user friendly forms like this:

where all requested information contributes to give a complete fault picture without interfering with the normal working process.

The EVA system has a layer WEB based software and is accessed by internal users according to a profiling policy (Operator, Supervisor, Responsible, Area Supervisor, Area Responsible, User monitoring, Supervisor monitoring, Administrator).

At different authorization levels the system allows a set of tools to manage the warning messages from the production/broadcast chain.

Data/Ora inizio	Luogo	Rete	Titolo Programma	Segnalazioni	Apri
17/10/2009 02:15:00	RVMMO: Roma	RAI ITALIA 1	xfactor	✓ ⚠	Apri
15/10/2009 19:33:00	RVMMO: Roma	Raidue	SQUADRA COBRA 11 - Nel...	✓ ⚠	Apri
15/10/2009 09:23:26	RVMMO: Roma	Rai STORIA	autunn caldo 15 ottobre	✓ ⚠	Apri
15/10/2009 00:53:00	Controllo Central...	RAI ITALIA 1	Pronto Elisir(Rai Italia1)	✓ ⚠	Apri
14/10/2009 23:47:45	Controllo Central...	Raidue	Spot Palco e retropalco (C8...	✓ ⚠	Apri
14/10/2009 23:17:00	Controllo Central...	Raidue	Spot "Anno Zero" (A3905)	✓ ⚠	Apri
14/10/2009 18:17:00	RVMMO: Roma	Raitre	Inserito pubblicitario LIDL 9...	✓ ⚠	Apri
14/10/2009 13:30:30	Studio: Roma	RAI ITALIA 1	italia focus	✓ ⚠	Apri
13/10/2009 09:15:39	RVMMO: Roma	RaiSport+	RUBRICA REPLAY	✓ ⚠	Apri

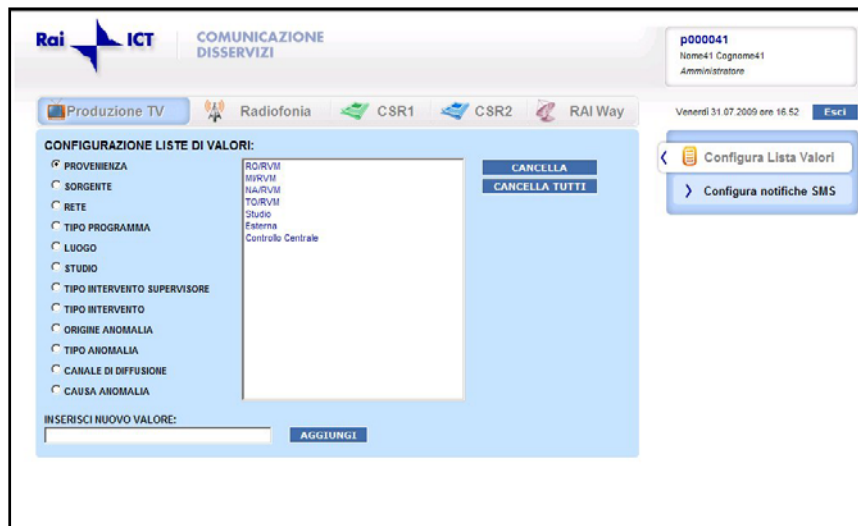

7.1.4 The monitor user interface

At the top level EVA offers a “dashboard” for a complete picture of the technical status of the Rai offer on air, with mask, screen report, interactive forms that manage the “measure” and the “communication” world.



7.1.5 Report and analysis section

Some reports and tools allow the administrator to perform analysis on archived data. Others are designed to evaluate the performance of entire TV/Radio broadcasting process and to better show areas which can be improved.

7.1.6 Quality certification

The system has a client-server structure and runs on a PC with a common WEB browser.



On June, 2010 EVA system obtained the quality certificate of conformity which will evolve according to system improvement.

7.2 “Rete Leggera”

“Rete Leggera” has been developed since 1998 inside the Monitoring Center of Rai as the natural evolution of previous systems and it is based on ITU Monitoring Handbook’s guidelines. Rai Monitoring Station has been part of the international monitoring network since its constitution in 1929.

The idea, on which the new monitoring network is based, was to verify the signal quality in target area in user perspective, using several fixed measurement locations which cover all the Italian Districts (about 100 Districts).

The monitoring network has been subject to several re-engineering processes, following the technical evolution and the new control requirements.

At the moment, the network is deployed on three hierarchical levels: UP (Peripheral Unit), UC (Concentrator Unit), UG (Management Unit), as shown in Fig. 42.

FIGURE 42

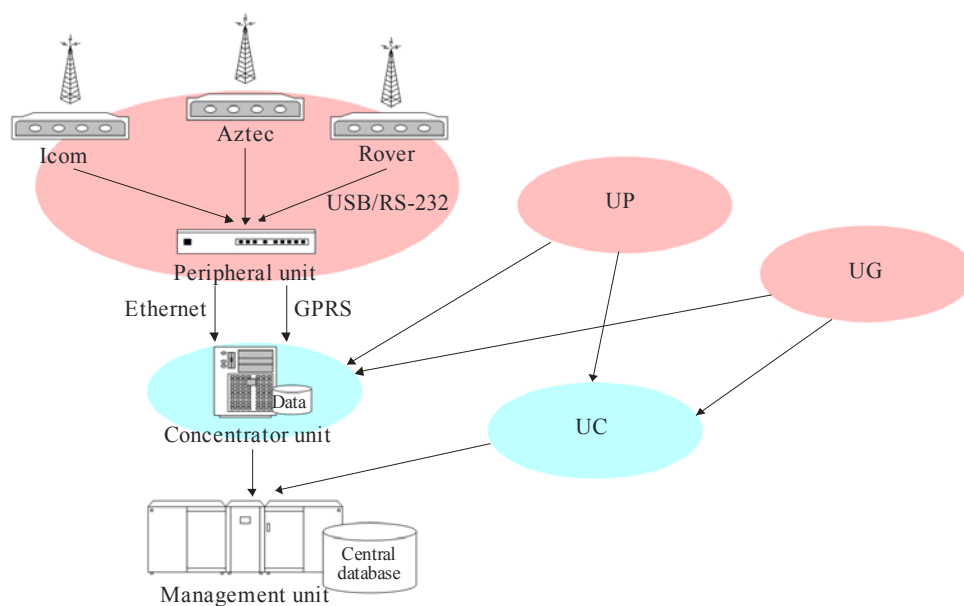

- UP: Collects measurement data in target area. It is composed by a processor, specific receivers, antennas and custom developed software. Collected data are not locally processed but sent directly to its UC.
- UC: Collects and processes data coming from its UP network. Its processor is based on high performance system. It is usually located by Rai premises and it is directly handled by the technicians of Monitoring Center.
- UG: Is the kernel of the system, where processed data are stored and shown on the Intranet WEB site. It is placed at Monza Monitoring Center.

7.2.1 DTTB measurements

Recommendation ITU-R BT.1790 recommends to deploy the monitoring activity on three layers and “to include monitoring of the received signal because clock jitter and cyclic redundancy check (CRC) errors are accumulated at each stage and sometimes lead to degradation of final quality, even if each process in a broadcasting chain conforms to the standard”.

Consequently, “Rete Leggera” has been developed following the principles mentioned above. The control activity is performed only on received signals following customized steps:

- Level 1: field strength measurements.
- Level 2: modulated signal (MER, BER, TPS).
- Level 3: coded-bit stream (ASI analysis and stream recording).

All measurements are performed by tuning cyclically the receivers on different channels, selected from a frequency table.

Level 1

Field strength measurements are carried out through a fast cycle compatible with the minimum time permitted by receivers. For this kind of measurements, no signal lock is required. The minimum required signal level at the input of the receiver is 30 dB(μ V).

Every measurement is compared with a **reference level**, which is the expected signal level/field strength, the **confidence interval** and the **threshold** under which a warning is generated. Only measurements outside confidence interval are stored in database.

FIGURE 43
RF Charts

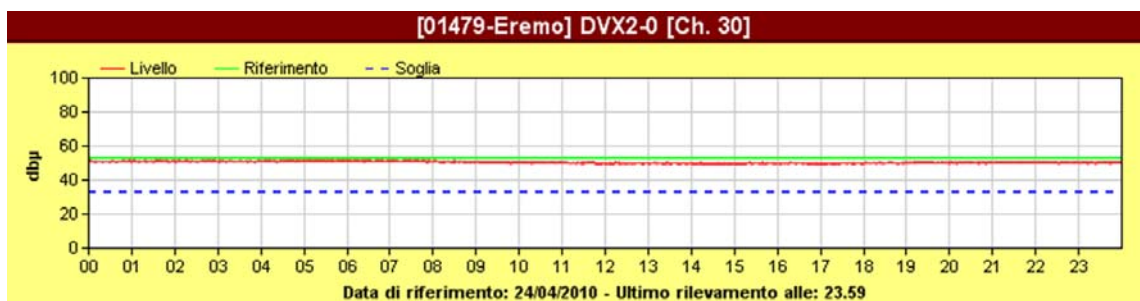

Level 2

Modulated signal measurement requires a signal lock on the channel under investigation. Signal lock needs a minimum time. In case of no lock a warning is generated. After locking procedure, the parameters MER and BER are measured by calculating the mean on 10 values. All measured values are stored in a database. Once a day, TPS check is performed.

FIGURE 44

MER chart (threshold values are defined by ETSI)

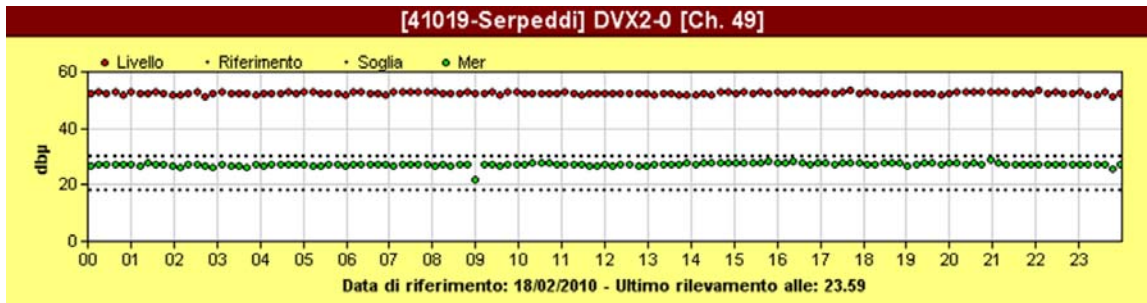

Report BT.2140-44

FIGURE 45

BER chart

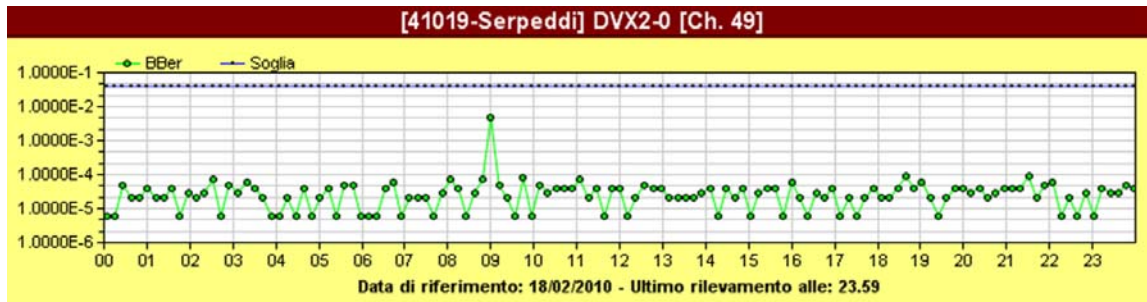

Report BT.2140-45

Using **signal level** and **BER value**, **signal quality** is calculated as indicated by Recommendation ITU-R BT.1735.

FIGURE 46

Quality chart

Qualità MUX3

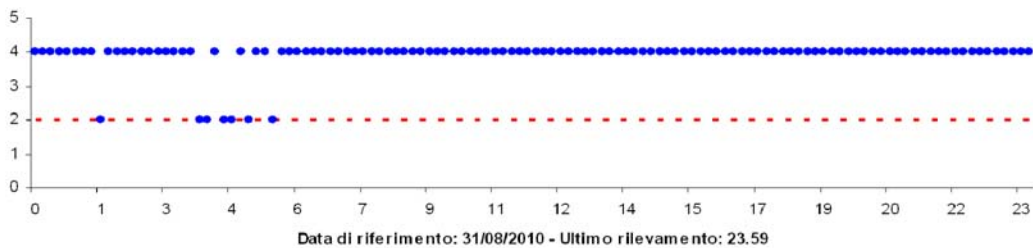

Report BT.2140-46

Level 3

At this level, a specific hardware composed by a receiver providing ASI output and a TS analyzer is required. Two different kinds of analysis can be performed:

- cyclical analysis on bit rate and null packet with dwell time of a minute on each multiplex under investigation. ASI stream can be also recorded for more detailed evaluation;
- long-term analysis on a specific multiplex to check the compliance with ETSI TR 101-290 protocol parameters for MPEG-2-TS monitoring.

In both cases, results are stored in the local database.

7.2.2 WEB user interface

All collected data are stored in the central database in Monza and processed to produce different types of results which are displayed on intranet Web site using various kinds of charts.

The global situation of the broadcasting net, in real time, is shown on a general map of Italy.

There, active warnings are displayed by red lights and warnings, which occurred in the last 24-48-72 h (the represented interval is selectable by the user), are displayed in a map by yellow lights.

FIGURE 47
Web panel

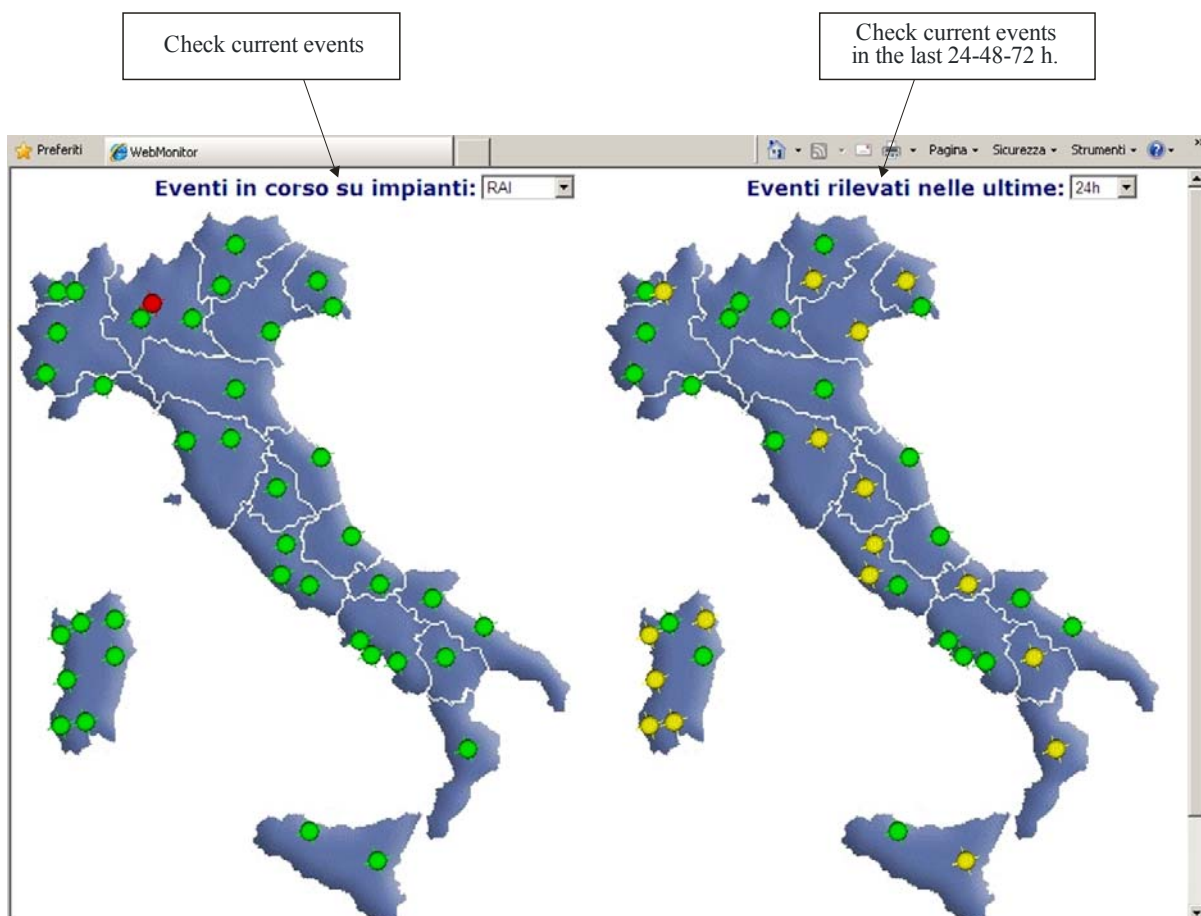

Clicking on the dots, the page of the chosen monitoring site is displayed. It contains the detailed information of all the channels controlled in this point.

Looking into the detail, the main page of a monitoring site shows the collection of RF real time signal level graphs for each controlled channel (see Fig. 48).

FIGURE 48
Monitoring chart

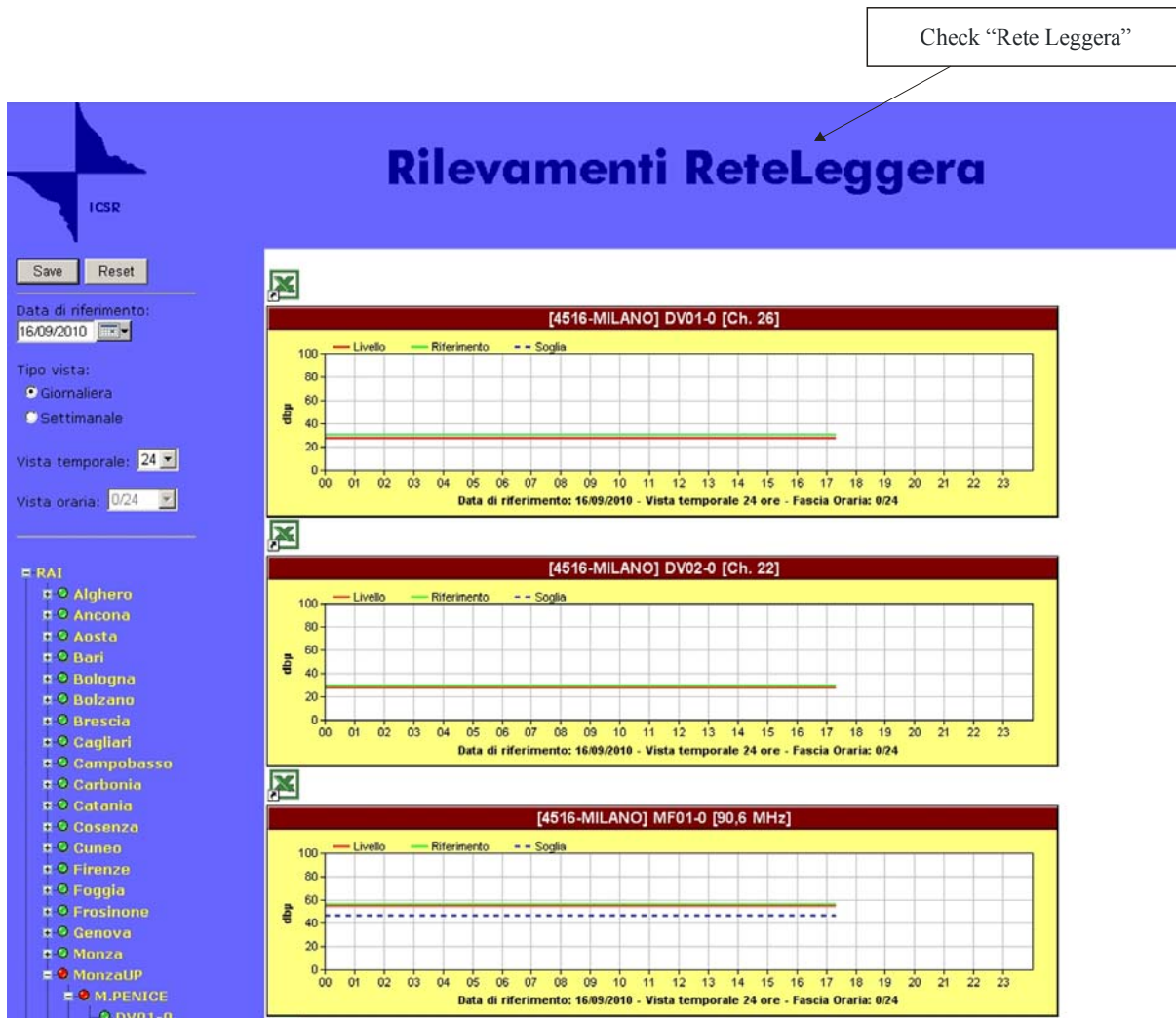

Report BT.2140-48

In the charts, it is possible to examine the details of measurements and signal level changes and even detect the details of the occurred interruptions.

In addition, users can display more graphs representing RF, MER, BER and quality measurements selecting monitoring sites, channels, services, data and time, according to their needs.

FIGURE 49
Monitoring details

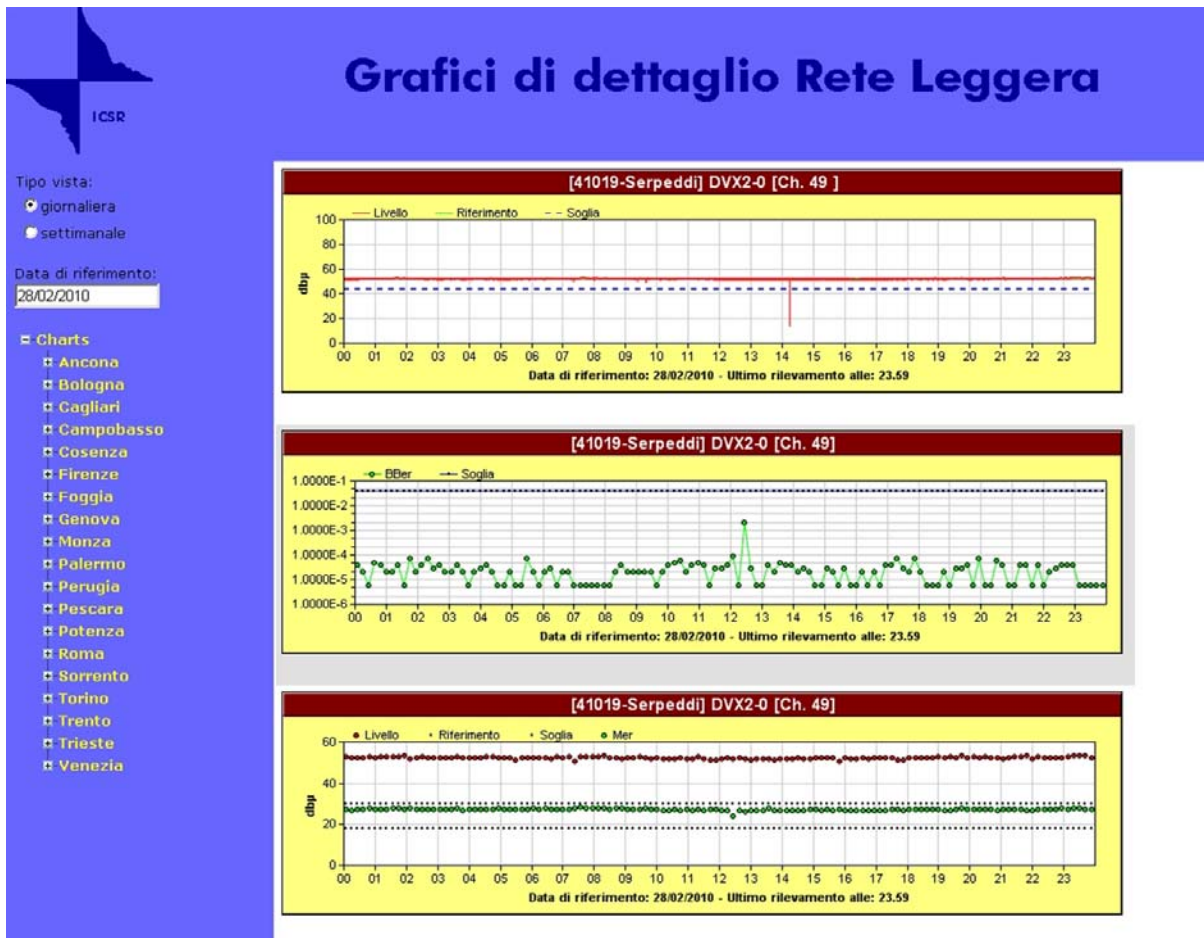

Report BT.2140-49

A section has also been developed where recorded ASI streams are available and can be reproduced (see Fig. 50).

FIGURE 50
Video recording

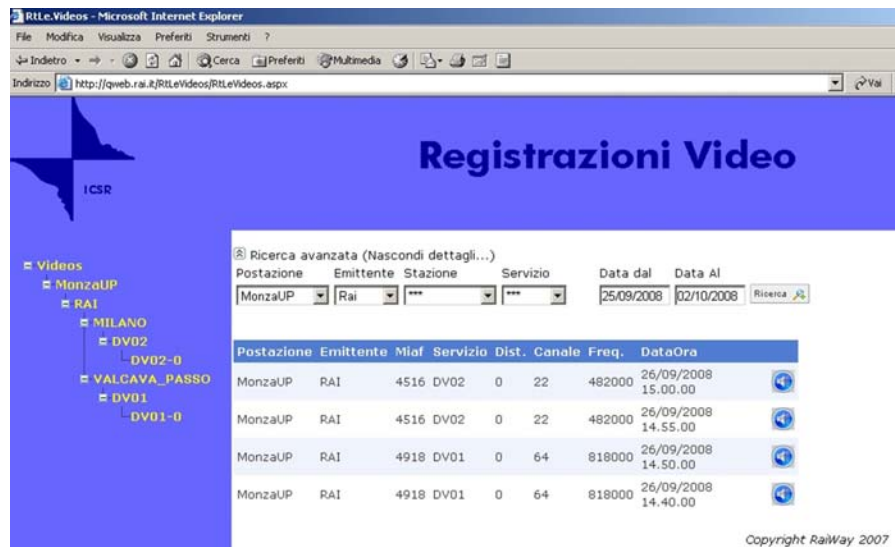

Report BT.2140-50

At the moment the web site is under re-engineering with the aim to add new facilities which can better match the new requirements.

7.2.3 Radio facilities

Of course, “Rete Leggera” has a parallel system for radio monitoring, but, at the moment, it is active just for analogical radio services, due to the fact that in Italy the implementation of digital radio is not yet started.

8 Japan

8.1 History in brief

The digital broadcasting system was discussed in Japan by the Telecommunications Technology Council (TTC) of the Ministry of Post and Telecommunications – MPT (current MIC: Ministry of Internal Affairs and Communications) and detailed technical matters were discussed at the Association of Radio Industries and Businesses (ARIB).

Under the concept of integrated services digital broadcasting (ISDB), three kinds of systems, ISDB-S (satellite), ISDB-T (terrestrial) and ISDB-C (cable) were developed in Japan to provide flexibility, expandability, and commonality to the multimedia broadcasting services using the networks.

Based on the results of field trials, the ISDB-T system was found to offer superior reception characteristics and consequently the ISDB-T system was adopted in Japan as the DTTB system and digital terrestrial sound broadcasting (ISDB-T_{SB}) system in 1999.

Figure 51 outlines the time schedule for DTTB in Japan.

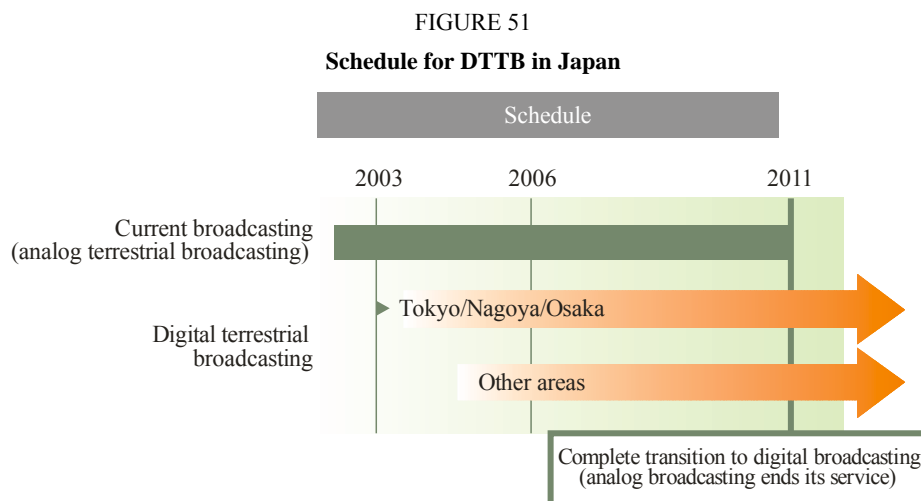

Report BT.2140-51

Broadcasters created a road map and constructed transmitting stations according to this plan. DTTB was launched in December 2003 in the Tokyo, Osaka, and Nagoya metropolitan areas. After that, digital terrestrial broadcasting started at the main cities in all other prefectures and 84% of households were covered by the end of 2006. Broadcasters constructed all relay stations and the service areas gradually expanded. Analogue terrestrial TV broadcasting was finally terminated in 2011.

8.2 Situation with frequencies

Analogue terrestrial broadcasting utilizes a multi-frequency network (MFN) with a transmission scheme that uses different transmitting frequencies in service areas. An MFN with many transmitting stations is a means to deliver programs to the national audience without causing harmful interference in service areas. Approximately 15,000 transmitting channels for analogue terrestrial TV broadcasting had been constructed throughout Japan. Consequently, there were not sufficient frequencies available for digital television broadcasting.

The Japanese government is undertaking a huge project to move the numerous analogue TV stations to the upper or lower parts of the spectrum to free up frequencies for digital television use (see Fig. 52).

FIGURE 52

Number of transmitting channels for analogue TV

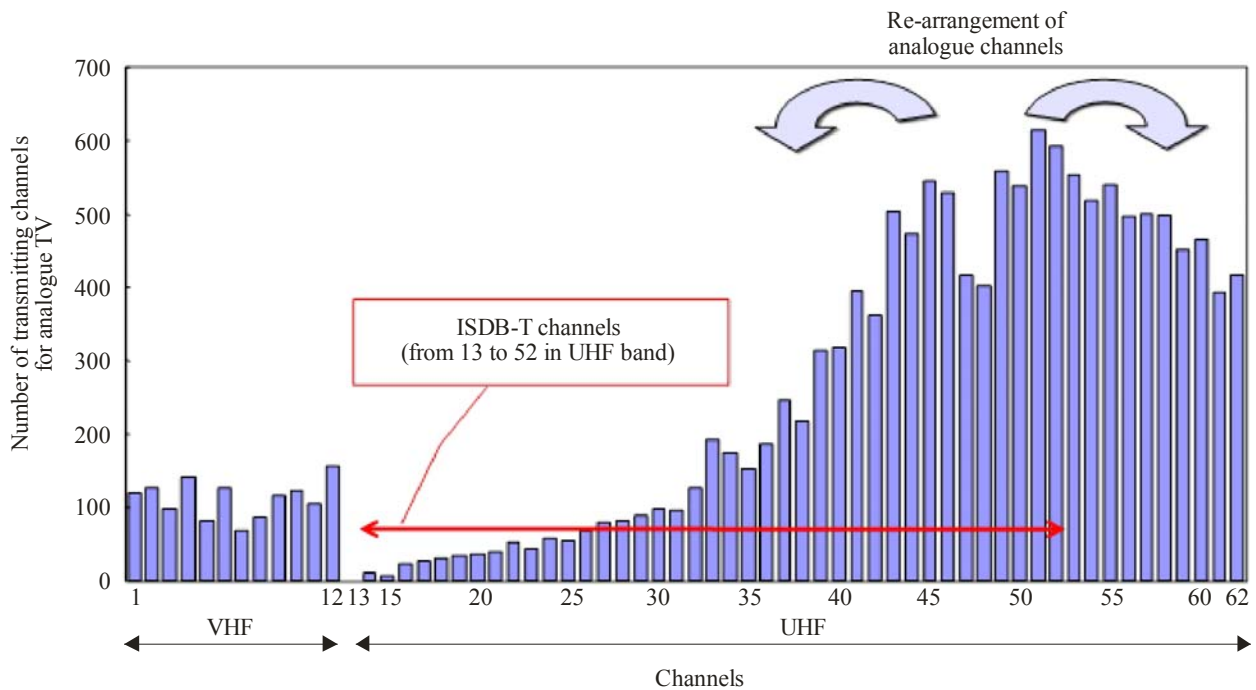

Report BT.2140-52

8.3 Transmission antennas

Broadcasters in the Tokyo area have placed new antennas at a height of 250 m on Tokyo Tower. A transmitter room was built under the tower's large observatory. A new facility with a 246-m steel tower and a broadcasting station has opened in Seto city in the Nagoya area. Broadcasters in the Osaka area have installed antennas on their own towers.

A new transmitting tower called Tokyo Sky Tree that will replace Tokyo Tower is being constructed in the Oshiage area in Tokyo. Its height will be 634 m, which will make it the highest self-standing tower in the world. Because it is twice the height of Tokyo Tower, it will reduce radio wave interference caused by super-high tower buildings in the Tokyo metropolitan area. TV broadcasting services from Tokyo Sky Tree will begin in 2013. An overview of these facilities is illustrated in Fig. 53.

FIGURE 53

Digital transmitting facilities in major cities

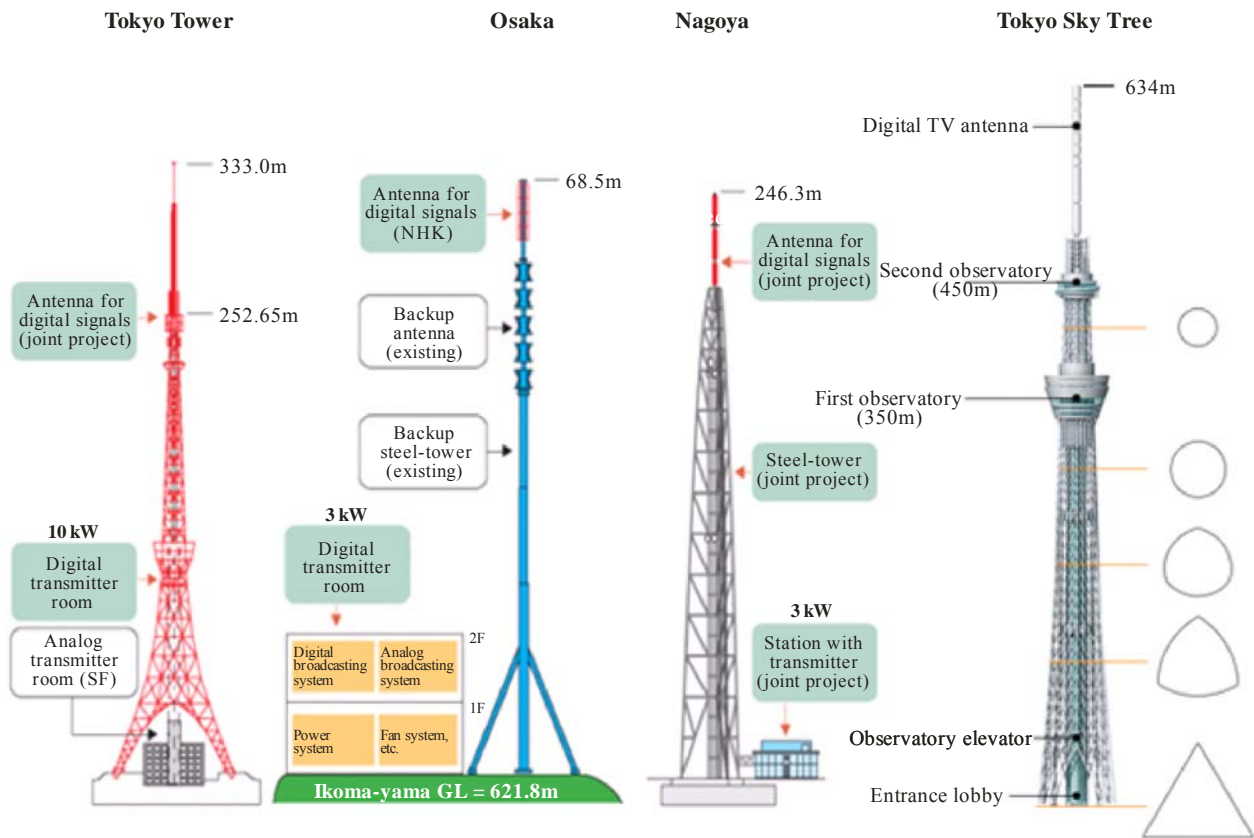

Report BT.2140-53

8.4 Technical characteristics of ISDB-T

The system compatibility between digital television and digital sound broadcasting was taken into consideration in ISDB-T. ISDB-T with full segments serves digital terrestrial television broadcasting and ISDB-T_{SB} using one segment, or three segments, serves digital terrestrial sound broadcasting.

ISDB-T is also capable of providing data broadcasting consisting of text, diagrams, still pictures, and video images to handheld devices, in addition to high-resolution pictures and stereo sound. In contrast with digital satellite broadcasting, it is able to feature detailed information on local interests. Furthermore, it has great potential to disseminate information to mobile multimedia terminals, such as car radios and pocket-sized receivers.

The following requirements were considered in developing ISDB-T.

It should:

- be capable of providing a variety of video, sound, and data services;
- be sufficiently robust to any multipath and fading interference encountered during portable or mobile reception;
- have separate receivers dedicated to television, sound, and data, as well as fully integrated receivers;
- be flexible enough to accommodate different service configurations and ensure flexible use of transmission capacity;
- be extendible enough to ensure that future needs can be met;

- accommodate SFN;
- use vacant frequencies effectively; and
- be compatible with existing analogue services and other digital services.

To comply with all the specified requirements, ISDB-T makes use of a series of unique tools such as (1) the orthogonal frequency division multiplex (OFDM) modulation system associated with band segmentation, which gives the system greater flexibility and the possibility of hierarchical transmission, (2) time interleaving, which contributes to achieving the necessary robustness for mobile and portable reception while giving the system powerful robustness against impulsive noise, and (3) transmission and multiplex configuration control (TMCC), which allows dynamic changes in transmission parameters to adjust the system for optimized performance depending on the type of broadcasting (e.g., HDTV and mobile reception).

These unique characteristics enable ISDB-T to provide a wide range of applications.

8.5 Outline of ISDB-T transmission scheme, related ARIB standards, and ITU-R Recommendations

TABLE 13
ISDB-T transmission scheme

Item	Content	ARIB standards	Recommendations ITU-R	
Video coding	MPEG-2 Video (ISO/IEC 13818-2)	STD-B32	BT.1870	
Audio coding	MPEG-2 AAC (ISO/IEC 13818-7)	STD-B32	BS.1196	
Data broadcasting	BML (XHTML), ECMA script	STD-B24	BT.1699	
Multiplex	MPEG-2 systems (ISO/IEC 13818-1)	STD-B10, STD-B32	BT.1300, BT.1209	
Conditional access	Multi 2	STD-B25	–	
Transmission	ISDB-T transmission	STD-B31	BT.1306 System C	
Channel bandwidth	6 MHz, 7 MHz, 8 MHz			
Modulation	Segmented OFDM (13 segment / ch)			
Mode, guard	Mode: 1, 2, 3 Guard interval ratio: 1/4, 1/8, 1/16, 1/32			
Carrier modulation	QPSK, 16-QAM, 64-QAM, DQPSK			
Error correction	Inner			Convolutional code (Coding rate: 1/2, 2/3, 3/4, 5/6, 7/8)
	Outer			(204,188) Reed-Solomon code
Interleave	Frequency and time interleave Time interleave: 0 – 0.5 s			
Information bit rate (depends on parameters)	6 MHz: 3.7-23.2 Mbit/s 7 MHz: 4.3-27.1 Mbit/s 8 MHz: 4.9-31.0 Mbit/s			
Receiver	ISDB-T receiver	STD-B21	–	
Operational guideline	ISDB-T broadcasting operation	TR-B14	–	

8.6 Emergency warnings through broadcasting

Early warnings of impending massive natural disasters such as earthquakes, tsunami, hurricanes, and volcanic activity are very effective in alerting those who may suffer from their consequences. Emergency warnings through broadcasting effectively inform persons of impending events and provide them with related information that can save their lives and help them protect their properties in the event of disaster. This chapter presents some emergency warning systems using broadcasting.

8.6.1 Automatic activation of handheld receivers by emergency warning system signals (see Recommendations ITU-R BT./BO.1774)

The emergency warning system (EWS) described in Recommendations ITU-R BT./BO.1774 enables public warnings to be made in emergencies due to disasters through analogue radio and/or analogue TV sound channels. Analogue broadcasting quite effectively issues public warnings using this method as it is one of the most widespread of all broadcasting services.

Digital terrestrial broadcasting has an emergency warning mechanism that is similar to that in analogue broadcasting. Broadcasting differs from other communications in that it can simultaneously send information to numerous handheld receivers. The capability to activate handheld receivers to receive emergency information should lead to reduced damage caused by disasters. Handheld receivers would have to be in constant stand-by mode for this to be effective for EWS signals, but if power consumption were too high, it would be difficult to maintain stand-by for prolonged periods.

A stand-by circuit for EWS signals that has low-power-consumption and can maintain stand-by for the EWS signals for digital terrestrial broadcasting has been studied to solve this problem.

Figure 54 shows the activation of a handheld receiver using EWS signals in digital terrestrial broadcasting.

An EWS signal is indicated by bit 26 in the TMCC signals comprising 204 bits in System C of Recommendation ITU-R BT.1306-3. In Mode 3 (No. of carriers: 5,617), there are 52 TMCC carriers in total for 13 segments, or four carriers per segment. The TMCC signals modulated by differential binary phase shift keying (DBPSK) are transmitted at intervals of approximately 0.2 s.

The EWS signals in one or more TMCC carriers are to be continuously monitored by all receivers to remotely activate the receivers. Furthermore, continuous monitoring is to be achieved without substantially shortening the stand-by time of handheld receivers. To reduce power consumption, a dedicated stand-by algorithm is introduced that:

- a) only extracts TMCC carriers; and
- b) only monitors the EWS signals by limiting time slots.

The function for EWS stand-by with very low power consumption has been tested and verified.

The technique of remote activation that uses EWS signals in TMCC can also be applied to fixed receivers in System C of Recommendation ITU-R BT.1306-3. Many existing TV receivers are able to receive EWS signals. Analogue TV receivers turn on automatically when the TV receiver detects EWS signals even if the switch is off, enabling the viewer to obtain urgent information. However, digital TV receivers can only receive these signals when the switches of TV receivers are turned on at present. Operation when EWS signals are received is essentially established by the product specifications of individual manufacturers.

FIGURE 54

**Activation of handheld receiver using EWS signals
for digital terrestrial broadcasting**

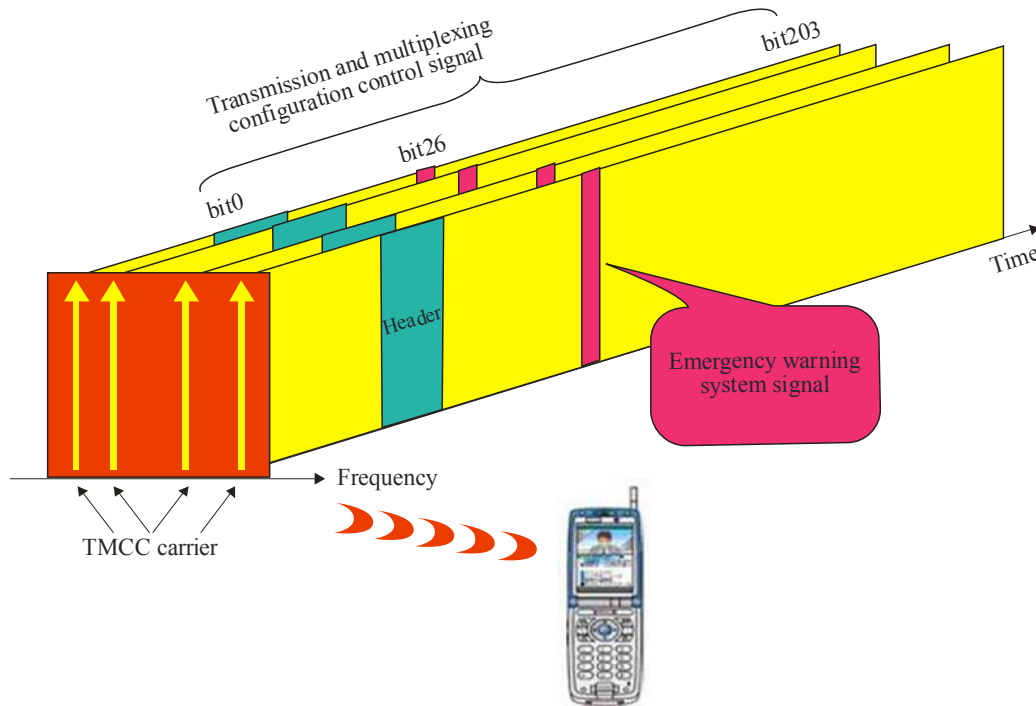

Report BT.2140-54

8.6.2 Earthquake and tsunami information services via data broadcasting

Earthquake and tsunami information has been offered via data broadcasts since January 2007, using three delivery media-broadcast satellite (BS) digital broadcasts, terrestrial digital broadcasts, and terrestrial digital broadcasts for mobile receivers (One-Seg). The features of these new “earthquake and tsunami information” services enabled people to obtain information about earthquakes that had just occurred or past earthquakes, and to rapidly learn of impending danger due to tsunamis following earthquakes.

The content of “earthquake and tsunami information” via data broadcasting is based on information obtained from the Japan Meteorological Agency (JMA). The production system for data broadcast content (called the “production system” after this) processes data received from outside the station and automatically produces content in BML format¹⁸. The content that is automatically generated by the production system is registered with the data broadcast transmission system and then broadcast. Earthquake and tsunami information is also automatically produced.

Data delivered to the broadcaster from the JMA for “earthquake and tsunami information” content are first received by the “earthquake tsunami database system”, which is commonly used by broadcasters for managing earthquake and tsunami information. Data are then transferred to the “earthquake tsunami gateway (GW)”, which is a dedicated system developed for “earthquake and tsunami information” content. The GW converts the data into a broadcast-ready format and sends it to the production system. Thus, content is automatically produced. The system configuration and flow for the “earthquake and tsunami information” service is given below.

¹⁸ BML is an XML-based data content format as described in Recommendation ITU-R BT.1699, originally developed by the ARIB.

FIGURE 55

System configuration and flow for earthquake and tsunami information

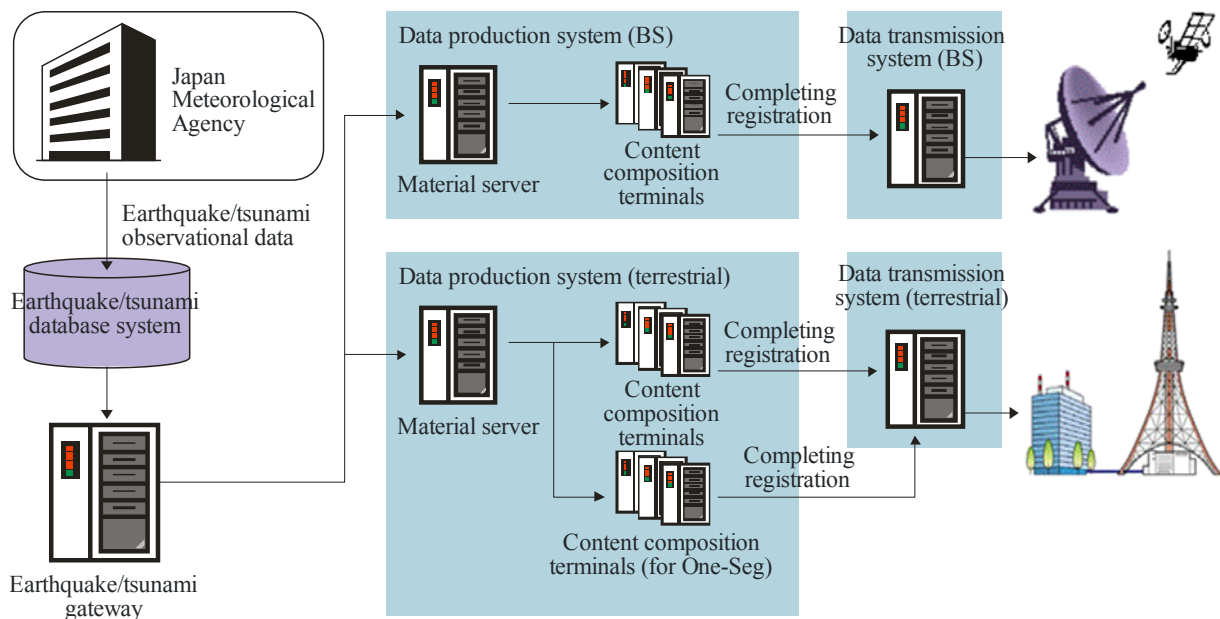

Report BT.2140-55

The “earthquake and tsunami information” service essentially consists of six kinds of screens. These are “Earthquake occurrence notification,” “Latest earthquake information,” “Most recent earthquakes,” “Tsunami Warnings/Advisories,” “Tsunami – Related earthquake information,” and “Tsunami monitoring information.” At the bottom of each screen are buttons for moving onto other screens, and viewers can use a remote controller to switch between any of these screens.

Within a month of when earthquake and tsunami information services commenced in January 2007, there were five earthquakes of intensity 3 or higher, and information on these earthquakes was delivered via data broadcasts. On each occasion, the automatic production function that enabled data to be broadcast immediately after they occurred worked effectively to enable earthquake information to be broadcast rapidly. Due to the large volume of information involved in reporting earthquake magnitudes for areas throughout Japan, viewers of regular TV services occasionally fail to see the information relevant to their areas of residence. In contrast, the data broadcasts were found to be extremely useful because they enabled people to use their remote controllers to see relevant information after the broadcasts had been made. The service was very helpful for this reason.

8.6.3 Broadcasting early warnings of earthquakes

The Japan Meteorological Agency has introduced an Earthquake Early Warning system, which can alert people to an impending earthquake when initial small-scale vibrations (primary waves) are detected and an estimated fix on its epicentre and magnitude (scale) is obtained. The system can predict such factors as the amount of time remaining until the earthquake’s main and potentially destructive vibrations (secondary waves) arrive, and its intensity (degree of jolting). The Agency will issue an Earthquake Early Warning in the event an earthquake is likely to have a minimum intensity of 5 on the Japanese scale of intensity which runs from 0 to 7, alerting people that they can expect severe jolting approximately within the next fifty seconds.

The Japan Broadcasting Corporation (NHK) has developed a system for relaying alerts issued by the Meteorological Agency. The system, which commenced operation on 1 October 2007, can relay alerts nationwide via all of NHK’s radio and television channels.

Any Earthquake Early Warning issued by the Meteorological Agency must be conveyed to the public promptly and in a readily intelligible format. The system adopted by NHK for relaying such alerts is characterized by three main features:

1 *Alerts are broadcast on all NHK radio and television channels*

Any alert is simultaneously broadcast on all twelve NHK radio and television channels.

2 *Alerts are fully automated*

Speed is essential, which means a fully automated system is in place for relaying an alert the moment it is received from the Meteorological Agency, without any decisions or intervention by NHK staff members.

3 *Special chime sounds in event of alert being issued*

A distinctive chime sounds and computer graphics (CG) appear on the television screen when an alert is being issued. The CG provide a map and list the names of prefectures that can expect jolting.

The alert is superimposed on all nationwide and local NHK TV broadcasts.

An alert issued from Tokyo will interrupt all nationwide and local broadcasts on NHK radio stations. The warning chime is followed by a synthesized voice announcing the prefectures that can expect seismic jolting.

8.7 Termination of analogue TV broadcasting in Japan

Analogue TV broadcasting was terminated in Japan on 24 July 2011¹⁹. The government and broadcasters worked hard to effect the migration to digital TV broadcasting.

8.7.1 Consultation office

In March 2003, the Ministry of Internal Affairs and Communications (MIC) opened a call centre to help audiences to migrate to digital broadcasting. In October 2008 MIC, in cooperation with broadcasters, manufacturers, and electricians, also opened 11 support centres, then opened the total of 51 centres finally with at least one in every prefecture, to solve problems in migrating to digital broadcasting. The support centres, which enable audiences to consult with staff for technical advice, have six major activities:

- 1) consultations and surveys;
- 2) visits to the elderly to give them advice;
- 3) consultations at town halls;
- 4) consultations, surveys, and grants for co-receivers of systems in apartments or fields;
- 5) consultations and grants for solutions to watching TV in areas with poor reception;
- 6) free loans of Set-Top Boxes (STBs) and UHF antennas.

¹⁹ Analogue TV broadcasting will continue until the end of March 2012 in Iwate, Miyagi, and Fukushima prefectures, which were severely damaged by the 2011 Tōhoku earthquake and tsunami.

FIGURE 56

Support centre activities

Report BT.2140-56

8.7.2 Support for reception

In the border area of analogue broadcasting coverage, where the received signal level is very weak, additional measures were taken, such as newly installing shared receiving facilities or replacing antennas with high-gain antennas.

In addition, MIC has prepared a safety net for receivers. For those with insufficient means, MIC will distribute free STBs and offer broadcasting satellites to cover areas with poor reception as a temporary measure to broadcast terrestrial TV programs. The broadcasting satellite services use a conditional access system to restrict viewers to only that area, and seven programs in the Tokyo metropolitan area are being served.

By standardizing the minimum functional requirements for STBs along with the technology development efforts of manufacturers, digital television and STB prices have steadily become cheaper, contributing to the spread of digital receivers. In addition, the government implemented an incentive program for consumers to purchase and switch to digital televisions, accelerating digital receiver diffusion.

8.7.3 Publicity



Many campaigns and commercials were developed by using animal mascots or famous entertainers as promotion symbols and popular newsreaders as “promotion ambassadors”. In addition, people of various generations were made familiar with the concept of “digitalization of terrestrial TV broadcasting” through the efforts of distinguished entertainers belonging to their own generation, who were named as “cheerleaders” and participated in a lot of promotional campaigns. Public viewing systems with huge screens were also used to show promotional clips that would appeal to fans at professional baseball and football stadiums and horse racing tracks. These activities helped to create a nationwide understanding of and familiarity with the concept of “digitalization of terrestrial TV broadcasting”.

8.7.4 Notification through analogue TV broadcasting

One of the most effective methods of generating publicity for the analogue-to-digital transition was having broadcasters make changes to analogue TV images in the stages shown in Table 14. These changes made it easy for viewers to distinguish between analogue and digital TV services, and telephone numbers on the screen made it easy for them to contact the call centre.

TABLE 14

Publicity via analogue broadcasting

Stage	Sample picture	Description
1 st stage July 2008		Characters meaning “analogue” were superimposed on the top right of the picture.
2 nd stage July 2010		As an addition to the 1 st stage, blanks serving as “letterboxes” were added to the top and bottom of the picture.
3 rd stage October 2010		As an addition to the 2 nd stage, short messages to promote the digital transition were superimposed in the letterbox on the bottom of the picture.
4 th stage 1 July 2011		As an addition to the 3 rd stage, a message showing the countdown to the termination of analogue TV was superimposed on the picture.
5 th stage Noon, 24 July 2011		All broadcasters broadcast their final message announcing that analogue broadcasting would terminate when analogue transmitting was terminated.
6 th stage After 24 July 2011		Analogue transmitting was terminated.

9 Kenya

9.1 Kenya's preparations for digital terrestrial broadcasting

9.1.1 National preparations towards the RRC

Following the Decision by the ITU Council to hold two sessions of a Regional Radiocommunication Conference (RRC) for planning of digital terrestrial broadcasting in the frequency bands 174-230 MHz and 470-862 MHz in ITU Regions 1 and 3, Kenya took an active part and fully participated in the following forums:

- the work of ITU-R Task Group 6/8 which was tasked by Radiocommunication SG 6 to prepare a Report on the technical bases for the Regional Radiocommunication Conference in 2004 for the planning of digital terrestrial broadcasting services (radio and television) in parts of Regions 1 and 3 in frequency bands 174-230 and 470-862 MHz;
- the first session of the Regional Radiocommunication Conference, held in 2004 (RRC-04), that established the technical basis for the work of the second session of the RRC held in 2006 (RRC-06), including the necessary bases to facilitate planning exercises prior to the second session of the RRC and the form in which the requirements of administrations should be submitted;
- the meetings of the Intersessional Planning Group (IPG), that was responsible for monitoring the intersessional activities with respect to the development of the draft digital plan and supervision of the activities of the planning exercise team (composed of BR assisted by experts nominated by the respective regional groups);
- the meetings of the ITU-R Regulatory & Procedural Group (RPG) specifically established by RRC-04 to study regulatory/procedural matters relating to the relevant parts of the RRC-06 agenda, and the agendas of the short conferences, associated with RRC-06, to revise the Regional Agreements Stockholm, 1961 and Geneva, 1989. The RPG was also responsible for transition issues;
- the second session of the Regional Radiocommunication Conference (RRC-06) that established new agreements and associated frequency plans for terrestrial digital broadcasting in the frequency bands 174 to 230 MHz and 470 to 862 MHz.

9.1.2 National Preparatory Committee

Kenya constituted a National Preparatory Committee (NPC) under the chairmanship of the Communications Commission of Kenya (CCK) to study the ITU Reports and prepare appropriate proposals and digital requirements for the first and second sessions of the RRC respectively. NPC were drawn from the following stakeholders in the broadcasting industry:

- Communications Commission of Kenya (CCK).
- National Communications Secretariat.
- Kenya Broadcasting Corporation.
- Media Owners Association.
- Ministry of Tourism and Information (now Information & Communications).

The NPC was responsible for developing national proposals and requirements for the RRC.

9.1.3 Regional preparations

Kenya took an active role in the Africa information meetings /workshops related to the planning of digital broadcasting. Kenya also held several meetings with its East Africa neighbours in an effort to forge common positions and also coordinate digital requirements.

9.1.4 Kenya's technical bases for digital planning

The table below summarizes Kenya's planning bases for digital terrestrial broadcasting during the RRC-06 Conference.

Description	RRC-06 Plan value
Frequency bands	174-230 MHz, 470-806 MHz
Channels	Channels 5-12, channels 21-62
Planned Band III services	Both DVB-T and T-DAB
Planned Band IV/V services	DVB-T
Reception mode	Fixed
Bandwidth	7 MHz in band III, 8 MHz in band IV/V
Network structure	Multi Frequency Network (MFN)
Reference planning configuration (T-DAB)	RPC5
Reference planning configuration (DVB-T)	RPC1
Planning mode	Assignment planning
Spectrum mask (DVB-T)	Mask 1 (DVB-T Tx operating in non-critical cases)
Spectrum mask (T-DAB)	Mask 1 (T-DAB Tx operating in non-critical cases)

In the planning process, a number of existing analogue TV frequencies in the GE89 Plan were converted to digital while almost all existing sites for analogue TV were retained for the digital plan.

9.1.5 Kenya's assignments in the Geneva 2006 Plan (GE06)

The GE06 digital broadcasting plan consists of two parts, namely, the 174-230 MHz band and the 470-862 MHz band (comprising T-DAB assignments, T-DAB allotments, DVB-T Plan assignments and DVB-T allotments). At the end of the RRC-06, Kenya obtained a total of 948 frequencies representing a level of over 95% satisfaction of the input requirements at the RRC-06.

9.2 Post RRC-06 activities regarding digital broadcasting

- a) Following the conclusion of the Regional Radiocommunication Conference of 2006 that established the Geneva 2006 (GE-06) digital Plan, the Commission prepared a Report of the outcome of the RRC-06 to the Minister of Information & Communications and recommendations on the next course of action.
- b) The Commission issued a public notice on the outcome of the RRC-06 with regard to transition from analogue to digital broadcasting and the envisaged discontinuation of assignments of broadcasting frequencies for analogue TV broadcasting on 4 October 2006. The Commission thereafter discontinued the assignment of frequencies for analogue TV broadcasting in order to prepare the country for digital broadcasting.
- c) In order to update broadcasters with the developments in digital broadcasting arena as well as the conclusions of the ITU RRC-06 Conference, a consultative broadcaster's breakfast meeting was jointly organized by CCK and the Ministry in December 2006. The Commission delivered presentations regarding results of the RRC-06, terrestrial digital audio broadcasting (T-DAB) technology, digital video broadcasting-handheld (DVB-H) technology and digital radio mondiale (DRM) technology. In addition, the Commission made similar presentations to the management of a number of local media houses following their requests.

- d) The Commission initiated Kenya's approval process for the Protocol revising certain parts of the Regional Agreement relating to the planning of VHF/UHF television broadcasting in the African Broadcasting Area and neighbouring countries (Geneva, 1989) (Geneva, 2006) and the Final Acts of the Regional Agreement for the Planning of the digital broadcasting service in Parts of Region 1 and in the Islamic Republic of Iran, in the frequency bands 174-230 MHz and 470-862 MHz, Geneva 2006. This was as a result of a request from the ITU.

9.3 Establishment of the digital migration taskforce

9.3.1 Role of the taskforce

In order to prepare Kenya for a smooth transition from analogue to digital broadcasting by the deadline set for 2015, the Government established a taskforce on the migration from analogue to digital broadcasting. The taskforce was launched by the Minister for Information and Communications, on 14 March 2007. It comprised of broadcasting experts and representatives drawn from the following stakeholders:

- Ministry of Information & Communications.
- National Communications Secretariat.
- Communications Commission of Kenya (CCK).
- Media Owners Association.
- Kenya Broadcasting Corporation (KBC).
- Media Council of Kenya.
- Association of Practitioners in Advertising (APA).

The Minister mandated the taskforce to give recommendations that will contribute to the development of a national strategy for the switchover and more specifically to:

- give recommendations to the government on the required policy and regulatory framework to address the introduction of digital broadcasting;
- develop a Kenyan approach for transition to digital broadcasting;
- establish a transition timeframe and a firm programme for analogue switch-off;
- give proposals on how Kenyans can adopt digital broadcasting.

The CCK took a leading role in facilitating and co-coordinating the activities of the taskforce. The Commission successfully organized and conducted a stakeholder's forum where stakeholders were sensitized and their views received. The consultation process provided vital inputs into task force report in which views of the stakeholders were incorporated and presented to the Ministry of Information and Communications.

9.3.2 Recommendations of the taskforce

The taskforce completed its work in September 2007 and prepared a Report to the Minister in October 2007, giving recommendations on various aspects. These included:

9.3.2.1 Digital broadcasting standards

- The DVB-T standard be adopted for digital television broadcasting in accordance with the decisions taken at RRC-06.
- The introduction of DVB-T standard for television broadcasting service and T-DAB standard for sound broadcasting in Kenya to be facilitated through licensed signal distributor(s).

- High-definition TV may be considered for deployment after the transition period.
- T-DAB standard be adopted as the standard for digital sound broadcasting in frequency band 174-230 MHz in accordance with the decisions taken at RRC-06.
- The platform for the introduction of DVB-H service in Kenya be determined in future depending on market developments.

9.3.2.2 Broadcast signal distribution

- The national public broadcaster, Kenya Broadcasting Corporation shall be required to form a separate company to run the signal distribution services in order to avoid conflict of interests or cross subsidization.
- Interested investors including current broadcasters may be licensed to offer broadcast signal distribution services.
- A broadcast signal distributor will be required to provide signal distribution services as a common carrier to broadcasting licensees upon their request on an equitable, reasonable, non-preferential and non-discriminatory basis.

9.3.2.3 Content issues in digital broadcasting

- The mandate of the Kenya Film Commission should be expanded to include promotion and development of local content for the broadcasting industry.
- The Government should streamline the development and supervision of curriculum used in the media training institutions.

9.3.2.4 Policy and regulatory considerations in the transition to digital broadcasting

- Subject to the timeframe set out in the taskforce Report, existing analogue terrestrial broadcasting service should migrate to digital transmission network based on their own commercial strategy and economic considerations.
- The Government in consultation with CCK should establish a multi-stakeholder Working Group to be known as Digital Migration Board whose role would include among others:
 - i) manage the migration process within a specified timetable;
 - ii) develop an appropriate switchover strategy;
 - iii) identify likely bottlenecks to the uptake of digital broadcast;
 - iv) make recommendations relating to fiscal measures;
 - v) develop and implement appropriate consumer awareness strategy;
 - vi) monitor and evaluate the awareness, take-up and use of the new services, and adjust the campaign accordingly.
- Digital Migration Board in consultation with the CCK to manage the migration process within a specified timetable and develop an appropriate switchover strategy once the government approves the taskforce recommendations.
- At least one broadcast signal distributor be licensed as soon as possible.
- The simulcast period to run up to 30 June 2012 and the proposed analogue switch-off date was set for 1st July 2012.
- The Government was urged to set aside adequate financial resources funds to cater for the digital migration process.
- Kenya should adopt a phased switch-off of analogue services in accordance with a proposed timeframe.

- The Government should ensure availability of set-top boxes (STB) through fiscal measures among others.
- The national standards agency, Kenya Bureau of Standards and the CCK should define the minimum standards for set-top boxes to be used in Kenya.
- Frequencies for digital broadcasting shall be assigned to signal distributor(s) as opposed to the broadcasters.
- One digital programme channel will be made available for the transition of each of the existing analogue television channel.
- The regulator (CCK) will ensure that the license condition obligates licensed signal distributors to provide services to broadcasters promptly upon request.
- CCK to explore providing appropriate regulations and necessary incentives towards implementation of digital broadcasting.
- Upon switch-off of the analogue television broadcasting transmitters, the broadcast frequencies earlier assigned to broadcasters for analogue TV broadcasting shall revert back to CCK.

9.3.2.5 Consumer issues

- Government should institute measures to ensure availability of set-top boxes and digital transmissions countrywide at the time of the switchover date. This will protect the end-user against instant crash of service that leaves them with no option at the end of the migration process.
- The consumers should be given adequate and timely information on the migration implementation timeframe to enable them prepare for the change.
- The Digital Migration Board will have the responsibility of responding to public concerns even beyond the switchover as all concerns may not be anticipated in time.
- Consumer education should involve broadcasters, retailers and other players in the broadcasting industry in order to yield the expected benefits.
- Government and broadcasters should contribute to consumer education by airing the campaigns regularly.
- Set-top boxes for digital broadcasting should be zero-rated to reduce their cost.
- The implementation strategy must specifically target the vulnerable groups which include people with disabilities, people in marginalized areas and the poor, to ensure they are included in the digital migration process.
- The consumer campaign should contain information on the need to purchase set-top boxes and that consumers will not have to discard their analogue equipment in order to receive digital transmissions.
- The government should put in place policies that discourage dumping of obsolete technologies and equipment.
- A switchover logo or other mechanisms will be developed by the Digital Migration Board. This will give consumers the assurance and confidence while purchasing receivers, antennae, and other equipment necessary to receive over-the-air signals after the switch over.
- Retailers should be required to sell only type approved/accepted set-top boxes or integrated digital television receivers.

9.4 Digital Television Committee

Following the recommendations of the taskforce, the Minister of Information & Communications appointed a 12 person Digital Television Committee (DTC) in December 2007 to spearhead the implementation/adoption of digital broadcasting in Kenya. The DTC was mandated to develop recommendations for effective implementation of digital broadcasting in Kenya so as to ensure that the country experiences a smooth transition from analogue to digital broadcasting. The DTC was specifically mandated to:

- manage the migration process within a specified timetable;
- develop an appropriate digital switchover strategy;
- recommend measures to be taken to ensure availability of digital set-top boxes and digital transmissions countrywide at the switchover date;
- identify likely bottlenecks to the uptake of digital broadcasting services;
- make recommendations relating to fiscal measures that need to be taken to encourage uptake of digital television services;
- develop and implement appropriate consumer awareness strategy;
- monitor and evaluate the awareness, take up and use of new services, and adjust the campaign strategy accordingly.

The CCK serves as Secretariat to the DTC.

The DTC membership, which was expanded to 20 members in 2009, is drawn from the following organizations:

- Ministry of Information and Communications.
- National Communications Secretariat.
- Communications Commission of Kenya.
- Kenya Broadcasting Corporation.
- Media Owners Association.

The DTC recommended that Kenya adopts MPEG-4 video compression standard on the DVB-T platform for migration to digital broadcasting. The Committee further recommended the following:

- launch of the pilot phase starting in Nairobi for DVB-T signal;
- development of the STB standards;
- waiver of taxes on the STBs;
- the roll out of the DVB-T signal be done in phases;
- marketing of STBs in Kenya;
- enhancement of the awareness campaign.

The DTC is an active committee that frequently holds meetings and that continues to oversee the migration process in Kenya.

9.5 Initial roll out of DTT in Kenya

9.5.1 Trial DVB-T digital network

The first DVB-T broadcasting network was authorized in Kenya on 10 April 2006 on trial basis for an initial period of 6 months. The licensee, MS Lancia Media Ltd, was assigned channel 57 in Nairobi with the transmitter at Limuru site (100 W transmitter, e.r.p. 1 kW) with 10.2 dBi antenna. The transmitter power was later on increased to 250 W (with corresponding e.r.p. of 2.5 kW)

in July 2006. The digital transmitter deployed is Screen Service Italia SCA 501UB. The digital platform used was DVB-T, MPEG-2.

The company initially operated its digital broadcasting services under the name Oxygen Television Network Ltd but later on changed to Freeview TV in 2009. The service was initially accessible through subscription with the set-top boxes (decoders) being readily available in the local market. The programmes were downloaded by satellite and transmitted to the DVB-T broadcast transmitter situated on the outskirts of Nairobi using a microwave link.

In 2009, the subscription service became available on free to air basis in Nairobi. The service was however discontinued in 2011 following Kenya's adoption of DVB-T2 standard. The initial network configuration and technical details are indicated in the table below:

Description	Value
Transmitter site	Limuru, Nairobi
Network configuration	Fixed DVB-T
TV channel	57 (762 MHz)
Carrier power	250 W
e.r.p.	2.5 kW
Antenna height	60 m
Modulation	64 QAM and QPSK COFDM
FEC code rate	7/8
Guard interval	1/32
Carriers/FFT	8k
Data rate	38 Mbit/s
Bandwidth	8 MHz
STL frequency	7 226 MHz

9.5.2 DVB-H digital broadcasting network (mobile TV)

In pursuit of the country's appetite to try out emerging technologies, the Commission licensed MS Digital Mobile Television (Kenya) Ltd to provide mobile TV (DVB-H) service in Nairobi on television channel 21.

The DVB-H broadcasting service, whose brand name is "DSTV Mobile and/or GOTV Mobile" was launched on 23 October 2007 in Nairobi with the first transmitter at Kasarani (carrier power 1 KW) and antenna gain of 10 dBi.

Additional sites operating on SFN mode have since been set up in Nairobi to improve mobile TV coverage especially for indoor reception. These sites include Rahimutula towers and Mombasa Road-steel makers.

Additional frequencies have been assigned to the licensee to expand the service to other parts of the countries. These are Mombasa (channel 30), Kisumu (channel 24), Nakuru (channel 24) and Eldoret (channel 24). The DVB-H signal is on air in all these four sites.

As at September 2012, the DVB-H service had a subscription bouquet of 16 channels as follows:

- KBC channel 1.
- SuperSport Blitz.
- SuperSport 9.

- Events.
- Super Sport 3 A.
- CNN.
- Africa Magic (Family).
- Africa Magic Entertainment.
- Africa Magic Swahili.
- Channel O.
- Disney Junior.
- Sony Max.
- Citizen TV.
- Nation TV (NTV).
- Select Sports.
- National Geographic Wild.

The programmes are downloaded from satellite (DSTV) and fed into the transmitters with the signal being synchronized using GPS. Three of the channels carried in the bouquet are local free to air TV channels.

The DVB-H network configuration and technical details for Nairobi are indicated in the table below:

Description	Authorized Value
Transmitter sites and TV channel	Nairobi(21), Mombasa (30), Kisumu (24), Nakuru (24) and Eldoret (24).
Network configuration	DVB-H
Carrier power	1 kW
ERP	10 kW
Antenna height	75 m (Kasarani)
Modulation	QPSK
FEC code rate	1/2
Guard interval	1/4
Carriers/FFT	8k
Data rate	–
Bandwidth	8 MHz

In Nairobi, the DVB-H network is configured for mini-SFN whereby there are 3 transmitters in Kasarani, Rahimutulla and Mombasa Road-Steel Makers operating on the same TV channel to improve DVB-H coverage. All the sites have 11 dBi antennas.

The DVB-H service is a subscription service which requires monthly fees. The DVB-H service provider is collaborating with some locally licensed mobile phone service operators with respect to distribution of handsets and subscription management.

9.6 Migration from analogue to digital terrestrial broadcasting

9.6.1 Introduction

The government is responsible for initially funding the migration from analogue to digital broadcasting in Kenya. During the simulcast period that was envisaged to take place between 2009 to 30 June 2012, the national broadcaster KBC was authorized to set up a subsidiary company “SIGNET Co. Ltd” to carry out broadcast signal distribution services. Priority will be given to existing broadcasters to provide their broadcast signal to the signal distributor so that the same can be relayed on the digital platform.

The deadline for analogue switchover was initially set for 1st July 2012 but later revised to 31st December 2012 with the understanding that phased analogue switch-off would be employed. It is expected that at the switch-off date, up to 90-95% of the consumers currently receiving analogue signal shall be capable of receiving the digital signal. This deadline could be further reviewed if the digital migration progress made by then fails to meet the targeted audience.

9.6.2 Restructuring of the DTC

The DTC is responsible for overseeing the digital migration process during the simulcast period and the period beyond. In order to fast track the preparations for the launch of the pilot digital signal and facilitate greater efficiency in its mandate going forward, the DTC was restructured into three taskforces to focus in specific areas namely:

- technical taskforce to handle at all technical aspects related to the digital migration process;
- policy and regulatory taskforce to advise on digital migration matters of policy and regulatory nature;
- consumer awareness taskforce for the development of consumer awareness and publicity programme for the digital migration process.

The recommendations of the taskforces are presented to the DTC which deliberates on them before making decisions or giving further directions.

The Commission facilitates the meetings of the DTC and its associated taskforces by providing logistical and technical support services in addition to hosting the Digital Kenya secretariat and meeting the budgetary needs. The secretariat is responsible for responding to all enquiries received from members of public, broadcasters and international organizations regarding digital migration in Kenya.

9.6.3 Digital infrastructure roll out plan in Kenya

The roll out of digital broadcasting infrastructure in Kenya will be the responsibility of the signal distributor and shall be carried out in phases. The national public broadcaster, Kenya Broadcasting Corporation, is establishing a subsidiary company known as SIGNET, to carry out the business of broadcast signal distribution and multiplexing during the simulcast period. SIGNET will initially be funded fully by the government. The government is also in the initial stages of considering a public private partnership arrangement between SIGNET and the private sector investor(s) in order to mobilize the much needed capital necessary for the massive digital infrastructure roll out. In this regard, the Ministry of Information and Communication has already invited potential investors interested in partnering with SIGNET, through a public expression of interest (EOI) notice, to submit their proposals. If the PPP process succeeds, it will be a big relief to government in terms of funding the rollout of the digital infrastructure.

At switchover, the DTT services broadcast on at least two 2 multiplexes are planned to substantially replicate the current analogue TV reception coverage (estimated to be 60% of population), so that 60% of population should then be able to receive all the free-to-air digital broadcast services over

DTT platform using their rooftop aerial and a set-top box. At the same time other services, like audio channels and Pay TV are expected to be brought on board.

9.6.3.1 Pilot phase roll out

The pilot phase involved the implementation of the Nairobi digital terrestrial broadcasting project. The Government released Kshs. 152 million to enable the national broadcaster KBC to tender for construction of the digital broadcasting infrastructure.

During this pilot phase, the installation and commissioning of the following was undertaken:

- the DVB-T Multiplex headend at Broadcasting House in Nairobi;
- DVB-T transmitters and accessories at Limuru;
- microwave STM-1 (1+0) radio to link the Multiplex centre to the Limuru Hill transmitting site.

In the last three months preceding the launch of the digital signal in Nairobi, the Commission facilitated two stakeholder forums between the DTC, the existing TV broadcasters and the print/electronic media houses so as to provide updates on the status of preparations for migration to digital broadcasting.

Such forums continue to be undertaken as they bring the broadcast industry players together to exchange ideas on the future of broadcasting in Kenya reflecting on the impending digital era and related issues.

There was also a built-up of publicity activities regarding digital broadcasting in the electronic (radio & TV) as well as the print media in order to enhance consumer awareness of the impending digital era in broadcasting. These activities were facilitated by the CCK.

On 9 December 2009, Kenya's migration to the digital television broadcasting became a reality, following the inauguration of the DVB-T signal in Nairobi by H.E., Hon. Mwai Kibaki, the President of the Republic of Kenya. This launch marked the beginning of the transition from analogue to digital TV broadcasting in Kenya.

A total of 16 channels were accommodated on the digital platform that was activated using TV channel 26 in the pilot phase.

NOTE 1 – The channel positions and composition change frequently due to the pilot nature of the project.

The technical details of the DVB-T transmission network established by KBC during the pilot phase are as follows:

Description	Implemented value (pilot Phase)
Transmitter site	Limuru, Nairobi
TV channel number	26
Frequency limits	514 MHz
Transmitter make and model No.	Thomson Elite 1 000
Transmitter carrier power	2.5 kW
Geographical coordinates of antenna	-010811, 0363835
Antenna type	IMP
Antenna gain (dBi)	12.9 dB
Antenna height above ground level	120 m
No of antenna bays	6
Radiated (transmitted) power	e.r.p. T. max (kW) 70.48 E. max (kW) 32.6
Transmission system	DVB-T
Transmission modulation	COFDM QAM
Channel bandwidth	8 MHz
Multiplexer make and model	Thomson NetProcessor 9030 – v3.2
Type of multiplexing	Flexstream statistical multiplexing
Transmission mode (No. of carriers – 2k or 8k)	8K
Carrier modulation	64-QAM
Code rate	3:4
Bit rate	Variable
Guard interval	1:16
Network identity	Signet
Stream identity	1
Capacity used for TV broadcasting	20 Mbit/s
Capacity used for supplementary services	0.8 Mbit/s
Max No. of TV channels to be accommodated	16
Max No. of radio channels to be accommodated	12
Type of links between Mux center and TX center	Microwave/fibre optic
Type of link(s) between broadcasters and Mux	Satellite and fibre optic
Video resolution	720 × 576 (PAL); 720 × 480 (NTSC)
Type of conditional access system (if any)	Conax CAS-7.4 with chipset pairing

9.6.3.2 Phase 1 roll out

9.6.3.2.1 Scope of Phase 1 roll out

The phase 1 DTT roll out was to commence before end of 2010 covering the following:

- upgrading of the headend at the national operating centers (NOC) to a dual (2) multiplex;
- setting up two headend centers in Mombasa and Kisumu city, each with a single multiplex headend unit;
- putting up and upgrading transmission sites at 12 sites namely:

- i) Maragoli hills in Kisumu, Kisii Hill, Webuye Hill and Kapenguria Hill for providing coverage to Nyanza, Western and parts of Northern Rift;
 - ii) Mazeras and Vuria Hills to provide coverage for the Coast Region and parts of Eastern province;
 - iii) Nakuru, Loldiani, Eldoret for parts of Central and North Rift districts coverage;
 - iv) Nyeri and Nyambene to provide coverage for Mt. Kenya Region;
 - v) Limuru transmitter upgrade to a dual multiplex for coverage in Nairobi and its environs;
- linking of programme signal from the NOC to transmission sites via satellite, fiber optic and microwave links;
 - Malindi has an existing digital ready analogue TV transmitter and may be easily activated at the end of the phase 1 roll out.

Subject to availability of sufficient funding, Phase 1 roll anticipated covering 12 major towns of the country covering about 80% -90% of areas currently enjoying analogue TV services.

The DTC also made a decision that other than the Nairobi pilot phase, all deployments of digital infrastructure going forward in phase 1 would be DVB-T2, MPEG-4 transmission standard and video compression format respectively.

9.6.3.2.2 Infrastructure requirements

The basic infrastructure requirements for each site vary from site to site depending on whether it exists or completely new. The basic requirements include land, access road, transmitter building, tower, commercial power supply, diesel generator power backup, DVB-T transmitters, and programme distribution and receive system. Each site's requirement has been assessed and documented for purposes of developing appropriate budget to facilitate roll out.

9.6.3.2.3 Nationwide frequency identification for migration

It was recognized that each of the sites identified required UHF frequencies to cater for the broadcast content providers. In order to ensure efficient use of spectrum, the CCK took stock of unused UHF TV frequencies earlier assigned to KBC at the different sites in order to determine where there was need to assign new frequencies.

The Commission thereafter identified and reserved UHF broadcast frequencies that shall be used by the Signal distributor to provide multiplex services during the simulcast period.

In addition to the developments at the WRC-12 Conference, the Commission began the process of changing frequencies assigned to the signal distributors that were above channel 48.

9.6.3.2.4 Cost effective deployment of infrastructure

In order to ensure costs associated to deployment of digital infrastructure is minimized, a number of strategies are being explored. These include:

- a) entering into lease agreements with Kenya Forest Service for lease of land on sites that fall within forest areas as opposed to purchasing of land;
- b) deployment of guyed masts as far as possible in favour of self-supporting masts;
- c) negotiate with other existing broadcasters on acquisition of their existing infrastructure (masts, sites, air conditioning, power, etc.) to minimize duplication;
- d) the use of prefabricated containerized shelters in favour of constructing buildings;
- e) modification of certain existing digital ready analogue TV transmitters for digital broadcasting;

- f) negotiation with the ICT Board with respect to the possible use of the National Optical Fibre Backbone for transportation of content to transmitter sites.

9.6.3.3 Phase 2 digital roll out

Phase 2 of the roll out was to involve the implementation of the digital broadcasting infrastructure in the following broadcasting sites:

- Nyahururu.
- Kitui.
- Mbuinzau.
- Garissa.
- Lamu.
- Vuria.
- Kabarnet.
- Migori.
- Marsabit.
- Marala.
- Lodwar.
- Lokichogio.

The timeframe for the implementation of Phase 2 earlier envisaged for the period July 2011-June 2012 but is no longer tenable.

9.6.3.4 Phase 3 digital roll out

Phase 3 is not envisaged to be part of the digital migration plan but will be used to ensure all the remaining parts of the country are covered with digital signal. It is noted that this phase will mainly target those areas that did not in the first place receive even the analogue television signal.

The areas initially identified for Phase 3 implementation of the digital infrastructure include the following:

- Eburu.
- Siaya.
- Madogashe.
- Hola.
- Garsen.
- Mandera.
- Embu.
- Moyale.
- Kajiado.
- Kakuma.
- Laisamis.
- Lokitaung.

The timeframe for the implementation of Phase 3 was earlier envisaged for July 2012-June 2013 but this is no longer tenable.

In view of the delays in rollout, the timings of the various phases is being reviewed.

9.7 Programmes transport system

A digital primary distribution network will be needed to distribute MPEG-4 transport streams from signal distributor's headends to re-multiplexing sites (regional programme insertion points) and to associated transmitters. The proposed platforms for transport stream include PDH or SDH networks, ATM, optical fibre or satellite distribution. It is envisaged that a mix of the above transport streams.

The linkage between the signal distributor's headend and the DVB-T transmission site in Limuru has been deployed using PDH/SDH microwave radio link with an optical fibre backbone as a backup.

Whereas Phases 1 and 2 transport system is expected to be fibre, Phase 3 sites shall be linked to the headend using satellite connectivity due to most of these sites being located in very remote areas where there is hardly any infrastructure.

Optical fibre is also the preferred medium for linking broadcasters studios to the signal distributor's headend facility.

9.8 Set-top boxes

9.8.1 Standardization

The cost effective migration strategy for Kenya is through the use of digital set-top boxes (STBs) so as to enable consumers already having analogue TV receiving sets to receive the digital signal without the need to purchase a new digital TV receiver. In this regard, the DTC adopted minimum specifications for set-top boxes that must comply with DVB-T2 transmission and MPEG-4 video compression standards. These minimum specifications have been put in the public domain and the Commission's website www.cck.go.ke and shall also be available on Digital Kenyan website once launched.

These minimum specifications were further revised in August 2012 making requirement of conditional access feature an optional requirement for set top boxes intended for FTA reception. This development will go a long way in ensuring availability of low priced compliant set top boxes on the local market.

The CCK is currently liaising with the national standards agency, the Kenya Bureau of Standards (KeBs) which is responsible for developing and gazetting national standards, with the view of gazetting DVB-T2 and MPEG 4 as a national standard for digital terrestrial receivers including

STBs and integrated digital TVs. CCK is a member of KeBs technical committee that is charged with the responsibility of developing the national digital standard.

However, due to recent decision by the DTC regarding rolling out DVB-T2 system following the successful pilot phase, it is expected that the specifications shall be upgraded to comply with DVB-T2 system specifications.

9.8.2 Tax exemptions for STBs

In order to make the cost of set-top boxes as affordable as possible to the masses so as not to become a barrier to consumers receiving digital signal, discussions to consider strategies for providing tax relief on STBs were held between the DTC, the Ministry of Finance and the Ministry of Information and Communications.

In June 2012, the Government announced the waiver of import duty (accounting for about 25%) on digital set-top boxes, thus making them more affordable. This action was in line with the decision by the five East African Community (EAC) member states to zero rate import duty on digital broadcast terrestrial receivers.

9.8.3 Marketing of STBs

In October 2009, the Commission issued a public notice in the local print media and on its website informing prospective vendors the opportunity to supply STBs. This was in line with the recommendations of DTC.

This meant that any retailer/vendor was free to import and supply STBs or idTVs to consumers without the need for a vendor's license from CCK as long as the digital receiver complied with the minimum specified requirements. This was intended to make set-top boxes readily available in the market and at very competitive prices. However, the supply of STBs is now subject to suppliers being required to be licensed and the set-top boxes/idTVs need to be type approved/accepted in order to ensure protection of consumers and maintenance of quality.

Vendors will be expected to import STBs that fully meet the DVB-T2 system specifications.

9.9 Making migration visible to consumers

9.9.1 Digital migration logo/identity

The DTC unveiled Digital Kenya Logo (shown below) to be identified with all activities related to digital migration in Kenya. The Digital Kenya secretariat is now based at the CCK, who are providing the required logistical and technical support for the migration process. Staff have also been seconded from some DTC member organizations to handle matters related to the secretariat.



9.9.2 Consumer awareness campaign and publicity

The consumer awareness taskforce within the DTC is responsible for spearheading the development of consumer awareness and publicity programme for the digital migration process. The taskforce also reviews the communicant plan from time to time.

Digital Kenya Logo is currently used on all publicity material used to educate and inform the public regarding digital broadcasting.

The DTC developed a communication plan for the consumer education on digital migration with a strategic focus that revolved around the following issues:

- creation of an identity for digital television in Kenya;
- consumer awareness;
- appropriate technologies and technology obsolescence issues;
- consumer protection;
- role of stakeholders and partners in transition;
- people with disabilities and other vulnerable categories of consumers;
- sustainability of the brand identity for digital Kenya.

To enhance consumer education and accessibility to information, a dedicated digital Kenya website www.digitalkenya.co.ke has been designed and is being finalized before being officially launched for public access. The website shall be a home for all information on digital migration in Kenya. Currently, the CCK website provides a portal for digital migration related information.

In addition, setting up of a full-fledged call center for digital migration is envisaged. The call center shall be staffed with qualified personnel and equipped with the necessary communication facilities to ensure that consumers have access to appropriate information.

The consumer awareness campaign and publicity are expected to be carried out during the simulcast period. The budget for the consumer awareness campaign is provided for by the CCK while existing electronic media houses have pledged to provide free airtime for promotions related to digital broadcasting.

The DTC in collaboration with a selected advertising agency came up with a concept to be used for production of publicity material for digital migration.

The DTC through the CCK commenced a multifaceted public awareness campaign dubbed “Join the great digital migration” to raise awareness about the ongoing analogue to digital television transition. The comprehensive consumer education had to be synchronized to digital network roll out and availability of DVB-T2 STBs.

The media campaign began on 8th June 2012 with various platforms being engaged in the campaign:

- Advertisements and public notices in the print press.
- Television and radio commercials.
- Digital screens in supermarkets.
- Outdoor advertising on billboards and street poles.
- Television interviews.
- News stories and analyses.
- Forums with stakeholders including vendors of set top boxes, and broadcasters.
- Awareness promotion in road shows and ASK shows at which fliers are distributed.
- Public interaction with Digital Kenya secretariat on phone and email.

The specific digital migration message in the advertisements emphasizes the importance of the public to buy compliant digital set-top boxes of the DVB-T2 standard from authorized vendors as well as the need for UHF aerial.

The campaign is continually being complemented by public relations activities whose strategic approach is focused on educating the media and explaining new developments in the migration process; engagement of distributors and suppliers of set-top boxes; and other stakeholders including media houses. CCK collaborates closely with the local media having recognized the media as an important vehicle to carry the digital migration message to every corner of the country and its TV viewing population. To this end, the campaign involves the media in every promotion event and is given wide coverage. In addition, a training forum for media personalities was held so that the media is able to read from the same digital migration script.

So far it is estimated that the campaign reached at least 60% of the population of Kenya and the number is bound to rise with the onset of roadshows.

9.10 Broadcast signal distribution

9.10.1 Licensing of first broadcast signal distributor

The broadcasting industry in Kenya is now segmented into two sectors, namely, broadcast signal distribution and content service provision, following the enactment of the Kenya Communications Amendment Act No. 1 of 2009.

Arising from the recommendations of the DTC, KBC by nature of its extensive public owned broadcasting infrastructure was identified as one viable entity to provide signal distribution

services. The government decided that only one signal distributor would be licensed during the simulcast period due to scarcity of spectrum currently used for analogue TV broadcasting. This policy decision was reviewed before the end of simulcast that resulted in the entry of a second broadcast signal distributor.

Following the initial rollout of DVB-T pilot signal in December 2009 in Nairobi, KBC (SIGNET) launched the first DVB-T2 transmitter in September 2011 with pay TV service offering.

As at September 2012, the SIGNET had activated three multiplexes and was on air on DVB-T2 signal in Nairobi, Mombasa, Kisumu, and Nakuru carrying over 40 channels comprising both free to air and pay TV.

The DVB-T signal was simulcast with DVB-T2 signal until 31st August 2012 when the DVB-T signal was discontinued thus enabling Kenya to only have DVB-T2 transmissions.

9.10.2 Licensing of second broadcast signal distributor

When Kenya commenced its plans to migrate from analogue to digital broadcasting, it was largely expected that the Government was to fully fund the process. However, the slow pace of progress in digital migration occasioned by lack of adequate budgetary provision for KBC by government to roll out the signal distribution infrastructure prompted the DTC to recommend to the Ministry the need to open up the signal distribution market to competition by licensing additional players ahead of end of simulcast period. This was to be done by licensing two more digital broadcast signal distributors to roll-out the digital network on a nationwide basis through a competitive procurement process by the CCK. The initial period is 15 years renewable for another 10 years.

The tendering process which commenced in February 2011 closed on 31st May 2011 attracting four bidders. M/S Pan-Africa Network Group (Kenya) Co. Ltd (PANG) emerged as the only qualified firm that met the tender requirements.

The CCK awarded a nationwide broadcast signal distribution license to Pan-Africa Network Group (Kenya) Co. Ltd on 7th October 2011. The licence required them to rollout in 12 sites by end of first year.

PANG's first DVB-T2 transmitter went on air in Nairobi in June 2012 and as at September 2012, they were on air in 7 sites namely Nairobi, Mombasa, Kisumu, Nakuru, Nyeri, Eldoret and Webuye. Their digital platform currently has a capacity of three multiples whose combined channel capacity is 81. It hosts one pay TV service provider and FTA broadcast content service providers.

9.10.3 Obligations of the signal distributor

In order to gain access to the broadcasting frequency resource necessary for countrywide roll-out of broadcast services, the signal distributor has to apply for the frequency resource in accordance with the applicable procedures.

The signal distributor shall be expected to adhere to license conditions such as:

- provide services to licensees on an equitable, reasonable, non-preferential and non-discriminatory basis;
- comply with coverage and QoS obligations as the case may be;
- payment of annual license operating fees and frequency fees to the Regulator;
- provide quality delivery of broadcasting services as per contract and SLA between the signal distributor and the broadcasters (content service providers), and make the same available to the regulator;
- submit quarterly and annual returns in a prescribed format to the Regulator;
- file all tariffs with the regulator before implementing them.

9.11 Developments in policy and legislative arena

9.11.1 The Kenya Communications (Amendment) Act

The Kenya Communications (Amendment) Act No. 1 of 2009 that came into force on 2nd January 2009 expanded mandate of the Communication Commission of Kenya to cover the broadcasting sector to include *inter alia* Licensing, Content Regulation, and Complaints Handling. The legislation also makes provision for licensing of broadcast signal distributor(s) as well as the migration from analogue to digital broadcasting.

The Kenya Communications (Broadcasting) Regulations, 2009 also has specific clauses that provide for licensing of a signal distributor/multiplex operator and provisions related to the migration from analogue to digital broadcasting. These regulations were gazetted by the Minister in January 2010.

In view of the new Act and the Regulations, specific proposals of revisions of the existing Kenya ICT Policy of 2006 have been proposed to facilitate the envisaged new role of KBC as the sole broadcast signal distributor during the simulcast period.

The CCK has also developed a new framework that will govern the licensing and regulation of broadcasting services in Kenya. However, the implementation of the framework has been put on hold due to an existing court injunction issued by the High Court.

9.11.2 Public notification

Following the coming into force of the Kenya Communications Amendment Act No. 1 of 2009, the Commission issued a public notice in February 2009 to bring to the attention of broadcasters the requirement in the Fifth Schedule of Act, which specifies that the broadcasting permits shall lapse within one year after the commencement of the Act. In this regard, the Commission advised on the requirement of migration of existing broadcasters from the regime of permit authorization issued by the Ministry to CCK licensing framework prior to the lapse of the one-year period.

However, the transitioning of existing broadcasters from old regime to the new licensing regime is temporarily on hold due to a pending court case in the High Court.

9.12 Harmonization at the East Africa Community level

The East Africa Community (EAC) member states comprise of Kenya, Uganda, Tanzania, Rwanda and Burundi. Under the auspices of the East Africa Communications Organisations (EACO), the member states have established a broadcasting technical task force (BTTF) whose terms of reference include harmonizing digital transmission standards and technical standards for set-top boxes in the EAC Region. The task force continues to have its meetings to address the various tasks it has been allocated. Kenya, through the CCK, is an active contributor to the work of the EACO taskforce.

This initiative of having a common standard for set-top boxes is expected to create a sizeable market for set-top boxes in the region that will translate into lower prices.

Kenya is currently actively involved in the work of the East African Communications Organization (EACO) technical task force on migration to digital broadcasting. The objective of the taskforce is to come up with harmonized approaches with respect to various areas related to digital broadcasting. Among the notable areas of harmonization currently under study include:

- adoption of the DVB-T2 standard for digital terrestrial broadcasting;
- development of minimum digital transmission standards and STB specifications for the EACO Region;
- coordination of digital broadcasting assignments;

- analogue switch-off date;
- quality of service parameters for digital platform;
- licensing of subscription broadcasting services;
- digital content management;
- charging principles by signal distributors.

The EACO taskforce on broadcasting is likely to be retained for some time in order to continue studying other issues related to digital broadcasting in order to enhance regional harmonization.

The EAC secretariat has also established a technical committee on broadcasting that considers the status of implementation of roadmap for analogue-to-digital broadcast migration and makes recommendations to the Sectorial Council on Transport, Communications and Meteorology (Council of Ministers) for consideration and approval before individual member states can implement.

Following the decision of WRC-12 allocating frequencies above 694 MHz for mobile services, a re-planning of channels within the band 470-694 MHz is ongoing and a number of coordination meetings are being held amongst EACO member states. This finalization of the coordination process shall culminate in individual member states filing modifications to the GE06 with the ITU way before the 2015 deadline for digital migration.

10 Russian Federation

Strategy basics for transition from analogue to digital broadcasting within an individual region (based on the experience of introduction of DVB-T broadcasting in the Primorsky region of Russia)

Modernization of a regional broadcasting network aims at updating the transmission firmware of the TV and radio broadcasting network in a region, expanding the range and list of services provided by the broadcasting operator to the users, increasing revenue for the operator and effecting a phased transformation of such an operator into an information package provider for the region allowing both commercial and social problems to be solved.

Overall strategy of updating the regional TV and radio transmission network and transition to digital broadcasting in the region

As a rule the degree of wear of analogue transmitters operated in the region is pretty high. The useful life of many transmitters is already over. Replacement of worn-out analogue transmitters by new analogue equipment appears senseless both from the technological and economic point of view, as in the transition to digital broadcasting it will be necessary to replace such new transmitters again with digital ones, this time long before the end of their useful life. Besides, one cannot see any ways of compensating for such replacement costs as analogue broadcasting in principle cannot support the new information services and products that the population would be prepared to buy and that could generate additional revenue for broadcasting operators. In this connection it seems worthwhile making the transition to digital broadcasting in the region without delay.

It is evident that transition to digital broadcasting should be effected within the framework of current frequency arrangements, that is digital TV programmes should be broadcast in the same frequency bands as analogue broadcasting formerly. This means that overnight transition to digital broadcasting should be accompanied by stopping analogue broadcasting of the same programmes within the coverage area where such transition takes place.

It goes without saying that overnight transition to digital broadcasting is not possible without equipping the population with digital receivers, i.e. subscriber set-top boxes (STBs). Transition to digital broadcasting can only be effected provided that every subscriber has such an STB, so that in

the transition process no small group's interests suffer. A broadcasting operator is not responsible for the provision of STBs to the population. Without going in detail on the organization of such provision one should mention that this problem must be solved through local funding under a comprehensive target programme implemented by the regional administration with the help of private investments. Thus the financial burden should be distributed between the commercial structures of the region the overwhelming majority of which is interested in new advanced interactive multimedia infocommunication services and products (including e-commerce and e-banking systems) supported by digital broadcasting. Introduction of such systems within a united regional information system (to be described below) may give a powerful impetus to business development in the region with the corresponding growth of commercial structures' turnover and revenues.

As for providing STBs for digital broadcasting to the population, this should be done according to a uniform schedule approved by the administration and coordinated with the broadcasters in one transmitter broadcasting coverage zone after another. Under the schedule, STBs should be provided to all rather than part of the people residing within one coverage zone, then another and so on. This will ensure the possibility of making a final transition to digital broadcasting in the region successfully. The STBs themselves are multipurpose interactive terminals capable of supporting a wide range of modern interactive information services and products besides broadcasting.

It is clear that transmitters replacing the old worn-out analogue ones should be hybrid, i.e. equally capable of operating both in analogue and digital broadcasting mode. At the first stage such a newly installed transmitter will operate in analogue mode. Later on when the population in the coverage zone is 100% equipped with STBs the transmitter will go over to digital mode with the DVB-T modulator switched on and the driver replaced (it is desirable to have both devices supplied in a complete set with the transmitter). It goes without saying that at the first stage the transmitter will broadcast only those programmes that used to be broadcast for the given coverage zone in analogue mode. Thus the next problem that arises is of most importance for urban areas where several TV programmes can be received within one coverage zone. In each broadcasting zone several analogue programmes broadcast by different transmitters may be received. Digital broadcasting is multiprogram, i.e. one digital transmitter will broadcast all those programmes that used to be broadcast by several analogue transmitters. Thus only one "head" analogue transmitter should be chosen out of the group for the coverage zone to be replaced by hybrid equipment. The transmitter should be connected with MPEG-2 signal feeder lines for all the TV programmes broadcast for the given coverage zone. All the signals should be joined together in a multiplexer into an MPEG-2 transport flow and fed into the DVB-T modulator. After this the transmitter may be switched over to the digital broadcasting mode and the analogue broadcasting of other transmitters may be stopped and dismantled.

It is clear that transition to digital broadcasting should entail an increase in the number of programmes provided to the population. As a result the situation should emerge when the regional programme package (i.e. all the programmes that are currently broadcast to at least part of the population of the region) will be accessible to every TV viewer. Of course with time the package should be expanded gradually with new commercial programmes (including pay programmes) and with free regional programmes of social and informational importance. To achieve this it is necessary to solve the problem of constructing a full regional network of TV programmes supply and distribution, i.e. when each programme received in the region via satellite channels or produced in the region itself would be supplied to every transmitter (or a group of transmitters) operated in the region. The problem can be best solved on the basis of a fibre-optic line laid in the region and running through its major populated areas. Fibre-optic line branches, i.e. TV programmes supply lines to other populated areas of the region, should be based on the existing radio relay lines or MMDS systems. Moreover the radio relay lines must be updated to transmit digital data streams. This can be done through using modems and MUXes ensuring the transmission of digital data

streams along the existing radio relay lines at the rate of 51 Mbit/s. The equipment will digitize the radio relay lines and at the same time the UHF equipment installed will remain intact. In many cases MMDS systems can also be used to bring digital broadcasting programmes to home cable networks. Naturally to expand the digital broadcasting programmes package broadcast to the population it is necessary to install some additional digital transmitters. However it is important that reception of digital broadcasting programme packages from several DVB-T transmitters by outdoor antennas in many cases may be ensured without amending the existing home cable networks.

The regional programme package may be expanded both through increasing the number of programmes made up in the region itself and through receiving more programmes via satellite communication channels.

Stages of comprehensive modernization of the regional TV and radio broadcasting network

Thus with the above approaches the following stages of comprehensive modernization of the regional TV and radio broadcasting network for transition to digital broadcasting can be defined:

- distribution of DVB-T STB to the population. STB manufacture funding may be effected within a target programme of the regional administration funded by regional investors. The STBs should be multifunctional interactive terminals supporting a wide range of modern multimedia services and products along with broadcasting;
- choosing a “head” transmitter out of the operating ones in each broadcasting zone to be replaced by a hybrid unit (with analogue broadcasting at the initial stage) with digital signals of all the programmes broadcast in the area fed to the latter;
- starting digital DVB-T broadcasting of those programmes that used to be analogue from the head transmitter, stopping analogue broadcasting and dismantling all the other transmitters in the broadcasting zone with the process going on in one broadcasting zone after another as these are ready for the change;
- constructing a regional TV programmes supply and distribution network on the basis of fibre-optic lines and digital radio relay lines, MMDS and cable lines used in the “last mile” section;
- as the regional distribution network is expanded bringing the regional TV programme package (i.e. all the programmes coming to the region via satellite channels and all the regional programmes) to each populated area in the region, with further expansion of the range of such programmes, including new regional ones (regional TV, commercial programmes); installing new DVB-T transmitters;
- on the basis of digital TV broadcasting, organizing data transmission (including web and web-type multimedia services) from the very beginning of digital TV broadcasting to provide to the population modern infocommunication services and products, both socially-oriented and commercial;
- introducing interactive products from the very beginning of digital TV broadcasting, primarily web and web-type services on TV broadcasting basis;
- constructing in the region a united interactive information multimedia regional network on the basis of subscriber’s STB with an interactive platform specially designed to take care of the region’s needs and interests and a uniform system of conditional access chosen upon agreement reached between digital broadcasting operators.

Further development of the TV and radio broadcasting transmission network in the region, expansion of the range of services and network functions through interactive servicing and provision of multimedia services.

Transition to digital broadcasting is not the end of TV and radio broadcasting transmission network modernization. It goes without saying that more TV broadcasting programmes will bring more revenue for broadcasting operators. However, the largest source of higher revenues is in the sphere of provision of a wide range of modern infocommunication services and products on the broadcasting basis to corporate and individual users. Technologically this can be achieved through encapsulation of multimedia data streams (including web and web-type services data) into TV broadcasting digital flows. Reception of the above services and their data display on the TV screen will be done with the help of digital TV broadcasting STBs. The same STBs with their software and firmware support return channels organized on telephone lines (on the basis of built-in dial-up modems) or with xDSL facilities or, provided there are home cable lines, HFC (hybrid fibre cable) on the basis of the DOCSIS standard (built-in or external DOCSIS modems connected with the STBs by Ethernet interface).

Overall description of information and interactive services and products based on digital TV broadcasting. The initial stage of introduction of the services in the region

Enhanced TV and interactive TV are principally new TV broadcasting services that can only be provided on the basis of digital broadcasting. The concept of enhanced TV envisages pay services with a coded signal that requires using smart cards and conditional access systems. Private companies leasing equipment from the operator may provide such services to the population under subscription for pay packages. Moreover the possibility of free reception of the social programmes package (both national and regional) by the population remains.

Enhanced TV envisages the technology of pseudo-interactive DVB-T services without a return channel. These include various information services and reference materials, such as TV – the press, weather forecasts, ratings, advertisement channels, etc. In transition to digital broadcasting such services may be provided at once in those populated areas of the region where there is a shortage of telephones and where it is yet impossible to organize a return channel for full-scale interactive service.

In the towns of the region with sufficient telephone penetration, interactive systems may be deployed on the basis of a return channel on a telephone line. A return channel can support various e-commerce services, on-line shops as well as rating votes and population polls that are important socially and may be needed by the regional administration. At the same time high-rate access to the Internet on dedicated digital DVB-T channels may be provided. For this a TV viewer will not need a PC as in this case its function will be performed by the STB for digital broadcasting: it will display web pages on the screen after appropriate reformatting and rescaling of text and graphic objects in web pages in a way allowing their display on the screen of a standard definition TV set. The web browser is operated with the help of a cordless keyboard. Connection does not require any additional time, as the Internet channel is permanently available. In fact the service is a factor of new quality of life, as television becomes a powerful information gateway concentrating most advanced information technologies that enable any person regardless of his or her age, education and social status to be a full-scale member of the global information infrastructure without buying a PC, just with the help of a familiar TV set. The digital TV broadcasting STB supports the Internet access and e-mail functions.

At the next stage of deploying a digital TV broadcasting system in the region it becomes possible to extend the interactive services to remote rural areas with insufficient telephone penetration. This becomes possible through using return channel cordless DVB-RCT technology.

Construction of a united interactive multipurpose information system on the basis of digital TV broadcasting in a region

If there are return channels, the following interactive infocommunication services may be provided on the basis of digital TV broadcasting to corporate and individual users:

- access to the Internet without using a PC;
- e-trade;
- e-commerce;
- management of a bank account, including execution of commercial transactions at a distance using a digital signature;
- e-system for ordering municipal services;
- communal utilities payment e-system;
- services base on “video-on-demand” technology;
- cottage industry e-systems;
- e-health;
- e-learning systems;
- virtual CD-ROM;
- web games.

All together the above-listed information services may form a united interactive multipurpose information system implemented on the basis of a single user’s interface (browser) and a uniform interactive platform. Thus a broadcasting operator may become a provider of the service system to corporate and individual users. It makes sense to shape such systems on a regional basis. For this there should be in the region data formation centres for corresponding information services, including specialized servers and devices for encapsulation of the said services in TV broadcasting signals. Server software represents a multifunctional software package including, in particular, billing modules, modules of interoperation with banking payment systems, advertising management, mediametrics collection and processing of return (interactive) channels data, etc. The user part of the software for such a system (browser) is installed in the digital broadcasting STBs.

Without going into detail concerning the construction and functioning of such a system it is possible to point out its major sources of additional revenues for the operator. These include among others subscription fee charged on the basis of a conditional access system (implemented through STB smart cards). However, it is advertiser’s payments that constitute the most important source of revenue for the operator of an interactive information system. Advertising in interactive information systems radically differs from traditional linear advertising in analogue broadcasting. Its main distinction lies in its target nature (different groups of users get different advertisements) and in the built-in function of measuring the audience (mediametrics). Actually STBs can support the following functions:

- 1 Assignment of a consumer index to the subscriber. When a subscriber is switched in the system a questionnaire is displayed on the screen with a number of items referring to the subscriber’s social status, age, sex, revenue, interests in various spheres, goods and services of interest, etc. (such a poll may be repeated in certain periods of time, e.g. annually, to identify the changes, if any). The questionnaire aims at establishing what type of advertising should be supplied to the subscriber. The questionnaire is based on multiple choices. A given consumer index is assigned depending on the choice of answers. The index is forwarded to the operator’s server and further on is used to identify the advertising materials to be supplied to this subscriber.
- 2 Mediametrics of TV programmes. An STB registers each switch over from one TV channel to another and certainly the viewing time on each channel. Periodically (say, once a day) the obtained viewing data is forwarded to the operator’s server. The function allows calculation of the exact rather than approximate rating of TV programmes.

- 3 Advertising mediametrics. Each payment for goods and services effected by a subscriber with an STB (supporting the e-payments function) is registered and the information about the type of goods or services bought is transmitted to the operator's server where the connection between the purchase of the goods and services and their advertising supplied to the subscriber earlier is analysed. This function is necessary to appraise the effectiveness of advertising materials.

It is clear that with these functions the operator of an interactive information system obtains data of vital importance both for TV companies (programme ratings) and advertisers (much higher effectiveness of advertising thanks to its target character, information about the effectiveness of advertising materials). This enhances the attractiveness of the system for the TV companies and advertisers and affects the operator's revenues accordingly.

Another important source of revenue for the operator is payments by commercial structures selling goods and services within the framework of the e-trade system, as part of the system as a whole. The e-trade system is in great demand for commercial structures as it enables these to increase significantly their sales. A new market is open to the sellers – electronic retail sales with immediate payment for goods and services in non-cash form via e-banking.

TV viewers may choose the goods via the on-line shops system in which they may view video clips of the goods, order these to be delivered to their homes or not and pay for them with the help of their smart card. Foreign practice confirms great success of such projects as in addition to convenience and time saving the customer pays less for the goods than in traditional shops (thanks to lower seller's overheads and non-cash payments) and due to that fact that e-payment systems in closed digital TV networks are more reliable than those on the Internet.

If the above regional interactive information system based on digital broadcasting is established in a region as a next logical step after overall transition to digital broadcasting in the region, it would also be logical to base the system of subscription fees on a uniform conditional access system. It goes without saying that such a system should have an open (socially oriented) component and a commercial component and subscription fees will be charged only for services provided by the commercial component.

11 Tanzania

Introduction

Tanzania has been addressing the migration from analogue to digital terrestrial broadcasting immediately after the RRC-04. The Tanzania Communications Regulatory Authority (TCRA), the regulator of Communications, Broadcasting and Postal sectors participated in the RRC-06 processes. After RRC-06, two consultation documents were issued followed by workshops, annual conferences and forums aimed at addressing how digital terrestrial broadcasting will be implemented, managed and regulated in Tanzania.

Important issues addressed, include the way digital television operates and its efficient use of frequency spectrum resource and its associated value added services.

Furthermore, the Authority has worked out major issues that will guide smooth migration.

Among the measures undertaken by TCRA is the introduction of the Converged Licensing Framework (CLF) with four (4) major licences, 1. Network Facility Licence, 2. Network Service Licence, 3. Content Licence 4. Application Service Licence addresses the complex licensing issues associated with digitization.

To realize smooth migration, TCRA produced two consultation documents on digital broadcasting which were discussed by all stakeholders. National Technical Committee has been formed to handle migration issues and workout the roadmap to full digital broadcasting in Tanzania.

The consultations, yielded initial framework on the new broadcasting landscape in Tanzania. The new broadcasting chain landscape is such that, there will be two distinctive features namely, the Content Service Provider and Signal Distributor who will be charged with multiplexing. There will be *two commercial Multiplex Operators, and one Public Service Multiplex Operator under the initial licensing framework* that will be charged with the responsibility of signal distribution.

Tanzania, a country at the eastern coast of the African continent, spans 1122 Sq. kilometres with a population of 36 million inhabitants. Tanzania falls under ITU Region 1. There are 26 licensed analogue television stations, out of which 4 are national coverage, 5 regional coverage (covering ten administrative district areas) and the rest district administrative coverage.

There are also three (3) licensed digital satellite pay television stations and one digital terrestrial television operator in the City of Dar Es salaam under a pilot DVB-T project. There are 95 analogue television transmitters countrywide.

After the two consultation processes between 2005 and 2007, a final document on “The Transition from Analogue to Digital Terrestrial Broadcasting in Tanzania” addressing the Regulatory and Legal Framework under which Digital Television will be implemented, managed and regulated. The Authority has so far run an awareness campaign among the media stakeholders during the consultation process that has come up with the roadmap for licensing of Multiplex Operators. The Authority has so far achieved the following goals and is set to licence the pilot project in the financial year, 2008/2009 on a phased approach basis.

In the interim period, the Authority has formed the Work Group on Digital Broadcasting (WGDB) with experts from broadcasting, spectrum management, ICT development and legal sector tasked to address the following issues:

- Consider licensing issues of MUX.
- Consider National Plan of Digital Broadcasting and simulcast period.
- Consider Licensing issues of other services like, Mobile TV, IPTV etc.
- Consider and adopt a positional paper on availability of STB.
- Editing of the final document on Digital Broadcasting in Tanzania.

In April, 2008, TCRA announced an Expression Of Interest (EOI) for prequalification for interested parties to submit their interest for provision of digital multiplex services in Tanzania. The response was positive.

The Authority has postponed licensing of new television applicants from 2007 in order to audit the UHF and VHF channels countrywide and plan for digital terrestrial services countrywide during simulcast period. The digital plan status will be ready before the end of this year.

The digital plan will give detail to the WRC-07 decisions, on smooth implementation of digital broadcasting.

The Authority is carrying out an exercise of reviewing the Broadcasting Services Act, 1993, Tanzania Communications Act, 1993 and the Tanzania Communications Regulatory Authority Act, 2003 with a view of incorporating Digital Terrestrial Broadcasting and Multiplex Operator a legal force.

The Authority will embark on public awareness campaign on digital migration and coordinate with neighbouring countries on best ways of efficient utilization of spectrum, interference mitigation and protection of existing analogue services during dual illumination.

Digital Migration Policy in Tanzania

The Tanzanian ICT Policy, 2003 governs the digital migration process in Tanzania.

And the realization of digital dividend prior to WRC-07 by allocating the broadcasting sub-band 825.285-862 MHz (about 37 MHz) for CDMA mobile operators realizing digital dividend earlier.

Tanzania's position during WRC-07 was very clear. It supported new broadcasting band at 470-790 MHz to promote mobile phone industry as a catalyst to universal access. The mobile industry penetration in the past few years has dominated the communication market than fixed lines whose roll out has been slowing down.

The Authority is constructively engaging the Government on possibilities of giving out subsidies to importation of set-top-boxes so as to make them available to common people.

TCRA in collaboration with the Government is setting up policies and recommendations on availability of set-top boxes. The idea of fees from the dividend is still raw and under discussion.

Migration from Analogue to Digital broadcasting in Tanzania in Tanzania is policy driven. It has taken TCRA three years to prepare broadcasters for the uptake of digital broadcasting. Worries have been on the fate of the analogue infrastructure investment and "fear" of revocation of frequency channels by incumbents. Worries have even been on consumers on the availability of affordable set-top boxes.

Tanzania has adopted phased migration approach. This will help correct mistakes experienced in initial stages of implementation.

Tanzania will switch off analogue systems by 2015 and the chances of doing it before that time is clear.

Challenges on licensing; There are digital TV products which the Authority is working on the proper framework to cater for the country's ICT trend.

There have been concerns during the migration process on existing analogue infrastructure.

During consultations, it was agreed that, the licensed multiplex operator enters into agreement with analogue broadcasters to use part of their usable infrastructure.

Tanzania is actively participating in all activities pertaining to digital broadcasting in Region 1 of the ITU and the CTO-Digital Broadcasting Forum in Johannesburg every year. This has been instrumental in having common migration strategies and has acted as sensitizing machinery among participating African nations. Even those that have not initiated efforts to migrate from Analogue to Digital broadcasting have been supported to initiate steps towards migration.

Organizations like Communications Regulatory Authorities of Southern Africa (CRASA) and East African Communication Regulatory authorities are engaged in efforts aimed at successful implementation of digital broadcasting.

12 United States of America

Background

The United States of America has moved forward aggressively with the implementation of DTV using the ATSC Digital Television (DTV) Standard, a powerful technology that is transforming the nature of broadcast television service. This new broadcast transmission standard provides broadcasters with many new capabilities to serve the public, such as HDTV and standard resolution pictures, multicasting, data delivery, interactive communication, robust reception modes, and other features. These capabilities provide broadcasters the technical flexibility and options to compete with other digital media such as cable and direct broadcast satellite services. The ATSC DTV

standard was developed through a lengthy initial specification process that began in 1987 and its evolution is continuing today, due to the flexibility for extending the digital system to include new capabilities as technology continues to develop. Coincident with the development of the transmission technology, the U.S. Government, through actions by its Federal Communications Commission (FCC) and legislation by the U.S. Congress, has developed public policies under which digital television is being implemented.

The U.S. Government is implementing broadcast DTV service as a replacement technology for the existing analog National Television System Committee (NTSC) technology that has been used for transmission of broadcast television service in the United States of America since the late 1940s. Under this policy approach, all eligible existing television stations were provided a second channel to be used for DTV service during a transition period from the analog to digital operation. This transition period, which began in 1998, is intended to facilitate an orderly change to the digital television technology while taking account of consumer investments in analog television sets. At the end of this transition period, TV stations will cease analog transmissions so that all broadcast television service will then be in the digital format. The FCC will also recover one of each TV station's two channels at this time. Because operation with the ATSC standard is very spectrum efficient, it is possible for all of the existing TV stations to operate in a much smaller amount of spectrum bandwidth, thereby allowing a portion of the existing TV channels 2-69 to be recovered for new uses. The U.S. Government plan is for all DTV stations to operate on channels 2-51 (the DTV core spectrum) after the transition ends and to recover channels 52-69 (698 MHz to 806 MHz) for new uses.

After very careful consideration and review in the FCC's public rule making processes, the Commission afforded broadcasters great flexibility in the use of their DTT channels. Broadcasters were required at least to match the hours of operation of their existing analog station. For example, if the analog station operated 24 h/day, then the digital station would also be required to operate 24 h/day.

Broadcasters were given almost unlimited flexibility in the services that could be offered over their 6 MHz digital channel. They were required to offer one free-to-air video program service with resolution equivalent to their existing analog service. Beyond this, they could offer whatever other services they chose on the digital channel.

The FCC did not impose any requirement that broadcasters offer HDTV, and there is no legal requirement for U.S. broadcasters to offer HDTV. However, HDTV was the initial focal point of the U.S. transition to DTT broadcasting, and it has remained the centerpiece application throughout the U.S. deployment.

Pay services were explicitly permitted by the FCC, once a single, free, standard-definition program had been provided. If broadcasters do use their DTT channel to offer services for which a subscription fee or charge is required in order to receive service, they are required to pay the U.S. government a spectrum use fee in the amount of 5% of gross revenues from any such service.

The basic transition plan followed in the U.S. was to require stations affiliated with the four largest TV networks in the 30 largest cities to implement DTT first, while allowing more time for stations in smaller cities to make the transition. In addition, public TV stations were given an extra year beyond the deadline that applied to commercial stations. The FCC's initial plan applied to approximately 1 600 commercial and non-commercial (public) stations. Transition planning for low-power TV stations and for translators was deferred for several years, but has now been completed. Low power TV stations generally will be allowed to transition to DTV operation on their existing channels. In addition, if they so desire and a channel is available, low power stations may request a "companion channel" for DTV operation during the transition. The FCC further stated that it would establish a deadline at the end of the transition for low power stations that would be after the end of the transition for full service stations.

Each station was given a new assignment for its DTT broadcast channel, along with an antenna height, antenna pattern and maximum radiated power level, in an effort to replicate the station's analog coverage area. Assignments for all 1,600 stations were made shortly after the FCC formally adopted the ATSC Standard and approximately 18 months before the launch of commercial DTT service.

At the request of the FCC, 28 stations in the ten largest cities volunteered to launch DTT service in November 1998, six months ahead of the deadline established by the FCC. Six months later (May 1999) all stations in the top 10 markets that were affiliated with the four largest broadcast networks were required to provide service, and in another six months (November 1999) this requirement was extended to the affiliates of the four largest networks in all of the 30 largest cities. All commercial broadcasters were required to be on the air by May 2002 and all non-commercial broadcasters by May 2003. Broadcasters who could not meet these deadlines were allowed to apply for a six-month extension and in some cases a second six-month extension under certain circumstances.

The U.S. Congress and the FCC are determined to conclude the transition to DTT broadcasting as rapidly as possible for a variety of reasons, most notably to recapture 108 MHz of invaluable nationwide spectrum that will be made available once analog TV transmissions cease. Broadcasters also want to make the conversion as rapidly as possible in order to eliminate the expense of operating two TV stations in parallel.

In early 2006, legislation was enacted by the U.S. Congress requiring broadcasters to terminate their analog transmissions by February 17, 2009. This legislation included provision of up to US \$1.5 billion to subsidize the purchase by television viewers of digital-to-analog set-top converters that could be used to view DTT signals on existing analog television receivers.

Each television household would be permitted to apply for up to two \$40 coupons that could be used to purchase such converters, with only one coupon allowed per converter. The price of these converters is typically about US \$50 (without a coupon).

The FCC adopted regulations that phased in a requirement for inclusion of ATSC receiving capability starting with the largest TV sets first, in 2004, and for all sets over 13 inches by July 2007. In November 2005 the FCC amended its rules to advance the date for the completion of the phase-in period to March 1, 2007, and to apply the requirement to all receivers regardless of screen size. Thus, every television set sold in the U.S. must now contain ATSC DTT reception and decoding capabilities. The U.S. Consumer Electronics Association predicts that over 100 million integrated ATSC DTT receivers per year will be sold in the U.S. alone by 2009. This is in addition to ATSC HDTV Set-top boxes and digital to analog converters.

Although it is not required by the government, all DTV receivers available in the United States are capable of decoding all ATSC specified video formats. All-format decoding is essential to permit the introduction of HDTV – later, if not initially.

While there are no government requirements for DTT receiver performance, on a voluntary basis (and upon the recommendation of the FCC) the ATSC has adopted a recommended practice giving performance parameter guidelines for DTT receivers.

Implementation progress

The United States is now in the final stages of its DTV transition and there have been many challenges that have been faced and overcome in the period since 1997. In recent years the desire of the U.S. Government to recover TV channels 52-69 for new uses has given rise to greater emphasis on completing the transition as rapidly as possible. The FCC has taken a variety of steps to achieve a rapid conclusion to the transition and to ensure that the benefits and services of DTV broadcasting

are available to all Americans. The U.S. Congress has also enacted legislation that mandates the end of analog television transmissions on February 17, 2009.

DTT broadcasting is moving ahead at a feverish pace. More than 1,700 DTV stations are on the air in 211 metropolitan areas, reaching 99.99% of U.S. television households with at least one digital signal. More than 90% of households have access to at least five digital signals, and more than 80% have access to at least eight. In the largest U.S. cities, as many as 23 digital stations are on the air.

HDTV programming is widely available, not only via DTT broadcasts, but over cable and satellite systems as well. Most network primetime and sports programming is now produced in HDTV. Local TV stations are beginning to offer their local news in HDTV.

Manufacturers throughout the world have responded to this demand by developing and marketing more than 750 different models of HDTV and other ATSC DTT consumer products, using a wide variety of new display technologies. Competition is frenzied, with prices continuing to fall rapidly and sales skyrocketing. Since late 1998 when the service was launched and March 31, 2006, more than 30 million units of DTT consumer products worth more than \$50 billion have been sold in the U.S. alone. Moreover, sales are continuing to grow exponentially, with projected sales for all of 2006 of approximately 20 million units worth US \$30 billion.

Standard-definition (SDTV) integrated 27" ATSC receivers are now available for as little as US \$299, and integrated 27" HDTV receivers for as little as US\$430. Indeed, prices for HDTVs are converging rapidly with those for analog color TVs. It is no longer possible to purchase a large-screen analog color TV in the U.S. They have all been replaced by digital HDTVs. This trend will accelerate and spread to smaller screen sizes over the next few years as prices continue to fall and as the phase-in of the FCC's tuner mandate is completed. Under this regulation, all television receivers sold in the U.S. must have ATSC tuning and decoding capability by March 2007. As a result, by 2007 an estimated 34 million ATSC receivers per year will be sold in the U.S. alone, with cumulative sales reaching 152 million by 2009. Such massive sales volumes will further drive down the price of ATSC receivers, such that many experts believe that within three or four years, virtually all TV sets sold in the U.S. will be HDTVs, because they will cost no more than analog color TVs by that time, even at the smaller screen sizes.

In addition to HDTV, broadcasters in the U.S. are using DTT to provide innovative packages of new services. Some broadcasters are providing multiple simultaneous programs of SDTV. This is especially important for public broadcasters in achieving their goals to support public education, providing multiple education programs instead of just one program at one time. Many commercial broadcasters are now offering a main program in HDTV, plus another SDTV program such as 24-hour news or weather. Some broadcasters are also pooling their excess capacity to offer basic pay-TV platforms in competition with cable and satellite systems.

Broadcasters are also beginning to offer various data services using the ATSC family of standards, including interactive information services.

The U.S. government is planning to complete the transition to DTT broadcasting by February 2009, in order to free up extremely valuable nationwide spectrum that can be used to promote public safety and national security, and to support new wireless services that will be engines of economic growth for decades to come. To support its decision to end analog television transmissions, the U.S. Congress urged the development of an inexpensive digital-to-analog set-top converter box to permit consumers to view DTT signals on their existing analog TV sets. Several manufacturers responded, demonstrating prototype converters that are expected to cost US\$50 by 2008, if sold in large quantities.

With respect to reception by portable hand-held receivers or in fast-moving vehicles, the ATSC Standard was not originally designed to provide this type of reception. Rather, the goal was to deliver the largest possible payload data rate to the largest service area, to ensure that broadcasters

could reach the largest possible audience with high-quality HDTV images and associated surround sound.

Now that HDTV is firmly in hand, however, U.S. broadcasters are showing increasing interest in receiving DTV signals in moving vehicles and by pedestrians with hand-held devices. A number of companies have been working on adding such applications to the ATSC Standard.

Conclusion

The implementation of digital television service based on the ATSC family of standards is moving ahead dramatically in the U.S. (HDTV is firmly entrenched, and is replacing analog color television at a rapid pace. SDTV multicasting and information services are also important and are being expanded, as broadcasters learn to take full advantage of the rich possibilities of DTT broadcasting using the ATSC family of standards. A cornucopia of dazzling new consumer products is available, at rapidly falling prices that make DTT receivers affordable for all socio-economic classes. Continuing improvements in ATSC receivers and further extensions and new additions to the ATSC family of standards are laying the groundwork for additional new services and applications in the future.

The U.S. is now in the final stages of its transition to digital television broadcasting, with a hard date set for the end of analog transmissions. Ending analog transmissions will mark the end of the transition to DTT broadcasting, which will permit the recovery of extremely valuable spectrum that will support new wireless services that will be engines of economic growth for decades to come.

13 Republic of Korea

The Republic of Korea decided digital transition from analogue broadcasting services to provide spectrum efficient and high quality services. With careful studies and field test, standards to achieve effectively the digital transition of each analogue media were chosen. For fixed reception at home, high quality services on large screen display will be major service models but low or intermediate quality acceptable on small and handheld receivers for mobile reception.

In the Republic of Korea, digital terrestrial television broadcasting was started in 2001, digital satellite broadcasting in 2002, and terrestrial multimedia broadcasting in 2005. Cable TV is also in service of digital programs since 2002.

13.1 Digital TV for fixed reception

Terrestrial television sets may be appropriate receivers to enjoy high definition video and multi-channel audio with a large screen at home. The Republic of Korea adopted ATSC system in 1997 for digital transition of analogue television broadcasting in the UHF band according to the policy to obtain high definition quality within 6 MHz raster and conducted field tests in 1999 and 2000.

There are 160 ATSC transmitters currently installed around the country covering about 92% of territory as of 2006. Several principles were given to digital terrestrial television broadcasters to follow government policies on digital transition as follows:

- Simulcast of analogue and digital broadcasting until analogue switchover.
- Requirement of minimum time for HDTV programs (annually increasing).
- Return of frequencies allocated to analogue television stations.

It was not an easy job to find frequencies for digital television stations, because the UHF band from 470-752 MHz is already occupied with analogue television broadcasting. Hence, the band of 752-806 MHz, currently allocated to fixed and mobile services in Korea, was decided to use for broadcasting services during the transition time only, but these bands will be returned after

analogue switchover. In order to facilitate frequency assignments, Equalization Digital On-Channel Repeater and Distributed Translator are devised for ATSC system to use same frequencies.

More than 4 million Set-Top-Boxes, about 23% of households, were sold as of 2006. It is expected to increase penetration rates of Set-Top-Boxes, since data broadcasting was started in 2005. Data services provide information on dramas or records of sports games as well as EPG.

13.2 T-DMB for mobile reception

For mobile multimedia broadcasting service, the Republic of Korea developed the video standard, which is fully backward compatible with the T-DAB, and named as Terrestrial Digital Multimedia Broadcasting (T-DMB). The specification of T-DMB was standardized as ETSI TS102 427 and ETSI TS 102 428 and submitted to WP 6M for a new recommendation of mobile multimedia broadcasting by handheld receivers.

T-DMB pilot services were conducted in Band III in Seoul metropolitan area and its vicinity and field test results showed good mobile reception quality. Field test results were submitted to WP 6M meeting held in April 2004 and included in Report ITU-R BT.2049 (see also Doc. 6E/186).

In December 2005, the Republic of Korea launched commercial service of T-DMB in Seoul Metropolitan area and expanded to the nationwide services in March 2007. Each broadcaster provides two video services or one video with three audio services within an ensemble and optionally with data services.

The whole territory was divided into seven regions including Jeju Island for business. One national broadcaster and seventeen regional broadcasters were licensed to serve T-DMB nationwide. It was intended to serve each region with the same frequency and most transmitters are linked with single frequency networks to cover the wanted regional area. Fortunately, Seoul Metropolitan area is assigned two TV channels, 8 and 12, and served by six broadcasters. In order to allocate frequencies to T-DMB stations, frequencies of 44 analogue TVR in the band III were changed after simulation of mutual interference and analysis. The channel assignment plan in the Band III for the services is shown in Fig. 57.

However some transmitters in southern part do not have same frequencies due to pre-occupied frequencies for analogue TV stations and some regions consist of multi frequency networks; Channel 7 and Channel 8 of the south-western region, Channel 7 and Channel 9 of the middle of eastern region, Channel 9 and Channel 12 of south-eastern region and Channel 8 and Channel 12 of Jeju Island. Hand-over technology was implemented on receivers for continued reception of a wanted service, even in other ensembles or different RF channels, while moving into other network.

In order to enjoy T-DMB services even underground, low powered T-DMB gap-fillers, which receive outdoor T-DMB signals and retransmit, were installed at 294 points to cover the whole lines of Metros in Seoul.

A variety of commercial receivers for portable or handheld reception are introduced in the market. Since the launch of T-DMB service in December 2005, 3.14 million receivers are sold in Korea as of 31 January 2007.

Data services such as EPG, TPEG and BWS are in services and interactive services using return channel will be appeared soon with the cooperation of telecommunication operators. These data services are expected to produce pay services for business by providing information on traffic jam, stock and even Internet access.

FIGURE 57
Channel Assignments for T-DMB in Korea

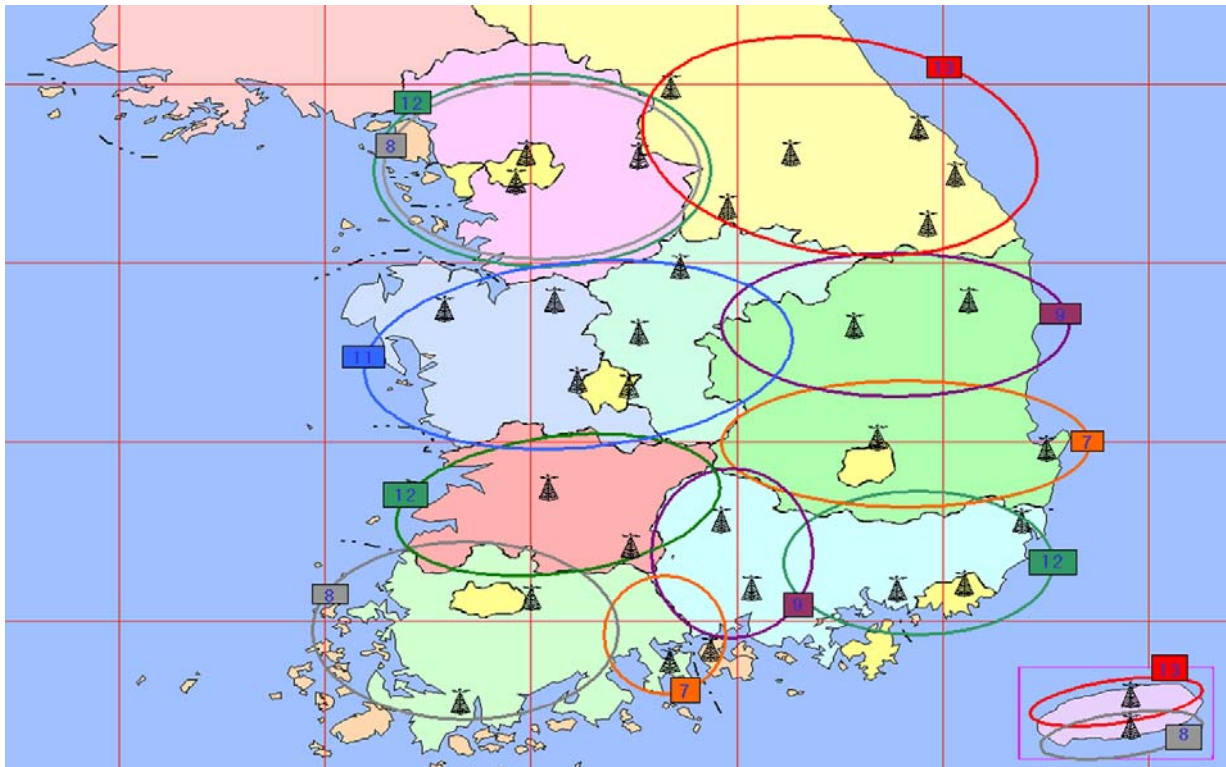

Report BT.2140-57

14 Venezuela

Adoption of standards for digital sound and digital television in Venezuela.

Introduction

In order to assist in the selection of Digital Radio and Television systems in Venezuela, the National Commission of Telecommunications (CONATEL) has created a Digital Radio and Television project, supported by constant research. Its ultimate goal is advancing the tasks for the introduction of this service, and thus, making Digital Radio and Television systems in Venezuela a medium-term reality.

Digital Radio and Television project – Development stages

The development of the Digital Radio and Television project involves four (4) stages, as described below:

Stage 1: Feasibility study (technical, economic and legal aspects)

The tasks that comprised the feasibility study –still under development- are the following:

Review of national television and radio stations regarding location, frequency, service quality, technology and regulatory aspects.

Review of digital radio and television technology development, equipment suppliers, costs, comparison and selection of the most suitable technology.

Detailed study of the band frequencies that are to be assigned to analog and digital radio and television stations, with the purpose of optimizing the use of spectrum.

Study of the required investments, economic impact and investment recuperation involved in the switching from analogical to digital radio and television systems.

Evaluation of foreign experiences regarding this matter, and possible variables for the acceptance of this technology in Venezuela.

Documental analysis of digital radio and television regulations.

Stage 2: Forum and operating tables

During this stage, contacts are made with companies in charge of the development of digital radio and television standards, as well as with equipment suppliers and regulation departments, with the cooperation of domestic radio and television operators.

Stage 3: Trials

Trials help to adopt suitable policies to benefit Venezuela's technological smooth switch to digital radio and television. This stage will produce both experimental and regulating experiences:

Trials

Switch to the digital system.

Setting of regulation framework.

In general, domestic and foreign investments for the development of new technologies require a regulation framework, which will settle the rules for their evolution and put into practice.

The efficient performance of the above-mentioned functions will be a key aspect to plan legally sustained trials for digital radio and television systems, which can prove trustful and safe for both domestic and foreign investors. Besides, this option will facilitate the study of spectrum shares, not assigned to digital radio and television.

Other important legal aspects relate to the obligation to mention the specific spectrum share to be used by the incumbent. This share can only be used and exploited within the specific cover indicated on a special permission.

Besides, getting a special permission will not grant expectations of rights to incumbents or preferential rights whatsoever in getting of a grant for the use and exploitation of the spectrum share necessary for developing all the activities foreseen by the regulations. Once a special permission has expired, its incumbent will not be able to continue using the spectrum shares assigned, unless they update their permission.

Incumbents with special permission will not obtain any counter-payment from users because of service rendering during trials. Once the trial is over, they should present a detailed report about the activities carried out and the results obtained. At any given moment, CONATEL can inspect or supervise the trials.

For the special permission, the interested incumbents will have to indicate the accurate date for the beginning of trials and the length the trials (up to three months).

If there are justifiable reasons, the beginning of trials can be adjourned unless decided otherwise by CONATEL. The trials can only be adjourned once.

During the deliberation period, CONATEL can require any concerning information from the incumbents, in order to evaluate the application. In this case, CONATEL will notify the titular that they have 10 days to submit their requirements. From the date of the application, CONATEL can interrupt the deliberation period for ten days. Due to the complexity of the matter, this period can be extended up to fifteen continuous days.

Stage 4: Standards adoption

This stage is the milestone for the digital radio and television adoption process. The fitting of the legislation in force to the characteristics of the chosen system will provide strength and trust to the process of putting digital radio and television services into practice in Venezuela.

Appendix 2

to Part 2

1 Definitions

From Radio Regulations.

Section II – Specific terms related to frequency management

1.16 *allocation* (of a frequency band): Entry in the Table of Frequency Allocations of a given frequency band for the purpose of its use by one or more terrestrial or space *radiocommunication services* or the *radio astronomy service* under specified conditions. This term shall also be applied to the frequency band concerned.

1.17 *allotment* (of a radio frequency or radio frequency channel): Entry of a designated frequency channel in an agreed plan, adopted by a competent conference, for use by one or more administrations for a terrestrial or space *radiocommunication service* in one or more identified countries or geographical areas and under specified conditions.

1.18 *assignment* (of a radio frequency or radio frequency channel): Authorization given by an administration for a radio *station* to use a radio frequency or radio frequency channel under specified conditions.

Section III – Radio services

1.19 *radiocommunication service*: A service as defined in this Section involving the transmission, *emission* and/or reception of *radio waves* for specific *telecommunication* purposes.

In these Regulations, unless otherwise stated, any radiocommunication service relates to *terrestrial radiocommunication*.

1.20 *fixed service*: A *radiocommunication service* between specified fixed points.

1.24 *mobile service*: A *radiocommunication service* between *mobile* and *land stations*, or between *mobile stations* (CV).

1.26 *land mobile service*: A *mobile service* between *base stations* and *land mobile stations*, or between *land mobile stations*.

1.38 *broadcasting service*: A *radiocommunication service* in which the transmissions are intended for direct reception by the general public. This service may include sound transmissions, *television* transmissions or other types of transmission (CS).

1.39 *broadcasting-satellite service*: A radiocommunication service in which signals transmitted or retransmitted by *space stations* are intended for direct reception by the general public.

In the broadcasting-satellite service, the term “direct reception” shall encompass both *individual reception* and *community reception*.

1.56 *amateur service*: A radiocommunication service for the purpose of self-training, intercommunication and technical investigations carried out by amateurs, that is, by duly authorized persons interested in radio technique solely with a personal aim and without pecuniary interest.

1.57 *amateur-satellite service*: A radiocommunication service using *space stations* on earth *satellites* for the same purposes as those of the *amateur service*.

Section IV – Radio stations and systems

1.61 *station*: One or more transmitters or receivers or a combination of transmitters and receivers, including the accessory equipment, necessary at one location for carrying on a radiocommunication service, or the *radio astronomy service*.

Each station shall be classified by the service in which it operates permanently or temporarily.

1.62 *terrestrial station*: A station effecting *terrestrial radiocommunication*.

In these Regulations, unless otherwise stated, any *station* is a terrestrial station.

1.63 *earth station*: A station located either on the Earth’s surface or within the major portion of the Earth’s atmosphere and intended for communication:

- with one or more *space stations*; or
- with one or more *stations* of the same kind by means of one or more reflecting *satellites* or other objects in space.

1.66 *fixed station*: A station in the *fixed service*.

1.66A *high altitude platform station*: A station located on an object at an altitude of 20 to 50 km and at a specified, nominal, fixed point relative to the Earth.

1.67 *mobile station*: A station in the *mobile service* intended to be used while in motion or during halts at unspecified points.

1.68 *mobile earth station*: An *earth station* in the *mobile-satellite service* intended to be used while in motion or during halts at unspecified points.

1.69 *land station*: A station in the *mobile service* not intended to be used while in motion.

1.70 *land earth station*: An *earth station* in the *fixed-satellite service* or, in some cases, in the *mobile-satellite service*, located at a specified fixed point or within a specified area on land to provide a *feeder link* for the *mobile-satellite service*.

1.71 *base station*: A *land station* in the *land mobile service*.

1.72 *base earth station*: An *earth station* in the *fixed-satellite service* or, in some cases, in the *land mobile-satellite service*, located at a specified fixed point or within a specified area on land to provide a *feeder link* for the *land mobile-satellite service*.

1.73 *land mobile station*: A *mobile station* in the *land mobile service* capable of surface movement within the geographical limits of a country or continent.

1.74 *land mobile earth station*: A mobile earth station in the land mobile-satellite service capable of surface movement within the geographical limits of a country or continent.

1.75 *coast station*: A land station in the maritime mobile service.

1.76 *coast earth station*: An earth station in the fixed-satellite service or, in some cases, in the maritime mobile-satellite service, located at a specified fixed point on land to provide a feeder link for the maritime mobile-satellite service.

1.77 *ship station*: A mobile station in the maritime mobile service located on board a vessel which is not permanently moored, other than a survival craft station.

1.78 *ship earth station*: A mobile earth station in the maritime mobile-satellite service located on board ship.

1.79 *on-board communication station*: A low-powered mobile station in the maritime mobile service intended for use for internal communications on board a ship, or between a ship and its lifeboats and life-rafts during lifeboat drills or operations, or for communication within a group of vessels being towed or pushed, as well as for line handling and mooring instructions.

1.80 *port station*: A coast station in the port operations service.

1.81 *aeronautical station*: A land station in the aeronautical mobile service.

In certain instances, an aeronautical station may be located, for example, on board ship or on a platform at sea.

1.82 *aeronautical earth station*: An earth station in the fixed-satellite service, or, in some cases, in the aeronautical mobile-satellite service, located at a specified fixed point on land to provide a feeder link for the aeronautical mobile-satellite service.

1.84 *aircraft earth station*: A mobile earth station in the aeronautical mobile-satellite service located on board an aircraft.

1.85 *broadcasting station*: A station in the broadcasting service.

1.96 *amateur station*: A station in the amateur service.

1.97 *radio astronomy station*: A station in the radio astronomy service.

1.98 *experimental station*: A station utilizing radio waves in experiments with a view to the development of science or technique.

This definition does not include *amateur stations*.

Section V – Operational terms

1.128 *television*: A form of telecommunication for the transmission of transient images of fixed or moving objects.

1.129 *individual reception* (in the broadcasting-satellite service): The reception of emissions from a space station in the broadcasting-satellite service by simple domestic installations and in particular those possessing small antennas.

1.130 *community reception* (in the broadcasting-satellite service): The reception of emissions from a space station in the broadcasting-satellite service by receiving equipment, which in some cases may be complex and have antennas larger than those used for *individual reception*, and intended for use:

- by a group of the general public at one location; or
- through a distribution system covering a limited area.

1.134 *telecommand*: The use of *telecommunication* for the transmission of signals to initiate, modify or terminate functions of equipment at a distance.

Section VI – Characteristics of emissions and radio equipment

1.137 *radiation*: The outward flow of energy from any source in the form of *radio waves*.

1.138 *emission*: *Radiation* produced, or the production of *radiation*, by a radio transmitting station.

For example, the energy radiated by the local oscillator of a radio receiver would not be an emission but a *radiation*.

1.139 *class of emission*: The set of characteristics of an *emission*, designated by standard symbols, e.g. type of modulation of the main carrier, modulating signal, type of information to be transmitted, and also, if appropriate, any additional signal characteristics.

1.140 *single-sideband emission*: An amplitude modulated *emission* with one sideband only.

1.141 *full carrier single-sideband emission*: A *single-sideband emission* without reduction of the carrier.

1.142 *reduced carrier single-sideband emission*: A *single-sideband emission* in which the degree of carrier suppression enables the carrier to be reconstituted and to be used for demodulation.

1.143 *suppressed carrier single-sideband emission*: A *single-sideband emission* in which the carrier is virtually suppressed and not intended to be used for demodulation.

1.144 *out-of-band emission**: *Emission* on a frequency or frequencies immediately outside the *necessary bandwidth* which results from the modulation process, but excluding *spurious emissions*.

1.145 *spurious emission**: *Emission* on a frequency or frequencies which are outside the *necessary bandwidth* and the level of which may be reduced without affecting the corresponding transmission of information. Spurious emissions include harmonic *emissions*, parasitic *emissions*, intermodulation products and frequency conversion products, but exclude *out-of-band emissions*.

1.146 *unwanted emissions**: Consist of *spurious emissions* and *out-of-band emissions*.

1.146A *out-of-band domain* (of an emission): The frequency range, immediately outside the necessary bandwidth but excluding the *spurious domain*, in which *out-of-band emissions* generally predominate. *Out-of-band emissions*, defined based on their source, occur in the out-of-band domain and, to a lesser extent, in the *spurious domain*. *Spurious emissions* likewise may occur in the out-of-band domain as well as in the *spurious domain*. (WRC-03)

1.146B *spurious domain* (of an emission): The frequency range beyond the *out-of-band domain* in which *spurious emissions* generally predominate. (WRC-03)

* The terms associated with the definitions given by Nos. **1.144**, **1.145** and **1.146** shall be expressed in the working languages as follows:

Numbers	In French	In English	In Spanish
1.144	Emission hors bande	Out-of-band emission	Emisión fuera de banda
1.145	Rayonnement non essentiel	Spurious emission	Emisión no esencial
1.146	Rayonnements non désirés	Unwanted emissions	Emisiones no deseadas

1.147 *assigned frequency band*: The frequency band within which the *emission* of a *station* is authorized; the width of the band equals the *necessary bandwidth* plus twice the absolute value of the *frequency tolerance*. Where *space stations* are concerned, the assigned frequency band includes twice the maximum Doppler shift that may occur in relation to any point of the Earth's surface.

1.148 *assigned frequency*: The centre of the frequency band assigned to a *station*.

1.149 *characteristic frequency*: A frequency which can be easily identified and measured in a given *emission*.

A carrier frequency may, for example, be designated as the characteristic frequency.

1.150 *reference frequency*: A frequency having a fixed and specified position with respect to the *assigned frequency*. The displacement of this frequency with respect to the *assigned frequency* has the same absolute value and sign that the displacement of the *characteristic frequency* has with respect to the centre of the frequency band occupied by the *emission*.

1.151 *frequency tolerance*: The maximum permissible departure by the centre frequency of the frequency band occupied by an *emission* from the *assigned frequency* or, by the *characteristic frequency* of an *emission* from the *reference frequency*.

The frequency tolerance is expressed in parts in 10^6 or in hertz.

1.152 *necessary bandwidth*: For a given *class of emission*, the width of the frequency band which is just sufficient to ensure the transmission of information at the rate and with the quality required under specified conditions.

1.153 *occupied bandwidth*: The width of a frequency band such that, below the lower and above the upper frequency limits, the *mean powers* emitted are each equal to a specified percentage $\beta/2$ of the total *mean power* of a given *emission*.

Unless otherwise specified in an ITU-R Recommendation for the appropriate *class of emission*, the value of $\beta/2$ should be taken as 0.5%.

1.154 *right-hand (clockwise) polarized wave*: An elliptically- or circularly-polarized wave, in which the electric field vector, observed in any fixed plane, normal to the direction of propagation, whilst looking in the direction of propagation, rotates with time in a right-hand or clockwise direction.

1.155 *left-hand (anticlockwise) polarized wave*: An elliptically- or circularly-polarized wave, in which the electric field vector, observed in any fixed plane, normal to the direction of propagation, whilst looking in the direction of propagation, rotates with time in a left-hand or anticlockwise direction.

1.156 *power*: Whenever the power of a radio transmitter, etc. is referred to it shall be expressed in one of the following forms, according to the class of *emission*, using the arbitrary symbols indicated:

- *peak envelope power* (PX or pX);
- *mean power* (PY or pY);
- *carrier power* (PZ or pZ).

For different *classes of emission*, the relationships between *peak envelope power*, *mean power* and *carrier power*, under the conditions of normal operation and of no modulation, are contained in ITU-R Recommendations which may be used as a guide.

For use in formulae, the symbol p denotes power expressed in watts and the symbol P denotes power expressed in decibels relative to a reference level.

1.157 *peak envelope power* (of a radio transmitter): The average power supplied to the antenna transmission line by a transmitter during one radio frequency cycle at the crest of the modulation envelope taken under normal operating conditions.

1.158 *mean power* (of a radio transmitter): The average power supplied to the antenna transmission line by a transmitter during an interval of time sufficiently long compared with the lowest frequency encountered in the modulation taken under normal operating conditions.

1.159 *carrier power* (of a radio transmitter): The average power supplied to the antenna transmission line by a transmitter during one radio frequency cycle taken under the condition of no modulation.

1.160 *gain of an antenna*: The ratio, usually expressed in decibels, of the power required at the input of a loss-free reference antenna to the power supplied to the input of the given antenna to produce, in a given direction, the same field strength or the same power flux-density at the same distance. When not specified otherwise, the gain refers to the direction of maximum *radiation*. The gain may be considered for a specified polarization.

Depending on the choice of the reference antenna a distinction is made between:

- a) absolute or isotropic gain (G_i), when the reference antenna is an isotropic antenna isolated in space;
- b) gain relative to a half-wave dipole (G_d), when the reference antenna is a half-wave dipole isolated in space whose equatorial plane contains the given direction;
- c) gain relative to a short vertical antenna (G_v), when the reference antenna is a linear conductor, much shorter than one quarter of the wavelength, normal to the surface of a perfectly conducting plane which contains the given direction.

1.161 *equivalent isotropically radiated power (e.i.r.p.)*: The product of the power supplied to the antenna and the antenna gain in a given direction relative to an isotropic antenna (*absolute or isotropic gain*).

1.162 *effective radiated power (e.r.p.)* (in a given direction): The product of the power supplied to the antenna and its *gain relative to a half-wave dipole* in a given direction.

1.163 *effective monopole radiated power (e.m.r.p.)* (in a given direction): The product of the power supplied to the antenna and its *gain relative to a short vertical antenna* in a given direction.

1.164 *tropospheric scatter*: The propagation of *radio waves* by scattering as a result of irregularities or discontinuities in the physical properties of the troposphere.

1.165 *ionospheric scatter*: The propagation of *radio waves* by scattering as a result of irregularities or discontinuities in the ionization of the ionosphere.

For all definitions and terminology see the ITU database:

<http://www.itu.int/ITU-R/go/terminology-database>.
