

REPORT ITU-R BT.2069

Spectrum usage and operational characteristics of terrestrial electronic news gathering (ENG), television outside broadcast (TVOB) and electronic field production (EFP) systems

(2006)

1 Introduction

This Report provides information on the current status of terrestrial electronic news gathering (ENG), television outside broadcast (TVOB) and electronic field production (EFP) systems.

It was developed by the former ITU-R Working Party 6P (now Working Party 6J) in response to WRC-03 agenda item 7.1 (Recommendation 723 (WRC-03)).

Member States, Sector Members, television broadcasters and organizations involved in terrestrial electronic news gathering (ENG), television outside broadcast (TVOB) and electronic field production (EFP) systems contributed to its development.

An input contribution to Working Party 6J from the United States of America (6J/28) stated:

“The Report provides excellent illustrations of how spectrum is utilized in the production of programmes for news, disaster reporting, sports, and entertainment. The interest of the public is served by live coverage of events especially those situations affecting public safety and national security. Improvements in quality and enhanced impact of programmes are facilitated by the use of non-wired technologies including point-of-view (POV) cameras and wireless microphones. Wireless devices for programme content production are providing the viewer with ever increasing opportunities to experience the coverage of live and realistic situations throughout the world. These devices rely heavily upon spectrum allocations beyond those primary allocations for broadcasting. The allocations include SAP (Services Ancillary to Programme making) and SAB (Services Ancillary to Broadcasting) as defined in the Report as well as fixed, mobile, and satellite services.

The preliminary draft new Report provides administrations with insights into the importance of spectrum usage by broadcasters and other programme content providers.”

Similarly a contribution from the North American Broadcaster’s Association stated:

“The public interest is served by live news coverage of breaking events, especially disasters or potential disasters affecting public safety and national security. The public is served by broadcasters’ increasing use of a visual intimacy and immediacy in such things as medical news, disaster reporting, and sporting events that can only be delivered via non-wired technologies such as live point-of-view (POV) cameras and wireless microphones. The broadcaster in developing programme content relies heavily upon the use of spectrum beyond those bands primarily allocated to broadcasting.

NABA continues to express serious concerns regarding the unregulated use of indoor, mobile, and hand-held systems that cause interference to radiocommunication services in support of broadcast systems. NABA strongly supports the protection of Broadcast Auxiliary Service (BAS) spectrum.

The Report illustrates the critical need to coordinate and protect the spectrum on an international basis.”

To develop this Report Working Party 6J established a Rapporteur who was to study¹:

- the technical, operational and frequency issues of ENG on a global basis;
- whether digitization may provide an opportunity for more efficient spectrum usage for ENG that could assist with meeting a growing demand for spectrum by these systems;
- provision of adequate and appropriate spectrum to meet the needs of broadcasters including the temporary needs of visiting broadcasters of other administrations.

This Report has been used as the basis for advancing studies in ITU-R on terrestrial electronic news gathering (ENG), television outside broadcast (TVOB) and electronic field production (EFP) systems.

It is provided as guidance for Members States, Sector Members, television broadcasters and organizations seeking to implement ENG, TVOB and EFP systems.

2 Background

In many administrations television has emerged as the primary delivery method of news to the general public.

Initially film was the major medium for the capture of news events. However, with film there were time delays associated with the transport and handling of film. The availability of high quality terrestrial ENG equipment changed that situation. The advances in television news coverage over the lifetime of television has led to a high level of expectation on the part of the consumer for a comprehensive and instant coverage of news events on television.

In many instances material goes “live to air”, a factor which demands the certainty of an interference free radio-frequency spectrum channel for the duration of the event. Indeed the presentation of a news story as “live” (the “live eye” concept) has become an objective for news bulletins. Such is the demand for immediacy by the public.

The viewing population of television audience coverage/service areas has also increased considerably since the present radio-frequency spectrum allocations for terrestrial ENG were identified. This has produced the twofold effect of increasing the probability of occurrence of news worthy events whilst also increasing the number of camera crews, vehicles and hence radio-frequency spectrum transmission channels which are needed to cover wider areas.

While there is a continuing increase in demand for the quantity and quality of coverage of outside events which television organizations/networks are required to provide, this increase in demand must be met often from within the same radio-frequency spectrum resource that was justified on the basis of the requirements developed several decades ago.

3 Definitions of SAP/SAB and ENG/OB

Definitions for ENG and TVOB were agreed some time ago. However, originally they referred only to video reporting services. Later it became obvious that ENG/OB definitions should also accommodate the sound reporting applications. As a result radiocommunication agencies proposed

¹ Refer Administrative Circular CA/131.

additional amendments to these definitions. Trying to combine all these various references into an overall picture, the following definition of ENG/OB is proposed:

ENG: Electronic news gathering (ENG) is the collection of video and/or sound material without the use of film or tape recorder, using small, often handheld, electronic cameras and/or microphones with radio links to the news room and/or to the portable tape or other recorders.

OB: Outside broadcasting (OB) is the temporary provision of programme making facilities at the location of ongoing news, sport or other events, lasting from a few hours to several weeks. Outside broadcasts are generally planned in advance, but it is often necessary to accommodate short notice changes of venue or unforeseen requirements. Video and/or sound reporting radio links (channels) might be required for mobile links, portable links and cordless cameras or microphones at the OB location. Additionally, video and/or sound reporting radio links may be required as part of a temporary point to point connection between the OB vehicle and the studio.

It can be seen that the definitions of ENG and OB are not mutually exclusive. Certain operations could equally well reside in either or both categories. Therefore, to avoid confusion, it has been a long practice within the administrations to consider all types of such operations under the combined term “ENG/OB/BAS/SAP/SAB”. It is also understood that these applications refer to terrestrial radiocommunication services, as opposed to SNG/OB terminology, which refers to similar applications but over the satellite radiocommunication channels.

For better understanding of differences between ENG and OB, Figs. 1 and 2 show typical operational set-ups for those two scenarios of broadcasting activities.

FIGURE 1
Typical set-up of ENG operations

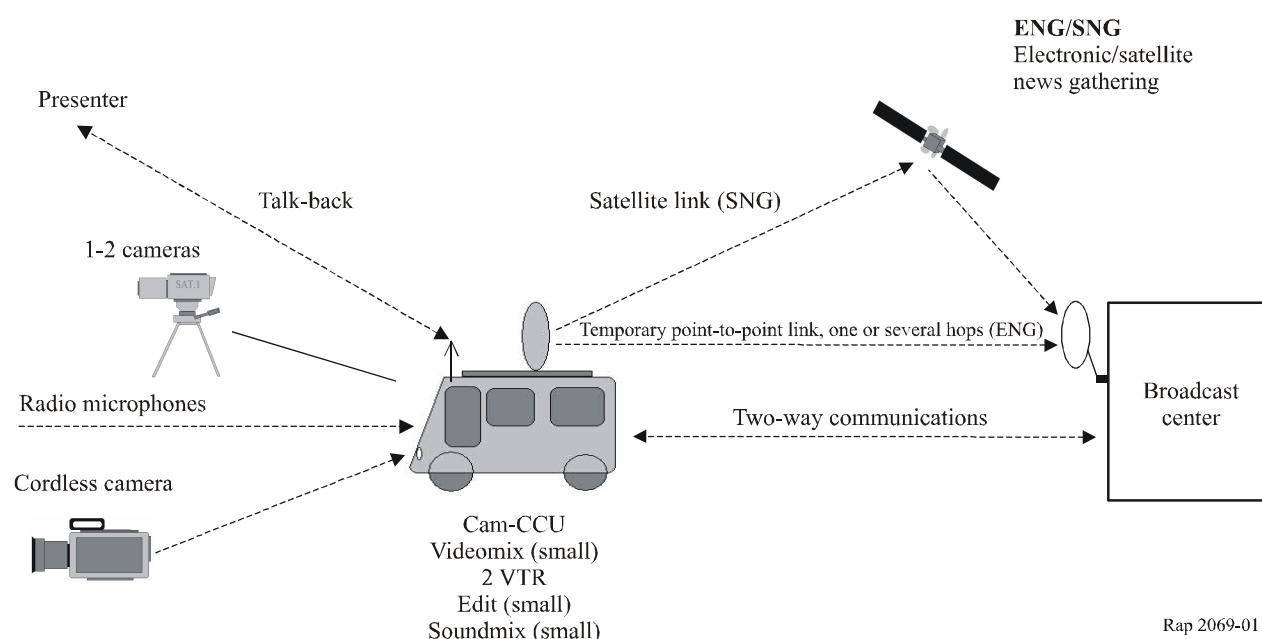
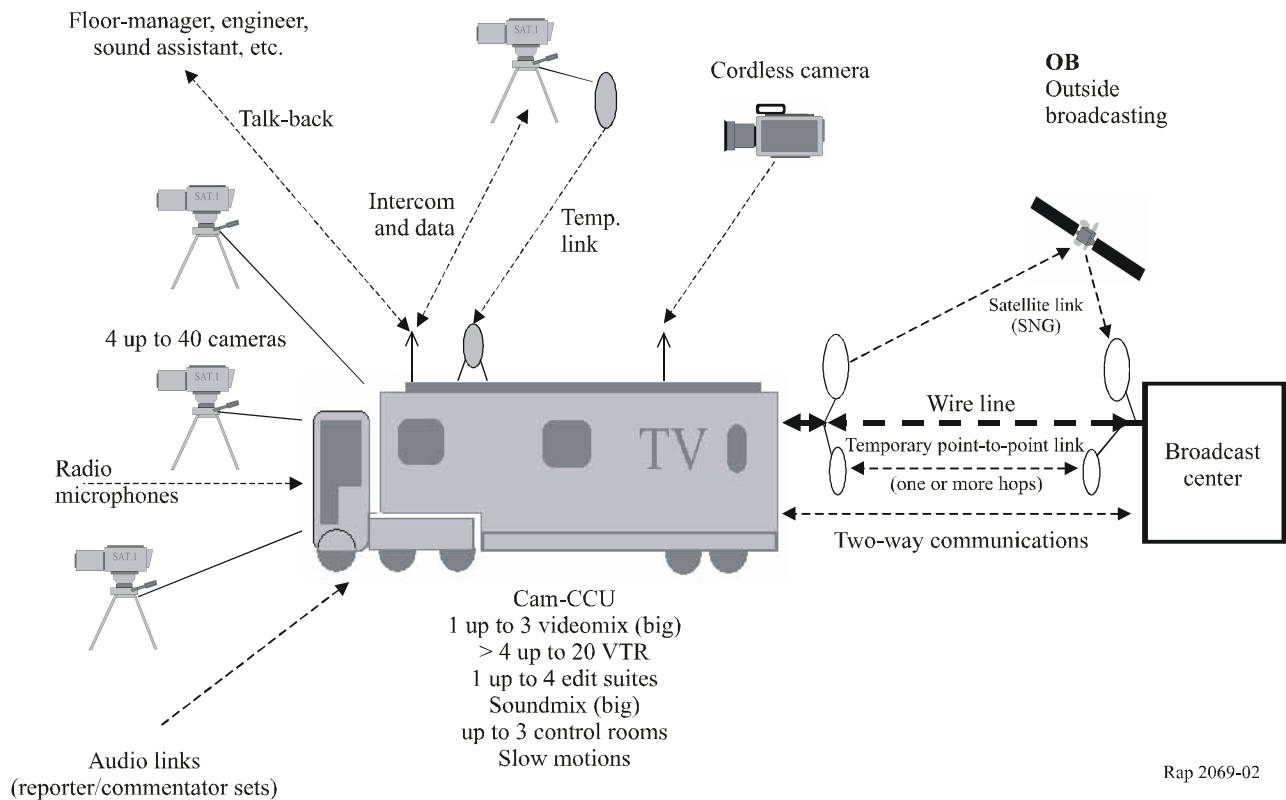

FIGURE 2
Typical set-up of OB operations



The definitions of SAP/SAB are set out as follows:

SAP²: Services ancillary to programme making (SAP) support the activities carried out in the making of “programmes”, such as film making, advertisements, corporate videos, concerts, theatre and similar activities not initially meant for broadcasting to general public.

SAB³: Services ancillary to broadcasting (SAB) support the activities of broadcast service companies carried out in the production of their programme material.

Services ancillary to broadcasting (SAB) were originally only those required by public broadcasting companies in the preparation of programme material, while services ancillary to programme making (SAP) covered programme making by independent companies along with the commercials, theatre shows, concerts and sporting events. While there are some differences in the nature of these two businesses, their spectrum requirements are almost identical.

Similarly to ENG/OB, it may be seen that the definitions of SAP and SAB are not necessarily mutually exclusive. Therefore they are also often used together as “SAP/SAB” to refer generally to the whole variety of services to transmit sound and video material over the radio links.

However, it is important to note that in such broad understanding, the SAP/SAB services include both ENG/OB and SNG/OB applications, but also the service links that may be used in the production of programmes, such as talk-back or personal monitoring of sound-track, telecommand, telecontrol and similar applications. Assuming all of the above definitions and comments, the

² In some parts of the world SAP has a reference to an alternative service such as second audio programme.

³ In some parts of the world SAB is referred to as BAS.

following gives detailed presentation of different applications possible within the above categories and links between them.

3.1 Overall picture of SAP/SAB world of applications

As mentioned before, the SAP/SAB definitions imply more business-oriented classification of programme making facilities. The technical view then adds another dimension to that picture because many SAP and SAB users use the same technology for their applications. Therefore, the following picture in Fig. 3 describes this two-layered structure of the whole world of SAP and SAB, including ENG/OB applications.

The following definitions are assumed in describing the technology layer of various SAP/SAB applications:

Radio microphone	Handheld or body worn microphone with integrated or body worn transmitter.
In-ear monitor	Body-worn miniature receiver with earpieces for personal monitoring of single or dual channel sound track.
Portable audio link	Body worn transmitter used with one or more microphones, with a longer operating range capabilities than that of radio microphones.
Mobile audio link	Audio transmission system employing radio transmitter mounted in/on motorcycles, pedal cycles, cars, racing cars, boats, etc. One or both link terminals may be used while moving.
Temporary point-to-point audio link	Temporary link between two points (e.g. part of a link between an OB site and a studio), used for carrying broadcast quality audio or for carrying service (voice) signals. Link terminals are mounted on tripods, temporary platforms, purpose built vehicles or hydraulic hoists. Two-way links are often required.
Cordless camera	Handheld or otherwise mounted camera with integrated transmitter, power pack and antenna for carrying broadcast-quality video together with sound signals over short-ranges.
Portable video link	Handheld camera with separate body-worn transmitter, power pack and antenna.
Mobile airborne video link	Video transmission system employing radio transmitter mounted on helicopters or other airships.
Mobile vehicular video link	Video transmission system employing radio transmitter mounted in/on motorcycles, pedal cycles, cars, racing cars or boats. One or both link terminals may be used while moving.
Temporary point-to-point video links	Temporary link between two points (e.g. part of a link between an OB site and a studio), used for carrying broadcast quality video/audio signals. Link terminals are mounted on tripods, temporary platforms, purpose built vehicles or hydraulic hoists. Two-way links are often required.
Talk-back	For communicating the instructions of the director instantly to all those concerned in making the programme; these include presenters, interviewers, cameramen, sound operators, lighting operators and engineers. A number of talk-back channels may be in simultaneous use to cover those different activities. Talk-back usually employs constant transmission.
Telecommand/remote control	Radio links for the remote control of cameras and other programme-making equipment and for signalling.

FIGURE 3
Overall picture of SAP/SAB user sectors and applications

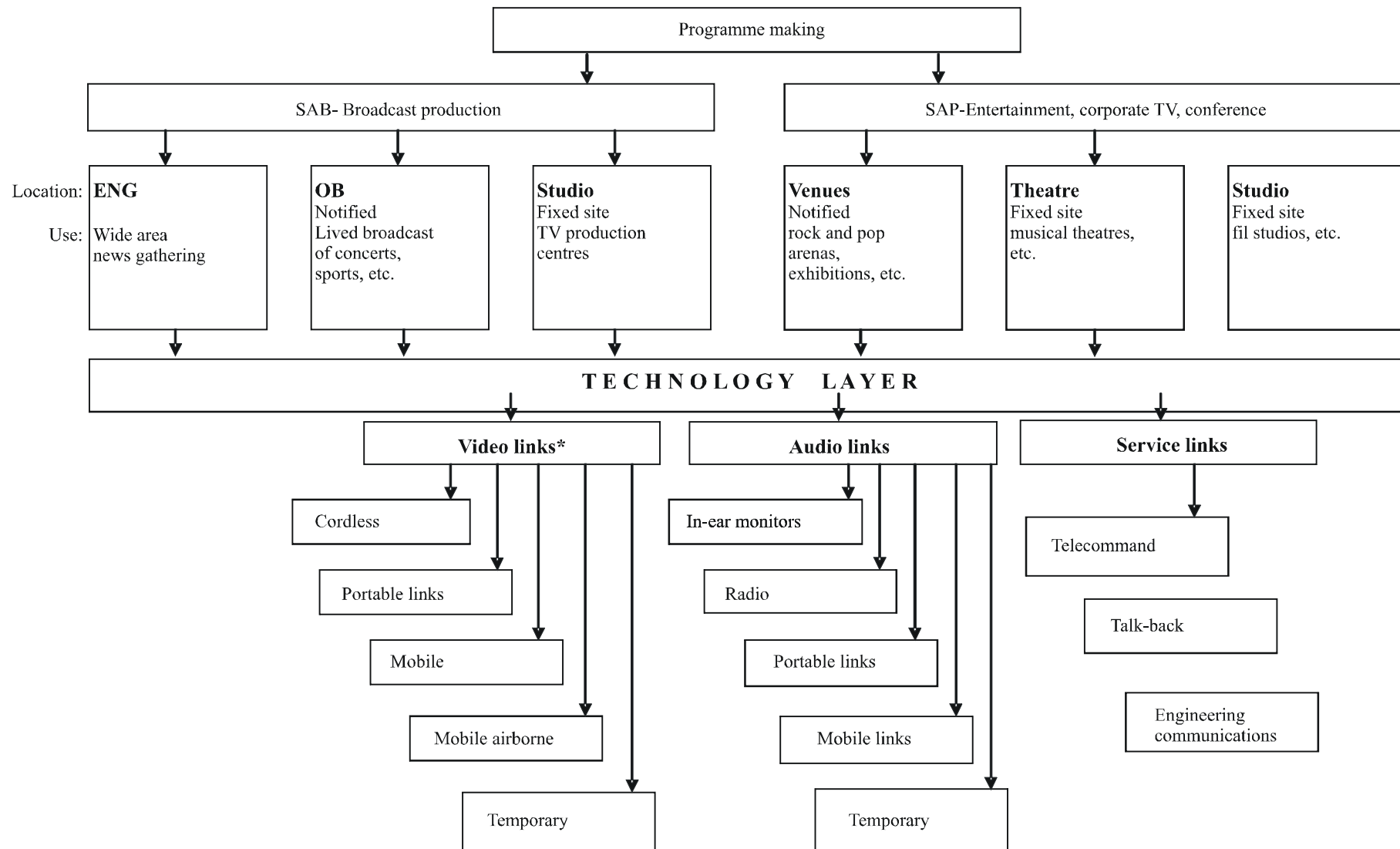

* Note – Video links often incorporate audio circuits for sound programme transmission.

3.2 Distinction between radio microphones and in-ear monitors (IEM)

Radio microphones normally use wideband frequency modulation to achieve the necessary audio performance for professional use. For the majority of applications the transmitted signal requires a channel bandwidth of up to 200 kHz.

IEM equipment is used by stage and studio performers to receive personal fold back (monitoring) of the performance. This can be just their own voice or a complex mix of sources. The bandwidth requirement of professional IEM equipment is up to 300 kHz.

The comparison of different specifications and operational requirements of radio microphones and IEM is given in Table 1.

TABLE 1
Comparison of radio microphones and in-ear monitors

Characteristics	Radio microphones	IEM (in-ear monitors)
Application	Voice (speech, song), music instruments	Voice or mixed feedback to stage
Transmitter		
Placement of a transmitter	Body worn or handheld	Fixed base
Power source	Battery	AC mains
Transmitter RF-output power	< 30 mW	50 mW
Transmitter audio input	Microphone level	Line level
Receiver		
Placement of a receiver	Fixed/camera mounted	Body worn
Power source	AC mains/battery	Battery
Receiver audio output	Line level	Earphone
Receiver type	Single or diversity	Single
General		
Battery/power pack operation time	> 4-8 h	
Audio frequency response	≤ 80 to ≥ 15.000 Hz	
Audio mode	Mono	MPX-stereo
RF frequency ranges	TV Bands III/IV/V, 1.8 GHz	TV Bands III/IV/V, 1.8 GHz (See Note 1)
Signal to noise ratio (optimal/possible)	> 100/119 dB	> 60/110 dB
Modulation	FM wideband	
RF peak deviation (AF = 1 kHz)	±50 kHz	
RF bandwidth	≤ 200 kHz	≤ 300 kHz
Useable equipment/channel (ΔRF = 8 MHz)	> 12	6...8

NOTE 1 – IEM may be also used in 863-865 MHz if complying with EN 301 357.

It is important to note these differences when assigning operating frequencies to IEM, as opposed to radio microphones.

4 Spectrum requirements for electronic news gathering

The radio-frequency spectrum bands used for ENG are usually microwave bands used by the television industry for temporary video link transmissions. The core use of the ENG bands relates to the operation of mobile ENG vans, involving in some cases the use of helicopter relays⁴, for the collection of news stories.

The very nature of news gathering in a competitive environment implies a high probability that several television broadcasters/organizations/networks will be attempting to cover the same situation. This requires several channels to operate simultaneously over virtually the same path.

There are many types of news events which give rise to this concentration of reporting which go beyond the “spectacular” or “disaster” class of news stories. Commonly occurring events such as the arrival of visiting dignitaries, press conferences, etc. all lead to a high level simultaneous demand on the radio-frequency spectrum resource.

Another aspect of terrestrial ENG usage is the production of current affairs material. Whilst the television organization/network will usually have control over the timing and location of such an event, it cannot be constrained by the availability of an ENG connection and therefore reliance on alternative radio-frequency spectrum bands for the collection of such material is not desirable.

The further use of the radio-frequency spectrum allocated to ENG bands is the coverage of major events, particularly sport. Unlike news stories this coverage is pre-planned, thereby providing the opportunity, and in the case of large events, the necessity of “borrowing” of channels and even equipment from other television organizations/networks.

Television organizations around the world have developed operational practices which have yielded greater productivity from the radio-frequency spectrum bands used for terrestrial ENG:

- Sharing – use by one licensee of a channel or channels in a band allocated to another by prior agreement for a period of time when it is not required by the primary licensee. The scope for this form of sharing however is limited because of the unpredictable nature of the ENG requirement, and by the fact that there is often a requirement for simultaneous coverage of a news story by several networks.
- Increased geographical deployment – reuse of frequencies through the establishment of additional pick up points around large cities.

Broadcasters are now considering reduction in transmission bandwidths within the radio-frequency spectrum bands assigned to ENG via reduced deviation analog frequency modulation (FM) and the eventual migration to digital modulation schemes. These might also result in improved productivity. However these potential gains are offset against the increased demand for higher quality contribution material required for digital television services, including high definition television (HDTV).

4.1 Current and future demand for SAP/SAB spectrum

The following is an analysis based upon European studies on the demand for programme making and special events spectrum and demand for audio reporting links.

⁴ The operation of a helicopter relay requires two frequencies, the occurrence of a major news story beyond the limits of a single hop from the central pick-up point is likely to involve the simultaneous use of several channels within one band or several bands.

4.1.1 SAP/SAB sectors addressed

Discussion of SAP/SAB spectrum demand is divided into several subsections, characterizing several distinctive sectors of programme making activities, along with the principles depicted at the business layer in Fig. 3. These sectors are:

- theatres and touring shows;
- studio production;
- television news gathering;
- sound broadcast;
- casual sport events and similar outside broadcasts;
- special events (i.e. large outside broadcasts).

The scope of each sector development may vary from country-to-country, therefore the aggregate figures of expected SAP/SAB spectrum demand may be adjusted accordingly for each specific country.

All of those sectors are poised to see growth in the future. The latest trends in society towards expanding consumption of TV programming and other (multimedia) entertainment will require an increasing radiocommunication infrastructure to support the additional programme making. This includes the expansion of television with digital, cable and satellite, and the future introduction of interactive TV, but also covers the Internet, which, as it goes broadband, will increasingly include sound and video programming.

It should be also noted that some administrations have enacted legislative requirements to produce a greater percentage of broadcast material within the community.

Other societal trends that may have a significant impact on the development of different SAP/SAB sectors include changes in programming style for TV, changes in coverage style and priorities for TV sport, changes in musical theatre and other sorts of theatre, changes in production budgets and staffing levels, etc. SAP/SAB is very dynamic as television producers continually seek new experiences for audiences, with consequential changes in demand for spectrum. Such requests need to be considered against the benefits and needs of other services and other SAP/SAB applications.

Technological trends and changes, which may be relevant for changing demand for SAP/SAB spectrum, include:

- the introduction of digital video links, for both point-to-point and mobile links;
- the introduction of digital radio microphones;
- the introduction of narrow-band technology for talk-back;
- possibilities to use in programme contribution public networks, like TETRA, GSM, UMTS, etc.

4.1.2 Peak vs. aggregate demand

SAP/SAB use in most cases may be characterized as having a high degree of locality, as it is normally confined to the limits of specific locality, where programme making takes place, or even to limits of a single building, like theatre, TV studio, etc. Therefore the demand for SAP/SAB radio spectrum normally occurs in parallel. For example if events in two cities have a demand for spectrum, the total demand for spectrum is equal to the larger of the two demands.

Similarly, if events on different days each have a demand for spectrum, the overall demand for spectrum is again equal to the larger of the two demands, as spectrum used for one purpose on one day can be reused for another purpose on another day.

Demand measured in this way is *peak* demand and is the correct measure to use to determine whether current spectrum assignments are sufficient. An alternative measure is *aggregate* demand, where spectrum demands are added together even where spectrum can be reused. This measure might be used to predict the total income from spectrum licence fees, for example. Attempts to predict aggregate demand would require quite different methods than used in this study.

Throughout this whole Report any discussion of spectrum demand assumes reference to peak demand. Expressed in such way, spectrum demand may be characterized by simply considering the most heavy users of radio spectrum (e.g. in major conurbations) and assuming that the smaller users (e.g. regional users) will be able to reuse the same spectrum well within the total amount designated as a peak demand.

To illustrate this schematically, a graph can be drawn of spectrum demand against time and place. The horizontal axis represents different times and/or places, although there is no sense of an increase in either time or place when moving to the right – it merely represents *different* times and/or places. The vertical axis represents spectrum demand. Example in Fig. 4 shows this with two rectangles, one representing schematically the way demand might arise for outside broadcasts, the other doing the same for TV news.

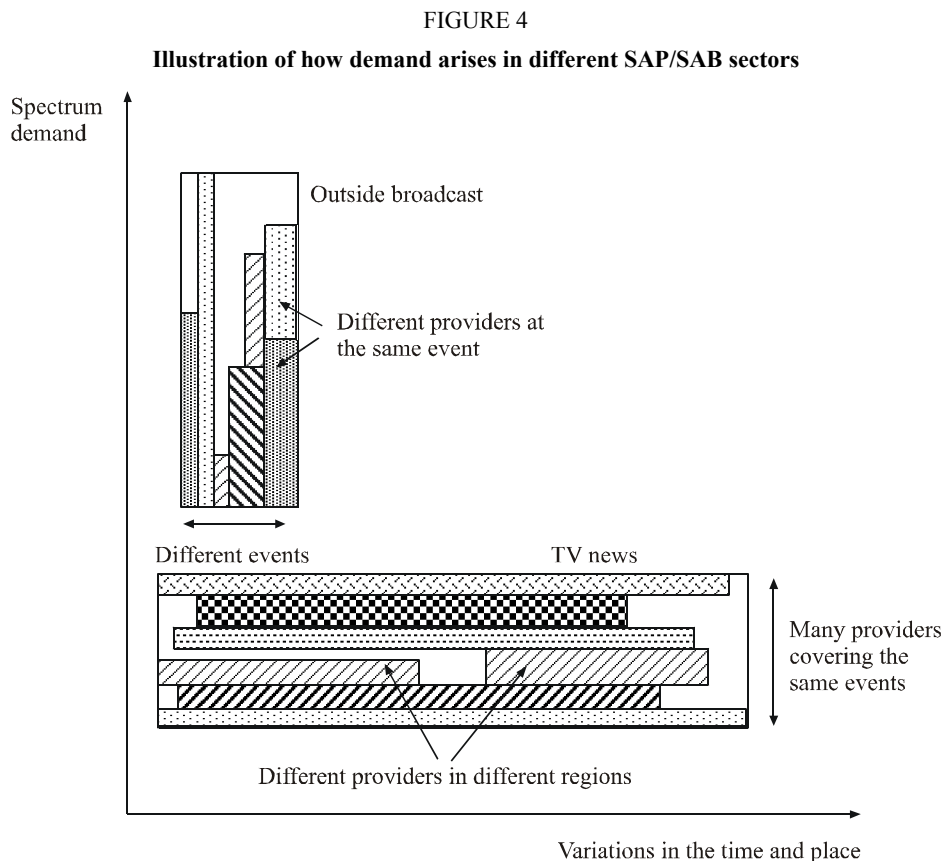

Rap 2069-04

Spectrum can be reused at different outside broadcast events, so each event has a different rectangle, and the rectangles are placed side-by-side. Demand at a single outside broadcast event is quite high so the height of each rectangle is large, but the demand is localized in time and space so the width of each rectangle is small. Where two or more broadcasters visit the same event, their rectangles have to be stacked on top of each other as they cannot use the same spectrum. Similar principles apply to demand from theatres and studios.

However for ENG applications, each broadcaster usually has to have its own spectrum, which it can use anywhere in time and space (within certain limits). This is because broadcasters need to be able to go anywhere at any time without booking frequencies first. Each broadcaster has relatively few frequencies, so the rectangles have small height, but can use those frequencies over a wide range of times and places, so the rectangles are wide.

Different broadcasters need to be able to visit the same event at the same time, so the rectangles representing different broadcasters have to be stacked on top of each other to obtain the overall demand for the sector. If two broadcasters operate in two sufficiently separated regions, they can share spectrum, so their rectangles can appear side-by-side.

Therefore the whole of the SAP/SAB use may be illustrated as shown in Fig. 5. Each sector has its own rectangle, representing its demand.

Demand from ENG users has to be added to demand from the other sectors as these sectors require a “go anywhere” capability (in time and within a geographical region), so they have allocations, which are separate from all other users. The same spectrum cannot (for example) be used by a theatre and for newsgathering, as the news gatherers require the capability to use spectrum at the same time and place as the theatre. However, as spectrum can normally be reused between theatres, studios and outside broadcasts, so their rectangles are separated horizontally rather than stacked vertically.

The total demand for SAP/SAB spectrum is therefore equal to the sum of the demands for TV news, radio and the largest of theatres, studios and outside broadcasts.

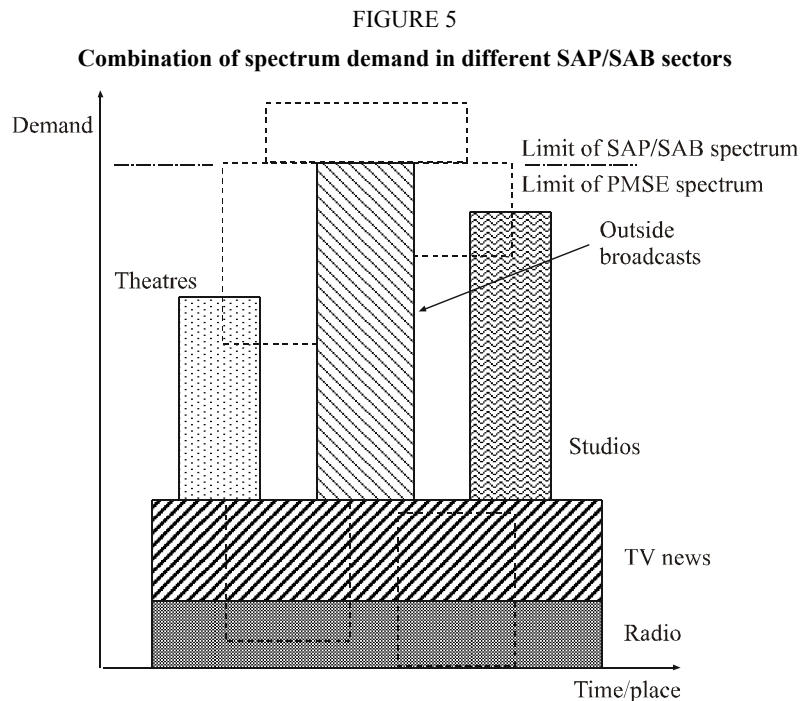

In fact, outside broadcast demand can be so heavy that spectrum is sometimes borrowed from the other sectors, and/or from outside the SAP/SAB allocations. This is shown by the additional dotted rectangles, which represent how outside broadcast might intrude on other radio services' spectrum.

4.1.3 Demand for theatres and touring shows

Theatres, concert venues and other auditoria of all sizes, both amateur and professional, use radio microphones and to a lesser extent, in-ear monitoring systems and talk-back. Applications include drama, musical theatre, rock concerts, corporate events and amateur uses (for example for drama, concerts and shows, and in churches).

Spectrum demand is heaviest for large-scale, professional productions, and for touring musicals and rock concerts, and it is these areas on which the following discussion concentrates. Typically, this kind of usage will be most prominent in the locations with highest density of professional theatres and entertainment venues.

Studies show that currently the heavy peak spectrum demand for a single theatre production may be as high as 45-55 wideband channels (radio microphones and in-ear monitors) and 5-10 narrow-band channels for talk-back and similar communications. Analysis shows that these figures of demand in theatres are not expected to grow significantly over the coming years, due to certain physical limits of manageability of that many signals.

Analysis of typical requirements for the touring shows, e.g. rock and pop concerts, suggests that for such touring productions channel demand may be in the order of 20-40 wideband channels, in a mixed active (60%) and standby (40%) assignment. One particular example considered in detail showed, that radio microphones would take around 25% of the channels, while the rest would be divided almost equally by in-ear monitors and instrument (guitar) pick-ups.

It may be further noted that in theatres the demand for in-ear monitors is insignificant and not likely to increase. However the situation is the opposite for rock and pop and similar concerts, where demand for in-ear monitors in terms of a number of necessary channels prevail over demand for radio microphones. This implies, that the same aforementioned maximum of 45-55 wideband channels may satisfy the needs of both theatres and concerts, but divided in appropriate proportions for different applications (radio microphones vs. in-ear monitors), as required by specific profile of necessary sound support.

Much of SAP/SAB operations had been short range and able to share spectrum with other services on a geographical basis. This may not always prove to be the case in the future and some reassessment of the balance between frequency reuse and area coverage may be required.

4.1.4 Demand for studio production

Studios use radio for talk-back, microphones, in-ear monitors for presenters, and (potentially, but not at present) cordless cameras. The reason for using radio is to give freedom of movement within the studio.

European studies show that currently spectrum demand by studio productions might be as high as 10-15 wide bandwidth channels (radio microphones and in-ear monitors) and 5-10 narrow-band channels (talk-back) for a single large studio. These figures should be increased up to 50-100 wideband and 30-70 narrow-band channels for large studio buildings, incorporating number of studios under one roof.

It is further foreseen that within the next decade the demand for wideband radio channels in a studio will approximately double, requiring around 20 channels per studio, or up to some 200 per large studio building. These figures are based on estimates from European studies.

It may be noted that substantial over-provision of microphones and frequencies is common in studio buildings. Typically every studio will have its own microphones and frequencies, with some spares to be used as "top-up", rather than having fewer frequencies with a pool system relying on not all studios being operative at any one time. This shows that the demand for spectrum may be

significantly reduced if a spectrum management discipline could be imposed on the management of radio equipment at the large studio buildings.

One trend may be that of transferring more and more of traditional studio work out to locations. This might move the desired number and type of channels towards the requirements described in § 4.1.7.

4.1.5 Demand for TV news (ENG)

TV news providers use radio links in order to provide rapid response coverage of developing news stories. Therefore video links as well as talk-back and radio microphones are used in the production of live and recorded news reports “from the scene”.

Terrestrial radio links, known under the term of ENG, consist of one or more microwave links that feed video and audio signals directly from the news location to broadcaster’s network or studio. ENG links are only one of a number of options used to transfer live or recorded material from location to the studio or network, others including:

- SNG (satellite news gathering) refers to the use of satellite links to achieve the same thing;
- fibre optic links can be used where a location has a fibre termination;
- store-and-forward over public telecommunications lines can be used for non-live inserts;
- similarly non-live inserts can be recorded on tape and carried by motorbike or otherwise to the studio.

Each terrestrial ENG operator (news provider) requires its own exclusive spectrum, for which it requires round-the-clock access over the designated area; there is no scope for event by event coordination as the time taken to respond to a news event is too small.

Terrestrial ENG operators normally operate a number of trucks, which can be quickly dispatched to a location where a news event is taking place. The truck contains all the facilities required to cover the story and transmit the signal back to the studio or network for (where necessary/appropriate) further production, editing and/or transmission.

It is estimated that all together terrestrial ENG operators providing news coverage in the area covering major conurbations with high density of news events (typically capital and other big cities) may require allocation of up to:

- 25-50 talk-back narrow-band channels;
- 15-30 wideband channels for radio microphones;
- 5-10 channels for various video links.

European studies suggest that predictions of future demand for ENG users would depend heavily on the success of digital technology as a major means of video transmission. If the digital technology does not deliver the promised advantages, hence making no significant impact on the sector, then over the next decade increase in spectrum demand for ENG operations would see a modest growth. However if the digital technology delivers on the promised advantages of resilience, quality and ruggedness, then it could mean not only replacing analog links with digital, but also an overall boost to use of video coverage. So, for major conurbations forecasts of future demand for those two scenarios may look like shown in Table 2.

TABLE 2

Two scenarios of forecasted future demand by ENG operations

Type of links	Channels demand within 10 years if digital <u>is not</u> a success	Channels demand within 10 years if digital <u>is</u> a success
Talk-back narrow-band	30-60	30-60
Wideband radio microphones	25-50	25-50
Analog point-to-point video links	5-10	0
Digital point-to-point video links	1-5	10-15
Cordless cameras	1-5	10-15

It is obvious from these figures that if digital technology proves to be successful, then an increase of demand for video links in the longer term may outweigh the gains in spectral efficiency obtained through using narrower channels for digital links.

4.1.6 Demand for sound broadcasters

Local and national sound broadcast stations use SAP/SAB services for newsgathering, traffic reporting, sports reporting, and other applications. Talk-back, radio microphones and audio links are the key services used. However not all stations make significant use of SAP/SAB, in most cases news provision is bought in from specialist news agencies or similar providers.

Therefore SAP/SAB demand for sound broadcast stations is quite modest, the total demand is some ten audio links, five wideband channels for radio microphones and five narrow-band channels for talk-back communications.

Prediction of demand over the next ten years indicate that the number of channels for audio links and for radio microphones may approximately double, totalling to 15-20 audio link channels and 5-10 radio microphones channels.

4.1.7 Demand for casual sport events and similar outside broadcasts

All forms of SAP/SAB applications are used heavily for sports and other outside broadcasts. Such events are divided into two sectors. This section covers routine outside broadcasts, the sort of events, which occur week in, week out up and down the country. Although coordination is needed, difficulties rarely arise and no special planning of frequencies is required. Frequencies do not have to be "borrowed" from other uses to cover events in this section.

Section 4.1.8 deals with major events, which require detailed and specialized planning, sometimes on-the-ground coordination, and sometimes "borrowing" of frequencies from other uses. The distinction should be emphasized that there are many more events in this section than the following one. Therefore it would not be desirable to have to expend the same planning effort that goes into the large events on the events in this section, unless there were clear rewards in terms of spectral efficiency.

It might be estimated that the current spectrum demand for a general sport event per single broadcaster covering that event, could be around:

- 5-10 wideband channels for radio microphones;
- 1 wideband channel for audio link;
- around 10 narrow-band channels for talk-back;

- 1-2 point-to-point video links (2-4 channels if stand-by/duplex are required);
- 1-5 video links by cordless cameras.

However it should be obvious that, if there are more than one broadcaster covering the same event or if several events occur near-by, then the above estimates should be multiplied appropriately. Demand may also increase if for topography or other reasons it might become necessary to duplicate some of the links, or use repeaters, etc.

European studies suggested that forecasts of future spectrum demand for sports and OB sector would depend on future take up of digital technology for video transmissions, as it would be for the above described case of TV news gathering. So Table 3 below shows two scenarios of possible future demand for sports and other outside broadcasts per single event/broadcaster. Demand for sound reporting point-to-point links is derived from European studies in year 2000.

TABLE 3

Two scenarios of forecasted future demand for coverage of daily sports and other routine OB

Type of links	Channels demand within 10 years if digital <u>is not</u> a success	Channels demand within 10 years if digital <u>is</u> a success
Talk-back narrow-band	10-15	10-15
Wideband radio microphones	10-15	10-15
Audio point to point links	2-5	2-5
Analog point-to-point video links	1-2	0
Digital point-to-point video links	1-2	3-5
Mobile and/or cordless cameras	5-8	8-10

By comparing forecasts in Tables 2 and 3 it may be seen that the TV news (ENG) would be more resonant to the success of digital technologies, than the outside broadcasts. This probably may be explained by the fact that outside broadcasts are normally more stationary in their operations, so the need for radio links is not as demanding as for fully mobile ENG operations.

4.1.8 Demand for coverage of major events

Some of the events covered by the outside broadcasts are extraordinary in terms of the attention they attract, their size, large geographical scales, etc. Some examples of such special events are:

- major large-scale sporting events, like marathons, cycle races, etc.;
- major national celebrations, royal weddings and funerals, etc.

The pictures given in Figs. 6 and 7 show a typical case (Vienna 2001 Marathon) of channel demand for video and audio links respectively, by the visiting ENG/OB team covering one of major sporting events.

FIGURE 6
Real case of ENG/OB demand for video channels to cover
Vienna Marathon, 2001 (Courtesy: NOB)

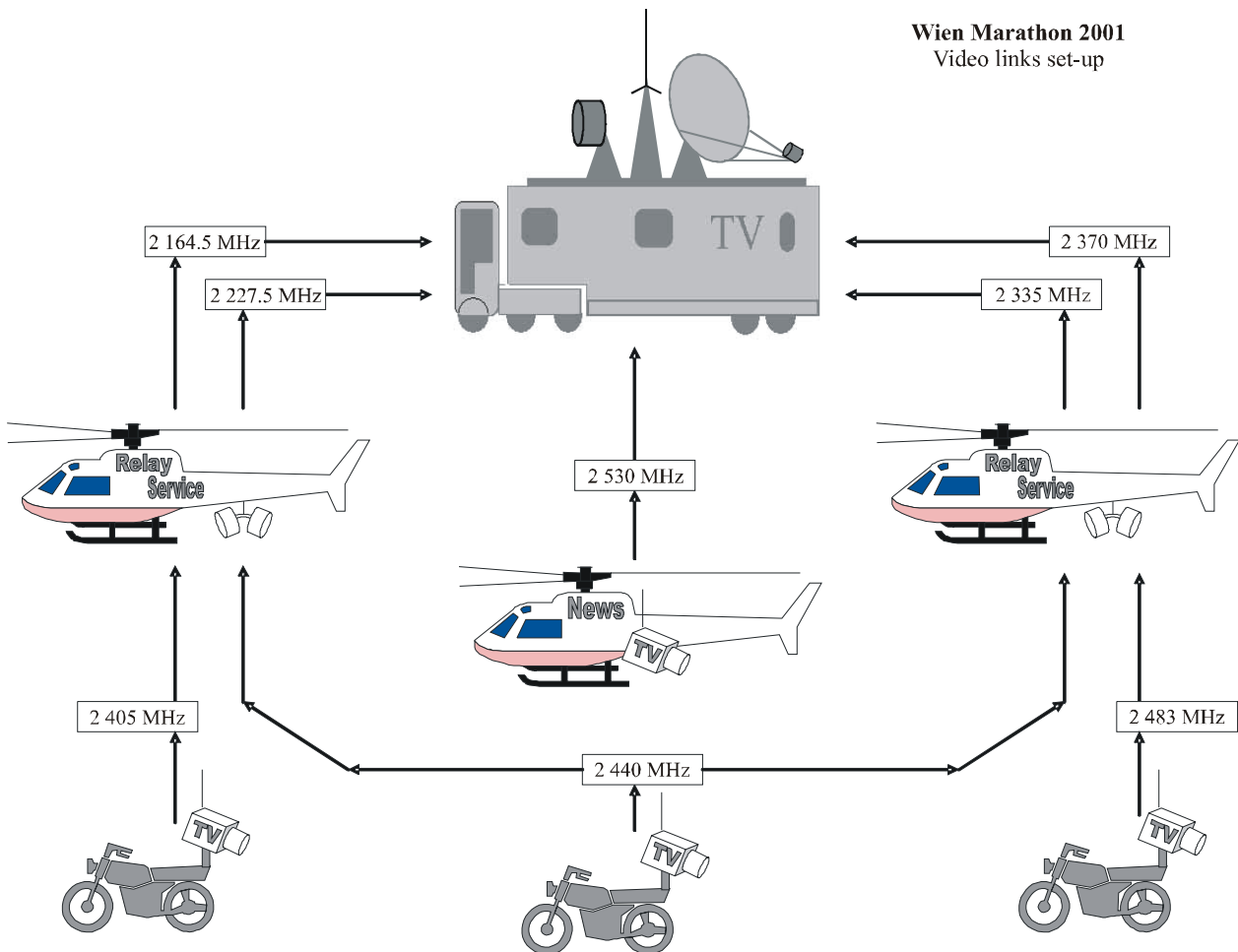

Rap 2069-06

Some administrations have, and are continuing development of industry operational practices for television outside broadcasts. As the television audience increases its interest in a wider variety of sports so the list of operational practices increases. These industry operational practices facilitate the design and development of common configurations in stadiums and maximized the potential and productivity of TV and radio production at sports venues through avoidance of costly omissions at planning and construction stages. These operational practices for television outside broadcasts have been used as a template in meeting the television production requirements for staging many sporting events at a series of venues. The interest by television audiences in globalized coverage of sporting events, modularization and miniaturization of television broadcasting equipment and the transportation of television broadcasting production systems from country-to-country for the coverage of like sports events has resulted in similar trends in harmonization and optimization of television broadcasting operations in many countries.

Such events are the points of greatest demand for SAP/SAB spectrum. However, because of their rarity it seems inappropriate to dimension national SAP/SAB allocations to cope with their demand. Rather, in preparing for such events, spectrum may be borrowed from other users of radio spectrum on a case-by-case basis.

There can be no question of predicting demand for a "typical" event, and there would be no virtue in doing so in order to obtain a band plan, as these events can not always be accommodated by a standard band plan, only by a specific plan for each event.

FIGURE 7

Real case of ENG/OB demand for audio and service link channels to cover
Vienna Marathon, 2001 (Courtesy: NOB)

Channel(s) – Purpose – Quality

1, 5, 12 – Director – comms
2, 6, 11 – Camera control – data (in n/b FM)
3, 8, 14 – Cue-line – comms
4 – Technical comms from base to/from all
7 – Talk-back from all motorcycles – comms

9 – Reporter 1 audio uplink – broadcast
10 – Reporter 2 audio uplink – broadcast

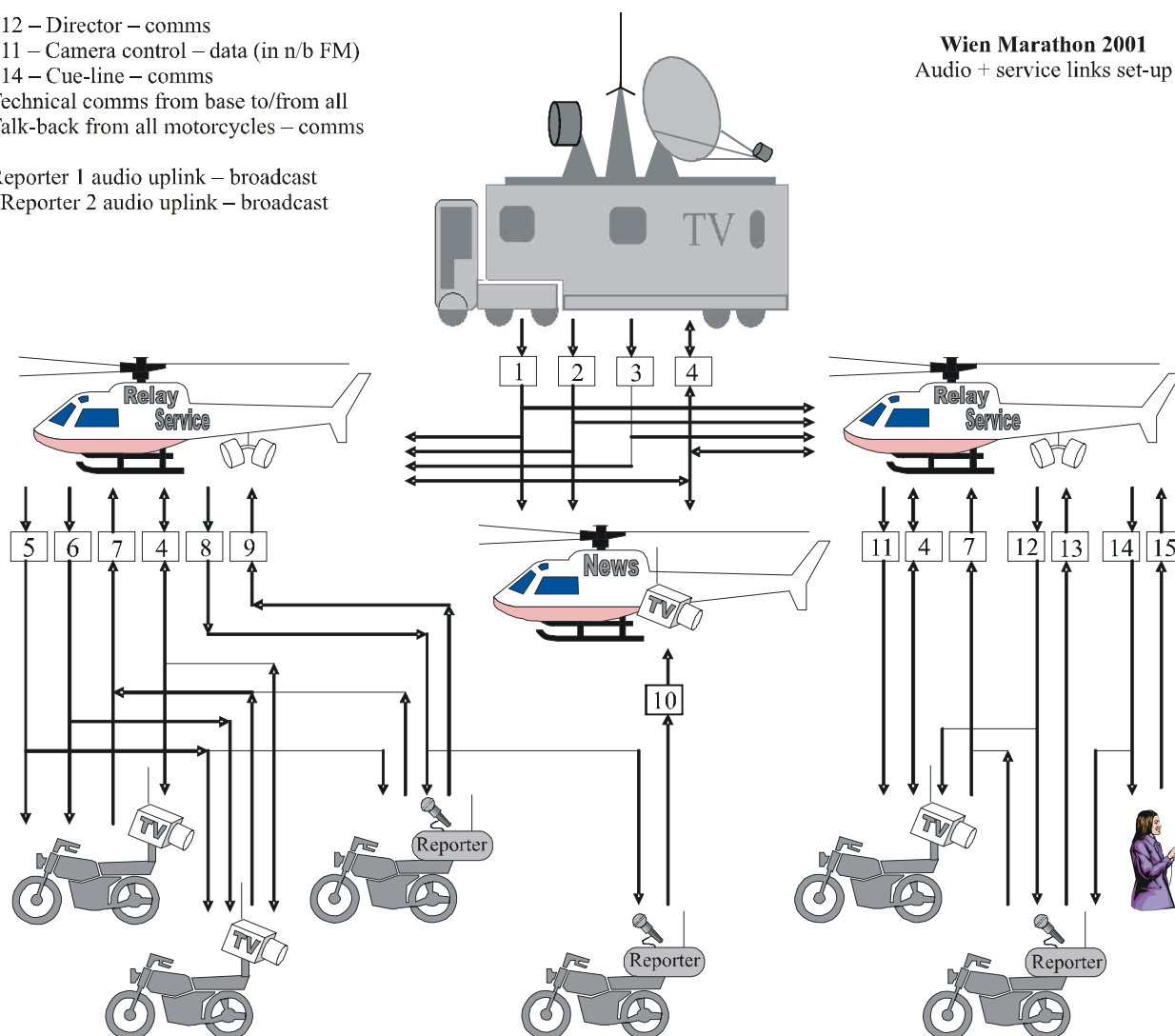

Rap 2069-07

In that respect, it may be also noted that these “non-standard” solutions for accommodating such additional demand would be more easy to achieve if SAP/SAB equipment would generally have wider tuning ranges. Therefore manufacturers should be encouraged to produce equipment with widest technically feasible tuning ranges, focused on covering whole (but if possible also going beyond) of the tuning ranges identified in this Report.

In general, the broadcasters covering these events are the same as those covering the events described in § 4.1.7, and the drivers and trends are mostly the same, although there are some variations since:

- nearly all the events considered here are “high profile”, so many more broadcasters will be attracted to cover them, hence significantly increasing demand for spectrum at one site;
- broadcasters are aware that SAP/SAB resources might be tight at such major events, so they would be prepared to adhere to the more strict spectrum use discipline and having to cooperate and/or accept less spectrum than they would like.

Assuming all this, this Report does not attempt to evaluate possible spectrum demand for these kind of events, as it would have to be satisfied on a case-by-case basis, based on national arrangements existing for such cases. Instead, the Tables in the following section indicate the order of possible spectrum demand figures, based on experience from some “typical” yearly recurring events.

5 Technical characteristics of ENG requirements

The spectrum bands identified to ENG have a number of inherent technical attributes which make them more suitable than some other radio-frequency spectrum bands for mobile operations. Indeed it is for these very reasons that these radio-frequency spectrum bands are now under pressure from other emerging mobile technologies.

Operational advantages for ENG operating in low radio-frequency spectrum bands tends to provide better propagation characteristics over obstructed paths, thereby increasing the probability of a successful transmission from any particular venue. The lower radio-frequency spectrum bands also provide greater margin of power for the operation of the link, i.e. the link can tolerate larger transmission losses because of the availability of higher transmitter powers and better receiver sensitivities. These factors are particularly important in the context of news reporting where the terrestrial television news gathering operator has no control over the venue of the event and virtually no opportunity to plan and optimize a transmission configuration.

The technical factors which make the radio-frequency spectrum bands assigned to ENG more suitable than some other bands for ENG purposes are:

- a) Lower diffraction loss for obstructed paths
- b) Lower receiver noise figure
- c) Higher available transmitter power
- d) Less directional antennas
- e) Avoidance of rigid/semi-rigid waveguide.

Factors a) to c) all contribute to an increase in available system gain, thereby maximizing the opportunity for establishing a link over an obstructed path. The nature of terrestrial ENG operations is that line-of-sight paths are often not available, such that the availability of the last few decibels of margin can make the difference between success or otherwise of the link.

Factor d), is in fact counter to the objective of maximizing system gain (the less directional the antenna the lower the forward gain), but is nevertheless an important compromise which must be made to achieve an alternative benefit, i.e. the ability to align an antenna quickly so as to acquire the wanted signal.

Factor e) enables quick set-up of equipment, the use of telescopic masts, helicopter mounted antennas, etc.

6 Development of TVOB

Many benefits have arisen from the use of the techniques developed for ENG. Some terrestrial ENG techniques such as the development of the handheld camera operation have contributed to techniques used in electronic field production (EFP), the use of hand held cameras for single camera programme production, and television outside broadcasts, the use of multiple cameras for television coverage of major events at non-studio locations such as sporting events. Of importance are the economic benefits which flow on from the staging of events viewed by world television audiences. The contribution of news and documentary footage often acts as a travelogue of a particular location for a viewing audience. However, this is more significant when one considers the migration

of terrestrial ENG techniques into other forms of production which have worldwide viewing audiences.

The development of these terrestrial ENG techniques has not only played a vital role for electronic news gathering but also facilitated the coverage of major planned events, particularly television outside broadcasts. Technologies and techniques which have been built up around the radio-frequency spectrum bands identified to ENG are now an essential component of many major sporting and other live “spectacular” telecasts.

The demands of these events, and the increase in television outside broadcast activity in many countries provides the basis for a continuing demand for spectrum for ENG and TOB for which broadcasters must continue to plan.

7 User requirements – TVOB/ENG/EFP/mobile platforms

7.1 TVOB

7.1.1 TVOB user requirements

Australian studies have advised ITU-R that TVOB involves the transmission of video from events back to a studio facility, for inclusion as programme material. TVOB operations are generally planned (e.g. sports broadcast, concert) multi camera live-to-air events. Such events may take place almost anywhere, but typically take place in urban area venues. TV networks each operate OB trucks and cars. Each broadcaster operates:

- up to two OB trucks;
- one to four ENG cars capable of linking signals back to studios and/or signal “collection” stations; and
- one helicopter.

The TVOB point-to-point links generally involve the use of directional antennas (e.g. parabolic) and relatively low elevation angles, other than where transmitting to an airborne platforms such as a helicopter or airship is used as a relay station. Operational duration ranges from a few minutes up to several days, depending upon the subject event timing.

Each major TV network operates at least one TVOB collection station per major city area in frequency bands often mounted on their broadcast tower facilities. In most cities these are located near the edge of the urban area. The collection station is a receive-only steerable parabolic dish.

7.2 ENG

The predominant programming originated by broadcasters is news and current affairs.

Electronic news gathering (ENG) operations often involve the setting up of an unplanned point-to-point link or series of links. For daily news gathering in major city areas, broadcast network operators utilize fixed collection stations operating in frequency bands consolidating ENG transmissions from multiple nomadic operations over a large (up to 100 km radius) area.

In some administrations each major TV network operates at least one ENG collection station per major city area. A typical central collection station is located within the city centre, on the roof of a large building (e.g. 150 m above the surrounding terrain), including a range of steerable (e.g. parabolic dish) and fixed (e.g. horn array with 360° of azimuthal coverage). Many networks also use an alternative collection station mounted on their broadcast tower facilities. In most cities these are located near the edge of the urban area.

- *Deployment:* Fixed collection stations located near city centres of major and capital cities. Nomadic news collection and sporting events principally around the major city and urban areas.
- *Link densities:* Major television networks operate ENG collection stations in major cities. Each operator may perform between one to five collection ENG collection operations per day, each of between 1/2 an hour up to 1 h duration per broadcaster. The very nature of competitive news broadcasting creates peak usage times where all channels are operated simultaneously.
- *Operational times/duration:* Collection stations operate continuously, picking up programme material from nomadic news teams using mobile and transportable ENG equipment. Events may take place at any time of the day, with significantly fewer events taking place at night, between about 12 midnight and 6 a.m. Collections are typically between about 1/2 to 1 h in duration. However, special event collections may involve durations of between 2 to 5 h. In some cases operations may be extended over days or even weeks.
- *Antennas and antenna elevation angles:* As detailed in Tables 5 and 6, ENG operations utilize a variety of antennas, including parabolic dish and co-linear. ENG collection receiving stations typically use a medium-gain (see Fig. 1) horn array with terrestrial coverage over the full azimuth range.
- In the case of nomadic stations transmitting to a collection station, the antenna elevation angle towards the collection station is proportional to the relative height difference between the nomadic station and the associated collection station and the path distance. For example Fig. 9 estimates a plane Earth 100 km radius ENG service area and a collection station antenna elevation of 150 m. Assuming a uniform probability distribution over the service area, Fig. 9 demonstrates that only a small proportion of transmitting antennas will have elevations in excess of about 2° (i.e. only those major city locations within the immediate vicinity of the collection station).

7.3 EFP

EFP operations are facilitated through the use of radio cameras, affording the operator with additional flexibility and obviating the need for troublesome cables.

Radio cameras relay programme material from portable cameras (e.g. as carried by a field cameraman) to a transportable or fixed receiving point, typically with path lengths of up to a couple of hundred meters. Typically, radio cameras operate at lower power levels and low gain omnidirectional transmitting antennas are used.

Operational times/duration: Radio camera operation tends to be limited by battery life with operations lasting up to one hour in duration. To provide continuous coverage, often a second camera is used on another frequency and rotated as necessary by the event.

7.4 Mobile platforms

Mobile video links include those where a camera is mounted on a moving vehicle (e.g. motorcycles, race cars and helicopters). In the case of terrestrial mobile (e.g. “race-cam”) cameras operating to a ground based receive site via an airborne platform (e.g. helicopter), each link fits into the mobile platform category. Race cars typically operate with 1 W transmitter operating into a vertically polarized 2 dBi patch antenna.

Helicopter platforms use bottom mounted antennas with an estimated antenna pattern discrimination (vertical and horizontal) of up to 20 dB. The downlink from the helicopter back to the local collection station often operates at elevation angles of up to 90°.

Helicopter platforms are often used as repeater stations to extend the range of the city collection stations. Hovering at elevations up to 10 000 feet the helicopter provides a relay platform for ground-based news crews to transmit news back to the city collection station, which may be of the order of 180 km away. Although these operations are not frequent, often they are used during major natural disasters such as bushfires, informing both the public and providing vital information for emergency services operations.

7.5 Analog FS system parameters for TVOB/ENG/EFP

7.5.1 System parameters for analog electronic news gathering

An example of ENG RF channel arrangements applied in Australia is based on a non-interleaved raster that provides seven 28 MHz and one 23.5 MHz bandwidth channels. Table 4 provides system parameters for current analog ENG systems employed in Australia (digital ENG systems are emerging).

TABLE 4

Analog ENG 2.5 GHz FS system parameters deployed in Australia

Frequency band	2 450-2 690	MHz
Modulation	FM	Analog
Capacity	PAL 625	Video
Channel spacing (MHz)	28	MHz
Transmit antenna gain	2 to 36	dBi
Transmit feeder loss (minimum)	1	dB
Transmit antenna type	Various	Parabolic/horns ⁽¹⁾
Transmit power (maximum)	20 ⁽²⁾	dBW
EIRP (maximum)	55	dBW
Receive antenna gain	1 to 36 ⁽³⁾	dBi
Receive antenna type	Various	Parabolic/horns ⁽⁴⁾
Receive feeder loss (maximum)	3	dB
Receiver IF bandwidth	30	MHz
Receive noise figure (dB)	8 ⁽⁵⁾	dB
Receiver thermal noise ⁽⁶⁾	-121.2	dBW

⁽¹⁾ ENG operations utilize a variety of antennas, including parabolic dish and collinear.

⁽²⁾ Some ENG analog collection stations operate up to 13 dBW transmit power.

⁽³⁾ Some ENG analog collection stations have receive antenna gains of 27 dBi.

⁽⁴⁾ A typical central collection station is located within the city centre, on the roof of a large building (e.g. 150 m above the surrounding terrain), including a range of steerable (e.g. parabolic dish) and fixed (e.g. horn array with 360° of azimuthal coverage).

⁽⁵⁾ Many ENG analog collection stations operate with a receiver noise figure of 2.5 dB, which lowers the quoted receiver thermal noise by up to 5.5 dB (depending on the amount of cable loss).

⁽⁶⁾ Does not include allowance for receive feeder loss.

TABLE 5

Analog ENG 2.5 GHz FS antenna parameters deployed in Australia

ENG antenna type vs. gain (dBi)	Minimum	Maximum	Mode
Fixed ENG collection station	1	27	13
Collinear ENG	5	21	12
Parabolic dish	14	36	20
Patch horn and other	2	12	10

TABLE 6

An example of ENG FS antenna half power beamwidths deployed in Australia

ENG antenna type	Azimuth (degrees)			Elevation (degrees)		
	Minimum	Maximum	Mode	Minimum	Maximum	Mode
Fixed ENG collection station	7	360	90	9	120	15
Collinear ENG	360	360	360	10	20	20
Parabolic dish	3	21	14	3	22	14
Patch horn and other	20	360	360	15	75	50

FIGURE 8

ENG collection station antenna gain (dBi) deployed in Australia

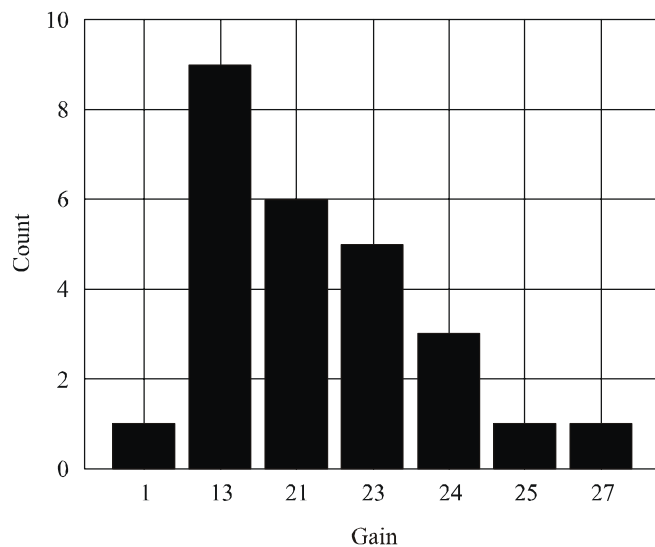

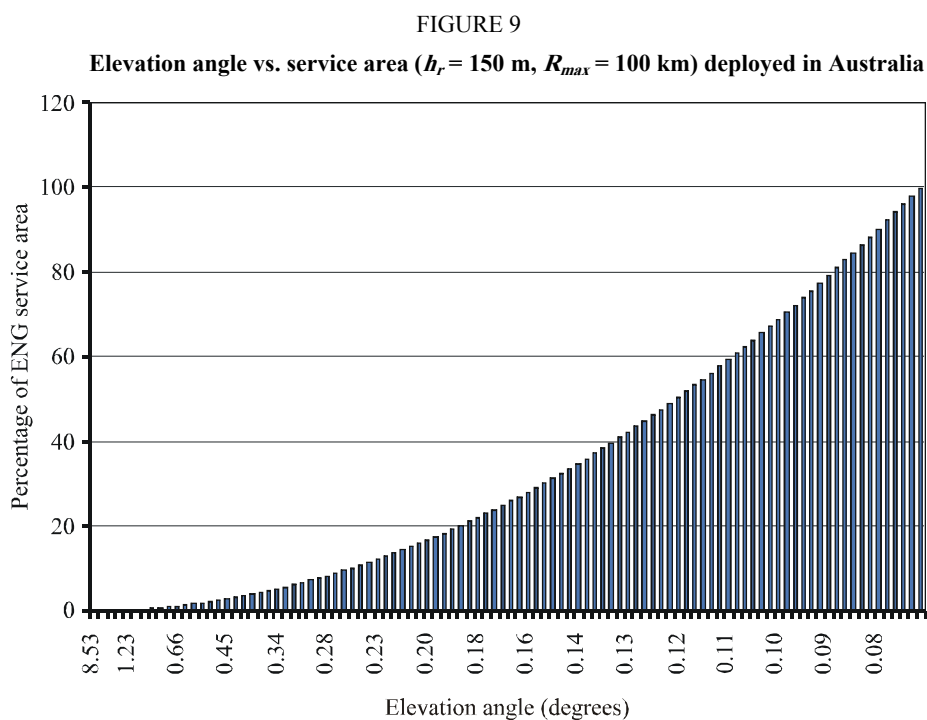

Rap 2069-09

7.5.2 System parameters for analog TVOB

In some administrations current MHzTVOB RF analog channel arrangements provide for interleaved 30 MHz channels. Table 7 provides system parameters for current analog TVOB systems deployed in Australia (digital TVOB systems are emerging).

TABLE 7
An example of analog TVOB FS system parameters

Frequency band	7 100-7 425	MHz
Modulation	FM	Analog
Capacity	PAL 625	Video
Channel spacing (MHz)	30	MHz
Transmit antenna gain	30 to 41	dBi
Transmit feeder loss (minimum)	1	dB
Transmit antenna type	Parabolic	
Transmit power (maximum)	13 ⁽¹⁾	dBW
EIRP (maximum)	53	dBW
Receive antenna gain	30 to 41	dBi
Receive antenna type	Parabolic ⁽²⁾	

TABLE 7 (end)

Receive feeder loss (maximum)	3	dB
Receiver IF bandwidth	30	MHz
Receive noise figure (dB)	4	dB
Receiver thermal noise ⁽³⁾	-125.2	dBW

- (1) TVOB analog collection stations may operate up to 20 dBW transmit power, but up to 5 W are in common use.
- (2) A typical central collection station is located on a transmission tower (e.g. 150 m above the surrounding terrain), including a steerable parabolic dish with 360° of azimuthal coverage.
- (3) Does not include allowance for receive feeder loss.

TABLE 8

An example of analog TVOB FS antenna parameters

TVOB antenna type vs. gain (dBi)	Minimum	Maximum
Antenna diameter (m)	0.6	1.8
Gain (dBi)	30	41
3 dB beamwidth (degrees)	4.9	1.6

TABLE 9

Alternative analog TVOB FS system parameters

Frequency band	8 275-8 400	MHz
Modulation	FM	Analog
Capacity	PAL 625	Video
Channel spacing (MHz)	28	MHz
Transmit antenna gain	31 to 41	dBi
Transmit feeder loss (minimum)	1	dB
Transmit antenna type	Parabolic	
Transmit power (maximum)	13 ⁽¹⁾	dBW
EIRP (maximum)	53	dBW
Receive antenna gain	31 to 41	dBi
Receive antenna type	Parabolic ⁽²⁾	
Receive feeder loss (maximum)	3	dB
Receiver IF bandwidth	30	MHz
Receive noise figure (dB)	4	dB
Receiver thermal noise ⁽³⁾	-125.2	dBW

- (1) Some TVOB analog collection stations operate up to 20 dBW transmit power.
- (2) A typical central collection station is located on a transmission tower (e.g. 150 m above the surrounding terrain), including a steerable parabolic dish with 360° of azimuthal coverage.
- (3) Does not include allowance for receive feeder loss.

TABLE 10

Alternative analog TVOB 8.3 GHz FS antenna parameters

TVOB antenna type vs. gain (dBi)	Minimum	Maximum
Antenna diameter (m)	0.6	1.8
Gain (dBi)	31	41
3 dB beamwidth (degrees)	4.8	1.5

In some administrations supplementary TVOB RF channel arrangements provide for sixteen 28 MHz interleaved channels assigned to TVOB. Table 11 provides an example of supplementary system parameters for current analog TVOB systems (digital TVOB systems are emerging).

TABLE 11

Alternative supplementary analog TVOB FS system parameters

Frequency band	12.75-13.25	GHz
Modulation	FM	Analog
Capacity	PAL 625	Video
Channel spacing (MHz)	28	MHz
Transmit antenna gain	29 to 41	dBi
Transmit feeder loss (minimum)	1	dB
Transmit antenna type	Parabolic	
Transmit power (maximum)	10	dBW
EIRP (maximum)	50	dBW
Receive antenna gain	29 to 41	dBi
Receive antenna type	Parabolic	
Receive feeder loss (maximum)	1	dB
Receiver IF bandwidth	30	MHz
Receive noise figure (dB)	4	dB
Receiver thermal noise ⁽¹⁾	-125.2	dBW

⁽¹⁾ Does not include allowance for receive feeder loss.

TABLE 12

Alternative supplementary analog TVOB FS antenna parameters

TVOB antenna type vs. gain (dBi)	Minimum	Maximum
Antenna diameter (m)	0.3	1.2
Gain (dBi)	29	41
3 dB beamwidth (degrees)	5.0	1.3

FIGURE 10
An Australian example of ENG/OB spectrum usage

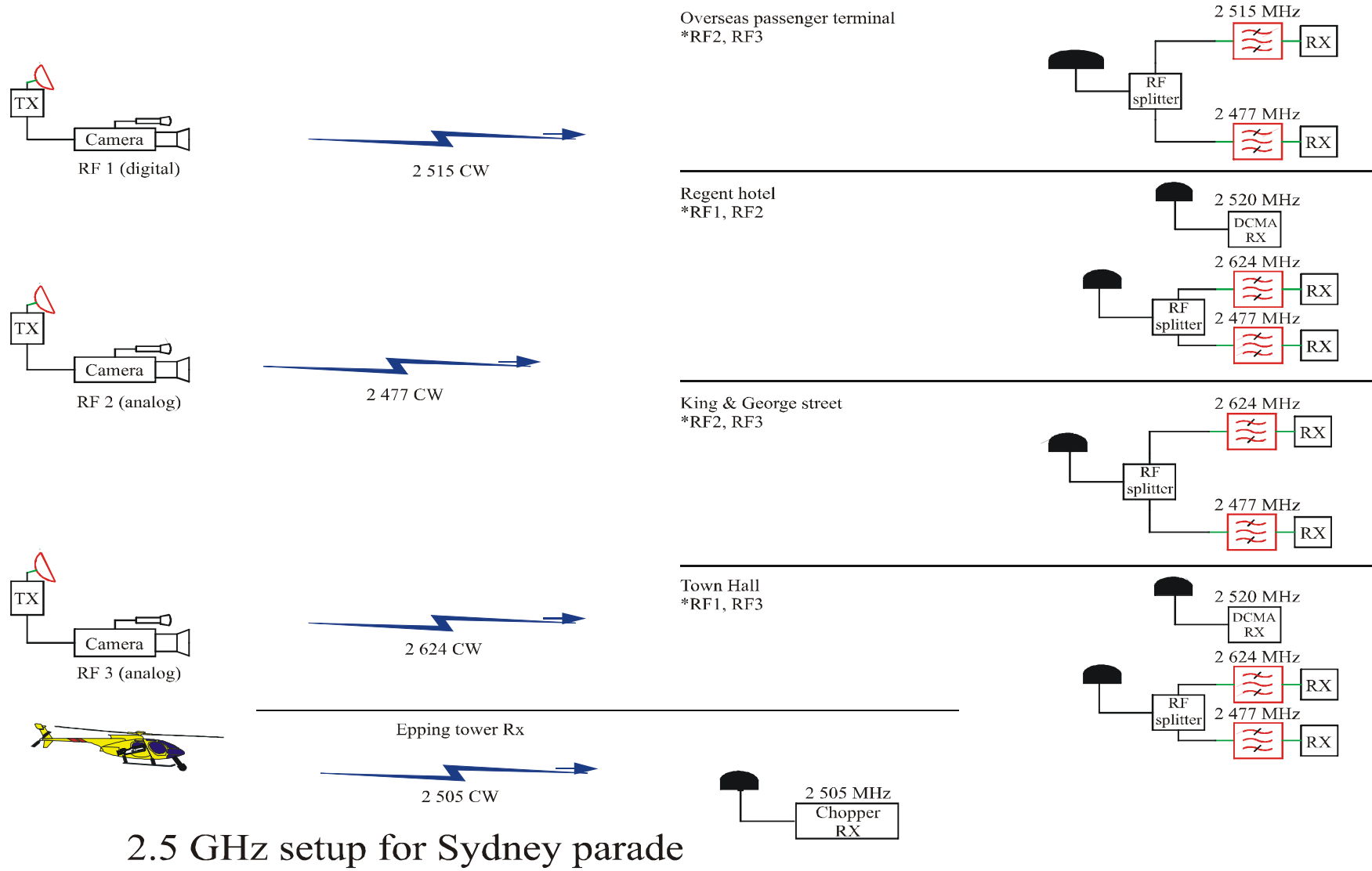

Note – RF1 and RF3 can be received at all 4 sites. RF1 DCMA only at Regent and Town Hall.

FIGURE 11
An Australian example of ENG/OB spectrum usage

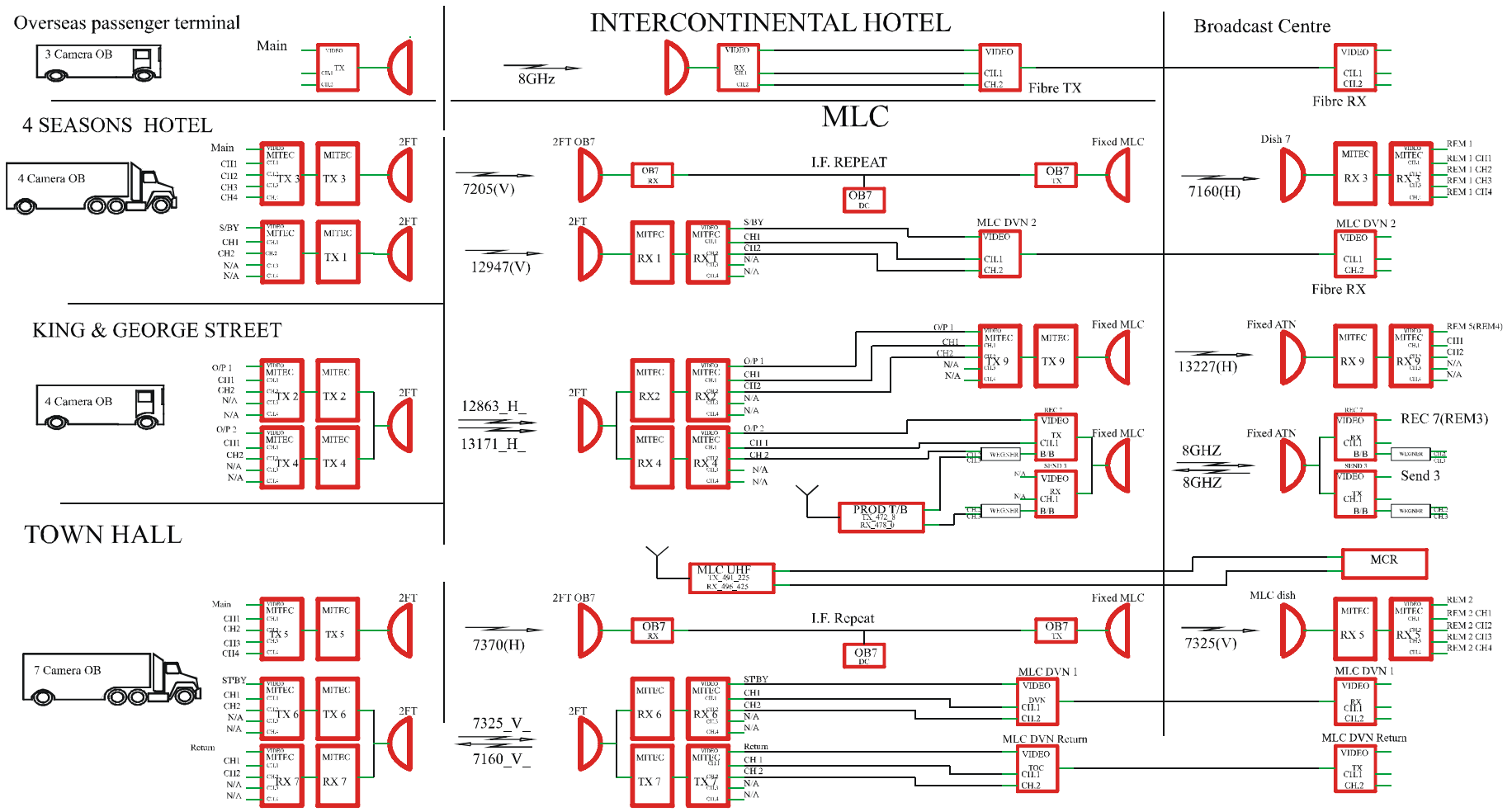

7, 8 and 13 GHz setup for Sydney Parade

7.6 Summary of service requirements of video and audio SAP/SAB applications

European studies state that based on the classification of SAP/SAB equipment in § 2 and considerations in § 3, it becomes possible to summarize and compare the service requirements of the various SAP/SAB sectors for different kinds of technical applications employed. These applications are further differentiated by scenarios in which the equipment might be used (mobility, airborne use) and their related operational parameters, such as range, antenna height, antenna directivity, etc. Such different operational requirements suggest preference for different frequency bands.

Table 13 summarizes the service requirements for video SAP/SAB links, and Table 14 summarizes the service requirements of audio SAP/SAB links.

Only those SAP/SAB usage sectors are reflected in Tables 13 and 14, which are likely to cause most significant and lasting peak demand. For video links these are the news-gathering (ENG), daily sport coverage or similar routine OB and some of recurring (usually annual) special events, such as major marathons, races and similar events.

For audio links the activity areas reflected are the news gathering (ENG), daily sports and similar routine OB, theatres and touring shows, and the major recurring events as already mentioned for video links (including major stage shows).

Apparently all such daily or recurring demand usually requires a long term solution to satisfy, however it may be required to a full extent only at a few locations across the nation.

Estimates of future demand for video links in Table 13 are based on the assumption that digital technology becomes a success, as described in § 4.1.5 and 4.1.7. This also implies that the necessary channel raster in the future may be decreased from current typical 20 MHz to 10 MHz for cordless cameras, portable and mobile video links.

Today temporary point-to-point video links are accommodated either in SAP/SAB bands alongside the mobile SAP/SAB applications, or in the traditional fixed bands (such as 7 GHz or 8 GHz bands). Accordingly they follow either a typical 20 MHz raster in SAP/SAB bands or 28 MHz channel raster in fixed bands. Advancement of digital technology in SAP/SAB applications for these temporary point-to-point links could lead to a transfer to either a 10 MHz (or even 8 MHz because of less stringent size limitations) raster in SAP/SAB bands, or to a 14 MHz raster in fixed bands, see § 11.1 for details.

Because of the wide variety of SAP/SAB, both in terms of number of applications, types of events covered and extent of SAP/SAB use across different European nations, it was not possible to obtain any definite (averaged) figures of estimated channel demand, which would be valid. Instead, the figures shown below in Tables 13 and 14 are either based on available estimates from the above mentioned European studies or provide the best-attempt estimates, derived from the practical experiences.

Therefore the estimates in Tables 13 and 14 should be used with caution and seen as indicative figures, giving order of demand, rather than its precise values.

TABLE 13

Classification and service requirements of video SAP/SAB links** **

Type of link	Typical range	Radio link path	Recommended tuning ranges – Not all frequency ranges are applicable in individual administrations	Channel requirement estimates for different activity sectors/events		
				ENG, for major urban area	Casual OB, e.g. football match ⁽¹⁾	OB at major annual events ⁽²⁾
Cordless camera	< 500 m	Usually clear line-of-sight, but might be susceptible to multipath impairment	2-2.5 or 2.7-2.9 GHz** 10.0-10.68 GHz 21.2-24.5 GHz 47.2-50.2 GHz	<i>Now:</i> (2...5) × 20 MHz ch. <i>In 10 years:</i> (10...15) × 10 MHz ch.	<i>Now:</i> (1...5) × 20 MHz ch. <i>In 10 years:</i> (8...10) × 10 MHz ch.	<i>Now:</i> (5...10) × 20 MHz ch. <i>In 10 years:</i> (10...20) × 10 MHz ch.
Portable link	< 2 km	Normally, but not always clear line-of-sight	2-2.5 GHz 10.0-10.68 GHz			
Mobile airborne	< 50 km	Normally, but not always clear line-of-sight	2-2.5 GHz 3.4-3.6 GHz	<i>Now:</i> (2...5) × 20/28 MHz <i>In 10 years:</i> (10...15) × 8/10 MHz	<i>Now:</i> (1...2) × 20/28 MHz <i>In 10 years:</i> (3...5) × 14/28 MHz	<i>Now:</i> (2...5) × 20/28 MHz <i>In 10 years:</i> (10...15) × 14/28 MHz
Mobile vehicular	< 10 km	Often obstructed and susceptible to multipath impairment	2-2.5 GHz 3.4-3.6 GHz			
Temporary point-to-point links	< 80 km per hop	Usually clear line-of-sight for OB, but often obstructed for ENG use	7 GHz, 8 GHz bands 10.0-10.68 GHz 21.2-24.5 GHz			

* For further technical characteristics (powers, antenna gains, etc.) refer to the European studies – ERC Report 38 (video links) or ERC Report 42 (audio links).

** Future use is possible in European countries but the final decision awaits results of sharing studies in the band 2.7-2.9 GHz. The studies and pending decisions are European and not those of the ITU, or other administrations.

⁽¹⁾ Channel estimates for casual OB operations are given per routine event/single broadcaster.

⁽²⁾ Major annual event means typical recurring special event, like annual marathons, races, major stage shows (Eurovision Song Contest), etc.

TABLE 14

Classification and service requirements of audio SAP/SAB links** **

Type of link	Typical range	Recommended tuning ranges – Not all frequency ranges are applicable in individual administrations	Channel requirement estimates for different activity sectors/events							
			TV/radio news (ENG), major urban area		Casual OB, e.g. football match ⁽¹⁾		Theatres and touring shows		OB at major annual event ⁽²⁾	
			Now	In 10 years	Now	In 10 years	Now	In 10 years	Now	In 10 years
In-ear monitors	< 100 m	174-216 MHz	10...15 ch.	15...30 ch.	1...5 ch.	5...10 ch.	45...55 ch.	45...55 ch.	20...80 ch.	20...80 ch.
Professional radio microphones	< 100 m	470-862 MHz 1 785-1 800 MHz								
Portable audio links	< 2 km	VHF/UHF bands ⁽³⁾	3...5 ch.	5...10 ch.	1...5 ch.	5...10 ch.	2...5 ch.	5...10 ch.	10...20 ch.	10...20 ch.
Mobile (incl. airborne) audio links	< 20 (50) km	VHF/UHF bands ⁽³⁾	3...5 ch.	5...10 ch.	3...5 ch.	5...10 ch.	Not applicable		5...10 ch.	5...10 ch.
Temporary point-to-point links	< 50 km per hop	VHF/UHF bands ⁽³⁾	1...5 ch.	3...5 ch.	1...3 ch.	2...5 ch.	Not applicable		5...10 ch.	5...10 ch.

* For further technical characteristics (powers, antenna gains, etc.) refer to the European studies – ERC Report 38 (video links) or ERC Report 42 (audio links).

** Future use is possible in European countries but the final decision awaits results of sharing studies in the band 2.7-2.9 GHz. The studies and pending decisions are European and not those of the ITU, or other administrations.

⁽¹⁾ Channel estimates for casual OB operations are given per routine event/single broadcaster.

⁽²⁾ Major annual event means typical recurring special event, like annual marathons, races, major stage shows (Eurovision Song Contest), etc.

⁽³⁾ Depending on application scenario, channel width and required transmitter power, portable, mobile and temporary point-to-point audio links may be accommodated either in SAP/SAB bands or in other VHF/UHF bands, including the private mobile radio (PMR) bands.

8 Spectrum usage

The range of microwave signal links to service TVOB/ENG/EFP include terrestrial, ground-to-air, air-to-ground (analog) transmission of live-to-air broadcast material from news and sporting event broadcasts, portable cameras at sporting venues, ground based mobile link vehicles, airship platforms and prominent buildings.

ENG operations are concentrated around major city and urban areas, with centrally located “collection” stations that utilize wide-beam horn array antennas. While these stations currently use wide-beam horn arrays other antenna types are likely to be deployed in the future. These “collection” stations are fixed receiving stations utilizing antennas that may be vulnerable to interference from emitters with arrival angles somewhat higher than conventional point-to-point systems. Other types of ENG deployments are nomadic and utilize a range of antenna types.

The principal difference against conventional FS is that TVOB, ENG and EFP operations utilize a wide range of antenna types with wider main beam radiation patterns, many also exhibiting considerable asymmetry in the azimuth vs. elevation planes.

Operations may be bidirectional point-to-point, but more usually involve one or more one-way transmissions from nomadic/mobile news cameras to a fixed network access point, for onward transmission to a central studio location. However, the upward transmission may be relayed via other nomadic transmission sites, including terrestrial vehicles and airborne platforms such as helicopters or airships. Refer Figs. 10 and 11 for an example of a typical TV outside broadcast staged in a major city metropolitan centre.

8.1 Frequency assignments for TVOB/ENG/EFP

An example of current frequency assignments for TVOB/ENG/EFP are represented as those provided by the Administration of Australia.

2.5 GHz band

In one administration the current MHz ENG RF channel arrangements are based on a mix of 23.5 MHz and 24 MHz channels as TVOB, ENG and EFP operations in the band 2 500-2 690 MHz.

Operational characteristics employed in Australia for analog ENG are variable but generally fit within the following:

- Transmit power up to 20 Watts with typical value of antenna gain of 21 dBi (i.e. typical EIRP of 33 dBW).
- Ground segment operational elevations from 0° to 45° elevation⁵. Higher elevations are occasionally used during sporting coverage for local helicopter relay.
- Helicopter platforms use bottom mounted antennas with estimated antenna pattern discrimination (vertical and horizontal) of up to 20 dB.
- Mobile platforms (e.g. race cars) typically use 10 Watt transmitters with 2 dBi “patch” that transmit to helicopter receive platforms.

Several distinct operational scenarios characterize the broadcast support FS applications operated in the 2.5 GHz band:

- nomadic, temporary TVOB point-to-point links;
- fixed, centrally located continuously operating ENG “collection” stations.

⁵ Operations at high elevation angles would typically involve collection from field cameras to a collection point over fairly short ranges within a single venue (e.g. a sports arena). Such transmissions would operate at EIRP levels much lower than the typical value quoted above.

- mobile (terrestrial vehicles and airborne relay platforms); and
- radio cameras (e.g. live outdoor events, “race-cam” applications).

7.2 GHz band

In one administration the current 7.2 GHz (7 100-7 430 MHz) TVOB rf channel arrangements provide for eighteen interleaved 30 MHz channels.

Operational characteristics for analog TVOB are variable but generally fit within the following:

- Transmit power up to 20 Watts, but typically 5 W or less, with a nominal antenna of 0.6 m (antenna gain 30 dBi) (i.e. typical EIRP of 36 dBW).
- Ground segment operational elevations from 0° to 5° elevation.

The singular operational scenario characterized for the broadcast support FS applications operated in the 7.2 GHz band is temporary TVOB point-to-point links.

8.3 GHz band

In one administration the current 8.3 GHz (8 275-8 400) TVOB rf channel arrangements provide for eight 28 MHz channels.

Operational characteristics for analog TVOB are variable but generally fit within the following:

- Transmit power up to 20 Watts, but typically 5 W or less, with a nominal antenna of 1.2 m (antenna gain +36 dBi) (i.e. typical EIRP of 42 dBW).
- Ground segment operational elevations from 0° to 5° elevation.

The singular operational scenario characterized for the broadcast support FS applications operated in the 8.3 GHz band is temporary TVOB point-to-point links.

13 GHz band

In one administration the current 13 GHz band (12.75-13.25 GHz) rf channel arrangements provide for sixteen 28 MHz channels assigned to TVOB, in a band plan of 32 channels.

Operational characteristics for analog TVOB are variable but generally fit within the following:

- Transmit power up to 10 Watts, but typically 5 W or less, with antenna gain 35 dBi (i.e. typical EIRP of 41 dBW).
- Ground segment operational elevations from 0° to 45° elevation⁶.

The singular operational scenario characterized for the broadcast support FS applications operated in the 13 GHz band is temporary TVOB point-to-point links.

9 Spectrum needs for ENG and TOB

A milestone in the development of terrestrial ENG has been the development of around the clock news programming and the increasing demand by the worldwide viewing public for outside broadcast of sporting events.

Spectrum needs in many countries requires consideration of trends in spectrum planning in other countries. This needs to take account of technology applied to an application in one country and the possibility equipment used in that application may be brought by overseas bodies into another

⁶ Operations high elevation angles would typically involve collection from field cameras to a collection point over fairly short ranges within a single venue (e.g. a sports arena). Such transmissions would operate at EIRP levels much lower than the value quoted above.

country. Band planning in an administration needs to accommodate the coverage requirements of the event or the viability of staging the event at the location may be diminished.

Few administrations have made similar spectrum national assignments for television outside broadcast and electronic news gathering despite the worldwide application of these techniques. Some have made assignments in the 900 MHz, 2-3 GHz, 7 GHz bands.

Many broadcasters are currently operating with analog FM equipment using a variety of channel widths. Some administrations have made national assignments of spectrum for ENG and TOB in lower bands by comparison with other countries. National spectrum assignments for ENG is often determined by number of users/licensees, geographic size of the country and demand for services.

Direct comparison between national assignments made between countries is difficult because of the different regulations which apply to the use of various bands for a range of broadcast “ancillary” uses.

However, one administration has made the observation that spectrum planning in many countries can benefit from the consideration of trends in spectrum planning in other countries. This need would take into account the technology applied to an application in one country and the possibility equipment used in that application may be brought by overseas bodies into another country. Harmonized band planning by administrations would enhance the viability of staging events at varied locations.

A number of administrations already have common spectrum assignments for television outside broadcast and electronic news gathering. These appear to have evolved as a result of the worldwide application of TVOB and ENG techniques. As indicated earlier ITU-R has identified a number of bands identified for IMT-2000 are currently assigned to terrestrial electronic news gathering:

- 806-960 MHz band – at least one administration in both Region 1 and 3
- 1 710-2 025 MHz band – four administrations in Region 1 and one administration in Region 2
- 2 110-2 200 MHz band – at least two administrations in Region 1
- 2 500-2 690 MHz – ten administrations in Region 1, two administrations in Region 2 and three administrations in Region 3.

9.1 Frequency bands for video links

European studies have provided an inventory of candidate bands for video SAP/SAB links. It lists those bands identified for ENG/OB. The inventory is intended to provide details for each of the bands: current provisions, national usage, reasoning and conclusions regarding possibilities of future (harmonized) use by video SAP/SAB links.

The bands listed in the document address mostly the bands, which are intended for use by cordless cameras and different mobile video SAP/SAB links. It is assumed that the majority of temporary fixed point-to-point ENG/OB connections are often accommodated in the “traditional” fixed services’ bands, utilizing the same channelling arrangements. For example, such fixed services’ bands, where temporary point-to-point links are often located, include bands around 5.9 GHz, 7.5 GHz, 8 GHz, etc.

The information on nationally used frequency bands is used in this section, as was collected in a European study in mid-2001 and applies to only some European countries particularly as regards to frequency band usage. It is reproduced in full in Table 22.

Two distinctive terms are used in this section to describe different proposed status of band identification for use by video SAP/SAB links:

Tuning range – Means identification of the frequency band, from where European countries may assign specific sub-bands or particular frequencies for video SAP/SAB links subject to availability, actual demand and sharing arrangements with primary services using those bands. Ideally, SAP/SAB equipment should be capable of being re-tuned within the whole of tuning range and even beyond, to be suitable for operation in different countries.

Preferred sub-band – A sub-band within the tuning range, where higher prospects of pan-European usage of video SAP/SAB links may be expected. These sub-bands are identified as either those, which are most widely used for SAP/SAB today, or as occupying certain gaps in spectrum use by primary services, such as separation gaps between the “go-return” duplex legs in fixed service channelling arrangements, etc. If SAP/SAB equipment is not capable of covering the whole tuning range, then it should be capable of operating at least within the preferred sub-band to ensure the best opportunity for international use.

9.1.1 Frequency bands 2 025-2 110/2 200-2 290 and 2 290-2 500 MHz

The bands 2 025-2 110/2 200-2 290 MHz are foreseen by European studies to be used primarily for fixed links, space science services and mobile systems. Mobile service is limited to tactical radio relay links and ENG/OB applications.

Other EU studies identify the sub-bands 2 025-2 070/2 200-2 245 MHz as the harmonized 2×45 MHz solution for near/cross-border operation of military TRRL.

Within the band 2 290-2 400 MHz EU studies foresee mobile systems, the band 2 400-2 483.5 MHz is designated as ISM band, also used for SRDs, etc. The band 2 483.5-2 500 MHz is designated as fixed, mobile, mobile satellite, ISM band.

Although until now EU studies did not directly foresee ENG/OB use in the band 2 290-2 500 MHz, such use was recommended. The EU study proposed to extend it downwards until 2 290 MHz and treat it together with the above bands 2 025-2 110/2 200-2 290 MHz.

These frequency bands today are already widely used across Europe for video SAP/SAB links. A total of 16 out of 18 countries providing information (89%) indicated that they do allow various video links in some parts of this frequency range. In terms of specific sub-bands, certain majority (70%) would allow SAP/SAB in the middle of the band, around 2.2-2.4 GHz, while respectively 40% and 45% of countries would allow such use in the lower (2-2.2 GHz) or upper (2.4-2.5 GHz) parts of this range.

Likely extended use by video SAP/SAB links on a shared basis with other services.

It should be noted that the ISM band 2 400-2 483.5 MHz becomes increasingly difficult to share between video links vs. SRDs, especially radio LANs, including bluetooth. However some further possibilities to maintain SAP/SAB use in this band are to be investigated further. E.g. the use of digital modulation technologies with the narrowed channel bandwidth and low power (10 mW) by future video SAP/SAB applications could improve sharing possibilities.

The bands 2 025-2 110/2 200-2 400 MHz are widely used for government purposes in many European countries, in particular for TRRL below 2 300 MHz and aeronautical telemetry between 2 300-2 400 MHz. However these bands provide potential for video SAP/SAB links, as it may be seen that SAP/SAB access to this band is allowed in many countries under various arrangements.

Category of video SAP/SAB links

Primarily mobile vehicular and airborne video links, but also including portable video links. Cordless cameras may have to be accommodated in this band too, unless replacement band at 2.7-2.9 GHz is made available for that kind of SAP/SAB links.

Prospects of harmonization and preferred sub-bands

It is suggested that the bands 2 025-2 110 and 2 200-2 500 MHz are combined together and identified as a single tuning range for video ENG/OB links. It is assumed that this corresponds well with the expected minimum tuning range of 500 MHz for equipment designed for this band.

9.1.2 Frequency band 2 500-2 690 MHz

The band 2 500-2 690 MHz has been identified by WRC-2000 for satellite and terrestrial components of UMTS/IMT-2000. The conditions and time-scales for UMTS access to this band are currently being developed.

EU administrations do not foresee ENG/OB use in this band; however such use was recommended by the ERC in the band 2 300-2 600 MHz.

Out of 16 European countries providing information for this band, only four (25%) indicated ongoing use of video SAP/SAB links in this band. A further five (30%) indicated that currently video SAP/SAB links are allowed, but in the future the band should be freed for other use, notably as an UMTS extension band. The remaining seven countries indicated no SAP/SAB use in this band.

The band 2 500-2 690 MHz is intended for sole UMTS use in the longer term. However this band might continue to be used for video SAP/SAB applications in the short term, presumably until 2007.

Category of video SAP/SAB links

Primarily mobile vehicular and airborne video links.

Prospects of harmonization and preferred sub-bands

No, given the expected future deployment of UMTS.

9.1.3 Candidate frequency band 2 700-3 400 MHz

This band is currently considered as a candidate for accommodating some SAP/SAB requirements, in particular within the sub-band 2 700-2 900 MHz. However such identification for video SAP/SAB links is awaiting results of ongoing sharing studies and review of the whole band 2 700-3 400 MHz.

Having considered the progress of sharing studies, EU administrations decided to restrict candidate SAP/SAB applications for introduction in the band 2 700-2 900 MHz to digital cordless cameras only. The operational requirements but adjusted for an expected digital scenario, are given below in Table 15.

TABLE 15

Parameters of digital cordless cameras considered for operation in the candidate band 2 700-2 900 MHz

Type of link	Typical Tx antenna characteristics			Maximum EIRP (dBW)	Typical environment
	Height (agl)	Directivity	Gain (dBi)		
Digital cordless cameras (see definition in § 1 of the Report)	2 m	Omni-directional in HRP	5	0	Indoor, outdoor (e.g. within sports stadium)

Additional operating and licensing conditions, e.g. coordination requirements, exclusion zones around radars or other measures for protection of aeronautical radionavigation, are to be established based on the results of sharing studies and realistic possibilities of enforcing such conditions.

It was assumed that the current choice for modulation would be the DVB-T standard in Europe, however later developments of proprietary modulation schemes may be considered once and if they become known. Unfortunately, this would also require revisiting the assumptions made when conducting the sharing studies. However it may be possible to associate the sharing study results with some essential requirements in terms of modulation parameters, compliance with which would assume validity of the original sharing study with the different system.

Such proposed restriction of potential SAP/SAB use to only one application would provide only a partial solution to congestion in use of the spectrum available to video SAP/SAB links. However, if cordless cameras may be used on certain conditions in the band 2 700-2 900 MHz, this would at least release pressure on the other bands (notably in the range 2-2.5 GHz), which then may be to a larger extent used for high mobility (terrestrial and airborne) video SAP/SAB links.

Given that the sharing concerns are resolved satisfactorily, then the band 2 700-2 900 MHz could become a good candidate for harmonized use by cordless cameras, because of existing similar use of the band by incumbent services across Europe.

9.1.4 Frequency band 3 400-3 600 MHz

EU administrations foresee this band to be used primarily for fixed links and fixed wireless access applications. Some administrations allow ENG/OB use under the mobile allocation. This is further specified in the Notes column as being for occasional coordinated ENG/OB links.

Some administrations identify the band 3 400-3 600 MHz as one of the bands, preferred for FWA applications.

While in many countries this band is earmarked or used for services other than SAP/SAB, notably for FWA, at least five out of 16 responding EU countries (some 30%) do allow video SAP/SAB links in this band. Usually it is for occasional SAP/SAB use on a coordinated basis.

Some possibilities of continued SAP/SAB use exist under national sharing arrangements or case-by-case coordination procedures.

Category of video SAP/SAB links

Mobile vehicular and airborne video links.

Prospects of harmonization and preferred sub-bands

The band might be kept as a tuning range for video SAP/SAB links, and such use may in particular utilize the spectrum gaps in and around the FWA channelling plan. Until FWA is better developed, wider use of this band by video SAP/SAB links may take place.

9.1.5 Frequency band 4 400-5 000 MHz

This band is identified by the EU administrations as a harmonized military band for fixed and mobile systems. The sub-band 4 990-5 000 MHz is also foreseen for radio astronomy measurements. However some administrations allow occasional use of coordinated ENG/OB links.

In most EU countries this band is reserved for sole military use. However at least six out of 17 providing the data (35%) indicated that they do allow occasional SAP/SAB use in this band.

Some possibilities of continued SAP/SAB use exist under national sharing arrangements or case-by-case coordination procedures.

Category of video SAP/SAB links

Tests performed in Austria of video SAP/SAB links in this band (ORF, 2001) concluded that this band is suitable for fixed or low mobility video link applications, such as temporary point-to-point links, portable links or cordless cameras.

Prospects of harmonization and preferred sub-bands

Few.

9.1.6 Frequency band 5 250-5 850 MHz

The various sub-bands of this band are foreseen by the EU to be used for different applications, including radiolocation, radionavigation, satellite services. Furthermore, EU administrations designate the bands 5 150-5 350 MHz and 5 470-5 725 MHz for HIPERLANs.

However, some administrations stipulate that the band 5 250-5 850 MHz will be studied to identify possibilities to accommodate ENG/OB, specifically wireless cameras.

Of 16 EU countries providing information, only three (20%) indicated possibilities for using video SAP/SAB links.

The band may be difficult to share with other services, allowed by the Radio Regulations, in particular with HIPERLAN in the future. However, possibilities to use HIPERLAN technology for ENG/OB links might be investigated.

The ISM part of the band, namely 5 725-5 850 MHz might be increasingly difficult to share with incumbent ISM equipment and with possible future increasing use of SRDs in this sub-band.

Category of video SAP/SAB links

Cordless cameras and portable video links.

Prospects of harmonization and preferred sub-bands

Few.

9.1.7 Frequency band 10.0-10.68 GHz

The various sub-bands of this band are foreseen by the EU to be used for different applications, such as FWA; radars in the parts below 10.5 GHz; sensors and passive applications. ENG/OB use is envisaged across the entire band. RR footnotes 5.149 and 5.482 apply in the band 10.6-10.68 GHz to protect operation of passive services.

EU administrations identify the band 10.15-10.30/10.50-10.65 GHz as one of the bands preferred for FWA applications.

This band is widely used by video SAP/SAB links in Europe. Of 18 countries, only two indicated no SAP/SAB use in this band. Of 16 positively responding countries, 12 would allow video SAP/SAB links in the middle part of the band (around 10.3-10.5 GHz), 10 in the upper parts (10.5-10.68 GHz) and six in the lower parts (10-10.15 GHz).

Likely continued use of video SAP/SAB links on a shared basis with other services, e.g. utilizing separation gaps between go-return duplex parts within FWA deployment scenarios, non-radar parts, etc.

Category of video SAP/SAB links

Temporary point-to-point video links, portable video links and cordless cameras.

Prospects of harmonization and preferred sub-bands

The whole band 10.00-10.68 GHz might be identified as a tuning range for video SAP/SAB links.

The sub-band of 10.3-10.45 GHz may be identified as a preferred sub-band for video SAP/SAB links.

9.1.8 Frequency band 21.20-24.50 GHz

The various sub-bands of this band are identified by the EU to be used for different applications, such as fixed links, passive services, RA observations and radars. There are no foreseen plans in Europe for operation of passive services in parts of this band.

EU administrations currently allow ENG/OB use across the entire band, except within the sub-band 21.4-22.0 GHz, reserved by EU administrations for wideband high definition television. The latter sub-band is also considered for BSS/HDFSS applications.

The ERO established the channel raster for fixed services in this range, *inter alia*, recommending to deploy fixed unidirectional links, such as used for ENG/OB, in the sub-bands 22.6-23.0 GHz, and 24.25-24.5 GHz. In such deployment, unidirectional links would not overlap with the duplex channelling raster of conventional bidirectional permanent fixed links.

This is another band in major use for video SAP/SAB links in Europe. Only two of 20 responding countries indicated no SAP/SAB use in this band. Out of 18 positively responding countries, 12 would allow video SAP/SAB links in the lower parts of the range (in particular within 21.2-21.4 GHz), nine in the middle parts (22.6-23 GHz) and 6 in the upper parts (24.25-24.5 GHz), while actual ranges vary much greater.

Good prospects are likely for increase SAP/SAB usage.

Category of video SAP/SAB links

Cordless cameras and temporary point-to-point video links.

Prospects of harmonization and preferred sub-bands

The whole band should be kept as a tuning range for video SAP/SAB links.

The sub-bands 21.2-21.4 GHz, 22.6-23.0 GHz and 24.25-24.5 GHz may be identified as the preferred sub-bands for video SAP/SAB links.

9.1.9 Frequency band 47.20-50.20 GHz

This band is foreseen by the EU to be used for different applications, such as fixed links, fixed-satellite services, broadcasting satellite feeder links, also for RA observations. The bands 47.2-47.5/47.9-48.2 GHz are designated for HAPS and sharing with this service may require caution.

ENG/OB use is envisaged by the EU administrations across the entire band.

This band is not currently demanded for SAP/SAB use in most EU countries. Of 16 countries providing data, six indicated that video SAP/SAB would be allowed, and only one (UK) indicated practical use. Other countries indicated no attitude towards video SAP/SAB links in this band.

Future use by video SAP/SAB links in Europe is unclear, as interest for SAP/SAB in this band is not yet mature. It might be expected that the SAP/SAB designations in the 21.2-24.5 GHz band should be filled first, before attention turns to the 48 GHz band.

Category of video SAP/SAB links

Cordless cameras and temporary point-to-point video links are potential applications in this band.

Prospects of harmonization and preferred sub-bands

Good prospects of harmonization may be seen in this band and its identification as a tuning range for SAP/SAB links should be kept. Further developments in this band would depend on actual requirements for video SAP/SAB links in this range.

9.1.10 Conclusions

From analysis given in the previous subsections it appears, that because of unlikely and, in principle, unnecessary exclusivity of spectrum for video SAP/SAB links and its highly divergent use across various European countries, the harmonization of specific sub-bands is achievable only to certain extent.

Instead, the tuning ranges should be pursued as a major and practical level of harmonizing SAP/SAB spectrum. Such harmonized tuning ranges would allow sufficient level of flexibility to administrations in managing different levels of national demand for SAP/SAB applications, while giving opportunity to manufacturers to achieve sufficient economies of scale, when producing equipment tuneable over the entire identified range.

In case the full tuning range in each band is not initially practicable due to equipment constraints, preferred sub-bands have been identified, where possible, as a best compromise. Consequently, it is recommended that administrations should consider the preferred sub-bands as the first choice, in particular for temporary used assignments.

9.2 Frequency bands for audio links and radio microphones

This section contains an inventory of frequency bands identified for audio SAP/SAB links in general, in particular for radio microphones.

It should be noted, that portable, mobile and temporary point-to-point audio links may be accommodated either in the SAP/SAB bands described in this section, or in other VHF/UHF bands, including PMR bands. This would depend on the particular application scenario, channel width and required transmitter power. It should be noted that identification of harmonized sub-bands for these audio links is not achievable.

9.2.1 Frequency band 174-216 MHz (TV Band III)

This band is identified by the EU as a tuning range for radio microphones. This band is still used for TV transmissions (TV Band III) in many European countries, restricting the wide spread of radio microphones. In some countries, this band is also increasingly used for land mobile services. At least ten EU administrations indicated that they do not allow radio microphones in this band, but in many other countries a large number of radio microphones are in operation.

It also seems that manufacturers focus their future plans on higher bands. In replies to the questionnaire on prospects of digital radio microphones, few manufacturers indicated their wish to produce professional digital radio microphones in the band 174-216 MHz.

However, taking into account a large amount of existing equipment, this band should be identified as a tuning range for audio SAP/SAB applications for the time being.

9.2.2 Frequency band 470-862 MHz (TV Bands IV and V)

TV Bands IV and V are identified as a tuning range for professional radio microphones in EU administrations and currently seem to accommodate the majority of national requirements for professional radio microphones. Only some five EU countries indicated that they do not allow radio microphones in this band.

Other categories of audio SAP/SAB links envisaged in this band are in-ear monitors and portable audio links.

To ensure continued and reliable long term operation of radio microphones and other audio SAP/SAB links in this band it was deemed necessary to answer two major problems, associated mostly with future plans of conversion from analog to digital TV:

- Identify possibilities and means of ensuring continued use of SAP/SAB in TV Bands IV and V after the introduction of digital TV, and in particular during analog-digital simulcasting period.
- Develop solutions for more uniform access to the band for cross-border operations, like touring shows, etc.

Working towards solution of these problems, EU countries initiated some of necessary sharing studies.

Details from manufacturers collected suggested that it would be impracticable to produce one piece of multi-channel equipment, which would be capable of switching across the whole of TV Bands IV and V, at that time the practical switching was only across some three TV channels. However at the time of writing this Report, the switching range of radio microphones on the market already reached up to six TV channels, that is some 48 MHz.

Further indications were that this switching range may be extended up to some 100 MHz in the future, subject to actual demand from users. This extension of switching range may be seen as very important contributing factor towards improved co-existence between broadcasting services and SAP/SAB.

Replies to the questionnaire on future prospects of digital radio microphones showed that most of the manufacturers intend producing digital radio microphones for the band 470-862 MHz.

Assuming all these developments and high interest between manufacturers in exploiting the band 470-862 MHz for current and future SAP/SAB applications, this band should be seen as the vital contributor to satisfying long term demand for audio SAP/SAB applications.

However solutions for ensuring continued co-existence of SAP/SAB with broadcasting after and during introduction of digital TV should be further considered, in close collaboration with the SAP/SAB industry. Further extension of switching range of equipment is one of these solutions, which already now may be explored to a larger extent.

9.2.3 Frequency band 1 785-1 800 MHz

After much searching by some administrations the band 1 785-1 800 MHz was identified as a candidate for harmonized allocation for future (digital) radio microphones. This band is positioned between GSM-1800, operating in the lower adjacent band 1 710-1 785 MHz and TFTS allocation in the upper adjacent band at 1 800-1 805 MHz.

Consequent compatibility studies, showed that a guard band at each end of the new band would be necessary in those countries using GSM-1800 and TFTS. The usable band for radio microphones was therefore effectively limited to 1 785.7-1 799.4 MHz, to protect GSM-1800 operations at the lower band edge and radio microphones from the airborne transmission leg of TFTS at the upper band edge. A licensing procedure was also established in some countries to protect the TFTS ground stations' receive facility, as well as to ensure protection of in-band radio relay operations.

The above identification was ultimately confirmed. The relevant technical characteristics and measurement procedures are described in the ETSI standard EN 301 840 (digital radio microphones) and EN 300 422 (analog radio microphones).

However this band still presents a challenge to manufacturers of professional radio microphones in designing and developing new equipment to the common harmonized standard. At the same time, it also provides marketing and use opportunities across most of Europe. In order to gather actual information on the level of implementation of this band for radio microphones, data was collected from EU administrations by means of specially developed for this purpose questionnaire. Responses from 23 EU administrations were received and only two of those indicated substantial restrictions to introduction of radio microphones in the band.

More detailed review of responses has shown the general positive attitude of EU administrations to the radio microphones in this band and wide degree of acceptance of relevant provisions. Summary of those responses is reproduced in Annex 2 of ECC Report 2.

This positive attitude from EU administrations was echoed by the radio microphone manufacturers, majority of whom in their replies to the aforementioned questionnaire on prospects of digital radio microphones, indicated that they intend to produce digital radio microphones for this band.

If all these expectations become true and the band 1 785-1 800 MHz becomes to a large extent used for radio microphones, this would provide a significant part of long-term solution for ensuring continued and uniform pan-European use of radio microphones.

9.2.4 Conclusions

The wide variety of audio SAP/SAB links, in particular radio microphones, are deployed in the tuning ranges identified for audio SAP/SAB in general and radio microphones in particular.

Of these tuning ranges, the band 174-216 MHz seems to be losing its importance for future SAP/SAB applications, but because of the large base of existing equipment, its identification as SAP/SAB tuning range should be maintained for the time being.

The band 470-862 MHz appears as the vital tuning range for audio SAP/SAB applications, where most of existing and future SAP/SAB use is concentrating. Even with future exploitation of the 1 800 MHz band for radio microphones, the pressure on the band 470-862 MHz is not likely to decrease significantly, as the band 1 785-1 800 MHz will satisfy only part of the overall SAP/SAB demand in the UHF range. Therefore identification of the band 470-862 MHz as a tuning range for audio SAP/SAB applications should be reinforced. In particular, some further measures for ensuring long-term co-existence with TV transmissions during and after conversion to DVB-T should be considered. One of such measures – widening of switching range of equipment, already seems technically feasible.

The band 1 785-1 800 MHz is another solution for long-term uniform use by radio microphones, most EU administrations have already declared their commitment to allow radio microphones to this band. When equipment becomes available for this band, it is likely to satisfy a significant portion of overall demand for audio SAP/SAB applications, such as radio microphones and IEM.

Provisioning of frequencies for portable, mobile and temporary point-to-point audio SAP/SAB links will continuously demand flexible approach, requiring accommodation of higher power links in VHF/UHF ranges, including PMR bands.

9.3 Licensing considerations

Licensing of the SAP/SAB equipment and users demands specific attention by administrations and should differ from the licensing regime of other radiocommunication services. This is because of the typically sporadic pattern of use of SAP/SAB equipment, requiring either some forms of general authorizations or setting up of individual temporary licensing with short application processing times.

Different administrations address these problems differently and solutions range from general authorization (blanket licence) to outsourcing of SAP/SAB licensing functions to specialized companies, providing user tailored licensing services at short notices.

However at least one case requiring certain degree of harmonization is the licensing of visiting foreign ENG/OB teams at short notice. In case a host administration does require individual licences and either does not recognize a licence issued in country of origin of ENG/OB team or frequencies have to be coordinated, then some simplified procedures would be beneficial.

One solution is the promotion of harmonized form for SAP/SAB applications. The current model SAP/SAB ERO application form (refer Annex 4 of ERC/REC 25-10 updated during the planned revision of ERC/REC 25-10). This update aims at producing more informative fields and making the application form better suited for electronic submissions and administrative handling.

10 Future investment in spectrum for ENG

Internationally, the television industry has a significant economic investment in the radio frequency spectrum bands assigned for ENG, both in terms of equipment and also in terms of expertise and techniques which have been developed over decades. The value of the spectrum bands assigned to ENG go beyond the value of the hardware and the resultant programme material. The capability provided by access to the bands assigned to ENG is to some extent a prerequisite for the staging of the major events which then may bring significant broader economic benefits to a country.

Many administrations are looking toward reducing the present radio-frequency spectrum assigned for electronic news gathering as a result of other technologies competing for the bands currently assigned to terrestrial ENG. These proposals will adversely affect the availability of channels needed for a diverse and comprehensive coverage of events. It will limit further development of current terrestrial ENG techniques and capabilities. It will be a disincentive to the industry to invest further in terrestrial ENG by way of the development of additional pick up points and new radio-frequency spectrum efficient equipment. Some proposals for a reduction in the available radio-frequency spectrum for terrestrial ENG has been based upon the yet to realized application of digital terrestrial ENG techniques.

Some administrations are now seeking solutions for continued access to spectrum for terrestrial ENG. Clearly the increasing demand for the spectrum bands used for ENG by other technologies, the associated lack of security of tenure and a potential reduction in total available bandwidth is counter to the pursuit of any broadcast industry long term investment objectives for terrestrial ENG.

11 Impact of digital technologies

11.1 Video links

By the time of writing this Report there was already commercially available equipment for digital video transmissions in SAP/SAB applications. Digital technology promises a lot of advantages to the SAP/SAB industry, such as improved and constant quality of transmitted picture, high robustness, flexible operation modes, decreased size, additional services and effects, etc. So if digital equipment delivers on those promises, then it might be expected that the digital would soon dominate the landscape of SAP/SAB services and applications.

The most popular digital modulation scheme used today is expected to offer advantages over analog links in terms of quality, resilience and range, especially in cluttered environments. However digital links have two drawbacks: they introduce a delay in the transmitted signal, and there is no visible warning of when the link is about to go down (in contrast to the situation with analog links, which will show increased interference in the picture before the link goes down).

In addition, some users have indicated concerns over the range of digital links; whilst others expect digital links to have a 10 dB advantage in a link budget over the analog links currently in use.

This section discusses what impact the introduction of digital technologies will or might have on the spectrum management decisions and solutions for SAP/SAB spectrum. For the purposes of this discussion it applies to European and Japanese frequency assignments and the transmission technologies deployed in these assignments.

11.2 Channel bandwidth of digital radio cameras

Current studies suggest that the typical digital radio camera will employ the DVB-T transmission standard with COFDM modulation. This would give an advantage of using the same technology as for the mass-market delivery, thus helping to drive down the price of cordless cameras.

DVB-T standard was developed so that transmissions would fit into the now standard lattice of terrestrial analog TV transmissions in the VHF/UHF bands, employing an 8 MHz channel raster.

However studies reported to FM PT 41⁷ have demonstrated that employing DVB-T signals for ENG/OB applications would normally require the higher channel bandwidth of 10 MHz. This is caused by the inability to use bulky filtering in the cordless cameras and hence necessity to ensure multi-camera operation in adjacent channels.

It was concluded that the digital video transmissions within the portable and mobile SAP/SAB applications, such as cordless cameras, should be accommodated in the 10 MHz width channel raster. This also allows the combining of two channels within the 20 MHz raster (currently used by analog wireless cameras) when higher quality transmission is required.

If digital cordless cameras were to operate within TV Bands IV and V, they would have to fit within the existing 8 MHz TV channel raster without causing adjacent channel interference.

Digital temporary point-to-point video links, operated in traditional fixed bands (e.g. 7 GHz or 8 GHz band) should be capable of supporting the channel raster of fixed links, usually following the pattern 7/14/28 MHz. If such links were deployed alongside the aforementioned mobile SAP/SAB applications, then in future they should be capable of operating either in the 10 MHz raster, or in the 8 MHz raster, where lesser restrictions to filtering allow.

11.3 Limits on operational frequency

Analysis of performance of DVB-T transmissions in the mobile environment suggests, that the COFDM modulation used in DVB-T is highly susceptible to the effects of Doppler shift of frequency in the reflected multipath signals. This has an adverse effect of limiting the maximum speed of relative displacement of transmitting and receiving terminals.

The studies reported to the FM PT 41 suggested the following figures of maximum speeds of operation of DVB-T terminals for the vehicular mobile environment, as shown in Table 16 below.

⁷ Working Group of European Radiocommunications Office, refer www.ero.dk

TABLE 16

Maximum limits of operational speed for vehicular mobile DVB-T wireless cameras

Mode of operation (COFDM 2K) and frequency	0 dB echo	Rural environment	Urban environment
2.5 GHz			
16-QAM $r = 1/2$	121 km/h	65 km/h	82 km/h
64-QAM $r = 1/2$	91 km/h	35 km/h	52 km/h
3.5 GHz			
16-QAM $r = 1/2$	86 km/h	46 km/h	59 km/h
64-QAM $r = 1/2$	65 km/h	25 km/h	37 km/h

The figures in Table 16 imply that the frequency of 3.5 GHz should be regarded as the practical limit for most typical ENG/OB uses of vehicle mounted wireless cameras.

11.4 HDTV digital terrestrial electronic news gathering (ENG)

Since HDTV digital satellite-broadcasting service was launched in 2000 in Japan, HDTV digital terrestrial ENG systems have been introduced, as well as HDTV digital SNG systems. In Japan, the 5 GHz band (18 MHz bandwidth 2 ch), the 6 GHz band (18 MHz bandwidth 6 ch), the 7 GHz band (18 MHz bandwidth 9 ch), the 10 GHz band (18 MHz bandwidth 18 ch) and the 13 GHz band (18 MHz bandwidth 16 ch) are allocated to the nomadic analog and HDTV digital microwave links. Besides, the 800 MHz band (9 MHz bandwidth 4 ch) are allocated to the nomadic analog and digital SDTV microwave links, and partially to radio microphones. In Tables 17 and 18, examples of user requirements and technical parameters for the transmission of digital TV signals over portable microwave links are shown. In order to meet the requirements, transmission systems were developed. For fixed operation and transmission from helicopters, single carrier QAM systems (ARIB* STD-B11) are used. For mobile transmission and wireless camera systems, OFDM systems (ARIB STD-B33) are used. Each system has a postcard-sized HDTV compression encoder or decoder in it. System parameters for the HDTV/SDTV digital microwave links are shown in Table 19. Moreover, the 42 GHz band (80 MHz bandwidth 5 ch) and the 60 GHz band (1 GHz bandwidth 1 ch) are also allocated to the nomadic TV links and future low-delay HDTV digital microwave links. The frequency bands for the broadcasting programme relay service are assigned exclusively except for some bands which are shared with fixed-satellite services, and only the interference with the same service is mainly considered. It is expected that the demand in the 42 GHz and the 60 GHz bands will increase and that the demand in other bands will remain unchanged.

* ARIB: Association of Radio Industries and Businesses of Japan.

TABLE 17

Example of user requirements and technical parameters for transmission of digital HD/SDTV signals over fixed/airborne (line-of-sight) portable microwave links

		User requirements	Technical parameters
Received picture quality		<i>HDTV:</i> As specified in Rec. ITU-R BT.1121 for 3-codecs in tandem <i>SDTV:</i> As specified in Rec. ITU-R BT.1205 for single codec	<i>HDTV:</i> Video bit rate: 52 Mbit/s (Using ISO/IEC 13818-2 (ITU-T Rec. H.262) 422P@HL with long-GOP) <i>SDTV:</i> Video bit rate: 15 Mbit/s × 3 ch (Using ISO/IEC 13818-2 (ITU-T Rec. H.262) MP@ML with long-GOP)
Received sound quality		Comparable to uncompressed LPCM (48 kHz, 16 bit/ch)	Total audio bit rate: 2 Mbit/s Uncompressed 768 kbit/s per channel × 2 ch MPEG-1 layer II 250 kbit/s per channel × 8 ch
Number of sound channels		2 to 8	
Latency		As short delay as possible	
Transmission bandwidth		18 MHz	Nyquist bandwidth: 13.5 MHz Rolloff: 30% Transmission bit rate: 81 Mbit/s Information bit rate: 60 Mbit/s Modulation: 64-QAM
Transmission power		1.5 W	
Frequency		6-7 GHz, 10 GHz, and 13 GHz bands	
Fixed	Tx antenna	0.6 m dish	Transmission distance: 6-7 GHz: 50-100 km (depending on necessary margin) 10 GHz: 7 km (with necessary rain margin) 13 GHz: 5 km (with necessary rain margin)
	Rx antenna	0.6 m dish	
Airborne	Tx antenna	0.2 m dish	Transmission distance: 6-7 GHz: 50-65 km (depending on necessary margin) 10 GHz: 7 km (with necessary rain margin) 13 GHz: 5 km (with necessary rain margin)
	Rx antenna	1.2 m dish	

TABLE 18

Example of user requirements and technical parameters for transmission of digital HD/SDTV signals over mobile (non line-of-sight) portable microwave links

		User requirements	Technical parameters
Received picture quality		As specified in Rec. ITU-R BT.1205 for single codec	<i>HDTV:</i> Video bit rate: 27 Mbit/s (Using ISO/IEC 13818-2 (ITU-T Rec. H.262) MP@HL with long-GOP) <i>SDTV:</i> Video bit rate: 15 Mbit/s (Using ISO/IEC 13818-2 (ITU-T Rec. H.262) MP@ML with long-GOP)
Received sound quality		Comparable to uncompressed LPCM (48 kHz, 16 bit/ch)	<i>HDTV:</i> Total audio bit rate: 2 Mbit/s Uncompressed 768 kbit/s per channel × 2 ch MPEG-1 layer II 250 kbit/s per channel × 8 ch <i>SDTV:</i> MPEG-1 layer II 250 kbit/s per channel × 4 ch
Number of sound channels		HDTV: 2 to 8 SDTV: 1 to 4	
Latency		As short delay as possible	< 500 ms
Transmission bandwidth		HDTV: 18 MHz SDTV: 9 MHz	<i>HDTV:</i> Information bit rate: 32 Mbit/s Modulation: 16-QAM/QPSK- OFDM <i>SDTV:</i> Information bit rate: 16 Mbit/s Modulation: 16-QAM/QPSK- OFDM
UHF	Transmission power	HDTV: 18 W SDTV: 5 W	Transmission distance: 4 km
	Frequency	800 MHz band	
	Tx antenna	Co-linear	
	Rx antenna	Yagi	
Microwave	Transmission power	HDTV: 5 W SDTV: 2.5 W	Transmission distance: 4 km
	Frequency	6-7 GHz, 10 GHz and 13 GHz bands	
	Tx antenna	Horn	
	Rx antenna	0.3 m dish	

TABLE 19
**System parameters for HDTV/SDTV digital terrestrial electronic
 news gathering (ARIB STD-B11 and B33)**

Frequency band	800 MHz	5, 6, 7, 10 and 13			GHz
ARIB standard	STD-B33	STD-B33	STD-B33	STD-B11	
Channel spacing	9 (SDTV)	9 (SDTV)	18 (HDTV)	18 (HDTV)	MHz
Capacity (payload)	Up to 16	Up to 30	Up to 60	Up to 66	Mbit/s
Modulation	QPSK-OFDM 16-QAM-OFDM 32-QAM-OFDM	QPSK-OFDM 16-QAM-OFDM 32-QAM-OFDM 64-QAM-OFDM	QPSK 16-QAM 32-QAM 64-QAM		Digital
Typical transmit antenna gain	5-10	29-35	29-35	29-35	dBi
Transmit feeder loss (min)	1	1	1	1	dB
Transmit antenna type	Colinear/Yagi	Parabolic	Parabolic	Parabolic	
Transmit power (max)	7	4	7	1.76	dBW
EIRP (max)	11-16	32-38	35-41	30-36	dBW
Typical receive antenna gain	10-15	29-35	29-35	29-35	dBi
Receive antenna type	Yagi	Parabolic	Parabolic	Parabolic	
Receive feeder loss (max)	1	1	1	1	dB
Receiver IF bandwidth	9	9	18	18	MHz
Receive noise figure	4	4	4	4	dB
Receiver thermal noise	-130.5	-130.5	-127.4	-127.4	dBW

11.5 Radio microphones

By the time of writing this Report, there was still large uncertainty with regard to the future prospects of digital technology for professional radio microphones. Few models of consumer digital radio microphones have been produced and tested in ISM bands (2.4 GHz), and they were found to be unsatisfactory for professional use because of audio delay and poor sound quality. Professional digital radio microphones in the band 1 785-1 800 MHz and in the TV Bands IV and V are yet to be developed.

Therefore it was decided to consider this issue from two different perspectives, resulting in two following subsections. First, the potential benefits of digital technology for radio microphone applications are considered from the theoretical point of view. Then, expectations of some of the current radio microphone manufacturers are summarized, based on the results of a questionnaire. A third subsection summarizes this analysis by providing comparison of expected spectral efficiency of digital vs. conventional analog radio microphones.

11.6 Analytical study of digital radio microphones

The studies reported to the FM PT 41 did suggest several assumptions, which might provide the basic specifications for considering the potential advantages of digital technologies for radio microphones. Among these were the following:

- The audio coding may be similar to that of existing NICAM-728 standard. Therefore assumed "mono-NICAM" configuration would require bit rate of 384 Kb/s.

- The necessity of channel coding (FEC = 1/2) would increase the transmission bit rate to 768 Kb/s.
- It was assumed that the basic modulation could be 25% root-raised cosine QPSK. If greater multipath tolerance were required, modulation like QPSK-COFDM could be used, yielding similar conclusions in terms of necessary bandwidth.

The above assumptions would mean that a theoretically estimated necessary spectral bandwidth of the digital radio microphones is 480 kHz, suggesting the potential channel spacing of 500 kHz.

The estimated channel width of 500 kHz is larger than the 200 kHz currently used by analog radio microphones. However, the same study analysed the impacts of non-linear amplification and reverse intermodulation in the transmission sections of simulated digital radio microphones. These simulations produced evidence, supporting the conclusion, that adjacent channel operation of digital radio microphones might be feasible, as opposed to the limitations imposed by intermodulation on analog radio microphones.

This would mean that although requiring higher bandwidth, the digital radio microphones may be potentially more spectrum efficient.

11.7 Digital radio microphones developments

In order to gather information on practical developments and future prospects of digital radio microphones, a questionnaire was distributed to radio microphone manufacturers in the summer of 2001. The responses from 10 manufacturers are summarized as follows:

- the problem of noticeable audio delay, resulting from digital signal processing, is seen as a major limiting factor in the up-take of digital technology (this may be controlled to some extent in broadcasting but may prohibit digital radio microphones for use in live theatre);
- however, all manufacturers announced their commitment to manufacture digital radio microphones, somewhere between the year 2001 and year 2003;
- 80% of manufacturers aim at producing digital microphones for the TV Bands IV and V, 80% – for the band 1 800 MHz;
- manufacturers expect that between 8-15 digital radio microphones could be colocated within the sub-band of 8 MHz;
- manufacturers expect that the switching and tuning ranges of digital radio microphones will remain essentially the same as of contemporary analog radio microphones, that is 15-24 MHz (three TV channels) and 50-100 MHz respectively.

Essentially all this means that currently the industry seems to be cautiously positive regarding the prospects of digital technologies, being sure that developments lie with the digital technology, but not sure exactly what benefits it would bring.

After completion of the survey some further statements were received providing further evidence that the radio microphones' manufacturers might be able to expand the switching range of their future products beyond the currently commercially available range of 3-6 UHF TV channels.

11.8 Performance comparison of digital vs. analog radio microphones

From the limited information available at the time of writing this Report, it was not possible to make a reliable estimate as to the performance characteristics and co-existence capabilities of future digital radio microphones. Therefore Table 20 compares the performance of contemporary analog radio microphones with analytically predicted as well as manufacturers' estimated performance of future digital radio microphones.

TABLE 20

Performance comparison of future digital vs. contemporary analog radio microphones

Type of radio microphones	Number of microphones used simultaneously at one location within a			
	Single 8 MHz block in Bands IV and V	Contiguous 2 × 8 MHz block	2 × 8 MHz blocks, separated by 8 MHz	Band 1 785.7-1 799.4 MHz
Typical analog today (200 kHz)	8...10	11	16	10 (estimate)
High performance analog today (200 kHz)	10...12	–	–	–
Theoretically simulated digital (500 kHz)	16	32	32	27
Currently envisioned by manufacturers digital	7...15	(1)	(1)	8...25

(1) Although manufacturers in their reply to the questionnaire did not specify the numbers, majority expressed preference for contiguously allocated channels for future digital radio microphones, as opposed to non-contiguous spectrum.

It becomes clear from the data given in Table 20, that even if digital radio microphones required larger channel width, they are still likely to provide much higher (2 to 3 times) spectral efficiency because of better co-existence features (more dense colocation).

It should be noted that the theoretical specification of 500 kHz microphone channels shown in Table 20 is optimistic. As most radio microphones are classified as consumer electronics products and operate in bands currently allocated to broadcasting, administrations have set limitations for their use to protect adjacent services. The establishment of frequency guardbands at the upper and lower ends of the television channel would reduce by a factor of 1 or 2, the number of available microphone channels.

11.9 Spectrum and operation of radio microphones and planning for digital radio microphones in Japan

11.9.1 Spectrum and operation of radio microphones

In Japan, the 70 MHz band (74.58-74.76 MHz), the 300 MHz band (322.025-322.400 MHz), the 800 MHz band (806.125-809.750 MHz) are allocated to radio microphone for low power radio station, for which license is not required. Besides, 779.125-787.875 MHz and 797.125-805.875 MHz are allocated to radio microphone for land mobile radio station for professional use, for which license is required. The latter two bands are shared with nomadic analog and digital SDTV links. System parameters for radio microphones are shown in Table 21.

A federation of radio microphone users coordinates the operation in the bands 779.125-787.875 MHz and 797.125-805.875 MHz to avoid collision and ensure interference-free operation.

In densely populated areas, the number of channels (frequency) has become insufficient recently. To solve this problem, currently, the standardization of the digital radio microphone is being discussed. Experimental systems for digital radio microphones have been developed and already been tested in studio and outside studio, in consideration of the actual operation.

11.9.2 Study of digital radio microphones

In discussing the specifications for the digital radio microphone, it is most important to keep the optimized balance between the transmission delay and transmission bandwidth. Four experimental systems for digital radio microphone have been developed. They employ 128 ksymbol/s (192 kHz bandwidth) or 192 ksymbol/s (288 kHz bandwidth), and QPSK or 8-PSK for modulation.

The duplex communication system has worked in addition to the one-way communication system.

Transmission delay varies from 2 to 6 ms depending on the difference of the audio coding process, transmission codec, modulation method, and so on.

This suggests that the coordination of the system parameter is required to achieve the quality which meets the user's requirements.

The sound quality of the SB-ADPCM-based codec at a bit rate of 192 kbit/s and with audio bandwidth up to 20 kHz has been evaluated based on Recommendation ITU-R BS.1116. The result shows that the codec provides the same quality as the source in 95% confidence interval.

The influence of the multipath fading on the radio propagation is the important factor for the digital radio microphone. The quality degradation by the data error due to multipath fading in a large-scale studio will be improved by choosing appropriate modulation parameters.

The digital system is more effective in sharing band with other ENG systems and the channels (frequency) can be used effectively because the coordination distance between each operation can be short.

In addition to the one way communication, the duplex communication including the function of transmission power control has been tested in studio. Although the one way system is usually used for radio microphone, the duplex system makes it possible to communicate and control various kinds of information between the microphone and the receiver.

From the result of our experiment, it has been found that the number of usable channels can be increased by the introduction of digital microphone systems. Standardization is under way towards the next generation radio microphone system.

TABLE 21

Spectrum and operation of radio microphones in Japan

Standard	RCR ⁽¹⁾ STD-15 V 4.0 (2000-07)	RCR STD-22 V 2.0 (2000-07)
	Radio microphone for specified low power radio station	Specified radio microphone for land mobile radio station
Frequency assignment	70 MHz band: 74.58-74.76 MHz 300 MHz band: 322.025-322.400 MHz 800 MHz band: 806.125-809.750 MHz	779.125-787.875 MHz, 797.125-805.875 MHz (with compander) 779.250-787.750 MHz, 797.250-805.750 MHz (without compander/stereo)
Communication system	70 MHz band: multicast communication 300 MHz, 800 MHz band: 1-way or multicast communication	One-way or multicast communication
Type of emission	70 MHz band: F3E, F8W 300 MHz, 800 MHz band: F1D, F2D, F3E, F8W, F9W	F3E, F8W, F8E

TABLE 21 (end)

Type of modulation	Frequency modulation		Frequency modulation	
Antenna power	70 MHz band	10 mW	10 mW	
	300 MHz band	1 mW		
	800 MHz band	10 mW		
Tolerance of antenna power	–	–50% to +20%	–50% ~ +20%	
Frequency tolerance	70 MHz band	20×10^{-6} (0.002%)	20×10^{-6} (0.002%)	
	300 MHz band	10×10^{-6} (0.001%)		
	800 MHz band	20×10^{-6} (0.002%)		
Maximum deviation	70 MHz band	± 20 kHz max.	With compander	± 40 kHz max.
	300 MHz band	± 8 kHz max.	Without compander	± 150 kHz max.
	800 MHz band	± 40 kHz max.	Stereo transmission	± 75 kHz max.
Occupied bandwidth	70 MHz band	60 kHz	Max. deviation < ± 40 kHz	110 kHz (99% of total power)
	300 MHz band	30 kHz	± 40 kHz < Max. deviation < ± 150 kHz	330 kHz (99% of total power)
	800 MHz band	110 kHz	stereo transmission	250 kHz (99% of total power)
Adjacent channel power ratio $10\log(P_c/P_{ac})$ P_c : carrier power P_{ac} : Adjacent channel power	70 MHz band	60 dB (at $f_c \pm 120$ kHz)	Max. deviation < ± 40 kHz	60 dB (channel spacing = 250 kHz)
	300 MHz band	60 dB (at $f_c \pm 50$ kHz)	± 40 kHz < Max. deviation < ± 150 kHz	60 dB (channel spacing = 500 kHz)
	800 MHz band	60 dB (at $f_c \pm 250$ kHz)	stereo transmission	60 dB (channel spacing = 500 kHz)
	70 MHz band: BW = 60 kHz 300 MHz band: BW = 30 kHz 800 MHz band: BW = 110 kHz		Max. deviation < ± 40 kHz: BW = 110 kHz ± 40 kHz < Max. deviation < ± 150 kHz: BW = 330 kHz stereo transmission: BW = 250 kHz	
Spurious emissions	< 2.5 μ W		< 2.5 μ W	
License	Not required		Required	
Collision avoidance between users	Not coordinated		Coordinated	

⁽¹⁾ Research & Development Center for Radio System of Japan.

ARIB Standard RCR STD-15 V 4.0 (Radio-microphone for specified low power radio station)

ARIB Standard RCR STD-22 V 2.0 (Specified radio-microphone for land mobile radio station)

12 Data collection for evaluation of user requirements and spectrum usage for terrestrial electronic news gathering (ENG) – October 2004

Administrations have been requested to provide the following information to the Rapporteur for spectrum usage and user requirements for terrestrial electronic news gathering. The following data collection has been received by the Rapporteur. Further data is to be collected from administrations.

TABLE 22

REGION 1

Slovenia

Item	Topic	Information required
1	Frequency bands	
1.1	Identification of the national frequency allocations (including footnotes)/radio-frequency channel arrangements and channel assignments applying to such nomadic TV links.	2 300-2 500 MHz S5.150, S5.282, S5.371, S5.398, S5.399, S5.402 The channels assigned to national operators: 2 300-2 325 MHz 2 400-2 425 MHz 2 350-2 375 MHz 2 425-2 450 MHz The channels assigned to foreign (visiting) operators: 2 375-2 400 MHz 2 475-2 500 MHz
1.2	Identification of additional frequency bands that are utilized by administrations for nomadic TV links.	10.00-10.68 GHz 21.20-24.50 GHz 47.20-50.20 GHz
1.3	Identification of any changes planned by administrations to the utilization of such bands. In such cases, to which frequency band(s) are administrations planning to relocate ENG, NOB or TOB services?	With introduction of digital TV links the channel arrangement in 2 300-2 500 MHz band will be step by step relocated according to CEPT/ERC/REC 25-10.

TABLE 22 (continued)

REGION 1 (continued)

Slovenia (continued)

Item	Topic	Information required
2	Level of availability	
2.1	Identification of the required availability of nomadic TV links and the nature and extent of such availability and deployment for each of the identified bands.	Availability – 24 hr national use and coverage, irregular usage patterns. Required availability during operation: 99.95% for all bands. Deployment – used extensively in major urban/suburban areas and frequently in nearby rural areas.
2.2	Identification of the technical and operational characteristics of nomadic TV links, apply for applications such as news coverage, sports programme production, live programme, including the level of availability.	News coverage – spontaneous application required 24 hr/day all year, coordination difficult. Necessity of worldwide harmonization for the operation of nomadic TV links.
3	Interference	
3.1	Identification of the technical and operational characteristics of nomadic TV links, including statistical information such as how often they are deployed, hours of operation and duration (e.g. for satellite service sharing studies information on the azimuthal pointing direction of nomadic TV links is particularly relevant), and the percentage of usage that is live on-air.	News coverage – several ENG vehicles deployed during daylight hours by all licensees. Duration of each event and duration of active reporting time varies. Fewer deployments between midnight and 6 a.m. Approximate hours of operation (all operators): 5 500 hours/year.
3.2	Identification of whether the current usage experiences noticeable interference while operating in the identified bands and channels.	Interferences are noticeable in urban areas.
3.3	Indication of the magnitude of interference generally experienced. Specify if sporadic or constant.	Sporadic interferences > -60 dBm.
3.4	Identification of the major sources of interference.	Domestic and foreign fixed links.
4	Potential for harmonization	
4.1	Band(s) where worldwide harmonization for the operation temporary nomadic TV links may be achieved.	2 300-2 500 MHz 10.00-10.68 GHz 21.20-24.50 GHz 47.20-50.20 GHz

TABLE 22 (continued)

REGION 1 (continued)

Slovenia (end)

Item	Topic	Information required
5	Coordination	
5.1	Identification of how nomadic TV links and their usage is coordinated for general operations.	See item 1.1.
5.2	Are all aspects of the operations coordinated – or is coordination confined to high-importance locations (e.g. hub collection sites)?	See item 1.1.
5.3	Identification of whether such coordination process is achieved through national or regional coordination processes.	Through national coordination process.
6	Expected future spectrum demand	
6.1	Based on recent experience, estimation of the demand foreseen in five and ten years.	No essential increase of demand is foreseen. Impact of digitalization yet to be determined.

National usage of bands for video SAP/SAB links within CEPT countries at June 2001 are listed in Document 6P/6 Part 2 Annex 1 (reference ECC Report 2).

TABLE 22 (continued)

REGION 1 (continued)

Lithuania

Item	Topic	Information required
1	Frequency bands	
1.1	Identification of the national frequency allocations (including footnotes)/radio-frequency channel arrangements and channel assignments applying to such nomadic TV links.	2 025-2 110 MHz 2 200-2 690 MHz 3 400-3 600 MHz 10-10.6 GHz 21.2-21 GHz 22.6-23 GHz 24.25-24.5 GHz.
1.2	Identification of additional frequency bands that are utilized by administrations for nomadic TV links.	Unplanned.
1.3	Identification of any changes planned by administrations to the utilization of such bands. In such cases, to which frequency band(s) are administrations planning to relocate ENG, NOB or TOB services?	Unplanned.
2	Level of availability	
2.1	Identification of the required availability of nomadic TV links and the nature and extent of such availability and deployment for each of the identified bands.	
2.2	Identification of the technical and operational characteristics of nomadic TV links, apply for applications such as news coverage, sports programme production, live programme, including the level of availability.	Radio-frequency channel can be assign for temporal use.
3	Interference	
3.1	Identification of the technical and operational characteristics of nomadic TV links, including statistical information such as how often they are deployed, hours of operation and duration (e.g. for satellite service sharing studies information on the azimuthal pointing direction of nomadic TV links is particularly relevant), and the percentage of usage that is live on-air.	Data does not exist.

TABLE 22 (continued)

REGION 1 (end)**Lithuania (end)**

Item	Topic	Information required
3.2	Identification of whether the current usage experiences noticeable interference while operating in the identified bands and channels.	Data does not exist.
3.3	Indication of the magnitude of interference generally experienced. Specify if sporadic or constant.	–
3.4	Identification of the major sources of interference.	
4	Potential for harmonization	
4.1	Band(s) where worldwide harmonization for the operation temporary nomadic TV links may be achieved.	See item 1.1.
5	Coordination	
5.1	Identification of how nomadic TV links and their usage are coordinated for general operations.	It does not coordinate.
5.2	Are all aspects of the operations coordinated – or is coordination confined to high-importance locations (e.g. hub collection sites)?	–
5.3	Identification of whether such coordination process is achieved through national or regional coordination processes.	–
6	Expected future spectrum demand	
6.1	Based on recent experience, estimation of the demand foreseen in five and ten years.	Not completed by contributor.

TABLE 22 (continued)

REGION 2

Colombia

Item	Topic	Information required
1	Frequency bands	
1.1	Identification of the national frequency allocations (including footnotes)/radio-frequency channel arrangements and channel assignments applying to such nomadic TV links.	10.5-10.68 GHz 10.532 GHz, 10.560 GHz, 10.588 GHz, 10.616 GHz, 10.644 GHz, 10.672 GHz NOTE – This frequency band is now no longer being used by any television station. Colombia intends to delete this allocation.
1.2	of additional frequency bands that are utilized by administrations for nomadic TV links.	Although the following sub-bands are not allocated for nomadic TV systems, frequencies have been assigned for these systems taking into account the mobile allocation. Sub-bands: 2 000-2 200 MHz 2 300-2 700 MHz 12 700-13 300 MHz
1.3	Identification of any changes planned by administrations to the utilization of such bands. In such cases, to which frequency band(s) are administrations planning to relocate ENG, NOB or TOB services?	Columbia, by Resolution 0008 of 7 January 2004 “By which radio-frequency bands are allocated and channelled within the national territory for the operation of nomadic television transmission systems ...has allocated the band 2 025-2 100 MHz. All nomadic TV systems operating within Colombia will be required to migrate to this band. (this national Resolution may be consulted ⁽¹⁾)
2	Level of availability	
2.1	Identification of the required availability of nomadic TV links and the nature and extent of such availability and deployment for each of the identified bands.	In the band referred to in § 1.3 there are 15 channels with adjacent separation of 5 MHz. Since the regulations are new, no assignments have yet been made under this channelling arrangement.

(1) <http://www.mincomunicaciones.gov.co/Archivos/normatividad/2004/Resolucion/R00008d2004.pdf>

TABLE 22 (continued)

REGION 2 (continued)

Colombia (continued)

Item	Topic	Information required
2.2	Identification of the technical and operational characteristics of nomadic TV links, apply for applications such as news coverage, sports programme production, live programme, including the level of availability.	The only characteristics specified in Resolution 0008 of 7 January 2004 are that the bandwidth must be equal to or less than the bandwidth of the channels established in the Resolution (5 MHz) and that one of the channels that is free from interference at the location at the time of the event may be selected.
3	Interference	
3.1	Identification of the technical and operational characteristics of nomadic TV links, including statistical information such as how often they are deployed, hours of operation and duration (e.g. for satellite service sharing studies information on the azimuthal pointing direction of nomadic TV links is particularly relevant), and the percentage of usage that is live on-air.	These systems are used on a daily basis for the presentation of live news outside broadcasts normally lasting up to three minutes, although in exceptional circumstances such broadcasts can last several hours. They are also used for the transmission of sporting events, generally on a weekly basis (weekends) and with an average duration of two hours.
3.2	Identification of whether the current usage experiences noticeable interference while operating in the identified bands and channels.	In the sub-bands referred to in § 1.2, i.e. those which have thus far been used, occasional interference has been experienced.
3.3	Indication of the magnitude of interference generally experienced. Specify if sporadic or constant.	The interference thus far has been very sporadic.
3.4	Identification of the major sources of interference.	The major source of interference tends to be other nomadic TV systems (i.e. those of other networks), such interference occurring when several companies turn up to cover the same event. It arises on account of intermodulation effects and, in some cases, sharing of the same bandwidth.
4	Potential for harmonization	
4.1	Band(s) where worldwide harmonization for the operation temporary nomadic TV links may be achieved.	Our Administration is of the view that the harmonization of such systems may be achieved in the band 2 025-2 100 MHz.

TABLE 22 (continued)

REGION 2 (continued)

Colombia (end)

Item	Topic	Information required
5	Coordination	
5.1	Identification of how nomadic TV links and their usage is coordinated for general operations.	Pursuant to the provisions of Article 6 of Resolution 0008 of 7 January 2004, coordination is effected at the site so that a user subsequently arriving at the event will use one of the free channels within the allocated band, in order not to cause interference to those users having arrived first.
5.2	Are all aspects of the operations coordinated – or is coordination confined to high-importance locations (e.g. hub collection sites)?	The only aspect to be coordinated is that referred to in § 1 and is a requirement for any location.
5.3	Identification of whether such coordination process is achieved through national or regional coordination processes.	
6	Expected future spectrum demand	
6.1	Based on recent experience, estimation of the demand foreseen in five and ten years.	Given the number of television channels that exist in Colombia, the band allocated to nomadic TV systems (2 025-2 100 MHz) is estimated to be sufficient to meet the needs of all of the networks for the next ten years.

TABLE 22 (continued)

REGION 2 (continued)

United States of America

Item	Topic	Information required
1	Frequency bands	
1.1	Identification of the national frequency allocations (including footnotes)/radio-frequency channel arrangements and channel assignments applying to such nomadic TV links.	<p>2 025.0-2 025.5 MHz (twenty 25 kHz wide data return link (DRL) channels for transmissions from an ENG-receive only site to an originating ENG platform; see Fig. 1).</p> <p>2 025.5-2 109.5 MHz (seven 12 MHz wide channels primarily used by ENG).</p> <p>2 109.5-2 110.0 MHz (an additional twenty 25 kHz wide DRL channels).</p> <p>2 450-2 483.5 MHz (16.5 and 17 MHz wide channels primarily used by ENG).</p> <p>2 483.5-2 500 MHz (one 16.5 MHz wide channel primarily used by ENG, on a “grandfathered” basis).</p> <p>NOTE – There is a pending proposal to reformat the 2.5 GHz TV BAS band into three 12 MHz wide digital channels, from 2 500-2 586 MHz; see Fig. 2.</p>
1.2	Identification of additional frequency bands that are utilized by administrations for nomadic TV links.	<p>25.8-26.5 MHz (remote pickup (RPU) stations).</p> <p>152-162 MHz (RPU stations).</p> <p>174-216 MHz (wireless microphones and cameras as secondary services).</p> <p>450-451; 455-456 MHz (RPU stations).</p> <p>470-806 MHz (wireless microphones and cameras as secondary services).</p> <p>944-952 MHz (fixed or mobile aural bas, studio-to-transmitter links (STL), Inter-City Relay (ICR)).</p> <p>6 425-6 525 MHz (1, 8 and 25 MHz wide channels for mobile usage only).</p>

⁽²⁾ ICR: Inter-city relay – Broadcast auxiliary service link carrying TV between and within cities.

TABLE 22 (continued)

REGION 2 (continued)

United States of America (continued)

Item	Topic	Information required
		<p>6 875-7 125 MHz (25 MHz wide channels, primarily point-to-point fixed links, but also some TV pickup (ENG) mobile operations).</p> <p>12 700-13 250 MHz (25 MHz wide channels, primarily point-to-point links shared with Cable Television Relay Service (CARS), but also some TV pickup (ENG) mobile operations. NOTE – CARS stations also use 6 and 12.5 MHz wide channels).</p> <p>17 700-19 700 MHz (2, 6, 10, 20, 40 and 80 MHz wide channels, primarily point-to-point links; Aural and TV STLs and ICRs; temporarily co-primary with fixed satellite until 8 June 2010).</p> <p>19 300-19 700 MHz (primarily point-to-point links; Aural and TV STLs and ICRs).</p>
1.3	Identification of any changes planned by administrations to the utilization of such bands. In such cases, to which frequency band(s) are administrations planning to relocate ENG, NOB or TOB services?	The 2 GHz band has recently undergone a reduction in the allocated bandwidth as illustrated in Fig. 1.
2	Level of availability	
2.1	Identification of the required availability of nomadic TV links and the nature and extent of such availability and deployment for each of the identified bands.	<p>Availability – 24 h national use and coverage, irregular usage patterns.</p> <p>Deployment – used extensively in major urban and suburban areas and frequently in rural areas.</p>
2.2	Identification of the technical and operational characteristics of nomadic TV links, apply for applications such as news coverage, sports programme production, live programme, including the level of availability.	<p>News coverage – spontaneous application required 24 h/day – 7 days/week; coordination is difficult; scheduled events permit coordination.</p> <p>Sports – scheduled events permit coordination.</p> <p>Live programmes – scheduled events permit coordination.</p>

⁽³⁾ CARS – A radio service used to deliver TV signals to cable systems via fixed point-to-point and multipoint microwave stations.

TABLE 22 (continued)

REGION 2 (continued)

United States of America (continued)

Item	Topic	Information required
3	Interference	
3.1	Identification of the technical and operational characteristics of nomadic TV links, including statistical information such as how often they are deployed, hours of operation and duration (e.g. for satellite service sharing studies information on the azimuthal pointing direction of nomadic TV links is particularly relevant), and the percentage of usage that is live on-air.	<p>News coverage – several ENG vehicles by all licensees 24 h/day – 7 days/week. Duration of each event varies and active use varies.</p> <p>Sports – scheduled deployment of nomadic use of links at sports confined to the duration of the event with some pre- and post-production. Intensive spectrum utilization at the scheduled location.</p> <p>Live programmes – scheduled deployment of nomadic use of links at live events confined to the duration of the event with some pre- and post-production. Intensive spectrum utilization at the scheduled location.</p> <p>SNG – utilization is primarily news and live programmes from remote locations. Deployments can be extensive.</p> <p>Satellite varies by licensee.</p>

TABLE 22 (continued)

REGION 2 (continued)

United States of America (continued)

Item	Topic	Information required
3.2	Identification of whether the current usage experiences noticeable interference while operating in the identified bands and channels.	<p>Minimal interference experienced between terrestrial ENG licensees due to good, and often exceptional, frequency coordination practices, even between competing stations.</p> <p>The space research (Earth-to-space; space-to-space), space operations (Earth-to-space; space-to-space), and Earth exploration-satellite (Earth-to-space; space-to-space) services are allocated in the band 2 025-2 110 MHz. These services have been operating for years without any noticeable interference to ENG operations.</p> <p>There is recognized interference in the 2 450-2 483.5 MHz TV BAS band from Part 15 (unlicensed) “Wi-Fi” devices, and from Part 18 industrial, scientific and medical (ISM) devices operating at 2 450 MHz with a ± 50 MHz frequency tolerance.</p> <p>There is the potential for interference to “grandfathered” Channel A10 (2 483.5-2 500 MHz) TV BAS operations from authorized but not yet operational MSS ancillary terrestrial component (ATC) base stations, at 2 487.5-2 493 MHz.</p> <p>There is also potential interference from newly created Broadband Radio Service (BRS) Channel 1, at 2 496-2 502 MHz, to grandfathered TV BAS Channel A10 operations.</p>
3.3	Indication of the magnitude of interference generally experienced. Specify if sporadic or constant.	Coordination is required between space uplink operations and ENG sites to preclude interference. Space-to-space communications is required to meet a power flux-density limit on the surface of the Earth to preclude interference to ENG operations.

TABLE 22 (continued)

REGION 2 (end)

United States of America (end)

Item	Topic	Information required
3.4	Identification of the major sources of interference.	Earth-to-space communications with EIRPs between 95 and 115 dBm. Part 15 Wi-Fi stations with TPOs of up to 1 Watt and EIRPs of up to 4 Watts. MSS ATC base stations with EIRPs of up to 1 600 Watts. BRS Channel 1 base stations with EIRPs of up to 1 600 Watts.
4	Potential for harmonization	
4.1	Band(s) where worldwide harmonization for the operation temporary nomadic TV links may be achieved.	
5	Coordination	
5.1	Identification of how nomadic TV links and their usage is coordinated for general operations.	Coordination between licensees through the Society of Broadcast Engineers, Inc. (SBE)
5.2	Are all aspects of the operations coordinated – or is coordination confined to high-importance locations (e.g. hub collection sites)?	Coordination is required in large cities, near large sports venues, and at locations where news coverage is intense and may be congested.
5.3	Identification of whether such coordination process is achieved through national or regional coordination processes.	Applicants typically use local area SBE coordinators or coordination committees.
6	Expected future spectrum demand	
6.1	Based on recent experience, estimation of the demand foreseen in five and ten years.	News coverage by its ratings is in high demand throughout the United States and is expected to increase further. As the technology for handheld and higher resolution cameras improves the demand for higher bandwidths will increase.

TABLE 22 (continued)

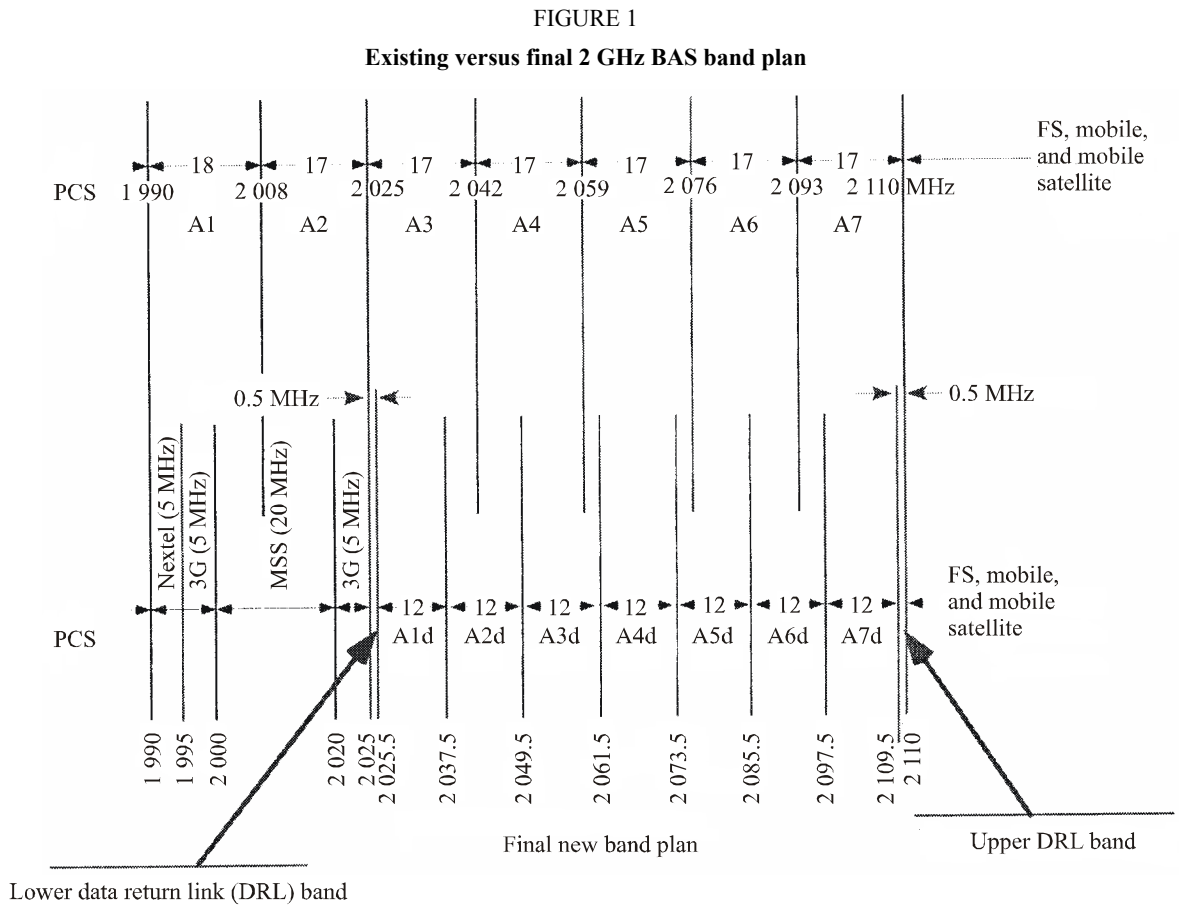

- FS: Fixed service
- PCS: Personal communication service
- MSS: Mobile-satellite service
- 3G: Third generation wireless service

TABLE 22 (continued)

FIGURE 2
Proposed 2.5 GHz TV BAS band plan
Existing

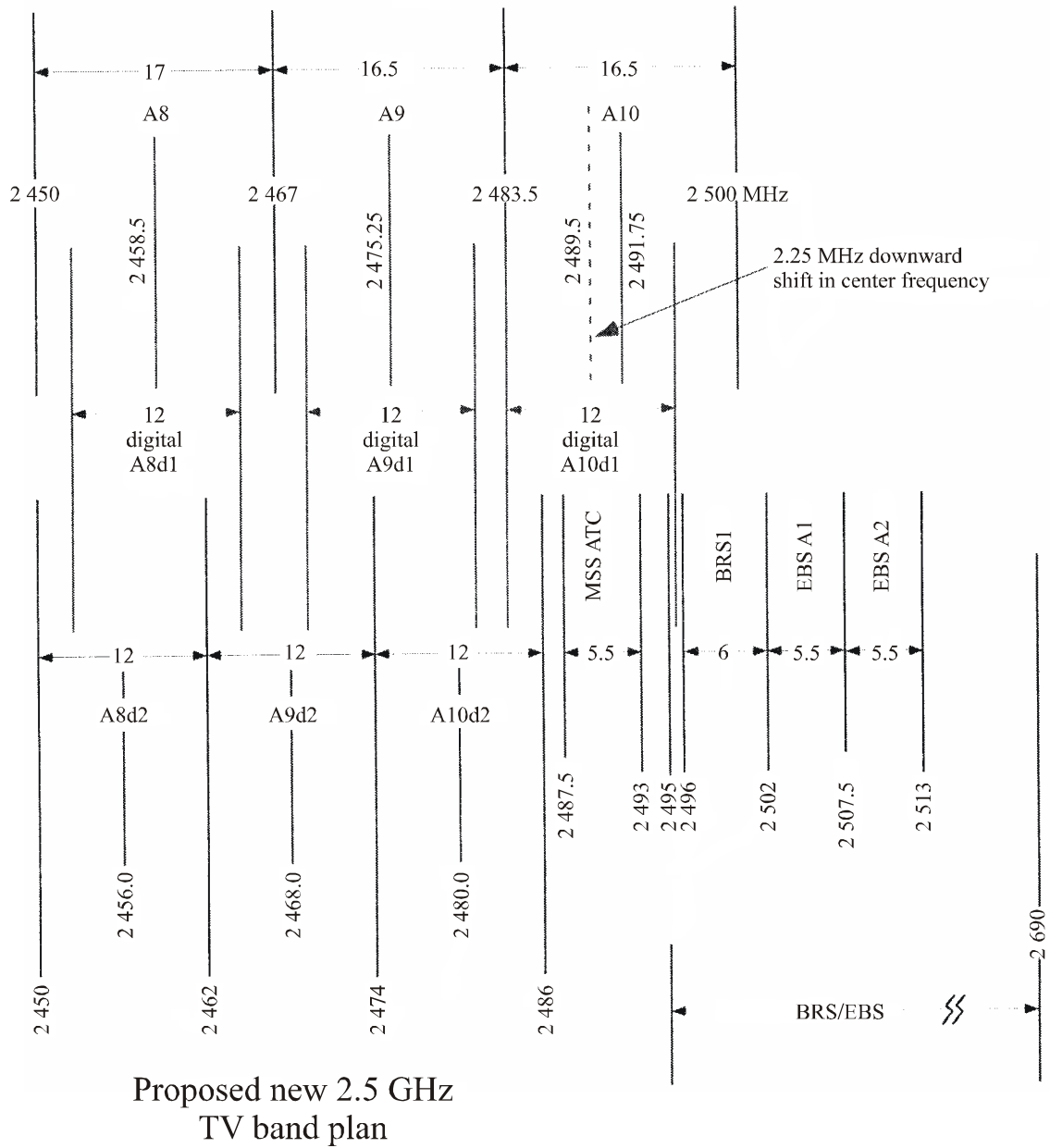

BRS: Broadband radio service
 EBS: Educational broadband service
 MSS ATC: Mobile-service (MSS) ancillary terrestrial component (ATC)

TABLE 22 (continued)

REGION 3**Australia**

Item	Topic	Information required
1	Frequency bands	
1.1	Identification of the national frequency allocations (including footnotes)/radio-frequency channel arrangements and channel assignments applying to such nomadic TV links.	2 450-2 690 MHz.
1.2	Identification of additional frequency bands that are utilized by administrations for nomadic TV links.	7 100-7 425 MHz (subject to sharing arrangements), 12.75-13.25 GHz.
1.3	Identification of any changes planned by administrations to the utilization of such bands. In such cases, to which frequency band(s) are administrations planning to relocate ENG, NOB or TOB services?	2 450-2 690 MHz moving to 2 500-2 690 MHz in February 2005.
2	Level of availability	
2.1	Identification of the required availability of nomadic TV links and the nature and extent of such availability and deployment for each of the identified bands.	Availability – 24 h national use and coverage, irregular usage patterns. Deployment – used extensively in major urban/suburban areas and frequently in nearby rural areas.
2.2	Identification of the technical and operational characteristics of nomadic TV links, apply for applications such as news coverage, sports programme production, live programme, including the level of availability.	News coverage – spontaneous application required 24 hr/day all year, coordination difficult. Some long link requirements. Channel optimization required including interleaving with analog links. Sports – scheduled events permit coordination. Link paths and channel selection open to planning. Live programmes – scheduled events permit coordination. Link paths and channel selection open to planning.

TABLE 22 (continued)

REGION 3 (continued)

Australia (continued)

Item	Topic	Information required
3	Interference	
3.1	Identification of the technical and operational characteristics of nomadic TV links, including statistical information such as how often they are deployed, hours of operation and duration (e.g. for satellite service sharing studies information on the azimuthal pointing direction of nomadic TV links is particularly relevant), and the percentage of usage that is live on-air.	News coverage – several ENG vehicles deployed during daylight hours by all licensees. Duration of each event and duration of active reporting time varies. Fewer deployments between midnight and 5 a.m. Sports – scheduled deployment of nomadic use of links at sports confined to duration of sports event. Some pre and post production. Intensive spectrum utilization at the scheduled location. Live programmes – scheduled deployment of nomadic use of links at live (entertainment) events confined to duration of the event. Some pre- and post-production. Intensive spectrum utilization at the scheduled location.
3.2	Identification of whether the current usage experiences noticeable interference while operating in the identified bands and channels.	Minimal interference experienced between terrestrial ENG licensees. Interference confining operations in urban areas below 2 500 MHz from RLAN applications in analog nomadic ENG links.
3.3	Indication of the magnitude of interference generally experienced. Specify if sporadic or constant.	Interference below 2 500 MHz from RLAN applications constant.
3.4	Identification of the major sources of interference.	RLAN and ISM.
4	Potential for harmonization	
4.1	Band(s) where worldwide harmonization for the operation temporary nomadic TV links may be achieved.	2 300-2 400 MHz 2 500-2 690 MHz 3 400-3 600 MHz

TABLE 22 (continued)

REGION 3 (continued)

Australia (end)

Item	Topic	Information required
5	Coordination	
5.1	Identification of how nomadic TV links and their usage is coordinated for general operations.	Coordination between licensees.
5.2	Are all aspects of the operations coordinated – or is coordination confined to high-importance locations (e.g. hub collection sites)?	Coordination undertaken by licensees for all urban areas. Coordination required when high usage in suburban areas. Minimal coordination required in rural areas.
5.3	Identification of whether such coordination process is achieved through national or regional coordination processes.	Coordination achieved between licensees on both national and regional basis. Dependant upon level of usage.
6	Expected future spectrum demand	
6.1	Based on recent experience, estimation of the demand foreseen in five and ten years.	Steady increase in demand increasing in urban and suburban areas. Maintained at similar activity levels in rural areas. Impact of digitization yet to be determined, however it is expected that COFDM links offer new possibilities that will lead to an increase in usage.

TABLE 22 (continued)

REGION 3 (continued)

Hong Kong

Item	Topic	Information required
1	Frequency bands	
1.1	Identification of the national frequency allocations (including footnotes)/radio-frequency channel arrangements and channel assignments applying to such nomadic TV links.	2.5-2.69 GHz, 7.075-7.75 GHz. 11.7-12.0 GHz, 12.5-13.25 GHz and 14.40-15.35 GHz.
1.2	Identification of additional frequency bands that are utilized by administrations for nomadic TV links.	Nil.
1.3	Identification of any changes planned by administrations to the utilization of such bands. In such cases, to which frequency band(s) are administrations planning to relocate ENG, NOB or TOB services?	2.5-2.69 GHz is planned to be replaced with 2.2-2.29 GHz in near future.
2	Level of availability	
2.1	Identification of the required availability of nomadic TV links and the nature and extent of such availability and deployment for each of the identified bands.	99.99% availability for all nomadic TV links.
2.2	Identification of the technical and operational characteristics of nomadic TV links, apply for applications such as news coverage, sports programme production, live programme, including the level of availability.	Essential to have lower operating frequency for longer coverage range, shorter set-up time, less power (battery) consumption, etc.
3	Interference	
3.1	Identification of the technical and operational characteristics of nomadic TV links, including statistical information such as how often they are deployed, hours of operation and duration (e.g. for satellite service sharing studies information on the azimuthal pointing direction of nomadic TV links is particularly relevant), and the percentage of usage that is live on-air.	More than 10 ENG events daily (duration of event around 1 hr in average) and around 50 TOB events per year (duration of event 2 to 3 days in average). Most of the events are live on air events.
3.2	Identification of whether the current usage experiences noticeable interference while operating in the identified bands and channels.	2.5 GHz MMDS interference is not noticeable.

TABLE 22 (continued)

REGION 3 (continued)**Hong Kong (end)**

Item	Topic	Information required
3.3	Indication of the magnitude of interference generally experienced. Specify if sporadic or constant.	Strong constant interference usually experienced. However, effect usually can be minimized by using directional receiving antenna.
3.4	Identification of the major sources of interference.	Cross-border interference from China Mainland, Macau, etc.
4	Potential for harmonization	
4.1	Band(s) where worldwide harmonization for the operation temporary nomadic TV links may be achieved.	No suggestion for the time being.
5	Coordination	
5.1	Identification of how nomadic TV links and their usage are coordinated for general operations.	Coordination is done by Telecommunication Authority of related countries/areas.
5.2	Are all aspects of the operations coordinated – or is coordination confined to high-importance locations (e.g. hub collection sites)?	Usually only high-importance locations.
5.3	Identification of whether such coordination process is achieved through national or regional coordination processes.	Both national and regional.
6	Expected future spectrum demand	
6.1	Based on recent experience, estimation of the demand foreseen in five and ten years.	Demand may be doubled in 5 to 10 years' time.

TABLE 22 (continued)

REGION 3 (continued)

Japan

Item	Topic	Information required
1	Frequency bands	
1.1	Identification of the national frequency allocations (including footnotes)/radio-frequency channel arrangements and channel assignments applying to such nomadic TV links.	In Japan, the 800 MHz band (9 MHz bandwidth 4 ch), the 5 GHz band (18 MHz bandwidth 2 ch), the 6 GHz band (18 MHz bandwidth 6 ch), the 7 GHz band (18 MHz bandwidth 9 ch), the 10 GHz band (18 MHz bandwidth 18 ch), the 13 GHz band (18 MHz bandwidth 16 ch), the 42 GHz band (80 MHz bandwidth 5 ch) and the 60 GHz band (1 GHz bandwidth 1 ch) are allocated to the nomadic TV links.
1.2	Identification of additional frequency bands that are utilized by administrations for nomadic TV links.	At this time, there are no plans to allocate additional frequency bands.
1.3	Identification of any changes planned by administrations to the utilization of such bands. In such cases, to which frequency band(s) are administrations planning to relocate ENG, NOB or TOB services?	In Japan, in the wake of the introduction of terrestrial digital broadcasting, the Japanese administration reviewed the allocation of frequency bands for broadcasting programme relay service which handles digital broadcasting.
2	Level of availability	
2.1	Identification of the required availability of nomadic TV links and the nature and extent of such availability and deployment for each of the identified bands.	The utilization of radio waves is indispensable for the broadcasting programme relay service, and it is necessary to assign frequency bands that can be operated anywhere at any time.
2.2	Identification of the technical and operational characteristics of nomadic TV links, apply for applications such as news coverage, sports programme production, live programme, including the level of availability.	Ditto.

TABLE 22 (continued)

REGION 3 (continued)

Japan (continued)

Item	Topic	Information required
3	Interference	
3.1	Identification of the technical and operational characteristics of nomadic TV links, including statistical information such as how often they are deployed, hours of operation and duration (e.g. for satellite service sharing studies information on the azimuthal pointing direction of nomadic TV links is particularly relevant), and the percentage of usage that is live on-air.	Ditto.
3.2	Identification of whether the current usage experiences noticeable interference while operating in the identified bands and channels.	In Japan, the frequency bands for the broadcasting programme relay service are assigned exclusively except for some bands which are shared with fixed-satellite services, and the only interference in the same service is mainly considered.
3.3	Indication of the magnitude of interference generally experienced. Specify if sporadic or constant.	Ditto.
3.4	Identification of the major sources of interference.	It is difficult to identify the interference sources.
4	Potential for harmonization	
4.1	Band(s) where worldwide harmonization for the operation temporary nomadic TV links may be achieved.	The utilization of worldwide-harmonized frequency bands is desirable, but at this time it is difficult to identify possible frequency bands because there is no information about other countries.
5	Coordination	
5.1	Identification of how nomadic TV links and their usage is coordinated for general operations.	The frequency channels are assigned for most of the broadcasters exclusively in each broadcasting service area. It is unnecessary for a broadcaster to coordinate unless there is a possibility that operation may cause interference in the area next to the broadcasting area.

TABLE 22 (continued)

REGION 3 (continued)**Japan (end)**

Item	Topic	Information required
5.2	Are all aspects of the operations coordinated – or is coordination confined to high-importance locations (e.g. hub collection sites)?	It is necessary for a broadcaster to coordinate with other broadcasters on all aspects outside of the broadcasting service area.
5.3	Identification of whether such coordination process is achieved through national or regional coordination processes.	Such coordination process applies only in Japan.
6	Expected future spectrum demand	
6.1	Based on recent experience, estimation of the demand foreseen in five and ten years.	It is expected that the demand in the 42 GHz and the 60 GHz bands will increase and that the demand in other bands will remain constant.

TABLE 22 (continued)

REGION 3 (continued)

New Zealand

Item	Topic	Information required
1	Frequency bands	
1.1	Identification of the national frequency allocations (including footnotes)/radio-frequency channel arrangements and channel assignments applying to such nomadic TV links.	2 500-2 690 MHz "O-band" Itinerant fixed linking for television outside broadcast operations. NOTE – This band is restricted to user-coordinated TV OB operations. For channel plans, see Annex NZL1.
1.2	Identification of additional frequency bands that are utilized by administrations for nomadic TV links.	2 700-2 900 MHz "OX-band" Itinerant fixed linking for TV OB NOTE – This band is restricted to user-coordinated TV OB operations. For channel plans, see Annex NZL2 7 100-7 425 MHz "V-band" Point-to-point (permanent) linking and itinerant TV OB linking. NOTE – In this band the use of 28 MHz channels is restricted to user-coordinated TV OB operations. For 28 MHz channel plans, see Annex NZL3 8 290-8 500 MHz "Y-band" Point to point linking and TV OB linking For channel plans, see Annex NZL4
1.3	Identification of any changes planned by administrations to the utilization of such bands. In such cases, to which frequency band(s) are administrations planning to relocate ENG, NOB or TOB services?	2 500-2 690 MHz – Spectrum identified for possible expansion of 3rd Generation Cellular services. Relocation band – 2 700-2 900 MHz.

TABLE 22 (continued)

REGION 3 (continued)

New Zealand (continued)

Item	Topic	Information required
2	Level of availability	
2.1	Identification of the required availability of nomadic TV links and the nature and extent of such availability and deployment for each of the identified bands.	Availability required to be 24 hours/365 days. Available 24h/365 days. TV OB operators “self-manage” the following three bands without the involvement of the administration: 2.5-2.69; 2.7-2.9; 7.1-7.425 GHz. 8.29-8.5 GHz mostly use by a single operator.
2.2	Identification of the technical and operational characteristics of nomadic TV links, apply for applications such as news coverage, sports programme production, live programme, including the level of availability.	ENG requires spontaneous access with little time for coordination. Hence channels O2 and O2# assigned to ENG. Mostly 28 MHz analog links. Sport OB & live broadcast links: Technical: Both analog and digital: up to +32 dBW e.i.r.p., up to 28 MHz channels. Operational: Coordination in advance, using Channels O1, O3, O1# & O3#, as well as channels in OX-band, and V-band.
3	Interference	
3.1	Identification of the technical and operational characteristics of nomadic TV links, including statistical information such as how often they are deployed, hours of operation and duration (e.g. for satellite service sharing studies information on the azimuthal pointing direction of nomadic TV links is particularly relevant), and the percentage of usage that is live on-air.	Sport OB & live broadcast linking operations: more than 2 000 linking operations per annum. On-air up to 4 hours or more, depending on the event. Pointing direction: Azimuth 0-360°. Elevation often < 2°, but on occasion up to 20°, or up to 90° when linking via building tops. Polarizations: H, V and circular.
3.2	Identification of whether the current usage experiences noticeable interference while operating in the identified bands and channels.	Virtually no interference experienced.
3.3	Indication of the magnitude of interference generally experienced. Specify if sporadic or constant.	N/A

TABLE 22 (continued)

REGION 3 (end)**New Zealand (end)**

Item	Topic	Information required
3.4	Identification of the major sources of interference.	N/A
4	Potential for harmonization	
4.1	Band(s) where worldwide harmonization for the operation temporary nomadic TV links may be achieved.	2.5-2.69 GHz is strongly preferred first choice. But note that ITU-R Radio Regulations footnote 5.384A identifies this band (among others) for use (wholly or in part) by administrations wishing to implement IMT-2000. This may put at risk any plan to harmonize this band for temporary nomadic TV OB linking. 2.3-2.4 GHz is second choice. (Not currently available for TV links, but NZL allocation is to be reviewed in 2010.) 2.7-2.9 GHz is third choice. This band may not be much used by TV OB outside NZL at present.
5	Coordination	
5.1	Identification of how nomadic TV links and their usage is coordinated for general operations.	It is a condition of these radio licences that all TV OB operators coordinate linking among themselves. Linking for planned events is coordinated by agreement through one operator, (currently BCL). The national administration is not involved in operational coordination.
5.2	Are all aspects of the operations coordinated – or is coordination confined to high-importance locations (e.g. hub collection sites)?	All sports and live programme events are coordinated in advance, but ENG requires immediate unplanned access, and coordination is avoided by giving 2 channels priority for ENG.
5.3	Identification of whether such coordination process is achieved through national or regional coordination processes.	National coordination only. (NZL is isolated by 2 000 km of sea and does not require regional coordination.)
6	Expected future spectrum demand	
6.1	Based on recent experience, estimation of the demand foreseen in five and ten years.	The number of linking events is expected to grow over the 5 to 10 year time-scale. Analog linking with 28 MHz channels is expected to be required for a significant percentage of links due to low latency and lower cost.

New Zealand ENG/OB channel plans

O-band 2 500-2 690 MHz

NOTE – This band is restricted to user-coordinated TV OB operations.

28 MHz channelling

TABLE 23

Channel	Frequency (MHz)	Lower edge (MHz)	Upper edge (MHz)
O1	2 512.500	2 498.500	2 526.500
O2	2 540.500	2 526.500	2 554.500
O3	2 568.500	2 554.500	2 582.500
O1#	2 603.500	2 589.500	2 617.500
O2#	2 631.500	2 617.500	2 645.500
O3#	2 659.500	2 645.500	2 673.500

OX-band 2 700-2 900 MHz

NOTE – This band is restricted to user-coordinated TV OB operations.

The 2.7-2.9 GHz band channelling is shown in Tables 1 and 2.

TABLE 24

10 MHz channelling (no mid-band gap)

NOTE – Aggregation of up to 3 × 10 MHz channels will permit a 28 MHz channelling overlay as per Table 2 and Fig. 1.

Channel	Frequency (MHz)	Lower edge (MHz)	Upper edge (MHz)
OX1A	2 710.000	2 705.000	2 715.000
OX1B	2 720.000	2 715.000	2 725.000
OX1C	2 730.000	2 725.000	2 735.000
OX2A	2 740.000	2 735.000	2 745.000
OX2B	2 750.000	2 745.000	2 755.000
OX2C	2 760.000	2 755.000	2 765.000
OX3A	2 770.000	2 765.000	2 775.000
OX3B	2 780.000	2 775.000	2 785.000
OX3C	2 790.000	2 785.000	2 795.000
OX3D	2 800.000	2 795.000	2 805.000
OX1A#	2 810.000	2 805.000	2 815.000
OX1B#	2 820.000	2 815.000	2 825.000

TABLE 24 (end)

Channel	Frequency (MHz)	Lower edge (MHz)	Upper edge (MHz)
OX1C#	2 830.000	2 825.000	2 835.000
OX2A#	2 840.000	2 835.000	2 845.000
OX2B#	2 850.000	2 845.000	2 855.000
OX2C#	2 860.000	2 855.000	2 865.000
OX3A#	2 870.000	2 865.000	2 875.000
OX3B#	2 880.000	2 875.000	2 885.000
OX3C#	2 890.000	2 885.000	2 895.000

TABLE 25

28 MHz channelling

(This plan aligns with 10 MHz channelling and permits a 12 MHz mid-band gap.)

Channel	Frequency (MHz)	Lower edge (MHz)	Upper edge (MHz)
OX1	2 720.000	2 706.000	2 734.000
OX2	2 750.000	2 736.000	2 764.000
OX3	2 780.000	2 766.000	2 794.000
OX1#	2 820.000	2 806.000	2 834.000
OX2#	2 850.000	2 836.000	2 864.000
OX3#	2 880.000	2 866.000	2 894.000

FIGURE 12

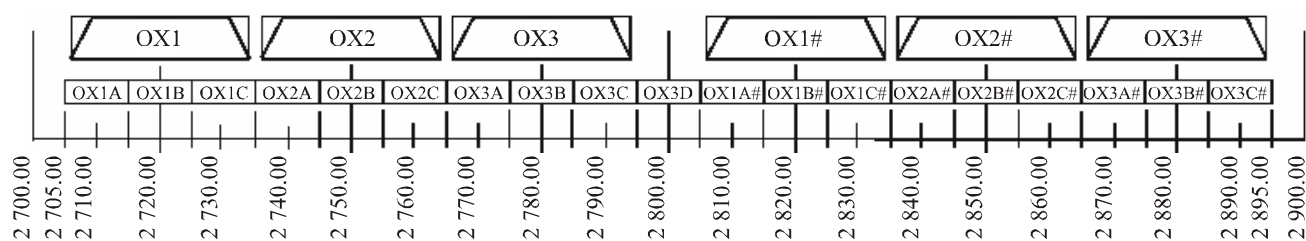
Band plot for OX-band – 2.7-2.9 GHz

Rap 2069-14

V-band 7100-7425 MHz

NOTE – These channels are restricted to user-coordinated television outside broadcast operations.

28 MHz channelling

TABLE 26

Channel	Frequency	Channel	Frequency
V1	7 124.500	V1#	7 285.500
V2	7 152.500	V2#	7 313.500
V1A	7 138.500	V1A#	7 299.500
V2A	7 166.500	V2A#	7 327.500

Y-band 8 290-8 500 MHz**28 MHz channelling**

TABLE 27

Channel	Frequency	Channel	Frequency
Y1	8 293.000	Y1#	8 412.000
Y2	8 321.000	Y2#	8 440.000
Y3	8 349.000	Y3#	8 468.000
Y1A	8 307.000	Y1A#	8 426.000
Y2A	8 335.000	Y2A#	8 454.000
Y3A	8 363.000	Y3A#	8 482.000

NOTE – The two groups of channels are interleaved.

Uzbekistan

Having considered Administrative Circular CA/131 dated 21 November 2003 concerning data required for the evaluation of user requirements and spectrum usage for terrestrial electronic news gathering (ENG), State Committee for Radiofrequencies of the Republic of Uzbekistan informs that at the present time the above-mentioned system is not operated in the Republic of Uzbekistan therefore we have no information required by the Radiocommunication Bureau in given Administrative Circular.

13 Conclusions arising from European studies

The following conclusions are documented in Document 6P/6, Part 2 (ECC Report 2):

- 1 It is suggested that CEPT adopts a unified and logically inter-linked set of definitions of various applications and technologies in the SAP/SAB area, as described in Fig. 3 Section 1 of the Report;
- 2 It is shown that while the actual demand for SAP/SAB spectrum varies significantly between different countries, different programme makers and different events, the overall trend is that of steady increase of SAP/SAB demand in most of the sectors. Administrations are invited to base their forecasts of the near/long-term demand for different SAP/SAB applications on the information provided in Tables 4 and 5, Section 3 of the ECC Report 2;

- 3 At the time of writing this Report, the actual impact of digital technologies on the future of SAP/SAB was not entirely clear, as digital SAP/SAB equipment was only about to be tested or in the conception phase. Even the potential benefits of digital technologies were not yet fully apparent to the industry, in particular for radio microphone applications;
- 4 However, based on the theoretical simulations and some of early tests, the Report shows that the introduction of digital technologies could mean higher spectral efficiency of SAP/SAB equipment. This might be achievable through the reduction of channel bandwidth for video links and easing of intermodulation constraints (hence more dense co-location) for radio microphones. For details refer to Section 4;
- 5 Overall consideration of frequency bands for SAP/SAB applications has proved that SAP/SAB use is highly divergent and irregular across various CEPT countries. Because of this, only limited harmonization may be achievable. Recognizing the impracticality of exclusive allocations the concept of tuning ranges should be pursued as the main means of harmonizing SAP/SAB spectrum use;
- 6 In reviewing frequency bands for video SAP/SAB links, the preferred sub-bands were identified where possible. These (if available in particular country) should be used as a first choice option in assigning frequencies for SAP/SAB, in particular for occasional/temporary use;
- 7 The potential interest in identifying the frequency band 2 700-2 900 MHz for one type of SAP/SAB applications – digital cordless cameras with 0 dBW output power was confirmed. This would significantly ease the pressure on the SAP/SAB bands below 2 500 MHz, which could then be better exploited for high mobility SAP/SAB applications. However conditions for use of the band 2 700-2 900 MHz by cordless cameras, if proved possible at all, are to be established by the FM PT 31, taking account in particular of the outcome of relevant SE PT 34⁸ studies;
- 8 Consideration of frequency bands for audio SAP/SAB applications, notably radio microphones, showed that the main interest of SAP/SAB industry is currently concentrating on the band 470-862 MHz, which should remain a vital tuning range of SAP/SAB operations for the foreseeable future. Therefore some solutions should be further considered for ensuring continued coexistence of SAP/SAB with primary broadcasting services in the band, in particular during and after their conversion to DVB-T. One of such already exploitable solutions is extension of switching range of radio microphones beyond that of currently marketed equipment (3-6 UHF TV channels);
- 9 The band 1 785-1 800 MHz is likely to make a large contribution to satisfying spectrum demand for radio microphones, in particular as a long-term solution for truly pan-European operations (touring shows, etc.). This would help to relieve the pressure for SAP/SAB use in the band 470-862 MHz;
- 10 The model application form for SAP/SAB licence applications should be promoted. The existing CEPT proposal for such a form in Annex 4 of the ERC Recommendation 25-10 should be used as the basis, but updated during the revision of REC 25-10 so that it contains more information and is better suited for electronic submissions and administrative handling.

⁸ Working Group of European Radiocommunications Office, refer www.ero.dk

14 Future work programme of the Rapporteur for spectrum usage and user requirements for electronics news gathering

The ITU-R Working Party 6J Rapporteur for terrestrial electronic news gathering seeks the support of administrations for international recognition of electronic news gathering through participation in the ongoing work of ITU-R.

Appendix 1

In Japan, since HDTV digital satellite-broadcasting service launched in 2000 in Japan, HDTV digital terrestrial ENG systems have been introduced as well as HDTV digital SNG systems. The digital ENG systems are based on ARIB STD-B33 Version 1.0 “Portable OFDM digital transmission system for television programme contribution” and ARIB STD-B11 Version 2.1 “portable microwave digital transmission system for television programme contribution”. For fixed operation and transmission from helicopters, single carrier QAM systems (ARIB STD-B11) are used. For mobile transmission and wireless camera systems, OFDM systems (ARIB STD-B33) are used.

The details of these technical specifications are shown in attached documents.

For ARIB STD B11 refer to: http://www.arib.or.jp/english/html/overview/sb_e.html

For ARIB STD B33 refer to: http://www.arib.or.jp/english/html/overview/sb_e.html
