



COSITU

The ITU model for the calculation of
telephone service costs, tariffs and
interconnection charges



Note: The views expressed in this paper are those of the author and do not necessarily represent the opinions of ITU or its membership.

The terms and definitions used are the author's own and can on no account be regarded as replacing the official ITU definitions.

pape-gorgui.toure@itu.int

Domestic services

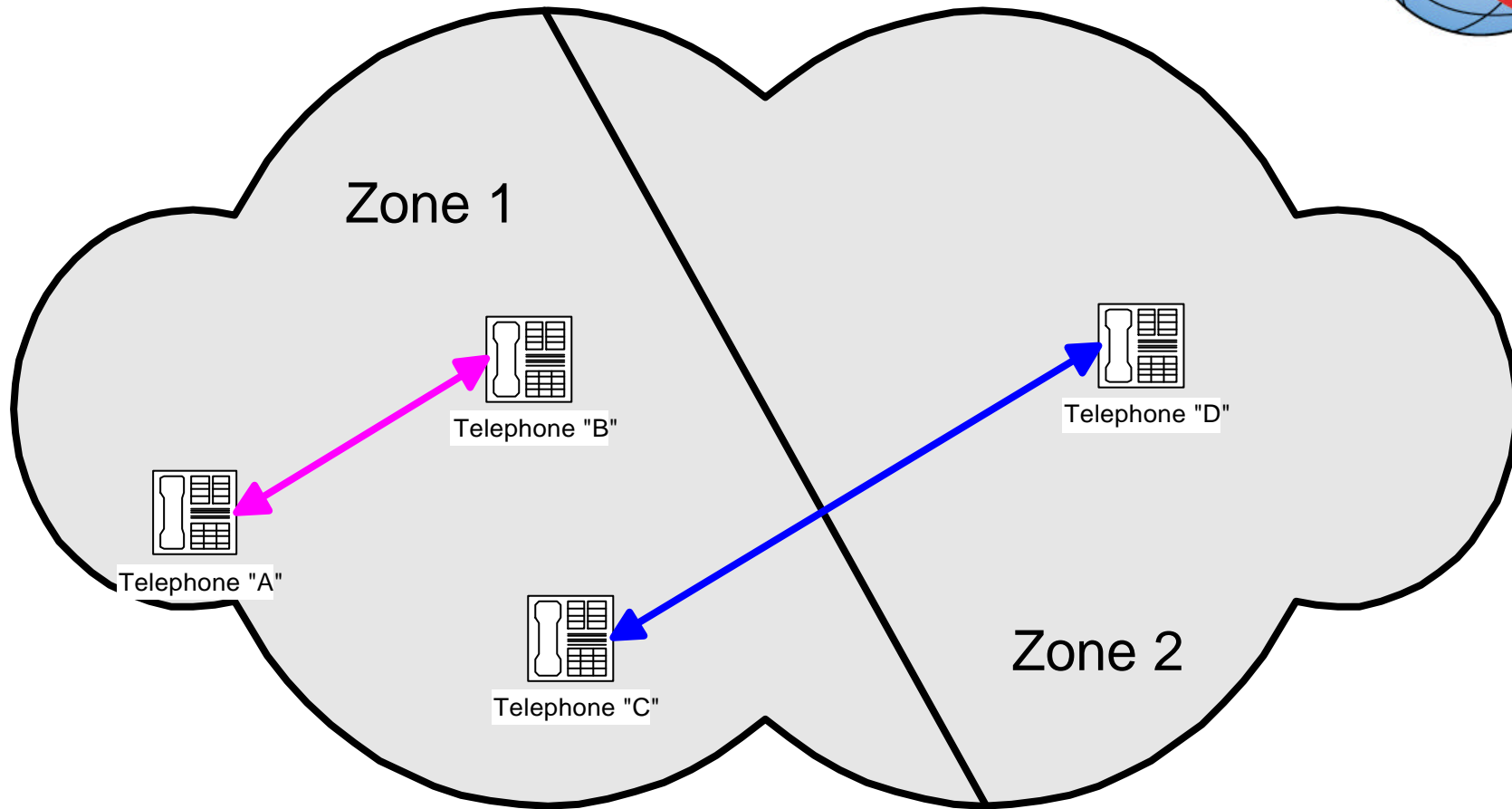

Definition of services for which COSITU calculates costs



- **Local/Urban:** Traffic carried solely within the network of the operator for which the calculations are made, between users located in the same local charging area,
- **Trunk/Interurban:** Traffic carried solely within the network of the operator for which the calculations are made, between users located in different local charging areas,
- ***International outgoing:*** A call from an end-user, connected to the access network of the provider who also operates the international gateway used, to a correspondent located outside the national boundaries,

Traditional International services

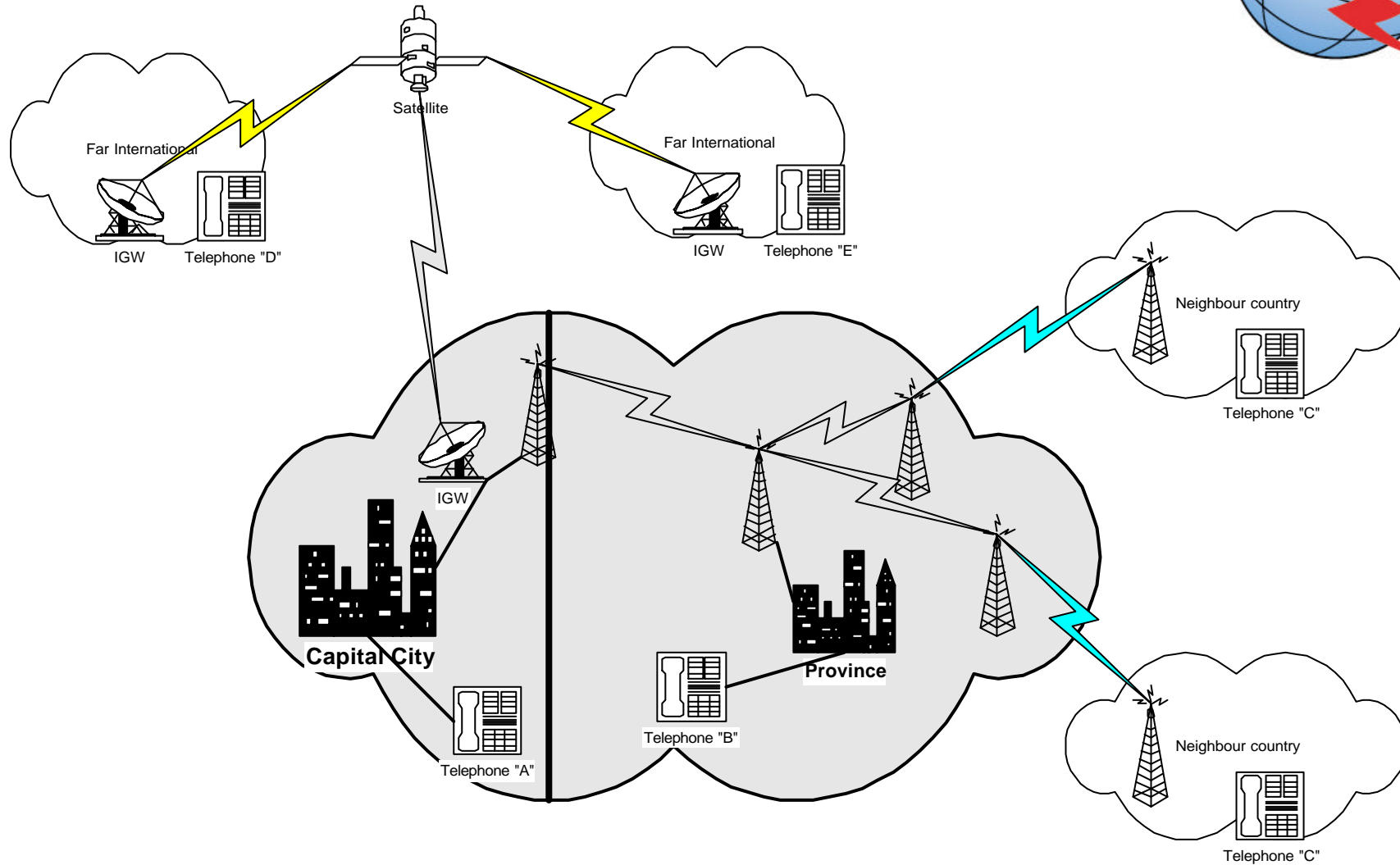

Definition of services for which COSITU calculates costs



- ***Incoming international:*** A call from a user located outside the national boundaries to an end-user connected to the access network of the provider who also operates the international gateway used,
- ***Outgoing subregional:*** A call from an end-user, connected to the access network of the provider who also operates the international gateway used, to a correspondent located outside the national boundaries, in a country which can be accessed by terrestrial media that are also used for trunk calls,

Definition of services for which COSITU calculates costs



- *Subregional incoming*: A call from a user located outside the national boundaries, in a country which can be accessed by terrestrial media also used for trunk traffic, to an end-user connected to the access network of the provider who also operates the international gateway used,

Definition of services for which COSITU calculates costs



- **International to international:** A call between two non-subregional international correspondents via the international gateway of the operator for which the calculations are made,
- **International to subregional:** A call from a non-subregional international correspondent to a subregional correspondent via the international gateway of the operator for which the calculations are made,

Definition of services for which COSITU calculates costs



- **Subregional to international:** A call from a subregional correspondent to a non-subregional international correspondent via the international gateway of the operator for which the calculations are made,
- **Subregional to subregional:** A call between two subregional correspondents via the international gateway of the operator for which the calculations are made,

National services

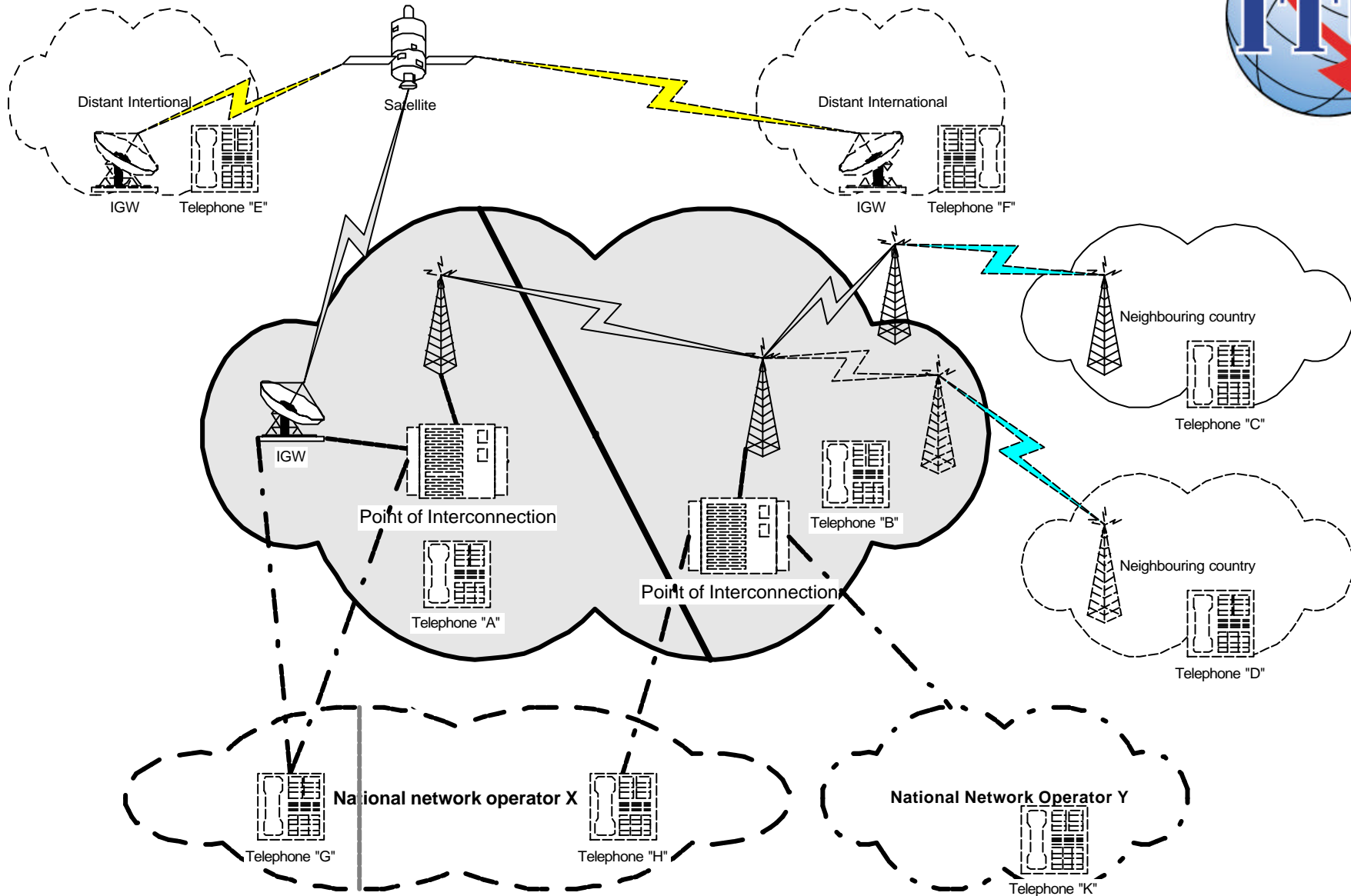

Definition of services for which COSITU calculates costs



- ***International to national***: A call from an international correspondent to an end-user connected to the access network of an operator, without an international gateway, located within the same political borders as the operator of the international gateway for which the calculations are made,
- ***National to international***: A call from an end-user connected to the access network of an operator, which did not make use of its own gateway, located within the same political borders as the operator of the international gateway for which the calculations are made, to an international correspondent,

Definition of services for which COSITU calculates costs



- **Outgoing national:** A call from an end-user of the network of the operator for which the calculations are made to another operator located within the same political borders as the first operator,
- **Incoming national, single transit:** A call coming from the network of another national operator to an end-user located in the charging area of the interconnection point and connected to the network of the operator for which the calculations are made,

Definition of services for which COSITU calculates costs



- **Incoming national, double transit:** A call coming from the network of another national operator to an end-user located outside the charging area of the interconnection point and connected to the network of the operator for which the calculations are made,
- **National to national:** A transit call between two national operators via the network of the operator for which the calculations are made,

International boundaries of networks



- Political boundaries do not always correspond to the international boundaries of networks: an imaginary point in the middle of the international area delimits the international “half-circuit” which completes the national network

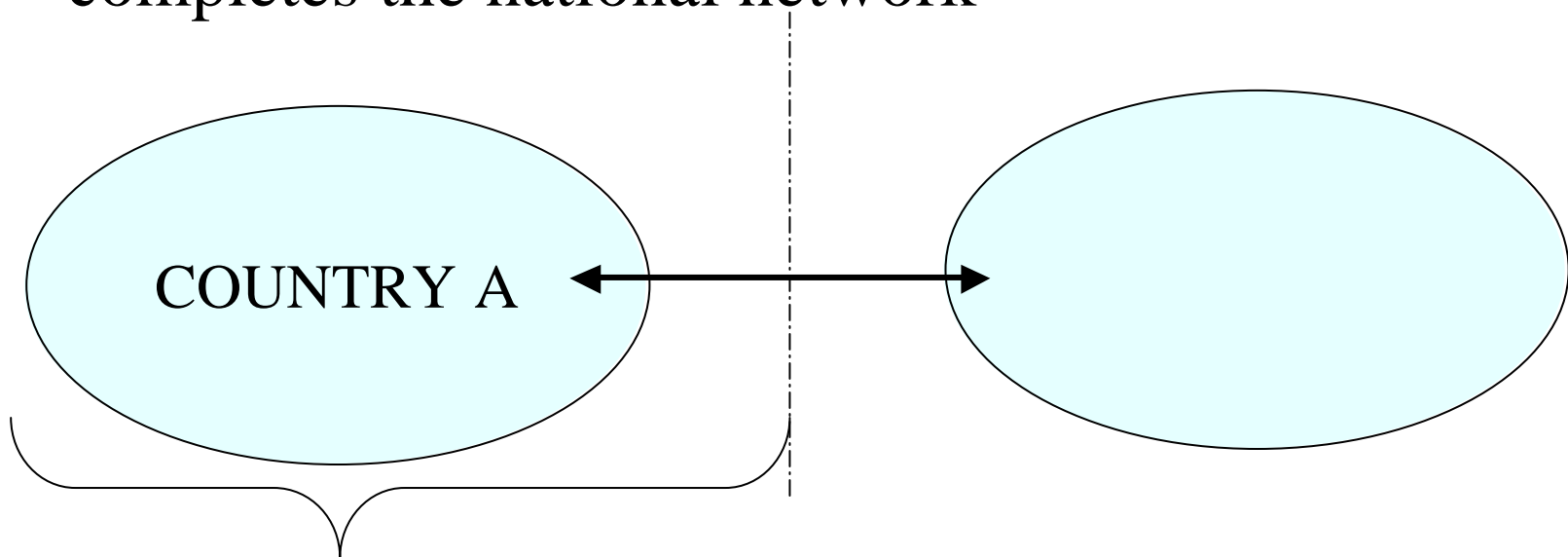

National boundaries of networks and the bases for interconnection



- Within a given jurisdiction, the interconnection points set the network boundaries.
- Costs incurred within the boundaries of a network are endogenous costs, which the operator is at liberty to improve itself.
- Except for transit charges identified at transmission, payments to other correspondents for terminal traffic are exogenous costs which are not counted in determining costs at boundaries.

Endogenous costs and exogenous costs

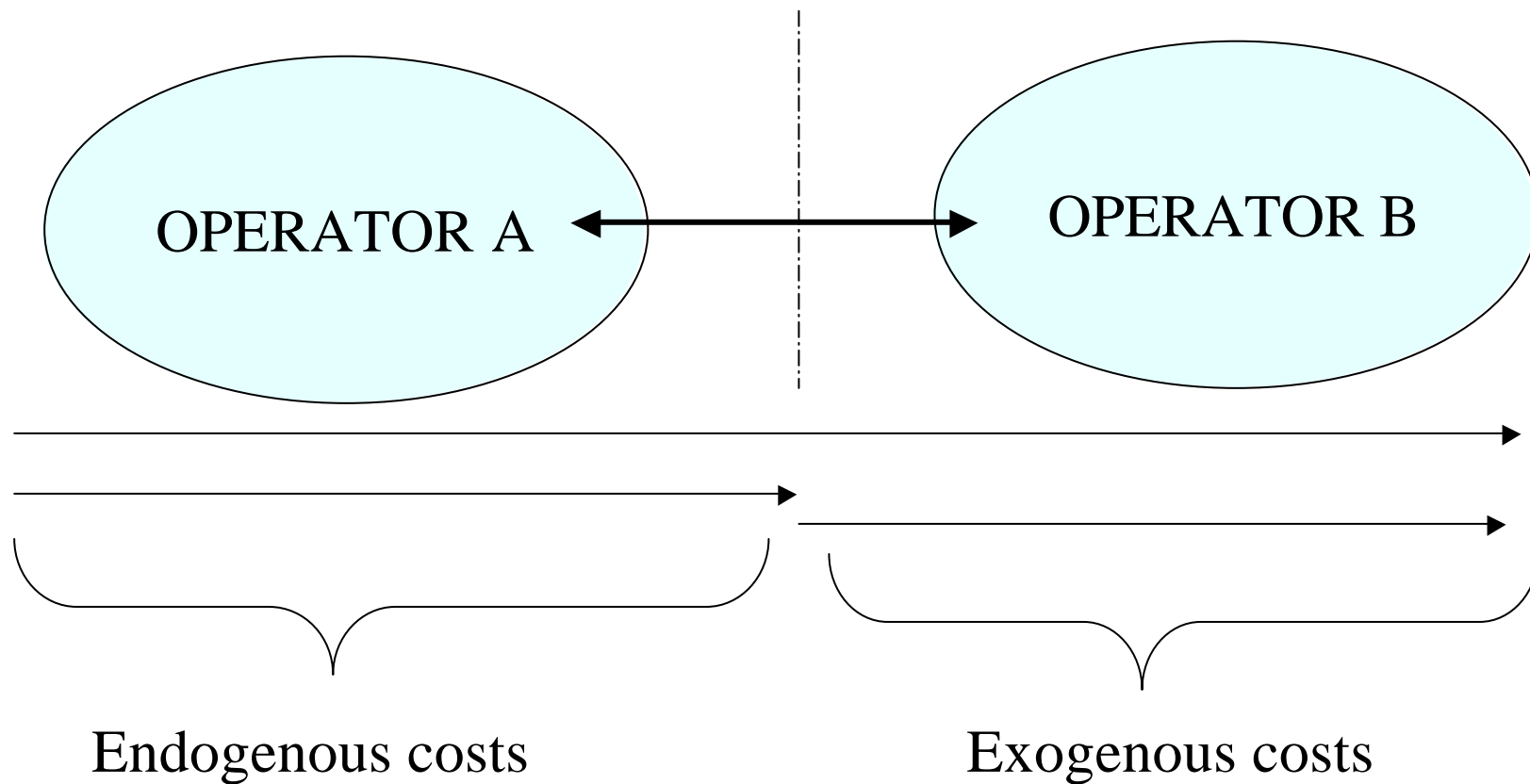

What are, for each operator, the services generating Endogenous costs ?



«A»

- Urban
- Interurban
- National outgoing
- International outgoing
- National-International
- International-National
- National-national
- International incoming
- National incoming single transit
- National incoming double transit

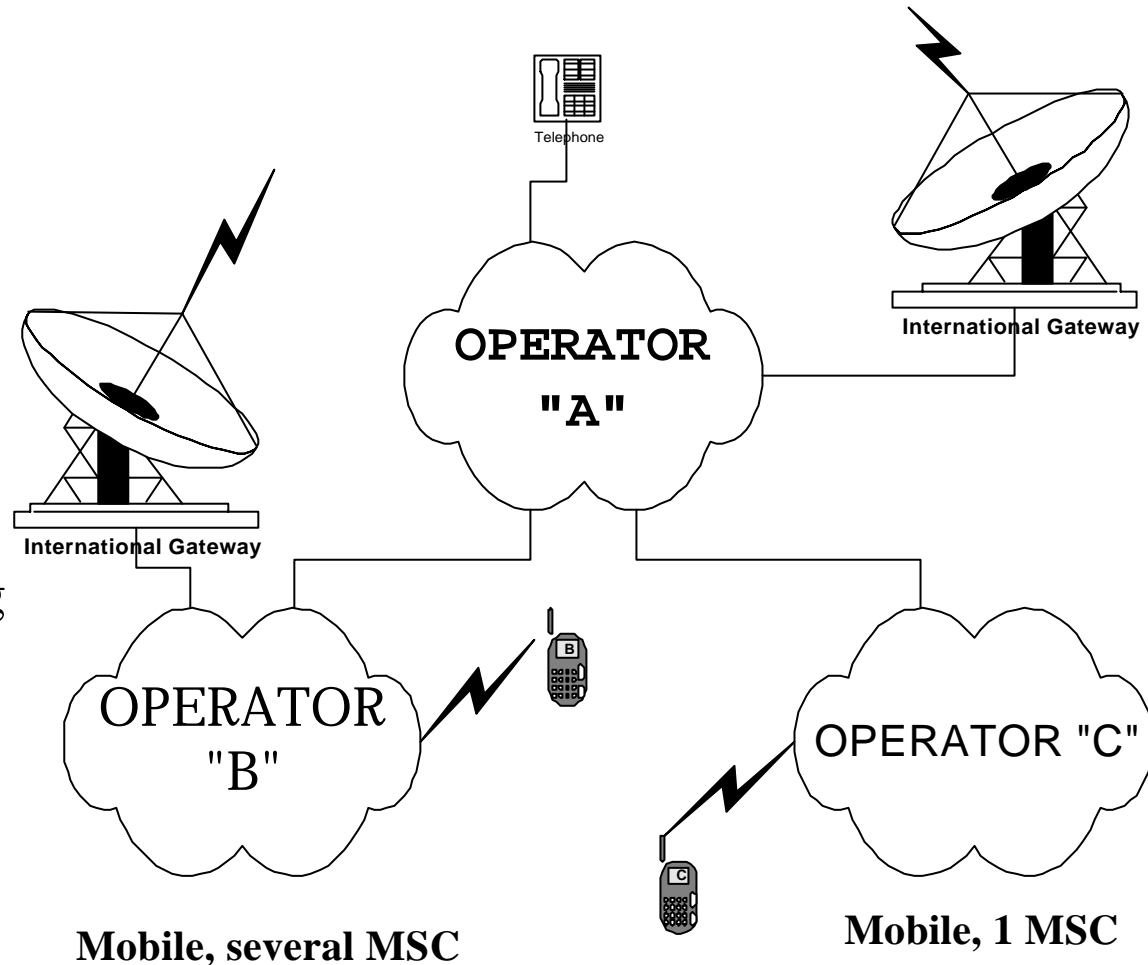

What are, for each operator, the services generating Endogenous costs ?



« **B** »

- Urban
- Interurban
- National outgoing
- International outgoing
- (National-International)
- International-National
- International incoming
- National incoming single transit
- National incoming double transit

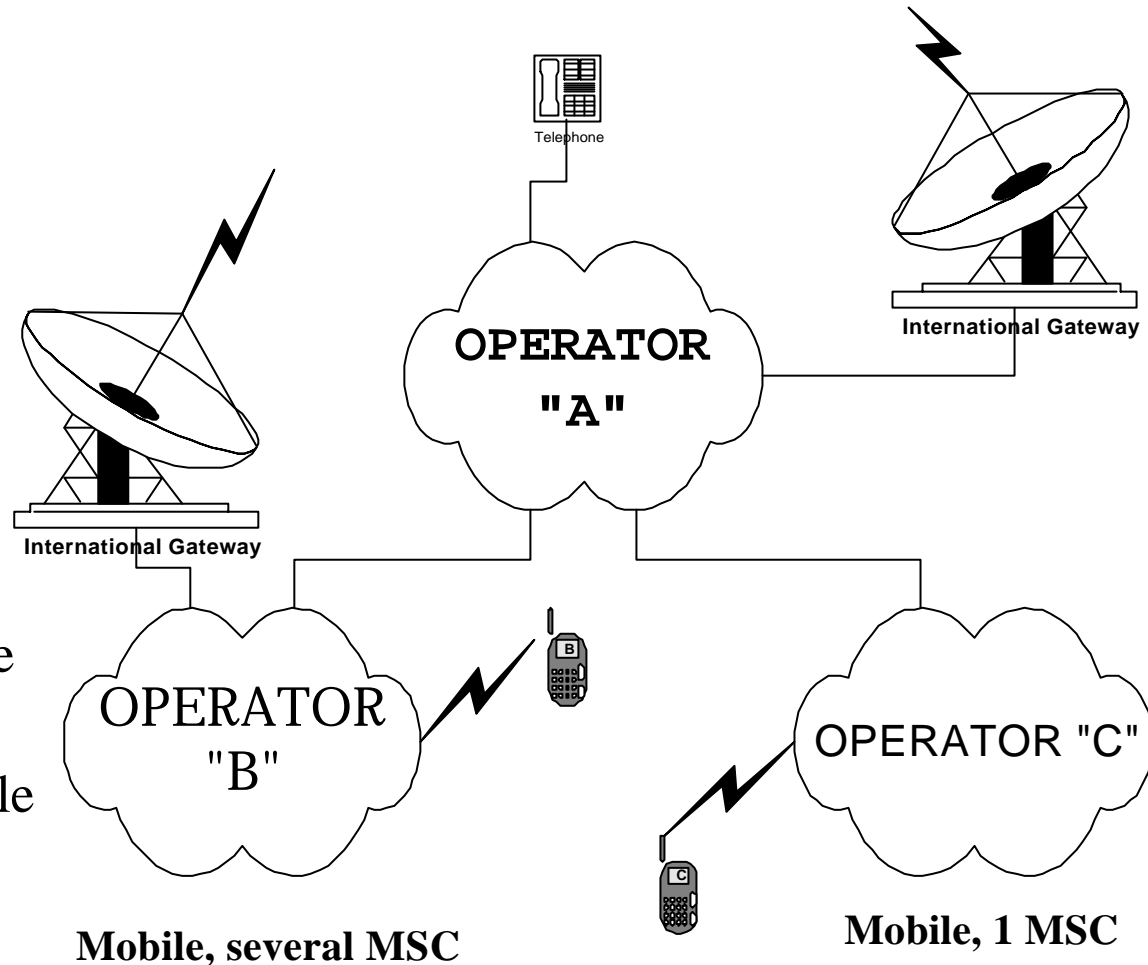

What are, for each operator, the services generating Endogenous costs ?



« C »

- Urban
- National incoming single transit
- National outgoing

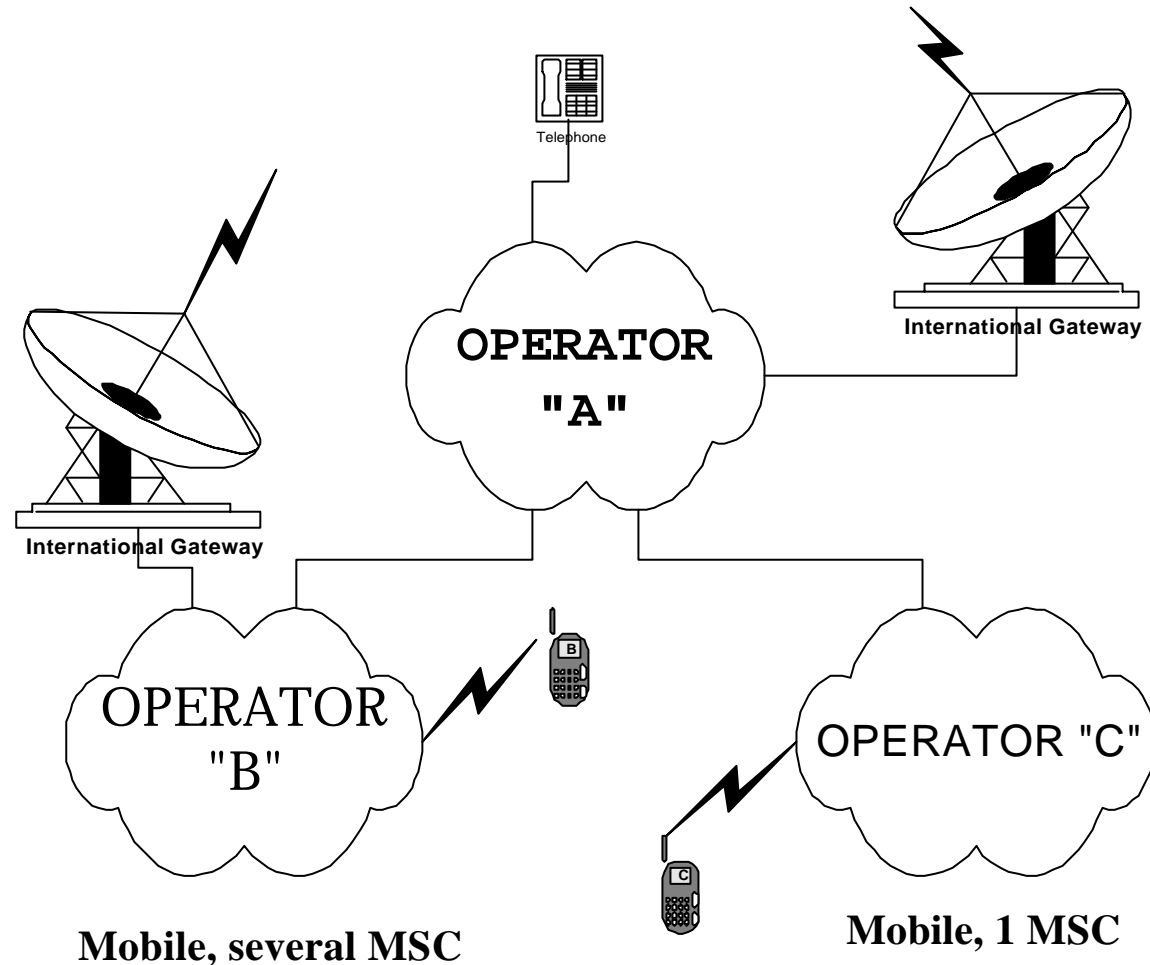

Change management



- Historical costs: Based on the cost price of equipment and services,
- Current costs: Take account of the changing environment: falling prices of telecommunication equipment, currency depreciation. COSITU utilizes current costs as confirmed on the relevant market.

Actual costs versus optimum costs



- The costs (even current costs) incurred in offering the service are not necessarily optimum.
- Efficiency of service provision can be an important factor.
- The structural realities of the different kinds of markets should nonetheless be considered in making any judgements.

Basic principles for cost models



- Transparency:

The open availability of information used in the cost derivation process in order to allow comprehension of the final rate from the vantage point of an external analyst.

- Practicability:

The ability to implement a costing methodology with reasonable demands being placed on data availability and data processing in order to keep the costing exercise economical yet still useful.



- Causality:
 - *The demonstration of a clear cause-and-effect relationship between service delivery, on the one hand, and the network elements and other resources used to provide it, on the other hand, taking account of relevant cost determinants (cost inducers).*



- Contribution to common costs:
 - *Costing methodologies should provide for a reasonable contribution to common costs.*
- Efficiency:
 - *The provision of a forecast of cost reductions that result from a more efficient combination of resources.*

Stages of cost-orientated charging allowed by this model

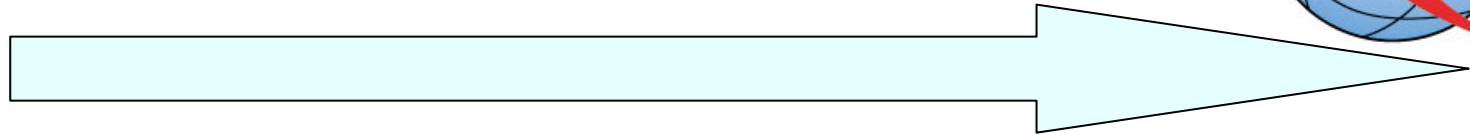

<ul style="list-style-type: none">•Cost of network components•Operation and maintenance costs•Service traffic	<ul style="list-style-type: none">•Amortization rules•Equipment price trends•Cost of capital	<ul style="list-style-type: none">•Cost of functional support•Identifiable direct and indirect costs•Other common costs•Routing table•Cost distribution	<ul style="list-style-type: none">•Unit endogenous cost of services•Tax components•Universal service obligations	<ul style="list-style-type: none">•Cost-orientated endogenous tariffs•Tariff rebalancing•USO simulation
---	--	---	--	---



“Bottom-up” or “Top-down”

- The difference between these two methods lies in the way the cost of network components is determined:
 - *Bottom-up (“scorched node” or “earth node”): a fictitious network is worked out from an estimate of traffic needs based on statistical data;*
 - *Top-down: the existing network is the source of all information.*
- COSITU accommodates both, the initial stage for the bottom-up method being completed outside the model.

Full costs or incremental costs



- The fully distributed costing method allocates all costs to all services,
- The incremental costing method allocates a cost variation to the variation - from a previously established balance - in traffic volume that caused it,
- Important: In terms of strict compliance with the rules of cost orientation, the incremental costing method requires complete rotation on all services and an additional allocation of common costs to balance operation (real or fictitious); in which case it is much the same as fully distributed costing.

Full costs or incremental costs



- In a market where several players are competing, it is in the interests of a service provider to apply the incremental costing method, without rotation, to a given service if that provider is already competitive in the other services (“value chain” theory),
- Costing a service by the incremental costing method without rotation amounts to transferring the fixed costs of that service to the other other services (cross-subsidy!),
- But economically speaking it is acceptable as long as it produces neither an increase in the price of the other services nor anti-competitive arbitrage, which makes the market less efficient.

Full costs or incremental costs



- Whatever the methods used to determine costs and traffic, the COSITU model can accommodate them,
- COSITU has, however, been optimized for use of real information from the accounts and technical data of real network operators with a view to equitable allocation of costs to the services that generate them, collectively or separately,
- COSITU is unaffected by technological choice, addressing directly the services sold – retail or wholesale.

Adjusted depreciation(1/3)



- Linear depreciation is the rule most widely applied in the accounts of telecommunication operators.
- It is nevertheless possible to take account of the natural evolution of the price of equipment in the specific market and adjust the depreciation accordingly.

Adjusted depreciation (2/3)



- Currency depreciation must also be taken into account:

$$e = 1 - \sqrt[n]{\frac{C_0}{C_n}}$$

- where:
 - *C_0 is the value of one SDR in the national currency in the year of acquisition;*
 - *C_n is the value of one SDR in the national currency in year N ;*
- statistically, the age of the equipment of an *ordinary* telecommunication network is $D/2$ (half the lifetime).



Adjusted depreciation (3/3)

- $ACC = AMO * ((1+t)^{D/2} / (1-e)^{D/2} - 1)$

where:

- ACC = adjustment to current costs
- AMO = amortization allowance
- τ = annual average growth rate in the price of equipment
- ϵ = average annual rate of currency depreciation
- D = depreciation period

Efficiency (1/2)



- Efficiency is calculated by combining the following factors:
 - *installed capacity;*
 - *utilized capacity;*
 - *average annual growth rate in number of subscribers;*
 - *replenishment period.*

Efficiency (2/2)



$$K' = \text{Max}(0 ; DK - K_u * [(1+t)^N - 1])$$

where :

K' is the idle capacity;

DK is the difference between the installed capacity and the utilized capacity;

K_u is the utilized capacity;

t is the annual average growth rate in the number of subscribers;

N is the necessary extension time.

Causality



- The cost of the local loop is not sensitive to variation in traffic volume,
- It is a basic investment which serves the global network,
- The cost of the local loop must be recovered as customary through all the services.



Operating and maintenance costs

- Cost of inputs
 - *Purchases and variations in stock;*
 - *Transport;*
 - *Outside services*
- Personnel costs
- Taxes and levies
- Other charges
- Financial and similar charges
- Operating provisions



Cost of capital

- Combined effect of debt and equity
- Creditors demand interest
- Owners demand dividends
- The ratio
net_profit / equity

gives an idea of current return on equity

- However, investors often demand a return in keeping with conditions prevailing on the international financial market.

Cost of capital



- The Capital asset pricing model (CAPM) gives an indication of how to determine a minimum return on equity in a given market:

$$\mathbf{s} = i_F + \mathbf{b} \cdot (r_M - i_F)$$

$$i_F = \text{risk_free_rate}$$

$$r_M = \text{market_return}$$

$$\mathbf{b} = \text{sensitivity_to_market_risk}$$



Calculating BETA

- The BETA of a stock corresponds to the slope of regression of its profitability as compared to that of the market, in other words, by definition:

$$b_T = \frac{\text{Cov}(r_T, r_M)}{V(r_M)}$$

i.e.

$$b_T = \frac{\sum_{i=1}^n \sum_{k=1}^n p_{i,k} (r_{T_i} - \overline{r_T})(r_{M_k} - \overline{r_M})}{\sum_{i=1}^n p_i (r_{M_i} - \overline{r_M})^2}$$

Sensitivity of SONATEL share rate to the market risk

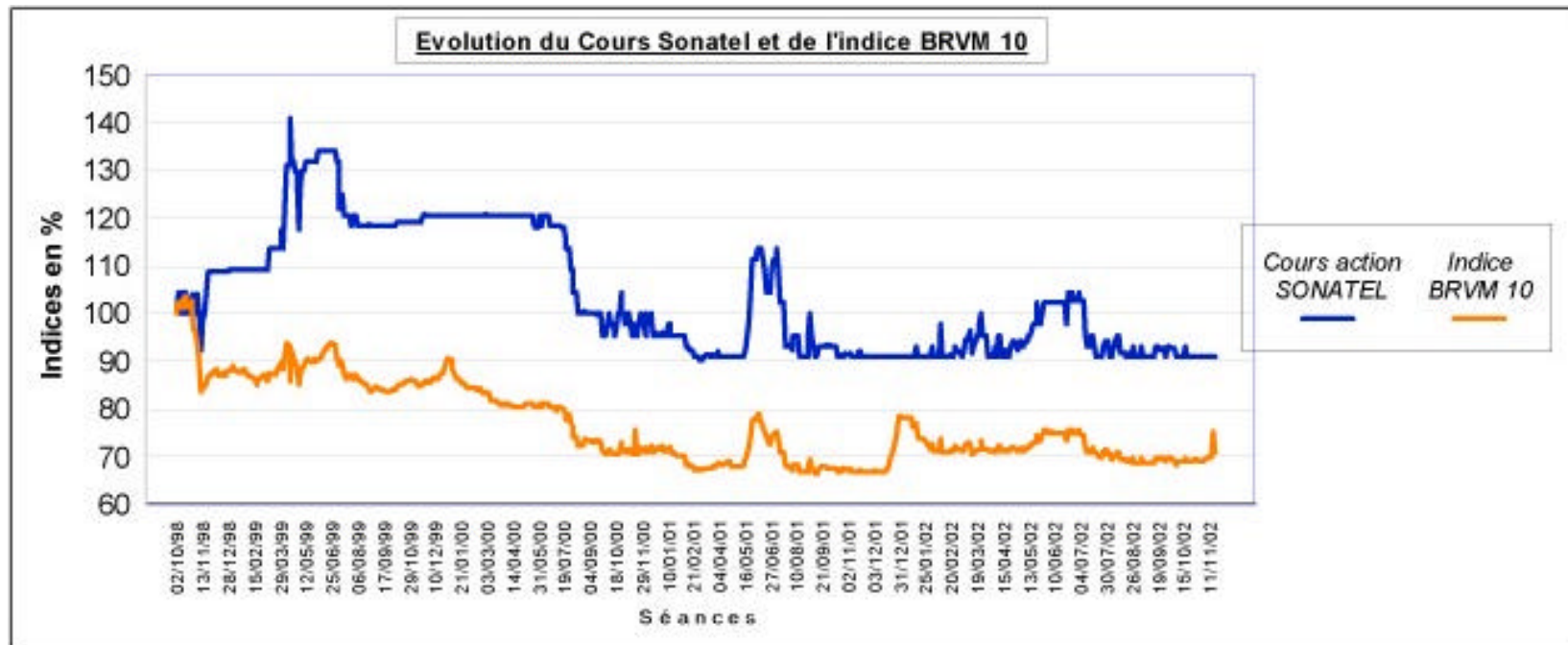

Bêta SONATEL = 1,18...

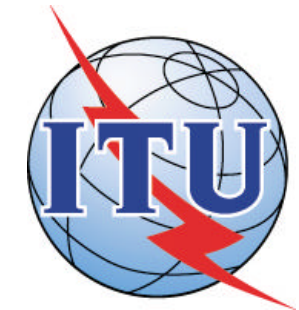

BETA of major European groups

$\beta < 0,65$		$0,65 < \beta < 0,8$		$0,8 < \beta < 1,0$		$1,0 < \beta < 1,15$		$\beta > 1,15$	
UNIBAIL	0,12	BENETTON	0,67	MICHELIN	0,80	CAP GEMINI	1,00	RANDSTAD	1,16
GEHE	0,24	BULGARI	0,67	THYSSEN KRUPP	0,82	SAP	1,00	SCHNEIDER	1,16
PERNOD-RICARD	0,34	HENKEL	0,70	PARMALAT	0,83	M6	1,01	SIEMENS	1,17
AIR FRANCE	0,39	CANAL +	0,70	ITALGAS	0,86	USINOR	1,02	PORSCHE	1,22
AGF	0,42	TF1	0,70	VOLKSWAGEN	0,86	SAGEM	1,02	L'OREAL	1,24
HEINEKEN	0,45	DANONE	0,70	BASF	0,88	AXA	1,02	DEUTSCHE BANK	1,24
LINDE	0,49	CARREFOUR	0,72	LUFTHANSA	0,88	ALLIANZ	1,03	DASSAULT SYSTEMES	1,27
EUROTUNNEL	0,50	DEUTSCHE TELEKOM	0,72	CLUB MEDITERRANEE	0,90	DRESDNER BANK	1,03	ALTRAN	1,27
CASINO	0,51	LAFARGE	0,75	BAYER	0,91	THOMSON-CSF	1,03	BNP-PARIBAS	1,29
METRO	0,52	GENERALI	0,75	SAINT GOBAIN	0,91	FRANCE TELECOM	1,05	SOCIETE GENERALE	1,29
TOTAL FINA ELF	0,54	ITALCEMENTI	0,77	CONTINENTAL	0,92	PEUGEOT	1,07	PORTUGAL TELECOM	1,29
CASTORAMA	0,55	AUTOGRILL	0,77	UNILEVER	0,92	BOUYGUES	1,08	TELEFONICA	1,29
BEIERSDORF	0,57	SUEZ LYON. DES EAUX	0,78	GUCCI	0,92	OLIVETTI	1,08	CHRISTIAN DIOR	1,29
STMICROELECTRONICS	0,59	REPSOL	0,78	PIRELLI	0,95	TELECOM ITAL MOBIL	1,08	LAGARDERE	1,31
RWE	0,60	COMMERZBANK	0,78	VIVENDI	0,95	ATOS	1,11	NOKIA	1,33
SODEXHO ALLIANCE	0,61	ALITALIA	0,78	BAAN	0,95	RENAULT	1,11	ABN AMRO	1,38
AIR LIQUIDE	0,61	DEXIA	0,79	FIAT	0,96	SOLVAY	1,12	LVMH	1,38
VEBA	0,62	ALTADIS	0,79	CCF	0,97	HAVAS ADVERTISING	1,13	PHILIPS	1,43
SIDEL	0,64	EDISON	0,79	INFOGRAMES	0,98	PINAULT PRINTEMPS	1,13	BBV ARGENTARIA	1,45
ENI	0,64	PECHINEY	0,79	AVENTIS	0,99	TELECOM ITALIA	1,13	ALCATEL	1,52

Source: Datastream

Evolution of market risk premium in Europe



Evolution de la prime de risque en Europe

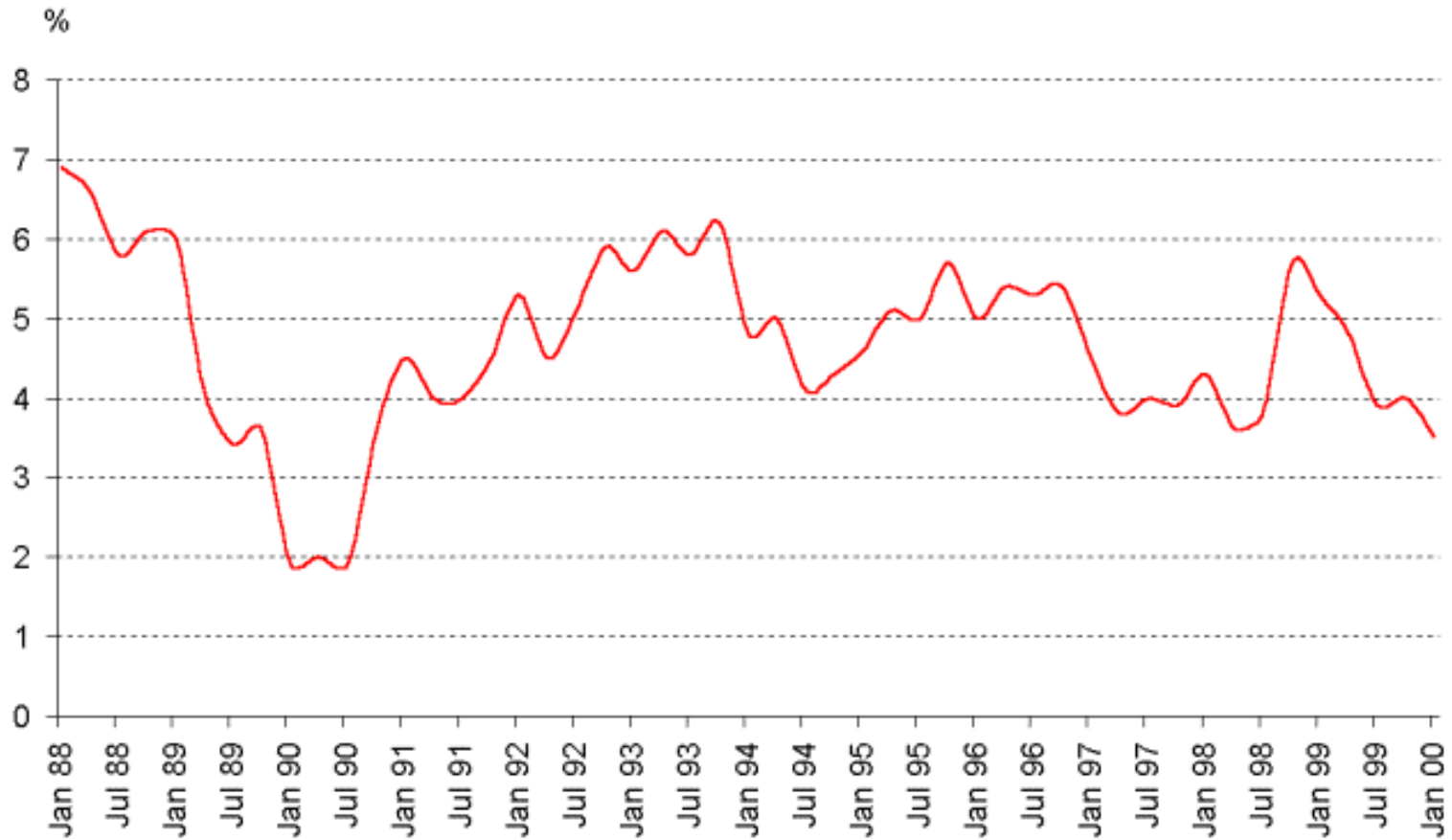

Source: BNP-Paribas

Evolution of market risk premium in France and Europe

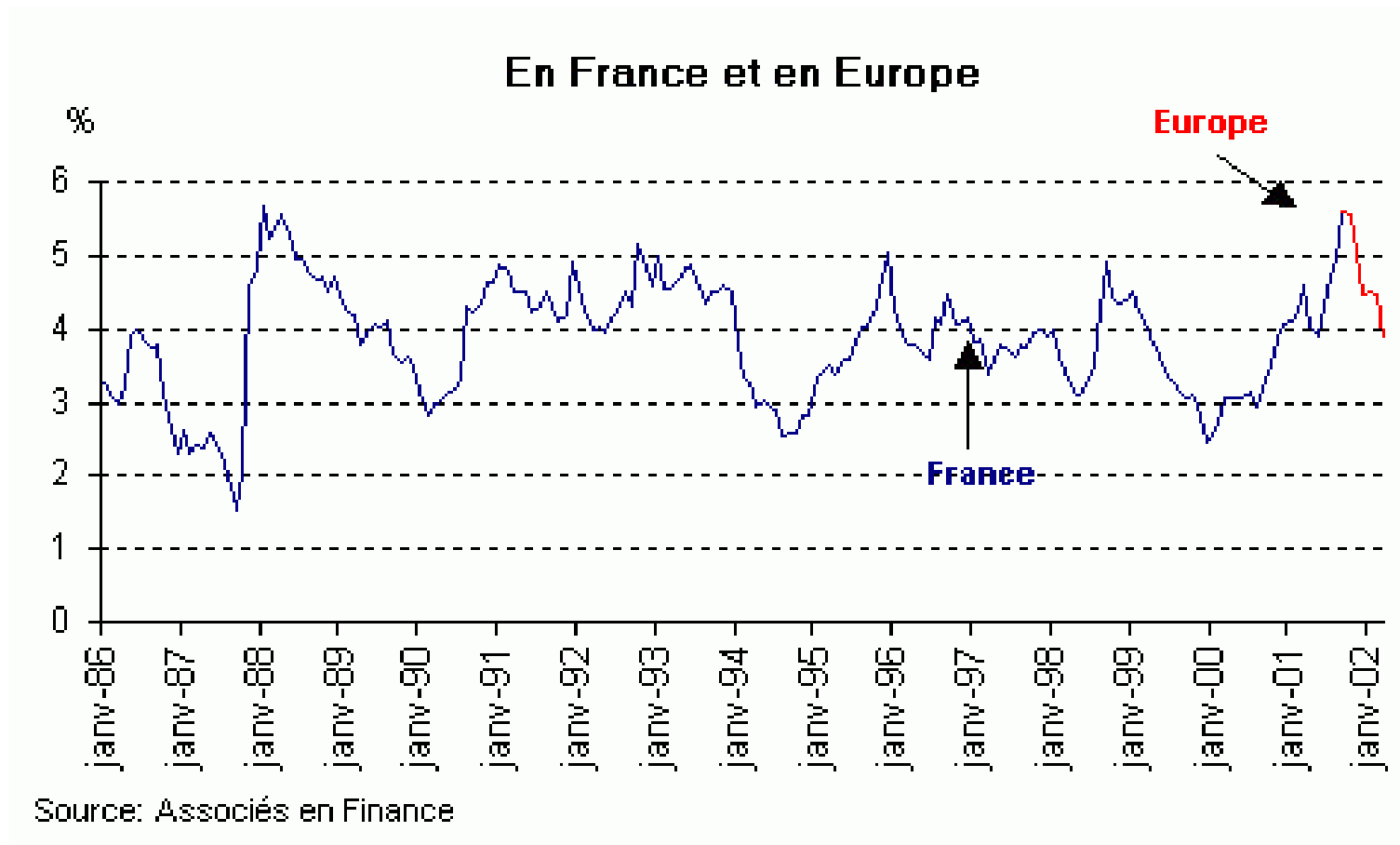

Evolution of market risk premium in United States

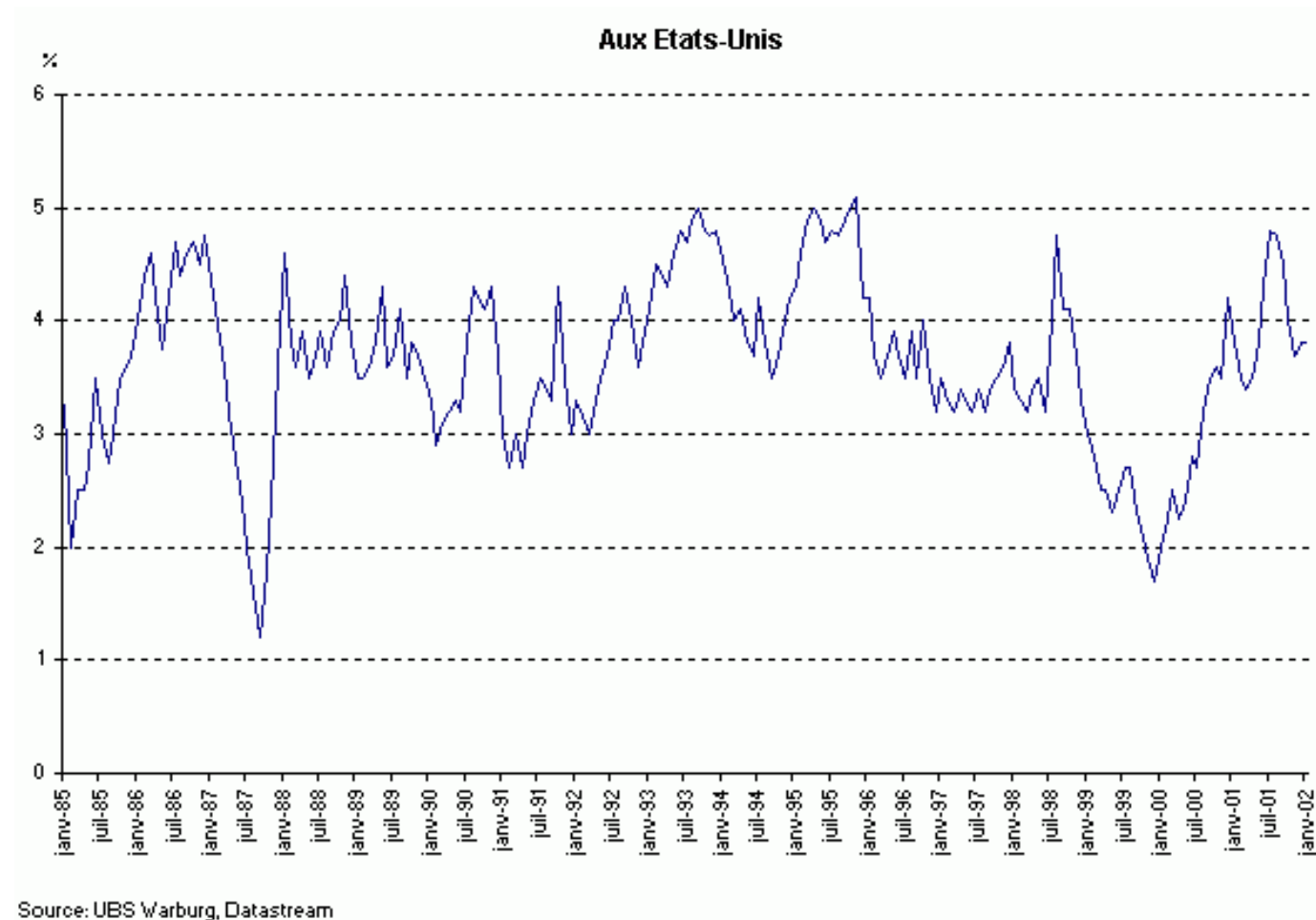



Evolution of risk premium in emerging market countries

Dans les pays émergents

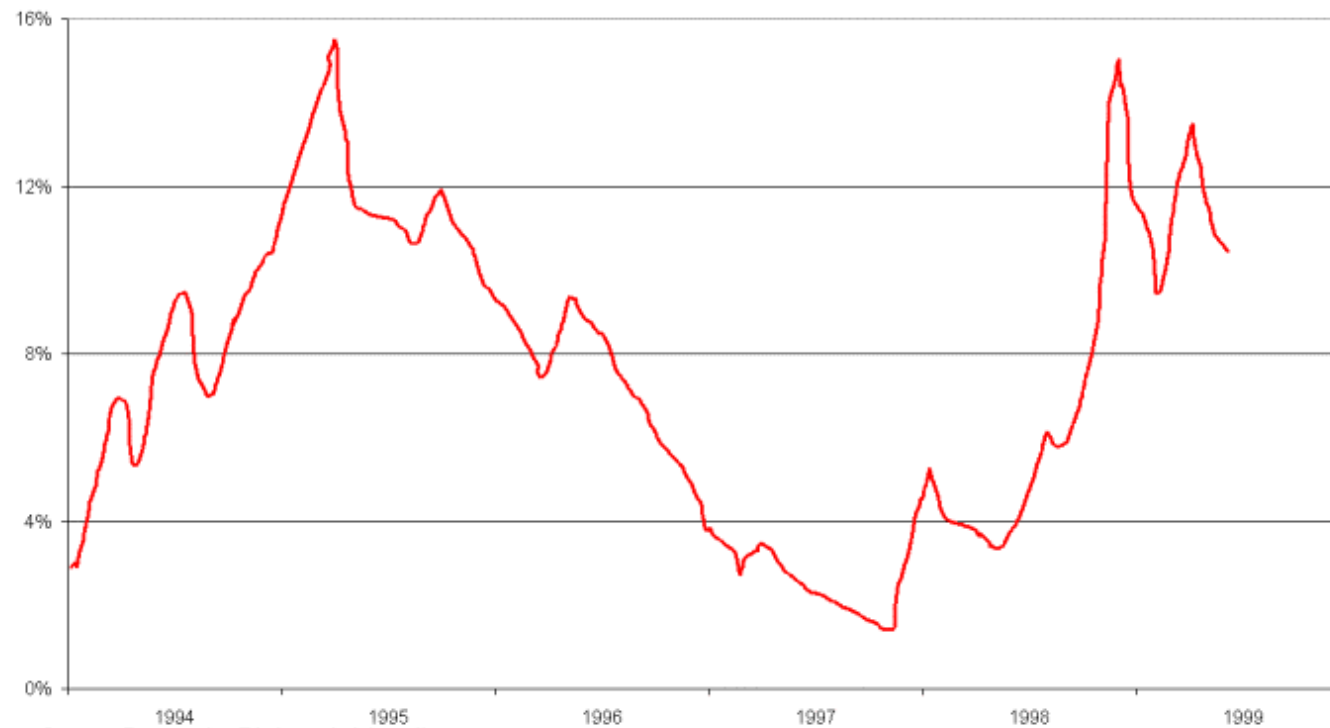

Source : Banque des Règlements Internationaux

COSTU - The ITU tariff model

BETA: conclusions



- The following shows that the CAPM is useful in calculating expected returns on equity only if there is abundant and reliable data pertaining to the market in question.
- COSITU does not rely only on this approach, given the specificities of developing countries,
- It has an additional approach, which is essentially a comparative one.



Some basic facts

- Markets in developing countries are exposed to adverse circumstances of all kinds, the effects of which are, for the most part, measured in terms of monetary risk,
- Most loans on these markets (in the telecommunication sector) are in convertible currencies,
- New investors in these markets also have investments in international financial markets.

Consequences



- The rate of interest on hard currency debts must be adjusted for the risk premium of the issuing markets and for local conditions using the currency depreciation rate,
- The expected rate-of-return must also be adjusted, on the basis of indications from the international financial market or the owners' market of origin.

Calculating the risk premium linked to currency depreciation



$$\frac{ne \left[1 + \frac{(n+1)}{2} i_F \right] - 1 + \frac{1}{(1+e)^n}}{n - \frac{1}{e} \left[1 - \frac{1}{(1+e)^n} \right]} - i_F$$

n = average duration of loan

e = currency depreciation

i_F = risk – free money rate



Returns on equity: Europe

Ratios sectoriels européens (principales sociétés cotées)

Rentabilité des capitaux propres	1993	1994	1995	1996	1997	1998	1999	2000e
Automobile	-1,0%	3,0%	-17,0%	5,2%	2,8%	5,3%	4,9%	4,9%
Agro-alimentaire	9,0%	10,0%	9,7%	10,8%	65,1%	53,9%	10,0%	15,0%
Boissons	6,0%	7,0%	11,0%	8,7%	8,6%	7,0%	6,3%	7,1%
Chimie	4,0%	5,0%	8,8%	6,0%	5,3%	4,9%	4,6%	4,8%
Grande distribution	7,0%	6,0%	10,0%	8,6%	6,5%	5,2%	6,0%	5,7%
Matériaux de construction	7,8%	12,1%	12,1%	12,2%	11,7%	10,6%	11,3%	12,0%
Matériel électrique et électronique	5,7%	2,5%	5,9%	6,3%	6,0%	6,1%	5,5%	8,1%
Média	11,0%	13,0%	15,3%	11,8%	9,1%	7,5%	6,5%	8,2%
Opérateurs de téléphonie	8,0%	9,0%	7,4%	7,7%	6,6%	4,3%	4,2%	4,4%
Pharmacie	11,0%	9,0%	19,5%	18,9%	15,6%	10,1%	17,5%	24,4%
Sidérurgie	-5,0%	4,0%	21,9%	19,5%	17,4%	15,6%	5,0%	7,9%

Source: BNP Paribas

Interest rates in the world

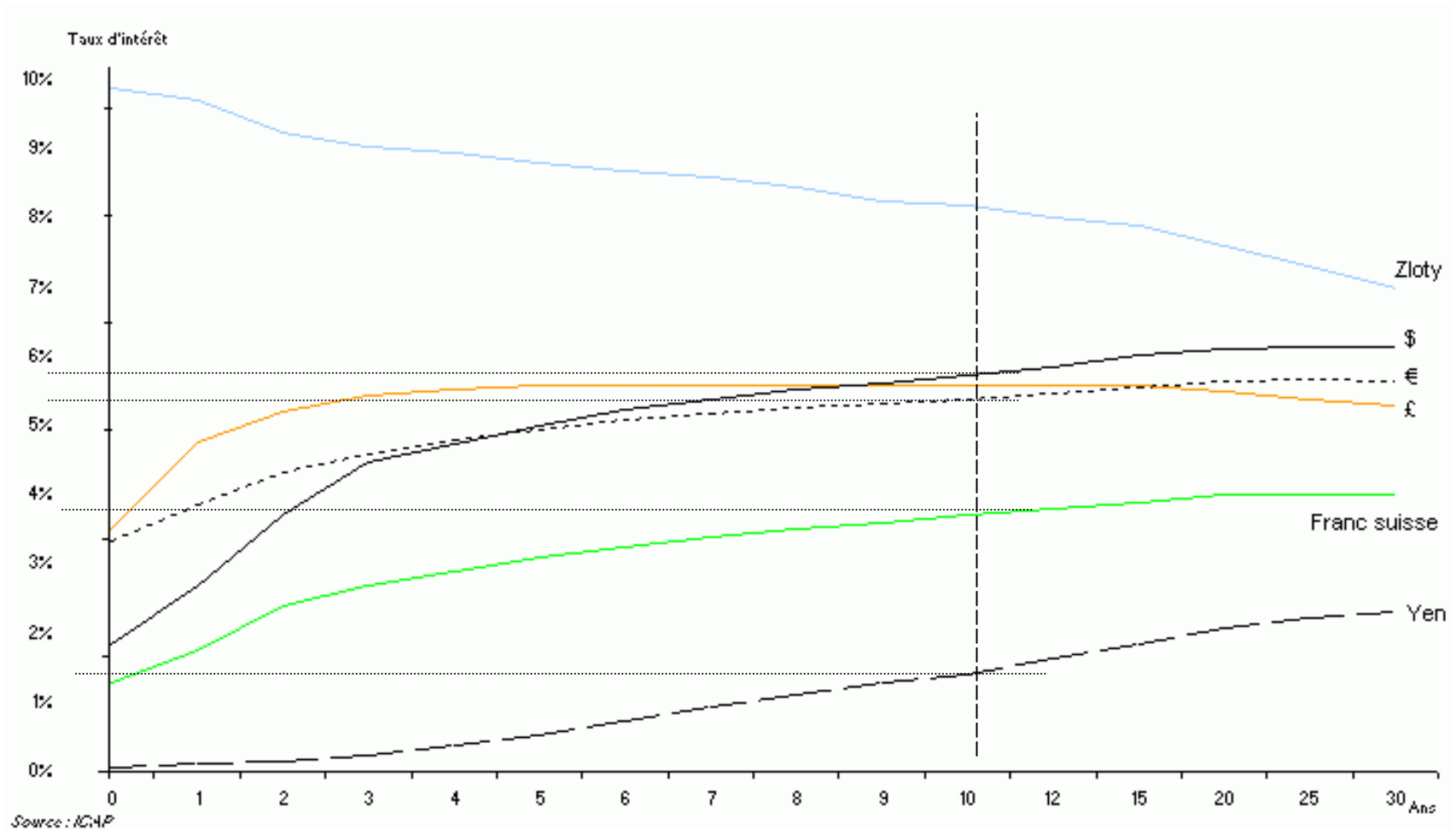

Example



- Taking a telecommunication company expecting a return on equity of 6.6% in Europe;
- Assuming an interest rate of 5.8% over ten years;
- In order for the enterprise to have an interest in investing in the market of a developing country where the differential currency depreciation rate is 3.5% per annum and to obtain the same return on capital in Euros over ten years, its expected rate of return in the local currency would need to be 10.93%.



The cost of capital: conclusion

- COSITU is able to calculate, assuming a preponderant risk of inflation for telecommunication companies in developing countries (sector risk \simeq market risk \rightarrow BETA \simeq 1), the essential components of the cost of capital as adjusted to local conditions.
- Thereafter the traditional formula for the cost of capital applies:

$$g = \frac{D}{D + E} i(1 - t) + \frac{E}{D + E} s$$



Special costs

- Some special costs are easy to single out even where the operator does not have analytical cost accounting:
 - *Study of products and services*
 - *Charging*
 - *Advertising*
 - *Distribution network*
 - *Customer service*
 - *International activities*
 - *National activities*
 - *Provisions for bad debts*

Routing table



- The routing table is an essential instrument for cost-orientated charging,
- It allows allocation to every service, according to the intensity of demand it places on each one, part of the resources needed for its production,
- The cost driver used by COSITU is traffic volume (adjusted by the geographical correction coefficient) for network component cost allocation.

Unit costs and reference costs



- On the basis of the routing table, COSITU allocates to services their share of each cost component,
- The resulting cost of a service is divided by the corresponding real traffic volume in order to obtain the unit cost of the service,
- At this stage, the COSITU server allows an online comparison with other telephone network operators,
- The costs here are endogenous intrinsic costs which do not take into account the specific requirements of States.



Moving from costs to tariffs

Other tariff elements



- The regulatory authority may impose constraints on the prices practised by a telecommunication service provider:
 - *Profit tax*
 - *Contribution to universal service obligations (USO)*
 - *Access deficit.*

Profit tax (1/2)



- An operator's profits are distributed between:
 - *Shareholders, through return on capital*
 - *The State, through statutory taxation of profits.*
- Shareholders often demand an after-tax return on capital.



Profit tax (2/2)

$$L_{benefits} = \frac{t_{levy}}{1 - t_{levy}} * r_{capital} * Capital$$

- L: profit estimated
- τ : corporation tax
- ρ : expected return on equity
- Capital: shareholders' capital

Contribution to universal service obligations



- A State may require a deduction from an operator's revenue for the purpose of financing USO costs.
- USOs may or may not be combined with the access deficit.
- Where applicable,

$$USO = \mathbf{r}_{uso} * \left(L_{benefit} + \sum_{i=1}^n k_{si} * T_i \right)$$

Access deficit (1/4)



- An access deficit may occur when the regulatory authority opposes cost-orientated adjustment of the following components:
 - *The connection charge*
 - *The monthly subscription*
 - *The price per minute of a local call*
 - *The price per minute of a trunk call.*



Access deficit (2/4)

- Before redistributing the access deficit, it must be borne in mind that only local users pay the connection charge and monthly subscription.
- The charge per minute for outgoing calls should be reduced by:

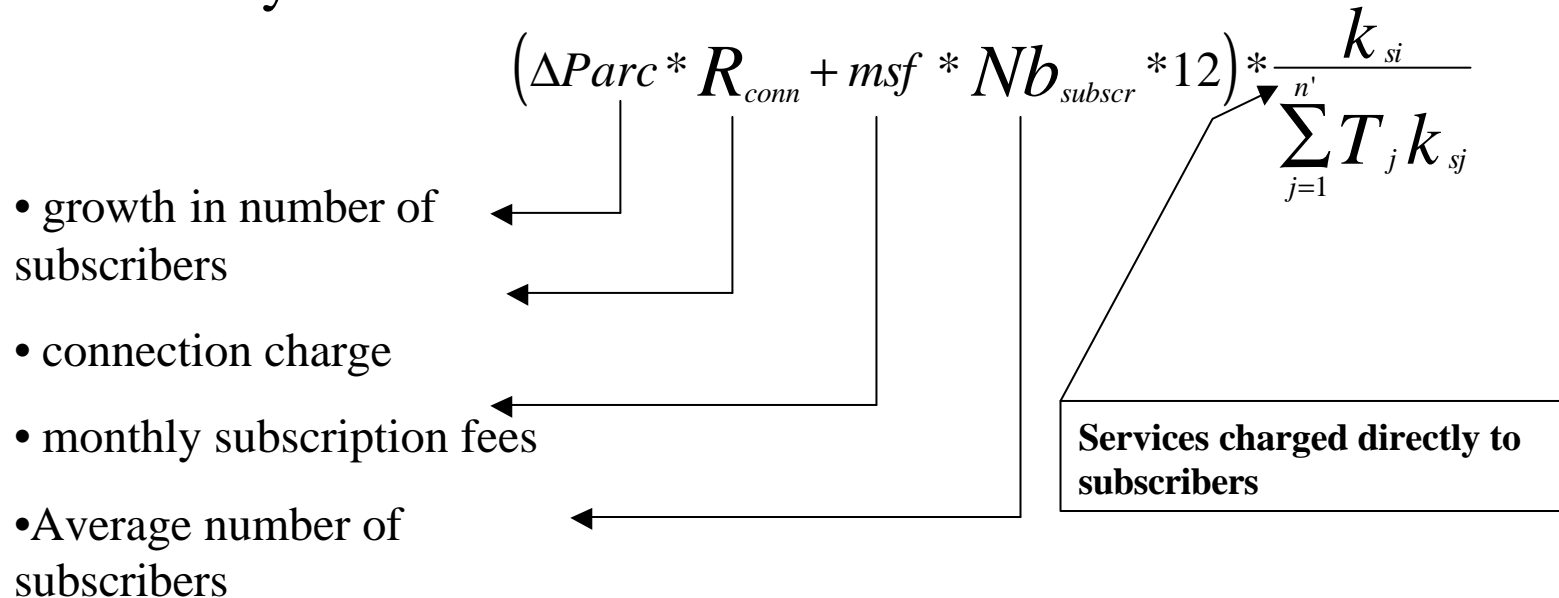

Access deficit (3/4)



- The amount of the access deficit is obtained by the following formula:

$$D = T_{local} * (k'_{local} - p_{local}) + T_{trunk} * (k'_{trunk} - p_{trunk}) - DomIneff$$



Access deficit (4/4)

- If $D > 0$, the access deficit is reallocated to all telecommunication services provided by the operator,
- If $D = 0$, there is no deficit. The surplus may be allocated to local and trunk calls in order to reduce and rebalance their tariffs.

Generic formula for distribution of other tariff elements



- Once calculated, the profit tax, the access deficit and the contribution to universal service obligations must be allocated to the appropriate services,
- The generic formula for this purpose is:

$$Share_{si} = \frac{Tariff_{element}}{\sum_{j=1}^n k_{sj} * T_j} * k_{si}$$

COSITU assumptions



- National transit offered if the third parties to be interconnected can be accessed inside the same tariff area,
- National traffic to/from international directly via an international transit centre,
- For certain specific applications, the model may need slight external reprocessing; the necessary elements are available *inter alia* in the report on unit costs.



Interconnection of mobiles

pape-gorgui.toure@itu.int

Note – The views expressed in this paper are those of the author and do not necessarily represent the opinions of ITU and its membership

Technical requirements for interconnection



- Definition of interfaces in accordance with ITU-T recommendations (e.g. R2, SS7);
- Creation of a physical link
 - *Belonging to one of the parties;*
 - *In co-ownership in accordance with the “half-circuit” regime;*
 - *Composed of two one-way special bundles.*

Architecture of a mobile GSM network

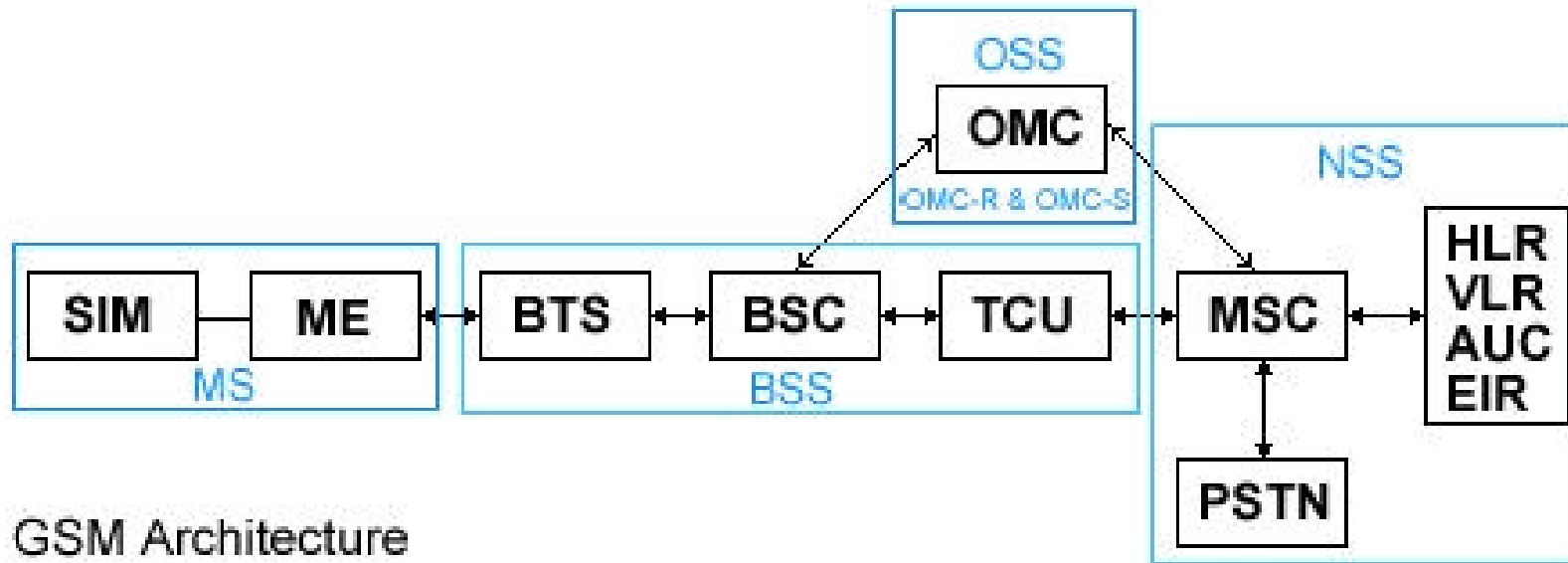

GSM Architecture

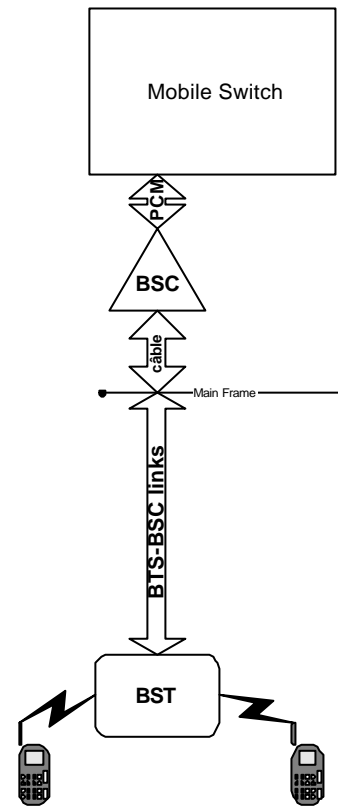
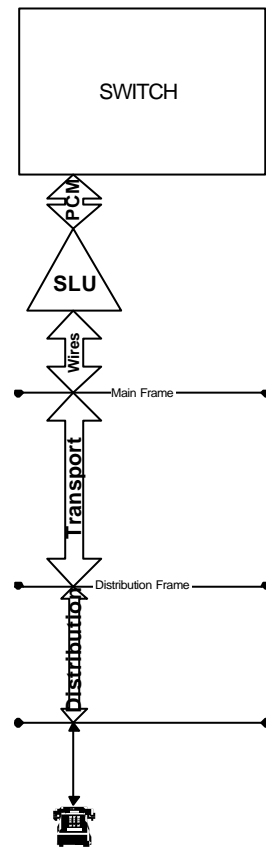

Fixed network Access and switching

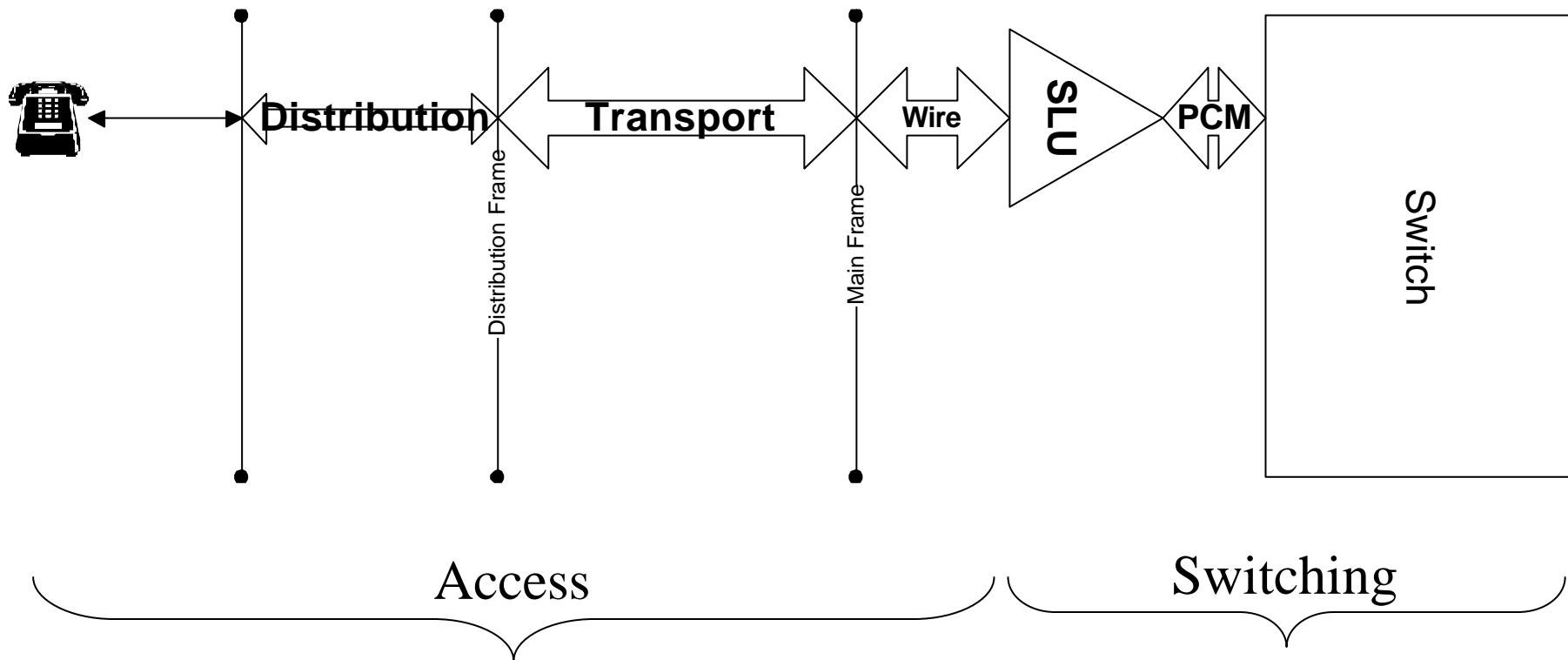

Mobile network Acces and switching

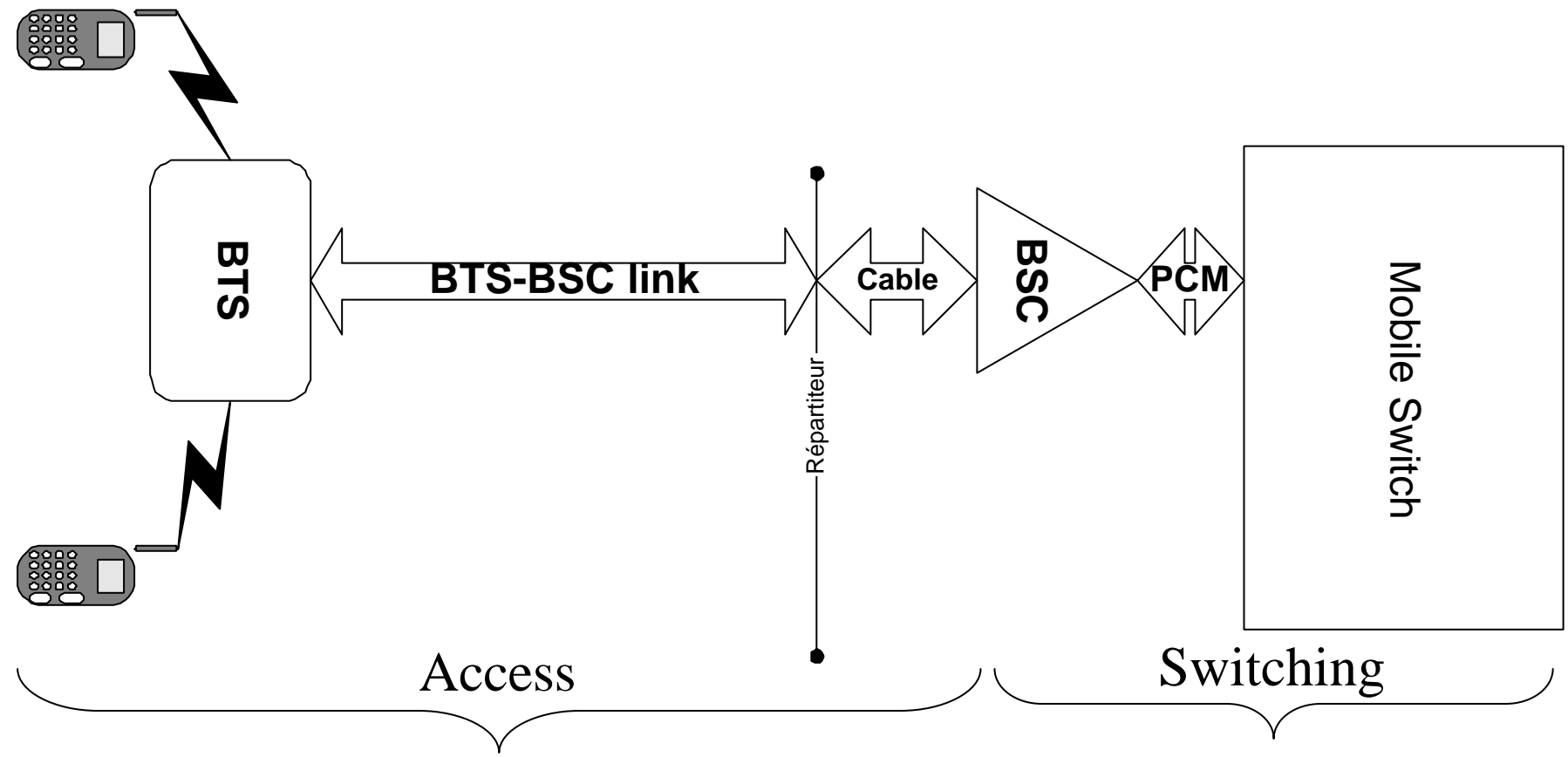

Application of COSITU to mobile networks



- Notions of capacity and growth in mobile communications:
 - *BSC access capacity;*
 - *utilized capacity;*
 - *BSC traffic growth adjusted to growth of utilized capacity;*
- Determination of average monthly subscription taking into account the weight of prepaid services.

Measure of efficiency of mobile network



- The relation between the number of mobile subscribers and the capacity of the access network is a function of the traffic;
- Bearing this in mind, one may, knowing the number of subscribers and their real traffic and assuming the quality of the service, determine the equivalent capacity of the network in terms of traffic and number of subscribers;
- The data of the number of real subscribers and the equivalent capacity can be used and entered directly in COSITU to calculate the efficiency of the network.

Measure of efficiency of mobile network: Example



1) Present number of subscribers	200000*
2) Average traffic per subscriber at peak hour	0.03
3) Number of BTS (base transceiver station)	375
4) Number of frequency channels per BST	4
5) Total traffic $= (1) * (2)$	6000
6) Maximum traffic / BTS $= (4) * 8 * 0,7$ (reject. \approx 1%)	22.4
7) Maximum traffic of network $= (3) * (6)$	8400
8) Capacity of network $= (7) / (2)$	280000*
9) Average annual growth rate	20%*

* The values in red are entered in COSITU for the calculation of the efficiency of the mobile network.

Determination of the average monthly licence fee



- It is important to bear in mind that, regarding mobile services, prepaid subscribers represent a substantial part of the number of subscribers
- If R_i is the average rental fee for segment i and N_i the population of that segment then the weighted average rental fee is calculated with the following formula:

$$R_{Average} = \frac{\sum_i N_i \times R_i}{\sum_i N_i}$$

Specific responsibilities of NRAs



- The interconnection interfaces must be clearly specified and publicly available,
- Should be part of the specifications common to all operators and be recognized during the licence awarding process,
- The basic principles for calculating interconnection charges, including those relating to discounts for volume, should be public and common to all operators,
- The effect of the application of USO policies should be borne by all network operators on an equitable basis,
- The main objective of interconnection should be to maximize the economic advantages of externalities and reduce service costs/prices.



ISP Interconnection

Pape-gorgui.toure@itu.int



Particular Case of Internet telephony

- There are three ways of accessing the telephone network via the Internet:
 - *A dedicated link (including cyber cafes) with the ISP: no interconnection with other national operators;*
 - *A domestic call terminating on a set of modems of an ISP connected to the Internet*
 - *A national call to a VoIP server connected to the Internet.*
- The costs of providing an end-to-end service are different in each of the above situations.

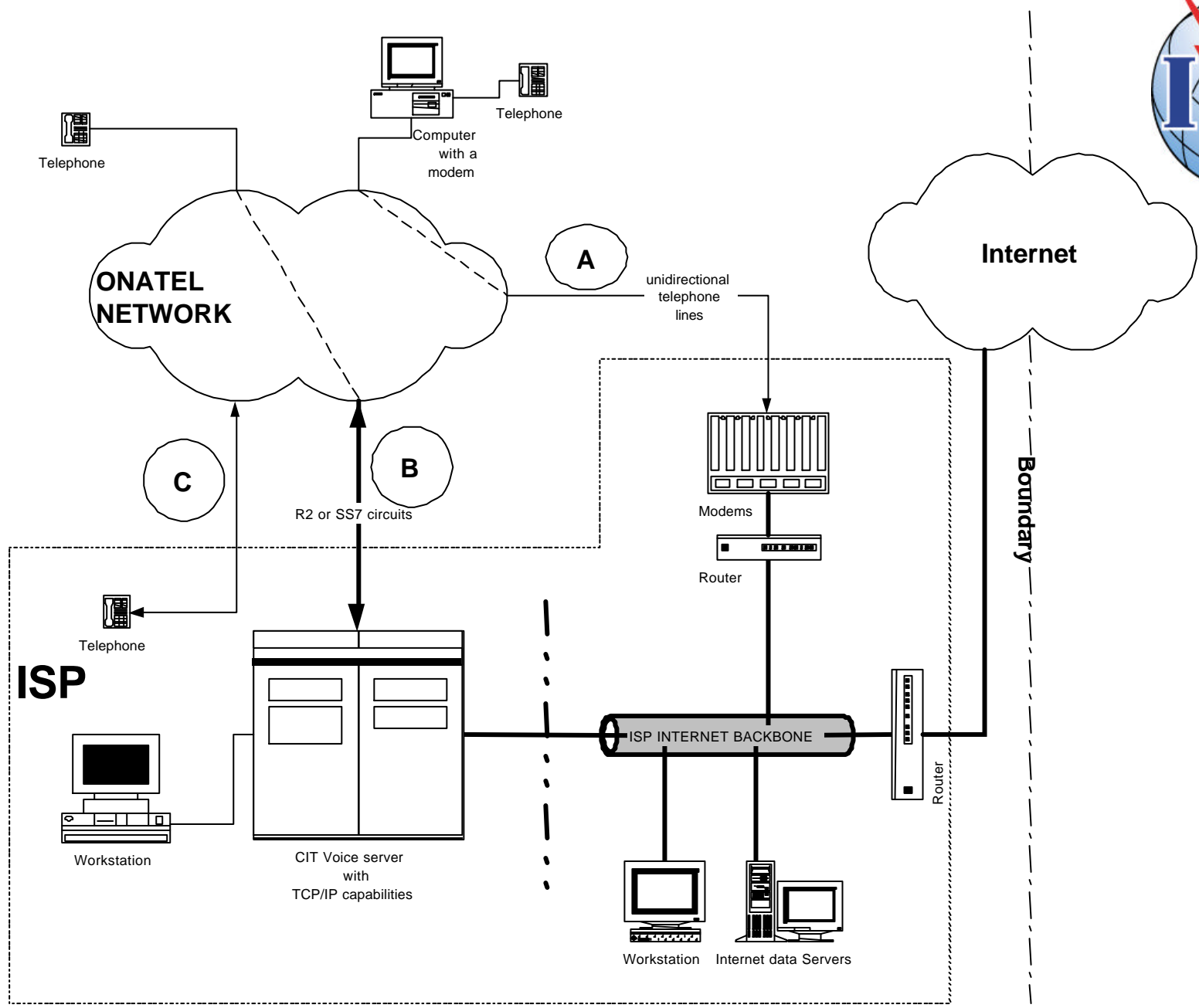

COSITU - The ITU tariff model

Avoid regulatory arbitrage



- Countries banning Internet telephony may deprive their economies of major opportunities,
- But VoIP must not be introduced outside the general regulatory framework solely on account of the technology used,
- The economic efficiency of VoIP could be reduced if the rules of cost orientation are not applied to all segments of the network, wherever necessary,
- Wherever there is an access deficit, equitable allocation of the USO costs to all network operators, including VoIP providers, will be decisive for the general growth of the service.

Types of VoIP calls



- There are different kinds of VoIP calls:
 - *C1: a national end-user calling via link A (computer-to-computer/telephone);*
 - *C2: a national end-user calling via link B (telephone-to-telephone);*
 - *C3: an international ISP calling via link A (computer-to-computer termination: the connection must first be established locally);*
 - *C4: an international ISP calling via link B (computer/telephone-to-telephone termination).*

Fraudulent links



- If the VoIP gateway of the ISP or the mobile network is connected to the network through subscriber lines and terminates calls on the latter at the price of a domestic call, the interconnection interface would no longer be in conformity with interconnection rules,
- This can be done by deviating normal telephone lines from their normal functions,
- To avoid this, type “A” links should be dedicated outgoing, and consumption of type “C” links should be regularly monitored.

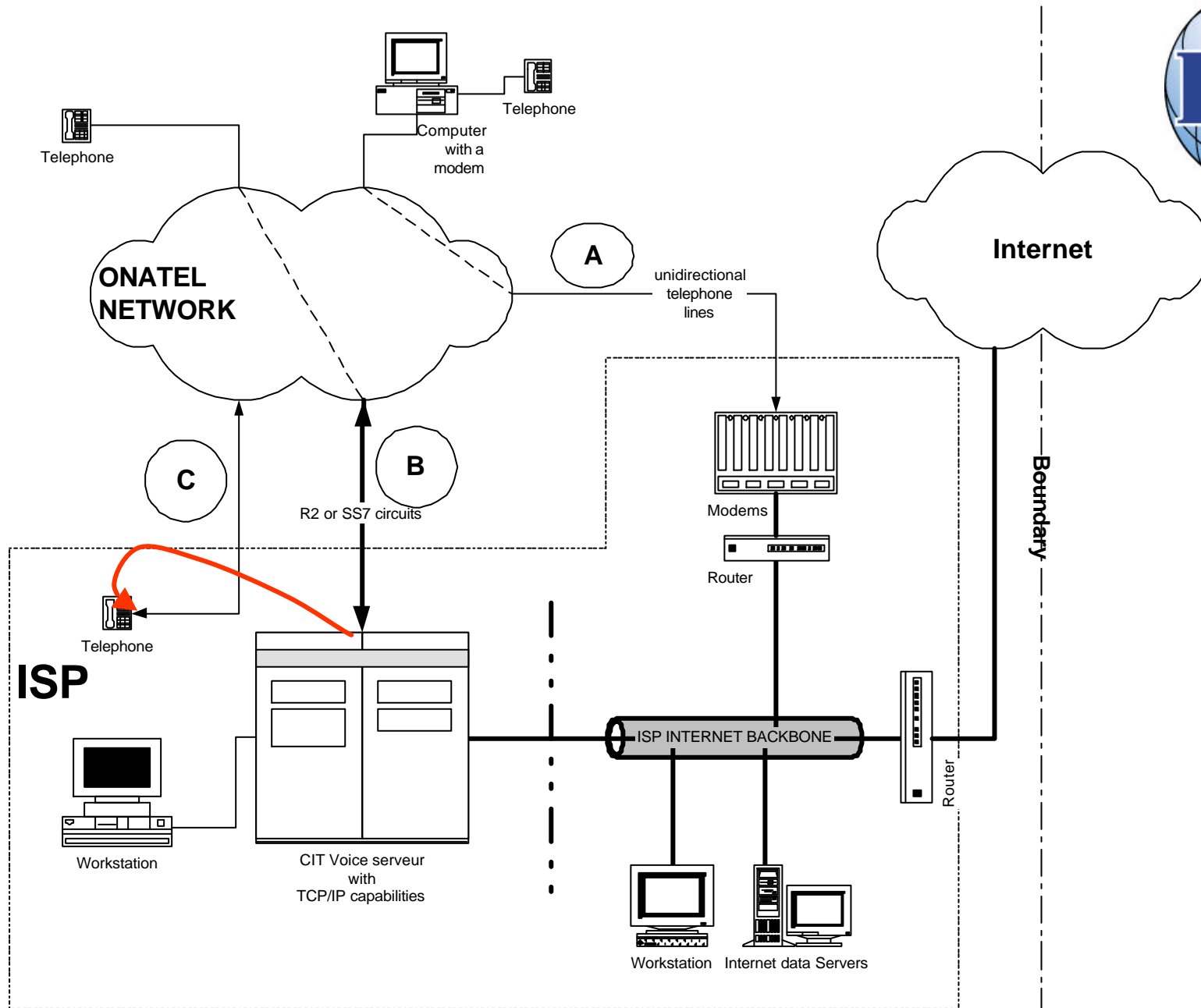

COSITU - The ITU tariff model

Analysis of C1 type calls (computer-to-computer/telephone)



- The end user pays the price of a national call in order to access the ISP's modems,
- If there is an access deficit, the call will be subsidized but since it is an end-to-end domestic call, the Internet access will be treated as a value-added service, so no measures are needed for outgoing VoIP calls using this link,
- However, a business-rate monthly subscription should be applied to the lines of this bundle. To avoid fraud, the lines should be dedicated outgoing.

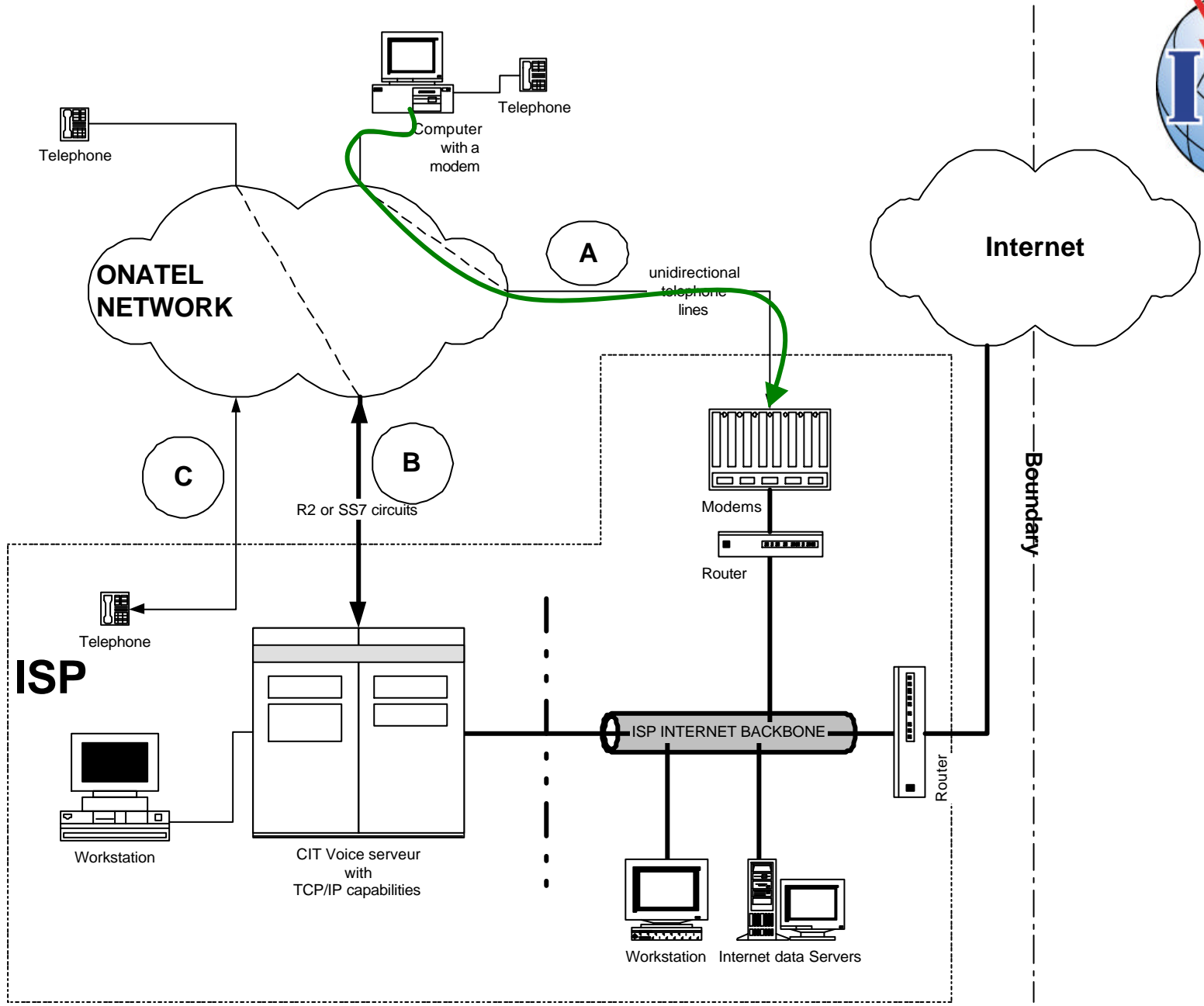

COSITU - The ITU tariff model

Analysis of type C2 calls (telephone to telephone)



- Type “B” links obey the interconnection rules,
- The telephone network operator will bear the cost of an outgoing national call, the endogenous cost of which can easily be calculated with COSITU,
- It takes account not only of CAPEX, OPEX and the costs of capital, but also taxes and part of the USO costs,
- Depending on who collects the customer’s payments (direct/cascade method), there may be several types of arrangements between TPH and VoIP providers.

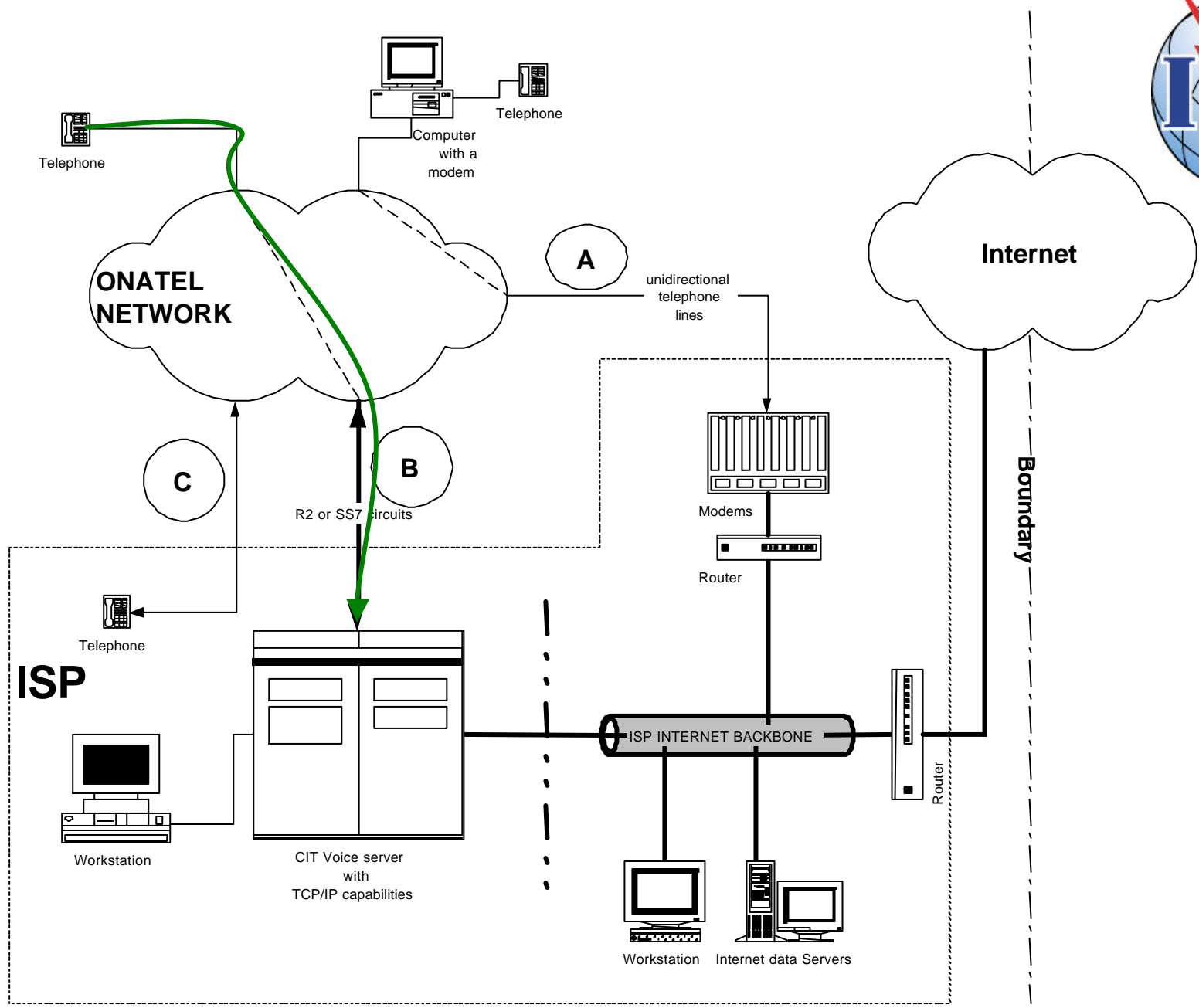

COSITU - The ITU tariff model

Analysis of type C3 calls (computer-to-computer termination: the connection must first be established locally)



- In order to avoid fraud of any kind, telephone calls from the VoIP provider to the TPH provider will have to be prohibited.
- But if the call is generated by the local TPH customer, a VoIP incoming international call may be generated (e.g. netmeeting calls),
- In this case the VoIP is a value-added service,
- No implications for interconnection rules.

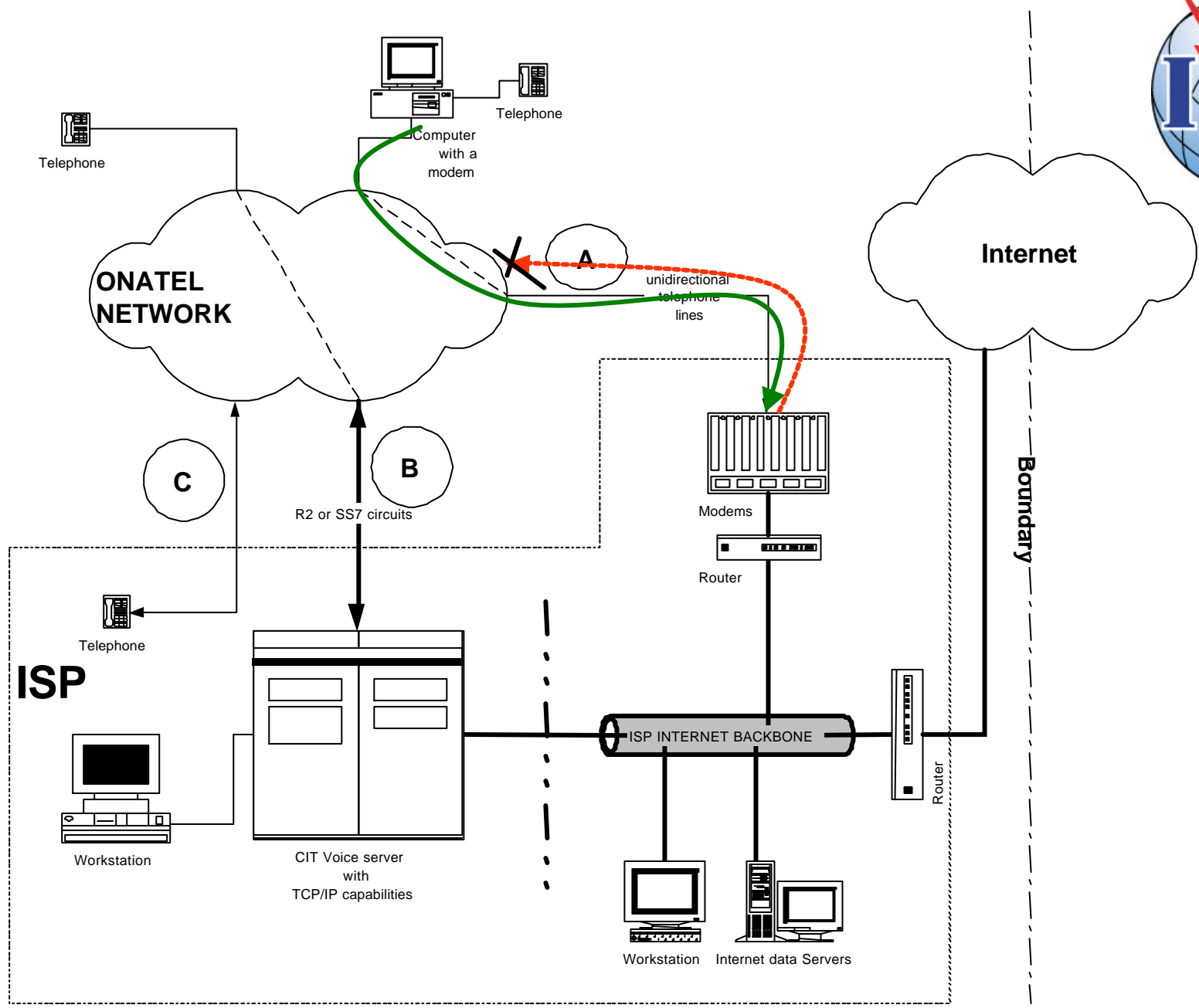

COSITU - The ITU tariff model

Analysis of type C4 calls

(computer/telephone-to-telephone termination)



- Normal call termination,
- The TPH operator will receive the price of an incoming national call, depending on where the latter terminates:
 - *single transit if the call terminates in the tariff area where the interconnection point is located;*
 - *double transit if it terminates outside that area.*
- COSITU can easily calculate the bases of these tariffs,
- If this type of call is terminated on the TPH network via a type “C” link, the result will be a fraudulent situation because the price of domestic calls will in all likelihood be largely subsidized wherever there is an access deficit (see COSITU).

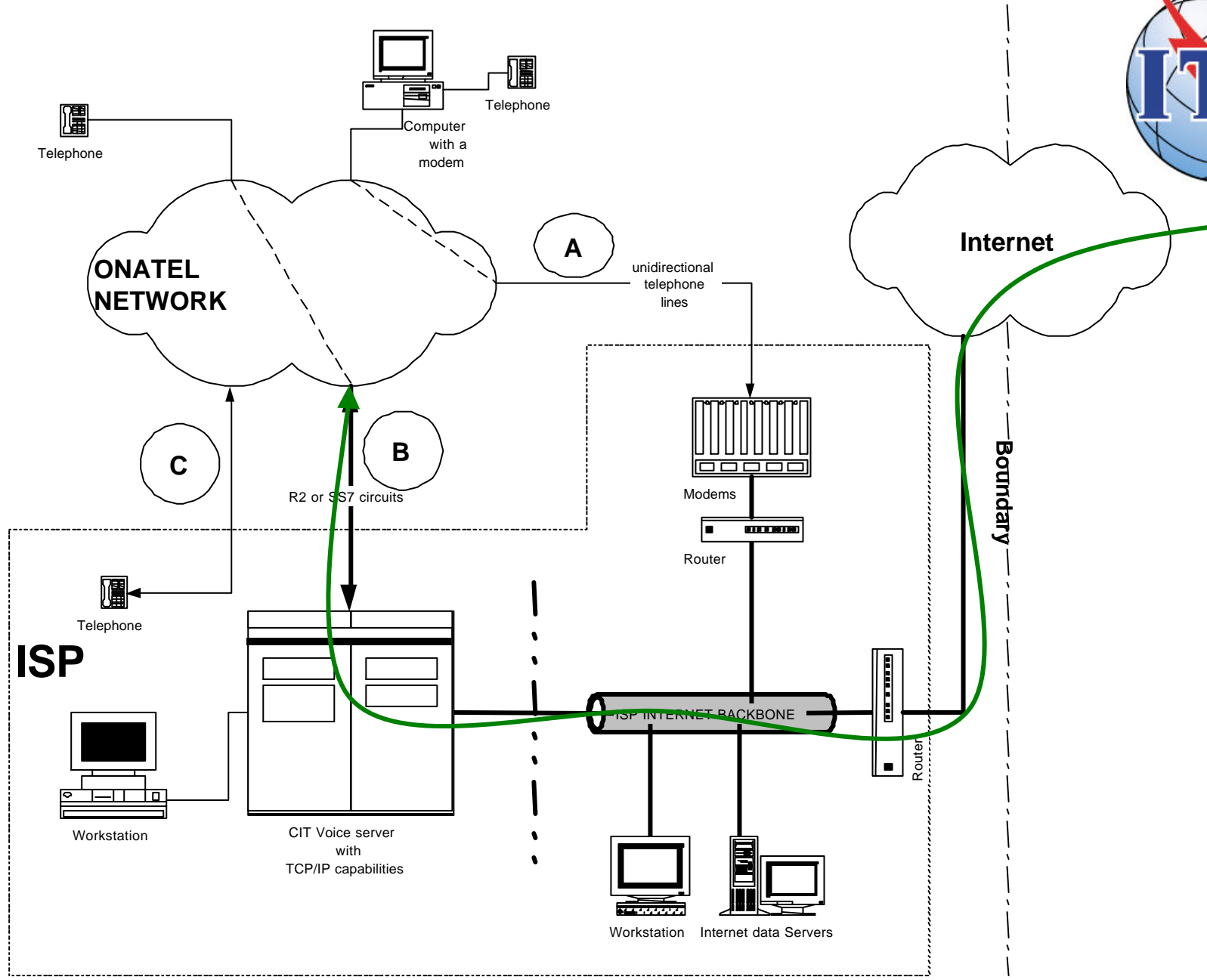

COSITU - The ITU tariff model



The AFRICOM case

Present price



COSITU - Tarifs courants

Terminal Traffic		Interconnexion	
Prix pour 1 minute de communication		Prix pour 1 minute de communication	
Urbain	0,0368	Nat entrant simple	0,1500
Interurbain	0,1658	Nat entrant Double	0,1700
Int Entrant	0,5300	National Sortant	0,1700
Int Sortant	0,8100	Nat vers Nat	0,0173
Sous régional entrant	0,6399	Int vers Nat	0,2500
Sous régional sortant	0,8201	National vers Int	0,5400

USO Paramètres

Contribution au Service Universel	Reçu pour le Service Universel	Taxe Raccordement	Redevance Mens.
0,00	0,00	77,00	5,14

Prix moyens int. OK Annuler

Cost oriented tariffs



COSITU Session Paramètres Rapports Administration Aide

Opérateur: NoAdmin Pays: ANGOLA Année: 2002 Monnaie: AOA Taux de Change: 1,3668

Estimation du trafic | Eléments de coûts | Coûts unitaires | **Tarifs / Simulation**

Tarif pour 1 Minute			Tarif d'interconnexion		
	Tarif	P&P		Tarif	P&P
Urbain	0,0368	0,0000	Nat entrant simple	0,1266	0,0234
Interurbain	0,1658	0,0000	Nat entrant double	0,2486	-0,0786
Int entrant	0,3799	0,1501	Nat vers Int	0,2735	0,2665
Int sortant	0,3749	0,4350	National sortant	0,1693	0,0007
Ss Rég entrant	0,3433	0,2966	Int vers Nat	0,2735	-0,0235
Ss Rég sortant	0,3402	0,4799	Nat vers Nat	0,1013	-0,0840

Tarif du Transit			Déficit d'accès
Int->Int	Int->SsRég	SsRég->SsRég	
0,3379	0,3948	0,3581	151 762 386,71

Paramètres		Prix pour 1 min		Boutons	
Contribution au Service Universel	Reçu pour le Service Universel	Urbain		Tarifs courants	
0,00 %	0,00	0,0368		Calculer Tarifs	
Taxe Raccordement	Redevance Mens.	Interurbain		Simulation	
77,00	5,14	0,1658		Rééquilibrer	

Tarifs et Simulation

La toute dernière étape permet de calculer les tarifs basés sur les coûts effectifs et sur le trafic. La partie supérieure permet de visualiser ces tarifs pour le trafic terminal, le trafic d'interconnexion et le trafic de transit. Le déficit d'accès est calculé, ainsi que les pertes et profits pour le trafic terminal et le trafic d'interconnexion, en se basant sur la différence entre les tarifs calculés et les prix effectivement pratiqués à l'heure actuelle.

Pour en arriver au tarifs orientés coûts, il faut encore saisir d'autres données:

Les prix actuels (Bouton "Tarifs

ITU - MaSession 13:15

Cost based tariffs



COSITU Session Paramètres Rapports Administration Aide

Opérateur: NoAdmin Pays: ANGOLA Année: 2002 Monnaie: AOA Taux de Change: 1,3668

Estimation du trafic | **Éléments de coûts** | Coûts unitaires | Tarifs / Simulation

Tarif pour 1 Minute

	Tarif	P&P
Urbain	0,0794	-0,0426
Interurbain	0,1374	0,0284
Int entrant	0,2118	0,3182
Int sortant	0,2000	0,6100
Ss Rég entrant	0,1914	0,4486
Ss Rég sortant	0,1815	0,6386

Tarif d'interconnexion

	Tarif	P&P
Nat entrant simple	0,0706	0,0794
Nat entrant double	0,1386	0,0314
Nat vers Int	0,1525	0,3875
National sortant	0,0903	0,0797
Int vers Nat	0,1525	0,0975
Nat vers Nat	0,0565	-0,0392

Tarif du Transit

Int<->Int	Int<->SsRég	SsRég<->SsRég	Déficit d'accès
0,1884	0,2201	0,1996	0,00

Paramètres

Contribution au Service Universel	Reçu pour le Service Universel	Prix pour 1 min Urbain	Tarifs courants
0,00 %	0,00	0,0368	Calculer Tarifs
Taxe Raccordement	Redevance Mens.	Interurbain	Simulation
77,00	5,14	0,1658	Rééquilibrer

Tarifs et Simulation

La toute dernière étape permet de calculer les tarifs basés sur les coûts effectifs et sur le trafic. La partie supérieur permet de visualiser ces tarifs pour le trafic terminal, le trafic d'interconnexion et le trafic de transit. Le déficit d'accès est calculé, ainsi que les pertes et profits pour le trafic terminal et le trafic d'interconnexion, en se basant sur la différence entre les tarifs calculés et les prix effectivement pratiqués à l'heure actuelle.

Pour en arriver au tarifs orientés coûts, il faut encore saisir d'autres données:

Les prix actuels (Bouton "Tarifs

ITU - MaSession 13:16

Status of VoIP providers in Afriland



- The USO policy choices of the public authorities generate an access deficit of USD 151 million for Africom,
- Given the size of the deficit, all telephone service providers in Afriland should bear a fair share of it,
- If these service providers operate a network, whatever the technology, they must have operator status and be subject to statutory USO constraints,
- This should apply to Afriland VoIP providers.

Equalization charge



- Afriland's USO policy creates a transfer of charges from domestic calls to international calls and domestic calls to national calls,
- The charge transferred to the outgoing international service is equal to the difference between the cost-orientated tariffs and the cost-based tariffs: $\text{USD } 0.37 - \text{USD } 0.20 = \text{USD } \mathbf{0.17}$,
- This additional charge, clear of all inefficiency costs and due solely to USO policy, is called the “equalization charge”,
- It should be applied to all international telephone service providers not participating in USO costs through the interconnection mechanism, in order to avoid regulatory arbitration: e.g. cyber cafes,
- The proceeds of the equalization charge are a resource belonging to the State which the incumbent operator may not claim.

Monthly subscription



- Type “A” link telephone lines must not be subsidized. Africom should apply a monthly subscription charge of USD 22 instead of the current USD 5.

Link “B” interconnection charges



From	To	Via	Africom must keep
Africom	International or National	National	USD 0.1693
International	National	Africom	USD 0.2735
National 1	National 2	Africom	USD 0.1013
National	International	Africom	USD 0.2735
National	Africom single	Africom	USD 0.1266
National	Africom double	Africom	USD 0.2486

Example 1: Africom customer to international customer via ISPTTEL



- Termination charge Afriland-ISPTTEL to Euroland-ISPTTEL: USD 0.10,
- Endogenous cost of Afriland-ISPTTEL: USD 0.15
- Minimum tariff when an Africom customer calls a Euroland customer via ISPTTEL:
 $0.1693 + 0.15 + 0.10 = \text{USD } 0.4193$
- Africom keeps USD 0.1693 and gives USD 0.25 to ISPTTEL and its other partners.

Example 2: International call from a cybercafé



- Endogenous costs of Afriland-ISPTTEL from a cybercafé, including the latter's costs: USD 0.12,
- Termination charge Afriland-ISPTTEL to Euroland-ISPTTEL: USD 0.10,
- Minimum charge when cybercafé customer calls a Euroland customer via ISPTTEL
 $0.17 + 0.12 + 0.10 = \text{USD } 0.39$
- ISPTTEL pays USD 0.17 to the Afriland department of finance.

Example 3: ISPTTEL routes a call which has to be terminated by Africom



- For example, ISPTTEL terminates an international call in the tariff area of the interconnection point:
 - *ISPTTEL pays Africom USD 0.1266*
- ISPTTEL terminates an international call outside the tariff area of the interconnection point:
 - *ISPTTEL pays Africom USD 0.2486*
- If 60% of the traffic terminated is “single transit”, ISPTTEL and Africom could negotiate a single termination charge equal to:
$$0.1266 * 0.6 + 0.2486 * 0.4 = \text{USD } 0.1754$$

<http://www.itu.int/ITU-D/finance/COSITU/>



ITU Software - Microsoft Internet Explorer

File Edit View Favorites Tools Help

Back Forward Stop Refresh Home Search Favorites History Mail Print Edit Discuss Real.com Messenger

Address <http://www.itu.int/ITU-D/finance/COSITU/index.html> Go Links

Google Search Web blocked AutoFill Options

Y! Options Recherche Ouvrir session JO-2004 Traduire Messenger Y! Mail Mon Yahoo! Rencontres

International Telecommunication Union Français Español

Our Sites News Events Publications Site Map About Us Print Version

Home : ITU-D : Financing Strategies Search

COSITU

To purchase COSITU, [click here](#)

NEW: COSITU Service Pack 2 will be available soon!

ITU Software for the Calculation of Costs, Tariffs and Rates for Telephone Services

Negotiating tariffs or rates is a delicate matter, whether it is for a new operator entering a liberalized market or a regulator wishing to set affordable tariffs for national calls without compromising competitiveness among operators.

COSITU is a practical tool from ITU's Market, Economics and Finance Unit to automate:

- the calculation of costs,
- taxes related to the exchange of international traffic (accounting, settlement and termination rates),
- interconnection rates between local operators, and
- tariffs for national and international telephone services taking into account the impact of Universal Service Obligations decided

News

 **COSITU Service Pack 1**

COSITU features, among other improvements, a new tool to estimate equivalent installed capacity of mobile communication networks with a view to evaluating the efficiency of their operation. To download **COSITU SERVICE PACK 1** and its revised electronic Help Menu, please follow the instructions below.

[Readme SP1](#)

[Download COSITU Service Pack 1](#)

COSITU session to be updated

The AFRICOM session should be replaced in the software by an updated version. Please follow the instructions.

[Readme](#)
[Download Africom.zip \(if you have not yet downloaded SP 1\)](#)
[Download Africom SP 1](#)

Done Internet

Start 16:37

COSITU - The ITU tariff model